

FCC PART 15, SUBPART B and C; FCC 15.231; and RSS-210 & RSS-GEN  
TEST REPORT

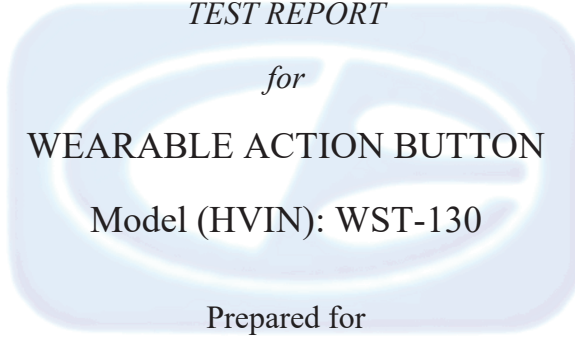

ECOLINK INTELLIGENT TECHNOLOGY, INC.  
2055 CORTE DEL NOGAL  
CARLSBAD, CALIFORNIA 92011

Prepared by: James Ross

JAMES ROSS

Approved by: Kyle Fujimoto

KYLE FUJIMOTO

COMPATIBLE ELECTRONICS INC.  
114 OLINDA DRIVE  
BREA, CALIFORNIA 92823  
(714) 579-0500

DATE: JANUARY 3, 2023

	REPORT BODY	APPENDICES					TOTAL
		A	B	C	D	E	
PAGES	21	2	2	2	11	26	64

This report shall not be reproduced except in full, without the written approval of Compatible Electronics.



## TABLE OF CONTENTS

Section / Title	PAGE
<b>GENERAL REPORT SUMMARY</b>	<b>4</b>
<b>SUMMARY OF TEST RESULTS</b>	<b>5</b>
<b>1. PURPOSE</b>	<b>6</b>
1.1 Decision Rule & Risk	7
<b>2. ADMINISTRATIVE DATA</b>	<b>8</b>
2.1 Location of Testing	8
2.2 Traceability Statement	8
2.3 Cognizant Personnel	8
2.4 Date Test Sample was Received	8
2.5 Disposition of the Test Sample	8
2.6 Abbreviations and Acronyms	8
<b>3. APPLICABLE DOCUMENTS</b>	<b>9</b>
<b>4. DESCRIPTION OF TEST CONFIGURATION</b>	<b>10</b>
4.1 Description of Test Configuration – Emissions	10
4.1.1 Cable Construction and Termination	10
<b>5. LISTS OF EUT, ACCESSORIES AND TEST EQUIPMENT</b>	<b>11</b>
5.1 EUT and Accessory List	11
5.2 Emissions Test Equipment	12
<b>6. TEST SITE DESCRIPTION</b>	<b>13</b>
6.1 Test Facility Description	13
6.2 EUT Mounting, Bonding and Grounding	13
6.3 Measurement Uncertainty	13
<b>7. TEST PROCEDURES</b>	<b>14</b>
7.1 RF Emissions	14
7.1.1 Conducted Emissions Test	14
7.1.2 Radiated Emissions Test	15
7.1.3 RF Emissions Test Results	16
7.1.4 Sample Calculations	17
7.1.5 Duty Cycle Calculation	18
7.1.6 99 % Bandwidth	19
7.1.7 -20 dB Bandwidth	19
7.1.8 Transmission Time	20
7.1.9 Variation of the Input Power	20
<b>8. CONCLUSIONS</b>	<b>21</b>

**LIST OF APPENDICES**

<b>APPENDIX</b>	<b>TITLE</b>
A	Laboratory Accreditations and Recognitions
B	Modifications to the EUT
C	Models Covered Under This Report
D	Diagrams, Charts, and Photos <ul style="list-style-type: none"><li>• Test Setup Diagrams</li><li>• Antenna and Effective Gain Factors</li><li>• Radiated Emissions Photos</li></ul>
E	Data Sheets

**LIST OF FIGURES**

<b>FIGURE</b>	<b>TITLE</b>
1	Conducted Emissions Test Setup
2	Layout of the Semi-Anechoic Test Chamber

**LIST OF TABLES**

<b>TABLE</b>	<b>TITLE</b>
1	Radiated Emission Results

## GENERAL REPORT SUMMARY

This electromagnetic emission test report is generated by Compatible Electronics Inc., which is an independent testing and consulting firm. The test report is based on testing performed by Compatible Electronics personnel according to the measurement procedures described in the test specifications given below and in the "Test Procedures" section of this report.

The measurement data and conclusions appearing herein relate only to the sample tested and this report may not be reproduced without the written permission of Compatible Electronics, unless done so in full.

This report must not be used by the client to claim product certification, approval or endorsement by NVLAP, NIST or any agency of the United States government.

Device Tested:           Wearable Action Button  
                                  Model (HVIN): WST-130  
                                  S/N: 1

Product Description:    The equipment under test is a battery powered (a single CR2032 Lithium battery) wireless transmitter for home automation/security application.  
                                  The transmit frequency is 433.92 MHz.  
                                  The crystal oscillators are 4 MHz and 13.56 MHz.  
                                  Dimensions: 3.2 cm (W) x 1.5 cm (L) x 5.5 cm (H).

Modifications:           The EUT was not modified to meet the specifications.

Customer:                Ecolink Intelligent Technology, Inc.  
                                  2055 Corte Del Nogal  
                                  Carlsbad, California 92011

Test Dates:              December 5 and 6, 2023

Test Specifications covered by accreditation:

Test Specifications:      Emissions requirements  
                                  CFR Title 47, Part 15, Subpart B;  
                                  CFR Title 47, Part 15, Subpart C, sections 15.205, 15.209, and 15.231;  
                                  RSS-210 and RSS-Gen



Test Procedures:        ANSI C63.4 and ANSI C63.10

Test Deviations:        The test procedure was not deviated from during the testing.

## SUMMARY OF TEST RESULTS

TEST	DESCRIPTION	RESULTS
1	Conducted RF Emissions, 150 kHz – 30 MHz	This test was not performed because the EUT operates on battery power only and cannot be plugged into the AC public mains.
2	Spurious Radiated RF Emissions, 9 kHz – 4.34 GHz (Transmitter and Digital portion)	Complies with the <b>Class B</b> limits of CFR Title 47, Part 15 Subpart B; the limits of CFR Title 47, Part 15 Subpart C, sections 15.205, 15.209, and 15.231; and the limits of RSS-210 and RSS-Gen. See section 6.3 for Measurement Uncertainty.
3	-20 dB Bandwidth	Complies with limits of CFR Title 47, Part 15 Subpart C, section 15.231 (c); and the limits of RSS-210
4	Transmission Time	Complies with limits of CFR Title 47, Part 15 Subpart C, section 15.231 (a)(1) and (a)(2); and the limits of RSS-210.

\*U = Expanded Uncertainty with a coverage factor of k=2

**1. PURPOSE**

This document is a qualification test report based on the emissions tests performed on the Wearable Action Button, Model (HVIN): WST-130. The emissions measurements were performed according to the measurement procedure described in ANSI C63.4 and ANSI C63.10. The tests were performed to determine whether the electromagnetic emissions from the equipment under test, referred to as EUT hereafter, are within the Class B specification limits defined by CFR Title 47, Part 15 Subpart B section, 15.109; the specification limits defined by CFR Title 47, Part 15 Subpart C sections 15.205, 15.209 and 15.231; and the specifications limits defined by RSS-210 and RSS-Gen.

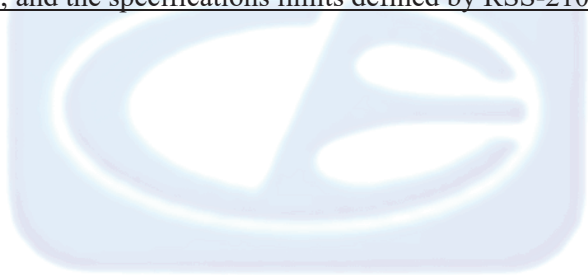

## 1.1 Decision Rule & Risk

If a measured value exceeds a specification limit it implies non-compliance. If the value is below a specification limit it implies compliance. Measurement uncertainty of the laboratory is reported with all measurement results but generally not taken into consideration unless a standard, rule or law requires it to be considered.

Qualification test reports are only produced for products that are in compliance with the test requirements, therefore results are always in conformity. Otherwise, an engineering report or just the data is provided to the customer.

When performing a measurement and making a statement of conformity, in or out-of-specification to manufacturer's specifications or Pass/Fail against a requirement, there are two possible outcomes:

- The result is reported as conforming with the specification
- The result is reported as not conforming with the specification

The decision rule is defined below.

When the test result is found to be below the limit but within our measurement uncertainty of the limit, it is our policy that the final acceptance decision is left to the customer, after discussing the implications and potential risks of the decision.

When the test result is found to be exactly on the specification, it is our policy, in the case of unwanted emissions measurements to consider the result non-compliant, however, the final decision is left to the customer, after discussing the implications and potential risks of the decision.

When the test result is found to be over the specification limit under any condition, it is our policy to consider the result non-compliant.

In terms of uncertainty of measurement, the laboratory is a calibrated and tightly controlled environment and generally exceptionally stable, the measurement uncertainties are evaluated without the considering of the test sample. When it comes to the test sample however, as most testing is performed on a single sample rather than a sample population, and that sample is often a pre-production representation of the final product, that test sample represents a significantly higher source of measurement uncertainty. We advise our customers of this and that when in doubt (small test to limit margins), they may wish to perform statistical sampling on a population to gain a higher confidence in the results. All lab reported results are that of a single sample in any event.

## 2. ADMINISTRATIVE DATA

### 2.1 Location of Testing

The emissions tests described herein were performed at the test facility of Compatible Electronics, 114 Olinda Drive, Brea, California 92823.

### 2.2 Traceability Statement

The calibration certificates of all test equipment used during the test are on file at the location of the test. The calibration is traceable to the National Institute of Standards and Technology (NIST).

### 2.3 Cognizant Personnel

Ecolink Intelligent Technology, Inc.

David J. Shepard	Product Compliance/QA Specialist
Jay Stone	Director of Engineering

Compatible Electronics Inc.

Kyle Fujimoto	Senior Test Engineer
James Ross	Senior Test Engineer

### 2.4 Date Test Sample was Received

The test sample was received prior to the initial test date in this report.

### 2.5 Disposition of the Test Sample

The test sample has not been returned to Ecolink Intelligent Technology, Inc. as of the date of this report.

### 2.6 Abbreviations and Acronyms

The following abbreviations and acronyms may be used in this document.

EMI	Electromagnetic Interference
EUT	Equipment Under Test
P/N	Part Number
S/N	Serial Number
FCC	Federal Communications Commission
DoC	Declaration of Conformity
N/A	Not Applicable
Tx	Transmit
Rx	Receive
Inc.	Incorporated
RSS	Radio Standards Specification
RF	Radio Frequency
BLE	Bluetooth Low Energy
CFR	Code of Federal Regulations
PCB	Printed Circuit Board
DC	Direct Current
LED	Light Emitting Diode



### 3. APPLICABLE DOCUMENTS

The following documents are referenced or used in the preparation of this emission Test Report.

<b>SPEC</b>	<b>TITLE</b>
FCC Title 47, Part 15 Subpart B	FCC Rules – Radio frequency devices (including digital devices) – Unintentional Radiators
FCC Title 47, Part 15 Subpart C	FCC Rules – Radio frequency devices (including digital devices) – Intentional Radiators
RSS-210 Issue 10: 2019 + Amendment (April 2020)	License-exempt Radio Apparatus: Category I Equipment
RSS-Gen Issue 5: 2018 + Amendment 1: 2019 + Amendment 2: 2021	General Requirements for Compliance of Radio Apparatus
ANSI C63.4: 2014	American National Standard for Methods of Measurement of Radio-Noise Emissions from Low-Voltage Electrical and Electronic Equipment in the Range of 9 kHz to 40 GHz
ANSI C63.4a: 2017	American National Standard for Methods of Measurement of Radio-Noise Emissions from Low-Voltage Electrical and Electronic Equipment in the Range of 9 kHz to 40 GHz  Amendment 1: Test Site Validation
ANSI C63.10: 2013	American National Standard of procedure for compliance testing of unlicensed wireless devices

## **4. DESCRIPTION OF TEST CONFIGURATION**

### **4.1 Description of Test Configuration – Emissions**

The Wearable Action Button, Model: WST-130 (EUT) tested as a standalone device and placed in the center of the test table.

The EUT was transmitting at 433.92 MHz on a continuous basis.

The EUT was tested for emissions while in the X, Y and Z axis. The X orientation is when the EUT is parallel to the ground mounted horizontally. The Y orientation is when the EUT is perpendicular to the ground mounted vertically. The Z orientation is when the EUT is perpendicular to the ground mounted horizontally.

The EUT had a fresh battery installed prior to the testing.

The firmware inside the EUT allowed the EUT to continuously transmit at 433.92 MHz.

The firmware was set to the maximum power setting.

The firmware is stored on the company's servers.

The final radiated emissions data for the EUT was taken in the configuration described above. Please see Appendix E for the data sheets.

#### **4.1.1 Cable Construction and Termination**

The EUT contained no external cables.

**5. LISTS OF EUT, ACCESSORIES AND TEST EQUIPMENT****5.1 EUT and Accessory List**

<b>EQUIPMENT</b>	<b>MANUFACTURER</b>	<b>MODEL NUMBER</b>	<b>SERIAL NUMBER</b>	<b>ID</b>
WEARABLE ACTION BUTTON (EUT)	ECOLINK INTELLIGENT TECHNOLOGY, INC.	WST-130	1	FCC: XQC-WST130 IC: 9863B-WST130
FIRMWARE	ECOLINK INTELLIGENT TECHNOLOGY, INC.	Version: 1.0	N/A	N/A

## 5.2 Emissions Test Equipment

EQUIPMENT TYPE	MANUFACTURER	MODEL NUMBER	SERIAL NUMBER	CAL. DATE	CAL. DUE DATE
<b>RF RADIATED AND AC CONDUCTED EMISSIONS TEST EQUIPMENT</b>					
TDK TestLab	TDK RF Solutions, Inc.	9.22	700145	N/A	N/A
EMI Receiver, 3 Hz – 44 GHz	Keysight Technologies, Inc.	N9038A	MY59050117	July 14, 2023	July 14, 2024
System Controller	Sunol Sciences Corporation	SC110V	112213-1	N/A	N/A
Turntable	Sunol Sciences Corporation	2011VS	N/A	N/A	N/A
Antenna-Mast	Sunol Sciences Corporation	TWR95-4	112213-3	N/A	N/A
Loop Antenna	Com-Power	AL-130R	121090	February 10, 2022	February 10, 2025
CombiLog Antenna	Com-Power	AC-220	61093	December 14, 2021	December 14, 2023
Horn Antenna	Com-Power	AH-118	10050113	December 16, 2021	December 16, 2023
Preamplifier	Com-Power	PA-118	181653	March 7, 2022	March 7, 2024
Computer	Hewlett Packard	p6716f	MXX1030PX0	N/A	N/A
LCD Monitor	Hewlett Packard	52031a	3CQ046N3MG	N/A	N/A

## 6. TEST SITE DESCRIPTION

### 6.1 Test Facility Description

Please refer to section 2.1 of this report for emissions test location.

### 6.2 EUT Mounting, Bonding and Grounding

**For frequencies 1 GHz and below:** The EUT was mounted on a 0.6 by 1.2 meter non-conductive table 0.8 meters above the ground plane.

**For frequencies above 1 GHz:** The EUT was mounted on a 0.6 by 1.2 meter non-conductive table 1.5 meters above the ground plane.

The EUT was not grounded.

### 6.3 Measurement Uncertainty

Compatible Electronics'  $U_{lab}$  value is less than  $U_{cispr}$ , thus based on this – compliance is deemed to occur if no measured disturbance exceeds the disturbance limit

$$u_c(y) = \sqrt{\sum_i c_i^2 u^2(x_i)}$$

Measurement		$U_{cispr}$	$U_{lab} = 2 u_c(y)$
Conducted disturbance (mains port)	(150 kHz – 30 MHz)	3.4 dB	2.72 dB
Radiated disturbance (electric field strength on an open area test site or alternative test site)	(30 MHz – 1 000 MHz)	6.3 dB	3.32 dB (Vertical) 3.30 dB (Horizontal)
Radiated disturbance (electric field strength on an open area test site or alternative test site)	(1 GHz - 6 GHz)	5.2 dB	4.06 dB
Radiated disturbance (electric field strength on an open area test site or alternative test site)	(6 GHz – 18 GHz)	5.5 dB	4.06 dB
Radiated disturbance (electric field strength on an open area test site or alternative test site)	(18 GHz – 26.5 GHz)	N/A	4.43 dB
Radiated disturbance (electric field strength on an open area test site or alternative test site)	(26.5 GHz – 40 GHz)	N/A	4.57 dB



## 7. TEST PROCEDURES

The following sections describe the test methods and the specifications for the tests. Test results are also included in this section.

### 7.1 RF Emissions

#### 7.1.1 Conducted Emissions Test

The EMI Receiver was used as a measuring meter. A quasi-peak and/or average reading was taken only where indicated in the data sheets. A 10 dB attenuator was used for the protection of the EMI Receiver input stage, and the offset was adjusted accordingly to read the actual data measured. The LISN output was measured using the EMI Receiver. The output of the second LISN was terminated by a 50-ohm termination. The effective measurement bandwidth used for this test was 9 kHz.

Please see section 6.2 of this report for mounting, bonding, and grounding of the EUT. The EUT was powered through the LISN, which was bonded to the ground plane. The LISN power was filtered and the filter was bonded to the ground plane. The EUT was set up with the minimum distances from any conductive surfaces as specified in ANSI 63:4. The excess power cord was wrapped in a figure eight pattern to form a bundle not exceeding 0.4 meters in length.

The conducted emissions from the EUT were maximized for operating mode as well as cable placement. The final data was collected under program control by computer software. The final qualification data is located in Appendix E.

#### **Test Results:**

This test was not performed because the EUT operates on battery power only and cannot be plugged into the AC public mains.

## 7.1.2 Radiated Emissions Test

The EMI Receiver was used as the measuring meter. An internal preamplifier was used to increase the sensitivity of the instrument during emissions tests up to 1000 MHz, and an external preamplifier was used to increase the sensitivity of the instrument during emissions tests above 1 GHz. The EMI Receiver was initially used with the Analyzer mode feature activated. In this mode, the EMI receiver can then record the actual frequency to be measured. This final reading is then taken accurately in the EMI Receiver mode, which considers the cable loss, amplifier gain and antenna factors, so that a true reading is compared to the true limit. The effective measurement bandwidth used for the radiated emissions test was according to the frequency measured.

The frequencies below 1 GHz, except for the fundamental frequency and the 2<sup>nd</sup> harmonic of the fundamental frequency, were quasi-peaked using the quasi-peak detector of the EMI Receiver.

The fundamental and harmonic frequencies were averaged using the duty cycle correction calculation, see section 7.1.5 of this report.

All other frequencies above 1 GHz were averaged using the average detector of the EMI Receiver.

The EMI test chamber of Compatible Electronics, Inc. was used for radiated emissions testing. This test site is in full compliance with ANSI C63.4. Please see section 6.2 of this report for mounting, bonding and grounding of the EUT. The turntable supporting the EUT is remote controlled using a motor. The turntable permits EUT rotation of 360 degrees to maximize emissions. Also, the antenna mast allows height variation of the antenna from 1 meter to 4 meters. Data was collected in the worst case (highest emission) configuration of the EUT. At each reading, the EUT was rotated 360 degrees and the antenna height was varied from 1 to 4 meters (for E field radiated field strength). The gunsight method was used when measuring with the horn antenna to ensure accurate results.

The EUT was tested at a 3-meter test distance. The six highest emissions are listed in Table 1.

The measurement bandwidths and transducers used for the radiated emissions test were:

FREQUENCY RANGE	EFFECTIVE MEASUREMENT BANDWIDTH	TRANSDUCER
9 kHz to 150 kHz	200 Hz	Loop Antenna
150 kHz to 30 MHz	9 kHz	Loop Antenna
30 MHz to 1 GHz	120 kHz	CombiLog Antenna
1 GHz to 4.34 GHz	1 MHz	Horn Antenna

### Test Results:

The EUT complies with the **Class B** limits of CFR Title 47, Part 15, Subpart B; the limits of CFR Title 47, Part 15, Subpart C sections 15.205, 15.209 and 15.231; and the limits of RSS-210 and RSS-Gen for radiated emissions.

### 7.1.3 RF Emissions Test Results

Table 1 RADIATED EMISSION RESULTS  
Wearable Action Button, Model: WST-130

Frequency (MHz)	Corrected Reading* (dB $\mu$ V/m)	Specification Limit (dB $\mu$ V/m)	Delta (Cor. Reading – Spec. Limit) (dB)
433.92 (V) (Y-Axis)	72.69 (AV)	80.82 (AV)	-8.13
433.92 (V) (Z-Axis)	72.54 (AV)	80.82 (AV)	-8.28
433.92 (H) (X-Axis)	69.66 (AV)	80.82 (AV)	-11.16
160.10 (V) (X-Axis)	29.51 (QP)	43.50 (QP)	-13.99
433.92 (H) (Z-Axis)	66.47 (AV)	80.82 (AV)	-14.35
1735.68 (H) (Z-Axis)	45.55 (AV)	60.82 (AV)	-15.27

Notes:

- \* The complete emissions data is given in Appendix E of this report.
- (V) Vertical
- (H) Horizontal
- (AV) Average
- (QP) Quasi-Peak



## 7.1.4 Sample Calculations

A correction factor for the antenna, cable and a distance factor (if any) must be applied to the meter reading before a true field strength reading can be obtained. This Corrected Meter Reading is then compared to the specification limit in order to determine compliance with the limits.

Conversion to logarithmic terms: Specification limit ( $\mu\text{V}/\text{m}$ )  $\log \times 20 =$  Specification Limit in  $\text{dBuV}/\text{m}$

To correct for distance when measuring at a distance other than the specification

For measurements below 30 MHz: (Specification distance / test distance)  $\log \times 40 =$  distance factor

For measurements above 30 MHz: (Specification distance / test distance)  $\log \times 20 =$  distance factor

Note: When using an Active Antenna, the Antenna factor shall be subtracted due to the combination of the internal amplification and antenna loss.

Corrected Meter Reading = meter reading + F – A + C

where:            F = antenna factor  
                      A = amplifier gain  
                      C = cable loss

The correction factors for the antenna and the amplifier gain are attached in Appendix D of this report. The data sheets are attached in Appendix E.

The distance factor D is 0 when the test is performed at the required specification distance.

When the limit is in terms of magnetic field, the following equation applies:

$$H[\text{dB}(\mu\text{A}/\text{m})] = V[\text{dB}(\mu\text{V})] + L_C [\text{dB}] - G_{PA} [\text{dB}] + AF^H [\text{dB}(\text{S}/\text{m})]$$

where:             $H$  is the magnetic field strength (to be compared with the limit),  
                       $V$  is the voltage level measured by the receiver or spectrum analyzer,  
                       $L_C$  is the cable loss,  
                       $G_{PA}$  is the gain of the preamplifier (if used), and  
                       $AF^H$  is the magnetic antenna factor.

The  $G_{PA}$  term is only included in the equation when an external preamplifier is used in the measurement chain, in front of the receiver or spectrum analyzer. An external preamplifier is not usually necessary (or even advisable, due to risk of saturating the input mixer of the receiver) when an active loop antenna is used. In that case, the antenna factor of the loop already includes the gain of its built-in preamplifier.

If the “electrical” antenna factor is used instead, the above equation becomes:

$$H[\text{dB}(\mu\text{A}/\text{m})] = V[\text{dB}(\mu\text{V})] + L_C [\text{dB}] - G_{PA}[\text{dB}] + AF^E [\text{dB}(\text{m}^{-1})] - 51.5 [\text{dB}\Omega]$$

where:             $AF^E$  is the “electric” antenna factor, as provided by the antenna calibration laboratory.

When the limit is in terms of electric field, the following equation applies:

$$E[\text{dB}(\mu\text{V}/\text{m})] = V[\text{dB}(\mu\text{V})] + L_C[\text{dB}] - G_{PA}[\text{dB}] + AF^E [\text{dB}(\text{m}^{-1})]$$

or, if the magnetic antenna factor is used:

$$E[\text{dB}(\mu\text{V}/\text{m})] = V[\text{dB}(\mu\text{V})] + L_C[\text{dB}] - G_{PA}[\text{dB}] + AF^H [\text{dB}(\text{S}/\text{m})] + 51.5[\text{dB}\Omega]$$

The display of the receiver (or spectrum analyzer) **shall not** be configured in units of current, e.g.  $\mu\text{A}$  or  $\text{dB}(\mu\text{A})$ . That conversion is calculated inside the receiver (or spectrum analyzer) using its input impedance, which is  $50 \Omega$ , while the magnetic field calculation is based on the free-space impedance of  $377 \Omega$ .

### 7.1.5 Duty Cycle Calculation

The fundamental and harmonics were measured at a 3-meter test distance. The EMI Receiver was used to obtain the final test data. The final qualification data sheets are in Appendix E.

Where

$$\delta(\text{dB}) = 20 \log \left[ \frac{\sum (nt_1 + mt_2 + \dots + \xi t_x)}{T} \right]$$

$n$  is the number of pulses of duration  $t_1$

$m$  is the number of pulses of duration  $t_2$

$\xi$  is the number of pulses of duration  $t_x$

$T$  is the period of the pulse train or 100 ms if the pulse train length is greater than 100 ms

Duty Cycle Correction Factor = -18.74 dB

Time of One Small Pulse = 120  $\mu\text{s}$

Time of One Large Pulse = 220  $\mu\text{s}$

Number of Small Pulses = 56

Number of Large Pulses = 22

Total On Time = 11560  $\mu\text{s}$  = 11.56 ms

The time between pulses is greater than 100.00 ms

Duty Cycle = 11.56 ms / 100.00 ms = 11.56 %



### 7.1.6 99 % Bandwidth

The 99 % bandwidth was measured using an EMI Receiver.

The following steps were performed for measuring the 99 % bandwidth per RSS-GEN, Issue 5, clause 6.7:

1. Set RBW to 1 % to 5 % of the actual occupied bandwidth.
2. Set VBW to greater than 3 times the RBW.
3. Set the EMI Receiver to the occupied bandwidth Function set at 99 %
4. Set the peak detector to max hold.
5. Set the sweep time to auto
6. Allow the trace to stabilize.

Please note that this was only used to determine the emission bandwidth and that there are no limits or pass/fail criteria for this test. Please see the data sheets located in Appendix E.

### 7.1.7 -20 dB Bandwidth

The -20 dB bandwidth was measured using an EMI Receiver.

The following steps were performed for measuring the -20 dB bandwidth:

1. Set RBW from 1% to 5% of the Occupied Bandwidth.
2. Set the span to 100 kHz.
3. Set VBW to greater than 3 times the RBW.
4. Set the peak detector to max hold.
5. Set the sweep time to auto
6. Allow the trace to stabilize.
7. Set the markers to -20 dB of the peak fundamental emission

#### Test Results:

The EUT complies with limits of CFR Title 47, Part 15, Subpart C section 15.231 (c); and the limits of RSS-210.

### 7.1.8 Transmission Time

The transmission time was measured using an EMI Receiver.

The following steps were performed for measuring transmission time:

1. Set RBW = 120 kHz
2. Set VBW = 510 kHz
3. Span = 0 Hz
4. Set the sweep time to 10 seconds
5. Push a button on the EUT, which automatically activated the transmitter
6. Allow the trace to stabilize
7. Set the 1<sup>st</sup> marker to start of the transmission
8. Set the 2<sup>nd</sup> marker to the end of the transmission
9. Verify the transmission does not go beyond 5 seconds

#### Test Results:

The EUT complies with limits of CFR Title 47, Part 15, Subpart C section 15.231 (a)(1) and (a)(2); and the limits of RSS-210.

### 7.1.9 Variation of the Input Power

The variation of the input power test was performed using the EMI Receiver. The EUT input power was varied between 85 % and 115 % of the nominal rated supply voltage. The carrier frequency was monitored for any change in amplitude.

#### Test Results:

This test was not performed because the EUT is battery power only.

## 8. CONCLUSIONS

The Wearable Action Button, Model (HVIN): WST-130 (EUT), as tested, meets all the specification limits defined in RSS-210, RSS-Gen, the **Class B** specification limits defined in CFR Title 47, Part 15, Subpart B; and the specification limits defined in CFR Title 47, Part, 15, Subpart C, sections 15.205, 15.209 and 15.231.





**APPENDIX A**

***LABORATORY ACCREDITATIONS AND RECOGNITIONS***

---

**Brea Division**  
114 Olinda Drive  
Brea, CA 92823  
(714) 579-0500

**Newbury Park Division**  
1050 Lawrence Drive  
Newbury Park, CA 91320  
(805) 480-4044

**Lake Forest Division**  
20621 Pascal Way  
Lake Forest, CA 92630  
(949) 587-0400

## LABORATORY ACCREDITATIONS AND RECOGNITIONS



For US, Canada, Australia/New Zealand, Japan, Taiwan, Korea, and the European Union, Compatible Electronics is currently accredited by NVLAP to ISO/IEC 17025.

For the most up-to-date version of our scopes and certificates please visit

<http://celectronics.com/quality/scope/>

Quote from ISO-ILAC-IAF Communiqué on the Management Systems Requirements of ISO/IEC 17025, General Requirements for the competence of testing and calibration laboratories:

"A laboratory's fulfilment of the requirements of ISO/IEC 17025 means the laboratory meets both the technical competence requirements and management system requirements that are necessary for it to consistently deliver technically valid test results and calibrations. The management system requirements in ISO/IEC 17025 are written in language relevant to laboratory operations and operate generally in accordance with the principles of ISO 9001"

Innovation, Science and Economic Development Canada  
Lab Code 2154A



**APPENDIX B**

***MODIFICATIONS TO THE EUT***



## MODIFICATIONS TO THE EUT

The modifications listed below were made to the EUT to pass FCC Subpart B, FCC 15.231, RSS-210, and RSS-Gen specifications.

All the rework described below was implemented during the test in a method that could be reproduced in all the units by the manufacturer.

No modifications were made to the EUT during the testing.





**APPENDIX C**

***MODELS COVERED UNDER THIS REPORT***

## MODELS COVERED UNDER THIS REPORT

**USED FOR THE PRIMARY TEST**

Wearable Action Button  
Model (HVIN): WST-130  
S/N: 1

**ADDITIONAL MODELS COVERED:**

The following model is considered by the manufacturer to be similar to the sample tested, however the test results contained in this report relate only to the sample tested.

Wearable Action Button  
Model (HVIN): RE603P

Differences between the two Model Numbers (HVIN) WST-130 and the RE603P:

Model (HVIN):	Features
WST-130	Identical to the RE603P in power output, hardware, and firmware. Model option is for marketing purposes only.
RE603P	Identical to the WST-130 in power output, hardware, and firmware. Model option is for marketing purposes only.



**APPENDIX D**

***DIAGRAMS, CHARTS, AND PHOTOS***

**FIGURE 1: CONDUCTED EMISSIONS TEST SETUP**

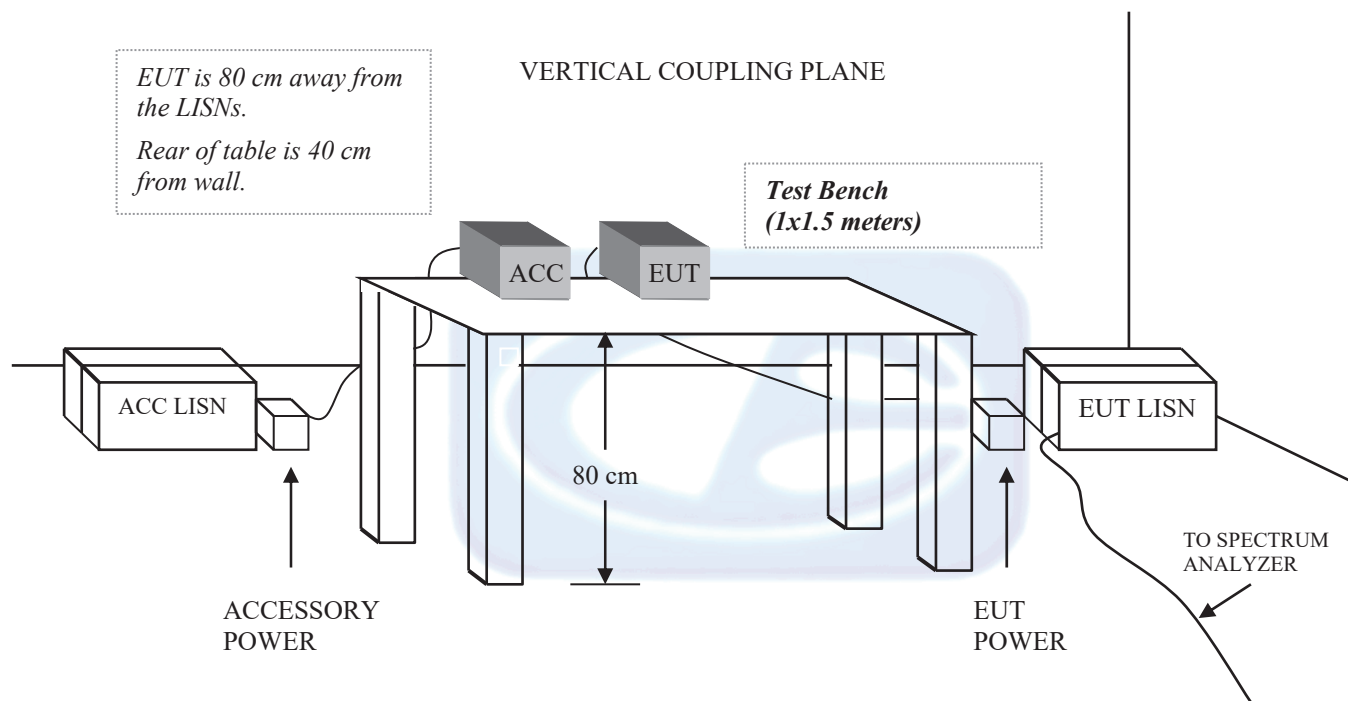

***FIGURE 2: LAYOUT OF THE SEMI-ANECHOIC TEST CHAMBER***

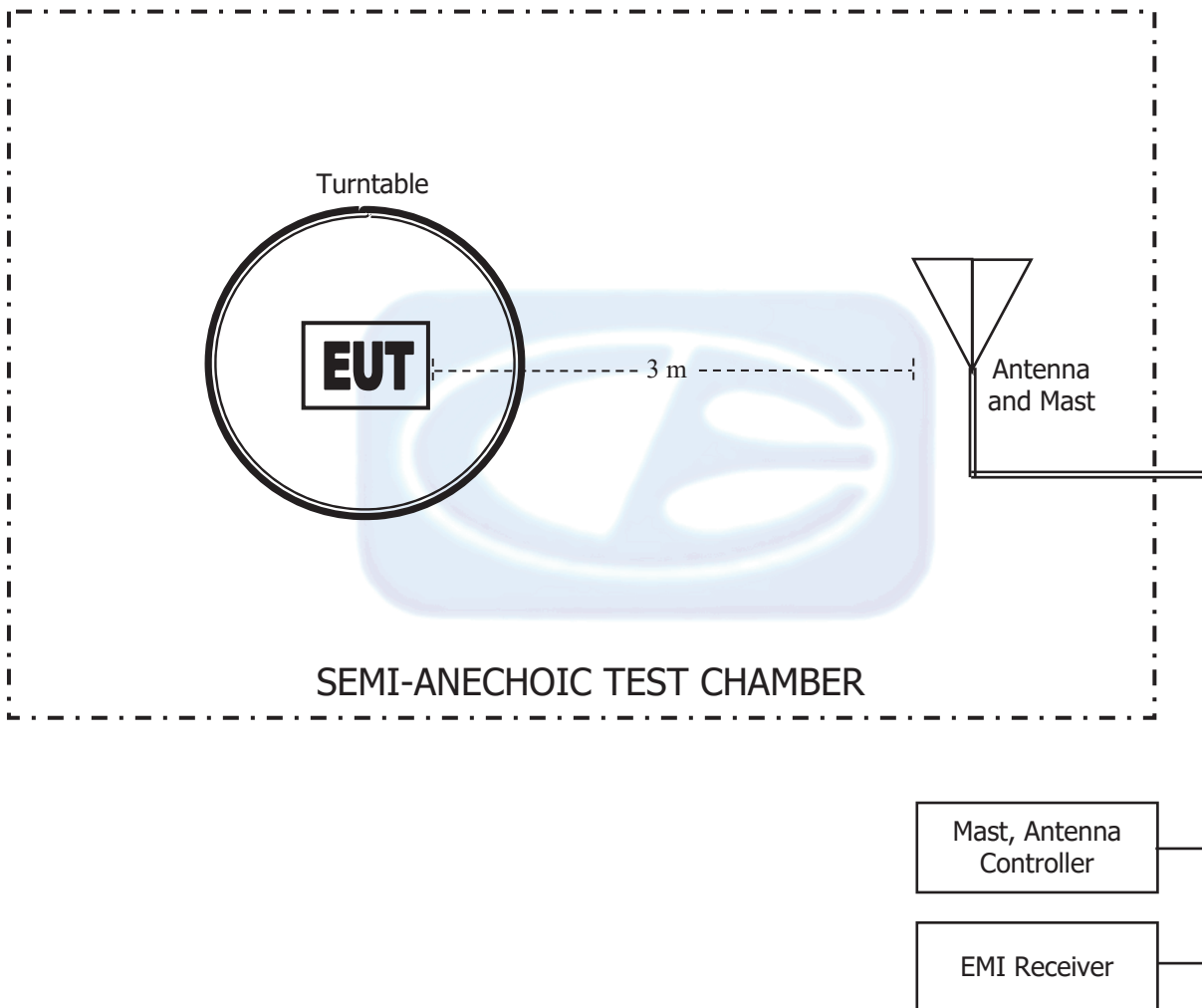

**COM-POWER AL-130R****LOOP ANTENNA**

S/N: 121090

CALIBRATION DATE: FEBRUARY 10, 2022

<b>FREQUENCY (MHz)</b>	<b>MAGNETIC (dB/m)</b>	<b>ELECTRIC (dB/m)</b>
0.009	15.6	-35.8
0.01	15.8	-35.6
0.02	14.8	-36.6
0.03	15.6	-35.9
0.04	15.0	-36.5
0.05	14.4	-37.1
0.06	14.6	-36.9
0.07	14.3	-37.2
0.08	14.3	-37.2
0.09	14.4	-37.0
0.10	14.1	-37.4
0.20	14.1	-37.4
0.30	14.0	-37.5
0.40	13.9	-37.6
0.50	14.1	-37.3
0.60	14.1	-37.3
0.70	14.2	-37.3
0.80	14.2	-37.3
0.90	14.2	-37.2
1.00	14.4	-37.0
2.00	14.6	-36.9
3.00	14.6	-36.8
4.00	14.9	-36.6
5.00	14.9	-36.7
6.00	14.8	-36.7
7.00	14.6	-36.8
8.00	14.5	-37.0
9.00	14.3	-37.2
10.00	14.5	-37.0
11.00	14.6	-36.9
12.00	14.7	-36.7
13.00	14.9	-36.6
14.00	15.0	-36.5
15.00	14.9	-36.6
16.00	14.9	-36.6
17.00	14.6	-36.8
18.00	14.4	-37.1
19.00	14.5	-37.0
20.00	14.5	-37.0
21.00	14.2	-37.3
22.00	13.9	-37.5
23.00	13.9	-37.5
24.00	13.8	-37.7
25.00	13.4	-38.0
26.00	13.2	-38.2
27.00	13.2	-38.3
28.00	12.7	-38.7
29.00	12.7	-38.8
30.00	12.4	-39.0

**COM-POWER AC-220****COMBILOG ANTENNA****S/N: 61093****CALIBRATION DATE: DECEMBER 14, 2021**

<b>FREQUENCY (MHz)</b>	<b>FACTOR (dB)</b>	<b>FREQUENCY (MHz)</b>	<b>FACTOR (dB)</b>
30	22.50	200	16.00
35	21.40	250	17.40
40	21.00	300	19.70
45	20.60	350	20.00
50	19.70	400	22.20
60	16.10	450	22.40
70	12.80	500	23.10
80	12.50	550	23.40
90	14.20	600	24.90
100	15.40	650	25.30
120	16.50	700	25.40
125	16.80	750	26.40
140	15.90	800	26.70
150	16.60	850	27.10
160	18.50	900	27.90
175	15.90	950	28.00
180	15.50	1000	28.00



**COM POWER AH-118****HORN ANTENNA****S/N: 10050113****CALIBRATION DATE: DECEMBER 16, 2021**

<b>FREQUENCY (GHz)</b>	<b>FACTOR (dB)</b>	<b>FREQUENCY (GHz)</b>	<b>FACTOR (dB)</b>
1.0	23.86	10.0	38.91
1.5	25.67	10.5	39.94
2.0	28.25	11.0	39.10
2.5	29.17	11.5	39.70
3.0	29.78	12.0	40.29
3.5	30.88	12.5	41.93
4.0	31.21	13.0	41.34
4.5	32.96	13.5	40.57
5.0	33.30	14.0	40.23
5.5	34.24	14.5	42.25
6.0	34.57	15.0	43.63
6.5	35.61	15.5	39.96
7.0	36.60	16.0	40.38
7.5	37.49	16.5	40.56
8.0	37.44	17.0	40.93
8.5	37.98	17.5	42.27
9.0	38.01	18.0	43.77
9.5	38.53		

**COM-POWER PAM-118****PREAMPLIFIER****S/N: 181653****CALIBRATION DATE: MARCH 7, 2022**

<b>FREQUENCY (GHz)</b>	<b>FACTOR (dB)</b>	<b>FREQUENCY (GHz)</b>	<b>FACTOR (dB)</b>
1.0	40.02	6.0	38.84
1.1	39.72	6.5	39.20
1.2	39.93	7.0	39.46
1.3	39.98	7.5	39.67
1.4	39.99	8.0	39.28
1.5	40.20	8.5	38.63
1.6	40.05	9.0	38.96
1.7	40.15	9.5	39.33
1.8	40.20	10.0	39.58
1.9	40.33	11.0	38.25
2.0	40.33	12.0	40.03
2.5	40.60	13.0	40.55
3.0	40.76	14.0	40.36
3.5	40.87	15.0	39.34
4.0	40.39	16.0	37.34
4.5	39.55	17.0	42.14
5.0	40.34	18.0	42.54
5.5	39.45		



**FRONT VIEW**

**ECOLINK INTELLIGENT TECHNOLOGY, INC.**

**WEARABLE ACTION BUTTON**

**MODEL: WST-130**

**FCC SUBPART B AND C; RSS-210 AND RSS-GEN – RADIATED EMISSIONS – BELOW 1 GHz**

**PHOTOGRAPH SHOWING THE EUT CONFIGURATION  
FOR MAXIMUM EMISSIONS**





**REAR VIEW**

ECOLINK INTELLIGENT TECHNOLOGY, INC.

WEARABLE ACTION BUTTON

MODEL: WST-130

FCC SUBPART B AND C; RSS-210 AND RSS-GEN – RADIATED EMISSIONS – BELOW 1 GHz

**PHOTOGRAPH SHOWING THE EUT CONFIGURATION  
FOR MAXIMUM EMISSIONS**

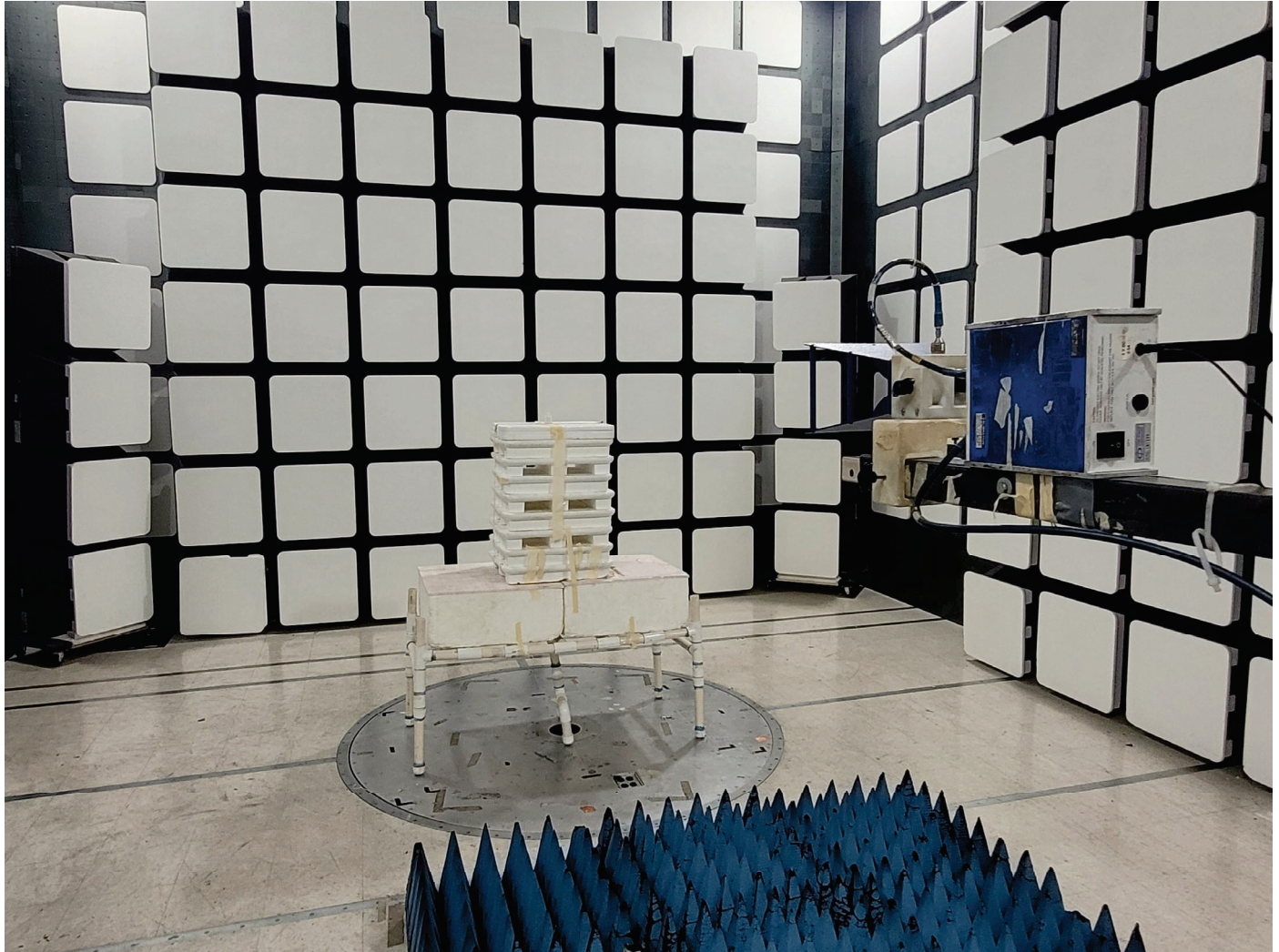
**FRONT VIEW**

ECOLINK INTELLIGENT TECHNOLOGY, INC.

WEARABLE ACTION BUTTON

MODEL: WST-130

FCC SUBPART B AND C; RSS-210 AND RSS-GEN – RADIATED EMISSIONS – ABOVE 1 GHz

**PHOTOGRAPH SHOWING THE EUT CONFIGURATION  
FOR MAXIMUM EMISSIONS****Brea Division  
114 Olinda Drive  
Brea, CA 92823  
(714) 579-0500****Newbury Park Division  
1050 Lawrence Drive  
Newbury Park, CA 91320  
(805) 480-4044****Lake Forest Division  
20621 Pascal Way  
Lake Forest, CA 92630  
(949) 587-0400**

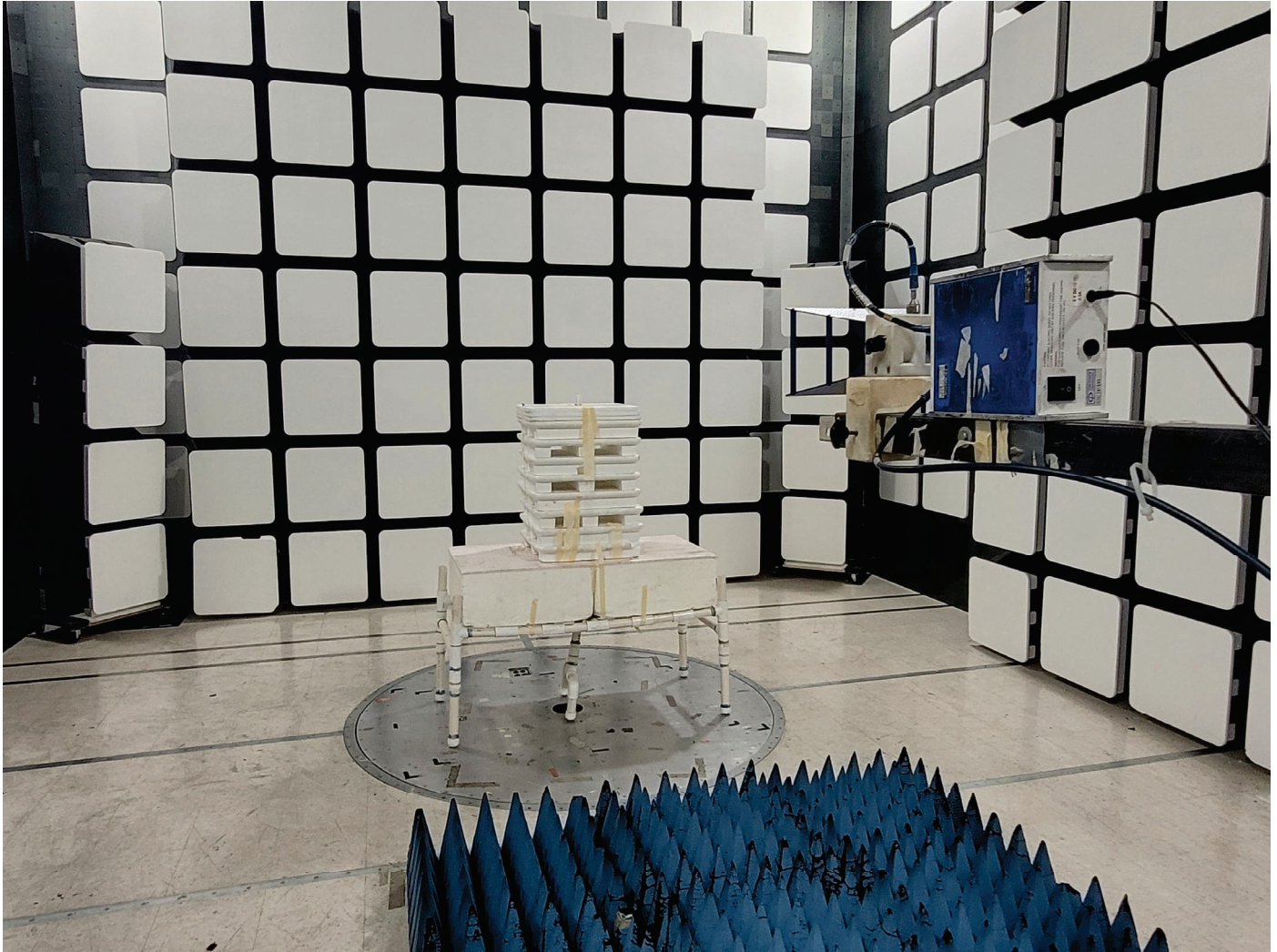

**REAR VIEW**

ECOLINK INTELLIGENT TECHNOLOGY, INC.

WEARABLE ACTION BUTTON

MODEL: WST-130

FCC SUBPART B AND C; RSS-210 AND RSS-GEN – RADIATED EMISSIONS – ABOVE 1 GHz

**PHOTOGRAPH SHOWING THE EUT CONFIGURATION  
FOR MAXIMUM EMISSIONS****Brea Division  
114 Olinda Drive  
Brea, CA 92823  
(714) 579-0500****Newbury Park Division  
1050 Lawrence Drive  
Newbury Park, CA 91320  
(805) 480-4044****Lake Forest Division  
20621 Pascal Way  
Lake Forest, CA 92630  
(949) 587-0400**



**APPENDIX E**

***DATA SHEETS***

***RADIATED EMISSIONS***

***DATA SHEETS***



Title: Pre-Scan - FCC Class B  
 File: 1 - Pre-Scan - 433.92 MHz - X-Axis - FCC Class B - 12-05-2023.set  
 Operator: Kyle Fujimoto  
 EUT Type: Wearable Action Button  
 EUT Condition: The EUT is continuously transmitting at 433.92 MHz  
 Company: Ecolink Intelligent Technology, Inc.  
 Model: WST-130  
 S/N: 1  
 X-Axis - Worst case  
 Note 1: Internal Battery Powered  
 Note 2: The frequencies at 433.92 MHz and 867.84 MHz are the fundamental and 2nd harmonic of the intentional radiator and are not subject to FCC Subpart B limits.

12/5/2023 10:50:27 AM  
 Sequence: Preliminary Scan

FCC Class B

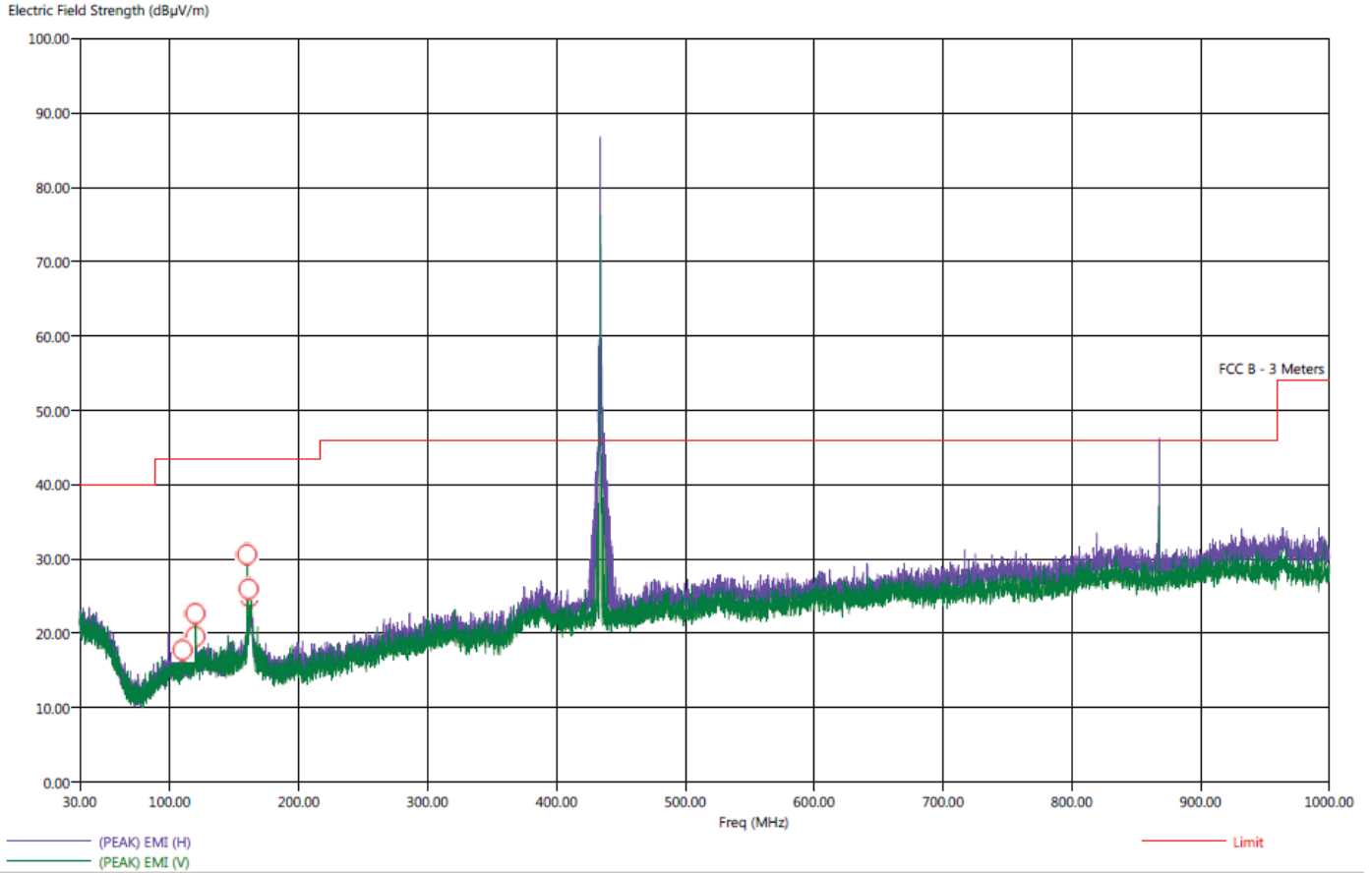

Title: Radiated Final - FCC Class B  
 File: 1 - Final Scan - 433.92 MHz - X-Axis - FCC Class B - 12-05-2023.set  
 Operator: Kyle Fujimoto  
 EUT Type: Wearable Action Button  
 EUT Condition: The EUT is continuously transmitting at 433.92 MHz  
 Company: Ecolink Intelligent Technology, Inc.  
 Model: WST-130  
 S/N: 1  
 X-Axis  
 Note: Internal Battery Powered

12/5/2023 11:02:46 AM  
 Sequence: Final Measurements

**FCC Class B**

Freq (MHz)	Pol	(PEAK) EMI (dBµV/m)	(QP) EMI (dBµV/m)	(PEAK) Margin (dB)	(QP) Margin (dB)	Limit (dBµV/m)	Transducer (dB)	Cable (dB)	Ttbl Aql (deq)	Twr Ht (cm)
110.00	V	18.09	13.16	-25.41	-30.34	43.50	15.82	0.65	197.00	255.22
120.00	H	20.50	17.04	-23.00	-26.46	43.50	16.52	0.70	12.00	382.56
120.00	V	25.41	21.19	-18.09	-22.31	43.50	16.50	0.70	113.50	175.28
160.10	V	32.44	29.51	-11.06	-13.99	43.50	18.55	0.76	307.50	111.40
161.20	V	25.10	20.23	-18.40	-23.27	43.50	20.77	0.77	110.00	127.22
162.00	H	25.96	20.64	-17.54	-22.86	43.50	22.69	0.77	93.50	254.98





***FUNDAMENTAL AND HARMONICS***

***DATA SHEETS***



**FCC 15.231**

 Ecolink Intelligent Technology, Inc.  
 Wearable Action Button  
 Model: WST-130

Date: 12/05/2023

Lab: D

Tested By: Kyle Fujimoto

**Harmonics**
**Transmit Mode - X-Axis**

Freq. (MHz)	Level (dBuV/m)	Pol (v/h)	Limit	Margin	Peak / QP / Avg	Table Angle (deg)	Ant. Height (cm)	Comments
867.84	46.92	V	80.82	-33.90	Peak	238.50	193.91	
867.84	28.18	V	60.82	-32.64	Avg	238.50	193.91	
1301.76	38.46	V	73.97	-35.51	Peak	127.75	159.34	
1301.76	19.72	V	53.97	-34.25	Avg	127.75	159.34	
1735.68	41.32	V	80.82	-39.50	Peak	324.25	249.08	
1735.68	22.58	V	60.82	-38.24	Avg	324.25	249.08	
2169.60	40.38	V	80.82	-40.44	Peak	302.50	175.22	
2169.60	21.64	V	60.82	-39.18	Avg	302.50	175.22	
2603.52	42.15	V	80.82	-38.67	Peak	87.75	239.28	
2603.52	23.41	V	60.82	-37.41	Avg	87.75	239.28	
3037.44	41.19	V	80.82	-39.63	Peak	122.25	207.04	
3037.44	22.45	V	60.82	-38.37	Avg	122.25	207.04	
3471.36	39.99	V	80.82	-40.83	Peak	107.25	159.58	
3471.36	21.25	V	60.82	-39.57	Avg	107.25	159.58	
3905.28	47.80	V	73.97	-26.17	Peak	91.50	127.34	
3905.28	29.06	V	53.97	-24.91	Avg	91.25	127.34	
4339.20	41.10	V	73.97	-32.87	Peak	99.75	110.68	
4339.20	22.36	V	53.97	-31.61	Avg	99.75	110.68	

**FCC 15.231**

Ecolink Intelligent Technology, Inc.

Wearable Action Button

Model: WST-130

Date: 12/05/2023

Lab: D

Tested By: Kyle Fujimoto

**Harmonics**
**Transmit Mode - Y-Axis**

Freq. (MHz)	Level (dBuV/m)	Pol (v/h)	Limit	Margin	Peak / QP / Avg	Table Angle (deg)	Ant. Height (cm)	Comments
867.84	50.39	V	80.82	-30.43	Peak	244.50	205.13	
867.84	31.65	V	60.82	-29.17	Avg	244.50	205.13	
1301.76	43.06	V	73.97	-30.91	Peak	242.00	127.82	
1301.76	24.32	V	53.97	-29.65	Avg	242.00	127.82	
1735.68	61.71	V	80.82	-19.11	Peak	10.00	159.46	
1735.68	42.97	V	60.82	-17.85	Avg	10.00	159.46	
2169.60	43.94	V	80.82	-36.88	Peak	120.00	111.58	
2169.60	25.20	V	60.82	-35.62	Avg	120.00	111.58	
2603.52	40.45	V	80.82	-40.37	Peak	161.00	249.97	
2603.52	21.71	V	60.82	-39.11	Avg	161.00	249.97	
3037.44	46.33	V	80.82	-34.49	Peak	117.50	111.40	
3037.44	27.59	V	60.82	-33.23	Avg	117.50	111.40	
3471.36	47.93	V	80.82	-32.89	Peak	92.50	111.34	
3471.36	29.19	V	60.82	-31.63	Avg	92.50	111.34	
3905.28	50.06	V	73.97	-23.91	Peak	173.50	127.28	
3905.28	31.32	V	53.97	-22.65	Avg	173.50	127.28	
4339.20	40.43	V	73.97	-33.54	Peak	198.00	239.28	
4339.20	21.69	V	53.97	-32.28	Avg	198.00	239.28	

**FCC 15.231**

Ecolink Intelligent Technology, Inc.

Wearable Action Button

Model: WST-130

Date: 12/05/2023

Lab: D

Tested By: Kyle Fujimoto

**Harmonics**
**Transmit Mode - Z-Axis**

Freq. (MHz)	Level (dBuV/m)	Pol (v/h)	Limit	Margin	Peak / QP / Avg	Table Angle (deg)	Ant. Height (cm)	Comments
867.84	54.15	V	80.82	-26.67	Peak	289.00	135.64	
867.84	35.41	V	60.82	-25.41	Avg	289.00	135.64	
1301.76	39.97	V	73.97	-34.00	Peak	2.25	223.28	
1301.76	21.23	V	53.97	-32.74	Avg	2.25	223.28	
1735.68	53.24	V	80.82	-27.58	Peak	207.75	239.40	
1735.68	34.50	V	60.82	-26.32	Avg	207.75	239.40	
2169.60	38.36	V	80.82	-42.46	Peak	241.50	191.34	
2169.60	19.62	V	60.82	-41.20	Avg	241.50	191.34	
2603.52	38.94	V	80.82	-41.88	Peak	107.75	249.14	
2603.52	20.20	V	60.82	-40.62	Avg	107.75	249.14	
3037.44	47.35	V	80.82	-33.47	Peak	280.00	143.22	
3037.44	28.61	V	60.82	-32.21	Avg	280.00	143.22	
3471.36	46.37	V	80.82	-34.45	Peak	72.25	110.56	
3471.36	27.63	V	60.82	-33.19	Avg	72.25	110.56	
3905.28	51.90	V	73.97	-22.07	Peak	206.75	143.34	
3905.28	33.16	V	53.97	-20.81	Avg	206.75	143.34	
4339.20	43.83	V	73.97	-30.14	Peak	211.25	143.28	
4339.20	25.09	V	53.97	-28.88	Avg	211.25	143.28	



**FCC 15.231**

Ecolink Intelligent Technology, Inc.

Wearable Action Button

Model: WST-130

Date: 12/06/2023

Lab: D

Tested By: Kyle Fujimoto

**Harmonics****Transmit Mode - X-Axis**

Freq. (MHz)	Level (dBuV/m)	Pol (v/h)	Limit	Margin	Peak / QP / Avg	Table Angle (deg)	Ant. Height (cm)	Comments
867.84	53.72	H	80.82	-27.10	Peak	213.75	160.23	
867.84	34.98	H	60.82	-25.84	Avg	213.75	160.23	
1301.76	43.31	H	73.97	-30.66	Peak	42.25	143.46	
1301.76	24.57	H	53.97	-29.40	Avg	42.25	143.46	
1735.68	58.91	H	80.82	-21.91	Peak	230.50	191.40	
1735.68	40.17	H	60.82	-20.65	Avg	230.50	191.40	
2169.60	45.75	H	80.82	-35.07	Peak	246.00	175.34	
2169.60	27.01	H	60.82	-33.81	Avg	246.00	175.34	
2603.52	47.55	H	80.82	-33.27	Peak	251.50	175.34	
2603.52	28.81	H	60.82	-32.01	Avg	251.50	175.34	
3037.44	42.46	H	80.82	-38.36	Peak	127.00	191.40	
3037.44	23.72	H	60.82	-37.10	Avg	127.00	191.40	
3471.36	44.47	H	80.82	-36.35	Peak	90.75	191.22	
3471.36	25.73	H	60.82	-35.09	Avg	90.75	191.22	
3905.28	50.06	H	73.97	-23.91	Peak	162.25	191.34	
3905.28	31.32	H	53.97	-22.65	Avg	162.25	191.34	
4339.20	41.72	H	73.97	-32.25	Peak	343.25	175.28	
4339.20	22.98	H	53.97	-30.99	Avg	343.25	175.28	



**FCC 15.231**

Ecolink Intelligent Technology, Inc.

Wearable Action Button

Model: WST-130

Date: 12/06/2023

Lab: D

Tested By: Kyle Fujimoto

**Harmonics****Transmit Mode - Y-Axis**

Freq. (MHz)	Level (dBuV/m)	Pol (v/h)	Limit	Margin	Peak / QP / Avg	Table Angle (deg)	Ant. Height (cm)	Comments
867.84	52.74	H	80.82	-28.08	Peak	129.25	151.10	
867.84	34.00	H	60.82	-26.82	Avg	129.25	151.10	
1301.76	38.37	H	73.97	-35.60	Peak	351.25	239.58	
1301.76	19.63	H	53.97	-34.34	Avg	351.25	239.58	
1735.68	46.89	H	80.82	-33.93	Peak	217.25	159.10	
1735.68	28.15	H	60.82	-32.67	Avg	217.25	159.10	
2169.60	40.05	H	80.82	-40.77	Peak	303.00	159.28	
2169.60	21.31	H	60.82	-39.51	Avg	303.00	159.28	
2603.52	42.24	H	80.82	-38.58	Peak	49.00	159.22	
2603.52	23.50	H	60.82	-37.32	Avg	49.00	159.22	
3037.44	41.16	H	80.82	-39.66	Peak	328.00	143.22	
3037.44	22.42	H	60.82	-38.40	Avg	328.00	143.22	
3471.36	40.00	H	80.82	-40.82	Peak	327.00	126.92	
3471.36	21.26	H	60.82	-39.56	Avg	327.00	126.92	
3905.28	47.45	H	73.97	-26.52	Peak	327.25	127.46	
3905.28	28.71	H	53.97	-25.26	Avg	327.25	127.46	
4339.20	41.22	H	73.97	-32.75	Peak	308.50	111.46	
4339.20	22.48	H	53.97	-31.49	Avg	308.50	111.46	

**FCC 15.231**

Ecolink Intelligent Technology, Inc.

Wearable Action Button

Model: WST-130

Date: 12/06/2023

Lab: D

Tested By: Kyle Fujimoto

**Harmonics****Transmit Mode - Z-Axis**

Freq. (MHz)	Level (dBuV/m)	Pol (v/h)	Limit	Margin	Peak / QP / Avg	Table Angle (deg)	Ant. Height (cm)	Comments
867.84	50.36	H	80.82	-30.46	Peak	10.00	135.70	
867.84	31.62	H	60.82	-29.20	Avg	10.00	135.70	
1301.76	30.23	H	73.97	-43.74	Peak	120.50	158.34	
1301.76	11.49	H	53.97	-42.48	Avg	120.50	158.34	
1735.68	64.29	H	80.82	-16.53	Peak	315.50	111.40	
1735.68	45.55	H	60.82	-15.27	Avg	315.50	111.40	
2169.60	41.60	H	80.82	-39.22	Peak	157.25	249.97	
2169.60	22.86	H	60.82	-37.96	Avg	157.25	249.97	
2603.52	42.02	H	80.82	-38.80	Peak	309.00	191.34	
2603.52	23.28	H	60.82	-37.54	Avg	309.00	191.34	
3037.44	45.49	H	80.82	-35.33	Peak	167.50	175.28	
3037.44	26.75	H	60.82	-34.07	Avg	167.50	175.28	
3471.36	49.13	H	80.82	-31.69	Peak	144.75	127.36	
3471.36	30.39	H	60.82	-30.43	Avg	144.75	127.36	
3905.28	52.42	H	73.97	-21.55	Peak	147.75	111.34	
3905.28	33.68	H	53.97	-20.29	Avg	147.75	111.34	
4339.20	41.51	H	73.97	-32.46	Peak	359.50	159.40	
4339.20	22.77	H	53.97	-31.20	Avg	359.50	159.40	





***-20 dB BANDWIDTH PLOT***

***DATA SHEET***

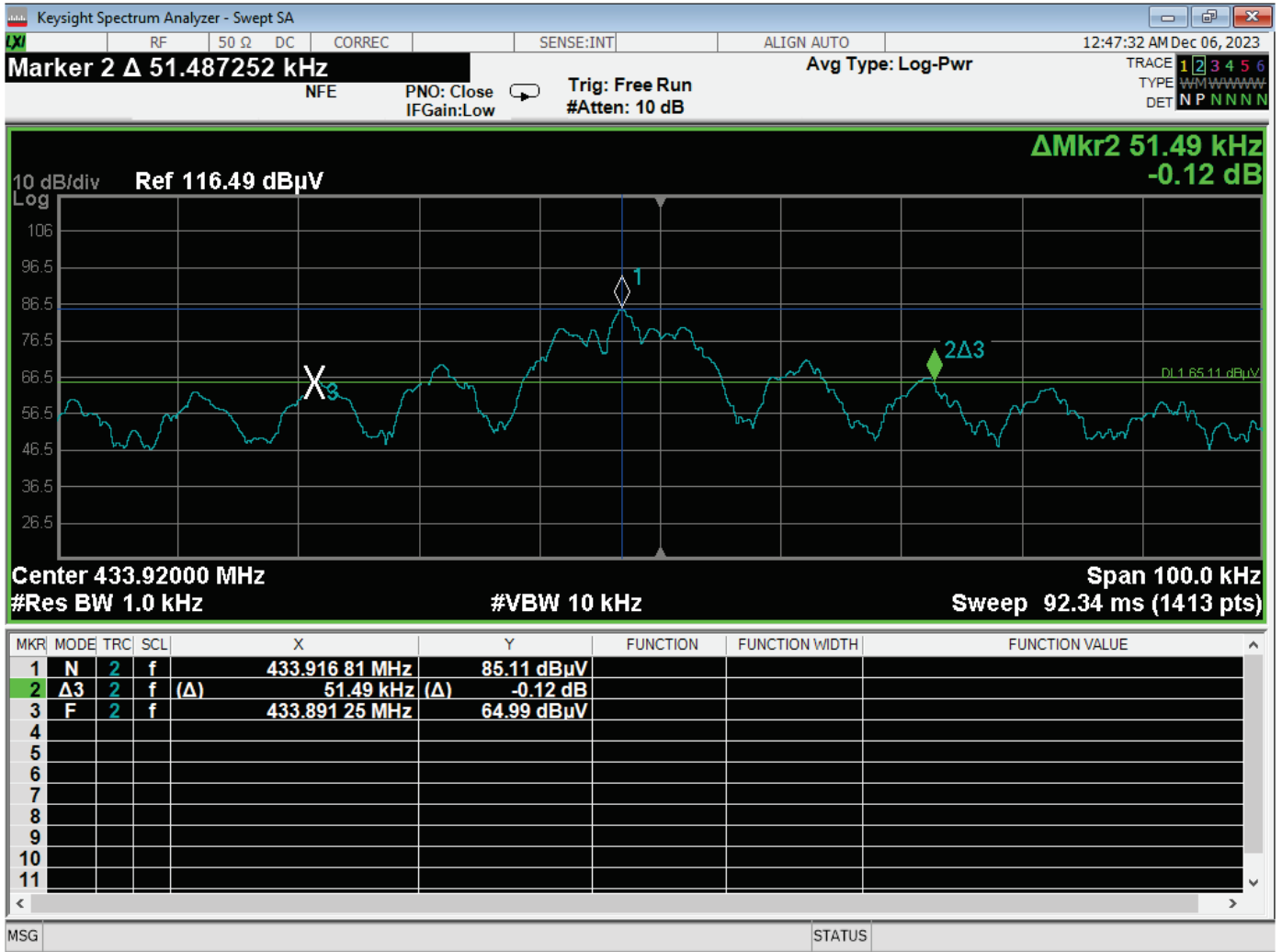

-20 dB Bandwidth Plot

***TRANSMISSION TIME  
DATA SHEET***

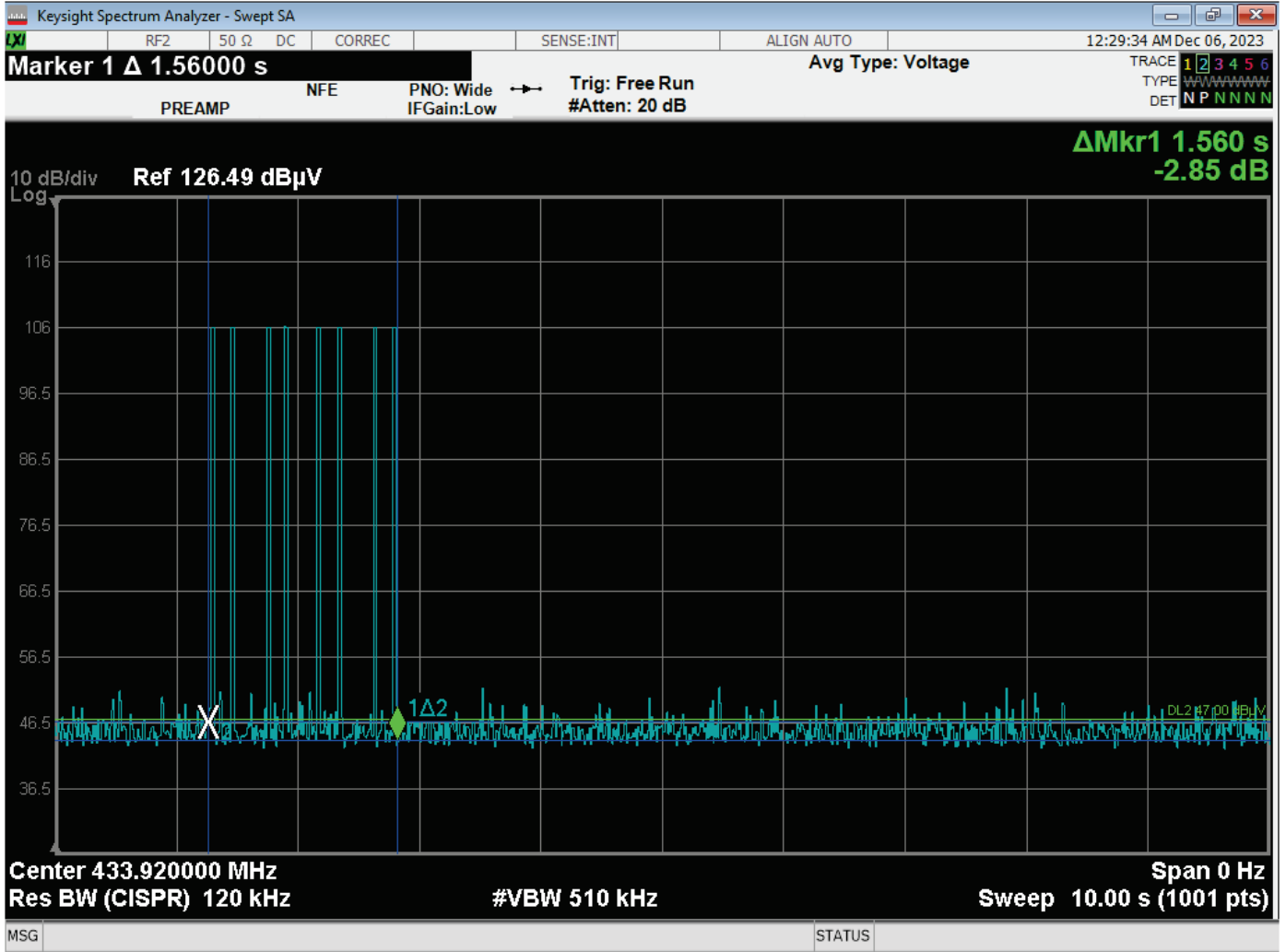

Plot Showing Actual Time of Transmission 1.56 seconds

Brea Division  
114 Olinda Drive  
Brea, CA 92823  
(714) 579-0500

Newbury Park Division  
1050 Lawrence Drive  
Newbury Park, CA 91320  
(805) 480-4044

Lake Forest Division  
20621 Pascal Way  
Lake Forest, CA 92630  
(949) 587-0400

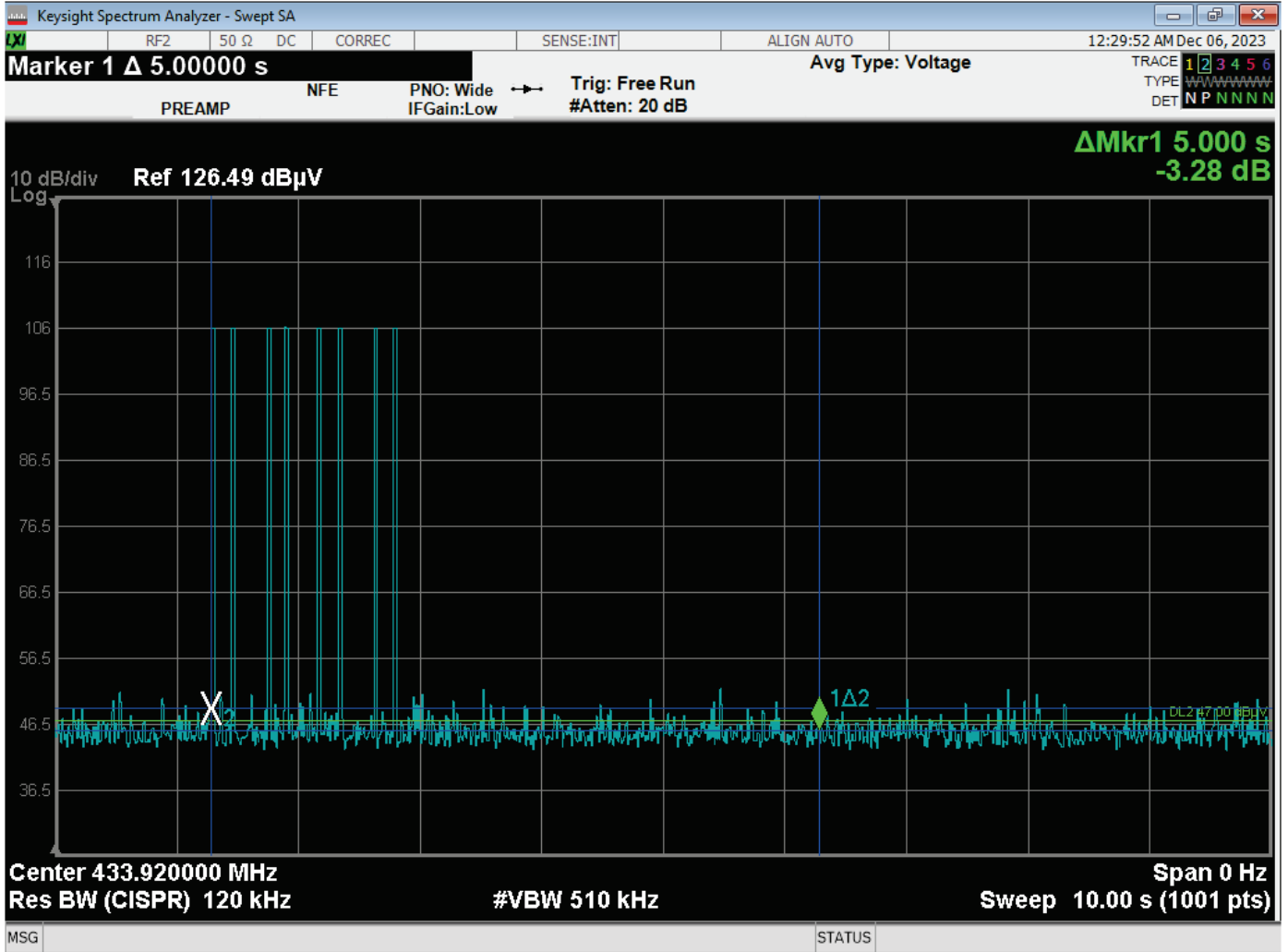

Plot Showing Time of Transmission is less than 5 seconds

Brea Division  
114 Olinda Drive  
Brea, CA 92823  
(714) 579-0500

Newbury Park Division  
1050 Lawrence Drive  
Newbury Park, CA 91320  
(805) 480-4044

Lake Forest Division  
20621 Pascal Way  
Lake Forest, CA 92630  
(949) 587-0400



**99 % BANDWIDTH  
DATA SHEET**

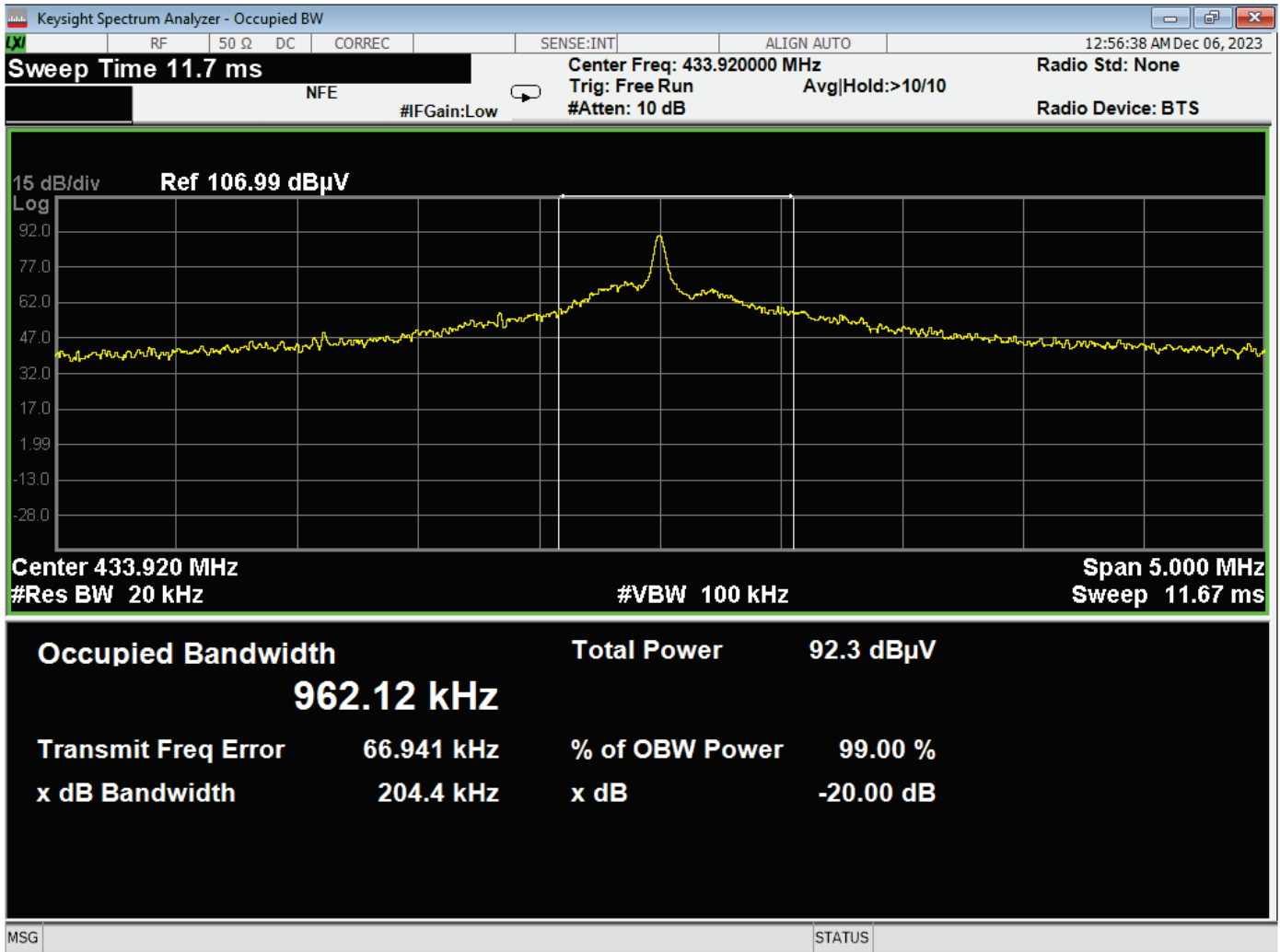

99 % Bandwidth Plot

***DUTY CYCLE***

***DATA SHEETS***

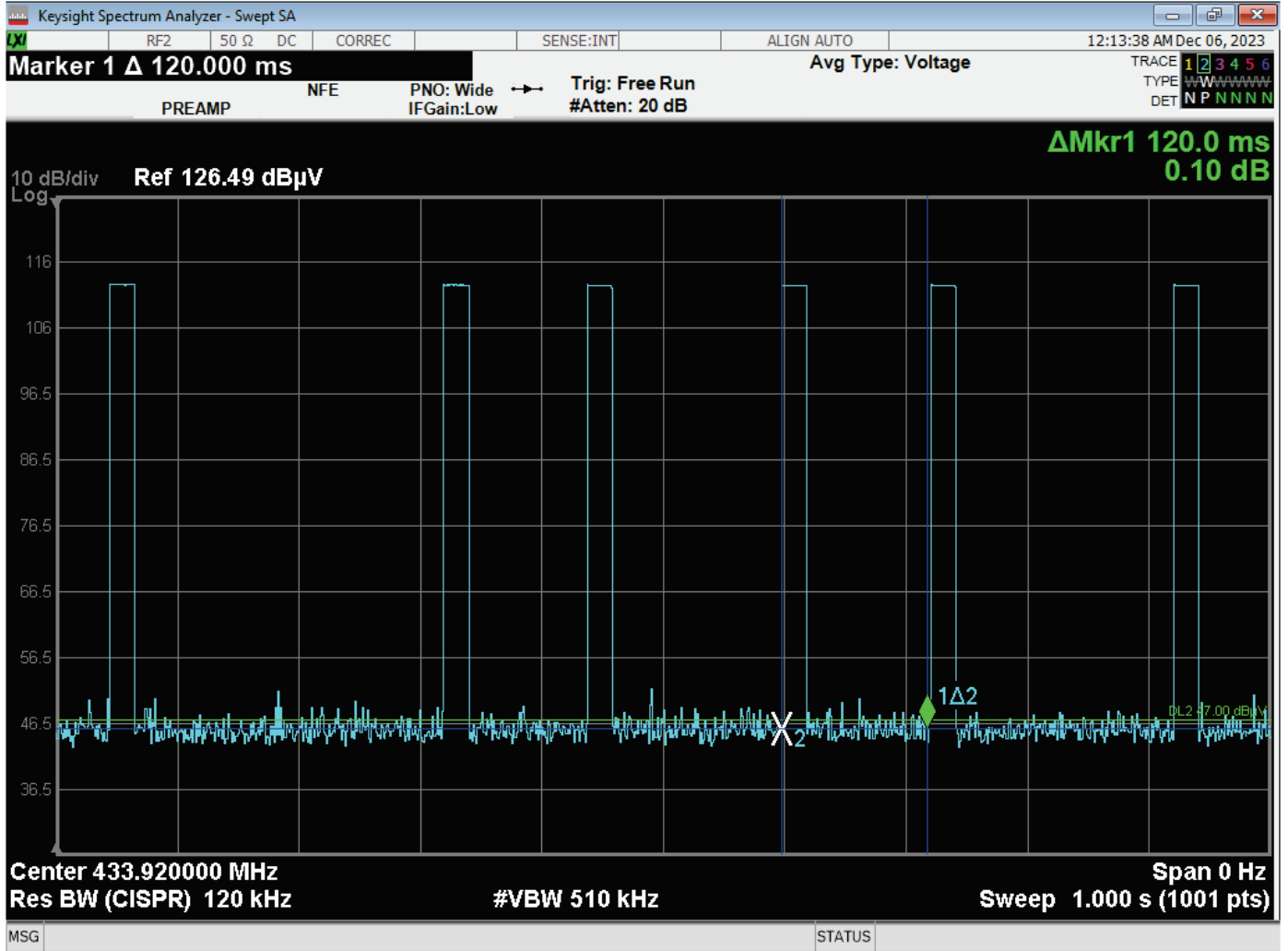

The worst case where the pulse train repeats itself will always be at least 100 ms

Brea Division  
114 Olinda Drive  
Brea, CA 92823  
(714) 579-0500

Newbury Park Division  
1050 Lawrence Drive  
Newbury Park, CA 91320  
(805) 480-4044

Lake Forest Division  
20621 Pascal Way  
Lake Forest, CA 92630  
(949) 587-0400



Number of Pulses

Brea Division  
114 Olinda Drive  
Brea, CA 92823  
(714) 579-0500

Newbury Park Division  
1050 Lawrence Drive  
Newbury Park, CA 91320  
(805) 480-4044

Lake Forest Division  
20621 Pascal Way  
Lake Forest, CA 92630  
(949) 587-0400

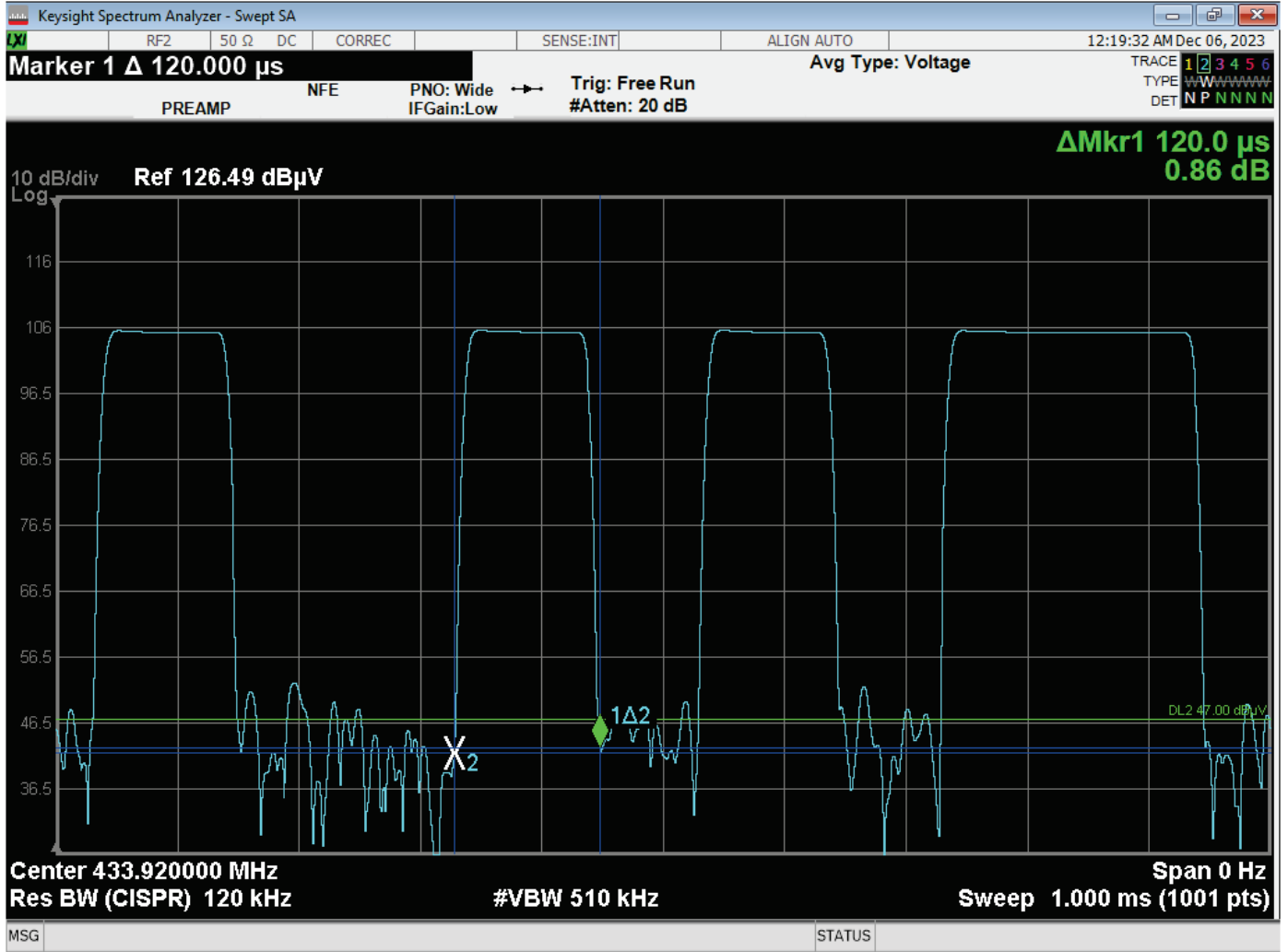

Time of Small Pulse = 120 us

**Brea Division**  
 114 Olinda Drive  
 Brea, CA 92823  
 (714) 579-0500

**Newbury Park Division**  
 1050 Lawrence Drive  
 Newbury Park, CA 91320  
 (805) 480-4044

**Lake Forest Division**  
 20621 Pascal Way  
 Lake Forest, CA 92630  
 (949) 587-0400

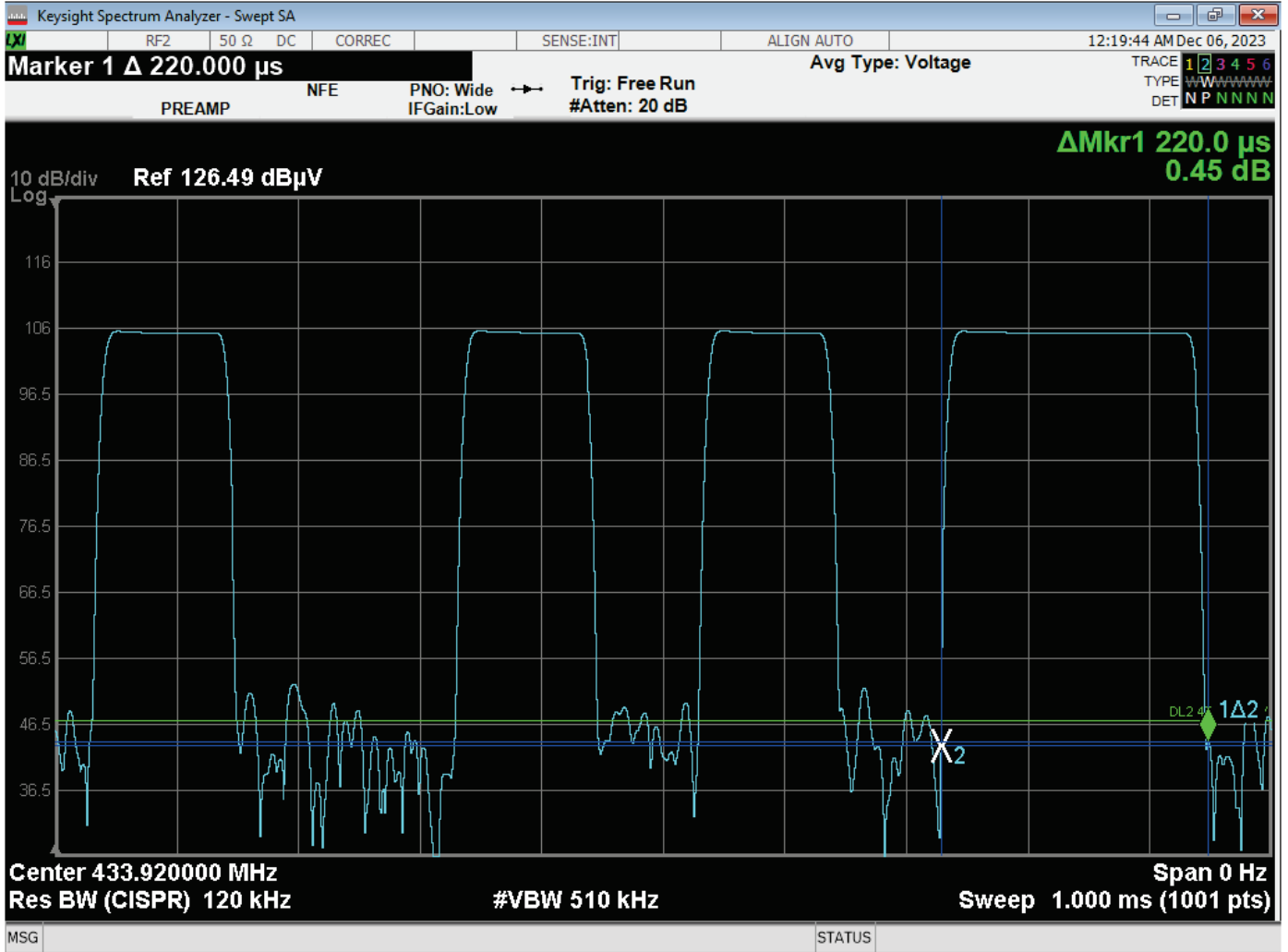

Time of One Large Pulse = 220 us

Brea Division  
114 Olinda Drive  
Brea, CA 92823  
(714) 579-0500

Newbury Park Division  
1050 Lawrence Drive  
Newbury Park, CA 91320  
(805) 480-4044

Lake Forest Division  
20621 Pascal Way  
Lake Forest, CA 92630  
(949) 587-0400



Number of Small Pulses = 56 = (56\*120 us) = 6720 us  
 Number of Large Pulses = 22 = (22\*220 us) = 4840 us

Total On Time = 11560 us = 11.560 ms

Duty Cycle = 11.560 ms / 100 ms = 11.56%

The peak to average ratio is -18.74 dB

Brea Division  
 114 Olinda Drive  
 Brea, CA 92823  
 (714) 579-0500

Newbury Park Division  
 1050 Lawrence Drive  
 Newbury Park, CA 91320  
 (805) 480-4044

Lake Forest Division  
 20621 Pascal Way  
 Lake Forest, CA 92630  
 (949) 587-0400