

### 5.7.4 MEASUREMENT PLOT (EXAMPLE PLOT, SHOWING WORST CASE, IF APPLICABLE)

LTE eFDD 5 16QAM, Channel = mid



Date: 26.AUG.2021 19:44:30

LTE eFDD 26 16QAM, Channel = mid

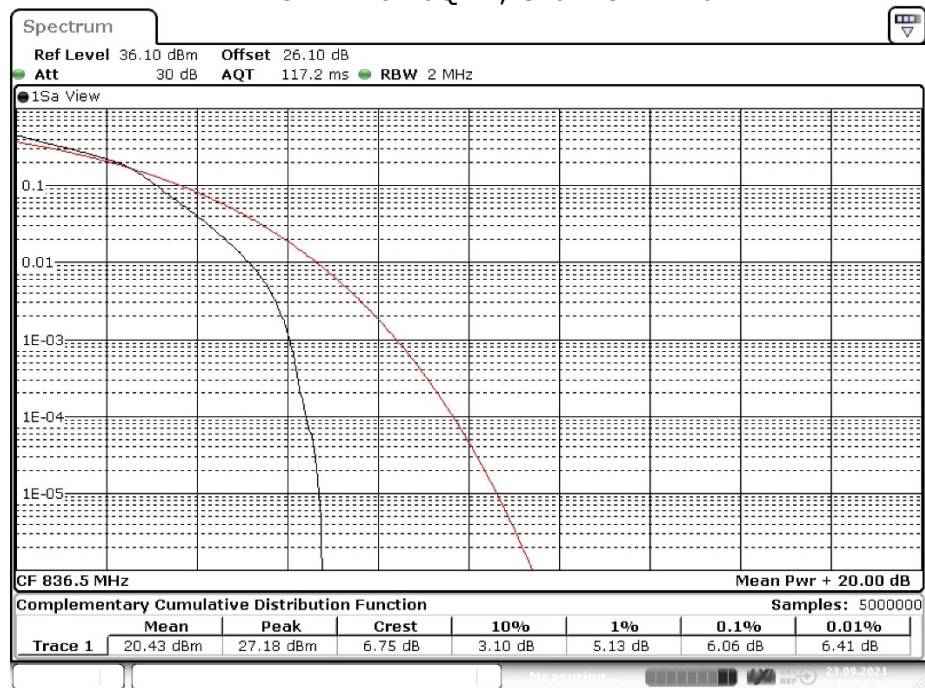

Date: 23.SEP.2021 09:07:13

### 5.7.5 TEST EQUIPMENT USED

- Radio Lab

## 5.8 RF OUTPUT POWER

Standard **FCC PART 24 Subpart E**

**The test was performed according to:**  
ANSI C63.26: 2015

### 5.8.1 TEST DESCRIPTION

This test case is intended to demonstrate compliance to the applicable RF Output power test case per § 2.1046 and RSS-GEN 6.12. The limit and the requirements come from the applicable rule part and ISED RSS-Standard for the operating band of the cellular device.

The EUT was connected to the test setup according to the following diagram:

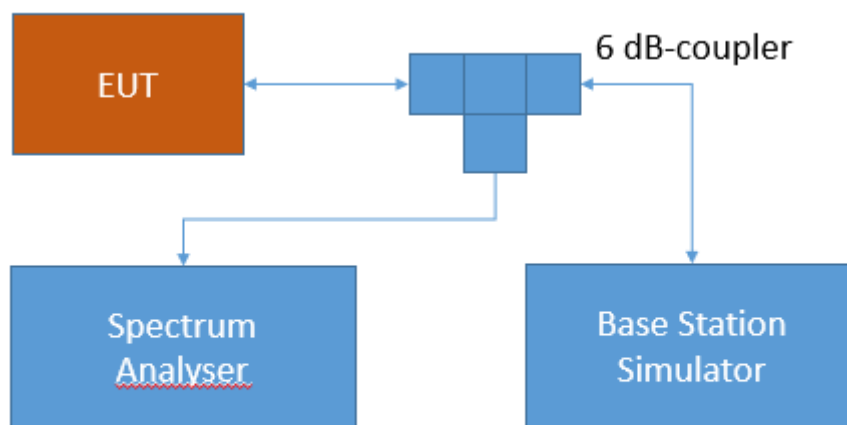

Test Setup FCC Part 22/24/27/90 Cellular;  
RF Output power

The attenuation of the measuring and stimulus path are known for each measured frequency and are considered.

The Spectrum Analyser settings can be directly found in the measurement diagrams.

### 5.8.2 TEST REQUIREMENTS / LIMITS

#### **FCC Part 24, § 24.232**

(c) Mobile and portable stations are limited to 2 watts EIRP and the equipment must employ a means for limiting power to the minimum necessary for successful communications.

### RSS-133; 6.4 Transmitter Output Power and Equivalent Isotropically Radiated Power

The equivalent isotropically radiated power (e.i.r.p.) for transmitters shall not exceed the limits given in SRSP-510.

### SRSP-510; 5.1.2 Radiated Power and Antenna Height Limits – Mobile Stations

Mobile stations and hand-held portables are limited to 2 watts maximum e.i.r.p. The equipment shall employ means to limit the power to the minimum necessary for successful communication.

### 5.8.3 TEST PROTOCOL

Ambient temperature: 20 - 28 °C  
Relative humidity: 30 - 45 %

Radio Technology	Channel	Re-source Blocks	Band-width [MHz]	Peak Cond. Power [dBm]	Average Cond. Power [dBm]	RMS Cond. Power [dBm]	FCC EIRP Limit [W]	IC EIRP Limit [W]	Max Antenna Gain FCC [dBi]	Max Antenna Gain IC [dBi]
GSM 1900	low	-	0.2	29.10	28.42	28.55	2	2	3.90	3.90
GSM 1900	mid	-	0.2	28.93	28.28	28.42	2	2	4.07	4.07
GSM 1900	high	-	0.2	28.89	28.22	28.36	2	2	4.11	4.11
GSM 1900 EDGE	low	-	0.2	28.02	24.71	25.20	2	2	4.98	4.98
GSM 1900 EDGE	mid	-	0.2	28.07	24.95	25.28	2	2	4.93	4.93
GSM 1900 EDGE	high	-	0.2	28.02	24.64	25.14	2	2	4.98	4.98
FDD II	low	-	5	28.52	22.95	23.08	2	2	9.92	9.92
FDD II	mid	-	5	28.12	22.80	23.01	2	2	9.99	9.99
FDD II	high	-	5	28.12	22.91	23.04	2	2	9.96	9.96
FDD II HSDPA Subtest 1	low	-	5	27.62	22.39	22.59	2	2	10.41	10.41
FDD II HSDPA Subtest 1	mid	-	5	27.49	21.98	22.48	2	2	10.52	10.52
FDD II HSDPA Subtest 1	high	-	5	27.62	22.00	22.36	2	2	10.64	10.64
FDD II HSDPA Subtest 2	low	-	5	28.64	22.61	22.37	2	2	10.63	10.63
FDD II HSDPA Subtest 2	mid	-	5	28.39	21.74	22.26	2	2	10.74	10.74
FDD II HSDPA Subtest 2	high	-	5	28.27	21.67	22.18	2	2	10.82	10.82
FDD II HSDPA Subtest 3	low	-	5	28.89	21.82	22.59	2	2	10.41	10.41
FDD II HSDPA Subtest 3	mid	-	5	28.52	21.58	22.75	2	2	10.25	10.25
FDD II HSDPA Subtest 3	high	-	5	28.12	21.82	22.59	2	2	10.41	10.41
FDD II HSDPA Subtest 4	low	-	5	28.64	22.03	22.83	2	2	10.17	10.17
FDD II HSDPA Subtest 4	mid	-	5	28.39	21.81	22.64	2	2	10.36	10.36
FDD II HSDPA Subtest 4	high	-	5	27.99	21.69	22.49	2	2	10.51	10.51
FDD II HSUPA Subtest 1	low	-	5	27.99	21.45	21.59	2	2	11.41	11.41
FDD II HSUPA Subtest 1	mid	-	5	27.75	20.86	22.00	2	2	11.00	11.00
FDD II HSUPA Subtest 1	high	-	5	27.62	21.53	21.47	2	2	11.53	11.53
FDD II HSUPA Subtest 2	low	-	5	28.39	21.43	22.05	2	2	10.95	10.95
FDD II HSUPA Subtest 2	mid	-	5	27.99	21.16	21.85	2	2	11.15	11.15
FDD II HSUPA Subtest 2	high	-	5	27.87	21.17	21.79	2	2	11.21	11.21
FDD II HSUPA Subtest 3	low	-	5	28.12	21.36	21.87	2	2	11.13	11.13
FDD II HSUPA Subtest 3	mid	-	5	27.75	22.02	21.71	2	2	11.29	11.29

FDD II HSUPA Subtest 3	high	-	5	27.75	21.20	21.71	2	2	11.29	11.29
FDD II HSUPA Subtest 4	low	-	5	28.39	19.31	20.00	2	2	13.00	13.00
FDD II HSUPA Subtest 4	mid	-	5	28.64	19.84	20.44	2	2	12.56	12.56
FDD II HSUPA Subtest 4	high	-	5	27.62	19.27	19.82	2	2	13.18	13.18
FDD II HSUPA Subtest 5	low	-	5	28.12	22.20	22.67	2	2	10.33	10.33
FDD II HSUPA Subtest 5	mid	-	5	27.99	22.03	22.41	2	2	10.59	10.59
FDD II HSUPA Subtest 5	high	-	5	27.87	21.43	22.12	2	2	10.88	10.88
LTE eFDD 2 QPSK	low	1	1.4	-	-	22.51	2	2	10.49	10.49
LTE eFDD 2 QPSK	low	3	1.4	-	-	22.10	2	2	10.90	10.90
LTE eFDD 2 QPSK	low	6	1.4	-	-	21.20	2	2	11.80	11.80
LTE eFDD 2 QPSK	mid	1	1.4	-	-	22.79	2	2	10.21	10.21
LTE eFDD 2 QPSK	mid	3	1.4	-	-	22.31	2	2	10.69	10.69
LTE eFDD 2 QPSK	mid	6	1.4	-	-	21.44	2	2	11.56	11.56
LTE eFDD 2 QPSK	high	1	1.4	-	-	22.61	2	2	10.39	10.39
LTE eFDD 2 QPSK	high	3	1.4	-	-	22.34	2	2	10.66	10.66
LTE eFDD 2 QPSK	high	6	1.4	-	-	21.12	2	2	11.88	11.88
LTE eFDD 2 16QAM	low	1	1.4	-	-	21.90	2	2	11.10	11.10
LTE eFDD 2 16QAM	low	6	1.4	-	-	20.25	2	2	12.75	12.75
LTE eFDD 2 16QAM	mid	1	1.4	-	-	21.31	2	2	11.69	11.69
LTE eFDD 2 16QAM	mid	6	1.4	-	-	20.27	2	2	12.73	12.73
LTE eFDD 2 16QAM	high	1	1.4	-	-	21.97	2	2	11.03	11.03
LTE eFDD 2 16QAM	high	6	1.4	-	-	19.90	2	2	13.10	13.10
LTE eFDD 2 QPSK	low	1	3	-	-	22.87	2	2	10.13	10.13
LTE eFDD 2 QPSK	low	15	3	-	-	21.63	2	2	11.37	11.37
LTE eFDD 2 QPSK	mid	1	3	-	-	23.13	2	2	9.87	9.87
LTE eFDD 2 QPSK	mid	15	3	-	-	21.95	2	2	11.05	11.05
LTE eFDD 2 QPSK	high	1	3	-	-	22.85	2	2	10.15	10.15
LTE eFDD 2 QPSK	high	15	3	-	-	21.71	2	2	11.29	11.29
LTE eFDD 2 16QAM	low	1	3	-	-	21.79	2	2	11.21	11.21
LTE eFDD 2 16QAM	low	15	3	-	-	20.63	2	2	12.37	12.37
LTE eFDD 2 16QAM	mid	1	3	-	-	21.97	2	2	11.03	11.03
LTE eFDD 2 16QAM	mid	15	3	-	-	20.88	2	2	12.12	12.12
LTE eFDD 2 16QAM	high	1	3	-	-	22.32	2	2	10.68	10.68
LTE eFDD 2 16QAM	high	15	3	-	-	20.70	2	2	12.30	12.30
LTE eFDD 2 QPSK	low	1	5	-	-	22.85	2	2	10.15	10.15
LTE eFDD 2 QPSK	low	12	5	-	-	21.66	2	2	11.34	11.34
LTE eFDD 2 QPSK	low	25	5	-	-	21.72	2	2	11.28	11.28
LTE eFDD 2 QPSK	mid	1	5	-	-	22.99	2	2	10.01	10.01
LTE eFDD 2 QPSK	mid	12	5	-	-	21.93	2	2	11.07	11.07
LTE eFDD 2 QPSK	mid	25	5	-	-	21.91	2	2	11.09	11.09
LTE eFDD 2 QPSK	high	1	5	-	-	22.75	2	2	10.25	10.25
LTE eFDD 2 QPSK	high	12	5	-	-	21.70	2	2	11.30	11.30
LTE eFDD 2 QPSK	high	25	5	-	-	21.69	2	2	11.31	11.31
LTE eFDD 2 16QAM	low	1	5	-	-	21.78	2	2	11.22	11.22
LTE eFDD 2 16QAM	low	25	5	-	-	20.74	2	2	12.26	12.26
LTE eFDD 2 16QAM	mid	1	5	-	-	21.99	2	2	11.01	11.01
LTE eFDD 2 16QAM	mid	25	5	-	-	20.73	2	2	12.27	12.27

LTE eFDD 2 16QAM	high	1	5	-	-	22.42	2	2	10.58	10.58
LTE eFDD 2 16QAM	high	25	5	-	-	20.62	2	2	12.38	12.38
LTE eFDD 2 QPSK	low	1	10	-	-	23.11	2	2	9.89	9.89
LTE eFDD 2 QPSK	low	50	10	-	-	21.94	2	2	11.06	11.06
LTE eFDD 2 QPSK	mid	1	10	-	-	23.12	2	2	9.88	9.88
LTE eFDD 2 QPSK	mid	50	10	-	-	22.09	2	2	10.91	10.91
LTE eFDD 2 QPSK	high	1	10	-	-	23.11	2	2	9.89	9.89
LTE eFDD 2 QPSK	high	50	10	-	-	21.92	2	2	11.08	11.08
LTE eFDD 2 16QAM	low	1	10	-	-	22.07	2	2	10.93	10.93
LTE eFDD 2 16QAM	low	12	10	-	-	20.33	2	2	12.67	12.67
LTE eFDD 2 16QAM	mid	1	10	-	-	22.69	2	2	10.31	10.31
LTE eFDD 2 16QAM	mid	12	10	-	-	21.82	2	2	11.18	11.18
LTE eFDD 2 16QAM	high	1	10	-	-	21.93	2	2	11.07	11.07
LTE eFDD 2 16QAM	high	12	10	-	-	21.49	2	2	11.51	11.51
LTE eFDD 2 QPSK	low	1	15	-	-	23.00	2	2	10.00	10.00
LTE eFDD 2 QPSK	low	36	15	-	-	22.11	2	2	10.89	10.89
LTE eFDD 2 QPSK	low	75	15	-	-	22.06	2	2	10.94	10.94
LTE eFDD 2 QPSK	mid	1	15	-	-	23.36	2	2	9.64	9.64
LTE eFDD 2 QPSK	mid	36	15	-	-	22.14	2	2	10.86	10.86
LTE eFDD 2 QPSK	mid	75	15	-	-	21.97	2	2	11.03	11.03
LTE eFDD 2 QPSK	high	1	15	-	-	23.04	2	2	9.96	9.96
LTE eFDD 2 QPSK	high	36	15	-	-	21.95	2	2	11.05	11.05
LTE eFDD 2 QPSK	high	75	15	-	-	21.83	2	2	11.17	11.17
LTE eFDD 2 16QAM	low	1	15	-	-	22.05	2	2	10.95	10.95
LTE eFDD 2 16QAM	low	18	15	-	-	20.70	2	2	12.30	12.30
LTE eFDD 2 16QAM	mid	1	15	-	-	21.73	2	2	11.27	11.27
LTE eFDD 2 16QAM	mid	18	15	-	-	21.04	2	2	11.96	11.96
LTE eFDD 2 16QAM	high	1	15	-	-	22.03	2	2	10.97	10.97
LTE eFDD 2 16QAM	high	18	15	-	-	20.98	2	2	12.02	12.02
LTE eFDD 2 QPSK	low	1	20	-	-	23.14	2	2	9.86	9.86
LTE eFDD 2 QPSK	low	100	20	-	-	22.09	2	2	10.91	10.91
LTE eFDD 2 QPSK	mid	1	20	-	-	23.47	2	2	9.53	9.53
LTE eFDD 2 QPSK	mid	100	20	-	-	21.96	2	2	11.04	11.04
LTE eFDD 2 QPSK	high	1	20	-	-	23.25	2	2	9.75	9.75
LTE eFDD 2 QPSK	high	100	20	-	-	21.92	2	2	11.08	11.08
LTE eFDD 2 16QAM	low	1	20	-	-	22.71	2	2	10.29	10.29
LTE eFDD 2 16QAM	low	18	20	-	-	21.91	2	2	11.09	11.09
LTE eFDD 2 16QAM	mid	1	20	-	-	22.34	2	2	10.66	10.66
LTE eFDD 2 16QAM	mid	18	20	-	-	21.82	2	2	11.18	11.18
LTE eFDD 2 16QAM	high	1	20	-	-	21.64	2	2	11.36	11.36
LTE eFDD 2 16QAM	high	18	20	-	-	21.80	2	2	11.20	11.20

Remark: Please see next sub-clause for the measurement plot.

### 5.8.4 MEASUREMENT PLOT (EXAMPLE PLOT, SHOWING WORST CASE, IF APPLICABLE)

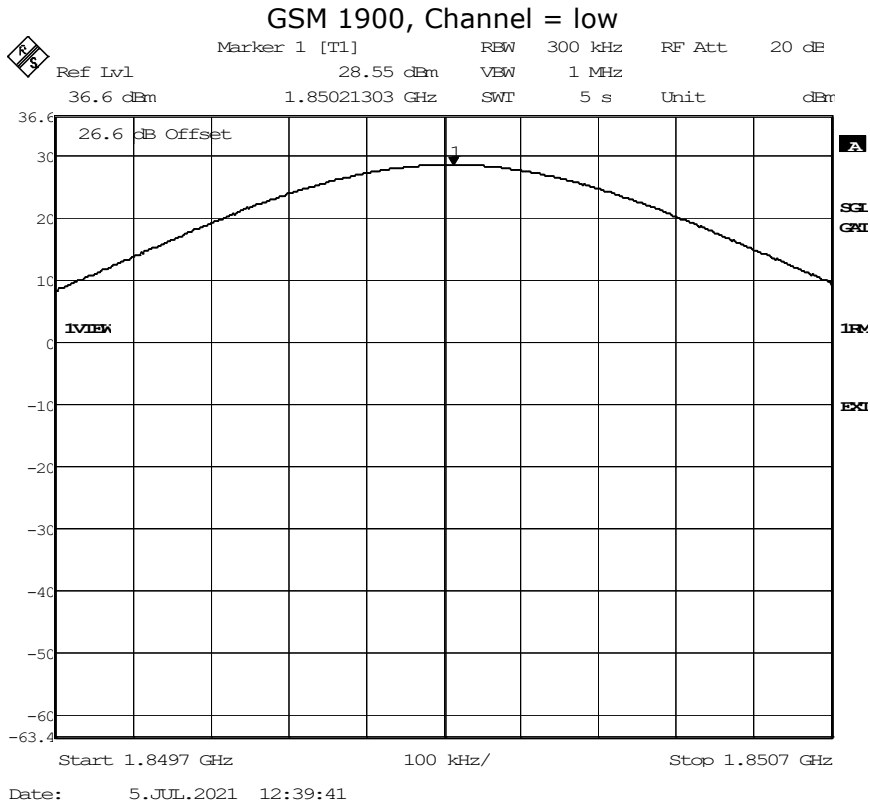

### EDGE 1900, Channel = mid

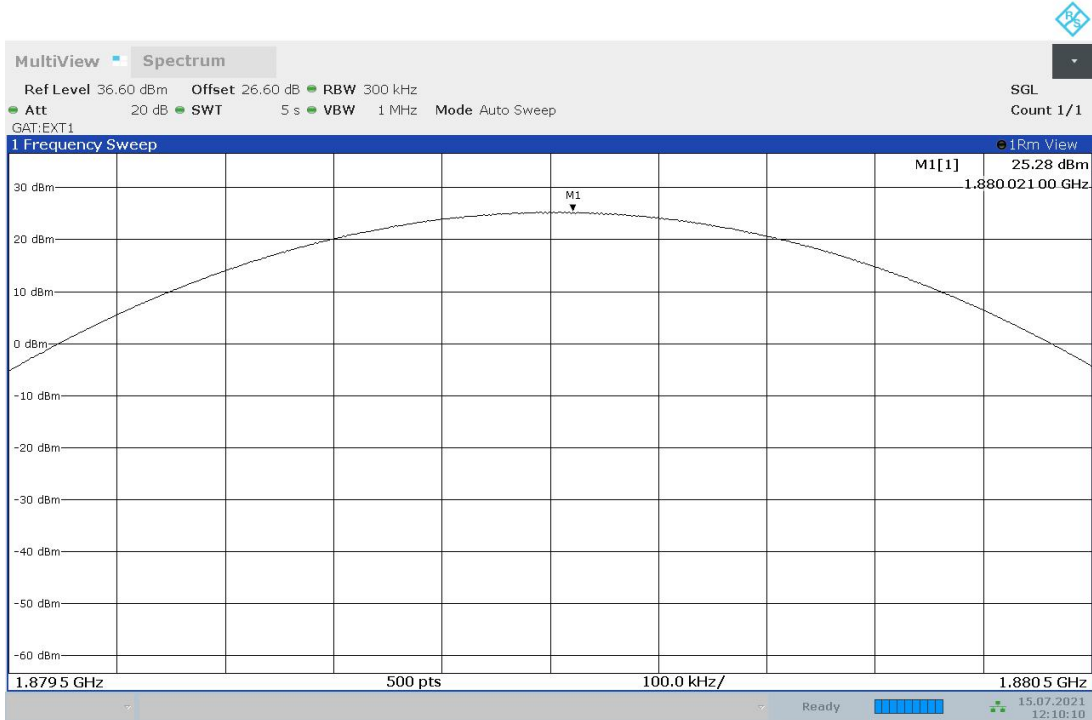

### WCDMA FDD 2, Channel = low

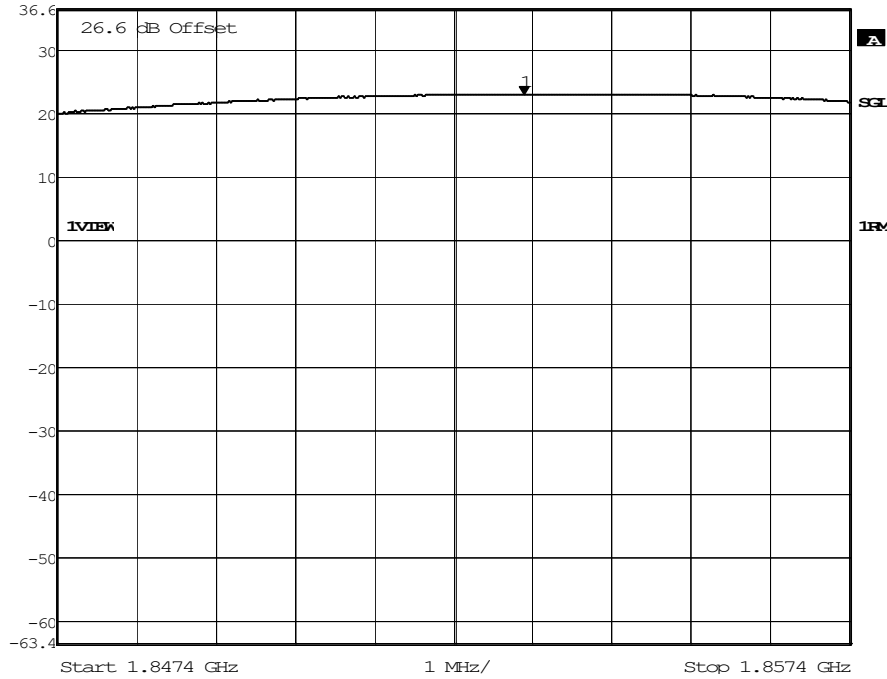

 Marker 1 [T1]      REW    10 MHz    RF Att    20 dB  
 Ref Lvl                    23.08 dBm    VEW    10 MHz  
 36.6 dBm                    1.85329178 GHz    SWP    5 ms    Unit    dBm



Date: 15.SEP.2021 15:56:38

### HSDPA FDD 2 Subtest 4, Channel = low

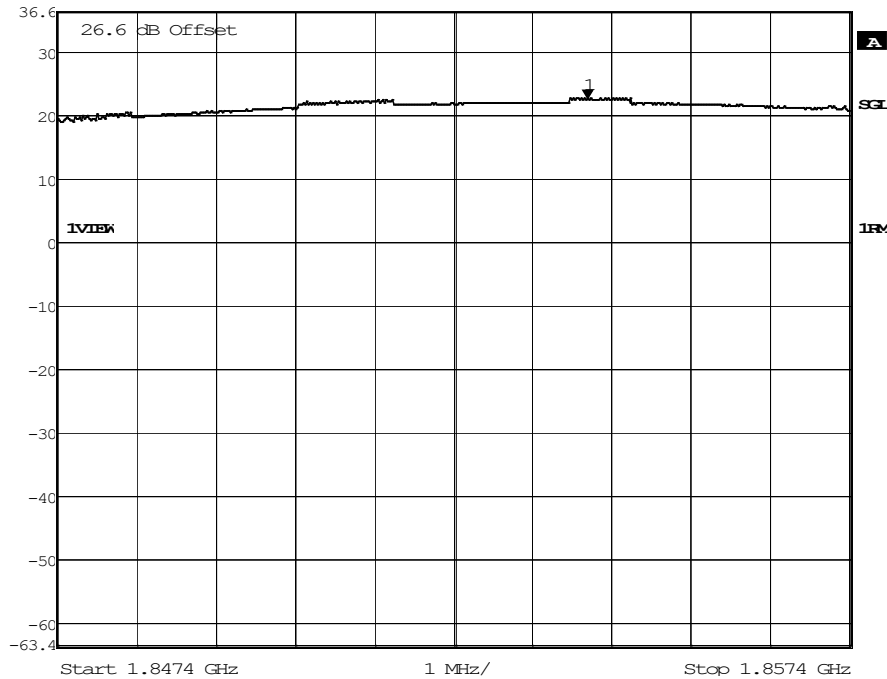
 Marker 1 [T1]      REW    10 MHz    RF Att    20 dB  
 Ref Lvl                    22.83 dBm    VEW    10 MHz  
 36.6 dBm                    1.85409339 GHz    SWP    5 ms    Unit    dBm



Date: 28.AUG.2021 16:21:44

### HSUPA FDD 2 Subtest 5, Channel = low

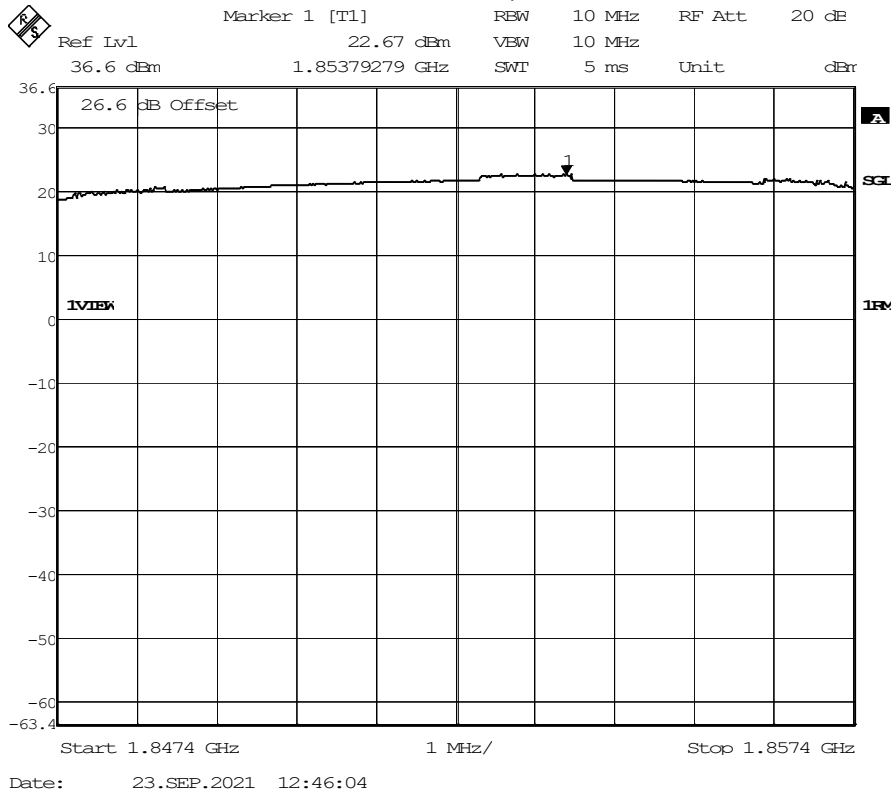

### LTE eFDD 2 QPSK 3 MHz RBs = 1, Channel = mid

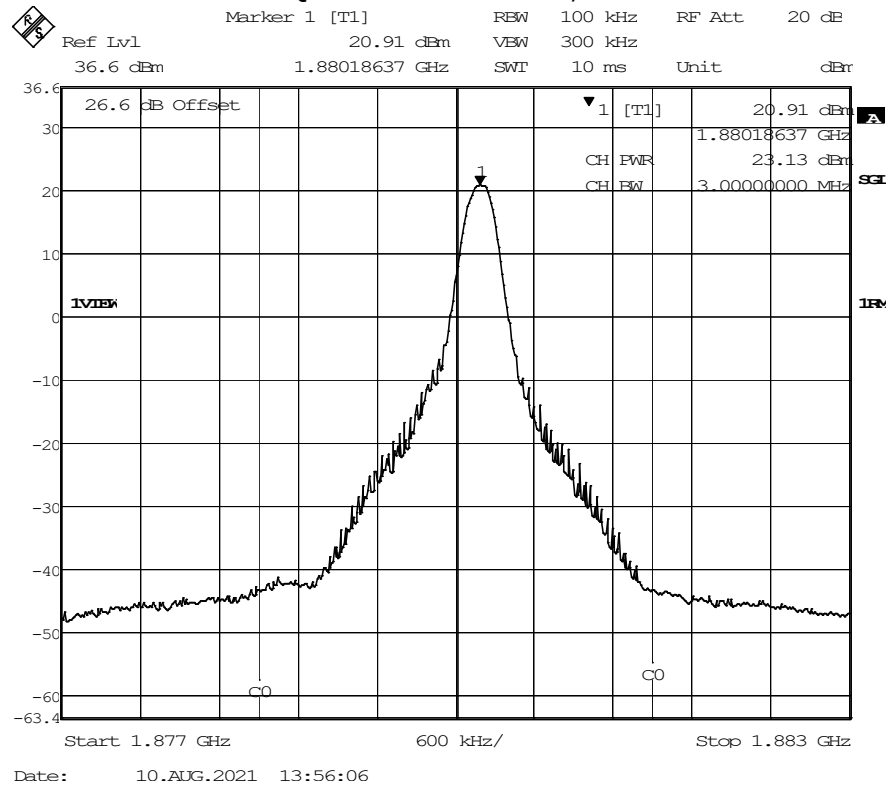

## 5.8.5 TEST EQUIPMENT USED

- Radio Lab



## 5.9 FREQUENCY STABILITY

Standard **FCC PART 24 Subpart E**

**The test was performed according to:**  
ANSI C63.26: 2015

### 5.9.1 TEST DESCRIPTION

This test case is intended to demonstrate compliance to the applicable frequency stability test case per § 2.1055 and RSS-GEN 6.11. The limit and the requirements come from the applicable rule part and ISED RSS-Standard for the operating band of the cellular device.

The EUT was connected to the test setup according to the following diagram:



Test Setup FCC Part 22/24/27/90 Cellular;  
Frequency stability

The attenuation of the measuring / stimulus path is known for each measured frequency and are considered.

### 5.9.2 TEST REQUIREMENTS / LIMITS

#### **FCC Part 24, § 24.235**

The frequency stability shall be sufficient to ensure that the fundamental emission stays within the authorized frequency block.

#### **RSS-133; 6.3 Frequency Stability**

The carrier frequency shall not depart from the reference frequency, in excess of  $\pm 2.5$  ppm for mobile stations.

In lieu of meeting the above stability values, the test report may show that the frequency stability is sufficient to ensure that the emission bandwidth stays within the operating frequency block when tested to the temperature and supply voltage variations specified in RSS-Gen.

### 5.9.3 TEST PROTOCOL

#### GSM 1900

Temp. °C	Duration min	Voltage	Limit Hz	Freq. error Average (Hz)	Freq. error Max. (Hz)	Verdict
-30	0	normal	4700	7	46	passed
-30	5			4	51	passed
-30	10			4	20	passed
-20	0	normal	4700	11	53	passed
-20	5			6	32	passed
-20	10			16	61	passed
-10	0	normal	4700	11	46	passed
-10	5			8	24	passed
-10	10			8	22	passed
0	0	normal	4700	13	36	passed
0	5			14	30	passed
0	10			10	53	passed
10	0	normal	4700	17	54	passed
10	5			19	35	passed
10	10			5	69	passed
20	0	low	4700	13	23	passed
20	5			17	31	passed
20	10			15	41	passed
20	0	normal	4700	18	27	passed
20	5			18	48	passed
20	10			14	40	passed
20	0	high	4700	13	61	passed
20	5			14	58	passed
20	10			9	65	passed
30	0	normal	4700	11	40	passed
30	5			10	29	passed
30	10			15	40	passed
40	0	normal	4700	9	77	passed
40	5			18	39	passed
40	10			15	28	passed
50	0	normal	4700	19	52	passed
50	5			16	40	passed
50	10			19	44	passed

EDGE 1900

Temp. °C	Duration min	Voltage	Limit Hz	Freq. error Average (Hz)	Freq. error Max. (Hz)	Verdict
-30	0	normal	4700	21	30	passed
-30	5			15	22	passed
-30	10			8	15	passed
-20	0	normal	4700	11	20	passed
-20	5			7	13	passed
-20	10			13	20	passed
-10	0	normal	4700	12	20	passed
-10	5			12	22	passed
-10	10			9	18	passed
0	0	normal	4700	10	17	passed
0	5			12	19	passed
0	10			8	17	passed
10	0	normal	4700	11	19	passed
10	5			14	22	passed
10	10			9	15	passed
20	0	low	4700	17	25	passed
20	5			21	46	passed
20	10			10	77	passed
20	0	normal	4700	5	81	passed
20	5			9	84	passed
20	10			9	73	passed
20	0	high	4700	23	88	passed
20	5			2	70	passed
20	10			3	80	passed
30	0	normal	4700	23	79	passed
30	5			15	77	passed
30	10			12	73	passed
40	0	normal	4700	23	80	passed
40	5			22	77	passed
40	10			26	94	passed
50	0	normal	4700	4	75	passed
50	5			11	76	passed
50	10			28	78	passed

WCDMA FDD2

Duration min	Voltage	Limit Hz	Freq. error Average (Hz)	Freq. error Max. (Hz)	Verdict
0	normal	4700	-4	-6	passed
5			-3	-6	passed
10			-4	-4	passed
0	normal	4700	-3	-5	passed
5			-3	-4	passed
10			-5	-5	passed
0	normal	4700	-4	-7	passed
5			-3	-5	passed
10			-4	-8	passed
0	normal	4700	-2	-7	passed
5			-4	-6	passed
10			-4	-6	passed
0	normal	4700	-3	-6	passed
5			-3	-7	passed
10			-1	-4	passed
0	low	4700	-3	-7	passed
5			-4	-6	passed
10			-2	-5	passed
0	normal	4700	-2	-6	passed
5			-3	-6	passed
10			-2	-8	passed
0	high	4700	-4	-7	passed
5			-2	-7	passed
10			-2	-9	passed
0	normal	4700	-6	-14	passed
5			-4	-12	passed
10			-3	-11	passed
0	normal	4700	-5	-9	passed
5			-3	-8	passed
10			-3	-9	passed
0	normal	4700	-6	-8	passed
5			-2	-9	passed
10			-3	-5	passed

HSDPA FDD2

Temp. °C	Duration min	Voltage	Limit Hz	Freq. error Average (Hz)	Freq. error Max. (Hz)	Verdict
-30	0	normal	4700	-2	-6	passed
-30	5			-1	-5	passed
-30	10			-1	-5	passed
-20	0	normal	4700	-1	-4	passed
-20	5			-1	-4	passed
-20	10			-2	-7	passed
-10	0	normal	4700	-1	-4	passed
-10	5			-2	-7	passed
-10	10			-4	-8	passed
0	0	normal	4700	-2	-4	passed
0	5			-1	-4	passed
0	10			-1	3	passed
10	0	normal	4700	1	-3	passed
10	5			1	-3	passed
10	10			-2	-5	passed
20	0	low	4700	-2	-4	passed
20	5			-2	-5	passed
20	10			-1	-2	passed
20	0	normal	4700	-2	-6	passed
20	5			-4	-7	passed
20	10			-4	-6	passed
20	0	high	4700	-1	-4	passed
20	5			-2	-4	passed
20	10			0	-3	passed
30	0	normal	4700	-1	-3	passed
30	5			-1	-3	passed
30	10			-2	-5	passed
40	0	normal	4700	-2	-4	passed
40	5			-3	-7	passed
40	10			-2	-5	passed
50	0	normal	4700	-1	-6	passed
50	5			-1	-5	passed
50	10			0	4	passed

HSUPA FDD2

Temp. °C	Duration min	Voltage	Limit Hz	Freq. error Average (Hz)	Freq. error Max. (Hz)	Verdict
-30	0	normal	4700	1	3	passed
-30	5			1	3	passed
-30	10			1	3	passed
-20	0	normal	4700	2	3	passed
-20	5			0	1	passed
-20	10			0	3	passed
-10	0	normal	4700	1	4	passed
-10	5			0	-1	passed
-10	10			1	-2	passed
0	0	normal	4700	-1	-3	passed
0	5			-1	-1	passed
0	10			0	3	passed
10	0	normal	4700	-1	-4	passed
10	5			-1	-3	passed
10	10			0	5	passed
20	0	low	4700	-2	-8	passed
20	5			-1	4	passed
20	10			0	-4	passed
20	0	normal	4700	0	-2	passed
20	5			-1	-4	passed
20	10			-1	-3	passed
20	0	high	4700	1	5	passed
20	5			-1	-3	passed
20	10			0	-3	passed
30	0	normal	4700	-1	3	passed
30	5			-2	-4	passed
30	10			-2	-6	passed
40	0	normal	4700	-2	-3	passed
40	5			-2	-4	passed
40	10			0	3	passed
50	0	normal	4700	-1	-4	passed
50	5			-1	-5	passed
50	10			-1	-3	passed

LTE eFDD 2

Temp. °C	Duration min	Voltage	Limit Hz	Freq. error Average (Hz)	Freq. error Max. (Hz)	Verdict
-30	0	normal	4700	0	4	passed
-30	5			0	3	passed
-30	10			0	4	passed
-20	0	normal	4700	-1	5	passed
-20	5			0	2	passed
-20	10			1	3	passed
-10	0	normal	4700	1	5	passed
-10	5			1	5	passed
-10	10			0	3	passed
0	0	normal	4700	-1	2	passed
0	5			0	3	passed
0	10			-1	3	passed
10	0	normal	4700	0	3	passed
10	5			0	2	passed
10	10			0	3	passed
20	0	low	4700	-1	4	passed
20	5			1	3	passed
20	10			1	3	passed
20	0	normal	4700	0	2	passed
20	5			-1	4	passed
20	10			0	4	passed
20	0	high	4700	1	3	passed
20	5			1	5	passed
20	10			0	3	passed
30	0	normal	4700	0	4	passed
30	5			1	3	passed
30	10			-1	2	passed
40	0	normal	4700	0	2	passed
40	5			-1	2	passed
40	10			0	4	passed
50	0	normal	4700	-1	5	passed
50	5			1	4	passed
50	10			1	4	passed

5.9.4 TEST EQUIPMENT USED

Radio Lab

## 5.10 SPURIOUS EMISSIONS AT ANTENNA TERMINAL

Standard **FCC PART 24 Subpart E**

**The test was performed according to:**  
ANSI C63.26: 2015

### 5.10.1 TEST DESCRIPTION

This test case is intended to demonstrate compliance to the applicable conducted spurious emission test case per § 2.1051 and RSS-GEN 6.13. The limit comes from the applicable rule part and ISSED RSS-Standard for the operating band of the cellular device.

The EUT was connected to the test setup according to the following diagram:

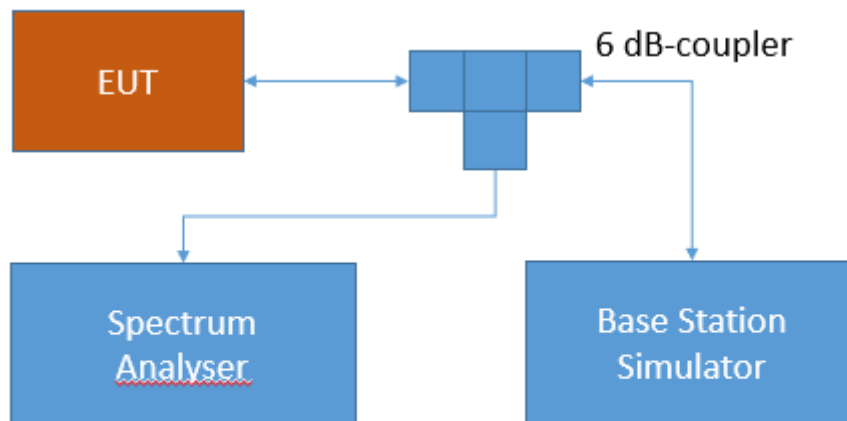

Test Setup FCC Part 22/24/27/90 Cellular;  
Spurious Emissions at antenna terminal

The attenuation of the measuring and stimulus path are known for each measured frequency and are considered.

The Spectrum Analyzer settings can be directly found in the measurement diagrams.

### 5.10.2 TEST REQUIREMENTS / LIMITS

#### **FCC Part 2.1051; Measurement required: Spurious emissions at antenna terminal:**

The radio frequency voltage or powers generated within the equipment and appearing on a spurious frequency shall be checked at the equipment output terminals when properly loaded with a suitable artificial antenna. Curves or equivalent data shall show the magnitude of each harmonic and other spurious emission that can be detected when the equipment is operated under the conditions specified in §2.1049 as appropriate. The magnitude of spurious emissions which are attenuated more than 20 dB below the permissible value need not be specified.



**Part 24, Subpart E – Broadband PCS; Band 2**

**§24.238 – Emission limitations for Broadband PCS equipment**

(a) *Out of band emissions.* The power of any emission outside of the authorized operating frequency ranges must be attenuated below the transmitting power (P) by a factor of at least  $43 + 10 \log(P)$  dB.

**RSS-133; 6.5 Transmitter Unwanted Emissions**

**6.5.1 Out-of-Block Emissions**

Equipment shall comply with the limits in (i) and (ii) below.

- i. In the 1.0 MHz bands immediately outside and adjacent to the equipment’s operating frequency block, the emission power per any 1% of the emission bandwidth shall be attenuated (in dB) below the transmitter output power P (dBW) by at least  $43 + 10 \log_{10}(P)$  (watts).
- ii. After the first 1.0 MHz, the emission power in any 1 MHz bandwidth shall be attenuated (in dB) below the transmitter output power P (dBW) by at least  $43 + 10 \log_{10}(P)$  (watts). If the measurement is performed using 1% of the emission bandwidth, power integration over 1.0 MHz is required.

**5.10.3 TEST PROTOCOL**

Ambient temperature: 20 - 28 °C  
 Relative humidity: 30 - 45 %

Radio Technology	Channel	Detector	Trace	Resolution Bandwidth /kHz	Frequency /MHz	Peak Value /dBm	Limit /dBm	Margin to Limit /dB
GSM 1900	low	rms	maxhold	3	1849.9	-27.01	-13	14.01
GSM 1900	mid	rms	maxhold	-	-	-	-13	> 20
GSM 1900	high	rms	maxhold	3	1910	-30.9	-13	17.90

Radio Technology	Channel	Detector	Trace	Resolution Bandwidth /kHz	Frequency /MHz	Peak Value /dBm	Limit /dBm	Margin to Limit /dB
EDGE 1900	low	rms	maxhold	3	1849.9	-34.44	-13	21.44
EDGE 1900	mid	rms	maxhold	-	-	-	-13	> 20
EDGE 1900	high	rms	maxhold	3	1910	-35.4	-13	22.40

Radio Technology	Channel	Detector	Trace	Resolution Bandwidth /kHz	Frequency /MHz	Peak Value /dBm	Limit /dBm	Margin to Limit /dB
WCDMA FDD2	low	rms	maxhold	50	1849.8	-25.61	-13	12.61
WCDMA FDD2	mid	peak	maxhold	1000	1961.3	-23.58	-13	10.58
WCDMA FDD2	high	rms	maxhold	50	1910.1	-29.36	-13	16.36
WCDMA FDD2	high	peak	maxhold	1000	1987.7	-23.44	-13	10.44

Radio Technology	Channel	Detector	Trace	Resolution Bandwidth /kHz	Frequency /MHz	Peak Value /dBm	Limit /dBm	Margin to Limit /dB
HSDPA FDD2	low	rms	maxhold	50	1849.9	-26.74	-13	13.74
HSDPA FDD2	mid	rms	maxhold	-	-	-	-13	> 20
HSDPA FDD2	high	rms	maxhold	-	-	-	-13	> 20

Radio Technology	Channel	Detector	Trace	Resolution Bandwidth /kHz	Frequency /MHz	Peak Value /dBm	Limit /dBm	Margin to Limit /dB
HSUPA FDD2	low	rms	maxhold	50	1849.9	-26.70	-13	13.70
HSUPA FDD2	mid	rms	maxhold	-	-	-	-13	>20
HSUPA FDD2	high	rms	maxhold	50	1910.0	-31.17	-13	18.17

Radio Technology	Channel	Detector	Trace	Resolution Bandwidth /kHz	Frequency /MHz	Peak Value /dBm	Limit /dBm	Margin to Limit /dB
LTE eFDD2	low	rms	maxhold	5	1850.0	-33.34	-23	10.34
LTE eFDD2	mid	rms	maxhold	-	-	-	-13	>20
LTE eFDD2	high	rms	maxhold	5	1910.0	-33.89	-23	10.89

Remark: Please see next sub-clause for the measurement plot.

#### 5.10.4 MEASUREMENT PLOT (EXAMPLE PLOT, SHOWING WORST CASE, IF APPLICABLE)

GSM 1900, Channel = low

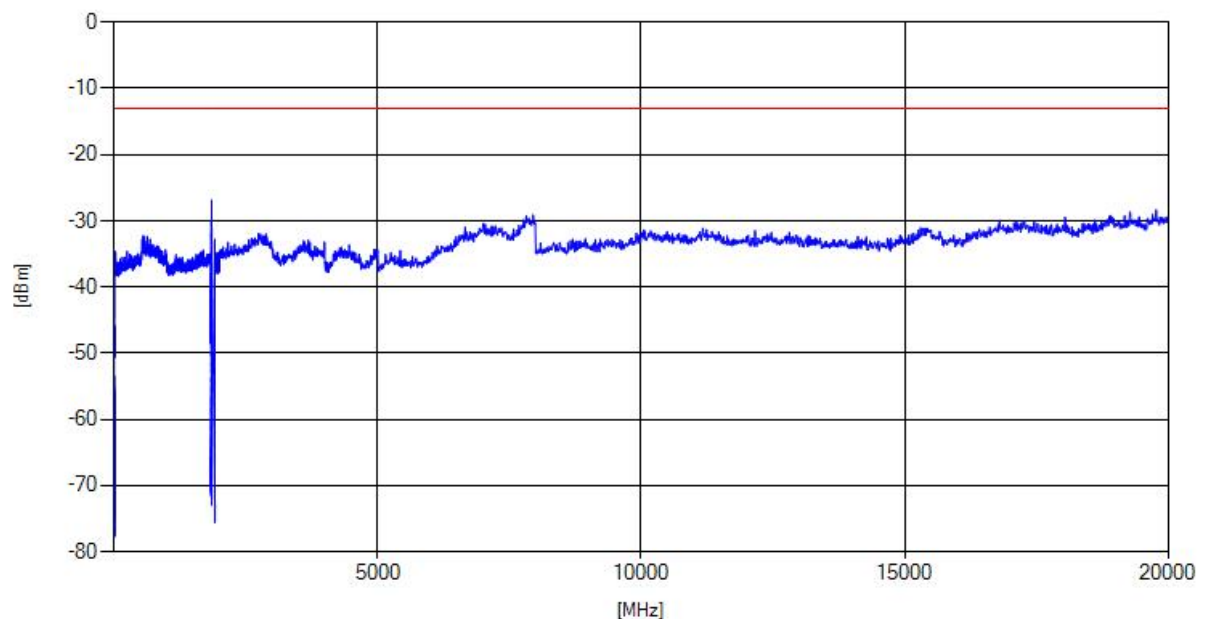

EDGE 1900, Channel = low

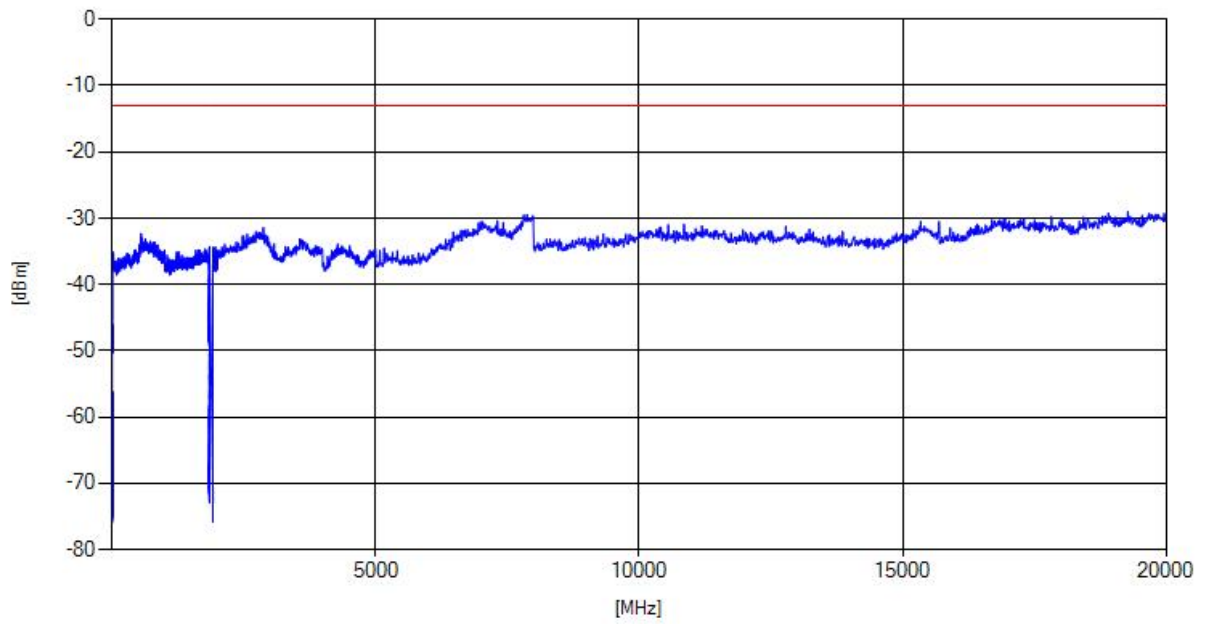

WCDMA FDD 2, Channel = high

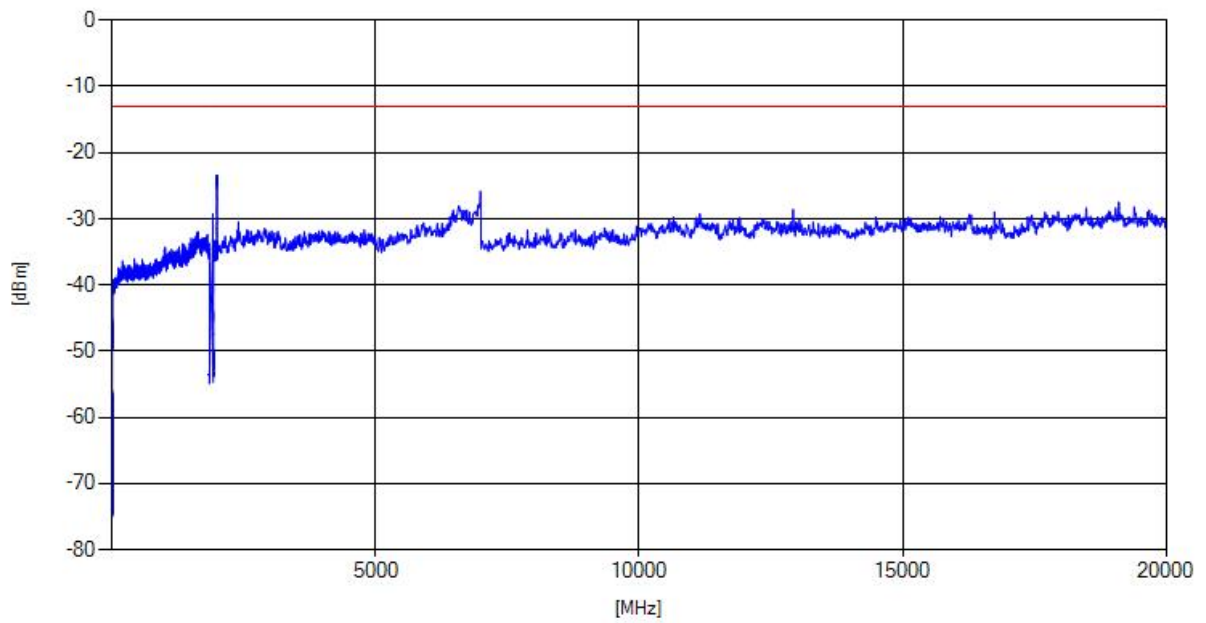

HSDPA FDD 2, Channel = low

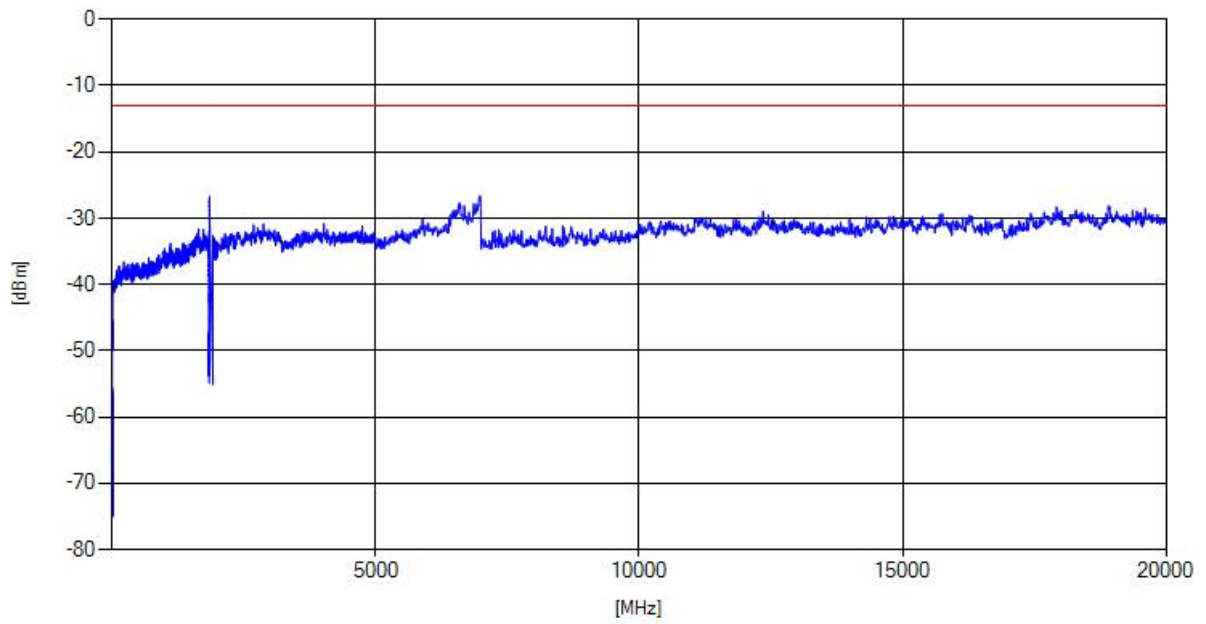

HSUPA FDD 2, Channel = low

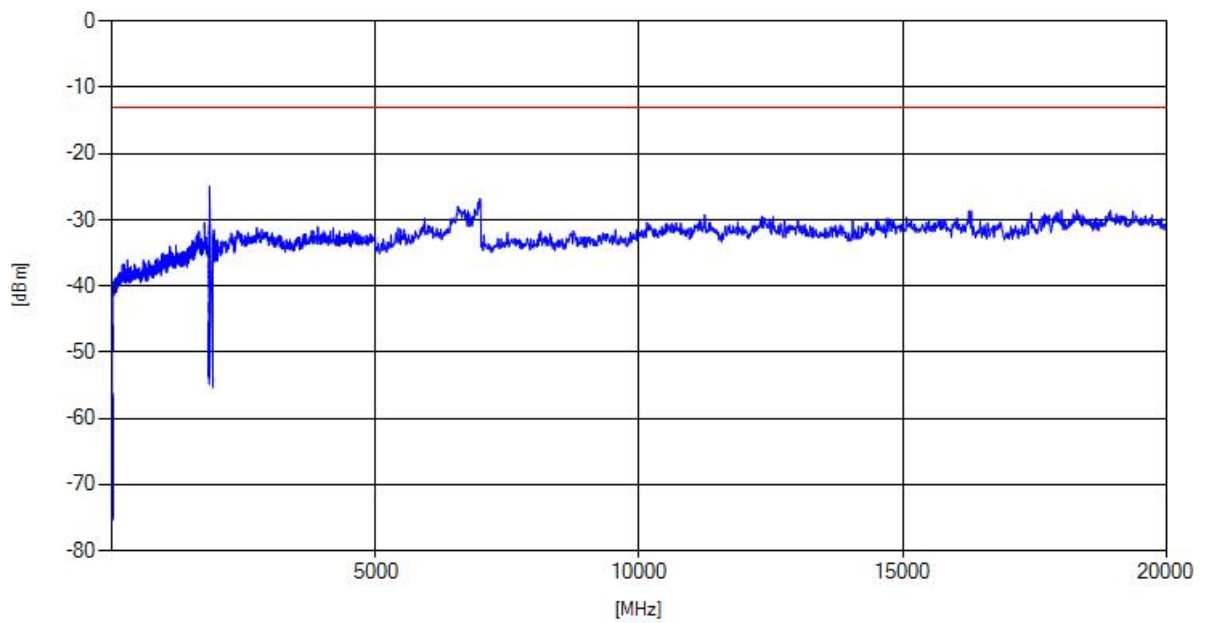

LTE eFDD 2 QPSK, Channel = low

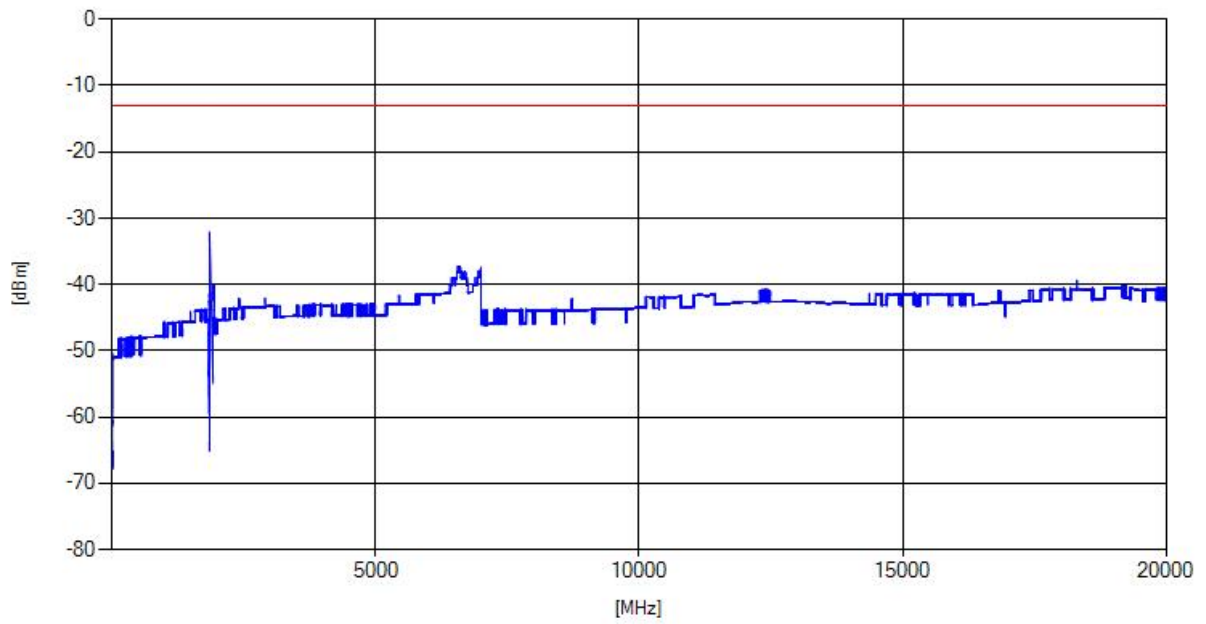

### 5.10.5 TEST EQUIPMENT USED

- Radio Lab

## 5.11 FIELD STRENGTH OF SPURIOUS RADIATION

Standard **FCC PART 24 Subpart E**

**The test was performed according to:**  
ANSI C63.26: 2015

### 5.11.1 TEST DESCRIPTION

This test case is intended to demonstrate compliance to the applicable radiated spurious emission measurements per § 2.1053 and RSS-GEN 6.13. The limit and requirements come from the applicable rule part and ISED RSS-Standard for the operating band of the cellular device.

The EUT was connected to the test setup according to the following diagram:

Frequency Range: 30 MHz – 1 GHz:

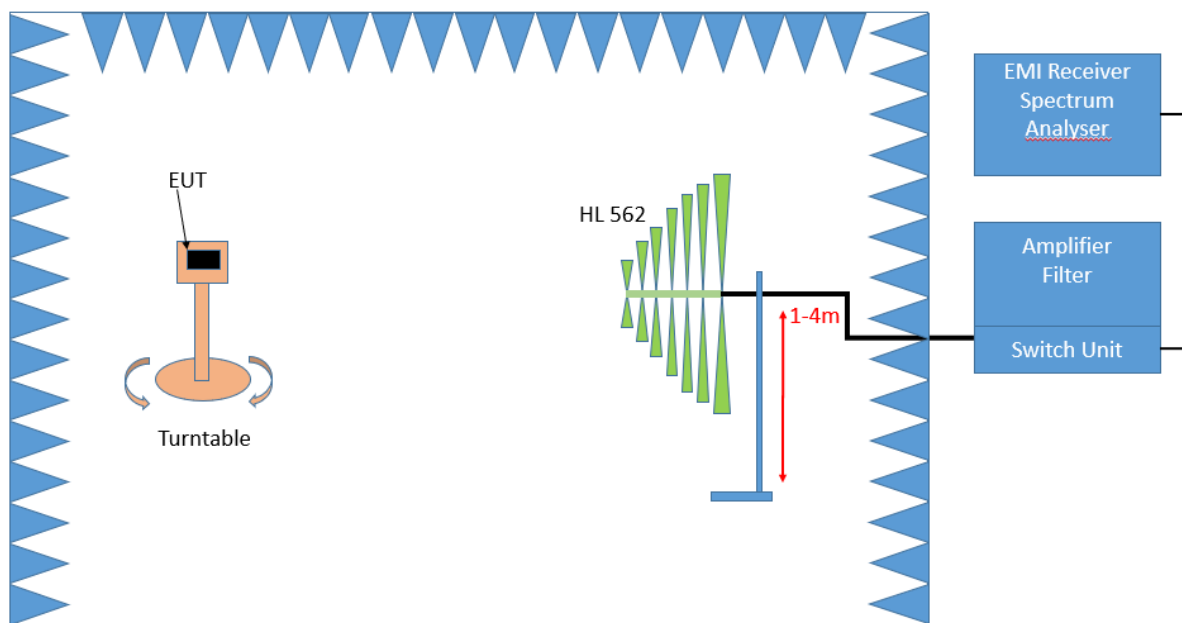

Test Setup; Spurious Emission Radiated (SAC), 30 MHz- 1GHz

Frequency Range: 1 GHz – 26.5 GHz

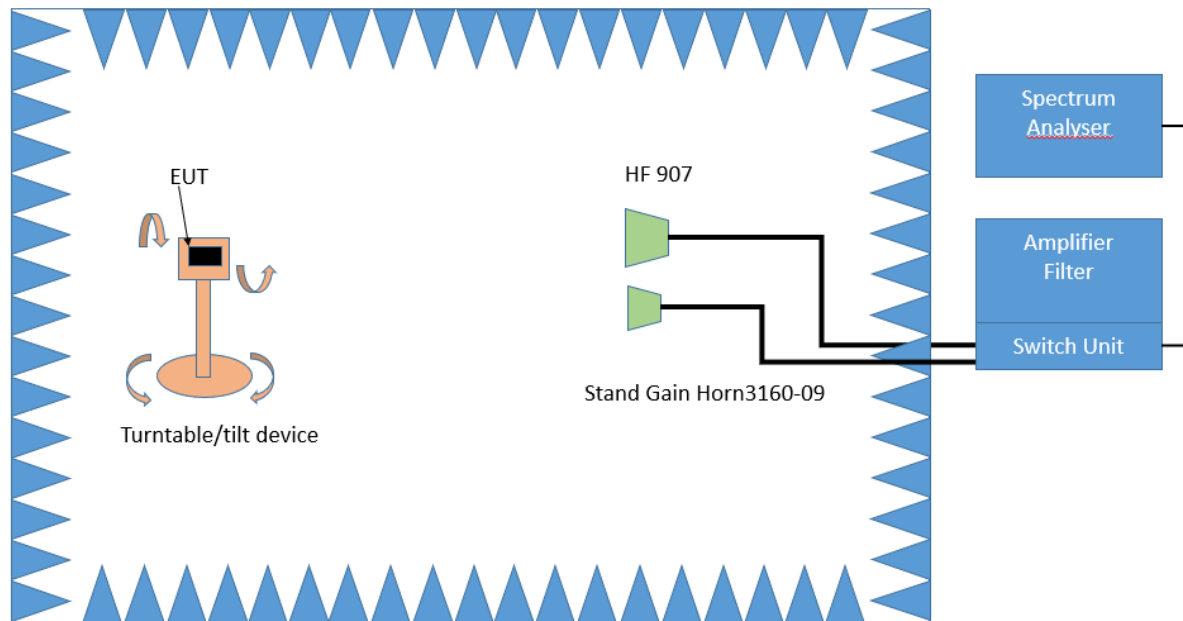

Test Setup; Spurious Emission Radiated (FAC), 1 GHz-26.5 GHz

The test set-up was made in accordance to the general provisions of ANSI C63.26 in a typical installation configuration. The Equipment Under Test (EUT) was set up on a non-conductive table 1.0 x 2.0 m<sup>2</sup> in the semi-anechoic chamber. The influence of the EUT support table that is used between 30–1000 MHz was evaluated.

The measurement procedure is implemented into the EMI test software EMC32 from R&S. Exploratory tests are performed at 3 orthogonal axes to determine the worst-case orientation of a body-worn or handheld EUT. The final test on all kind of EUTs is also performed at 3 axes. A pre-check is performed while the EUT is powered from a DC power source.

## 1. Measurement above 30 MHz and up to 1 GHz

### Step 1: Preliminary scan

This is a preliminary test to identify the highest amplitudes relative to the limit.

Settings for step 1:

- Antenna distance: 3 m
- Detector: Peak
- RBW: 100 kHz
- VBW: 300 kHz
- Sweep time: coupled
- Turntable angle range:  $-180^{\circ}$  to  $90^{\circ}$
- Turntable step size:  $90^{\circ}$
- Height variation range: 1 – 4 m
- Height variation step size: 1.5 m
- Polarisation: Horizontal + Vertical

Intention of this step is, to determine the radiated EMI-profile of the EUT. Afterwards the relevant emissions for the final measurement are identified.

### Step 2: Adjustment measurement

In this step the accuracy of the turntable azimuth and antenna height will be improved. This is necessary to find out the maximum value of every frequency.

For each frequency, which was determined the turntable azimuth and antenna height will be adjusted. The turntable azimuth will slowly vary by  $360^{\circ}$ . During this action, the value of emission is continuously measured. The turntable azimuth at the highest emission will be

recorded and adjusted. In this position, the antenna height will also slowly vary from 1 – 4 m. During this action, the value of emission is also continuously measured. The antenna height of the highest emission will also be recorded and adjusted.

- Detector: Peak
- Measured frequencies: in step 1 determined frequencies
- RBW: 100 kHz
- VBW: 300 kHz
- Sweep time: coupled
- Turntable angle range: 360°
- Height variation range: 1 – 4 m
- Antenna Polarisation: max. value determined in step 1

### **Step 3:** Final measurement with RMS detector

With the settings determined in step 3, the final measurement will be performed:

EMI receiver settings for step 4:

- Detector: RMQ
- Measured frequencies: in step 1 determined frequencies
- RBW: 100 kHz
- VBW: 300 kHz
- Sweep time: 1 s

After the measurement a plot will be generated which contains a diagram with the results of the preliminary scan and a chart with the frequencies and values of the results of the final measurement.

## **3. Measurement above 1 GHz**

The following modifications apply to the measurement procedure for the frequency range above 1 GHz:

### **Step 1:**

The Equipment Under Test (EUT) was set up on a non-conductive support (tilt device) at 1.5 m height in the fully-anechoic chamber.

All steps were performed with one height (1.5 m) of the receiving antenna only.

The EUT is turned during the preliminary measurement across the elevation axis, with a step size of 90 °.

The turn table step size (azimuth angle) for the preliminary measurement is 45 °.

- Antenna distance: 3 m
- Detector: Peak
- RBW: 1 MHz
- VBW: 3 MHz
- Sweep time: coupled
- Turntable angle range: -180° to 90°
- Turntable step size: 90°
- Polarisation: Horizontal + Vertical

### **Step 2:**

Due to the fact, that in this frequency range the test is performed in a fully anechoic room, the height scan of the receiving antenna instep 2 is omitted. Instead of this, a maximum search with a step size  $\pm 45^\circ$  for the elevation axis is performed.

The turn table azimuth will slowly vary by  $\pm 22.5^\circ$ .

The elevation angle will slowly vary by  $\pm 45^\circ$

EMI receiver settings (for all steps):

- Detector: Peak,
- RBW: 1 MHz
- VBW: 3 MHz
- Sweep time: coupled



### Step 3:

Spectrum analyser settings for step 3:

- Detector: RMS
- Measured frequencies: in step 1 determined frequencies
- RBW: 1 MHz
- VBW: 3 MHz
- Sweep Time: 1 s

## 5.11.2 TEST REQUIREMENTS / LIMITS

### **FCC Part 2.1053; Measurement required: Field strength of spurious radiation:**

Measurements shall be made to detect spurious emissions that may be radiated directly from the cabinet, control circuits, power leads, or intermediate circuit elements under normal conditions of installation and operation. Curves or equivalent data shall be supplied showing the magnitude of each harmonic and other spurious emission. For this test, single sideband, independent sideband, and controlled carrier transmitters shall be modulated under the conditions specified in paragraph (c) of §2.1049, as appropriate.

### **Part 24, Subpart E – Broadband PCS**

#### **§ 24 238 – Emission limitations for Broadband PCS equipment**

- a) Out of band emissions. The power of any emission outside of the authorized operating frequency ranges must be attenuated below the transmitting power (P) by a factor of at least  $43 + 10 \log(P)$  dB.
- b) Measurement procedure. Compliance with these rules is based on the use of measurement instrumentation employing a resolution bandwidth of 1 MHz or greater. However, in the 1 MHz bands immediately outside and adjacent to the frequency block a resolution bandwidth of at least one percent of the emission bandwidth of the fundamental emission of the transmitter may be employed. A narrower resolution bandwidth is permitted in all cases to improve measurement accuracy provided the measured power is integrated over the full required measurement bandwidth (i.e. 1 MHz or 1 percent of emission bandwidth, as specified). The emission bandwidth is defined as the width of the signal between two points, one below the carrier center frequency and one above the carrier center frequency, outside of which all emissions are attenuated at least 26 dB below the transmitter power.

#### **RSS-133; 6.5 Transmitter Unwanted Emissions**

Mobile and base station equipment shall comply with the limits in (1) and (2) below.

1. In the 1.0 MHz bands immediately outside and adjacent to the equipment's operating frequency block, the emission power per any 1% of the emission bandwidth shall be attenuated (in dB) below the transmitter output power P (dBW) by at least  $43 + 10 \log_{10}P$  (watts).
2. After the first 1.0 MHz, the emission power in any 1 MHz bandwidth shall be attenuated (in dB) below the transmitter output power P (dBW) by at least  $43 + 10 \log_{10}P$  (watts). If the measurement is performed using 1% of the emission bandwidth, power integration over 1.0 MHz is required.

### 5.11.3 TEST PROTOCOL

Ambient temperature: 20 - 28 °C  
 Relative humidity: 30 - 45 %

Radio Technology	Channel	Detector	Trace	Resolution Bandwidth /kHz	Frequency /MHz	Peak Value /dBm	Limit /dBm	Margin to Limit /dB
GSM 1900	low	rms	maxhold	3	1849.9	-19.15	-13	6.15
GSM 1900	mid	peak	maxhold				-13	-13.00
GSM 1900	high	rms	maxhold	3	1910	-17.4	-13	4.40

Radio Technology	Channel	Detector	Trace	Resolution Bandwidth /kHz	Frequency /MHz	Peak Value /dBm	Limit /dBm	Margin to Limit /dB
EDGE 1900	low	rms	maxhold	3	1849.9	-23.44	-13	10.44
EDGE 1900	mid	rms	maxhold	-	-	-	-13	>20
EDGE 1900	high	rms	maxhold	3	1910.0	-25.42	-13	12.42

Radio Technology	Channel	Detector	Trace	Resolution Bandwidth /kHz	Frequency /MHz	Peak Value /dBm	Limit /dBm	Margin to Limit /dB
WCDMA FDD2	low	rms	maxhold	1000	1849.0	-16.16	-13	3.16
WCDMA FDD2	mid	peak	maxhold	-	-	-	-13	> 20
WCDMA FDD2	high	rms	maxhold	50	1910.2	-28.56	-13	15.56

Radio Technology	Channel	Detector	Trace	Resolution Bandwidth /kHz	Frequency /MHz	Peak Value /dBm	Limit /dBm	Margin to Limit /dB
FDD2 HSDPA	low	rms	maxhold	1000	1849.0	-15.37	-13	2.37
FDD2 HSDPA	mid	peak	maxhold	-	-	-	-13	> 20
FDD2 HSDPA	high	rms	maxhold	50	1910	-27.7	-13	14.70

Radio Technology	Channel	Detector	Trace	Resolution Bandwidth /kHz	Frequency /MHz	Peak Value /dBm	Limit /dBm	Margin to Limit /dB
FDD2 HSUPA	low	rms	maxhold	50	1849.9	-27.05	-13	14.05
FDD2 HSUPA	mid	peak	maxhold	-	-	-	-13	> 20
FDD2 HSUPA	high	rms	maxhold	50	1910	-29.29	-13	16.29

Radio Technology	Channel	Detector	Trace	Resolution Bandwidth /kHz	Frequency /MHz	Peak Value /dBm	Limit /dBm	Margin to Limit /dB
LTE eFDD2	low	rms	maxhold	5	1850.0	-33.91	-23	10.91
LTE eFDD2	mid	peak	maxhold	-	-	-	-13	> 20
LTE eFDD2	high	rms	maxhold	5	1910	-34.89	-23	11.89

Remark: Please see next sub-clause for the measurement plot.

### 5.11.4 MEASUREMENT PLOT (EXAMPLE PLOT, SHOWING WORST CASE, IF APPLICABLE)

GSM 1900, Channel = high  
30 MHz – 1 GHz

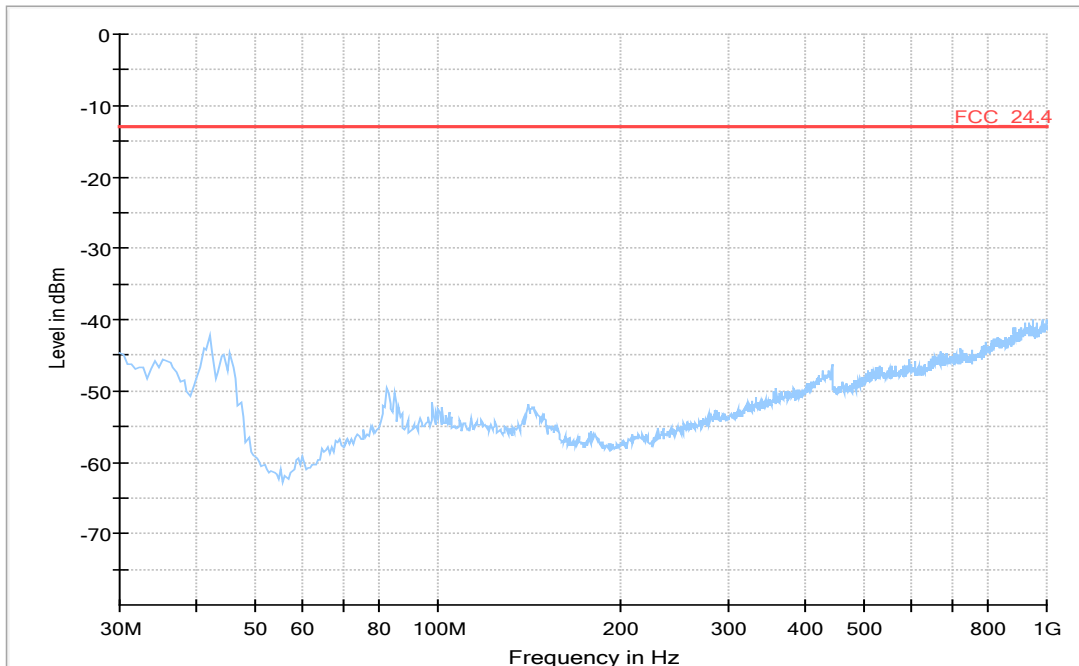

1 GHz – 20 GHz

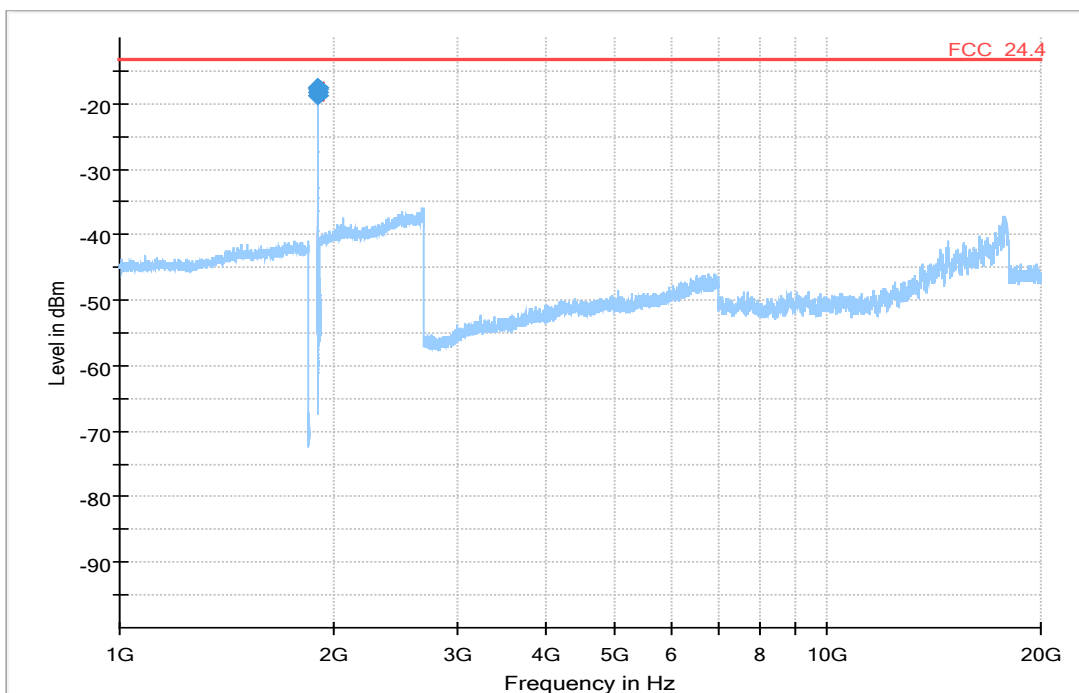

Frequency (MHz)	MaxPeak (dBm)	Limit (dBm)	Margin (dB)	Meas. Time (ms)	Bandwidth (kHz)	Height (cm)	Pol	Azimuth (deg)	Elevation (deg)	Corr. (dB)
1910.024	-17.4	-13.00	4.36	2000.0	3.000	150.0	H	-90.0	0.0	-64.5

EDGE 1900, Channel = low  
30 MHz - 1 GHz

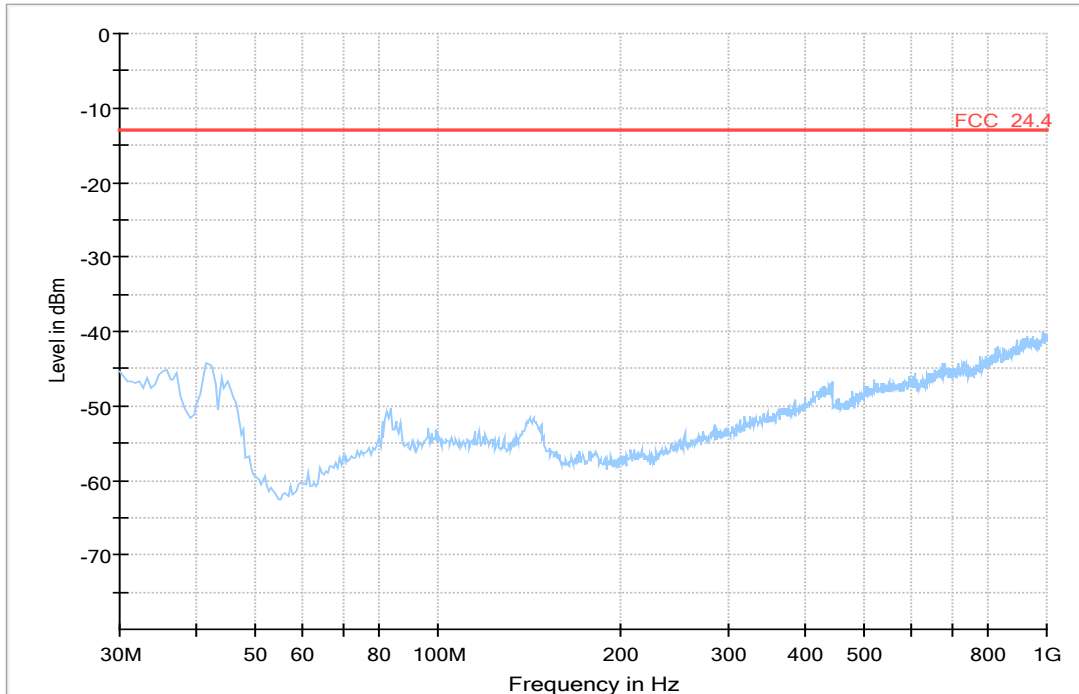

1 GHz - 20 GHz

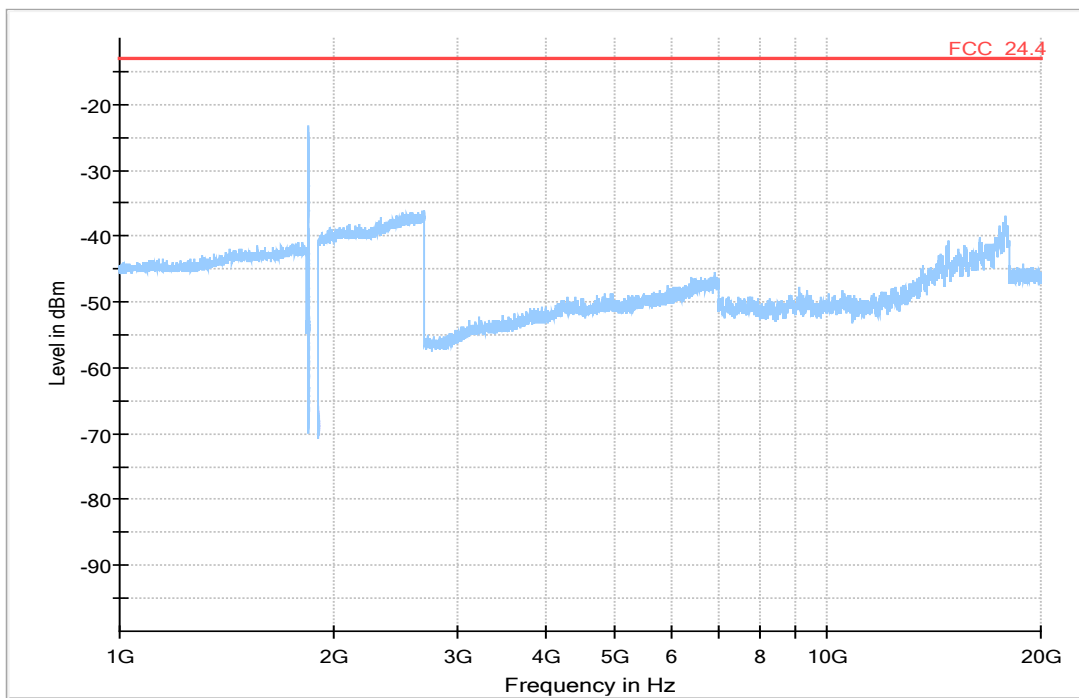

WCDMA FDD2, Channel = low  
30 MHz – 1 GHz

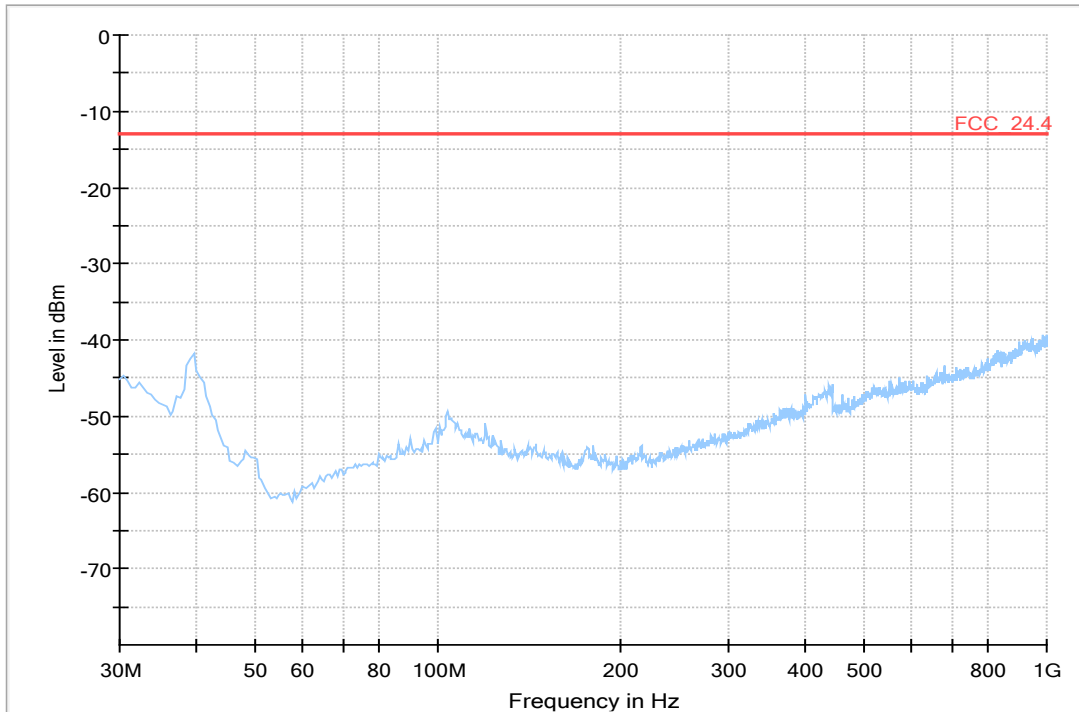

1 GHz – 20 GHz

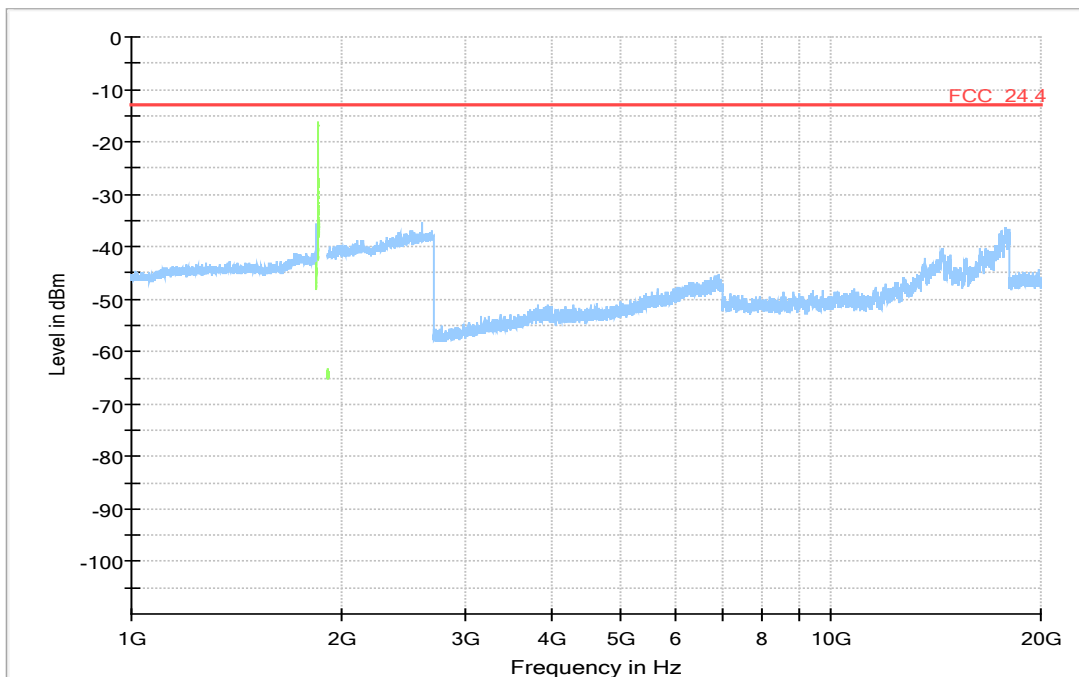

HSDPA FDD2, Channel = low  
30 MHz - 1 GHz

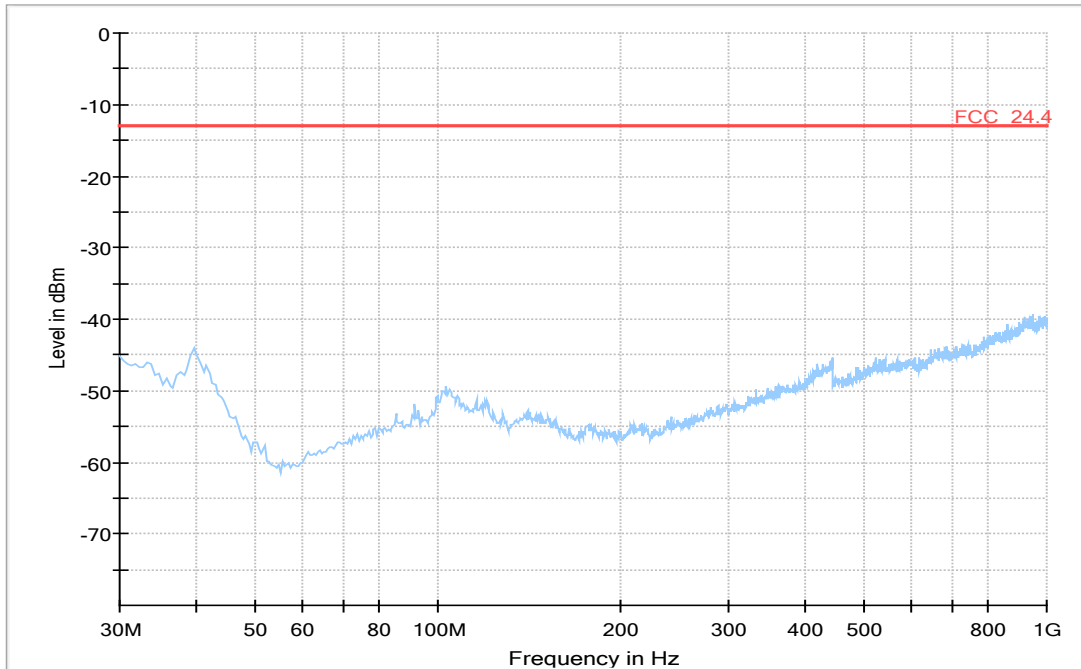

1 GHz - 20 GHz

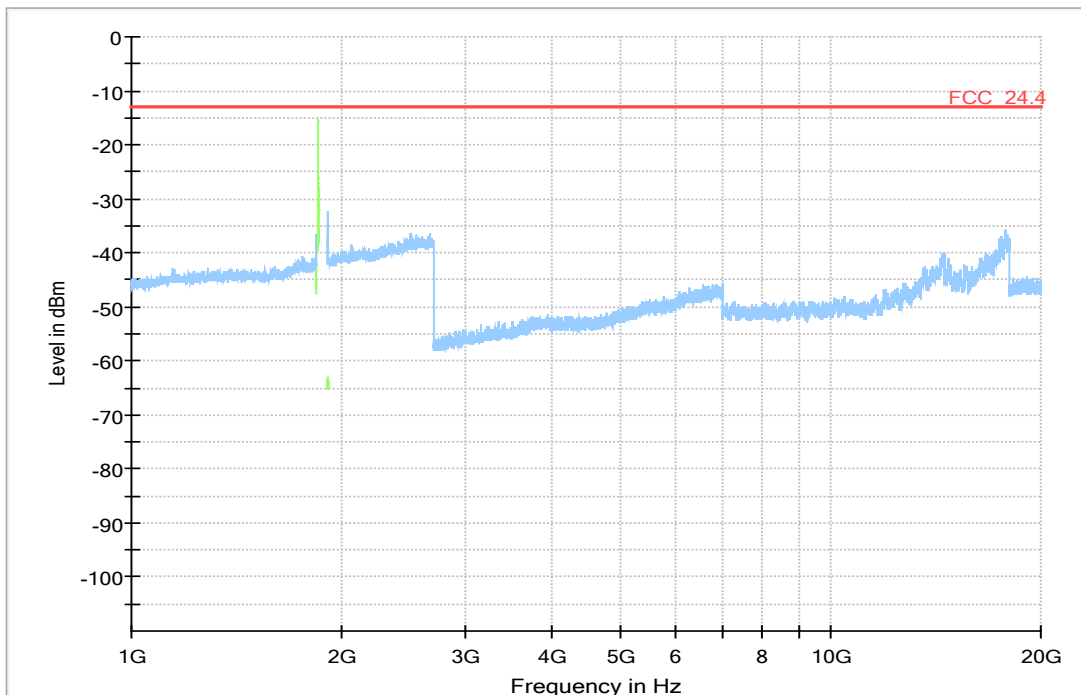

HSUPA FDD2, Channel = low  
30 MHz - 1 GHz

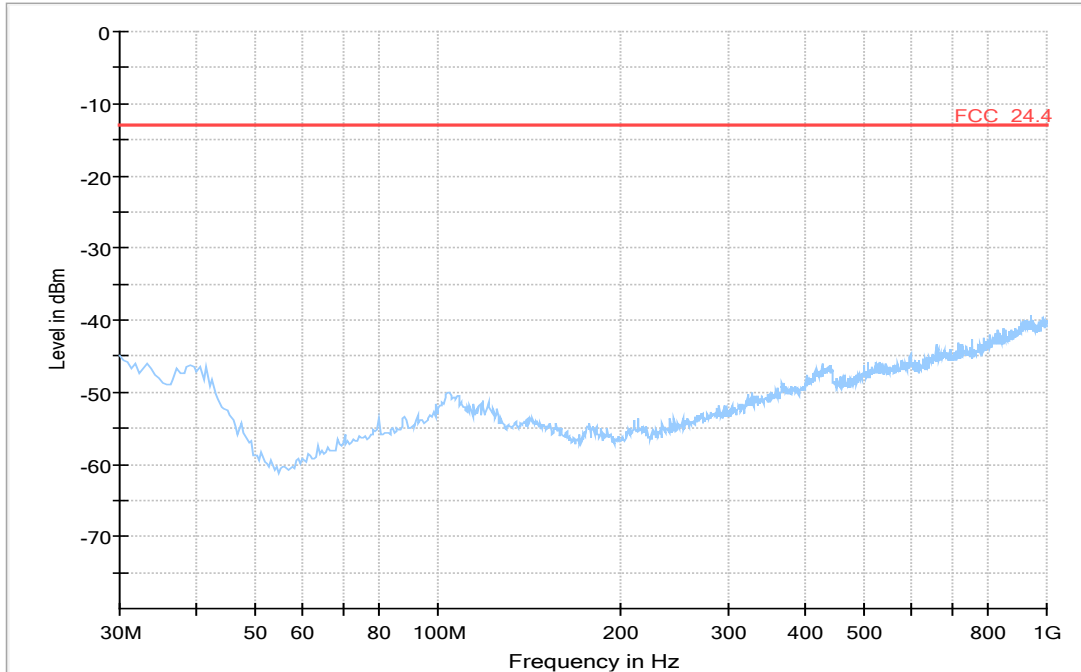

1 GHz - 20 GHz

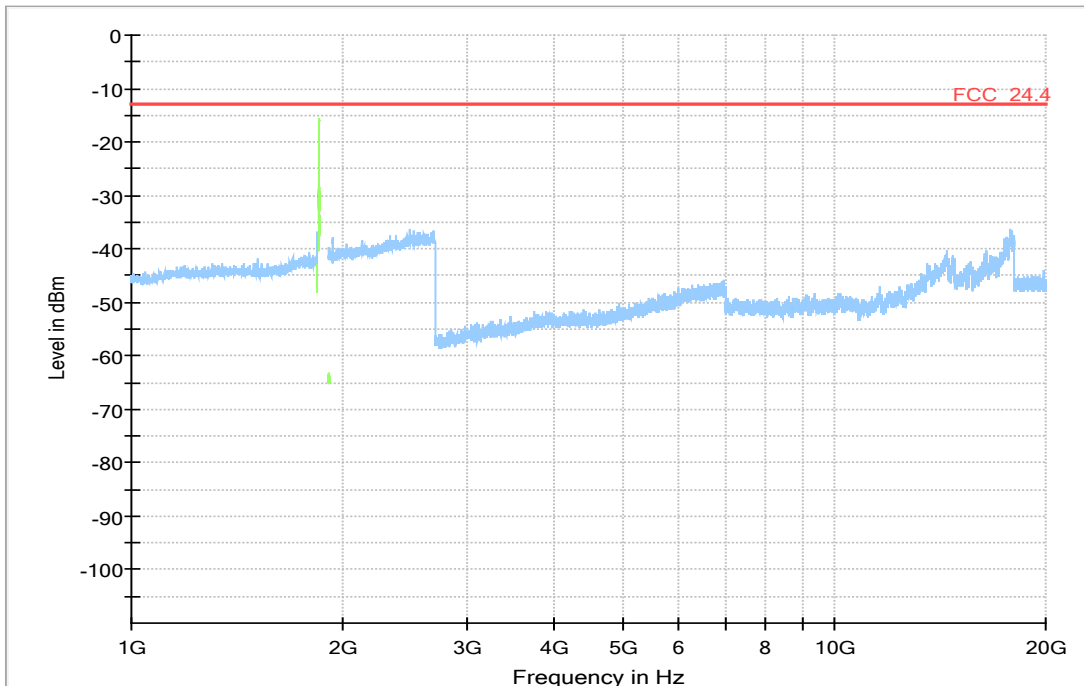

LTE eFDD2, Channel = low  
30 MHz - 1 GHz

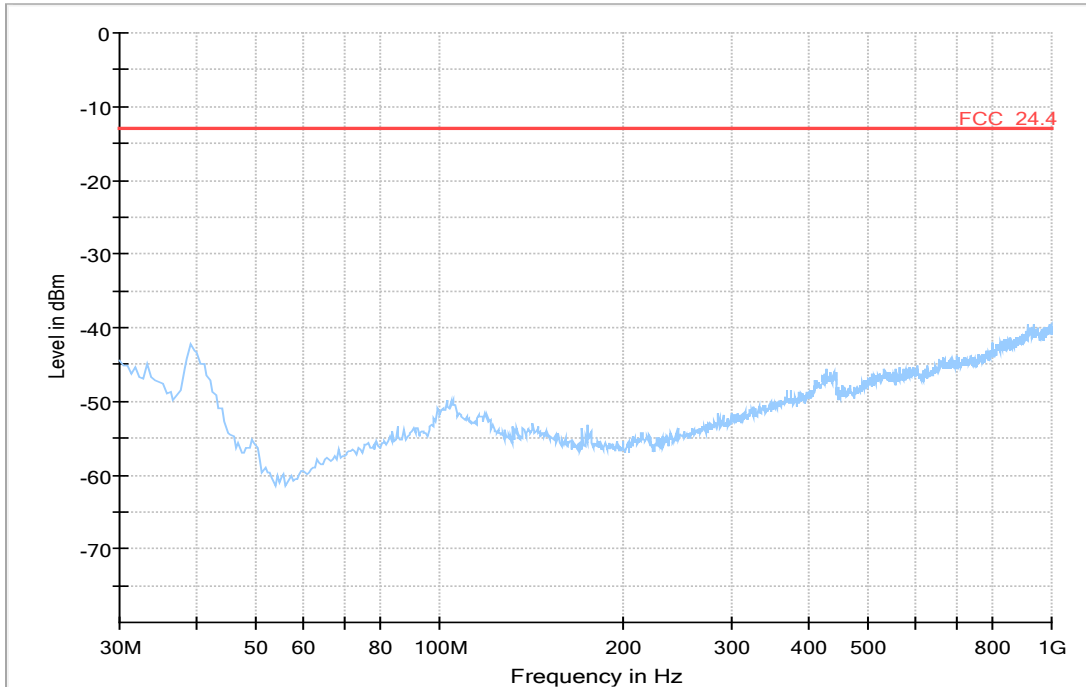

1 GHz - 20 GHz

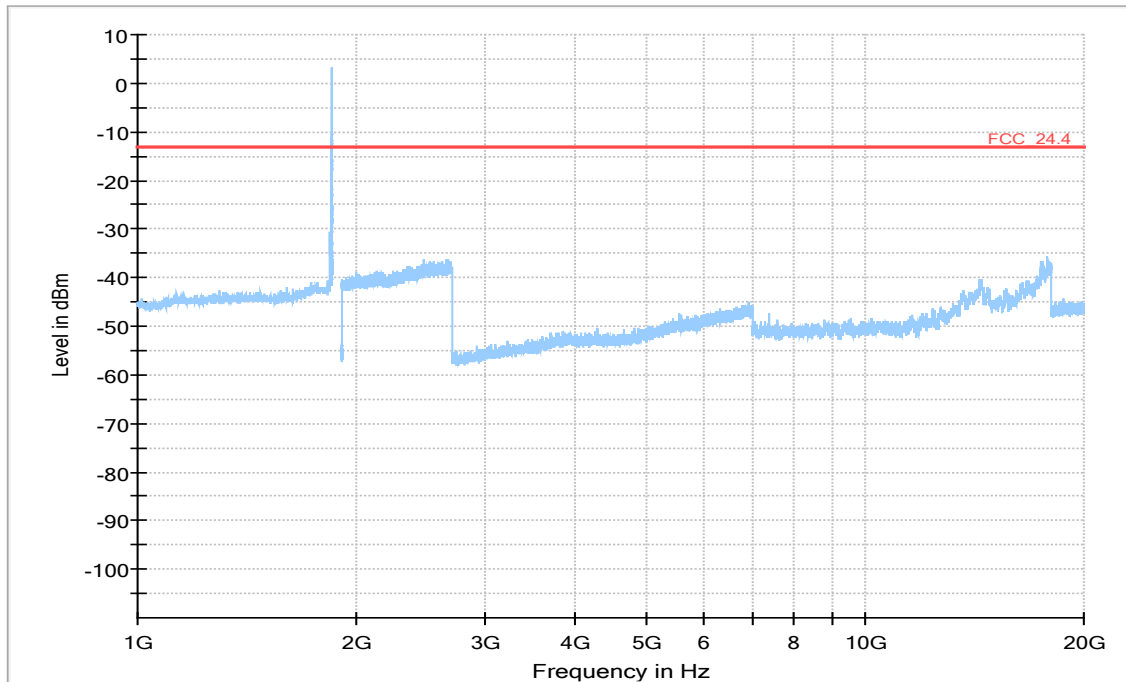



re-measurement at carrier

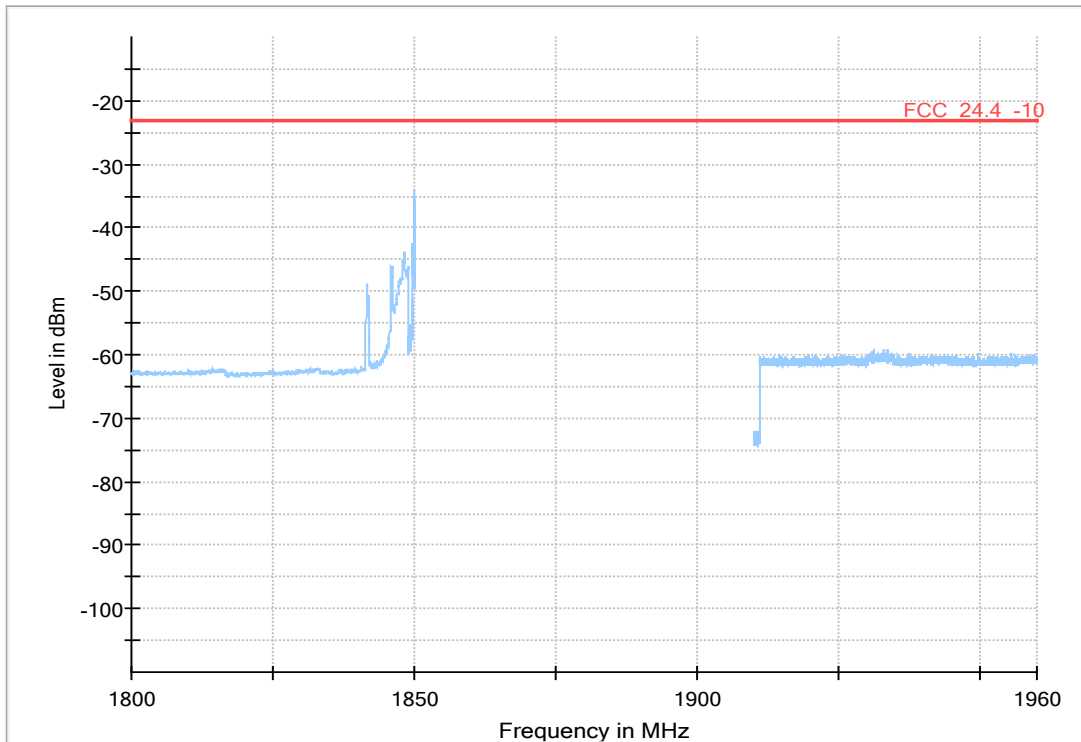

### 5.11.5 TEST EQUIPMENT USED

- Radiated Emissions

## 5.12 EMISSION AND OCCUPIED BANDWIDTH

Standard **FCC PART 24 Subpart E**

**The test was performed according to:**  
ANSI C63.26: 2015

### 5.12.1 TEST DESCRIPTION

This test case is intended to demonstrate compliance to the applicable conducted spurious emission test case per FCC §2.1049 and RSS-GEN 6.7. The limit and the requirements come from the applicable rule part and ISED RSS-Standard for the operating band of the cellular device.

The EUT was connected to the test setups according to the following diagram:

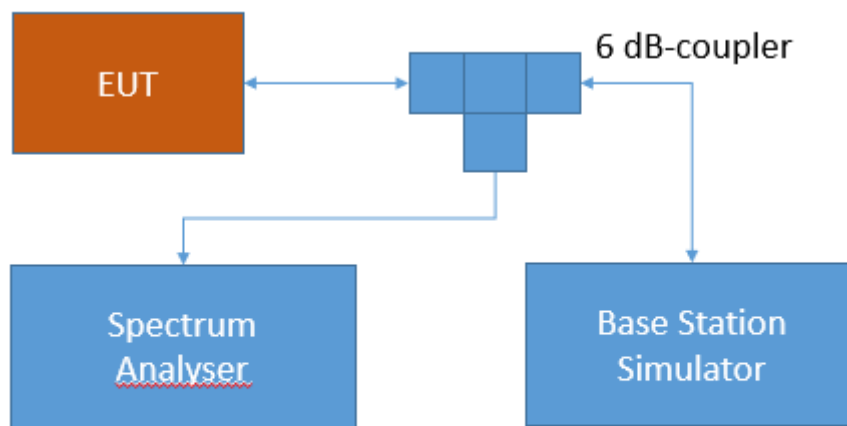

Test Setup FCC Part 22/24/27/90 Cellular;  
Spurious Emissions at antenna terminal

The attenuation of the measuring and stimulus path are known for each measured frequency and are considered.

The Spectrum Analyzer settings can be directly found in the measurement diagrams.

## 5.12.2 TEST REQUIREMENTS / LIMITS

### **FCC Part 2.1049; Occupied Bandwidth:**

The occupied bandwidth, that is the frequency bandwidth such that, below its lower and above its upper frequency limits, the mean powers radiated are each equal to 0.5 percent of the total mean power radiated by a given emission shall be measured under the following conditions as applicable:

(h) Transmitters employing digital modulation techniques—when modulated by an input signal such that its amplitude and symbol rate represent the maximum rated conditions under which the equipment will be operated. The signal shall be applied through any filter networks, pseudo-random generators or other devices required in normal service. Additionally, the occupied bandwidth shall be shown for operation with any devices used for modifying the spectrum when such devices are optional at the discretion of the user.

(i) Transmitters designed for other types of modulation—when modulated by an appropriate signal of sufficient amplitude to be representative of the type of service in which used. A description of the input signal should be supplied.

### **RSS-GEN; 6.7 Occupied Bandwidth (or 99% emission bandwidth) and x dB bandwidth**

The occupied bandwidth or the “99% emission bandwidth” is defined as the frequency range between two points, one above and the other below the carrier frequency, within which 99% of the total transmitted power of the fundamental transmitted emission is contained. The occupied bandwidth shall be reported for all equipment in addition to the specified bandwidth required in the applicable RSSs.

In some cases, the “x dB bandwidth” is required, which is defined as the frequency range between two points, one at the lowest frequency below and one at the highest frequency above the carrier frequency, at which the maximum power level of the transmitted emission is attenuated x dB below the maximum in-band power level of the modulated signal, where the two points are on the outskirts of the in-band emission.

The following conditions shall be observed for measuring the occupied bandwidth and x dB bandwidth:

The transmitter shall be operated at its maximum carrier power measured under normal test conditions.

The span of the spectrum analyzer shall be set large enough to capture all products of the modulation process, including the emission skirts, around the carrier frequency, but small enough to avoid having other emissions (e.g. on adjacent channels) within the span. The detector of the spectrum analyzer shall be set to “Sample”. However, a peak, or peak hold, may be used in place of the sampling detector since this usually produces a wider bandwidth than the actual bandwidth (worst-case measurement). Use of a peak hold (or “Max Hold”) may be necessary to determine the occupied / x dB bandwidth if the device is not transmitting continuously.

The resolution bandwidth (RBW) shall be in the range of 1% to 5% of the actual occupied / x dB bandwidth and the video bandwidth (VBW) shall not be smaller than three times the RBW value. Video averaging is not permitted.

Note: It may be necessary to repeat the measurement a few times until the RBW and VBW are in compliance with the above requirement.

For the 99% emission bandwidth, the trace data points are recovered and directly summed in linear power level terms. The recovered amplitude data points, beginning at the lowest frequency, are placed in a running sum until 0.5% of the total is reached, and that frequency recorded. The process is repeated for the highest frequency data points (starting at the highest frequency, at the right side of the span, and going down in frequency). This frequency is then recorded. The difference between the two recorded frequencies is the occupied bandwidth (or the 99% emission bandwidth).

### 5.12.3 TEST PROTOCOL

Ambient temperature: 20 - 28 °C  
Relative humidity: 30 - 45 %

Radio Technology	Channel	Ressource Blocks / Subcarrier	Bandwidth [MHz]	Nominal BW [MHz]	26 dB BW [kHz]	99 % BW [kHz]
GSM 1900	low	-	0.2	0.2	322.7	246.5
GSM 1900	mid	-	0.2	0.2	314.6	246.5
GSM 1900	high	-	0.2	0.2	318.6	246.5
GSM 1900 EDGE	low	-	0.2	0.2	286.6	234.5
GSM 1900 EDGE	mid	-	0.2	0.2	284.6	238.5
GSM 1900 EDGE	high	-	0.2	0.2	292.6	226.5
FDD II	low	-	5	5	4749.5	4128.3
FDD II	mid	-	5	5	4729.5	4128.3
FDD II	high	-	5	5	4749.5	4128.3
FDD II HSDPA Subtest 1	low	-	5	5	4709.4	4128.3
FDD II HSDPA Subtest 1	mid	-	5	5	4749.5	4128.3
FDD II HSDPA Subtest 1	high	-	5	5	4729.5	4128.3
FDD II HSUPA Subtest 1	low	-	5	5	4809.6	4168.3
FDD II HSUPA Subtest 1	mid	-	5	5	4789.6	4148.3
FDD II HSUPA Subtest 1	high	-	5	5	4789.6	4148.3
FDD II HSUPA Subtest 5	low	-	5	5	4809.6	4168.3
FDD II HSUPA Subtest 5	mid	-	5	5	4789.6	4148.3
FDD II HSUPA Subtest 5	high	-	5	5	4789.6	4148.3
LTE eFDD 2 QPSK	low	6	1.4	1.4	-	1118.2
LTE eFDD 2 QPSK	mid	6	1.4	1.4	-	1100.2
LTE eFDD 2 QPSK	high	6	1.4	1.4	-	1106.2
LTE eFDD 2 16QAM	low	6	1.4	1.4	-	1100.2
LTE eFDD 2 16QAM	mid	6	1.4	1.4	-	1106.2
LTE eFDD 2 16QAM	high	6	1.4	1.4	-	1100.2
LTE eFDD 2 QPSK	low	15	3	3	-	2753.5
LTE eFDD 2 QPSK	mid	15	3	3	-	2753.5
LTE eFDD 2 QPSK	high	15	3	3	-	2753.5

LTE eFDD 2 16QAM	low	15	3	3	-	2777.6
LTE eFDD 2 16QAM	mid	15	3	3	-	2741.5
LTE eFDD 2 16QAM	high	15	3	3	-	2765.5
LTE eFDD 2 QPSK	low	25	5	5	-	4549.1
LTE eFDD 2 QPSK	mid	25	5	5	-	4529.1
LTE eFDD 2 QPSK	high	25	5	5	-	4509.0
LTE eFDD 2 16QAM	low	25	5	5	-	4529.1
LTE eFDD 2 16QAM	mid	25	5	5	-	4569.1
LTE eFDD 2 16QAM	high	25	5	5	-	4529.1
LTE eFDD 2 QPSK	low	50	10	10	-	9018.0
LTE eFDD 2 QPSK	mid	50	10	10	-	8978.0
LTE eFDD 2 QPSK	high	50	10	10	-	8978.0
LTE eFDD 2 16QAM	low	12	10	10	-	2485.0
LTE eFDD 2 16QAM	mid	12	10	10	-	2525.1
LTE eFDD 2 16QAM	high	12	10	10	-	2485.0
LTE eFDD 2 QPSK	low	75	15	15	-	13527.1
LTE eFDD 2 QPSK	mid	75	15	15	-	13466.9
LTE eFDD 2 QPSK	high	75	15	15	-	13466.9
LTE eFDD 2 16QAM	low	18	15	15	-	3727.5
LTE eFDD 2 16QAM	mid	18	15	15	-	3787.6
LTE eFDD 2 16QAM	high	18	15	15	-	3727.5
LTE eFDD 2 QPSK	low	100	20	20	-	18036.1
LTE eFDD 2 QPSK	mid	100	20	20	-	18116.2
LTE eFDD 2 QPSK	high	100	20	20	-	17955.9
LTE eFDD 2 16QAM	low	18	20	20	-	4168.3
LTE eFDD 2 16QAM	mid	18	20	20	-	4088.2
LTE eFDD 2 16QAM	high	18	20	20	-	4248.5

Remark: Please see next sub-clause for the measurement plot.

### 5.12.4 MEASUREMENT PLOT (EXAMPLE PLOT, SHOWING WORST CASE, IF APPLICABLE)

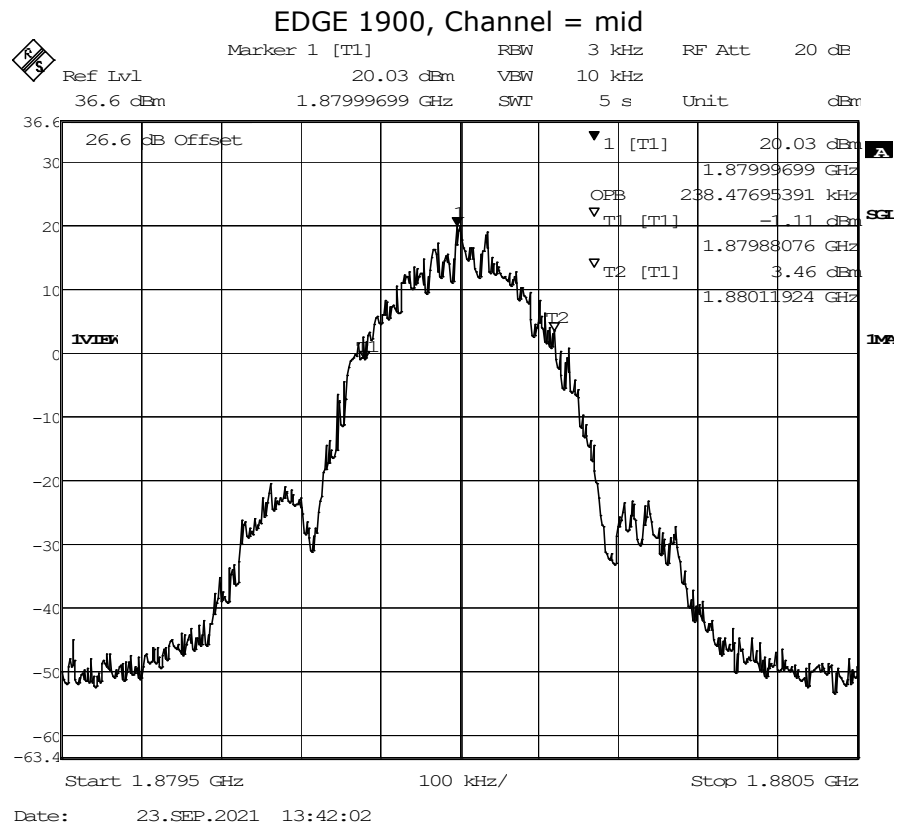
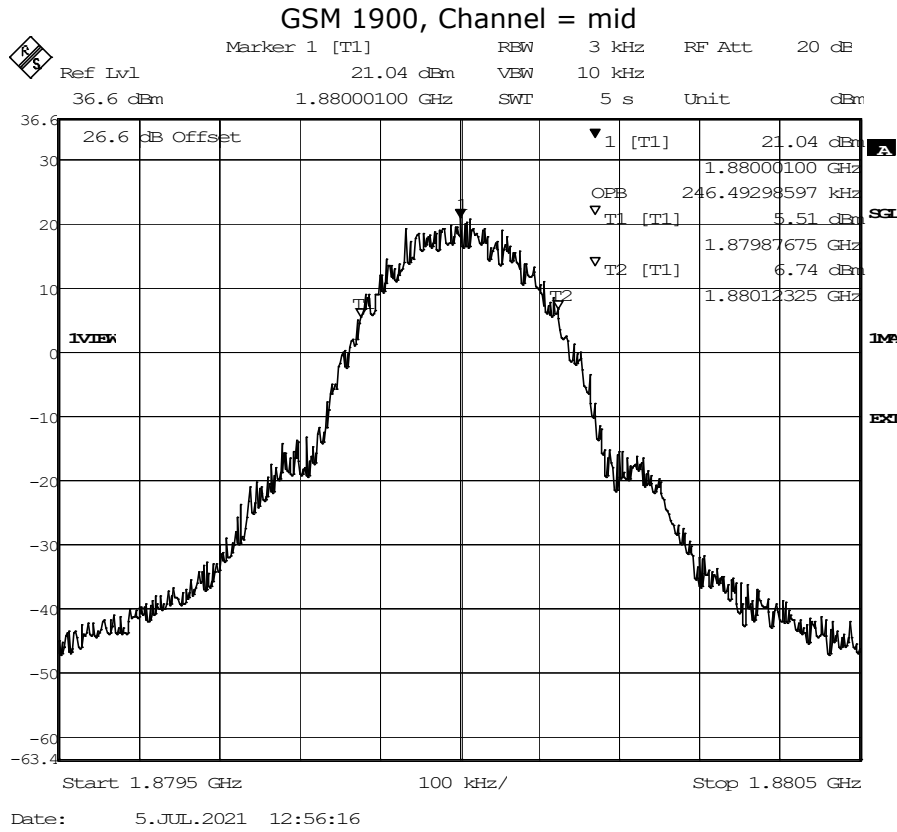

### WCDMA FDD2, Channel = mid

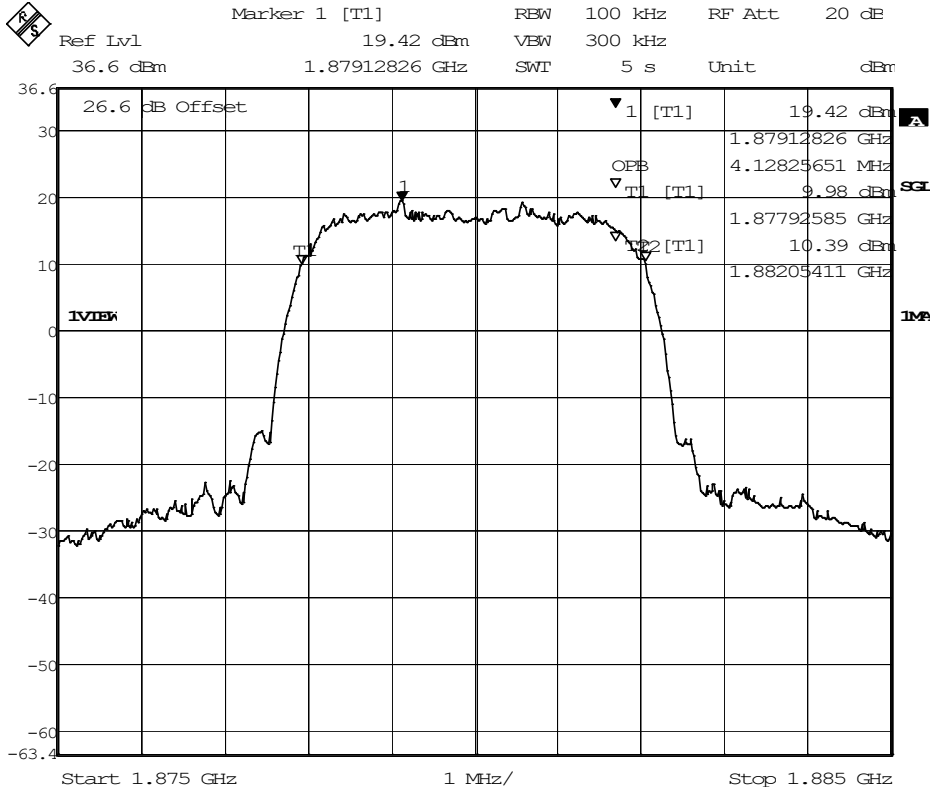

Date: 15.SEP.2021 15:52:07

### HSDPA FDD2, Channel = mid

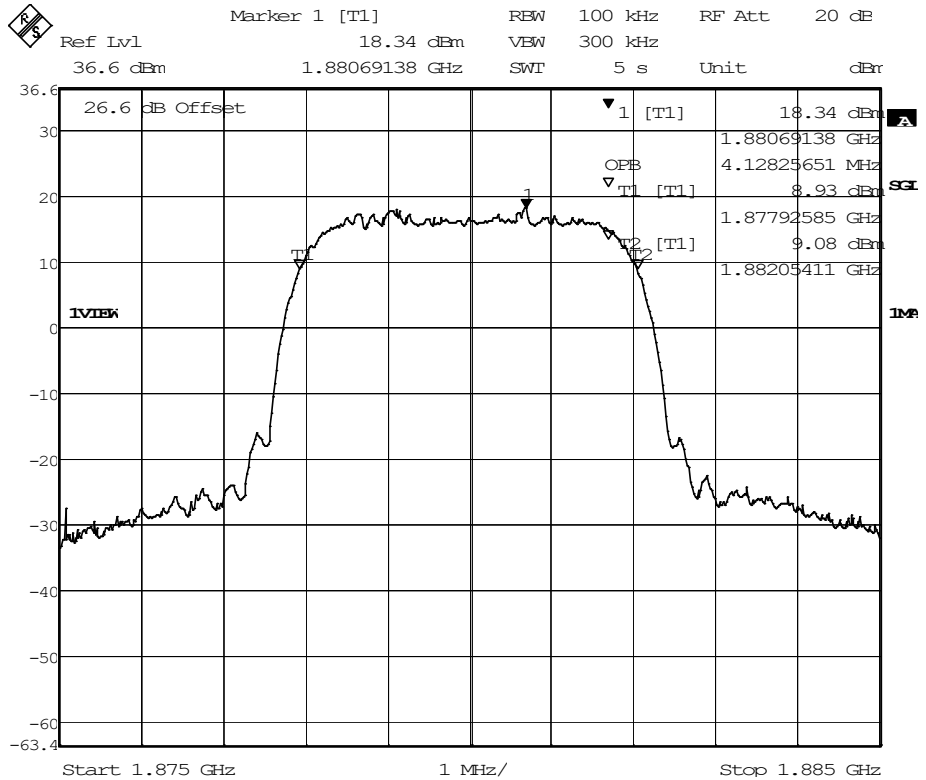

Date: 28.AUG.2021 15:06:17

### HSUPA FDD2 Subtest 1, Channel = mid

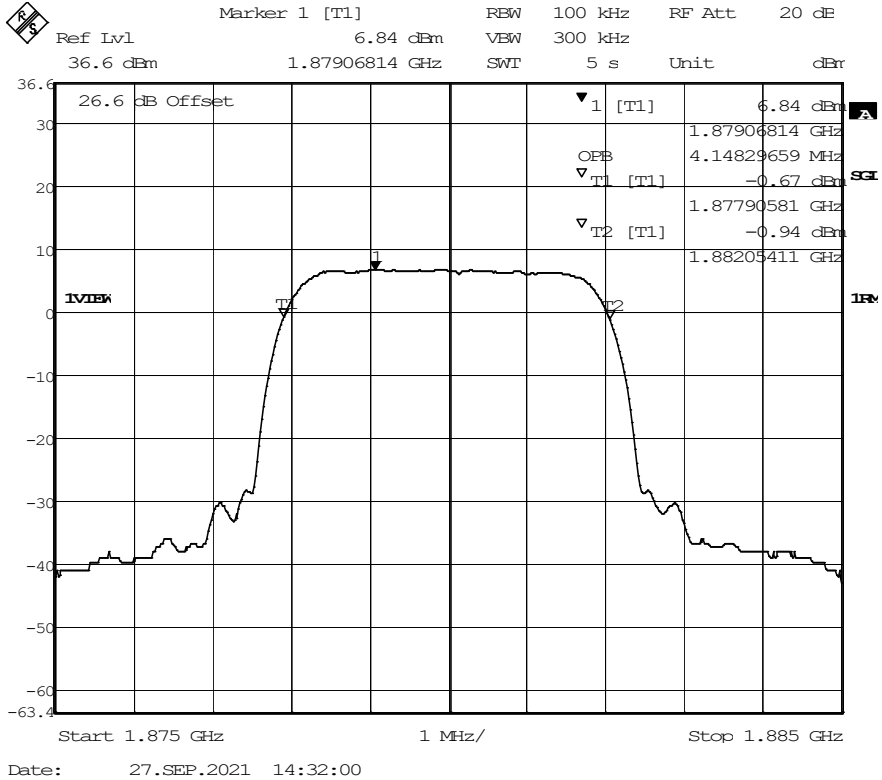

### LTE eFDD2 QPSK 10MHz, Channel = mid

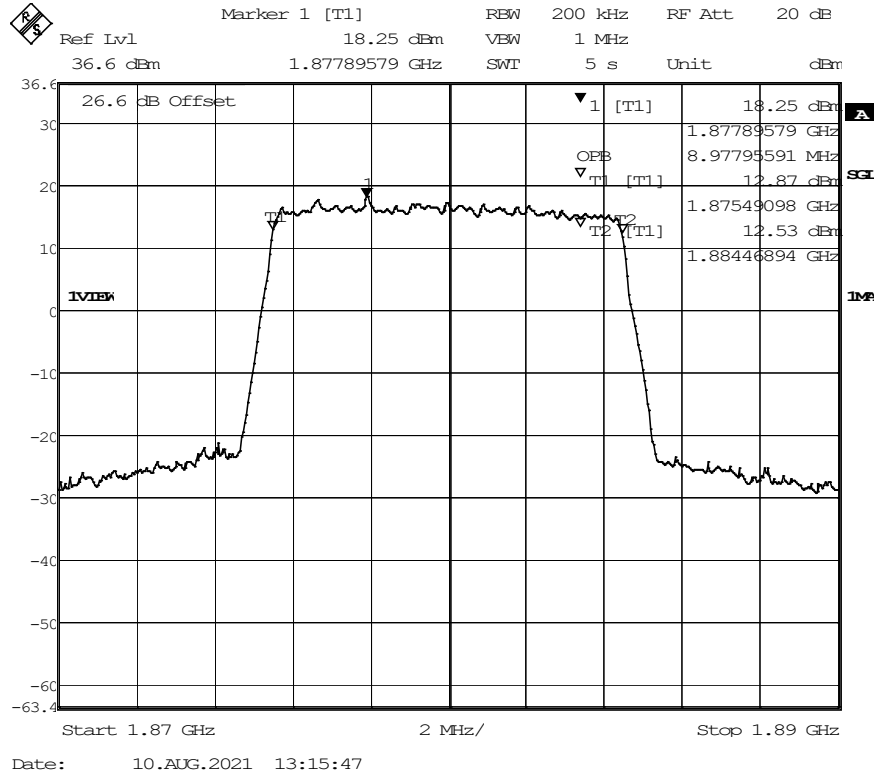

## 5.12.5 TEST EQUIPMENT USED

- Radio Lab



## 5.13 BAND EDGE COMPLIANCE

Standard **FCC PART 24 Subpart E**

**The test was performed according to:**  
ANSI C63.26: 2015

### 5.13.1 TEST DESCRIPTION

This test case is intended to demonstrate compliance to the applicable conducted spurious emission test case per § 2.1051 and RSS-GEN 6.13. The limit comes from the applicable rule part and ISSED RSS-Standard for the operating band of the cellular device.

The EUT was connected to the test setup according to the following diagram:

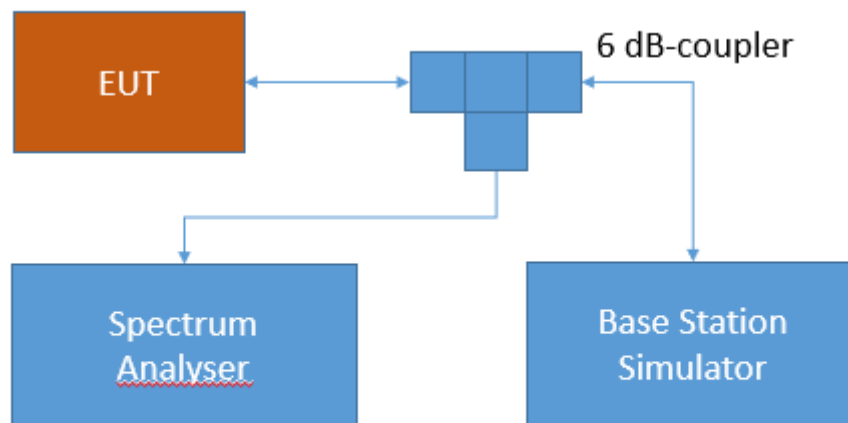

Test Setup FCC Part 22/24/27/90 Cellular;  
Band edge compliance

The attenuation of the measuring and stimulus path are known for each measured frequency and are considered.

The Spectrum Analyzer settings can be directly found in the measurement diagrams.

### 5.13.2 TEST REQUIREMENTS / LIMITS

#### **FCC Part 2.1051; Measurement required: Spurious emissions at antenna terminal:**

The radio frequency voltage or powers generated within the equipment and appearing on a spurious frequency shall be checked at the equipment output terminals when properly loaded with a suitable artificial antenna. Curves or equivalent data shall show the magnitude of each harmonic and other spurious emission that can be detected when the equipment is operated under the conditions specified in §2.1049 as appropriate. The magnitude of spurious emissions which are attenuated more than 20 dB below the permissible value need not be specified.

## Part 24, Subpart E – Broadband PCS

### §24.238 – Emission limitations for Broadband PCS equipment

- a) Out of band emissions. The power of any emission outside of the authorized operating frequency ranges must be attenuated below the transmitting power (P) by a factor of at least  $43 + 10 \log(P)$  dB.
- b) Measurement procedure. Compliance with these rules is based on the use of measurement instrumentation employing a resolution bandwidth of 1 MHz or greater. However, in the 1 MHz bands immediately outside and adjacent to the frequency block a resolution bandwidth of at least one percent of the emission bandwidth of the fundamental emission of the transmitter may be employed. A narrower resolution bandwidth is permitted in all cases to improve measurement accuracy provided the measured power is integrated over the full required measurement bandwidth (i.e. 1 MHz or 1 percent of emission bandwidth, as specified). The emission bandwidth is defined as the width of the signal between two points, one below the carrier center frequency and one above the carrier center frequency, outside of which all emissions are attenuated at least 26 dB below the transmitter power.

### RSS-133; 6.5 Transmitter Unwanted Emissions

Mobile and base station equipment shall comply with the limits in (1) and (2) below.

1. In the 1.0 MHz bands immediately outside and adjacent to the equipment's operating frequency block, the emission power per any 1% of the emission bandwidth shall be attenuated (in dB) below the transmitter output power P (dBW) by at least  $43 + 10 \log_{10}P$  (watts).
2. After the first 1.0 MHz, the emission power in any 1 MHz bandwidth shall be attenuated (in dB) below the transmitter output power P (dBW) by at least  $43 + 10 \log_{10}P$  (watts). If the measurement is performed using 1% of the emission bandwidth, power integration over 1.0 MHz is required.

### 5.13.3 TEST PROTOCOL

Ambient temperature: 20 - 28 °C  
 Relative humidity: 30 - 45 %

Radio Technology	Channel	Re-source Blocks	Bandwidth [MHz]	Peak [dBm]	Average [dBm]	RMS [dBm]	Limit /dBm	Margin to Limit /dB
GSM 1900	low	-	0.2	-19.62	-40.9	-31.73	-13	18.73
GSM 1900	high	-	0.2	-23.22	-40.9	-33.86	-13	20.86
GSM 1900 EDGE	low	-	0.2	-28.28	-45.13	-37.31	-13	24.31
GSM 1900 EDGE	high	-	0.2	-32.36	-49.45	-39.85	-13	26.85
FDD II	low	-	5	-18.72	-28.08	-27.14	-13	14.14
FDD II	high	-	5	-21.17	-31.73	-31.01	-13	18.01
FDD II HSDPA Subtest 1	low	-	5	-21.02	-29.72	-28.86	-13	15.86
FDD II HSDPA Subtest 1	high	-	5	-20.97	-31.36	-30.34	-13	17.34
FDD II HSUPA Subtest 1	low	-	5	-17.34	-26.30	-25.52	-13	12.52
FDD II HSUPA Subtest 1	high	-	5	-21.26	-31.01	-30.34	-13	17.34
FDD II HSUPA Subtest 5	low	-	5	-18.44	-26.50	-25.71	-13	12.71
FDD II HSUPA Subtest 5	high	-	5	-20.53	-31.01	-30.02	-13	17.02
LTE eFDD 2 QPSK	low	6	1.4	-18.51	-28.34	-27.14	-13	14.14
LTE eFDD 2 QPSK	high	6	1.4	-20.68	-29.72	-28.86	-13	15.86
LTE eFDD 2 16QAM	low	6	1.4	-18.57	-29.72	-28.86	-13	15.86
LTE eFDD 2 16QAM	high	6	1.4	-19.66	-31.36	-30.34	-13	17.34
LTE eFDD 2 QPSK	low	15	3	-15.74	-28.08	-26.5	-13	13.5
LTE eFDD 2 QPSK	high	15	3	-17.74	-31.01	-29.14	-13	16.14
LTE eFDD 2 16QAM	low	15	3	-17.73	-30.34	-28.60	-13	15.6
LTE eFDD 2 16QAM	high	15	3	-18.52	-32.52	-30.67	-13	17.67
LTE eFDD 2 QPSK	low	25	5	-15.43	-29.72	-27.84	-13	14.84
LTE eFDD 2 QPSK	high	25	5	-16.65	-32.52	-30.34	-13	17.34
LTE eFDD 2 16QAM	low	25	5	-12.16	-28.08	-25.9	-13	12.9
LTE eFDD 2 16QAM	high	25	5	-14.18	-30.67	-28.34	-13	15.34
LTE eFDD 2 QPSK	low	50	10	-17.5	-31.01	-30.02	-13	17.02
LTE eFDD 2 QPSK	high	50	10	-19.32	-34.36	-32.94	-13	19.94
LTE eFDD 2 16QAM	low	12	10	-15.46	-29.42	-28.34	-13	15.34
LTE eFDD 2 16QAM	high	12	10	-18.1	-32.94	-31.73	-13	18.73
LTE eFDD 2 QPSK	low	75	15	-18.36	-31.36	-30.34	-13	17.34
LTE eFDD 2 QPSK	high	75	15	-16	-32.94	-31.36	-13	18.36
LTE eFDD 2 16QAM	low	18	15	-13.99	-27.6	-26.3	-13	13.3
LTE eFDD 2 16QAM	high	18	15	-16.04	-31.36	-30.02	-13	17.02
LTE eFDD 2 QPSK	low	100	20	-22.09	-33.86	-32.94	-13	19.94
LTE eFDD 2 QPSK	high	100	20	-21.17	-33.39	-32.52	-13	19.52
LTE eFDD 2 16QAM	low	18	20	-15.21	-26.3	-25.34	-13	12.34
LTE eFDD 2 16QAM	high	18	20	-15.05	-31.36	-30.34	-13	17.34

Remark: Please see next sub-clause for the measurement plot.

### 5.13.4 MEASUREMENT PLOT (EXAMPLE PLOT, SHOWING WORST CASE, IF APPLICABLE)

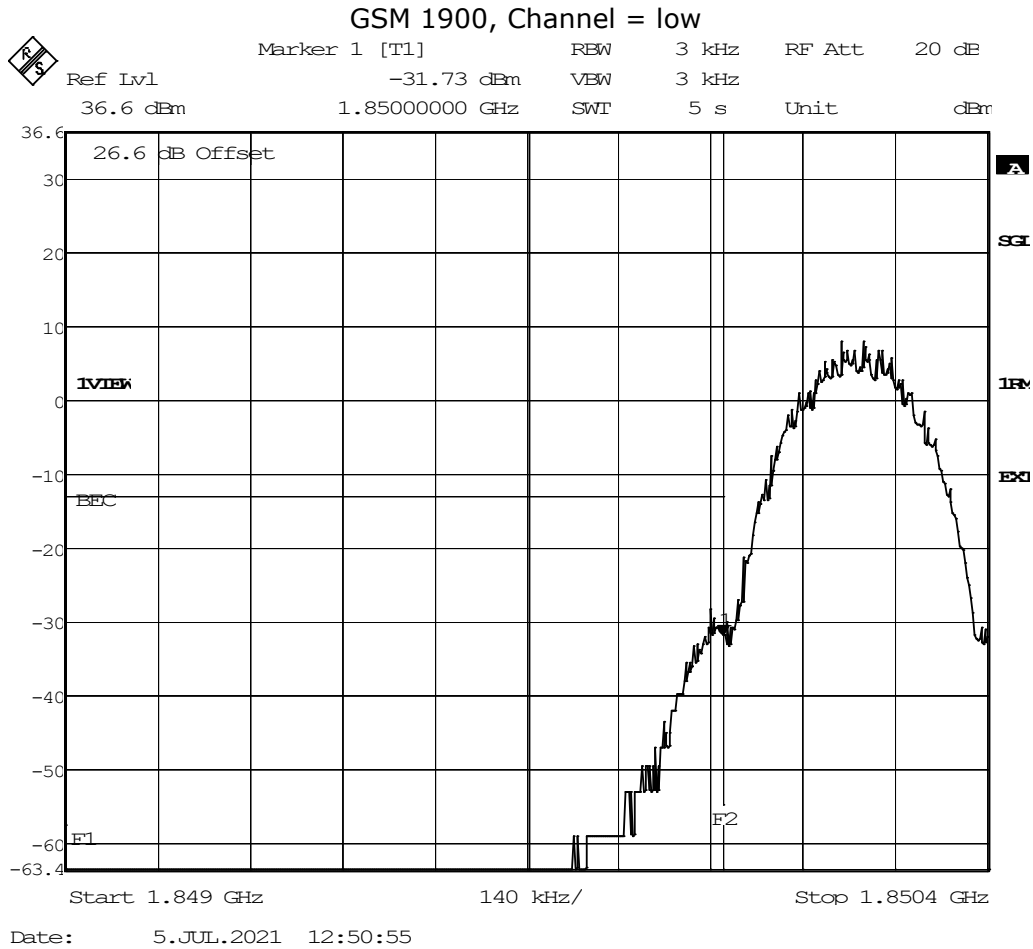

### EDGE 1900, Channel = low



### WCDMA FDD2, Channel = low

	Marker 1 [T1]	RBW	50 kHz	RF Att	20 dB
	Ref Lvl	-27.14 dBm	VBW	50 kHz	
	36.6 dBm	1.8500000 GHz	SWT	5 s	Unit dBm

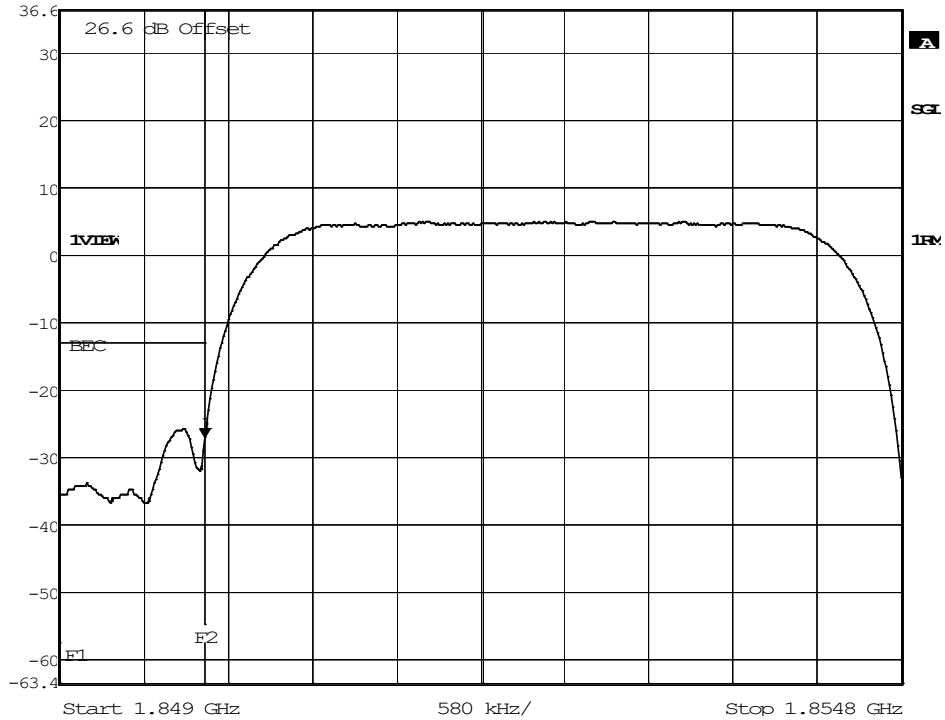

Date: 15.SEP.2021 15:12:11

### HSDPA FDD2, Channel = low

	Marker 1 [T1]	RBW	50 kHz	RF Att	20 dB
	Ref Lvl	-28.86 dBm	VBW	50 kHz	
	36.6 dBm	1.8500000 GHz	SWT	5 s	Unit dBm

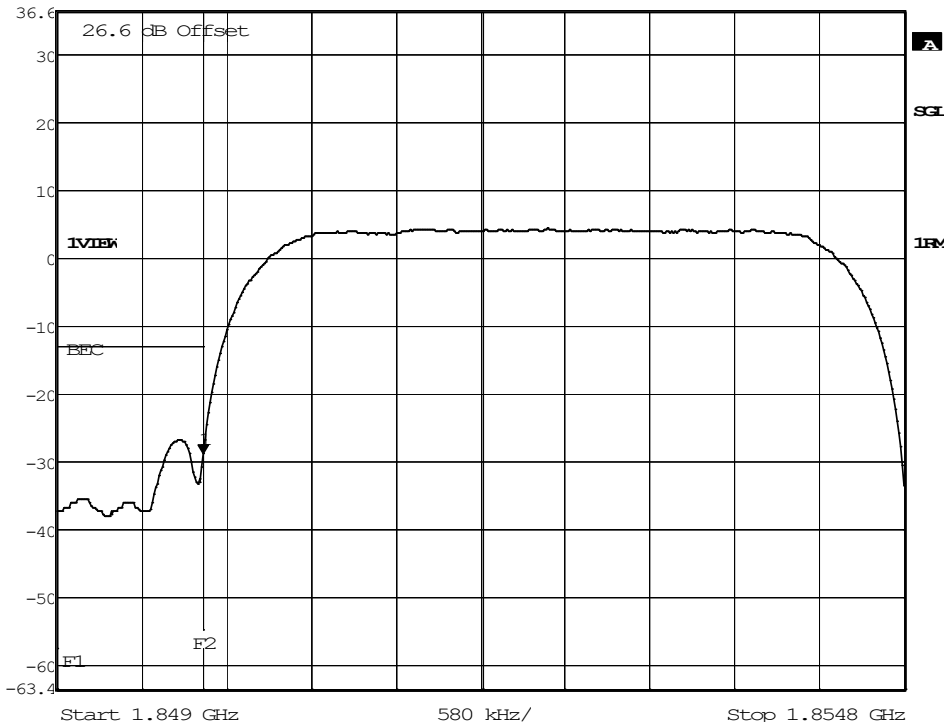

Date: 28.AUG.2021 14:57:19

### HSUPA FDD2 Subtest 5, Channel = low

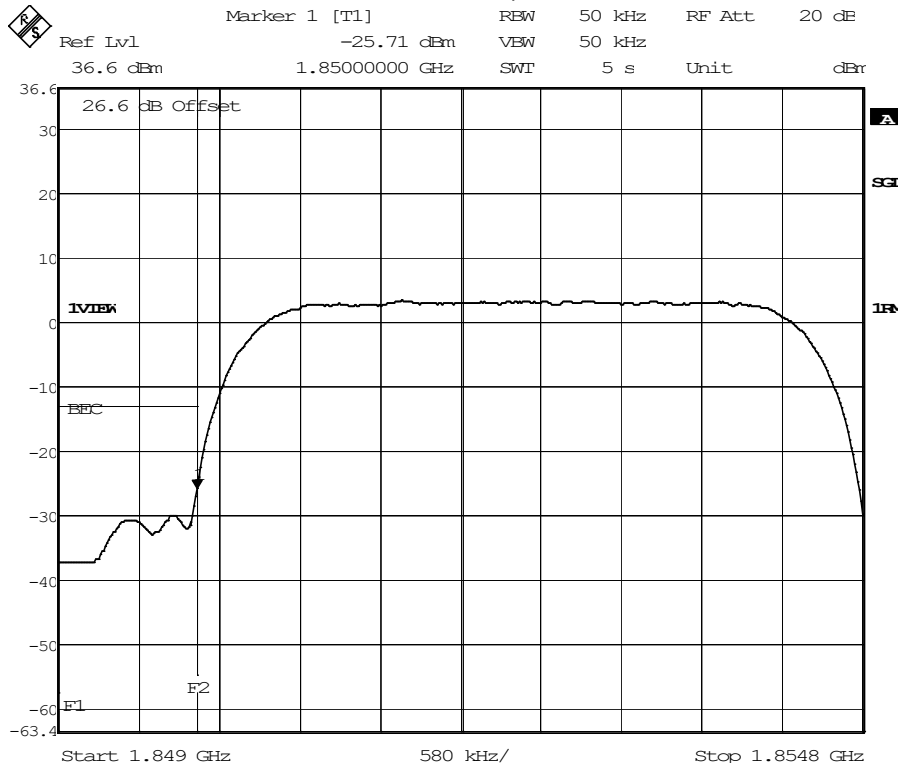

Date: 15.SEP.2021 14:09:13

### LTE eFDD2 16QAM 20MHz, Channel = low

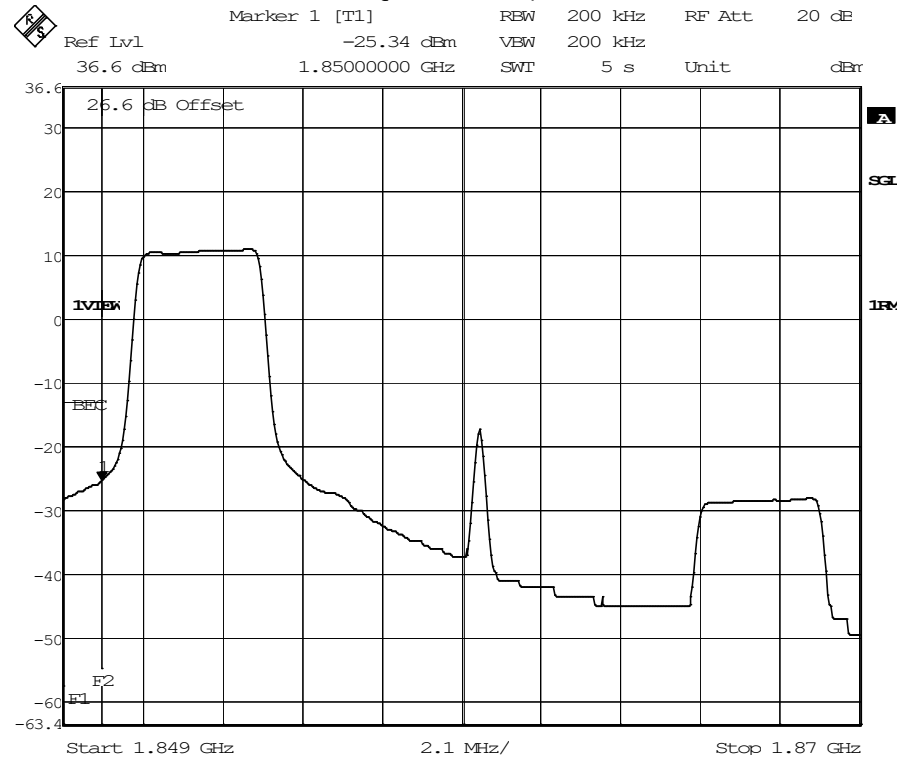

Date: 26.AUG.2021 14:17:25

## 5.13.5 TEST EQUIPMENT USED

- Radio Lab

## 5.14 PEAK TO AVERAGE RATIO

Standard **FCC PART 24 Subpart E**

**The test was performed according to:**  
ANSI C63.26: 2015

### 5.14.1 TEST DESCRIPTION

This test case is intended to demonstrate compliance of the EUT to the peak-to-average limits and requirements of the applicable rule part and ISED RSS-Standard for the operating band of the cellular device.

The EUT was connected to the test setup according to the following diagram:

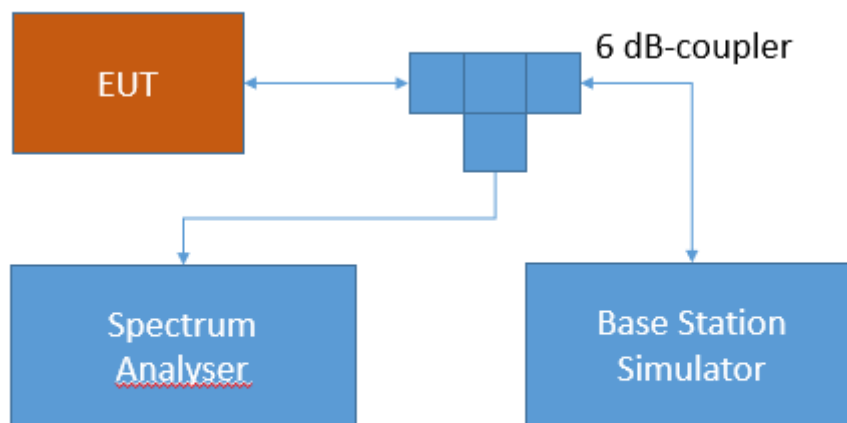

Test Setup FCC Part 22/24/27/90 Cellular;  
Peak-average ratio

The attenuation of the measuring and stimulus path are known for each measured frequency and are considered.

The Spectrum Analyser settings can be directly found in the measurement diagrams. The internal CCDF (complementary cumulative distribution function) of the spectrum analyser is used for this measurement

### 5.14.2 TEST REQUIREMENTS / LIMITS

#### **FCC Part 24, § 24.232**

(d) Power measurements for transmissions by stations authorized under this section may be made either in accordance with a Commission-approved average power technique or in compliance with paragraph (e) of this section. In both instances, equipment employed must be authorized in accordance with the provisions of §24.51. In measuring transmissions in this

band using an average power technique, the peak-to-average ratio (PAR) of the transmission may not exceed 13 dB.

**RSS-133; 6.4 Transmitter Output Power and Equivalent Isotropically Radiated Power**

In addition, the peak-to-average power ratio (PAPR) of the transmitter shall not exceed 13 dB for more than 0.1% of the time using a signal corresponding to the highest PAPR during periods of continuous transmission.

**5.14.3 TEST PROTOCOL**

Ambient temperature: 20 - 28 °C  
Relative humidity: 30 - 45 %

Radio Technology	Channel	Re-source Blocks	Bandwidth [MHz]	Peak to Average Ratio	Limit (IC) [dB]
GSM 1900	low	-	0.2	0.68	13
GSM 1900	mid	-	0.2	0.65	13
GSM 1900	high	-	0.2	0.67	13
GSM 1900 EDGE	low	-	0.2	3.31	13
GSM 1900 EDGE	mid	-	0.2	3.12	13
GSM 1900 EDGE	high	-	0.2	3.38	13
FDD II	low	-	5	5.57	13
FDD II	mid	-	5	5.32	13
FDD II	high	-	5	5.21	13
FDD II HSDPA Subtest 1	low	-	5	5.23	13
FDD II HSDPA Subtest 1	mid	-	5	5.51	13
FDD II HSDPA Subtest 1	high	-	5	5.62	13
FDD II HSUPA Subtest 1	low	-	5	6.03	13
FDD II HSUPA Subtest 1	mid	-	5	6.65	13
FDD II HSUPA Subtest 1	high	-	5	6.60	13
FDD II HSUPA Subtest 5	low	-	5	7.07	13
FDD II HSUPA Subtest 5	mid	-	5	6.94	13
FDD II HSUPA Subtest 5	high	-	5	6.30	13
LTE eFDD 2 QPSK	low	6	1.4	5.97	13
LTE eFDD 2 QPSK	mid	6	1.4	5.74	13
LTE eFDD 2 QPSK	high	6	1.4	5.77	13
LTE eFDD 2 16QAM	low	6	1.4	6.58	13
LTE eFDD 2 16QAM	mid	6	1.4	6.20	13
LTE eFDD 2 16QAM	high	6	1.4	6.26	13

Remark: Please see next sub-clause for the measurement plot.



### 5.14.4 MEASUREMENT PLOT (EXAMPLE PLOT, SHOWING WORST CASE, IF APPLICABLE)

LTE eFDD2 16QAM, Channel = low

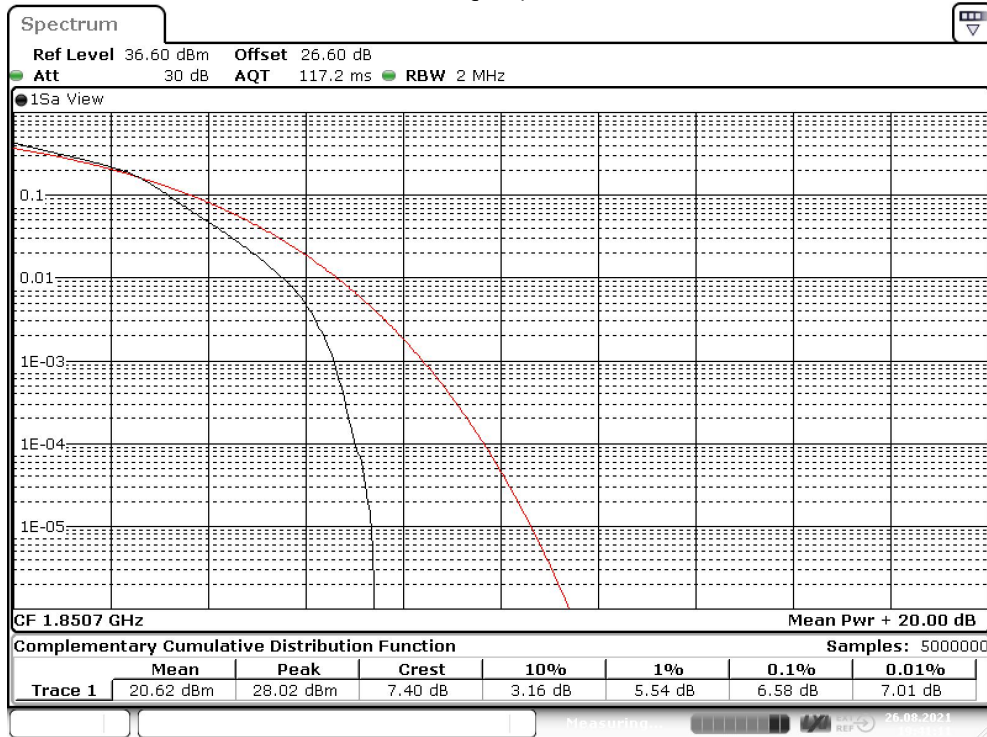

Date: 26.AUG.2021 19:41:12

### 5.14.5 TEST EQUIPMENT USED

- Radio Lab

## 5.15 RF OUTPUT POWER

Standard **FCC PART 27 Subpart C**

**The test was performed according to:**  
ANSI C63.26: 2015

### 5.15.1 TEST DESCRIPTION

This test case is intended to demonstrate compliance to the applicable RF Output power test case per § 2.1046 and RSS-GEN 6.12. The limit and the requirements come from the applicable rule part and ISED RSS-Standard for the operating band of the cellular device.

The EUT was connected to the test setup according to the following diagram:

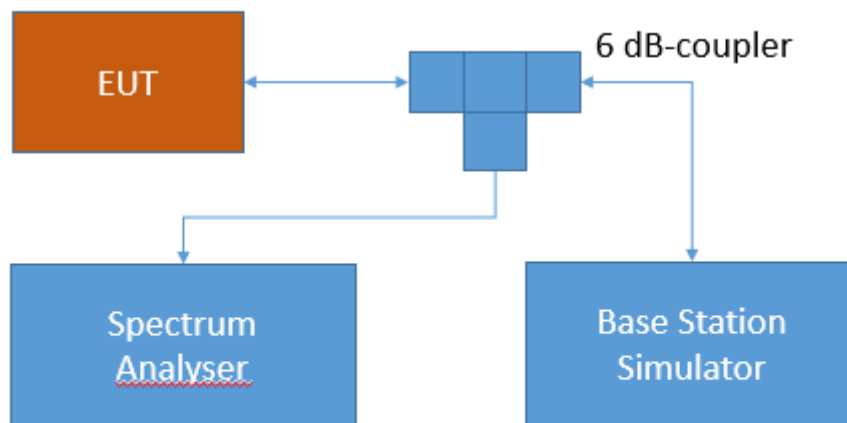

Test Setup FCC Part 22/24/27/90 Cellular;  
RF Output power

The attenuation of the measuring and stimulus path are known for each measured frequency and are considered.

The Spectrum Analyser settings can be directly found in the measurement diagrams.

## 5.15.2 TEST REQUIREMENTS / LIMITS

### **FCC Part 27; Miscellaneous Wireless Communication Services**

#### **Subpart C – Technical standards**

#### **§ 27.50 - Power limits and duty cycle**

##### **Band 13:**

(b) The following power limits apply to transmitters operating in the 746-758 MHz, 775-788 MHz and 805-806 MHz bands:

(10) Portable stations (hand-held devices) transmitting in the 746-757 MHz, 776-788 MHz, and 805-806 MHz bands are limited to 3 watts ERP.

##### **RSS-130; 4.6.3 Transmitter Output Power**

The e.r.p. shall not exceed 3 watts for portable equipment and indoor fixed subscriber equipment.

##### **Band 12:**

(c) The following power and antenna height requirements apply to stations transmitting in the 600 MHz band and the 698-746 MHz band:

(10) Portable stations (hand-held devices) in the 600 MHz uplink band and the 698-746 MHz band, and fixed and mobile stations in the 600 MHz uplink band are limited to 3 watts ERP.

##### **RSS-130; 4.6.3 Transmitter Output Power**

The e.r.p. shall not exceed 3 watts for portable equipment and indoor fixed subscriber equipment.

##### **Band 4/10/66:**

(d) The following power and antenna height requirements apply to stations transmitting in the 1695-1710 MHz, 1710-1755 MHz, 1755-1780 MHz, 1915-1920 MHz, 1995-2000 MHz, 2000-2020 MHz, 2110-2155 MHz, 2155-2180 MHz and 2180-2200 MHz bands:

(4) Fixed, mobile, and portable (hand-held) stations operating in the 1710-1755 MHz band and mobile and portable stations operating in the 1695-1710 MHz and 1755-1780 MHz bands are limited to 1 watt EIRP. Fixed stations operating in the 1710-1755 MHz band are limited to a maximum antenna height of 10 meters above ground. Mobile and portable stations operating in these bands must employ a means for limiting power to the minimum.

##### **RSS-139; 6.5 Transmitter Output Power**

The equivalent isotropically radiated power (e.i.r.p.) for mobile and portable transmitters shall not exceed one watt.

##### **Band 17:**

(c) The following power requirements apply to stations transmitting in the 600 MHz band and the 698-746 MHz band:

(10) Portable stations (hand-held devices) in the 600 MHz uplink band and the 698-746 MHz band, and fixed and mobile stations in the 600 MHz uplink band are limited to 3 watts ERP.

**RSS-130; 4.6.3 Transmitter Output**

The e.r.p. shall not exceed 3 watts for portable equipment and indoor fixed subscriber equipment.

**Band 7:**

(h) The following power limits shall apply in the BRS and EBS:

(2) Mobile and other user stations. Mobile stations are limited to 2.0 watts EIRP. All user stations are limited to 2.0 watts transmitter output power.

**RSS-199; 4.4 Transmitter output power and equivalent isotropically power (e.i.r.p.)**

The transmitter output power shall be measured in terms of average value.

For mobile subscriber equipment, the e.i.r.p. shall not exceed 2 W. For fixed subscriber equipment, the transmitter output power shall not exceed 2 W and the e.i.r.p. shall be limited to 40 W.

For equipment with multiple antennas, the transmitter output power and e.i.r.p shall be measured according to ANSI C63.26-2015.

**5.15.3 TEST PROTOCOL**

Ambient temperature: 20 - 28 °C  
Relative humidity: 30 - 45 %

Radio Technology	Channel	Resource Blocks	Bandwidth [MHz]	RMS Conducted Power (dBm)	FCC Limit (W)	IC Limit (W)	Maximum Antenna Gain FCC (dBi)	Maximum Antenna Gain IC (dBi)
LTE eFDD 4 QPSK	low	1	1.4	23.13	1 (EIRP)	1 (EIRP)	6.87	6.87
LTE eFDD 4 QPSK	low	3	1.4	22.54	1 (EIRP)	1 (EIRP)	7.46	7.46
LTE eFDD 4 QPSK	low	6	1.4	21.57	1 (EIRP)	1 (EIRP)	8.43	8.43
LTE eFDD 4 QPSK	mid	1	1.4	23.14	1 (EIRP)	1 (EIRP)	6.86	6.86
LTE eFDD 4 QPSK	mid	3	1.4	22.90	1 (EIRP)	1 (EIRP)	7.10	7.10
LTE eFDD 4 QPSK	mid	6	1.4	22.03	1 (EIRP)	1 (EIRP)	7.97	7.97
LTE eFDD 4 QPSK	high	1	1.4	23.50	1 (EIRP)	1 (EIRP)	6.50	6.50
LTE eFDD 4 QPSK	high	3	1.4	22.99	1 (EIRP)	1 (EIRP)	7.01	7.01
LTE eFDD 4 QPSK	high	6	1.4	22.02	1 (EIRP)	1 (EIRP)	7.98	7.98
LTE eFDD 4 16QAM	low	1	1.4	21.28	1 (EIRP)	1 (EIRP)	8.72	8.72
LTE eFDD 4 16QAM	low	6	1.4	20.31	1 (EIRP)	1 (EIRP)	9.69	9.69
LTE eFDD 4 16QAM	mid	1	1.4	22.28	1 (EIRP)	1 (EIRP)	7.72	7.72
LTE eFDD 4 16QAM	mid	6	1.4	20.53	1 (EIRP)	1 (EIRP)	9.47	9.47
LTE eFDD 4 16QAM	high	1	1.4	22.19	1 (EIRP)	1 (EIRP)	7.81	7.81
LTE eFDD 4 16QAM	high	6	1.4	20.43	1 (EIRP)	1 (EIRP)	9.57	9.57
LTE eFDD 4 QPSK	low	1	3	23.37	1 (EIRP)	1 (EIRP)	6.63	6.63
LTE eFDD 4 QPSK	low	15	3	22.07	1 (EIRP)	1 (EIRP)	7.93	7.93
LTE eFDD 4 QPSK	mid	1	3	23.65	1 (EIRP)	1 (EIRP)	6.35	6.35
LTE eFDD 4 QPSK	mid	15	3	22.49	1 (EIRP)	1 (EIRP)	7.51	7.51
LTE eFDD 4 QPSK	high	1	3	23.80	1 (EIRP)	1 (EIRP)	6.20	6.20

LTE eFDD 4 QPSK	high	15	3	22.56	1 (EIRP)	1 (EIRP)	7.44	7.44
LTE eFDD 4 16QAM	low	1	3	21.78	1 (EIRP)	1 (EIRP)	8.22	8.22
LTE eFDD 4 16QAM	low	15	3	20.51	1 (EIRP)	1 (EIRP)	9.49	9.49
LTE eFDD 4 16QAM	mid	1	3	21.94	1 (EIRP)	1 (EIRP)	8.06	8.06
LTE eFDD 4 16QAM	mid	15	3	20.96	1 (EIRP)	1 (EIRP)	9.04	9.04
LTE eFDD 4 16QAM	high	1	3	22.41	1 (EIRP)	1 (EIRP)	7.59	7.59
LTE eFDD 4 16QAM	high	15	3	20.76	1 (EIRP)	1 (EIRP)	9.24	9.24
LTE eFDD 4 QPSK	low	1	5	23.29	1 (EIRP)	1 (EIRP)	6.71	6.71
LTE eFDD 4 QPSK	low	12	5	21.97	1 (EIRP)	1 (EIRP)	8.03	8.03
LTE eFDD 4 QPSK	low	25	5	22.00	1 (EIRP)	1 (EIRP)	8.00	8.00
LTE eFDD 4 QPSK	mid	1	5	23.68	1 (EIRP)	1 (EIRP)	6.32	6.32
LTE eFDD 4 QPSK	mid	12	5	22.48	1 (EIRP)	1 (EIRP)	7.52	7.52
LTE eFDD 4 QPSK	mid	25	5	22.50	1 (EIRP)	1 (EIRP)	7.50	7.50
LTE eFDD 4 QPSK	high	1	5	23.67	1 (EIRP)	1 (EIRP)	6.33	6.33
LTE eFDD 4 QPSK	high	12	5	22.55	1 (EIRP)	1 (EIRP)	7.45	7.45
LTE eFDD 4 QPSK	high	25	5	22.53	1 (EIRP)	1 (EIRP)	7.47	7.47
LTE eFDD 4 16QAM	low	1	5	21.49	1 (EIRP)	1 (EIRP)	8.51	8.51
LTE eFDD 4 16QAM	low	25	5	20.55	1 (EIRP)	1 (EIRP)	9.45	9.45
LTE eFDD 4 16QAM	mid	1	5	22.06	1 (EIRP)	1 (EIRP)	7.94	7.94
LTE eFDD 4 16QAM	mid	25	5	20.87	1 (EIRP)	1 (EIRP)	9.13	9.13
LTE eFDD 4 16QAM	high	1	5	22.16	1 (EIRP)	1 (EIRP)	7.84	7.84
LTE eFDD 4 16QAM	high	25	5	20.93	1 (EIRP)	1 (EIRP)	9.07	9.07
LTE eFDD 4 QPSK	low	1	10	23.33	1 (EIRP)	1 (EIRP)	6.67	6.67
LTE eFDD 4 QPSK	low	50	10	22.01	1 (EIRP)	1 (EIRP)	7.99	7.99
LTE eFDD 4 QPSK	mid	1	10	23.91	1 (EIRP)	1 (EIRP)	6.09	6.09
LTE eFDD 4 QPSK	mid	50	10	22.69	1 (EIRP)	1 (EIRP)	7.31	7.31
LTE eFDD 4 QPSK	high	1	10	23.80	1 (EIRP)	1 (EIRP)	6.20	6.20
LTE eFDD 4 QPSK	high	50	10	22.71	1 (EIRP)	1 (EIRP)	7.29	7.29
LTE eFDD 4 16QAM	low	1	10	22.27	1 (EIRP)	1 (EIRP)	7.73	7.73
LTE eFDD 4 16QAM	low	12	10	21.96	1 (EIRP)	1 (EIRP)	8.04	8.04
LTE eFDD 4 16QAM	mid	1	10	22.22	1 (EIRP)	1 (EIRP)	7.78	7.78
LTE eFDD 4 16QAM	mid	12	10	22.09	1 (EIRP)	1 (EIRP)	7.91	7.91
LTE eFDD 4 16QAM	high	1	10	22.18	1 (EIRP)	1 (EIRP)	7.82	7.82
LTE eFDD 4 16QAM	high	12	10	21.79	1 (EIRP)	1 (EIRP)	8.21	8.21
LTE eFDD 4 QPSK	low	1	15	22.52	1 (EIRP)	1 (EIRP)	7.48	7.48
LTE eFDD 4 QPSK	low	36	15	21.53	1 (EIRP)	1 (EIRP)	8.47	8.47
LTE eFDD 4 QPSK	low	75	15	21.63	1 (EIRP)	1 (EIRP)	8.37	8.37
LTE eFDD 4 QPSK	mid	1	15	23.79	1 (EIRP)	1 (EIRP)	6.21	6.21
LTE eFDD 4 QPSK	mid	36	15	22.72	1 (EIRP)	1 (EIRP)	7.28	7.28
LTE eFDD 4 QPSK	mid	75	15	22.65	1 (EIRP)	1 (EIRP)	7.35	7.35
LTE eFDD 4 QPSK	high	1	15	22.62	1 (EIRP)	1 (EIRP)	7.38	7.38
LTE eFDD 4 QPSK	high	36	15	21.71	1 (EIRP)	1 (EIRP)	8.29	8.29
LTE eFDD 4 QPSK	high	75	15	22.23	1 (EIRP)	1 (EIRP)	7.77	7.77
LTE eFDD 4 16QAM	low	1	15	21.91	1 (EIRP)	1 (EIRP)	8.09	8.09
LTE eFDD 4 16QAM	low	18	15	20.76	1 (EIRP)	1 (EIRP)	9.24	9.24
LTE eFDD 4 16QAM	mid	1	15	21.52	1 (EIRP)	1 (EIRP)	8.48	8.48
LTE eFDD 4 16QAM	mid	18	15	20.96	1 (EIRP)	1 (EIRP)	9.04	9.04

LTE eFDD 4 16QAM	high	1	15	22.73	1 (EIRP)	1 (EIRP)	7.27	7.27
LTE eFDD 4 16QAM	high	18	15	21.24	1 (EIRP)	1 (EIRP)	8.76	8.76
LTE eFDD 4 QPSK	low	1	20	23.46	1 (EIRP)	1 (EIRP)	6.54	6.54
LTE eFDD 4 QPSK	low	100	20	22.61	1 (EIRP)	1 (EIRP)	7.39	7.39
LTE eFDD 4 QPSK	mid	1	20	23.96	1 (EIRP)	1 (EIRP)	6.04	6.04
LTE eFDD 4 QPSK	mid	100	20	22.67	1 (EIRP)	1 (EIRP)	7.33	7.33
LTE eFDD 4 QPSK	high	1	20	22.97	1 (EIRP)	1 (EIRP)	7.03	7.03
LTE eFDD 4 QPSK	high	100	20	21.79	1 (EIRP)	1 (EIRP)	8.21	8.21
LTE eFDD 4 16QAM	low	1	20	22.53	1 (EIRP)	1 (EIRP)	7.47	7.47
LTE eFDD 4 16QAM	low	18	20	21.84	1 (EIRP)	1 (EIRP)	8.16	8.16
LTE eFDD 4 16QAM	mid	1	20	22.44	1 (EIRP)	1 (EIRP)	7.56	7.56
LTE eFDD 4 16QAM	mid	18	20	21.64	1 (EIRP)	1 (EIRP)	8.36	8.36
LTE eFDD 4 16QAM	high	1	20	22.46	1 (EIRP)	1 (EIRP)	7.54	7.54
LTE eFDD 4 16QAM	high	18	20	21.94	1 (EIRP)	1 (EIRP)	8.06	8.06
LTE eFDD 12 QPSK	low	1	1.4	23.86	3 (ERP)	3 (ERP)	10.91	10.91
LTE eFDD 12 QPSK	low	3	1.4	23.24	3 (ERP)	3 (ERP)	11.53	11.53
LTE eFDD 12 QPSK	low	6	1.4	22.36	3 (ERP)	3 (ERP)	12.41	12.41
LTE eFDD 12 QPSK	mid	1	1.4	23.48	3 (ERP)	3 (ERP)	11.29	11.29
LTE eFDD 12 QPSK	mid	3	1.4	23.31	3 (ERP)	3 (ERP)	11.46	11.46
LTE eFDD 12 QPSK	mid	6	1.4	22.34	3 (ERP)	3 (ERP)	12.43	12.43
LTE eFDD 12 QPSK	high	1	1.4	23.77	3 (ERP)	3 (ERP)	11.00	11.00
LTE eFDD 12 QPSK	high	3	1.4	23.41	3 (ERP)	3 (ERP)	11.36	11.36
LTE eFDD 12 QPSK	high	6	1.4	22.30	3 (ERP)	3 (ERP)	12.47	12.47
LTE eFDD 12 16QAM	low	1	1.4	21.74	3 (ERP)	3 (ERP)	13.03	13.03
LTE eFDD 12 16QAM	low	6	1.4	20.29	3 (ERP)	3 (ERP)	14.48	14.48
LTE eFDD 12 16QAM	mid	1	1.4	22.16	3 (ERP)	3 (ERP)	12.61	12.61
LTE eFDD 12 16QAM	mid	6	1.4	20.37	3 (ERP)	3 (ERP)	14.40	14.40
LTE eFDD 12 16QAM	high	1	1.4	21.90	3 (ERP)	3 (ERP)	12.87	12.87
LTE eFDD 12 16QAM	high	6	1.4	20.19	3 (ERP)	3 (ERP)	14.58	14.58
LTE eFDD 12 QPSK	low	1	3	23.07	3 (ERP)	3 (ERP)	11.70	11.70
LTE eFDD 12 QPSK	low	15	3	21.82	3 (ERP)	3 (ERP)	12.95	12.95
LTE eFDD 12 QPSK	mid	1	3	24.17	3 (ERP)	3 (ERP)	10.60	10.60
LTE eFDD 12 QPSK	mid	15	3	22.82	3 (ERP)	3 (ERP)	11.95	11.95
LTE eFDD 12 QPSK	high	1	3	24.11	3 (ERP)	3 (ERP)	10.66	10.66
LTE eFDD 12 QPSK	high	15	3	22.90	3 (ERP)	3 (ERP)	11.87	11.87
LTE eFDD 12 16QAM	low	1	3	21.97	3 (ERP)	3 (ERP)	12.80	12.80
LTE eFDD 12 16QAM	low	15	3	20.70	3 (ERP)	3 (ERP)	14.07	14.07
LTE eFDD 12 16QAM	mid	1	3	22.31	3 (ERP)	3 (ERP)	12.46	12.46
LTE eFDD 12 16QAM	mid	15	3	20.85	3 (ERP)	3 (ERP)	13.92	13.92
LTE eFDD 12 16QAM	high	1	3	22.47	3 (ERP)	3 (ERP)	12.30	12.30
LTE eFDD 12 16QAM	high	15	3	21.15	3 (ERP)	3 (ERP)	13.62	13.62
LTE eFDD 12 QPSK	low	1	5	23.83	3 (ERP)	3 (ERP)	10.94	10.94
LTE eFDD 12 QPSK	low	12	5	22.73	3 (ERP)	3 (ERP)	12.04	12.04
LTE eFDD 12 QPSK	low	25	5	22.59	3 (ERP)	3 (ERP)	12.18	12.18
LTE eFDD 12 QPSK	mid	1	5	24.11	3 (ERP)	3 (ERP)	10.66	10.66
LTE eFDD 12 QPSK	mid	12	5	22.79	3 (ERP)	3 (ERP)	11.98	11.98
LTE eFDD 12 QPSK	mid	25	5	22.60	3 (ERP)	3 (ERP)	12.17	12.17

LTE eFDD 12 QPSK	high	1	5	23.91	3 (ERP)	3 (ERP)	10.86	10.86
LTE eFDD 12 QPSK	high	12	5	22.70	3 (ERP)	3 (ERP)	12.07	12.07
LTE eFDD 12 QPSK	high	25	5	22.74	3 (ERP)	3 (ERP)	12.03	12.03
LTE eFDD 12 16QAM	low	1	5	21.65	3 (ERP)	3 (ERP)	13.12	13.12
LTE eFDD 12 16QAM	low	25	5	20.78	3 (ERP)	3 (ERP)	13.99	13.99
LTE eFDD 12 16QAM	mid	1	5	22.08	3 (ERP)	3 (ERP)	12.69	12.69
LTE eFDD 12 16QAM	mid	25	5	20.93	3 (ERP)	3 (ERP)	13.84	13.84
LTE eFDD 12 16QAM	high	1	5	22.87	3 (ERP)	3 (ERP)	11.90	11.90
LTE eFDD 12 16QAM	high	25	5	20.84	3 (ERP)	3 (ERP)	13.93	13.93
LTE eFDD 12 QPSK	low	1	10	24.06	3 (ERP)	3 (ERP)	10.71	10.71
LTE eFDD 12 QPSK	low	50	10	22.89	3 (ERP)	3 (ERP)	11.88	11.88
LTE eFDD 12 QPSK	mid	1	10	24.39	3 (ERP)	3 (ERP)	10.38	10.38
LTE eFDD 12 QPSK	mid	50	10	22.86	3 (ERP)	3 (ERP)	11.91	11.91
LTE eFDD 12 QPSK	high	1	10	24.16	3 (ERP)	3 (ERP)	10.61	10.61
LTE eFDD 12 QPSK	high	50	10	22.84	3 (ERP)	3 (ERP)	11.93	11.93
LTE eFDD 12 16QAM	low	1	10	22.33	3 (ERP)	3 (ERP)	12.44	12.44
LTE eFDD 12 16QAM	low	12	10	20.71	3 (ERP)	3 (ERP)	14.06	14.06
LTE eFDD 12 16QAM	mid	1	10	22.41	3 (ERP)	3 (ERP)	12.36	12.36
LTE eFDD 12 16QAM	mid	12	10	21.04	3 (ERP)	3 (ERP)	13.73	13.73
LTE eFDD 12 16QAM	high	1	10	22.64	3 (ERP)	3 (ERP)	12.13	12.13
LTE eFDD 12 16QAM	high	12	10	21.06	3 (ERP)	3 (ERP)	13.71	13.71
LTE eFDD 7 QPSK	low	1	5	22.39	2 (EIRP)	2 (EIRP)	10.61	10.61
LTE eFDD 7 QPSK	low	12	5	21.05	2 (EIRP)	2 (EIRP)	11.95	11.95
LTE eFDD 7 QPSK	low	25	5	20.96	2 (EIRP)	2 (EIRP)	12.04	12.04
LTE eFDD 7 QPSK	mid	1	5	22.33	2 (EIRP)	2 (EIRP)	10.67	10.67
LTE eFDD 7 QPSK	mid	12	5	21.07	2 (EIRP)	2 (EIRP)	11.93	11.93
LTE eFDD 7 QPSK	mid	25	5	21.08	2 (EIRP)	2 (EIRP)	11.92	11.92
LTE eFDD 7 QPSK	high	1	5	22.30	2 (EIRP)	2 (EIRP)	10.7	10.7
LTE eFDD 7 QPSK	high	12	5	21.10	2 (EIRP)	2 (EIRP)	11.9	11.9
LTE eFDD 7 QPSK	high	25	5	21.15	2 (EIRP)	2 (EIRP)	11.85	11.85
LTE eFDD 7 16QAM	low	1	5	21.98	2 (EIRP)	2 (EIRP)	11.02	11.02
LTE eFDD 7 16QAM	low	25	5	20.09	2 (EIRP)	2 (EIRP)	12.91	12.91
LTE eFDD 7 16QAM	mid	1	5	21.28	2 (EIRP)	2 (EIRP)	11.72	11.72
LTE eFDD 7 16QAM	mid	25	5	20.00	2 (EIRP)	2 (EIRP)	13.00	13.00
LTE eFDD 7 16QAM	high	1	5	21.52	2 (EIRP)	2 (EIRP)	11.48	11.48
LTE eFDD 7 16QAM	high	25	5	20.22	2 (EIRP)	2 (EIRP)	12.78	12.78
LTE eFDD 7 QPSK	low	1	10	22.70	2 (EIRP)	2 (EIRP)	10.3	10.3
LTE eFDD 7 QPSK	low	50	10	21.35	2 (EIRP)	2 (EIRP)	11.65	11.65
LTE eFDD 7 QPSK	mid	1	10	22.46	2 (EIRP)	2 (EIRP)	10.54	10.54
LTE eFDD 7 QPSK	mid	50	10	21.32	2 (EIRP)	2 (EIRP)	11.68	11.68
LTE eFDD 7 QPSK	high	1	10	22.47	2 (EIRP)	2 (EIRP)	10.53	10.53
LTE eFDD 7 QPSK	high	50	10	21.15	2 (EIRP)	2 (EIRP)	11.85	11.85
LTE eFDD 7 16QAM	low	1	10	21.61	2 (EIRP)	2 (EIRP)	11.39	11.39
LTE eFDD 7 16QAM	low	50	10	21.20	2 (EIRP)	2 (EIRP)	11.8	11.8
LTE eFDD 7 16QAM	mid	1	10	21.78	2 (EIRP)	2 (EIRP)	11.22	11.22
LTE eFDD 7 16QAM	mid	50	10	21.02	2 (EIRP)	2 (EIRP)	11.98	11.98
LTE eFDD 7 16QAM	high	1	10	21.22	2 (EIRP)	2 (EIRP)	11.78	11.78

LTE eFDD 7 16QAM	high	50	10	20.94	2 (EIRP)	2 (EIRP)	12.06	12.06
LTE eFDD 7 QPSK	low	1	15	22.23	2 (EIRP)	2 (EIRP)	10.77	10.77
LTE eFDD 7 QPSK	low	36	15	21.36	2 (EIRP)	2 (EIRP)	11.64	11.64
LTE eFDD 7 QPSK	low	75	15	20.27	2 (EIRP)	2 (EIRP)	12.73	12.73
LTE eFDD 7 QPSK	mid	1	15	22.47	2 (EIRP)	2 (EIRP)	10.53	10.53
LTE eFDD 7 QPSK	mid	36	15	21.26	2 (EIRP)	2 (EIRP)	11.74	11.74
LTE eFDD 7 QPSK	mid	75	15	21.22	2 (EIRP)	2 (EIRP)	11.78	11.78
LTE eFDD 7 QPSK	high	1	15	22.19	2 (EIRP)	2 (EIRP)	10.81	10.81
LTE eFDD 7 QPSK	high	36	15	21.13	2 (EIRP)	2 (EIRP)	11.87	11.87
LTE eFDD 7 QPSK	high	75	15	21.10	2 (EIRP)	2 (EIRP)	11.9	11.9
LTE eFDD 7 16QAM	low	1	15	21.43	2 (EIRP)	2 (EIRP)	11.57	11.57
LTE eFDD 7 16QAM	low	75	15	20.46	2 (EIRP)	2 (EIRP)	12.54	12.54
LTE eFDD 7 16QAM	mid	1	15	22.09	2 (EIRP)	2 (EIRP)	10.91	10.91
LTE eFDD 7 16QAM	mid	75	15	20.56	2 (EIRP)	2 (EIRP)	12.44	12.44
LTE eFDD 7 16QAM	high	1	15	20.44	2 (EIRP)	2 (EIRP)	12.56	12.56
LTE eFDD 7 16QAM	high	75	15	20.13	2 (EIRP)	2 (EIRP)	12.87	12.87
LTE eFDD 7 QPSK	low	1	20	22.44	2 (EIRP)	2 (EIRP)	10.56	10.56
LTE eFDD 7 QPSK	low	100	20	21.28	2 (EIRP)	2 (EIRP)	11.72	11.72
LTE eFDD 7 QPSK	mid	1	20	22.48	2 (EIRP)	2 (EIRP)	10.52	10.52
LTE eFDD 7 QPSK	mid	100	20	21.17	2 (EIRP)	2 (EIRP)	11.83	11.83
LTE eFDD 7 QPSK	high	1	20	22.02	2 (EIRP)	2 (EIRP)	10.98	10.98
LTE eFDD 7 QPSK	high	100	20	21.06	2 (EIRP)	2 (EIRP)	11.94	11.94
LTE eFDD 7 16QAM	low	1	20	21.70	2 (EIRP)	2 (EIRP)	11.3	11.3
LTE eFDD 7 16QAM	low	100	20	21.36	2 (EIRP)	2 (EIRP)	11.64	11.64
LTE eFDD 7 16QAM	mid	1	20	21.16	2 (EIRP)	2 (EIRP)	11.84	11.84
LTE eFDD 7 16QAM	mid	100	20	21.24	2 (EIRP)	2 (EIRP)	11.76	11.76
LTE eFDD 7 16QAM	high	1	20	21.39	2 (EIRP)	2 (EIRP)	11.61	11.61
LTE eFDD 7 16QAM	high	100	20	21.08	2 (EIRP)	2 (EIRP)	11.92	11.92
LTE eFDD 13 QPSK	low	1	5	23.78	3 (ERP)	3 (ERP)	10.99	10.99
LTE eFDD 13 QPSK	low	12	5	22.61	3 (ERP)	3 (ERP)	12.16	12.16
LTE eFDD 13 QPSK	low	25	5	22.60	3 (ERP)	3 (ERP)	12.17	12.17
LTE eFDD 13 QPSK	mid	1	5	23.82	3 (ERP)	3 (ERP)	10.95	10.95
LTE eFDD 13 QPSK	mid	12	5	22.68	3 (ERP)	3 (ERP)	12.09	12.09
LTE eFDD 13 QPSK	mid	25	5	22.59	3 (ERP)	3 (ERP)	12.18	12.18
LTE eFDD 13 QPSK	high	1	5	22.40	3 (ERP)	3 (ERP)	12.37	12.37
LTE eFDD 13 QPSK	high	12	5	21.84	3 (ERP)	3 (ERP)	12.93	12.93
LTE eFDD 13 QPSK	high	25	5	21.86	3 (ERP)	3 (ERP)	12.91	12.91
LTE eFDD 13 16QAM	low	1	5	22.13	3 (ERP)	3 (ERP)	12.64	12.64
LTE eFDD 13 16QAM	low	25	5	20.72	3 (ERP)	3 (ERP)	14.05	14.05
LTE eFDD 13 16QAM	mid	1	5	22.78	3 (ERP)	3 (ERP)	11.99	11.99
LTE eFDD 13 16QAM	mid	25	5	20.81	3 (ERP)	3 (ERP)	13.96	13.96
LTE eFDD 13 16QAM	high	1	5	21.97	3 (ERP)	3 (ERP)	12.80	12.80
LTE eFDD 13 16QAM	high	25	5	20.95	3 (ERP)	3 (ERP)	13.82	13.82
LTE eFDD 13 QPSK	mid	1	10	24.07	3 (ERP)	3 (ERP)	10.70	10.70
LTE eFDD 13 QPSK	mid	50	10	22.71	3 (ERP)	3 (ERP)	12.06	12.06
LTE eFDD 13 16QAM	mid	1	10	22.18	3 (ERP)	3 (ERP)	12.59	12.59
LTE eFDD 13 16QAM	mid	50	10	21.59	3 (ERP)	3 (ERP)	13.18	13.18



LTE eTDD 38 QPSK	low	1	5	22.58	2 (EIRP)	2 (EIRP)	10.42	10.42
LTE eTDD 38 QPSK	low	12	5	22.29	2 (EIRP)	2 (EIRP)	10.71	10.71
LTE eTDD 38 QPSK	low	25	5	22.19	2 (EIRP)	2 (EIRP)	10.81	10.81
LTE eTDD 38 QPSK	mid	1	5	22.76	2 (EIRP)	2 (EIRP)	10.24	10.24
LTE eTDD 38 QPSK	mid	12	5	22.34	2 (EIRP)	2 (EIRP)	10.66	10.66
LTE eTDD 38 QPSK	mid	25	5	22.28	2 (EIRP)	2 (EIRP)	10.72	10.72
LTE eTDD 38 QPSK	high	1	5	22.80	2 (EIRP)	2 (EIRP)	10.2	10.2
LTE eTDD 38 QPSK	high	12	5	22.06	2 (EIRP)	2 (EIRP)	10.94	10.94
LTE eTDD 38 QPSK	high	25	5	22.26	2 (EIRP)	2 (EIRP)	10.74	10.74
LTE eTDD 38 16QAM	low	1	5	22.67	2 (EIRP)	2 (EIRP)	10.33	10.33
LTE eTDD 38 16QAM	low	25	5	21.56	2 (EIRP)	2 (EIRP)	11.44	11.44
LTE eTDD 38 16QAM	mid	1	5	21.72	2 (EIRP)	2 (EIRP)	11.28	11.28
LTE eTDD 38 16QAM	mid	25	5	21.40	2 (EIRP)	2 (EIRP)	11.6	11.6
LTE eTDD 38 16QAM	high	1	5	22.87	2 (EIRP)	2 (EIRP)	10.13	10.13
LTE eTDD 38 16QAM	high	25	5	21.32	2 (EIRP)	2 (EIRP)	11.68	11.68
LTE eTDD 38 QPSK	low	1	10	23.95	2 (EIRP)	2 (EIRP)	9.05	9.05
LTE eTDD 38 QPSK	low	50	10	22.15	2 (EIRP)	2 (EIRP)	10.85	10.85
LTE eTDD 38 QPSK	mid	1	10	23.29	2 (EIRP)	2 (EIRP)	9.71	9.71
LTE eTDD 38 QPSK	mid	50	10	22.26	2 (EIRP)	2 (EIRP)	10.74	10.74
LTE eTDD 38 QPSK	high	1	10	23.57	2 (EIRP)	2 (EIRP)	9.43	9.43
LTE eTDD 38 QPSK	high	50	10	22.06	2 (EIRP)	2 (EIRP)	10.94	10.94
LTE eTDD 38 16QAM	low	1	10	21.67	2 (EIRP)	2 (EIRP)	11.33	11.33
LTE eTDD 38 16QAM	low	50	10	21.73	2 (EIRP)	2 (EIRP)	11.27	11.27
LTE eTDD 38 16QAM	mid	1	10	23.26	2 (EIRP)	2 (EIRP)	9.74	9.74
LTE eTDD 38 16QAM	mid	50	10	22.11	2 (EIRP)	2 (EIRP)	10.89	10.89
LTE eTDD 38 16QAM	high	1	10	22.28	2 (EIRP)	2 (EIRP)	10.72	10.72
LTE eTDD 38 16QAM	high	50	10	21.65	2 (EIRP)	2 (EIRP)	11.35	11.35
LTE eTDD 38 QPSK	low	1	15	23.89	2 (EIRP)	2 (EIRP)	9.11	9.11
LTE eTDD 38 QPSK	low	36	15	22.19	2 (EIRP)	2 (EIRP)	10.81	10.81
LTE eTDD 38 QPSK	low	75	15	22.47	2 (EIRP)	2 (EIRP)	10.53	10.53
LTE eTDD 38 QPSK	mid	1	15	23.28	2 (EIRP)	2 (EIRP)	9.72	9.72
LTE eTDD 38 QPSK	mid	36	15	22.08	2 (EIRP)	2 (EIRP)	10.92	10.92
LTE eTDD 38 QPSK	mid	75	15	22.15	2 (EIRP)	2 (EIRP)	10.85	10.85
LTE eTDD 38 QPSK	high	1	15	22.54	2 (EIRP)	2 (EIRP)	10.46	10.46
LTE eTDD 38 QPSK	high	36	15	21.95	2 (EIRP)	2 (EIRP)	11.05	11.05
LTE eTDD 38 QPSK	high	75	15	22.08	2 (EIRP)	2 (EIRP)	10.92	10.92
LTE eTDD 38 16QAM	low	1	15	21.58	2 (EIRP)	2 (EIRP)	11.42	11.42
LTE eTDD 38 16QAM	low	75	15	22.03	2 (EIRP)	2 (EIRP)	10.97	10.97
LTE eTDD 38 16QAM	mid	1	15	23.20	2 (EIRP)	2 (EIRP)	9.8	9.8
LTE eTDD 38 16QAM	mid	75	15	21.59	2 (EIRP)	2 (EIRP)	11.41	11.41
LTE eTDD 38 16QAM	high	1	15	22.55	2 (EIRP)	2 (EIRP)	10.45	10.45
LTE eTDD 38 16QAM	high	75	15	21.36	2 (EIRP)	2 (EIRP)	11.64	11.64
LTE eTDD 38 QPSK	low	1	20	23.09	2 (EIRP)	2 (EIRP)	9.91	9.91
LTE eTDD 38 QPSK	low	100	20	22.20	2 (EIRP)	2 (EIRP)	10.8	10.8
LTE eTDD 38 QPSK	mid	1	20	23.87	2 (EIRP)	2 (EIRP)	9.13	9.13
LTE eTDD 38 QPSK	mid	100	20	22.19	2 (EIRP)	2 (EIRP)	10.81	10.81
LTE eTDD 38 QPSK	high	1	20	23.28	2 (EIRP)	2 (EIRP)	9.72	9.72

LTE eTDD 38 QPSK	high	100	20	22.02	2 (EIRP)	2 (EIRP)	10.98	10.98
LTE eTDD 38 16QAM	low	1	20	22.42	2 (EIRP)	2 (EIRP)	10.58	10.58
LTE eTDD 38 16QAM	low	100	20	22.03	2 (EIRP)	2 (EIRP)	10.97	10.97
LTE eTDD 38 16QAM	mid	1	20	21.42	2 (EIRP)	2 (EIRP)	11.58	11.58
LTE eTDD 38 16QAM	mid	100	20	22.03	2 (EIRP)	2 (EIRP)	10.97	10.97
LTE eTDD 38 16QAM	high	1	20	22.08	2 (EIRP)	2 (EIRP)	10.92	10.92
LTE eTDD 38 16QAM	high	100	20	22.24	2 (EIRP)	2 (EIRP)	10.76	10.76
LTE eTDD 41 QPSK	low	1	5	23.64	2 (EIRP)	2 (EIRP)	9.36	9.36
LTE eTDD 41 QPSK	low	12	5	22.25	2 (EIRP)	2 (EIRP)	10.75	10.75
LTE eTDD 41 QPSK	low	25	5	22.77	2 (EIRP)	2 (EIRP)	10.23	10.23
LTE eTDD 41 QPSK	mid	1	5	23.72	2 (EIRP)	2 (EIRP)	9.28	9.28
LTE eTDD 41 QPSK	mid	12	5	22.36	2 (EIRP)	2 (EIRP)	10.64	10.64
LTE eTDD 41 QPSK	mid	25	5	22.58	2 (EIRP)	2 (EIRP)	10.42	10.42
LTE eTDD 41 QPSK	high	1	5	23.10	2 (EIRP)	2 (EIRP)	9.9	9.9
LTE eTDD 41 QPSK	high	12	5	22.51	2 (EIRP)	2 (EIRP)	10.49	10.49
LTE eTDD 41 QPSK	high	25	5	22.51	2 (EIRP)	2 (EIRP)	10.49	10.49
LTE eTDD 41 16QAM	low	1	5	22.11	2 (EIRP)	2 (EIRP)	10.89	10.89
LTE eTDD 41 16QAM	low	25	5	21.29	2 (EIRP)	2 (EIRP)	11.71	11.71
LTE eTDD 41 16QAM	mid	1	5	23.12	2 (EIRP)	2 (EIRP)	9.88	9.88
LTE eTDD 41 16QAM	mid	25	5	21.21	2 (EIRP)	2 (EIRP)	11.79	11.79
LTE eTDD 41 16QAM	high	1	5	20.35	2 (EIRP)	2 (EIRP)	12.65	12.65
LTE eTDD 41 16QAM	high	25	5	21.10	2 (EIRP)	2 (EIRP)	11.9	11.9
LTE eTDD 41 QPSK	low	1	10	24.26	2 (EIRP)	2 (EIRP)	8.74	8.74
LTE eTDD 41 QPSK	low	50	10	22.32	2 (EIRP)	2 (EIRP)	10.68	10.68
LTE eTDD 41 QPSK	mid	1	10	23.62	2 (EIRP)	2 (EIRP)	9.38	9.38
LTE eTDD 41 QPSK	mid	50	10	22.35	2 (EIRP)	2 (EIRP)	10.65	10.65
LTE eTDD 41 QPSK	high	1	10	23.89	2 (EIRP)	2 (EIRP)	9.11	9.11
LTE eTDD 41 QPSK	high	50	10	22.20	2 (EIRP)	2 (EIRP)	10.8	10.8
LTE eTDD 41 16QAM	low	1	10	23.41	2 (EIRP)	2 (EIRP)	9.59	9.59
LTE eTDD 41 16QAM	low	50	10	22.06	2 (EIRP)	2 (EIRP)	10.94	10.94
LTE eTDD 41 16QAM	mid	1	10	22.65	2 (EIRP)	2 (EIRP)	10.35	10.35
LTE eTDD 41 16QAM	mid	50	10	22.43	2 (EIRP)	2 (EIRP)	10.57	10.57
LTE eTDD 41 16QAM	high	1	10	22.36	2 (EIRP)	2 (EIRP)	10.64	10.64
LTE eTDD 41 16QAM	high	50	10	21.92	2 (EIRP)	2 (EIRP)	11.08	11.08
LTE eTDD 41 QPSK	low	1	15	24.08	2 (EIRP)	2 (EIRP)	8.92	8.92
LTE eTDD 41 QPSK	low	36	15	22.08	2 (EIRP)	2 (EIRP)	10.92	10.92
LTE eTDD 41 QPSK	low	75	15	22.26	2 (EIRP)	2 (EIRP)	10.74	10.74
LTE eTDD 41 QPSK	mid	1	15	23.48	2 (EIRP)	2 (EIRP)	9.52	9.52
LTE eTDD 41 QPSK	mid	36	15	22.39	2 (EIRP)	2 (EIRP)	10.61	10.61
LTE eTDD 41 QPSK	mid	75	15	22.30	2 (EIRP)	2 (EIRP)	10.70	10.70
LTE eTDD 41 QPSK	high	1	15	22.85	2 (EIRP)	2 (EIRP)	10.15	10.15
LTE eTDD 41 QPSK	high	36	15	21.90	2 (EIRP)	2 (EIRP)	11.10	11.10
LTE eTDD 41 QPSK	high	75	15	22.17	2 (EIRP)	2 (EIRP)	10.83	10.83
LTE eTDD 41 16QAM	low	1	15	21.69	2 (EIRP)	2 (EIRP)	11.31	11.31
LTE eTDD 41 16QAM	low	75	15	21.36	2 (EIRP)	2 (EIRP)	11.64	11.64
LTE eTDD 41 16QAM	mid	1	15	23.34	2 (EIRP)	2 (EIRP)	9.66	9.66
LTE eTDD 41 16QAM	mid	75	15	21.50	2 (EIRP)	2 (EIRP)	11.50	11.50

LTE eTDD 41 16QAM	high	1	15	22.64	2 (EIRP)	2 (EIRP)	10.36	10.36
LTE eTDD 41 16QAM	high	75	15	21.40	2 (EIRP)	2 (EIRP)	11.6	11.6
LTE eTDD 41 QPSK	low	1	20	23.30	2 (EIRP)	2 (EIRP)	9.7	9.7
LTE eTDD 41 QPSK	low	100	20	22.22	2 (EIRP)	2 (EIRP)	10.78	10.78
LTE eTDD 41 QPSK	mid	1	20	24.00	2 (EIRP)	2 (EIRP)	9.00	9.00
LTE eTDD 41 QPSK	mid	100	20	22.24	2 (EIRP)	2 (EIRP)	10.76	10.76
LTE eTDD 41 QPSK	high	1	20	23.51	2 (EIRP)	2 (EIRP)	9.49	9.49
LTE eTDD 41 QPSK	high	100	20	22.03	2 (EIRP)	2 (EIRP)	10.97	10.97
LTE eTDD 41 16QAM	low	1	20	22.49	2 (EIRP)	2 (EIRP)	10.51	10.51
LTE eTDD 41 16QAM	low	100	20	22.14	2 (EIRP)	2 (EIRP)	10.86	10.86
LTE eTDD 41 16QAM	mid	1	20	21.49	2 (EIRP)	2 (EIRP)	11.51	11.51
LTE eTDD 41 16QAM	mid	100	20	22.03	2 (EIRP)	2 (EIRP)	10.97	10.97
LTE eTDD 41 16QAM	high	1	20	21.92	2 (EIRP)	2 (EIRP)	11.08	11.08
LTE eTDD 41 16QAM	high	100	20	22.27	2 (EIRP)	2 (EIRP)	10.73	10.73

Remark: Please see next sub-clause for the measurement plot.

#### 5.15.4 MEASUREMENT PLOT (EXAMPLE PLOT, SHOWING WORST CASE, IF APPLICABLE)

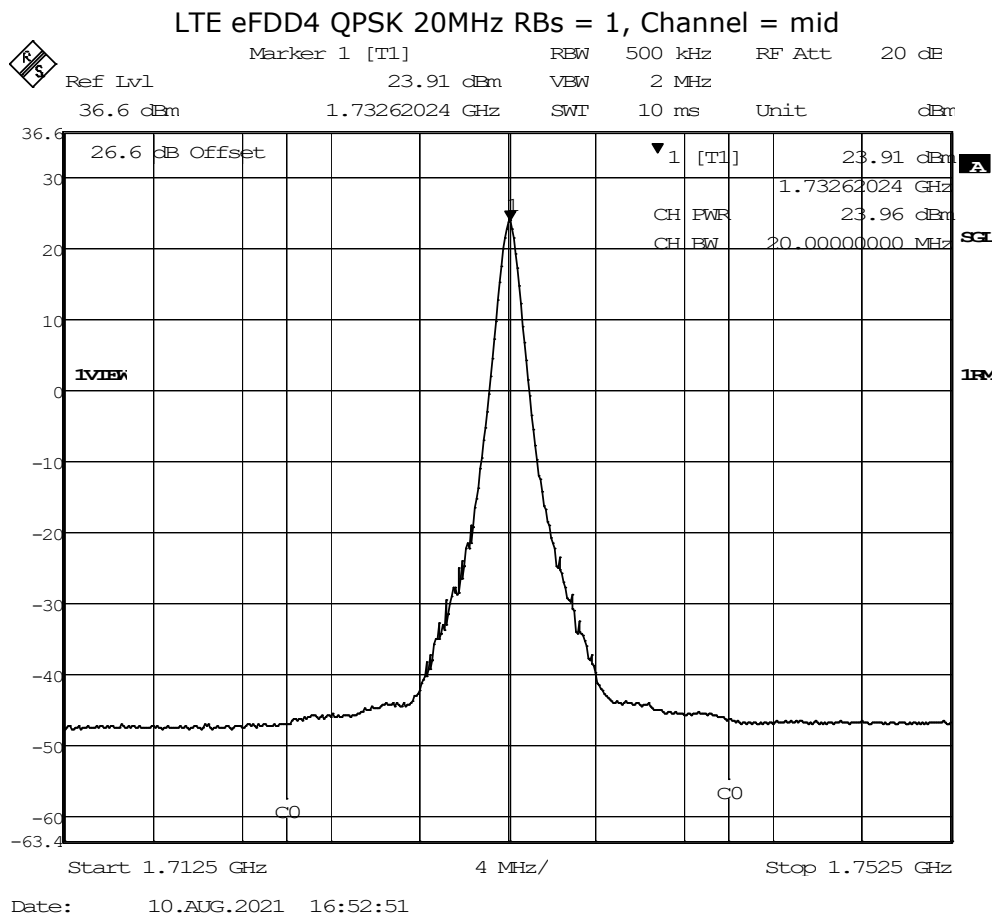

### LTE eFDD7 QPSK 10MHz RBs = 1, Channel = low

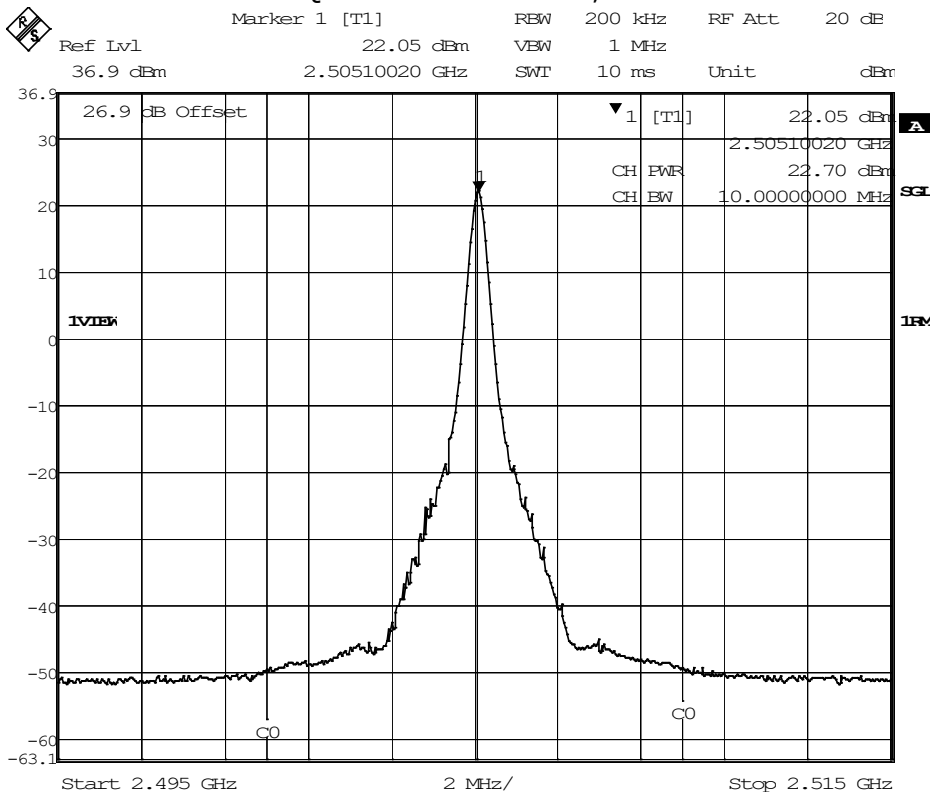

Date: 4.NOV.2021 09:51:17

### LTE eFDD12 QPSK 10MHz RBs = 1, Channel = mid

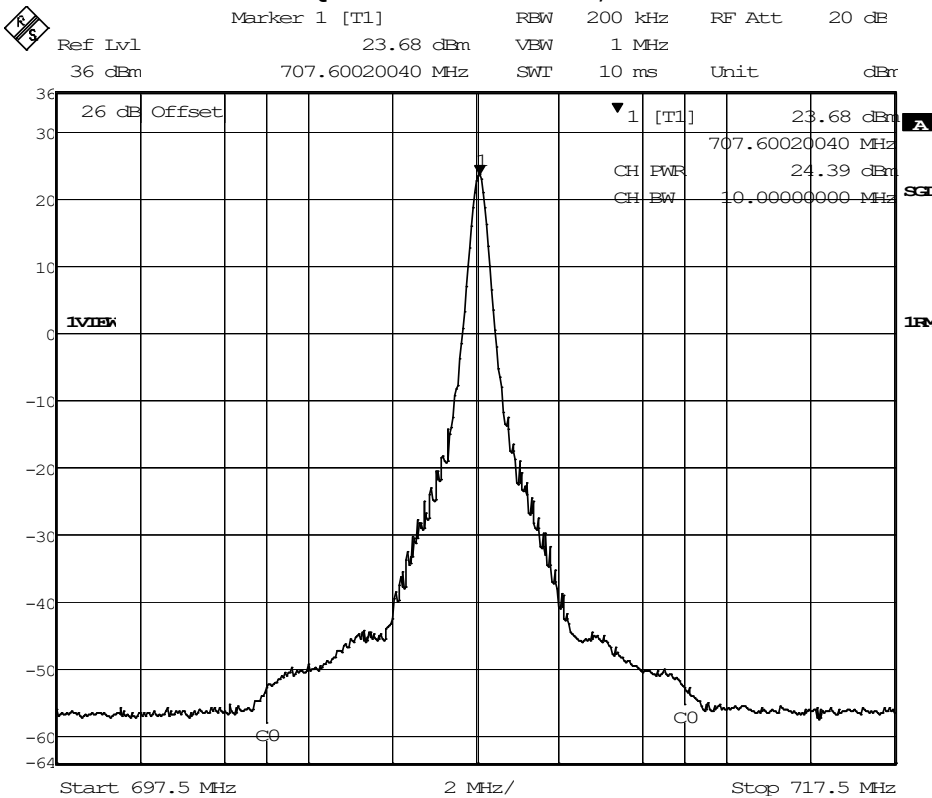

Date: 10.AUG.2021 20:14:22

### LTE eFDD13 QPSK 10MHz RBs = 1, Channel = mid

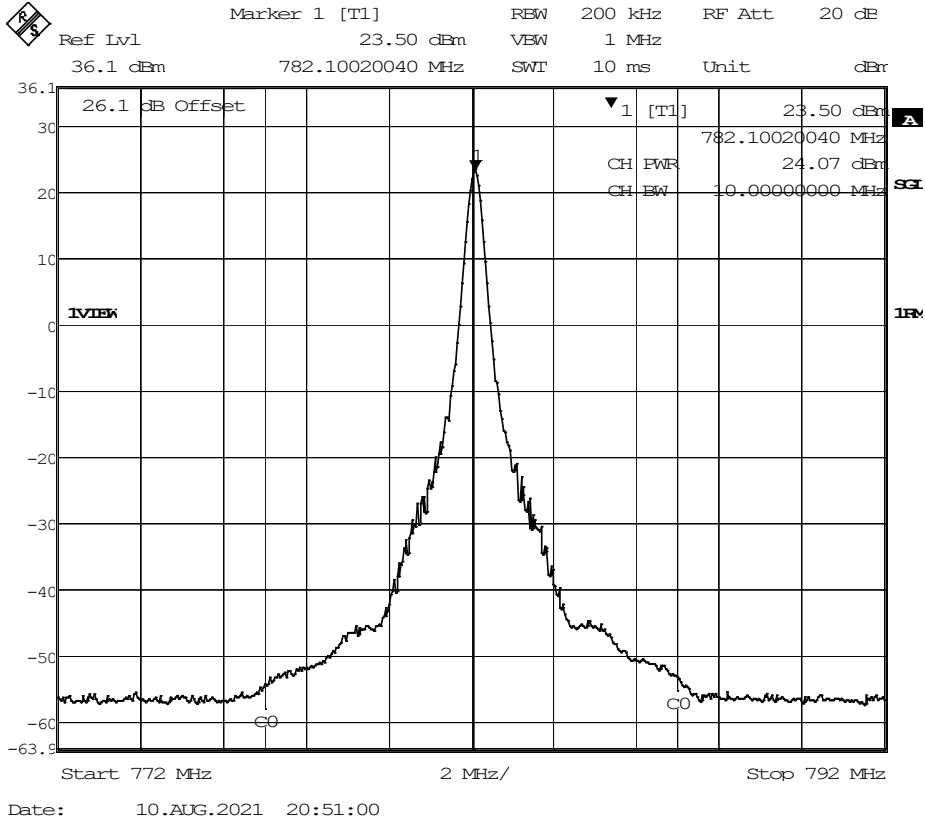

### LTE eTDD38 QPSK 10MHz RBs = 1, Channel = mid

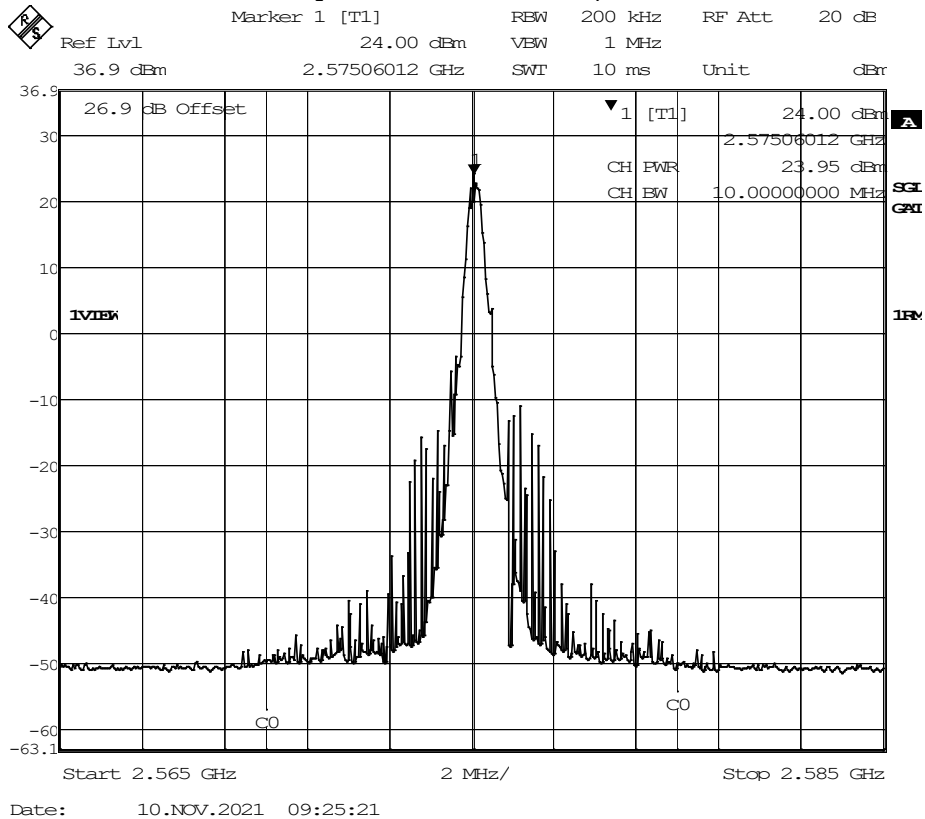

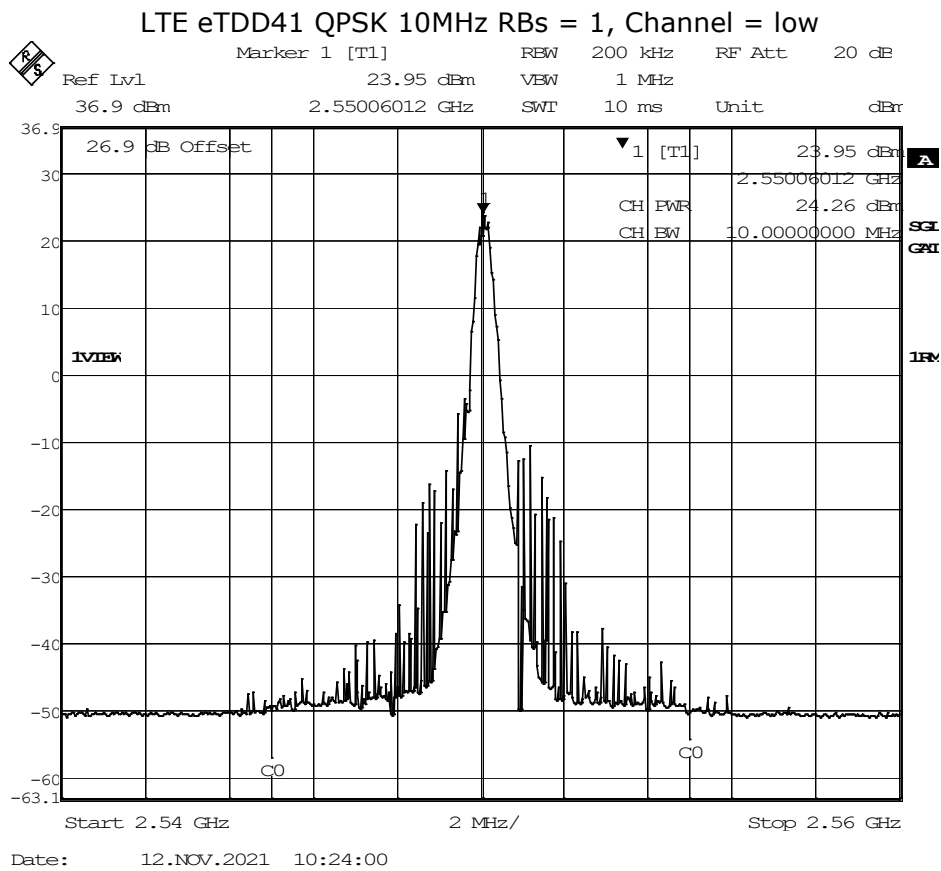

### 5.15.5 TEST EQUIPMENT USED

- Radio Lab

## 5.16 FREQUENCY STABILITY

Standard **FCC PART 27 Subpart C**

**The test was performed according to:**  
ANSI C63.26: 2015

### 5.16.1 TEST DESCRIPTION

This test case is intended to demonstrate compliance to the applicable frequency stability test case per § 2.1055 and RSS-GEN 6.11. The limit and the requirements come from the applicable rule part and ISED RSS-Standard for the operating band of the cellular device.

The EUT was connected to the test setup according to the following diagram:



Test Setup FCC Part 22/24/27/90 Cellular;  
Frequency stability

The attenuation of the measuring / stimulus path is known for each measured frequency and are considered.

### 5.16.2 TEST REQUIREMENTS / LIMITS

#### **FCC Part 27; Miscellaneous Wireless Communication Services**

#### **Subpart C – Technical standards**

#### **§ 27.54 - Frequency stability**

#### **All Bands**

The frequency stability shall be sufficient to ensure that the fundamental emissions stay within the authorized bands of operation.

#### **Band 12/13/17:**

#### **RSS-130; 4.5 Transmitter frequency stability**

For equipment that is capable of transmitting numerous channels simultaneously for different applications (e.g. LTE and narrowband – Internet of Things (IoT)), the occupied bandwidth shall be the bandwidth representing the sum of the occupied bandwidths of these channels.

The frequency stability shall be sufficient to ensure that the occupied bandwidth remains within each frequency block range when tested at the temperature and supply voltage variations specified in RSS-Gen.

**Band 4/10/66:**

**RSS-139; 6.4 Frequency Stability**

The frequency stability shall be sufficient to ensure that the occupied bandwidth stays within the operating frequency block when tested to the temperature and supply voltage variations specified in RSS-Gen.

**Band 7:**

**RSS-199; 4.3 Transmitter frequency stability**

The transmitter frequency stability limit shall be determined as follows:

- a. the frequency offset shall be measured according to the procedure described in RSS-Gen and recorded.
- b. using a resolution bandwidth equal to that permitted within the 1 MHz band immediately outside the channel edge, as found in section 4.5, reference points will be selected at the unwanted emission limits, which comply with the attenuation specified in section 4.5 for the type of device under test, on the emission mask of the lowest and highest channels. The frequency at these points shall be recorded as fL and fH respectively.

The applicant shall ensure compliance with frequency stability requirements by showing that fL minus the frequency offset and fH plus the frequency offset is within the frequency range in which the equipment is designed to operate.



### 5.16.3 TEST PROTOCOL

#### LTE eFDD 4

Temp. °C	Duration min	Voltage	Limit Hz	Freq. error Average (Hz)	Freq. error Max. (Hz)	Verdict
-30	0	normal	4331.25	-4	10	passed
-30	5			-3	12	passed
-30	10			-4	15	passed
-20	0	normal	4331.25	-2	14	passed
-20	5			-3	13	passed
-20	10			-2	14	passed
-10	0	normal	4331.25	5	12	passed
-10	5			1	10	passed
-10	10			3	10	passed
0	0	normal	4331.25	-4	11	passed
0	5			-2	12	passed
0	10			-3	15	passed
10	0	normal	4331.25	-3	12	passed
10	5			5	11	passed
10	10			4	14	passed
20	0	low	4331.25	-3	13	passed
20	5			-5	10	passed
20	10			-5	14	passed
20	0	normal	4331.25	2	11	passed
20	5			3	14	passed
20	10			2	12	passed
20	0	high	4331.25	2	13	passed
20	5			3	14	passed
20	10			3	11	passed
30	0	normal	4331.25	1	13	passed
30	5			-4	15	passed
30	10			-2	12	passed
40	0	normal	4331.25	3	14	passed
40	5			3	12	passed
40	10			-1	10	passed
50	0	normal	4331.25	2	11	passed
50	5			-2	13	passed
50	10			-3	14	passed

LTE eFDD 7

Temp. °C	Duration min	Voltage	Limit Hz	Freq. error Average (Hz)	Freq. error Max. (Hz)	Verdict
-30	0	normal	6337.5	-1	-6	passed
-30	5			-5	-8	passed
-30	10			-2	-8	passed
-20	0	normal	6337.5	-3	-6	passed
-20	5			-3	-7	passed
-20	10			-4	-7	passed
-10	0	normal	6337.5	-5	-11	passed
-10	5			-4	-7	passed
-10	10			-4	-6	passed
0	0	normal	6337.5	-2	-9	passed
0	5			-4	-10	passed
0	10			-1	-5	passed
10	0	normal	6337.5	-3	-6	passed
10	5			-1	-4	passed
10	10			-2	-7	passed
20	0	low	6337.5	-3	-8	passed
20	5			-1	-5	passed
20	10			-1	-5	passed
20	0	normal	6337.5	-2	-6	passed
20	5			-2	-7	passed
20	10			-3	-7	passed
20	0	high	6337.5	-2	-5	passed
20	5			-3	-7	passed
20	10			-1	-5	passed
30	0	normal	6337.5	-3	-8	passed
30	5			-2	-5	passed
30	10			-2	-6	passed
40	0	normal	6337.5	-4	-9	passed
40	5			-2	-7	passed
40	10			-1	-7	passed
50	0	normal	6337.5	-3	-7	passed
50	5			-3	-10	passed
50	10			-3	-8	passed

LTE eFDD 12

Temp. °C	Duration min	Voltage	Limit Hz	Freq. error Average (Hz)	Freq. error Max. (Hz)	Verdict
-30	0	normal	1768.75	-4	-21	passed
-30	5			-8	-23	passed
-30	10			-6	-20	passed
-20	0	normal	1768.75	-5	-18	passed
-20	5			-5	-19	passed
-20	10			-4	-17	passed
-10	0	normal	1768.75	-3	-22	passed
-10	5			-8	-18	passed
-10	10			-4	-13	passed
0	0	normal	1768.75	-7	-17	passed
0	5			-6	-18	passed
0	10			-3	-14	passed
10	0	normal	1768.75	-4	-20	passed
10	5			-6	-18	passed
10	10			-8	-15	passed
20	0	low	1768.75	-7	-16	passed
20	5			-8	-18	passed
20	10			-8	-14	passed
20	0	normal	1768.75	-9	-23	passed
20	5			-8	-16	passed
20	10			-4	-24	passed
20	0	high	1768.75	-5	-12	passed
20	5			-5	-15	passed
20	10			-8	-16	passed
30	0	normal	1768.75	-3	-19	passed
30	5			-7	-13	passed
30	10			-2	-14	passed
40	0	normal	1768.75	-2	-16	passed
40	5			-7	-18	passed
40	10			-5	-16	passed
50	0	normal	1768.75	-6	-16	passed
50	5			-4	-22	passed
50	10			-3	-13	passed

LTE eFDD 13

Temp. °C	Duration min	Voltage	Limit Hz	Freq. error Average (Hz)	Freq. error Max. (Hz)	Verdict
-30	0	normal	1955	2	7	passed
-30	5			3	5	passed
-30	10			-3	-6	passed
-20	0	normal	1955	-3	-5	passed
-20	5			-4	-7	passed
-20	10			3	12	passed
-10	0	normal	1955	2	10	passed
-10	5			5	8	passed
-10	10			-4	-9	passed
0	0	normal	1955	-2	-6	passed
0	5			3	8	passed
0	10			4	10	passed
10	0	normal	1955	-5	-8	passed
10	5			2	4	passed
10	10			3	7	passed
20	0	low	1955	4	9	passed
20	5			-3	-8	passed
20	10			-2	-3	passed
20	0	normal	1955	-4	-9	passed
20	5			-3	-7	passed
20	10			-3	-7	passed
20	0	high	1955	-5	-6	passed
20	5			6	12	passed
20	10			4	9	passed
30	0	normal	1955	-5	-10	passed
30	5			6	11	passed
30	10			6	9	passed
40	0	normal	1955	-4	-8	passed
40	5			-3	-12	passed
40	10			-4	-11	passed
50	0	normal	1955	5	9	passed
50	5			-6	-8	passed
50	10			4	8	passed

LTE eTDD 38

Temp. °C	Duration min	Voltage	Limit Hz	Freq. error Average (Hz)	Freq. error Max. (Hz)	Verdict
-30	0	normal	6487.5	3	6	passed
-30	5			1	5	passed
-30	10			4	4	passed
-20	0	normal	6487.5	2	3	passed
-20	5			1	6	passed
-20	10			3	6	passed
-10	0	normal	6487.5	4	7	passed
-10	5			3	5	passed
-10	10			4	-8	passed
0	0	normal	6487.5	2	7	passed
0	5			2	6	passed
0	10			1	9	passed
10	0	normal	6487.5	3	11	passed
10	5			2	8	passed
10	10			3	6	passed
20	0	low	6487.5	4	7	passed
20	5			3	6	passed
20	10			1	9	passed
20	0	normal	6487.5	3	8	passed
20	5			3	8	passed
20	10			4	7	passed
20	0	high	6487.5	2	7	passed
20	5			2	7	passed
20	10			2	10	passed
30	0	normal	6487.5	3	6	passed
30	5			1	7	passed
30	10			2	7	passed
40	0	normal	6487.5	3	5	passed
40	5			4	6	passed
40	10			2	5	passed
50	0	normal	6487.5	3	-6	passed
50	5			1	8	passed
50	10			3	5	passed

LTE eTDD 41

Temp. °C	Duration min	Voltage	Limit Hz	Freq. error Average (Hz)	Freq. error Max. (Hz)	Verdict
-30	0	normal	6482.5	2	5	passed
-30	5			1	7	passed
-30	10			1	6	passed
-20	0	normal	6482.5	1	6	passed
-20	5			2	8	passed
-20	10			1	5	passed
-10	0	normal	6482.5	3	6	passed
-10	5			1	8	passed
-10	10			1	8	passed
0	0	normal	6482.5	2	6	passed
0	5			0	5	passed
0	10			1	5	passed
10	0	normal	6482.5	2	9	passed
10	5			3	8	passed
10	10			3	6	passed
20	0	low	6482.5	1	7	passed
20	5			1	5	passed
20	10			1	8	passed
20	0	normal	6482.5	0	6	passed
20	5			1	7	passed
20	10			1	5	passed
20	0	high	6482.5	1	4	passed
20	5			2	6	passed
20	10			1	6	passed
30	0	normal	6482.5	2	7	passed
30	5			1	8	passed
30	10			1	6	passed
40	0	normal	6482.5	1	5	passed
40	5			0	4	passed
40	10			0	4	passed
50	0	normal	6482.5	2	5	passed
50	5			1	6	passed
50	10			1	9	passed

5.16.4 TEST EQUIPMENT USED

- Radio Lab

## 5.17 SPURIOUS EMISSIONS AT ANTENNA TERMINALS

Standard **FCC PART 27 Subpart C**

**The test was performed according to:**  
ANSI C63.26: 2015

### 5.17.1 TEST DESCRIPTION

This test case is intended to demonstrate compliance to the applicable conducted spurious emission test case per § 2.1051 and RSS-GEN 6.13. The limit comes from the applicable rule part and ISED RSS-Standard for the operating band of the cellular device.

The EUT was connected to the test setup according to the following diagram:

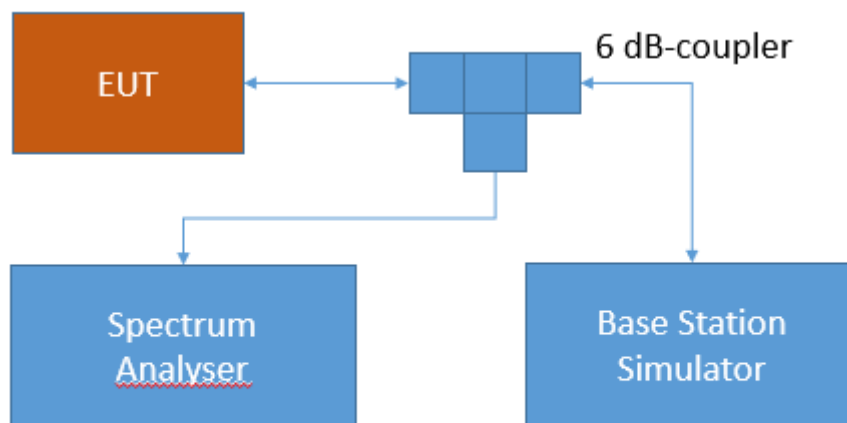

Test Setup FCC Part 22/24/27/90 Cellular;  
Spurious Emissions at antenna terminal

The attenuation of the measuring and stimulus path are known for each measured frequency and are considered.

The Spectrum Analyzer settings can be directly found in the measurement diagrams.

### 5.17.2 TEST REQUIREMENTS / LIMITS

#### **FCC Part 2.1051; Measurement required: Spurious emissions at antenna terminal:**

The radio frequency voltage or powers generated within the equipment and appearing on a spurious frequency shall be checked at the equipment output terminals when properly loaded with a suitable artificial antenna. Curves or equivalent data shall show the magnitude of each harmonic and other spurious emission that can be detected when the equipment is operated under the conditions specified in §2.1049 as appropriate. The magnitude of spurious emissions which are attenuated more than 20 dB below the permissible value need not be specified.

## FCC Part 27; Miscellaneous Wireless Communication Services

### Subpart C – Technical standards

#### §27.53 – Emission limits

##### Band 13

(c) For operations in the 746-758 MHz band and the 776-788 MHz band, the power of any emission outside the licensee's frequency band(s) of operation shall be attenuated below the transmitter power (P) within the licensed band(s) of operation, measured in watts, in accordance with the following:

(1) On any frequency outside the 746-758 MHz band, the power of any emission shall be attenuated outside the band below the transmitter power (P) by at least  $43 + 10 \log (P)$  dB;

(2) On any frequency outside the 776-788 MHz band, the power of any emission shall be attenuated outside the band below the transmitter power (P) by at least  $43 + 10 \log (P)$  dB;

(3) On all frequencies between 763-775 MHz and 793-805 MHz, by a factor not less than  $76 + 10 \log (P)$  dB in a 6.25 kHz band segment, for base and fixed stations;

(4) On all frequencies between 763-775 MHz and 793-805 MHz, by a factor not less than  $65 + 10 \log (P)$  dB in a 6.25 kHz band segment, for mobile and portable stations;

(5) Compliance with the provisions of paragraphs (c)(1) and (c)(2) of this section is based on the use of measurement instrumentation employing a resolution bandwidth of 100 kHz or greater. However, in the 100 kHz bands immediately outside and adjacent to the frequency block, a resolution bandwidth of at least 30 kHz may be employed;

(f) For operations in the 746-758 MHz, 775-788 MHz, and 805-806 MHz bands, emissions in the band 1559-1610 MHz shall be limited to  $-70$  dBW/MHz equivalent isotropically radiated power (EIRP) for wideband signals, and  $-80$  dBW EIRP for discrete emissions of less than 700 Hz bandwidth. For the purpose of equipment authorization, a transmitter shall be tested with an antenna that is representative of the type that will be used with the equipment in normal operation.

(6) Compliance with the provisions of paragraphs (c)(3) and (c)(4) of this section is based on the use of measurement instrumentation such that the reading taken with any resolution bandwidth setting should be adjusted to indicate spectral energy in a 6.25 kHz segment.

##### **RSS-130; 4.7.1 General unwanted emissions limits**

The unwanted emissions in any 100 kHz bandwidth on any frequency outside the low frequency edge and the high frequency edge of each frequency block range(s), shall be attenuated below the transmitter power, P (dBW), by at least  $43 + 10 \log_{10} p$  (watts), dB. However, in the 100 kHz band immediately outside of the equipment's frequency block range, a resolution bandwidth of 30 kHz may be employed.

##### **RSS-130; 4.7.2 Additional unwanted emissions limits**

In addition to the limit outlined in section 4.7.1 above, equipment operating in the frequency bands 746-756 MHz and 777-787 MHz shall also comply with the following restrictions:

- a. the power of any unwanted emissions in any 6.25 kHz bandwidth for all frequencies between 763-775 MHz and 793-806 MHz shall be attenuated below the transmitter power, P (dBW), by at least:
  - i.  $76 + 10 \log_{10} p$  (watts), dB, for base and fixed equipment and
  - ii.  $65 + 10 \log_{10} p$  (watts), dB, for mobile and portable equipment
- b. the e.i.r.p. in the band 1559-1610 MHz shall not exceed  $-70$  dBW/MHz for wideband signal and  $-80$  dBW for discrete emission with bandwidth less than 700 Hz.



### **Band 12:**

(g) For operations in the 600 MHz band and the 698-746 MHz band, the power of any emission outside a licensee's frequency band(s) of operation shall be attenuated below the transmitter power (P) within the licensed band(s) of operation, measured in watts, by at least  $43 + 10 \log(P)$  dB. Compliance with this provision is based on the use of measurement instrumentation employing a resolution bandwidth of 100 kilohertz or greater. However, in the 100 kilohertz bands immediately outside and adjacent to a licensee's frequency block, a resolution bandwidth of at least 30 kHz may be employed.

### **RSS-130; 4.7.1 General unwanted emissions limits**

The unwanted emissions in any 100 kHz bandwidth on any frequency outside the low frequency edge and the high frequency edge of each frequency block range(s), shall be attenuated below the transmitter power, P (dBW), by at least  $43 + 10 \log_{10} p$  (watts), dB. However, in the 100 kHz band immediately outside of the equipment's frequency block range, a resolution bandwidth of 30 kHz may be employed.

### **RSS-130; 4.7.2 Additional unwanted emissions limits**

In addition to the limit outlined in section 4.7.1 above, equipment operating in the frequency bands 746-756 MHz and 777-787 MHz shall also comply with the following restrictions:

- a. the power of any unwanted emissions in any 6.25 kHz bandwidth for all frequencies between 763-775 MHz and 793-806 MHz shall be attenuated below the transmitter power, P (dBW), by at least:
  - i.  $76 + 10 \log_{10} p$  (watts), dB, for base and fixed equipment and
  - ii.  $65 + 10 \log_{10} p$  (watts), dB, for mobile and portable equipment
- b. the e.i.r.p. in the band 1559-1610 MHz shall not exceed  $-70$  dBW/MHz for wideband signal and  $-80$  dBW for discrete emission with bandwidth less than 700 Hz.

### **Band 4/10/66:**

(h) *AWS emission limits— (1) General protection levels.* Except as otherwise specified below, for operations in the 1695-1710 MHz, 1710-1755 MHz, 1755-1780 MHz, 1915-1920 MHz, 1995-2000 MHz, 2000-2020 MHz, 2110-2155 MHz, 2155-2180 MHz, and 2180-2200 bands, the power of any emission outside a licensee's frequency block shall be attenuated below the transmitter power (P) in watts by at least  $43 + 10 \log_{10}(P)$  dB.

### **RSS-139; 6.6 Transmitter Unwanted Emissions**

Equipment shall comply with the limits in (i) and (ii) below.

- i. In the first 1.0 MHz bands immediately outside and adjacent to the equipment's smallest operating frequency block, which can contain the equipment's occupied bandwidth, the emission power per any 1% of the emission bandwidth shall be attenuated below the transmitter output power P (in dBW) by at least  $43 + 10 \log_{10} p$  (watts) dB.
- ii. After the first 1.0 MHz outside the equipment's smallest operating frequency block, which can contain the equipment's occupied bandwidth, the emission power in any 1 MHz bandwidth shall be attenuated below the transmitter output power P (in dBW) by at least  $43 + 10 \log_{10} p$  (watts) dB.

### **Band 7:**

(m) For BRS and EBS stations, the power of any emissions outside the licensee's frequency bands of operation shall be attenuated below the transmitter power (P) measured in watts in accordance with the standards below. If a licensee has multiple contiguous channels, out-of-band emissions shall be measured from the upper and lower edges of the contiguous channels.

(4) For mobile digital stations, the attenuation factor shall be not less than  $40 + 10 \log (P)$  dB on all frequencies between the channel edge and 5 megahertz from the channel edge,  $43 + 10 \log (P)$  dB on all frequencies between 5 megahertz and X megahertz from the channel edge, and  $55 + 10 \log (P)$  dB on all frequencies more than X megahertz from the channel edge, where X is the greater of 6 megahertz or the actual emission bandwidth as defined in paragraph (m)(6) of this section. In addition, the attenuation factor shall not be less than  $43 + 10 \log (P)$  dB on all frequencies between 2490.5 MHz and 2496 MHz and  $55 + 10 \log (P)$  dB at or below 2490.5 MHz. Mobile Satellite Service licensees operating on frequencies below 2495 MHz may also submit a documented interference complaint against BRS licensees operating on channel BRS Channel 1 on the same terms and conditions as adjacent channel BRS or EBS licensees.

### **RSS-199; 4.5 Transmitter unwanted emissions**

In the 1 MHz band immediately outside and adjacent to the channel edge, the unwanted emission power shall be measured with a resolution bandwidth of at least 1% of the occupied bandwidth for base station and fixed subscriber equipment, and 2% for mobile subscriber equipment. Beyond the 1 MHz band, a resolution bandwidth of 1 MHz shall be used. A narrower resolution bandwidth can be used, provided that the measured power is integrated over the full required measurement bandwidth of 1 MHz, or 1% or 2% of the occupied bandwidth, as applicable.

Equipment shall comply with the following unwanted emission limits:

b. for mobile subscriber equipment, the power of any unwanted emissions measured as above shall be attenuated (in dB) below the transmitter power, P (dBW), by at least:

$40 + 10 \log_{10} p$  from the channel edges to 5 MHz away

$43 + 10 \log_{10} p$  between 5 MHz and X MHz from the channel edges, and

$55 + 10 \log_{10} p$  at X MHz and beyond from the channel edges

In addition, the attenuation shall not be less than  $43 + 10 \log_{10} p$  on all frequencies between 2490.5 MHz and 2496 MHz, and  $55 + 10 \log_{10} p$  at or below 2490.5 MHz.

In (b), p is the transmitter power measured in watts and X is 6 MHz or the equipment occupied bandwidth, whichever is greater.

**Band 17:**

(g) For operations in the 600 MHz band and the 698-746 MHz band, the power of any emission outside a licensee's frequency band(s) of operation shall be attenuated below the transmitter power (P) within the licensed band(s) of operation, measured in watts, by at least  $43 + 10 \log(P)$  dB. Compliance with this provision is based on the use of measurement instrumentation employing a resolution bandwidth of 100 kilohertz or greater. However, in the 100 kilohertz bands immediately outside and adjacent to a licensee's frequency block, a resolution bandwidth of at least 30 kHz may be employed.

**RSS-130; 4.7.1 General unwanted emissions limits**

The unwanted emissions in any 100 kHz bandwidth on any frequency outside the low frequency edge and the high frequency edge of each frequency block range(s), shall be attenuated below the transmitter power, P (dBW), by at least  $43 + 10 \log_{10} p$  (watts), dB. However, in the 100 kHz band immediately outside of the equipment's frequency block range, a resolution bandwidth of 30 kHz may be employed.

**RSS-130; 4.7.2 Additional unwanted emissions limits**

In addition to the limit outlined in section 4.7.1 above, equipment operating in the frequency bands 746-756 MHz and 777-787 MHz shall also comply with the following restrictions:

- a. the power of any unwanted emissions in any 6.25 kHz bandwidth for all frequencies between 763-775 MHz and 793-806 MHz shall be attenuated below the transmitter power, P (dBW), by at least:
  - i.  $76 + 10 \log_{10} p$  (watts), dB, for base and fixed equipment and
  - ii.  $65 + 10 \log_{10} p$  (watts), dB, for mobile and portable equipment
- b. the e.i.r.p. in the band 1559-1610 MHz shall not exceed  $-70$  dBW/MHz for wideband signal and  $-80$  dBW for discrete emission with bandwidth less than 700 Hz.

### 5.17.3 TEST PROTOCOL

Ambient temperature: 20 - 28 °C  
Relative humidity: 30 - 45 %

Radio Technology	Channel	Detector	Trace	Resolution Bandwidth /kHz	Frequency /MHz	Peak Value /dBm	Limit /dBm	Margin to Limit /dB
LTE eFDD4	low	rms	maxhold	5	1709.9	-33.44	-23	10.44
LTE eFDD4	low	rms	maxhold	1000	2113.7	-24.45	-13	11.45
LTE eFDD4	mid	peak	maxhold	1000	2131.8	-24.45	-13	11.45
LTE eFDD4	high	rms	maxhold	5	1755.0	-33.54	-23	-23.54

Radio Technology	Channel	Detector	Trace	Resolution Bandwidth /kHz	Frequency /MHz	Peak Value /dBm	Limit /dBm	Margin to Limit /dB
LTE eFDD7	low	rms	maxhold	5	2500.0	-27.84	-23	2.84
LTE eFDD7	mid	peak	maxhold	-	-	-	-13	>20
LTE eFDD7	high	rms	maxhold	5	2570.0	-25.98	-23	2.98

Radio Technology	Channel	Detector	Trace	Resolution Bandwidth /kHz	Frequency /MHz	Peak Value /dBm	Limit /dBm	Margin to Limit /dB
LTE eFDD12	low	peak	maxhold	100	2912.0	-36.93	-13	23.93
LTE eFDD12	mid	peak	maxhold	100	3000.0	-37.2	-13	24.20
LTE eFDD12	high	rms	maxhold	100	719.9	-40.88	-13	27.88

Radio Technology	Channel	Detector	Trace	Resolution Bandwidth /kHz	Frequency /MHz	Peak Value /dBm	Limit /dBm	Margin to Limit /dB
LTE eFDD13	low	rms	maxhold	100	746.3	-34.86	-13	21.86
LTE eFDD13	mid	rms	maxhold	-	-	-	-13	>20
LTE eFDD13	high	rms	maxhold	100	751.82	-34.86	-13	21.86

Radio Technology	Channel	Detector	Trace	Resolution Bandwidth /kHz	Frequency /MHz	Peak Value /dBm	Limit /dBm	Margin to Limit /dB
LTE eTDD38	low	rms	maxhold	100	2569.9	-19.24	-10	9.24
LTE eTDD38	low	peak	maxhold	1000	5140.7	-36.34	-25	11.34
LTE eTDD38	mid	peak	maxhold	1000	5190.78	-34.5	-25	9.50
LTE eTDD38	high	rms	maxhold	1000	2624.0	-25.84	-13	12.84
LTE eTDD38	high	peak	maxhold	1000	5227.6	-36.27	-25	11.27

Radio Technology	Channel	Detector	Trace	Resolution Bandwidth /kHz	Frequency /MHz	Peak Value /dBm	Limit /dBm	Margin to Limit /dB
LTE eTDD41	low	rms	maxhold	100	2495.9	-20.72	-10	10.72
LTE eTDD41	mid	peak	maxhold	-	-	-	-13	>20
LTE eTDD41	high	rms	maxhold	100	2690	-18.88	-10	8.88

Remark: Please see next sub-clause for the measurement plot.

5.17.4 MEASUREMENT PLOT (EXAMPLE PLOT, SHOWING WORST CASE, IF APPLICABLE)

LTE eFDD 4 QPSK, Channel = high

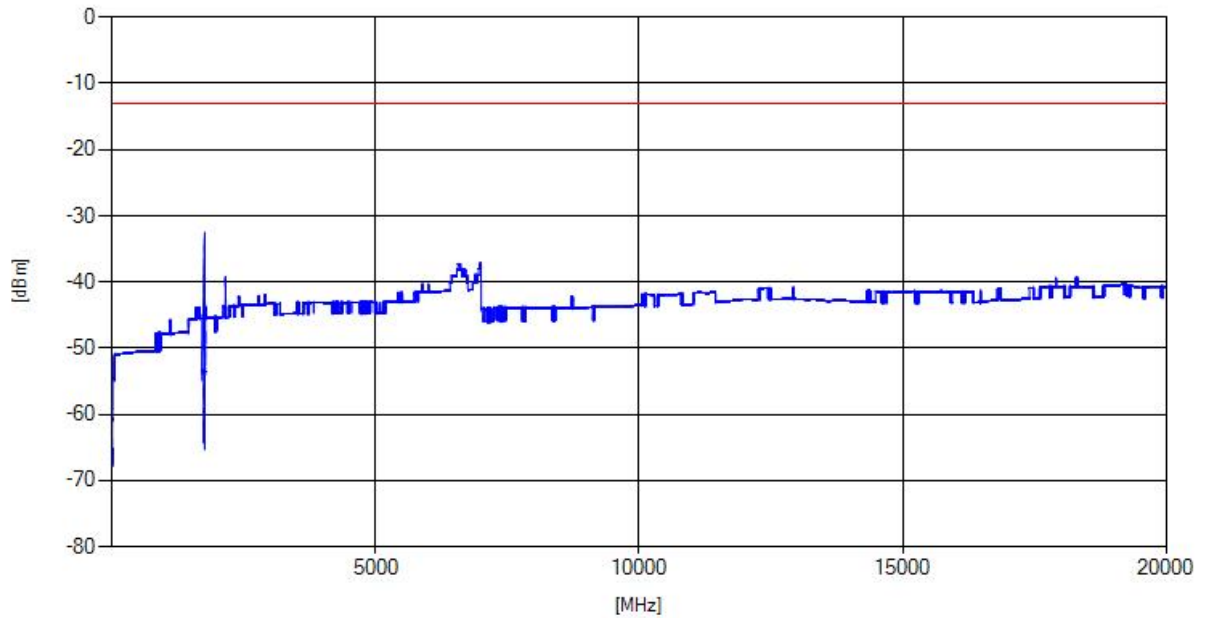

LTE eFDD 7 QPSK, Channel = high

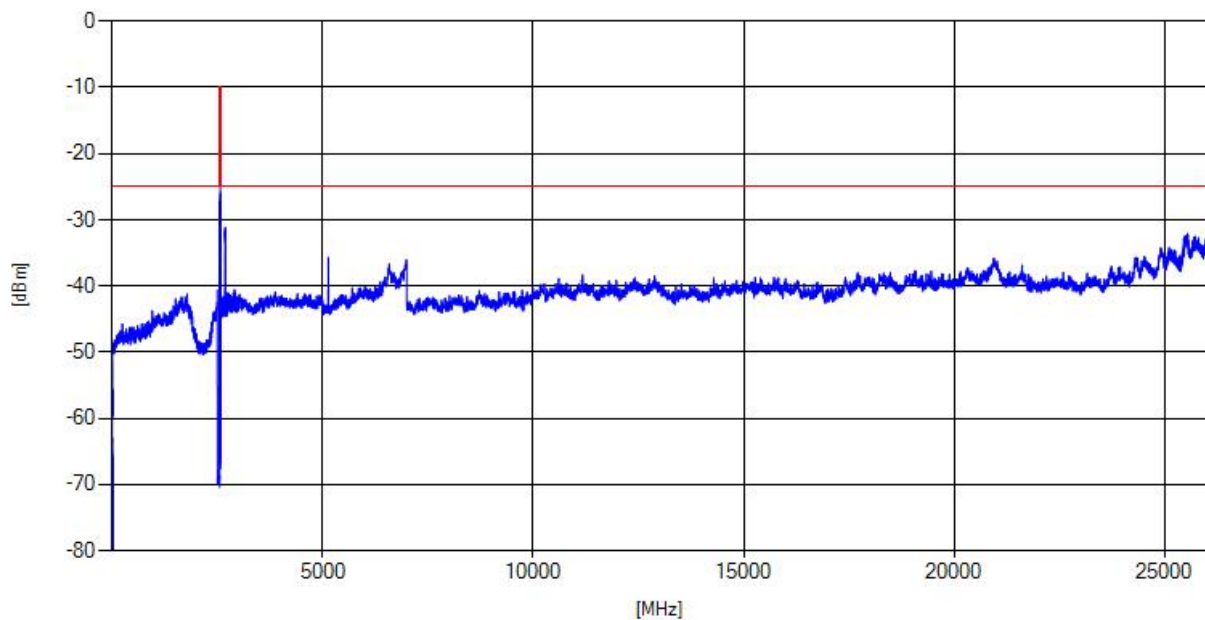

LTE eFDD 12 QPSK, Channel = low

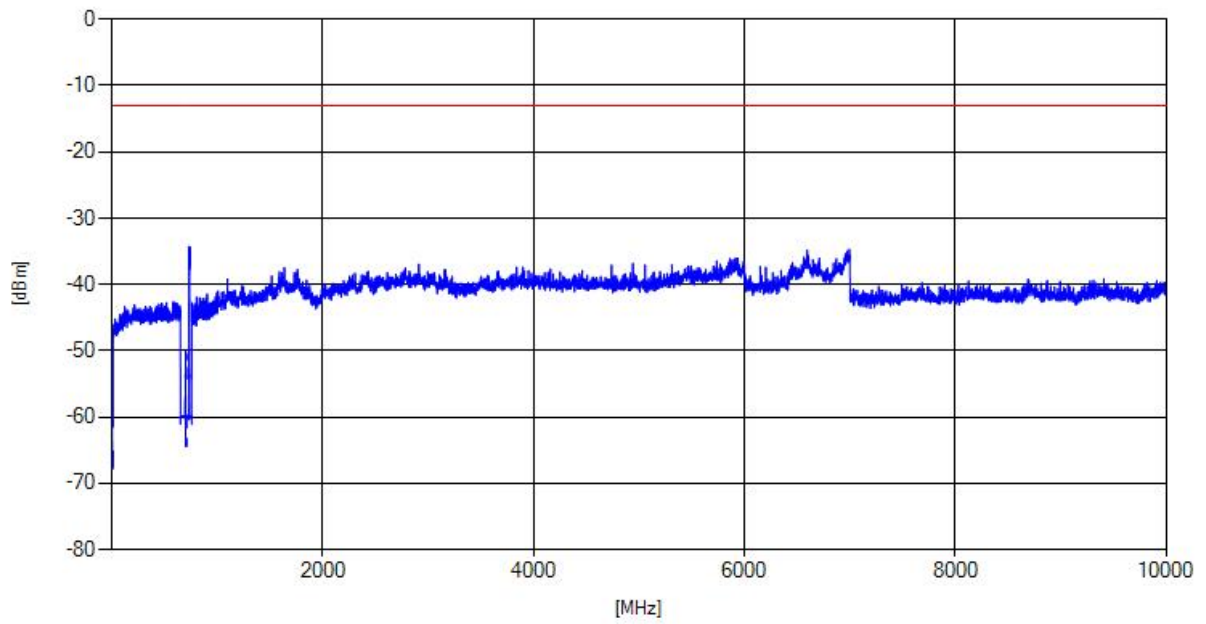

LTE eFDD 13 QPSK, Channel = high

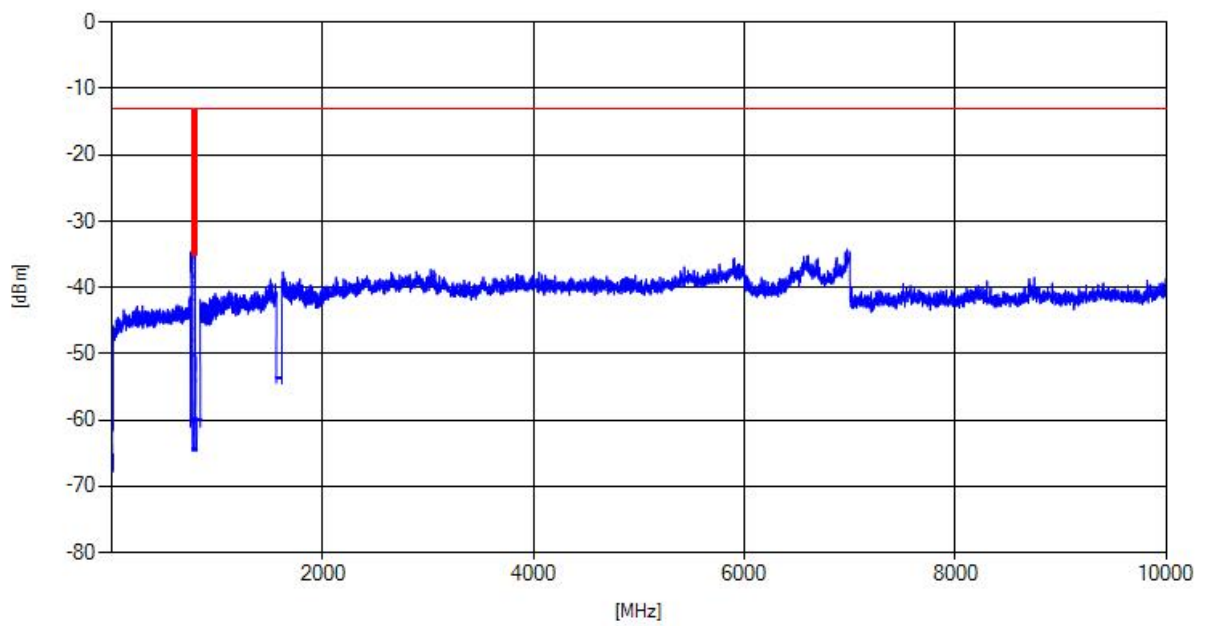

LTE eTDD 38 QPSK, Channel = low

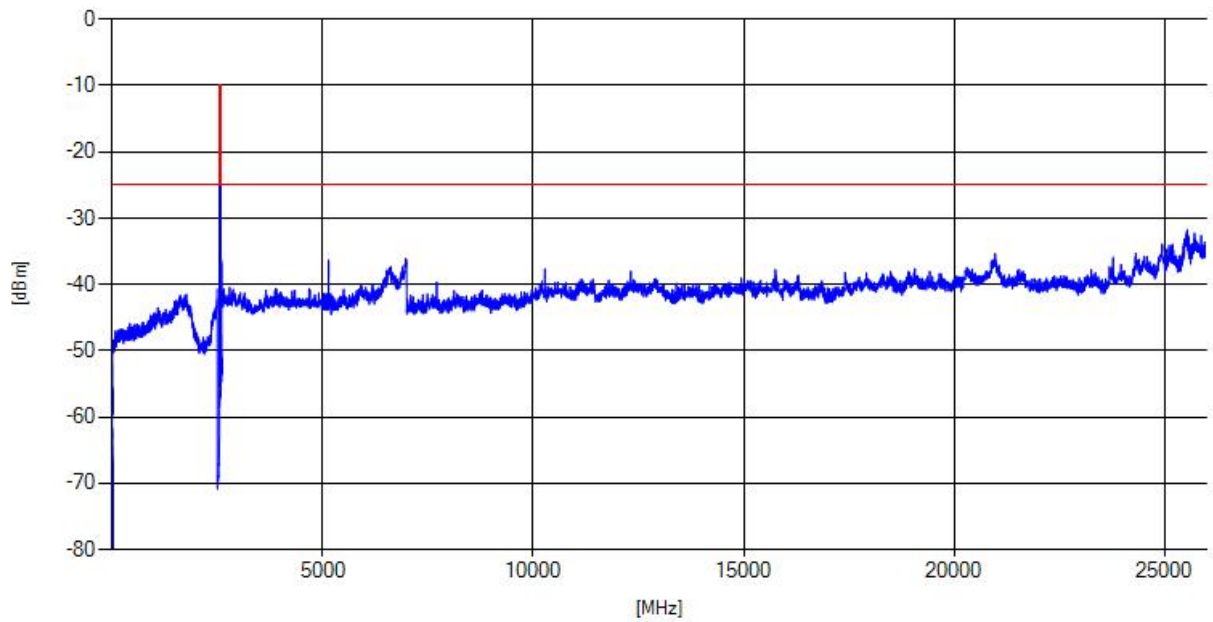

LTE eTDD 41 QPSK, Channel = high

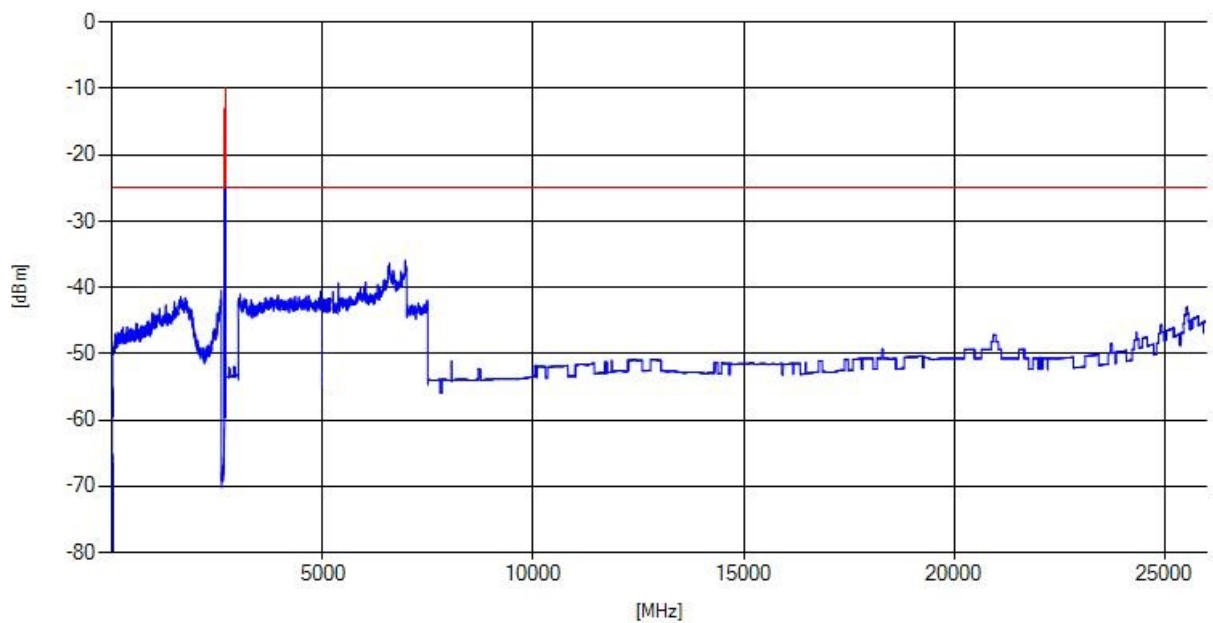

### 5.17.5 TEST EQUIPMENT USED

- Radio Lab

## 5.18 FIELD STRENGTH OF SPURIOUS RADIATION

Standard **FCC PART 27 Subpart C**

**The test was performed according to:**  
ANSI C63.26: 2015

### 5.18.1 TEST DESCRIPTION

This test case is intended to demonstrate compliance to the applicable radiated spurious emission measurements per § 2.1053 and RSS-GEN 6.13. The limit and requirements come from the applicable rule part and ISED RSS-Standard for the operating band of the cellular device.

The EUT was connected to the test setup according to the following diagram:

Frequency Range: 30 MHz – 1 GHz:

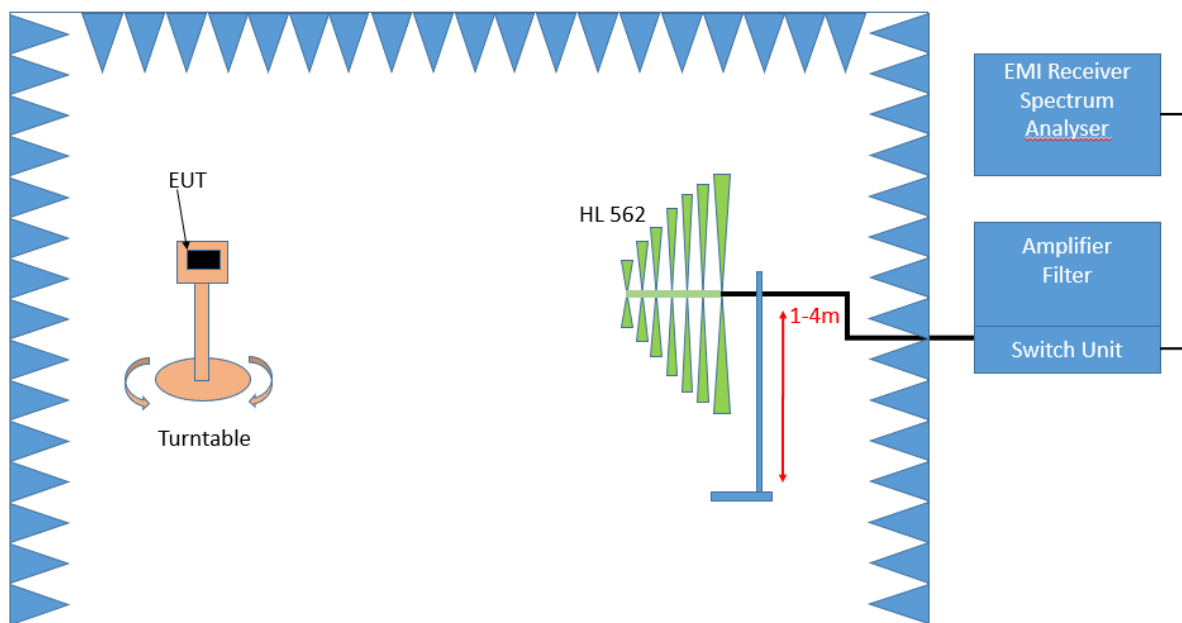

Test Setup; Spurious Emission Radiated (SAC), 30 MHz- 1GHz

Frequency Range: 1 GHz – 26.5 GHz



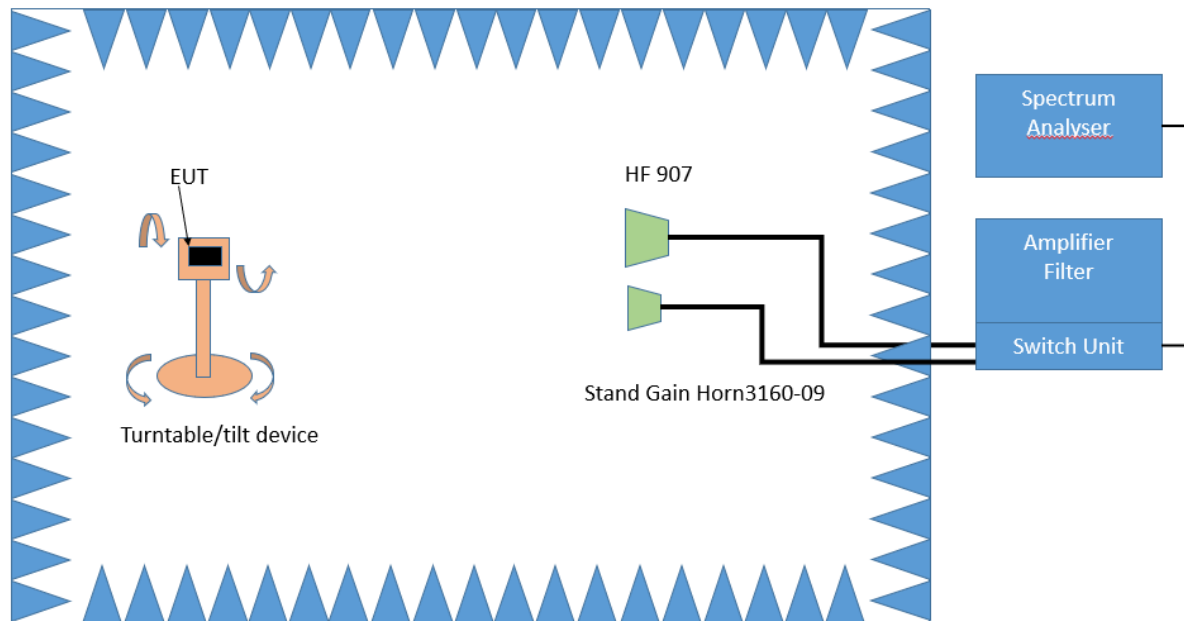

Test Setup; Spurious Emission Radiated (FAC), 1 GHz-26.5 GHz

The test set-up was made in accordance to the general provisions of ANSI C63.26 in a typical installation configuration. The Equipment Under Test (EUT) was set up on a non-conductive table 1.0 x 2.0 m<sup>2</sup> in the semi-anechoic chamber. The influence of the EUT support table that is used between 30–1000 MHz was evaluated.

The measurement procedure is implemented into the EMI test software EMC32 from R&S. Exploratory tests are performed at 3 orthogonal axes to determine the worst-case orientation of a body-worn or handheld EUT. The final test on all kind of EUTs is also performed at 3 axes. A pre-check is performed while the EUT is powered from a DC power source.

## 1. Measurement above 30 MHz and up to 1 GHz

### Step 1: Preliminary scan

This is a preliminary test to identify the highest amplitudes relative to the limit.

Settings for step 1:

- Antenna distance: 3 m
- Detector: Peak
- RBW: 100 kHz
- VBW: 300 kHz
- Sweep time: coupled
- Turntable angle range: -180° to 90°
- Turntable step size: 90°
- Height variation range: 1 – 4 m
- Height variation step size: 1.5 m
- Polarisation: Horizontal + Vertical

Intention of this step is, to determine the radiated EMI-profile of the EUT. Afterwards the relevant emissions for the final measurement are identified.

### Step 2: Adjustment measurement

In this step the accuracy of the turntable azimuth and antenna height will be improved. This is necessary to find out the maximum value of every frequency.

For each frequency, which was determined the turntable azimuth and antenna height will be adjusted. The turntable azimuth will slowly vary by 360°. During this action, the value of emission is continuously measured. The turntable azimuth at the highest emission will be

recorded and adjusted. In this position, the antenna height will also slowly vary from 1 – 4 m. During this action, the value of emission is also continuously measured. The antenna height of the highest emission will also be recorded and adjusted.

- Detector: Peak
- Measured frequencies: in step 1 determined frequencies
- RBW: 100 kHz
- VBW: 300 kHz
- Sweep time: coupled
- Turntable angle range:  $\pm 45^\circ$  around the determined value
- Height variation range:  $\pm 100$  cm around the determined value
- Antenna Polarisation: max. value determined in step 1

### **Step 3:** Final measurement with RMS detector

With the settings determined in step 3, the final measurement will be performed:

EMI receiver settings for step 4:

- Detector: RMQ
- Measured frequencies: in step 1 determined frequencies
- RBW: 100 kHz
- VBW: 300 kHz
- Sweep time: 1 s

After the measurement a plot will be generated which contains a diagram with the results of the preliminary scan and a chart with the frequencies and values of the results of the final measurement.

## **3. Measurement above 1 GHz**

The following modifications apply to the measurement procedure for the frequency range above 1 GHz:

### **Step 1:**

The Equipment Under Test (EUT) was set up on a non-conductive support (tilt device) at 1.5 m height in the fully-anechoic chamber.

All steps were performed with one height (1.5 m) of the receiving antenna only.

The EUT is turned during the preliminary measurement across the elevation axis, with a step size of  $90^\circ$ .

The turn table step size (azimuth angle) for the preliminary measurement is  $45^\circ$ .

- Antenna distance: 3 m
- Detector: Peak
- RBW: 1 MHz
- VBW: 3 MHz
- Sweep time: coupled
- Turntable angle range:  $-180^\circ$  to  $90^\circ$
- Turntable step size:  $90^\circ$
- Polarisation: Horizontal + Vertical

### **Step 2:**

Due to the fact, that in this frequency range the test is performed in a fully anechoic room, the height scan of the receiving antenna instep 2 is omitted. Instead of this, a maximum search with a step size  $\pm 45^\circ$  for the elevation axis is performed.

The turn table azimuth will slowly vary by  $\pm 22.5^\circ$ .

The elevation angle will slowly vary by  $\pm 45^\circ$

EMI receiver settings (for all steps):

- Detector: Peak,
- RBW: 1 MHz
- VBW: 3 MHz
- Sweep time: coupled

**Step 3:**

Spectrum analyser settings for step 3:

- Detector: RMS
- Measured frequencies: in step 1 determined frequencies
- RBW: 1 MHz
- VBW: 3 MHz
- Sweep Time: 1 s

## 5.18.2 TEST REQUIREMENTS / LIMITS

**FCC Part 2.1053; Measurement required: Field strength of spurious radiation:**

Measurements shall be made to detect spurious emissions that may be radiated directly from the cabinet, control circuits, power leads, or intermediate circuit elements under normal conditions of installation and operation. Curves or equivalent data shall be supplied showing the magnitude of each harmonic and other spurious emission. For this test, single sideband, independent sideband, and controlled carrier transmitters shall be modulated under the conditions specified in paragraph (c) of §2.1049, as appropriate.

**FCC Part 27; Miscellaneous Wireless Communication Services****Subpart C – Technical standards****§27.53 – Emission limits****Band 13**

(c) For operations in the 746-758 MHz band and the 776-788 MHz band, the power of any emission outside the licensee's frequency band(s) of operation shall be attenuated below the transmitter power (P) within the licensed band(s) of operation, measured in watts, in accordance with the following:

- (1) On any frequency outside the 746-758 MHz band, the power of any emission shall be attenuated outside the band below the transmitter power (P) by at least  $43 + 10 \log (P)$  dB;
- (2) On any frequency outside the 776-788 MHz band, the power of any emission shall be attenuated outside the band below the transmitter power (P) by at least  $43 + 10 \log (P)$  dB;
- (3) On all frequencies between 763-775 MHz and 793-805 MHz, by a factor not less than  $76 + 10 \log (P)$  dB in a 6.25 kHz band segment, for base and fixed stations;
- (4) On all frequencies between 763-775 MHz and 793-805 MHz, by a factor not less than  $65 + 10 \log (P)$  dB in a 6.25 kHz band segment, for mobile and portable stations;
- (5) Compliance with the provisions of paragraphs (c)(1) and (c)(2) of this section is based on the use of measurement instrumentation employing a resolution bandwidth of 100 kHz or greater. However, in the 100 kHz bands immediately outside and adjacent to the frequency block, a resolution bandwidth of at least 30 kHz may be employed;
- (f) For operations in the 746-758 MHz, 775-788 MHz, and 805-806 MHz bands, emissions in the band 1559-1610 MHz shall be limited to  $-70$  dBW/MHz equivalent isotropically radiated power (EIRP) for wideband signals, and  $-80$  dBW EIRP for discrete emissions of less than 700 Hz bandwidth. For the purpose of equipment authorization, a transmitter shall be tested with an antenna that is representative of the type that will be used with the equipment in normal operation.

(6) Compliance with the provisions of paragraphs (c)(3) and (c)(4) of this section is based on the use of measurement instrumentation such that the reading taken with any resolution bandwidth setting should be adjusted to indicate spectral energy in a 6.25 kHz segment.

#### **RSS-130; 4.7.1 General unwanted emissions limits**

The unwanted emissions in any 100 kHz bandwidth on any frequency outside the low frequency edge and the high frequency edge of each frequency block range(s), shall be attenuated below the transmitter power, P (dBW), by at least  $43 + 10 \log_{10} p$  (watts), dB. However, in the 100 kHz band immediately outside of the equipment's frequency block range, a resolution bandwidth of 30 kHz may be employed.

#### **RSS-130; 4.7.2 Additional unwanted emissions limits**

In addition to the limit outlined in section 4.7.1 above, equipment operating in the frequency bands 746-756 MHz and 777-787 MHz shall also comply with the following restrictions:

- a. the power of any unwanted emissions in any 6.25 kHz bandwidth for all frequencies between 763-775 MHz and 793-806 MHz shall be attenuated below the transmitter power, P (dBW), by at least:
  - i.  $76 + 10 \log_{10} p$  (watts), dB, for base and fixed equipment and
  - ii.  $65 + 10 \log_{10} p$  (watts), dB, for mobile and portable equipment
- b. the e.i.r.p. in the band 1559-1610 MHz shall not exceed  $-70$  dBW/MHz for wideband signal and  $-80$  dBW for discrete emission with bandwidth less than 700 Hz.

#### **Band 12:**

(g) For operations in the 600 MHz band and the 698-746 MHz band, the power of any emission outside a licensee's frequency band(s) of operation shall be attenuated below the transmitter power (P) within the licensed band(s) of operation, measured in watts, by at least  $43 + 10 \log (P)$  dB. Compliance with this provision is based on the use of measurement instrumentation employing a resolution bandwidth of 100 kilohertz or greater. However, in the 100 kilohertz bands immediately outside and adjacent to a licensee's frequency block, a resolution bandwidth of at least 30 kHz may be employed.

#### **RSS-130; 4.7.1 General unwanted emissions limits**

The unwanted emissions in any 100 kHz bandwidth on any frequency outside the low frequency edge and the high frequency edge of each frequency block range(s), shall be attenuated below the transmitter power, P (dBW), by at least  $43 + 10 \log_{10} p$  (watts), dB. However, in the 100 kHz band immediately outside of the equipment's frequency block range, a resolution bandwidth of 30 kHz may be employed.

#### **RSS-130; 4.7.2 Additional unwanted emissions limits**

In addition to the limit outlined in section 4.7.1 above, equipment operating in the frequency bands 746-756 MHz and 777-787 MHz shall also comply with the following restrictions:

- a. the power of any unwanted emissions in any 6.25 kHz bandwidth for all frequencies between 763-775 MHz and 793-806 MHz shall be attenuated below the transmitter power, P (dBW), by at least:
  - i.  $76 + 10 \log_{10} p$  (watts), dB, for base and fixed equipment and
  - ii.  $65 + 10 \log_{10} p$  (watts), dB, for mobile and portable equipment
- b. the e.i.r.p. in the band 1559-1610 MHz shall not exceed  $-70$  dBW/MHz for wideband signal and  $-80$  dBW for discrete emission with bandwidth less than 700 Hz.

### **Band 4/10/66:**

(h) *AWS emission limits—(1) General protection levels.* Except as otherwise specified below, for operations in the 1695-1710 MHz, 1710-1755 MHz, 1755-1780 MHz, 1915-1920 MHz, 1995-2000 MHz, 2000-2020 MHz, 2110-2155 MHz, 2155-2180 MHz, and 2180-2200 bands, the power of any emission outside a licensee's frequency block shall be attenuated below the transmitter power (P) in watts by at least  $43 + 10 \log_{10} (P)$  dB.

### **RSS-139; 6.6 Transmitter Unwanted Emissions**

Equipment shall comply with the limits in (i) and (ii) below.

- i. In the first 1.0 MHz bands immediately outside and adjacent to the equipment's smallest operating frequency block, which can contain the equipment's occupied bandwidth, the emission power per any 1% of the emission bandwidth shall be attenuated below the transmitter output power P (in dBW) by at least  $43 + 10 \log_{10} p$  (watts) dB.
- ii. After the first 1.0 MHz outside the equipment's smallest operating frequency block, which can contain the equipment's occupied bandwidth, the emission power in any 1 MHz bandwidth shall be attenuated below the transmitter output power P (in dBW) by at least  $43 + 10 \log_{10} p$  (watts) dB.

### **Band 7:**

(m) For BRS and EBS stations, the power of any emissions outside the licensee's frequency bands of operation shall be attenuated below the transmitter power (P) measured in watts in accordance with the standards below. If a licensee has multiple contiguous channels, out-of-band emissions shall be measured from the upper and lower edges of the contiguous channels.

(4) For mobile digital stations, the attenuation factor shall be not less than  $40 + 10 \log (P)$  dB on all frequencies between the channel edge and 5 megahertz from the channel edge,  $43 + 10 \log (P)$  dB on all frequencies between 5 megahertz and X megahertz from the channel edge, and  $55 + 10 \log (P)$  dB on all frequencies more than X megahertz from the channel edge, where X is the greater of 6 megahertz or the actual emission bandwidth as defined in paragraph (m)(6) of this section. In addition, the attenuation factor shall not be less than  $43 + 10 \log (P)$  dB on all frequencies between 2490.5 MHz and 2496 MHz and  $55 + 10 \log (P)$  dB at or below 2490.5 MHz. Mobile Satellite Service licensees operating on frequencies below 2495 MHz may also submit a documented interference complaint against BRS licensees operating on channel BRS Channel 1 on the same terms and conditions as adjacent channel BRS or EBS licensees.

### **RSS-199; 4.5 Transmitter unwanted emissions**

In the 1 MHz band immediately outside and adjacent to the channel edge, the unwanted emission power shall be measured with a resolution bandwidth of at least 1% of the occupied bandwidth for base station and fixed subscriber equipment, and 2% for mobile subscriber equipment. Beyond the 1 MHz band, a resolution bandwidth of 1 MHz shall be used. A narrower resolution bandwidth can be used, provided that the measured power is integrated over the full required measurement bandwidth of 1 MHz, or 1% or 2% of the occupied bandwidth, as applicable.

Equipment shall comply with the following unwanted emission limits:

b. for mobile subscriber equipment, the power of any unwanted emissions measured as above shall be attenuated (in dB) below the transmitter power, P (dBW), by at least:

$40 + 10 \log_{10} p$  from the channel edges to 5 MHz away

$43 + 10 \log_{10} p$  between 5 MHz and X MHz from the channel edges, and

$55 + 10 \log_{10} p$  at X MHz and beyond from the channel edges

In addition, the attenuation shall not be less than  $43 + 10 \log_{10} p$  on all frequencies between 2490.5 MHz and 2496 MHz, and  $55 + 10 \log_{10} p$  at or below 2490.5 MHz.

In (b),  $p$  is the transmitter power measured in watts and  $X$  is 6 MHz or the equipment occupied bandwidth, whichever is greater.

#### **Band 17:**

(g) For operations in the 600 MHz band and the 698-746 MHz band, the power of any emission outside a licensee's frequency band(s) of operation shall be attenuated below the transmitter power ( $P$ ) within the licensed band(s) of operation, measured in watts, by at least  $43 + 10 \log(P)$  dB. Compliance with this provision is based on the use of measurement instrumentation employing a resolution bandwidth of 100 kilohertz or greater. However, in the 100 kilohertz bands immediately outside and adjacent to a licensee's frequency block, a resolution bandwidth of at least 30 kHz may be employed.

#### **RSS-130; 4.7.1 General unwanted emissions limits**

The unwanted emissions in any 100 kHz bandwidth on any frequency outside the low frequency edge and the high frequency edge of each frequency block range(s), shall be below the transmitter power,  $P$  (dBW), by at least  $43 + 10 \log_{10} p$  (watts), dB. However, in the 100 kHz band immediately outside of the equipment's frequency block range, a resolution bandwidth of 30 kHz may be employed.

#### **RSS-130; 4.7.2 Additional unwanted emissions limits**

In attenuated addition to the limit outlined in section 4.7.1 above, equipment operating in the frequency bands 746-756 MHz and 777-787 MHz shall also comply with the following restrictions:

- a. the power of any unwanted emissions in any 6.25 kHz bandwidth for all frequencies between 763-775 MHz and 793-806 MHz shall be attenuated below the transmitter power,  $P$  (dBW), by at least:
  - i.  $76 + 10 \log_{10} p$  (watts), dB, for base and fixed equipment and
  - ii.  $65 + 10 \log_{10} p$  (watts), dB, for mobile and portable equipment
- b. the e.i.r.p. in the band 1559-1610 MHz shall not exceed  $-70$  dBW/MHz for wideband signal and  $-80$  dBW for discrete emission with bandwidth less than 700 Hz.

### 5.18.3 TEST PROTOCOL

Ambient temperature: 20 - 28 °C  
 Relative humidity: 30 - 45 %

Radio Technology	Channel	Detector	Trace	Resolution Bandwidth /kHz	Frequency /MHz	Peak Value /dBm	Limit /dBm	Margin to Limit /dB
LTE eFDD4	low	rms	maxhold	50	1710.0	-24.6	-13	11.60
LTE eFDD4	mid	peak	maxhold	-	-	-	-13	> 20
LTE eFDD4	high	rms	maxhold	50	1755.0	-23.9	-13	10.90

Radio Technology	Channel	Detector	Trace	Resolution Bandwidth /kHz	Frequency /MHz	Peak Value /dBm	Limit /dBm	Margin to Limit /dB
LTE eFDD7	low	peak	maxhold	50	2506.0	-23.3	-10	13.30
LTE eFDD7	low	rms	maxhold	1000	2623.1	-38.6	-25	13.60
LTE eFDD7	mid	rms	maxhold	1000	2654.3	-38.3	-25	13.30
LTE eFDD7	high	rms	maxhold	1000	2686.8	-44.6	-25	19.60

Radio Technology	Channel	Detector	Trace	Resolution Bandwidth /kHz	Frequency /MHz	Peak Value /dBm	Limit /dBm	Margin to Limit /dB
LTE eFDD12	low	rms	maxhold	30	698.9	-35.1	-13	22.10
LTE eFDD12	mid	peak	maxhold	-	-	-	-13	> 20
LTE eFDD12	high	rms	maxhold	30	716	-26.6	-13	13.60

Radio Technology	Channel	Detector	Trace	Resolution Bandwidth /kHz	Frequency /MHz	Peak Value /dBm	Limit /dBm	Margin to Limit /dB
LTE eFDD13	low	rms	maxhold	-	-	-	-13	> 20
LTE eFDD13	mid	peak	maxhold	-	-	-	-13	> 20
LTE eFDD13	high	peak	maxhold	30	787	-15.8	-13	2.80
LTE eFDD13	high	rms	maxhold	1000	1573.1	-56	-40	16.00

Radio Technology	Channel	Detector	Trace	Resolution Bandwidth /kHz	Frequency /MHz	Peak Value /dBm	Limit /dBm	Margin to Limit /dB
LTE eTDD38	low	rms	maxhold	50	2569.9	-32.2	-10	22.20
LTE eTDD38	mid	peak	maxhold				-25	-25.00
LTE eTDD38	high	rms	maxhold	50	2620	-18.5	-13	5.50

Radio Technology	Channel	Detector	Trace	Resolution Bandwidth /kHz	Frequency /MHz	Peak Value /dBm	Limit /dBm	Margin to Limit /dB
LTE eTDD41	low	rms	maxhold	50	2495.9	-22.86	-13	9.86
LTE eTDD41	mid	rms	maxhold	-	-	-	-13	>20
LTE eTDD41	high	rms	maxhold	50	2690.0	-24.7	-13	11.70

Remark: Please see next sub-clause for the measurement plot.

5.18.4 MEASUREMENT PLOT (EXAMPLE PLOT, SHOWING WORST CASE, IF APPLICABLE)

LTE eFDD 4, Channel = high  
30 MHz – 1 GHz

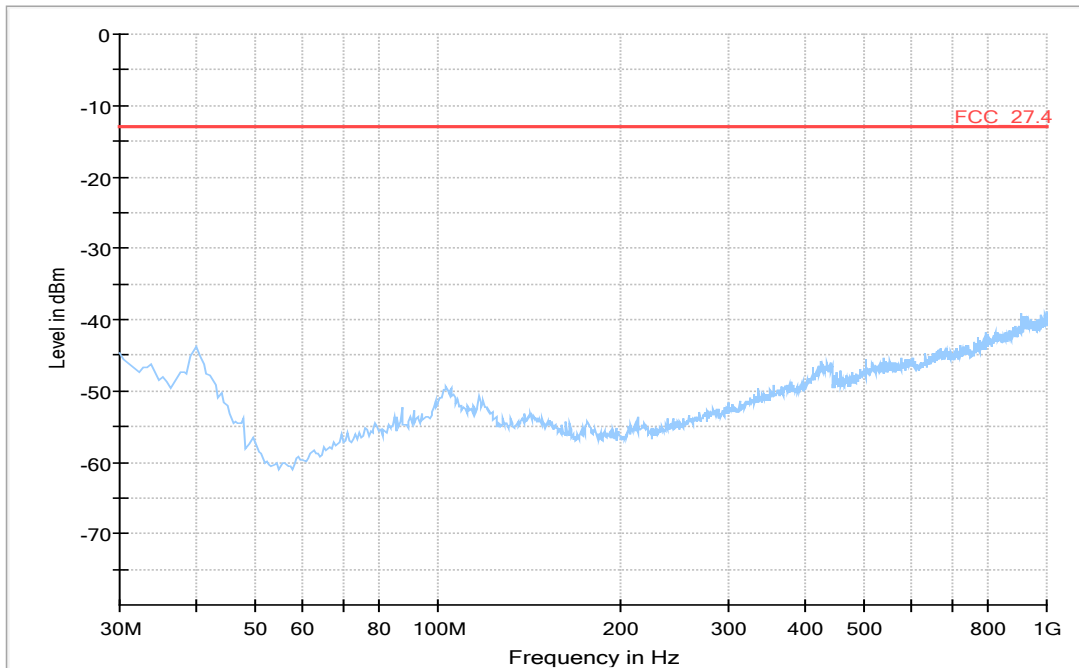

1 GHz – 20 GHz

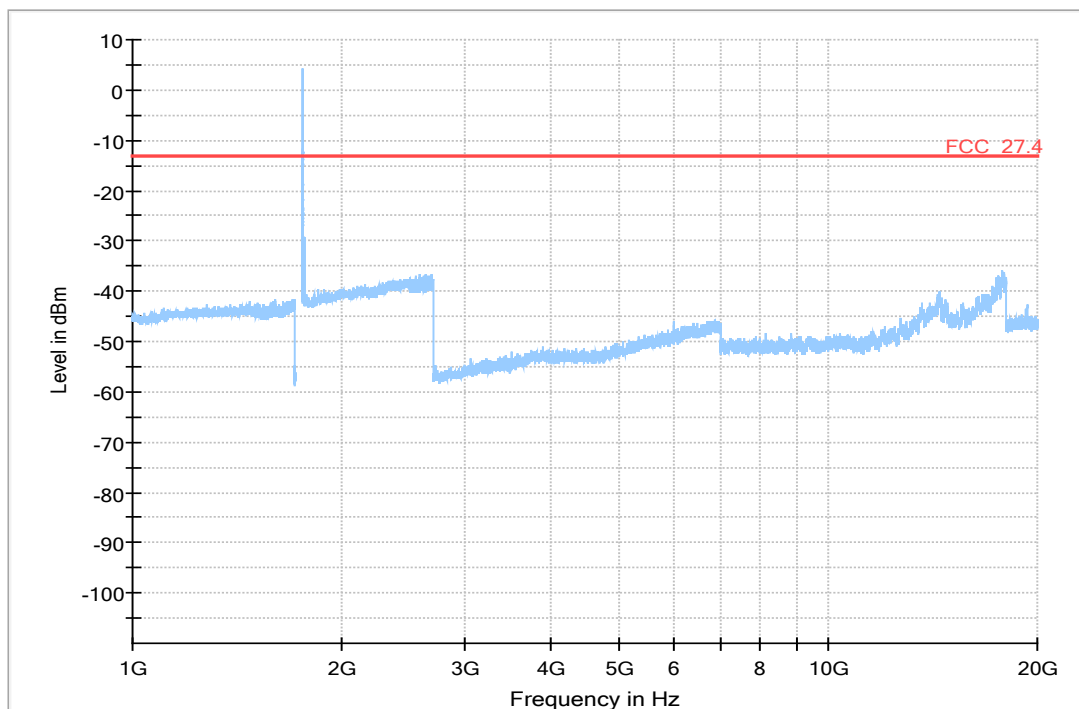



re-measurement at carrier

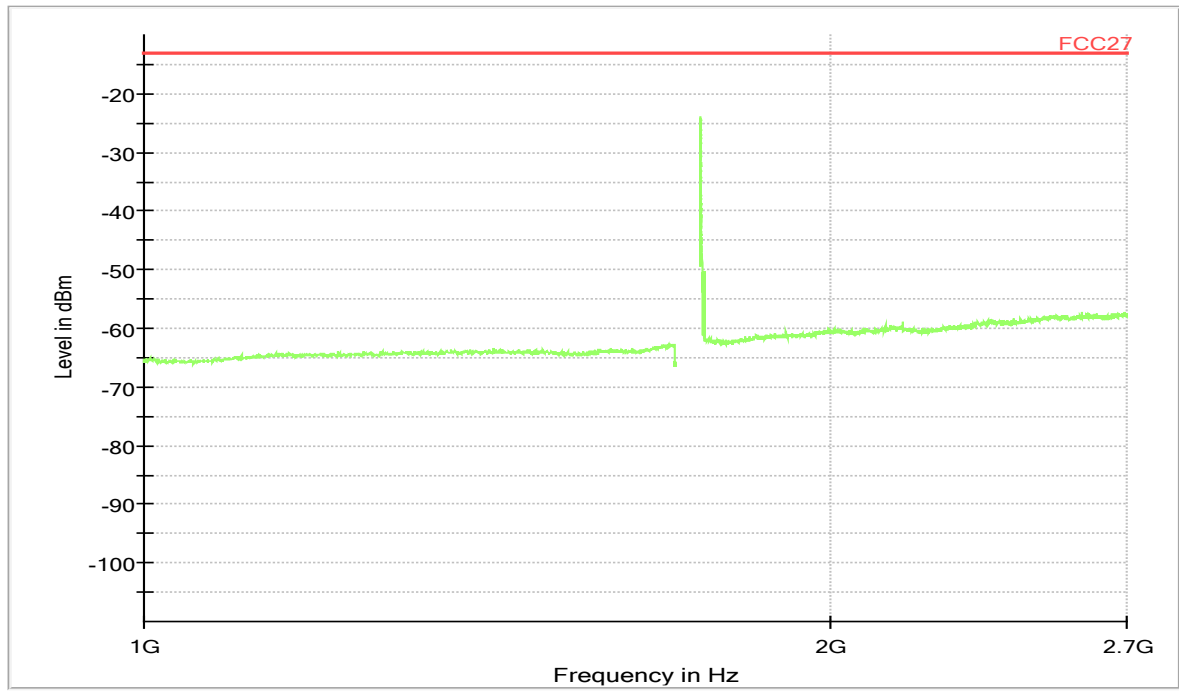

LTE eFDD 7, Channel = mid  
30 MHz - 1 GHz

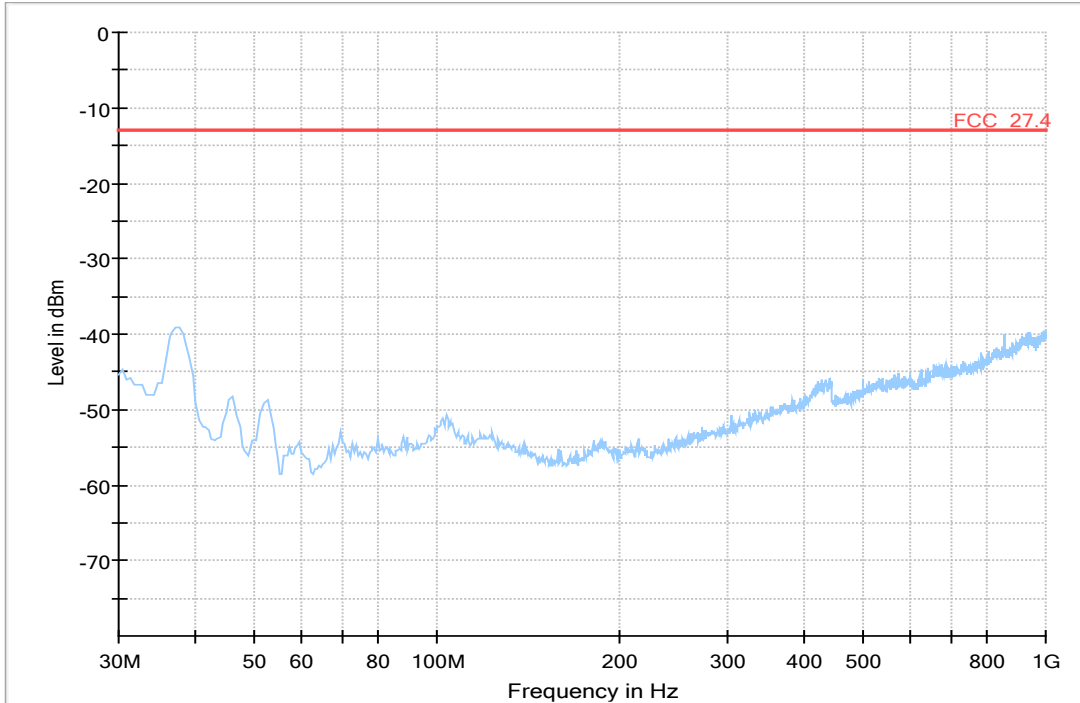

1 GHz - 26 GHz

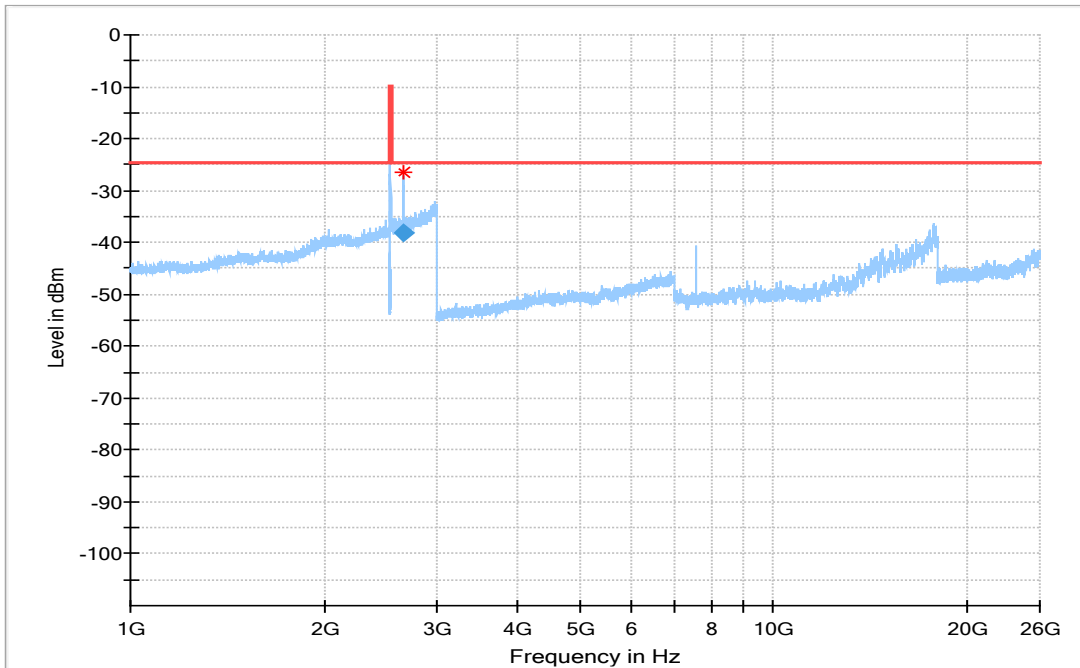

Frequency (MHz)	RMS (dBm)	Limit (dBm)	Margin (dB)	Meas. Time (ms)	Bandwidth (kHz)	Height (cm)	Pol	Azimuth (deg)	Elevation (deg)	Corr. (dB)
2654.337	-38.3	-25.00	13.31	1000.0	1000.000	150.0	H	-97.0	-15.0	-61.3

LTE eFDD 12, Channel = high  
30 MHz – 1 GHz

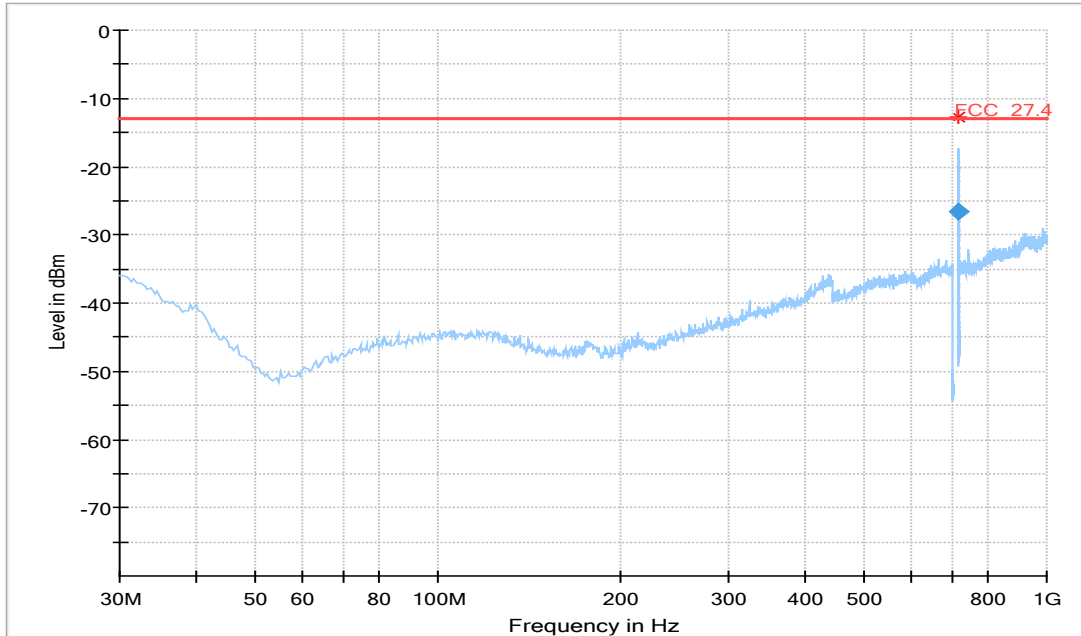

Frequency (MHz)	RMS (dBm)	Limit (dBm)	Margin (dB)	Meas. Time (ms)	Bandwidth (kHz)	Height (cm)	Pol	Azimuth (deg)	Corr. (dB)
716.000100	-26.55	-13.00	13.55	1000.0	30.000	131.0	H	134.0	-74.8

1 GHz – 10 GHz

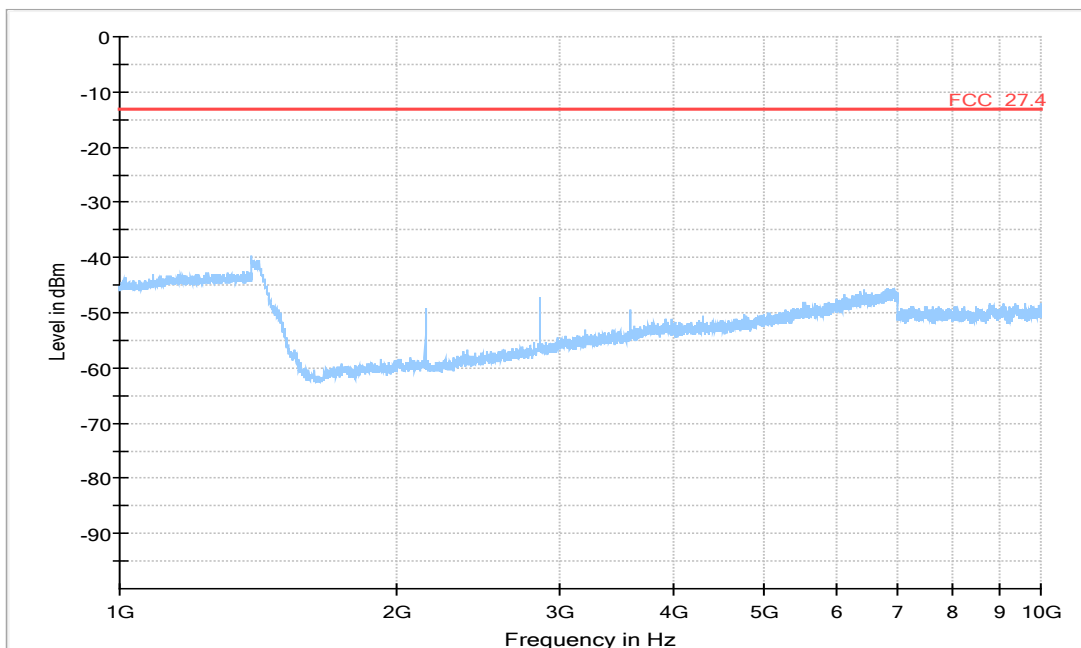

LTE eFDD 13, Channel = high  
30 MHz - 1 GHz

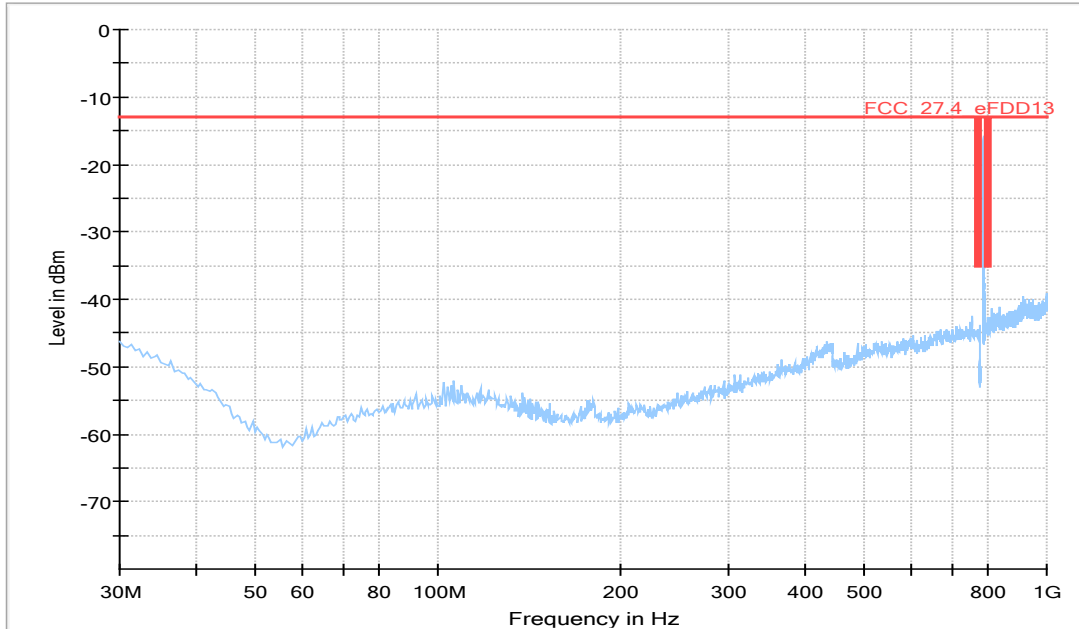

1 GHz - 10 GHz

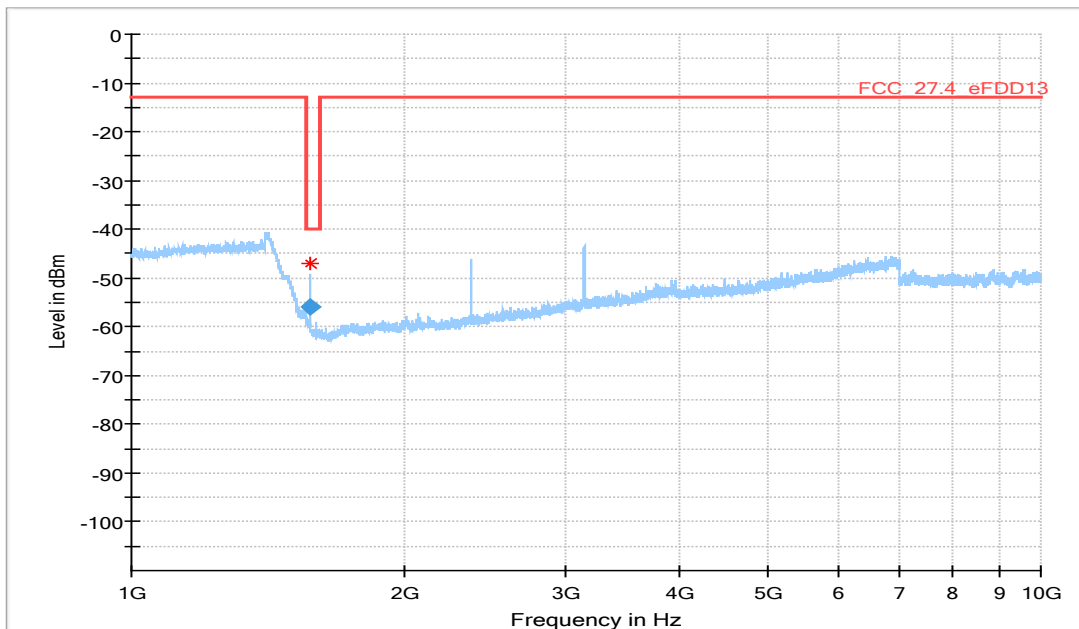

Frequency (MHz)	RMS (dBm)	Limit (dBm)	Margin (dB)	Meas. Time (ms)	Bandwidth (kHz)	Height (cm)	Pol	Azimuth (deg)	Elevation (deg)	Corr. (dB)
1573.133	-56.0	-40.00	16.00	1000.0	1000.000	150.0	V	158.0	98.0	-102.8

LTE eTDD 38, Channel = high  
30 MHz - 1 GHz

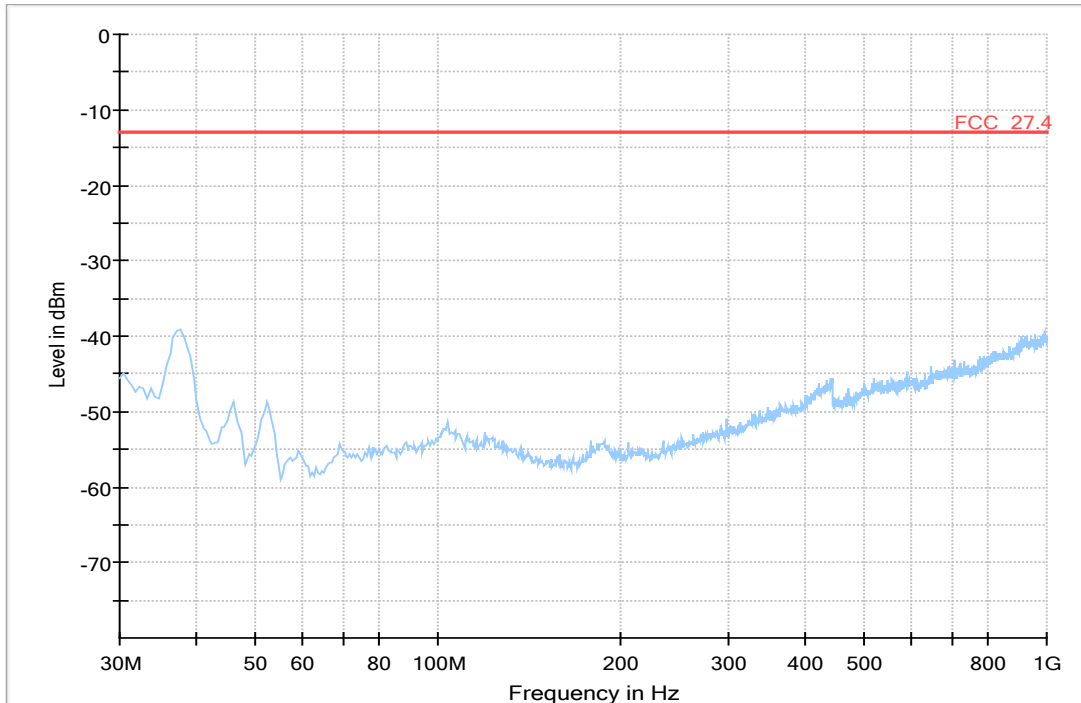

1 GHz - 26 GHz

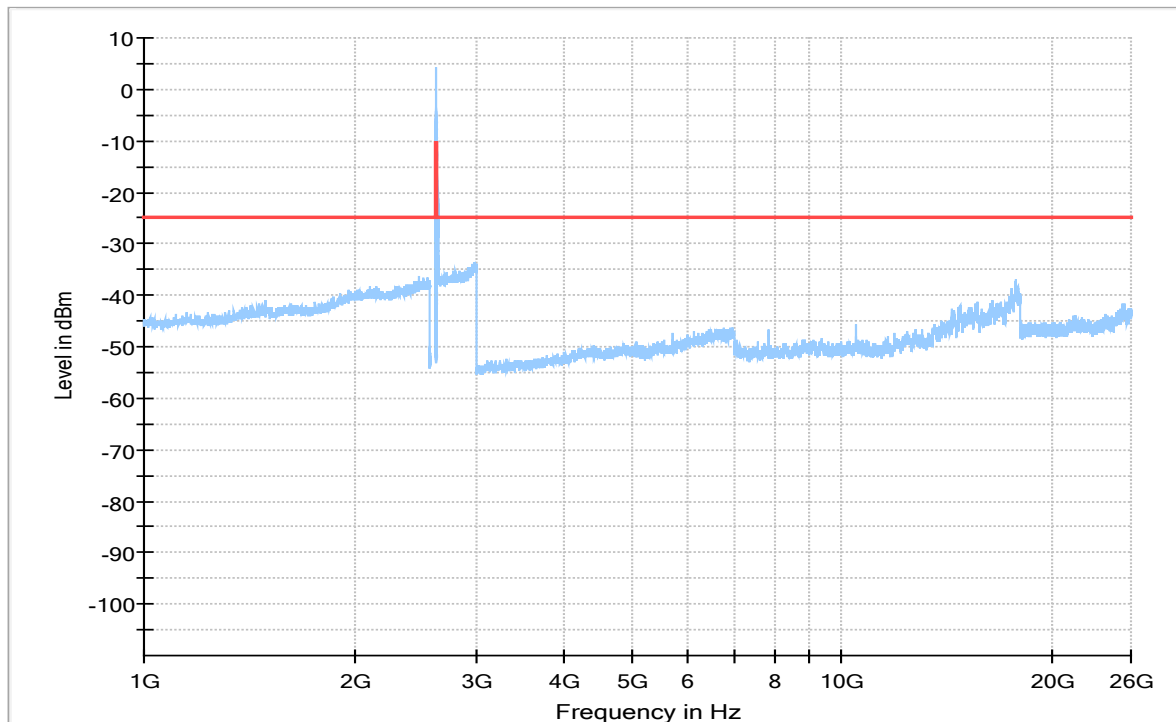

re-measurement at carrier

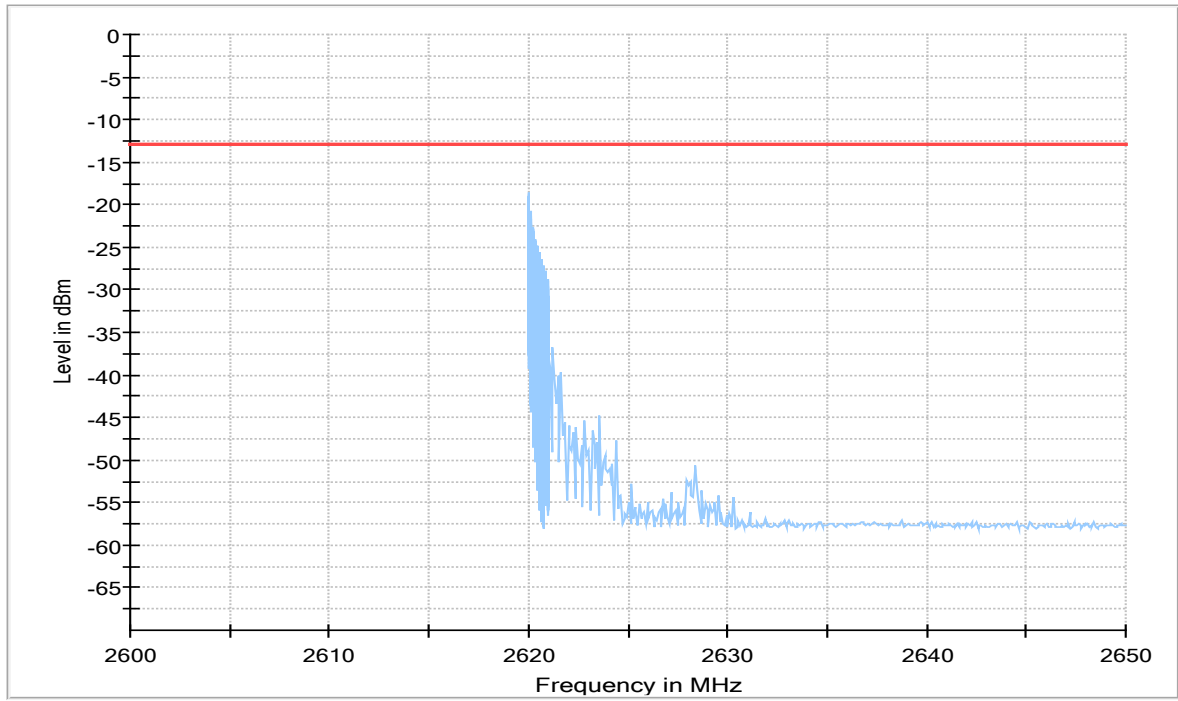

LTE eTDD 41, Channel = low  
30 MHz - 1 GHz

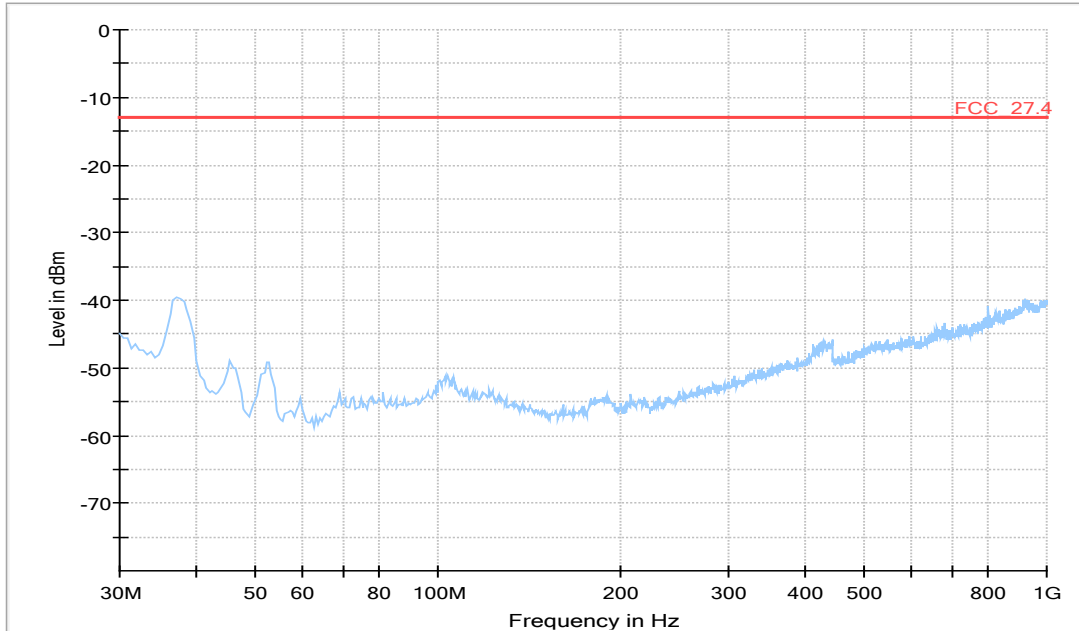

1 GHz - 26 GHz

