

FCC Measurement/Technical Report on

LARA-R6001 / LARA-R6001D

2G / 3G / LTE module

FCC ID: XPYUBX21BE01

IC: 8595A-UBX21BE01

Test Report Reference: MDE_UBLOX_2029_FCC_01

Test Laboratory:

7layers GmbH
Borsigstrasse 11
40880 Ratingen
Germany



Deutsche
Akkreditierungsstelle
D-PL-12140-01-01
D-PL-12140-01-02
D-PL-12140-01-03

Note:

The following test results relate only to the devices specified in this document. This report shall not be reproduced in parts without the written approval of the test laboratory.

7layers GmbH

Borsigstraße 11
40880 Ratingen, Germany
T +49 (0) 2102 749 0
F +49 (0) 2102 749 350

Geschäftsführer/
Managing Directors:
Frank Spiller
Bernhard Retka
Alexandre Norré-Oudard

Registergericht/registered:
Düsseldorf HRB 75554
USt-Id.-Nr./VAT-No. DE203159652
Steuer-Nr./TAX-No. 147/5869/0385

a Bureau Veritas
Group Company

www.7layers.com

Table of Contents

1	Applied Standards and Test Summary	4
1.1	Applied Standards	4
1.2	FCC-IC Correlation Table	6
1.3	Measurement Summary	10
2	Revision History / Signatures	45
3	Administrative Data	46
3.1	Testing Laboratory	46
3.2	Project Data	46
3.3	Applicant Data	46
3.4	Manufacturer Data	46
4	Test object Data	47
4.1	General EUT Description	47
4.2	EUT Main components	47
4.3	Ancillary Equipment	49
4.4	Auxiliary Equipment	49
4.5	EUT Setups	49
4.6	Operating Modes / Test Channels	50
4.7	Product labelling	51
5	Test Results	52
5.1	RF Output power	52
5.2	Frequency stability	61
5.3	Spurious emissions at antenna terminals	67
5.4	Field strength of spurious radiation	74
5.5	Emission and occupied bandwidth	87
5.6	Band edge compliance	95
5.7	Peak-average-ratio	102
5.8	RF Output power	105
5.9	Frequency stability	112
5.10	Spurious emissions at antenna terminal	119
5.11	Field strength of spurious radiation	125
5.12	Emission and occupied bandwidth	137
5.13	Band edge compliance	144
5.14	Peak to Average Ratio	150
5.15	RF Output Power	153
5.16	Frequency stability	166
5.17	Spurious emissions at antenna terminals	174
5.18	Field strength of spurious radiation	183
5.19	Emission and occupied bandwidth	200
5.20	Band edge compliance	209
5.21	Peak to Average Ratio	220
5.22	RF Output Power	227

5.23	Frequency stability	230
5.24	Spurious emissions at antenna terminals	232
5.25	Field strength of spurious radiation	235
5.26	Emission and occupied bandwidth	241
5.27	Band edge compliance	244
5.28	Peak to Average Ratio	247
5.29	RF Output Power	250
5.30	Spurious Emissions at antenna terminals	253
5.31	Field Strength of Spurious Radiation	256
5.32	Emission and Occupied Bandwidth	262
5.33	Band Edge	266
5.34	Peak to Average Ratio	269
6	Test Equipment	271
7	Antenna Factors, Cable Loss and Sample Calculations	275
7.1	LISN R&S ESH3-Z5 (150 kHz – 30 MHz)	275
7.2	Antenna R&S HFH2-Z2 (9 kHz – 30 MHz)	276
7.3	Antenna R&S HL562 (30 MHz – 1 GHz)	277
7.4	Antenna R&S HF907 (1 GHz – 18 GHz)	278
7.5	Antenna EMCO 3160-09 (18 GHz – 26.5 GHz)	279
7.6	Antenna EMCO 3160-10 (26.5 GHz – 40 GHz)	280
8	Measurement Uncertainties	281
9	Photo Report	285

1 APPLIED STANDARDS AND TEST SUMMARY

1.1 APPLIED STANDARDS

Type of Authorization

Certification for a cellular mobile device.

Applicable FCC Rules

Prepared in accordance with the requirements of FCC Rules and Regulations as listed in 47 CFR Ch.1 Parts 2 and 22, 24,27 and 90, (10-1-20 Edition). The following subparts are applicable to the results in this test report.

Part 2, Subpart J - Equipment Authorization Procedures, Certification

Part 22, Subpart H – Cellular Radiotelephone Service

- § 22.905 – Channels for cellular service
- § 22.913 – Effective radiated power limits
- § 22.917 – Emission limitations for cellular equipment

Part 24, Subpart E – Broadband PCS

- § 24.232 – Power and antenna height limits
- § 24.235 – Frequency stability
- § 24.238 – Emission limitations for Broadband PCS equipment

Part 27; Miscellaneous Wireless Communications Services
Subpart C – Technical standards

- § 27.50 – Power and duty cycle limits
- § 27.53 – Emission limits
- § 27.54 – Frequency stability

Part 27; Miscellaneous Wireless Communications Services
Subpart P – Technical standards

- § 27.1507 – Power and duty cycle limits
- § 27.1509 – Emission limits
- § 27.54 – Frequency stability

Part 90; Private Land Mobile Radio Services

Subpart S—REGULATIONS GOVERNING LICENSING AND USE OF FREQUENCIES IN THE 806-824, 851-869, 896-901, AND 935-940 MHZ BANDS

Subpart R—REGULATIONS GOVERNING THE LICENSING AND USE OF FREQUENCIES IN THE 763-775 AND 793-805 MHZ BANDS

§ 90.635 – Limitations on power and antenna height

§ 90.543 – Emission limitations

§ 90.539 – Frequency stability

The tests were selected and performed with reference to:

- FCC Public Notice 971168 applying “Measurement guidance for certification of licensed digital transmitters” 971168 D01 v03r01, 2018-04-09
- ANSI C63.26: 2015

1.2 FCC-IC CORRELATION TABLE

Correlation of measurement requirements for Cellular Mobile Devices from FCC and ISED Canada

Measurement	FCC reference	ISED reference
RF Output Power	§ 2.1046 § 22.913	RSS-GEN Issue 5, 6.12 RSS-132 Issue 3, 5.4
Peak-Average-Ratio	-	RSS 132 Issue 3: 5.4
Emission and Occupied bandwidth	§ 2.1049	RSS-GEN Issue 5, 6.7
Spurious Emission at Antenna Terminals	§ 2.1051 § 22.917	RSS-GEN Issue 5, 6.13 RSS-132 Issue 3, 5.5
Band Edge Compliance	§ 2.1051 § 22.917	RSS-GEN Issue 4, 6.13 RSS-132 Issue 3, 5.5
Frequency stability	§ 2.1055 § 22.355	RSS-GEN Issue 5, 6.11 RSS-132 Issue 3: 5.3
Field strength of spurious radiation	§ 2.1053 § 22.917	RSS-GEN Issue 5, 6.13 RSS-132 Issue 3: 5.5

**Correlation of measurement requirements for
Cellular Mobile Devices
from
FCC and ISED Canada**

Measurement	FCC reference	ISED reference
RF Output Power	§ 2.1046 § 24.232	RSS-GEN Issue 5, 6.12 RSS-133 Issue 6, 6.4
Peak-Average-Ratio	§ 24.232	RSS 133 Issue 6: 6.4
Emission and Occupied bandwidth	§ 2.1049	RSS-GEN Issue 5, 6.7
Spurious Emission at Antenna Terminals	§ 2.1051 § 24.238	RSS-GEN Issue 5, 6.13 RSS-133 Issue 6, 6.5
Band Edge Compliance	§ 2.1051 § 24.238	RSS-GEN Issue 5, 6.13 RSS-133 Issue 6, 6.5
Frequency stability	§ 2.1055 § 24.235	RSS-GEN Issue 5, 6.11 RSS-133 Issue 6: 6.3
Field strength of spurious radiation	§ 2.1053 § 24.236	RSS-GEN Issue 5, 6.13 RSS-133 Issue 6: 6.5

**Correlation of measurement requirements for
Cellular Mobile Devices
from
FCC and ISED Canada**

Measurement	FCC reference	ISED reference
RF Output Power	§ 2.1046 § 27.50 § 27.1507	RSS-GEN Issue 5, 6.12 RSS-130 Issue 2, 4.6.2/4.6.3 RSS-139 Issue 3, 6.5 RSS-199 Issue 3, 4.4
Peak to Average-Ratio	§ 27.50 § 27.1507	RSS-130 Issue 2: 4.6.1 RSS 139 Issue 3: 6.5 RSS-199 Issue 3, 4.4
Emission and Occupied bandwidth	§ 2.1049	RSS-GEN Issue 5, 6.7
Spurious Emission at Antenna Terminals	§ 2.1051 § 27.53 § 27.1509	RSS-GEN Issue 5, 6.13 RSS-130 Issue 2: 4.7.1/4.7.2 RSS-139 Issue 3, 6.6 RSS-199 Issue 3, 4.5
Band Edge Compliance	§ 2.1051 § 27.53 § 27.1509	RSS-GEN Issue 5, 6.13 RSS-130 Issue 2: 4.7.1/4.7.2 RSS-139 Issue 3, 6.6 RSS-199 Issue 3, 4.5
Frequency stability	§ 2.1055 § 27.54	RSS-GEN Issue 5, 6.11 RSS-130 Issue 2: 4.5 RSS-139 Issue 3: 6.4 RSS-199 Issue 3, 4.3
Field strength of spurious radiation	§ 2.1053 § 27.53 § 27.1509	RSS-GEN Issue 5, 6.13 RSS-130 Issue 2: 4.7.1/4.7.2 RSS-139 Issue 3: 6.6 RSS-199 Issue 3, 4.5

**Correlation of measurement requirements for
Cellular Mobile Devices
from
FCC and ISED Canada**

Measurement	FCC reference	ISED reference
RF Output Power	§ 2.1046 § 90.635	RSS-GEN Issue 5, 6.12 RSS-140 Issue 1, 4.3
Peak to Average-Ratio	§ 90.635	RSS-140 Issue 1, 4.3
Emission and Occupied bandwidth	§ 2.1049	RSS-GEN Issue 5, 6.7
Spurious Emission at Antenna Terminals	§ 2.1051 § 90.543	RSS-GEN Issue 5, 6.13 RSS-140 Issue 1, 4.4
Band Edge Compliance	§ 2.1051 § 90.543	RSS-GEN Issue 5, 6.13 RSS-140 Issue 1, 4.4
Frequency stability	§ 2.1055 § 90.539	RSS-GEN Issue 5, 6.11 RSS-140 Issue 1, 4.2
Field strength of spurious radiation	§ 2.1053 § 90.543	RSS-GEN Issue 5, 6.13 RSS-140 Issue 1, 4.4

1.3 MEASUREMENT SUMMARY

47 CFR CHAPTER I FCC PART 22 § 2.1046 § 22.913 Subpart H

RF Output power

The measurement was performed according to ANSI C63.26: 2015

Final Result

OP-Mode Technology, Radio Technology, Operating Frequency, ChBW, Ressource Blocks, Measurement method	Setup	Date	FCC	IC
GSM, GSM 850 EDGE, high channel, 0.2 MHz, conducted	S01_AB01	2021-07-15	Passed	Passed
GSM, GSM 850 EDGE, low channel, 0.2 MHz, conducted	S01_AB01	2021-07-15	Passed	Passed
GSM, GSM 850 EDGE, mid channel, 0.2 MHz, conducted	S01_AB01	2021-07-15	Passed	Passed
GSM, GSM 850, high channel, 0.2 MHz, conducted	S01_AB01	2021-07-15	Passed	Passed
GSM, GSM 850, low channel, 0.2 MHz, conducted	S01_AB01	2021-07-15	Passed	Passed
GSM, GSM 850, mid channel, 0.2 MHz, conducted	S01_AB01	2021-07-15	Passed	Passed
UTRA, FDD V HSDPA, Subtest 1, high channel, 5 MHz, cond.	S01_AS04	2021-08-26	Passed	Passed
UTRA, FDD V HSDPA, Subtest 1, low channel, 5 MHz, cond.	S01_AS04	2021-08-26	Passed	Passed
UTRA, FDD V HSDPA, Subtest 1, mid channel, 5 MHz, cond.	S01_AS04	2021-08-26	Passed	Passed
UTRA, FDD V HSDPA, Subtest 2, high channel, 5 MHz, cond.	S01_AY04	2021-08-28	Passed	Passed
UTRA, FDD V HSDPA, Subtest 2, low channel, 5 MHz, cond.	S01_AY04	2021-08-28	Passed	Passed
UTRA, FDD V HSDPA, Subtest 2, mid channel, 5 MHz, cond.	S01_AY04	2021-08-28	Passed	Passed
UTRA, FDD V HSDPA, Subtest 3, high channel, 5 MHz, cond.	S01_AY04	2021-08-28	Passed	Passed
UTRA, FDD V HSDPA, Subtest 3, low channel, 5 MHz, cond.	S01_AY04	2021-08-28	Passed	Passed
UTRA, FDD V HSDPA, Subtest 3, mid channel, 5 MHz, cond.	S01_AY04	2021-08-28	Passed	Passed
UTRA, FDD V HSDPA, Subtest 4, high channel, 5 MHz, cond.	S01_AY04	2021-08-28	Passed	Passed
UTRA, FDD V HSDPA, Subtest 4, low channel, 5 MHz, cond.	S01_AY04	2021-08-28	Passed	Passed
UTRA, FDD V HSDPA, Subtest 4, mid channel, 5 MHz, cond.	S01_AY04	2021-08-28	Passed	Passed
UTRA, FDD V HSUPA, Subtest 1, high channel, 5 MHz, cond.	S01_AS04	2021-09-15	Passed	Passed
UTRA, FDD V HSUPA, Subtest 1, low channel, 5 MHz, conducted	S01_AS04	2021-09-15	Passed	Passed
UTRA, FDD V HSUPA, Subtest 1, mid channel, 5 MHz, cond.	S01_AS04	2021-09-15	Passed	Passed
UTRA, FDD V HSUPA, Subtest 2, high channel, 5 MHz, cond.	S01_AY04	2021-09-27	Passed	Passed
UTRA, FDD V HSUPA, Subtest 2, low channel, 5 MHz, conducted	S01_AS04	2021-09-15	Passed	Passed
UTRA, FDD V HSUPA, Subtest 2, mid channel, 5 MHz, cond.	S01_AS04	2021-09-15	Passed	Passed
UTRA, FDD V HSUPA, Subtest 3, high channel, 5 MHz, cond.	S01_AS04	2021-09-15	Passed	Passed
UTRA, FDD V HSUPA, Subtest 3, low channel, 5 MHz, conducted	S01_AS04	2021-09-15	Passed	Passed
UTRA, FDD V HSUPA, Subtest 3, mid channel, 5 MHz, cond.	S01_AS04	2021-09-15	Passed	Passed
UTRA, FDD V HSUPA, Subtest 4, high channel, 5 MHz, cond.	S01_AS04	2021-09-15	Passed	Passed
UTRA, FDD V HSUPA, Subtest 4, low channel, 5 MHz, conducted	S01_AS04	2021-09-15	Passed	Passed
UTRA, FDD V HSUPA, Subtest 4, mid channel, 5 MHz, cond.	S01_AS04	2021-09-15	Passed	Passed
UTRA, FDD V HSUPA, Subtest 5, high channel, 5 MHz, cond.	S01_AS04	2021-09-15	Passed	Passed
UTRA, FDD V HSUPA, Subtest 5, low channel, 5 MHz, conducted	S01_AS04	2021-09-15	Passed	Passed
UTRA, FDD V HSUPA, Subtest 5, mid channel, 5 MHz, cond.	S01_AS04	2021-09-15	Passed	Passed
UTRA, FDD V, none, high channel, 5 MHz, conducted	S01_AS04	2021-09-15	Passed	Passed
UTRA, FDD V, none, low channel, 5 MHz, conducted	S01_AS04	2021-09-15	Passed	Passed
UTRA, FDD V, none, mid channel, 5 MHz, conducted	S01_AS04	2021-09-15	Passed	Passed
E-UTRA, eFDD 26 16QAM, high channel, 1.4 MHz, 1, conducted	S01_AS03	2021-08-14	Passed	Passed
E-UTRA, eFDD 26 16QAM, high channel, 1.4 MHz, 6, conducted	S01_AS03	2021-08-14	Passed	Passed
E-UTRA, eFDD 26 16QAM, high channel, 10 MHz, 1, conducted	S01_AS03	2021-08-14	Passed	Passed
E-UTRA, eFDD 26 16QAM, high channel, 3 MHz, 1, conducted	S01_AS04	2021-09-20	Passed	Passed
E-UTRA, eFDD 26 16QAM, high channel, 3 MHz, 15, conducted	S01_AS04	2021-09-20	Passed	Passed

47 CFR CHAPTER I FCC PART 22

§ 2.1046 § 22.913

Subpart H

RF Output power

The measurement was performed according to ANSI C63.26: 2015

Final Result

OP-Mode	Setup	Date	FCC	IC
Technology, Radio Technology, Operating Frequency, ChBW, Ressource Blocks, Measurement method				
E-UTRA, eFDD 26 16QAM, high channel, 5 MHz, 1, conducted	S01_AS03	2021-08-14	Passed	Passed
E-UTRA, eFDD 26 16QAM, high channel, 5 MHz, 25, conducted	S01_AS03	2021-08-14	Passed	Passed
E-UTRA, eFDD 26 16QAM, low channel, 1.4 MHz, 1, conducted	S01_AS03	2021-08-14	Passed	Passed
E-UTRA, eFDD 26 16QAM, low channel, 1.4 MHz, 6, conducted	S01_AS03	2021-08-14	Passed	Passed
E-UTRA, eFDD 26 16QAM, low channel, 10 MHz, 1, conducted	S01_AS03	2021-08-14	Passed	Passed
E-UTRA, eFDD 26 16QAM, low channel, 3 MHz, 1, conducted	S01_AS03	2021-08-14	Passed	Passed
E-UTRA, eFDD 26 16QAM, low channel, 3 MHz, 15, conducted	S01_AS03	2021-08-14	Passed	Passed
E-UTRA, eFDD 26 16QAM, low channel, 5 MHz, 1, conducted	S01_AS03	2021-08-14	Passed	Passed
E-UTRA, eFDD 26 16QAM, low channel, 5 MHz, 25, conducted	S01_AS03	2021-08-14	Passed	Passed
E-UTRA, eFDD 26 16QAM, mid channel, 1.4 MHz, 1, conducted	S01_AS03	2021-08-14	Passed	Passed
E-UTRA, eFDD 26 16QAM, mid channel, 1.4 MHz, 6, conducted	S01_AS03	2021-08-14	Passed	Passed
E-UTRA, eFDD 26 16QAM, mid channel, 10 MHz, 1, conducted	S01_AS03	2021-08-14	Passed	Passed
E-UTRA, eFDD 26 16QAM, mid channel, 3 MHz, 1, conducted	S01_AS03	2021-08-14	Passed	Passed
E-UTRA, eFDD 26 16QAM, mid channel, 3 MHz, 15, conducted	S01_AS03	2021-08-14	Passed	Passed
E-UTRA, eFDD 26 16QAM, mid channel, 5 MHz, 1, conducted	S01_AS03	2021-08-14	Passed	Passed
E-UTRA, eFDD 26 16QAM, mid channel, 5 MHz, 25, conducted	S01_AS03	2021-08-14	Passed	Passed
E-UTRA, eFDD 26 QPSK, high channel, 1.4 MHz, 1, conducted	S01_AR03	2021-08-10	Passed	Passed
E-UTRA, eFDD 26 QPSK, high channel, 1.4 MHz, 3, conducted	S01_AR03	2021-08-10	Passed	Passed
E-UTRA, eFDD 26 QPSK, high channel, 1.4 MHz, 6, conducted	S01_AR03	2021-08-10	Passed	Passed
E-UTRA, eFDD 26 QPSK, high channel, 10 MHz, 1, conducted	S01_AR03	2021-08-10	Passed	Passed
E-UTRA, eFDD 26 QPSK, high channel, 10 MHz, 50, conducted	S01_AR03	2021-08-10	Passed	Passed
E-UTRA, eFDD 26 QPSK, high channel, 3 MHz, 1, conducted	S01_AS04	2021-09-20	Passed	Passed
E-UTRA, eFDD 26 QPSK, high channel, 3 MHz, 15, conducted	S01_AS04	2021-09-20	Passed	Passed
E-UTRA, eFDD 26 QPSK, high channel, 5 MHz, 1, conducted	S01_AR03	2021-08-10	Passed	Passed
E-UTRA, eFDD 26 QPSK, high channel, 5 MHz, 12, conducted	S01_AR03	2021-08-10	Passed	Passed
E-UTRA, eFDD 26 QPSK, high channel, 5 MHz, 25, conducted	S01_AR03	2021-08-10	Passed	Passed
E-UTRA, eFDD 26 QPSK, low channel, 1.4 MHz, 1, conducted	S01_AR03	2021-08-10	Passed	Passed
E-UTRA, eFDD 26 QPSK, low channel, 1.4 MHz, 3, conducted	S01_AR03	2021-08-10	Passed	Passed
E-UTRA, eFDD 26 QPSK, low channel, 1.4 MHz, 6, conducted	S01_AR03	2021-08-10	Passed	Passed
E-UTRA, eFDD 26 QPSK, low channel, 10 MHz, 1, conducted	S01_AR03	2021-08-10	Passed	Passed
E-UTRA, eFDD 26 QPSK, low channel, 10 MHz, 50, conducted	S01_AR03	2021-08-10	Passed	Passed
E-UTRA, eFDD 26 QPSK, low channel, 3 MHz, 1, conducted	S01_AR03	2021-08-10	Passed	Passed
E-UTRA, eFDD 26 QPSK, low channel, 3 MHz, 15, conducted	S01_AR03	2021-08-10	Passed	Passed
E-UTRA, eFDD 26 QPSK, low channel, 5 MHz, 1, conducted	S01_AR03	2021-08-10	Passed	Passed
E-UTRA, eFDD 26 QPSK, low channel, 5 MHz, 12, conducted	S01_AR03	2021-08-10	Passed	Passed
E-UTRA, eFDD 26 QPSK, low channel, 5 MHz, 25, conducted	S01_AR03	2021-08-10	Passed	Passed
E-UTRA, eFDD 26 QPSK, mid channel, 1.4 MHz, 1, conducted	S01_AR03	2021-08-10	Passed	Passed
E-UTRA, eFDD 26 QPSK, mid channel, 1.4 MHz, 3, conducted	S01_AR03	2021-08-10	Passed	Passed
E-UTRA, eFDD 26 QPSK, mid channel, 1.4 MHz, 6, conducted	S01_AR03	2021-08-10	Passed	Passed
E-UTRA, eFDD 26 QPSK, mid channel, 10 MHz, 1, conducted	S01_AR03	2021-08-10	Passed	Passed
E-UTRA, eFDD 26 QPSK, mid channel, 10 MHz, 50, conducted	S01_AR03	2021-08-10	Passed	Passed
E-UTRA, eFDD 26 QPSK, mid channel, 3 MHz, 1, conducted	S01_AR03	2021-08-10	Passed	Passed
E-UTRA, eFDD 26 QPSK, mid channel, 3 MHz, 15, conducted	S01_AR03	2021-08-10	Passed	Passed
E-UTRA, eFDD 26 QPSK, mid channel, 5 MHz, 1, conducted	S01_AR03	2021-08-10	Passed	Passed
E-UTRA, eFDD 26 QPSK, mid channel, 5 MHz, 12, conducted	S01_AR03	2021-08-10	Passed	Passed

47 CFR CHAPTER I FCC PART 22

§ 2.1046 § 22.913

Subpart H

RF Output power

The measurement was performed according to ANSI C63.26: 2015

Final Result

OP-Mode	Setup	Date	FCC	IC
Technology, Radio Technology, Operating Frequency, ChBW, Ressource Blocks, Measurement method				
E-UTRA, eFDD 26 QPSK, mid channel, 5 MHz, 25, conducted	S01_AR03	2021-08-10	Passed	Passed
E-UTRA, eFDD 5 16QAM, high channel, 1.4 MHz, 1, conducted	S01_AS03	2021-08-12	Passed	Passed
E-UTRA, eFDD 5 16QAM, high channel, 1.4 MHz, 6, conducted	S01_AS03	2021-08-12	Passed	Passed
E-UTRA, eFDD 5 16QAM, high channel, 10 MHz, 1, conducted	S01_AS03	2021-08-12	Passed	Passed
E-UTRA, eFDD 5 16QAM, high channel, 3 MHz, 1, conducted	S01_AS03	2021-08-12	Passed	Passed
E-UTRA, eFDD 5 16QAM, high channel, 3 MHz, 15, conducted	S01_AS03	2021-08-12	Passed	Passed
E-UTRA, eFDD 5 16QAM, high channel, 5 MHz, 1, conducted	S01_AS03	2021-08-16	Passed	Passed
E-UTRA, eFDD 5 16QAM, high channel, 5 MHz, 25, conducted	S01_AS03	2021-08-16	Passed	Passed
E-UTRA, eFDD 5 16QAM, low channel, 1.4 MHz, 1, conducted	S01_AS03	2021-08-12	Passed	Passed
E-UTRA, eFDD 5 16QAM, low channel, 1.4 MHz, 6, conducted	S01_AS03	2021-08-12	Passed	Passed
E-UTRA, eFDD 5 16QAM, low channel, 10 MHz, 1, conducted	S01_AS03	2021-08-14	Passed	Passed
E-UTRA, eFDD 5 16QAM, low channel, 3 MHz, 1, conducted	S01_AS03	2021-08-12	Passed	Passed
E-UTRA, eFDD 5 16QAM, low channel, 3 MHz, 15, conducted	S01_AS03	2021-08-12	Passed	Passed
E-UTRA, eFDD 5 16QAM, low channel, 5 MHz, 1, conducted	S01_AS03	2021-08-16	Passed	Passed
E-UTRA, eFDD 5 16QAM, low channel, 5 MHz, 25, conducted	S01_AS03	2021-08-16	Passed	Passed
E-UTRA, eFDD 5 16QAM, mid channel, 1.4 MHz, 1, conducted	S01_AS03	2021-08-12	Passed	Passed
E-UTRA, eFDD 5 16QAM, mid channel, 1.4 MHz, 6, conducted	S01_AS03	2021-08-12	Passed	Passed
E-UTRA, eFDD 5 16QAM, mid channel, 10 MHz, 1, conducted	S01_AS03	2021-08-12	Passed	Passed
E-UTRA, eFDD 5 16QAM, mid channel, 3 MHz, 1, conducted	S01_AS03	2021-08-12	Passed	Passed
E-UTRA, eFDD 5 16QAM, mid channel, 3 MHz, 15, conducted	S01_AS03	2021-08-12	Passed	Passed
E-UTRA, eFDD 5 16QAM, mid channel, 5 MHz, 1, conducted	S01_AS03	2021-08-12	Passed	Passed
E-UTRA, eFDD 5 16QAM, mid channel, 5 MHz, 25, conducted	S01_AS03	2021-08-12	Passed	Passed
E-UTRA, eFDD 5 QPSK, high channel, 1.4 MHz, 1, conducted	S01_AR03	2021-08-10	Passed	Passed
E-UTRA, eFDD 5 QPSK, high channel, 1.4 MHz, 3, conducted	S01_AR03	2021-08-10	Passed	Passed
E-UTRA, eFDD 5 QPSK, high channel, 1.4 MHz, 6, conducted	S01_AR03	2021-08-10	Passed	Passed
E-UTRA, eFDD 5 QPSK, high channel, 10 MHz, 1, conducted	S01_AR03	2021-08-10	Passed	Passed
E-UTRA, eFDD 5 QPSK, high channel, 10 MHz, 50, conducted	S01_AR03	2021-08-10	Passed	Passed
E-UTRA, eFDD 5 QPSK, high channel, 3 MHz, 1, conducted	S01_AR03	2021-08-10	Passed	Passed
E-UTRA, eFDD 5 QPSK, high channel, 3 MHz, 15, conducted	S01_AR03	2021-08-10	Passed	Passed
E-UTRA, eFDD 5 QPSK, high channel, 5 MHz, 1, conducted	S01_AS03	2021-08-14	Passed	Passed
E-UTRA, eFDD 5 QPSK, high channel, 5 MHz, 12, conducted	S01_AS03	2021-08-14	Passed	Passed
E-UTRA, eFDD 5 QPSK, high channel, 5 MHz, 25, conducted	S01_AS03	2021-08-14	Passed	Passed
E-UTRA, eFDD 5 QPSK, low channel, 1.4 MHz, 1, conducted	S01_AR03	2021-08-10	Passed	Passed
E-UTRA, eFDD 5 QPSK, low channel, 1.4 MHz, 3, conducted	S01_AR03	2021-08-10	Passed	Passed
E-UTRA, eFDD 5 QPSK, low channel, 1.4 MHz, 6, conducted	S01_AR03	2021-08-10	Passed	Passed
E-UTRA, eFDD 5 QPSK, low channel, 10 MHz, 1, conducted	S01_AR03	2021-08-10	Passed	Passed
E-UTRA, eFDD 5 QPSK, low channel, 10 MHz, 50, conducted	S01_AR03	2021-08-10	Passed	Passed
E-UTRA, eFDD 5 QPSK, low channel, 3 MHz, 1, conducted	S01_AR03	2021-08-10	Passed	Passed
E-UTRA, eFDD 5 QPSK, low channel, 3 MHz, 15, conducted	S01_AR03	2021-08-10	Passed	Passed
E-UTRA, eFDD 5 QPSK, low channel, 5 MHz, 1, conducted	S01_AS03	2021-08-14	Passed	Passed
E-UTRA, eFDD 5 QPSK, low channel, 5 MHz, 12, conducted	S01_AS03	2021-08-14	Passed	Passed
E-UTRA, eFDD 5 QPSK, low channel, 5 MHz, 25, conducted	S01_AS03	2021-08-14	Passed	Passed
E-UTRA, eFDD 5 QPSK, mid channel, 1.4 MHz, 1, conducted	S01_AR03	2021-08-10	Passed	Passed
E-UTRA, eFDD 5 QPSK, mid channel, 1.4 MHz, 3, conducted	S01_AR03	2021-08-10	Passed	Passed
E-UTRA, eFDD 5 QPSK, mid channel, 1.4 MHz, 6, conducted	S01_AR03	2021-08-10	Passed	Passed

47 CFR CHAPTER I FCC PART 22 § 2.1046 § 22.913

Subpart H

RF Output power

The measurement was performed according to ANSI C63.26: 2015

Final Result

OP-Mode	Setup	Date	FCC	IC
Technology, Radio Technology, Operating Frequency, ChBW, Ressource Blocks, Measurement method				
E-UTRA, eFDD 5 QPSK, mid channel, 10 MHz, 1, conducted	S01_AR03	2021-08-10	Passed	Passed
E-UTRA, eFDD 5 QPSK, mid channel, 10 MHz, 50, conducted	S01_AR03	2021-08-10	Passed	Passed
E-UTRA, eFDD 5 QPSK, mid channel, 3 MHz, 1, conducted	S01_AR03	2021-08-10	Passed	Passed
E-UTRA, eFDD 5 QPSK, mid channel, 3 MHz, 15, conducted	S01_AR03	2021-08-10	Passed	Passed
E-UTRA, eFDD 5 QPSK, mid channel, 5 MHz, 1, conducted	S01_AR03	2021-08-10	Passed	Passed
E-UTRA, eFDD 5 QPSK, mid channel, 5 MHz, 12, conducted	S01_AR03	2021-08-10	Passed	Passed
E-UTRA, eFDD 5 QPSK, mid channel, 5 MHz, 25, conducted	S01_AR03	2021-08-10	Passed	Passed

47 CFR CHAPTER I FCC PART 22 § 2.1055 § 22.355

Subpart H

Frequency stability

The measurement was performed according to ANSI C63.26: 2015

Final Result

OP-Mode	Setup	Date	FCC	IC
Technology, Radio Technology, Operating Frequency, ChBW, Measurement method				
GSM, GSM 850 EDGE, mid channel, 0.2 MHz, conducted	S01_AB01	2021-07-23	Passed	Passed
GSM, GSM 850 GPRS, mid channel, 0.2 MHz, conducted	S01_AB01	2021-07-21	Passed	Passed
UTRA, FDD V HSDPA, Subtest 1, mid channel, 5 MHz, cond.	S01_AY04	2021-08-30	Passed	Passed
UTRA, FDD V HSUPA, Subtest 1, mid channel, 5 MHz, cond.	S01_AY04	2021-09-03	Passed	Passed
UTRA, FDD V, none, mid channel, 5 MHz, conducted	S01_AY04	2021-09-01	Passed	Passed
E-UTRA, eFDD 5 QPSK, mid channel, 5 MHz, 1, conducted	S01_AS04	2021-09-05	Passed	Passed
E-UTRA, eFDD 26 QPSK, mid channel, 5 MHz, 1, conducted	S01_AS04	2021-09-05	Passed	Passed

47 CFR CHAPTER I FCC PART 22 § 2.1051 § 22.917

Subpart H

Spurious emissions at antenna terminals

The measurement was performed according to ANSI C63.26: 2015

Final Result

OP-Mode	Setup	Date	FCC	IC
Technology, Radio Technology, Operating Frequency, ChBW, Measurement method				
GSM, GSM 850 EDGE, high channel, 0.2 MHz, conducted	S01_AB01	2021-07-19	Passed	Passed
GSM, GSM 850 EDGE, low channel, 0.2 MHz, conducted	S01_AB01	2021-07-19	Passed	Passed
GSM, GSM 850 EDGE, mid channel, 0.2 MHz, conducted	S01_AB01	2021-07-19	Passed	Passed
GSM, GSM 850 GPRS, high channel, 0.2 MHz, conducted	S01_AB01	2021-07-19	Passed	Passed
GSM, GSM 850 GPRS, low channel, 0.2 MHz, conducted	S01_AB01	2021-07-19	Passed	Passed
GSM, GSM 850 GPRS, mid channel, 0.2 MHz, conducted	S01_AB01	2021-07-19	Passed	Passed
UTRA, FDD V HSDPA, Subtest 1, high channel, 5 MHz, cond.	S01_AY04	2021-08-28	Passed	Passed
UTRA, FDD V HSDPA, Subtest 1, low channel, 5 MHz, cond.	S01_AY04	2021-08-28	Passed	Passed
UTRA, FDD V HSDPA, Subtest 1, mid channel, 5 MHz, cond.	S01_AY04	2021-08-28	Passed	Passed
UTRA, FDD V HSUPA, Subtest 1, high channel, 5 MHz, cond.	S01_AS04	2021-09-15	Passed	Passed
UTRA, FDD V HSUPA, Subtest 1, low channel, 5 MHz, conducted	S01_AS04	2021-09-15	Passed	Passed
UTRA, FDD V HSUPA, Subtest 1, mid channel, 5 MHz, cond.	S01_AS04	2021-09-15	Passed	Passed

47 CFR CHAPTER I FCC PART 22

§ 2.1051 § 22.917

Subpart H

Spurious emissions at antenna terminals

The measurement was performed according to ANSI C63.26: 2015

Final Result

OP-Mode	Setup	Date	FCC	IC
Technology, Radio Technology, Operating Frequency, ChBW, Measurement method				
UTRA, FDD V, none, high channel, 5 MHz, conducted	S01_AS04	2021-09-15	Passed	Passed
UTRA, FDD V, none, low channel, 5 MHz, conducted	S01_AS04	2021-09-15	Passed	Passed
UTRA, FDD V, none, mid channel, 5 MHz, conducted	S01_AS04	2021-09-15	Passed	Passed
E-UTRA, eFDD 5 QPSK, high channel, 5 MHz, 1, conducted	S01_AS03	2021-08-12	Passed	Passed
E-UTRA, eFDD 5 QPSK, low channel, 5 MHz, 1, conducted	S01_AS03	2021-08-12	Passed	Passed
E-UTRA, eFDD 5 QPSK, mid channel, 5 MHz, 1, conducted	S01_AS03	2021-08-12	Passed	Passed
E-UTRA, eFDD 26 QPSK, high channel, 5 MHz, 1, conducted	S01_AS04	2021-10-21	Passed	Passed
E-UTRA, eFDD 26 QPSK, low channel, 5 MHz, 1, conducted	S01_AS04	2021-10-21	Passed	Passed
E-UTRA, eFDD 26 QPSK, mid channel, 5 MHz, 1, conducted	S01_AS04	2021-10-21	Passed	Passed

47 CFR CHAPTER I FCC PART 22

§ 2.1053 § 22.917

Subpart H

Field strength of spurious radiation

The measurement was performed according to ANSI C63.26: 2015

Final Result

OP-Mode	Setup	Date	FCC	IC
Technology, Radio Technology, Operating Frequency, ChBW, Measurement method				
GSM, GSM 850 EDGE, high channel, 0.2 MHz, radiated	S01_AB04	2021-10-03	Passed	Passed
GSM, GSM 850 EDGE, low channel, 0.2 MHz, radiated	S01_AB04	2021-10-03	Passed	Passed
GSM, GSM 850 EDGE, mid channel, 0.2 MHz, radiated	S01_AB04	2021-10-03	Passed	Passed
GSM, GSM 850 GPRS, high channel, 0.2 MHz, radiated	S01_AB04	2021-10-03	Passed	Passed
GSM, GSM 850 GPRS, low channel, 0.2 MHz, radiated	S01_AB04	2021-10-03	Passed	Passed
GSM, GSM 850 GPRS, mid channel, 0.2 MHz, radiated	S01_AB04	2021-10-03	Passed	Passed
UTRA, FDD V HSDPA, Subtest 1, high channel, 5 MHz, radiated	S01_AS04	2021-09-29	Passed	Passed
UTRA, FDD V HSDPA, Subtest 1, low channel, 5 MHz, radiated	S01_AS04	2021-09-29	Passed	Passed
UTRA, FDD V HSDPA, Subtest 1, mid channel, 5 MHz, radiated	S01_AS04	2021-09-29	Passed	Passed
UTRA, FDD V HSUPA, Subtest 1, high channel, 5 MHz, radiated	S01_AS04	2021-09-29	Passed	Passed
UTRA, FDD V HSUPA, Subtest 1, low channel, 5 MHz, radiated	S01_AS04	2021-09-29	Passed	Passed
UTRA, FDD V HSUPA, Subtest 1, mid channel, 5 MHz, radiated	S01_AS04	2021-09-29	Passed	Passed
UTRA, FDD V, none, high channel, 5 MHz, radiated	S01_AS04	2021-09-29	Passed	Passed
UTRA, FDD V, none, low channel, 5 MHz, radiated	S01_AS04	2021-09-29	Passed	Passed
UTRA, FDD V, none, mid channel, 5 MHz, radiated	S01_AS04	2021-09-29	Passed	Passed
E-UTRA, eFDD 26 QPSK, high channel, 5 MHz, 1, radiated	S01_AS04	2021-09-29	Passed	Passed
E-UTRA, eFDD 26 QPSK, low channel, 5 MHz, 1, radiated	S01_AS04	2021-09-29	Passed	Passed
E-UTRA, eFDD 26 QPSK, mid channel, 5 MHz, 1, radiated	S01_AS04	2021-09-29	Passed	Passed
E-UTRA, eFDD 5 QPSK, high channel, 5 MHz, 1, radiated	S01_AS04	2021-09-29	Passed	Passed
E-UTRA, eFDD 5 QPSK, low channel, 5 MHz, 1, radiated	S01_AS04	2021-09-29	Passed	Passed
E-UTRA, eFDD 5 QPSK, mid channel, 5 MHz, 1, radiated	S01_AS04	2021-09-29	Passed	Passed

47 CFR CHAPTER I FCC PART 22
Subpart H

§ 2.1049

Emission and occupied bandwidth

The measurement was performed according to ANSI C63.26: 2015

Final Result

OP-Mode	Setup	Date	FCC	IC
Technology, Radio Technology, Operating Frequency, ChBW, Measurement method				
GSM, GSM 850 EDGE, high channel, 0.2 MHz, conducted	S01_AS04	2021-09-20	Passed	Passed
GSM, GSM 850 EDGE, low channel, 0.2 MHz, conducted	S01_AS04	2021-09-20	Passed	Passed
GSM, GSM 850 EDGE, mid channel, 0.2 MHz, conducted	S01_AS04	2021-09-20	Passed	Passed
GSM, GSM 850, high channel, 0.2 MHz, conducted	S01_AS04	2021-09-20	Passed	Passed
GSM, GSM 850, low channel, 0.2 MHz, conducted	S01_AS04	2021-09-20	Passed	Passed
GSM, GSM 850, mid channel, 0.2 MHz, conducted	S01_AS04	2021-09-20	Passed	Passed
UTRA, FDD V HSDPA, Subtest 1, high channel, 5 MHz, conducted	S01_AS04	2021-08-26	Passed	Passed
UTRA, FDD V HSDPA, Subtest 1, low channel, 5 MHz, conducted	S01_AS04	2021-08-26	Passed	Passed
UTRA, FDD V HSDPA, Subtest 1, mid channel, 5 MHz, conducted	S01_AS04	2021-08-26	Passed	Passed
UTRA, FDD V, none, high channel, 5 MHz, conducted	S01_AS04	2021-09-15	Passed	Passed
UTRA, FDD V, none, low channel, 5 MHz, conducted	S01_AS04	2021-09-15	Passed	Passed
UTRA, FDD V, none, mid channel, 5 MHz, conducted	S01_AS04	2021-09-15	Passed	Passed
UTRA, FDD V HSUPA, Subtest 1, high channel, 5 MHz, conducted	S01_AY04	2021-09-27	Passed	Passed
UTRA, FDD V HSUPA, Subtest 1, low channel, 5 MHz, conducted	S01_AY04	2021-09-27	Passed	Passed
UTRA, FDD V HSUPA, Subtest 1, mid channel, 5 MHz, conducted	S01_AY04	2021-09-27	Passed	Passed
UTRA, FDD V HSUPA, Subtest 5, high channel, 5 MHz, conducted	S01_AY04	2021-09-27	Passed	Passed
UTRA, FDD V HSUPA, Subtest 5, low channel, 5 MHz, conducted	S01_AY04	2021-09-27	Passed	Passed
UTRA, FDD V HSUPA, Subtest 5, mid channel, 5 MHz, conducted	S01_AY04	2021-09-27	Passed	Passed
E-UTRA, eFDD 26 16QAM, high channel, 1.4 MHz, 6, conducted	S01_AS04	2021-08-26	Passed	Passed
E-UTRA, eFDD 26 16QAM, high channel, 3 MHz, 15, conducted	S01_AS04	2021-08-26	Passed	Passed
E-UTRA, eFDD 26 16QAM, high channel, 5 MHz, 25, conducted	S01_AS04	2021-08-26	Passed	Passed
E-UTRA, eFDD 26 16QAM, low channel, 1.4 MHz, 6, conducted	S01_AS04	2021-08-26	Passed	Passed
E-UTRA, eFDD 26 16QAM, low channel, 3 MHz, 15, conducted	S01_AS04	2021-08-26	Passed	Passed
E-UTRA, eFDD 26 16QAM, low channel, 5 MHz, 25, conducted	S01_AS04	2021-08-26	Passed	Passed
E-UTRA, eFDD 26 16QAM, mid channel, 1.4 MHz, 6, conducted	S01_AS04	2021-08-26	Passed	Passed
E-UTRA, eFDD 26 16QAM, mid channel, 3 MHz, 15, conducted	S01_AS04	2021-08-26	Passed	Passed
E-UTRA, eFDD 26 16QAM, mid channel, 5 MHz, 25, conducted	S01_AS04	2021-08-26	Passed	Passed
E-UTRA, eFDD 26 QPSK, high channel, 1.4 MHz, 6, conducted	S01_AR03	2021-10-08	Passed	Passed
E-UTRA, eFDD 26 QPSK, high channel, 10 MHz, 50, conducted	S01_AR03	2021-10-08	Passed	Passed
E-UTRA, eFDD 26 QPSK, high channel, 10 MHz, 50, conducted	S01_AR03	2021-10-08	Passed	Passed
E-UTRA, eFDD 26 QPSK, high channel, 3 MHz, 15, conducted	S01_AR03	2021-10-08	Passed	Passed
E-UTRA, eFDD 26 QPSK, high channel, 5 MHz, 25, conducted	S01_AR03	2021-10-08	Passed	Passed
E-UTRA, eFDD 26 QPSK, low channel, 1.4 MHz, 6, conducted	S01_AR03	2021-10-08	Passed	Passed
E-UTRA, eFDD 26 QPSK, low channel, 10 MHz, 50, conducted	S01_AR03	2021-10-08	Passed	Passed
E-UTRA, eFDD 26 QPSK, low channel, 3 MHz, 15, conducted	S01_AR03	2021-10-08	Passed	Passed
E-UTRA, eFDD 26 QPSK, low channel, 5 MHz, 25, conducted	S01_AR03	2021-10-08	Passed	Passed
E-UTRA, eFDD 26 QPSK, mid channel, 1.4 MHz, 6, conducted	S01_AR03	2021-10-08	Passed	Passed
E-UTRA, eFDD 26 QPSK, mid channel, 10 MHz, 50, conducted	S01_AR03	2021-10-08	Passed	Passed
E-UTRA, eFDD 26 QPSK, mid channel, 3 MHz, 15, conducted	S01_AR03	2021-10-08	Passed	Passed
E-UTRA, eFDD 26 QPSK, mid channel, 5 MHz, 25, conducted	S01_AR03	2021-10-08	Passed	Passed
E-UTRA, eFDD 5 16QAM, high channel, 1.4 MHz, 6, conducted	S01_AS04	2021-08-26	Passed	Passed
E-UTRA, eFDD 5 16QAM, high channel, 3 MHz, 15, conducted	S01_AS04	2021-08-26	Passed	Passed
E-UTRA, eFDD 5 16QAM, high channel, 5 MHz, 25, conducted	S01_AS04	2021-08-26	Passed	Passed
E-UTRA, eFDD 5 16QAM, low channel, 1.4 MHz, 6, conducted	S01_AS04	2021-08-26	Passed	Passed
E-UTRA, eFDD 5 16QAM, low channel, 3 MHz, 15, conducted	S01_AS04	2021-08-26	Passed	Passed

47 CFR CHAPTER I FCC PART 22 § 2.1049
Subpart H

Emission and occupied bandwidth

The measurement was performed according to ANSI C63.26: 2015

Final Result

OP-Mode	Setup	Date	FCC	IC
Technology, Radio Technology, Operating Frequency, ChBW, Measurement method				
E-UTRA, eFDD 5 16QAM, low channel, 5 MHz, 25, conducted	S01_AS04	2021-08-26	Passed	Passed
E-UTRA, eFDD 5 16QAM, mid channel, 1.4 MHz, 6, conducted	S01_AS04	2021-08-26	Passed	Passed
E-UTRA, eFDD 5 16QAM, mid channel, 3 MHz, 15, conducted	S01_AS04	2021-08-26	Passed	Passed
E-UTRA, eFDD 5 16QAM, mid channel, 5 MHz, 25, conducted	S01_AS04	2021-08-26	Passed	Passed
E-UTRA, eFDD 5 QPSK, high channel, 1.4 MHz, 6, conducted	S01_AR03	2021-10-08	Passed	Passed
E-UTRA, eFDD 5 QPSK, high channel, 10 MHz, 50, conducted	S01_AR03	2021-10-08	Passed	Passed
E-UTRA, eFDD 5 QPSK, high channel, 3 MHz, 15, conducted	S01_AR03	2021-10-08	Passed	Passed
E-UTRA, eFDD 5 QPSK, high channel, 5 MHz, 25, conducted	S01_AR03	2021-10-08	Passed	Passed
E-UTRA, eFDD 5 QPSK, low channel, 1.4 MHz, 6, conducted	S01_AR03	2021-10-08	Passed	Passed
E-UTRA, eFDD 5 QPSK, low channel, 10 MHz, 50, conducted	S01_AR03	2021-10-08	Passed	Passed
E-UTRA, eFDD 5 QPSK, low channel, 3 MHz, 15, conducted	S01_AR03	2021-10-08	Passed	Passed
E-UTRA, eFDD 5 QPSK, low channel, 5 MHz, 25, conducted	S01_AR03	2021-10-08	Passed	Passed
E-UTRA, eFDD 5 QPSK, mid channel, 1.4 MHz, 6, conducted	S01_AR03	2021-10-08	Passed	Passed
E-UTRA, eFDD 5 QPSK, mid channel, 10 MHz, 50, conducted	S01_AR03	2021-10-08	Passed	Passed
E-UTRA, eFDD 5 QPSK, mid channel, 3 MHz, 15, conducted	S01_AR03	2021-10-08	Passed	Passed
E-UTRA, eFDD 5 QPSK, mid channel, 5 MHz, 25, conducted	S01_AR03	2021-10-08	Passed	Passed

47 CFR CHAPTER I FCC PART 22 § 2.1051 § 22.917
Subpart H

Band edge compliance

The measurement was performed according to ANSI C63.26: 2015

Final Result

OP-Mode	Setup	Date	FCC	IC
Technology, Radio Technology, Operating Frequency, ChBW, Measurement method				
GSM, GSM 850 EDGE, high channel, 0.2 MHz, conducted	S01_AB01	2021-07-15	Passed	Passed
GSM, GSM 850 EDGE, low channel, 0.2 MHz, conducted	S01_AB01	2021-07-15	Passed	Passed
GSM, GSM 850, high channel, 0.2 MHz, conducted	S01_AB01	2021-07-15	Passed	Passed
GSM, GSM 850, low channel, 0.2 MHz, conducted	S01_AB01	2021-07-15	Passed	Passed
UTRA, FDD V HSDPA, Subtest 1, high channel, 5 MHz, cond.	S01_AS04	2021-08-26	Passed	Passed
UTRA, FDD V HSDPA, Subtest 1, low channel, 5 MHz, cond.	S01_AS04	2021-08-26	Passed	Passed
UTRA, FDD V HSUPA, Subtest 1, high channel, 5 MHz, cond.	S01_AS04	2021-09-23	Passed	Passed
UTRA, FDD V HSUPA, Subtest 1, low channel, 5 MHz, conducted	S01_AS04	2021-09-23	Passed	Passed
UTRA, FDD V HSUPA, Subtest 5, high channel, 5 MHz, cond.	S01_AS04	2021-09-15	Passed	Passed
UTRA, FDD V HSUPA, Subtest 5, low channel, 5 MHz, conducted	S01_AS04	2021-09-15	Passed	Passed
UTRA, FDD V, none, high channel, 5 MHz, conducted	S01_AS04	2021-09-23	Passed	Passed
UTRA, FDD V, none, low channel, 5 MHz, conducted	S01_AS04	2021-09-23	Passed	Passed
E-UTRA, eFDD 26 16QAM, high channel, 1.4 MHz, 6, conducted	S01_AS04	2021-09-20	Passed	Passed
E-UTRA, eFDD 26 16QAM, high channel, 3 MHz, 15, conducted	S01_AS04	2021-09-20	Passed	Passed
E-UTRA, eFDD 26 16QAM, high channel, 5 MHz, 25, conducted	S01_AS04	2021-09-20	Passed	Passed
E-UTRA, eFDD 26 16QAM, low channel, 1.4 MHz, 6, conducted	S01_AS04	2021-09-20	Passed	Passed
E-UTRA, eFDD 26 16QAM, low channel, 3 MHz, 15, conducted	S01_AS04	2021-09-20	Passed	Passed
E-UTRA, eFDD 26 16QAM, low channel, 5 MHz, 25, conducted	S01_AS04	2021-09-20	Passed	Passed
E-UTRA, eFDD 26 QPSK, high channel, 1.4 MHz, 6, conducted	S01_AS04	2021-09-20	Passed	Passed
E-UTRA, eFDD 26 QPSK, high channel, 10 MHz, 50, conducted	S01_AS04	2021-09-20	Passed	Passed

47 CFR CHAPTER I FCC PART 22

§ 2.1051 § 22.917

Subpart H

Band edge compliance

The measurement was performed according to ANSI C63.26: 2015

Final Result

OP-Mode	Setup	Date	FCC	IC
Technology, Radio Technology, Operating Frequency, ChBW, Measurement method				
E-UTRA, eFDD 26 QPSK, high channel, 3 MHz, 15, conducted	S01_AS04	2021-09-20	Passed	Passed
E-UTRA, eFDD 26 QPSK, high channel, 5 MHz, 25, conducted	S01_AS04	2021-09-20	Passed	Passed
E-UTRA, eFDD 26 QPSK, low channel, 1.4 MHz, 6, conducted	S01_AS04	2021-09-20	Passed	Passed
E-UTRA, eFDD 26 QPSK, low channel, 10 MHz, 50, conducted	S01_AS04	2021-09-20	Passed	Passed
E-UTRA, eFDD 26 QPSK, low channel, 3 MHz, 15, conducted	S01_AS04	2021-09-20	Passed	Passed
E-UTRA, eFDD 26 QPSK, low channel, 5 MHz, 25, conducted	S01_AS04	2021-09-20	Passed	Passed
E-UTRA, eFDD 5 16QAM, high channel, 1.4 MHz, 6, conducted	S01_AS04	2021-08-26	Passed	Passed
E-UTRA, eFDD 5 16QAM, high channel, 3 MHz, 15, conducted	S01_AS04	2021-08-26	Passed	Passed
E-UTRA, eFDD 5 16QAM, high channel, 5 MHz, 25, conducted	S01_AS04	2021-08-26	Passed	Passed
E-UTRA, eFDD 5 16QAM, low channel, 1.4 MHz, 6, conducted	S01_AS04	2021-08-26	Passed	Passed
E-UTRA, eFDD 5 16QAM, low channel, 3 MHz, 15, conducted	S01_AS04	2021-08-26	Passed	Passed
E-UTRA, eFDD 5 16QAM, low channel, 5 MHz, 25, conducted	S01_AS04	2021-08-26	Passed	Passed
E-UTRA, eFDD 5 QPSK, high channel, 1.4 MHz, 6, conducted	S01_AS03	2021-08-11	Passed	Passed
E-UTRA, eFDD 5 QPSK, high channel, 10 MHz, 50, conducted	S01_AS04	2021-09-20	Passed	Passed
E-UTRA, eFDD 5 QPSK, high channel, 3 MHz, 15, conducted	S01_AS03	2021-08-11	Passed	Passed
E-UTRA, eFDD 5 QPSK, high channel, 5 MHz, 25, conducted	S01_AS03	2021-08-11	Passed	Passed
E-UTRA, eFDD 5 QPSK, low channel, 1.4 MHz, 6, conducted	S01_AS03	2021-08-11	Passed	Passed
E-UTRA, eFDD 5 QPSK, low channel, 10 MHz, 50, conducted	S01_AS03	2021-08-11	Passed	Passed
E-UTRA, eFDD 5 QPSK, low channel, 3 MHz, 15, conducted	S01_AS04	2021-09-20	Passed	Passed
E-UTRA, eFDD 5 QPSK, low channel, 5 MHz, 25, conducted	S01_AS03	2021-08-11	Passed	Passed

47 CFR CHAPTER I FCC PART 22

-

Subpart H

Peak-average-ratio

The measurement was performed according to ANSI C63.26: 2015

Final Result

OP-Mode	Setup	Date	FCC	IC
Technology, Radio Technology, Operating Frequency, ChBW, Measurement method				
GSM, GSM 850 EDGE, high channel, 0.2 MHz, conducted	S01_AB01	2021-07-15	Passed	Passed
GSM, GSM 850 EDGE, low channel, 0.2 MHz, conducted	S01_AB01	2021-07-15	Passed	Passed
GSM, GSM 850 EDGE, mid channel, 0.2 MHz, conducted	S01_AB01	2021-07-15	Passed	Passed
GSM, GSM 850, high channel, 0.2 MHz, conducted	S01_AB01	2021-07-15	Passed	Passed
GSM, GSM 850, low channel, 0.2 MHz, conducted	S01_AB01	2021-07-15	Passed	Passed
GSM, GSM 850, mid channel, 0.2 MHz, conducted	S01_AB01	2021-07-15	Passed	Passed
UTRA, FDD V HSDPA, Subtest 1, high channel, 5 MHz, cond.	S01_AS04	2021-08-26	Passed	Passed
UTRA, FDD V HSDPA, Subtest 1, low channel, 5 MHz, cond.	S01_AS04	2021-08-26	Passed	Passed
UTRA, FDD V HSDPA, Subtest 1, mid channel, 5 MHz, cond.	S01_AS04	2021-08-26	Passed	Passed
UTRA, FDD V HSUPA, Subtest 1, high channel, 5 MHz, cond.	S01_AS04	2021-08-26	Passed	Passed
UTRA, FDD V HSUPA, Subtest 1, low channel, 5 MHz, conducted	S01_AS04	2021-08-26	Passed	Passed
UTRA, FDD V HSUPA, Subtest 1, mid channel, 5 MHz, cond.	S01_AS04	2021-08-26	Passed	Passed
UTRA, FDD V HSUPA, Subtest 5, high channel, 5 MHz, cond.	S01_AS04	2021-08-26	Passed	Passed
UTRA, FDD V HSUPA, Subtest 5, low channel, 5 MHz, conducted	S01_AS04	2021-08-26	Passed	Passed
UTRA, FDD V HSUPA, Subtest 5, mid channel, 5 MHz, cond.	S01_AS04	2021-08-26	Passed	Passed
UTRA, FDD V, none, high channel, 5 MHz, conducted	S01_AS04	2021-09-15	Passed	Passed

47 CFR CHAPTER I FCC PART 22 -

Subpart H

Peak-average-ratio

The measurement was performed according to ANSI C63.26: 2015

Final Result

OP-Mode	Setup	Date	FCC	IC
Technology, Radio Technology, Operating Frequency, ChBW, Measurement method				
UTRA, FDD V, none, low channel, 5 MHz, conducted	S01_AS04	2021-09-15	Passed	Passed
UTRA, FDD V, none, mid channel, 5 MHz, conducted	S01_AS04	2021-09-15	Passed	Passed
E-UTRA, eFDD 5 16QAM, high channel, 1.4 MHz, 6, conducted	S01_AS04	2021-08-26	Passed	Passed
E-UTRA, eFDD 5 16QAM, low channel, 1.4 MHz, 6, conducted	S01_AS04	2021-08-26	Passed	Passed
E-UTRA, eFDD 5 16QAM, mid channel, 1.4 MHz, 6, conducted	S01_AS04	2021-08-26	Passed	Passed
E-UTRA, eFDD 5 QPSK, high channel, 1.4 MHz, 6, conducted	S01_AS04	2021-08-26	Passed	Passed
E-UTRA, eFDD 5 QPSK, low channel, 1.4 MHz, 6, conducted	S01_AS04	2021-08-26	Passed	Passed
E-UTRA, eFDD 5 QPSK, mid channel, 1.4 MHz, 6, conducted	S01_AS04	2021-08-26	Passed	Passed

47 CFR CHAPTER I FCC PART 24

§ 2.1046 § 24.232

Subpart E

RF Output power

The measurement was performed according to ANSI C63.26: 2015

Final Result

OP-Mode	Setup	Date	FCC	IC
Technology, Radio Technology, Operating Frequency, ChBW, Ressource Blocks, Measurement method				
GSM, GSM 1900 EDGE, high channel, 0.2 MHz, conducted	S01_AB01	2021-07-15	Passed	Passed
GSM, GSM 1900 EDGE, low channel, 0.2 MHz, conducted	S01_AB01	2021-07-15	Passed	Passed
GSM, GSM 1900 EDGE, mid channel, 0.2 MHz, conducted	S01_AB01	2021-07-15	Passed	Passed
GSM, GSM 1900, high channel, 0.2 MHz, conducted	S01_AB01	2021-07-05	Passed	Passed
GSM, GSM 1900, low channel, 0.2 MHz, conducted	S01_AB01	2021-07-05	Passed	Passed
GSM, GSM 1900, mid channel, 0.2 MHz, conducted	S01_AB01	2021-07-05	Passed	Passed
UTRA, FDD II HSDPA, Subtest 1, high channel, 5 MHz, cond.	S01_AY04	2021-08-28	Passed	Passed
UTRA, FDD II HSDPA, Subtest 1, low channel, 5 MHz, cond.	S01_AY04	2021-08-28	Passed	Passed
UTRA, FDD II HSDPA, Subtest 1, mid channel, 5 MHz, cond.	S01_AY04	2021-08-28	Passed	Passed
UTRA, FDD II HSDPA, Subtest 2, high channel, 5 MHz, cond.	S01_AY04	2021-08-28	Passed	Passed
UTRA, FDD II HSDPA, Subtest 2, low channel, 5 MHz, cond.	S01_AY04	2021-08-28	Passed	Passed
UTRA, FDD II HSDPA, Subtest 2, mid channel, 5 MHz, cond.	S01_AY04	2021-08-28	Passed	Passed
UTRA, FDD II HSDPA, Subtest 3, high channel, 5 MHz, cond.	S01_AY04	2021-08-28	Passed	Passed
UTRA, FDD II HSDPA, Subtest 3, low channel, 5 MHz, cond.	S01_AY04	2021-08-28	Passed	Passed
UTRA, FDD II HSDPA, Subtest 3, mid channel, 5 MHz, cond.	S01_AY04	2021-08-28	Passed	Passed
UTRA, FDD II HSDPA, Subtest 4, high channel, 5 MHz, cond.	S01_AY04	2021-08-28	Passed	Passed
UTRA, FDD II HSDPA, Subtest 4, low channel, 5 MHz, cond.	S01_AY04	2021-08-28	Passed	Passed
UTRA, FDD II HSDPA, Subtest 4, mid channel, 5 MHz, cond.	S01_AY04	2021-08-28	Passed	Passed
UTRA, FDD II HSUPA, Subtest 1, high channel, 5 MHz, cond.	S01_AS04	2021-09-15	Passed	Passed
UTRA, FDD II HSUPA, Subtest 1, low channel, 5 MHz, cond.	S01_AS04	2021-09-15	Passed	Passed
UTRA, FDD II HSUPA, Subtest 1, mid channel, 5 MHz, cond.	S01_AS04	2021-09-15	Passed	Passed
UTRA, FDD II HSUPA, Subtest 2, high channel, 5 MHz, cond.	S01_AS04	2021-09-23	Passed	Passed
UTRA, FDD II HSUPA, Subtest 2, low channel, 5 MHz, cond.	S01_AY04	2021-09-27	Passed	Passed
UTRA, FDD II HSUPA, Subtest 2, mid channel, 5 MHz, cond.	S01_AS04	2021-09-23	Passed	Passed
UTRA, FDD II HSUPA, Subtest 3, high channel, 5 MHz, cond.	S01_AS04	2021-09-23	Passed	Passed
UTRA, FDD II HSUPA, Subtest 3, low channel, 5 MHz, cond.	S01_AS04	2021-09-23	Passed	Passed
UTRA, FDD II HSUPA, Subtest 3, mid channel, 5 MHz, cond.	S01_AS04	2021-09-23	Passed	Passed
UTRA, FDD II HSUPA, Subtest 4, high channel, 5 MHz, cond.	S01_AS04	2021-09-23	Passed	Passed

47 CFR CHAPTER I FCC PART 24

§ 2.1046 § 24.232

Subpart E

RF Output power

The measurement was performed according to ANSI C63.26: 2015

Final Result

OP-Mode	Setup	Date	FCC	IC
Technology, Radio Technology, Operating Frequency, ChBW, Ressource Blocks, Measurement method				
UTRA, FDD II HSUPA, Subtest 4, low channel, 5 MHz, cond.	S01_AS04	2021-09-23	Passed	Passed
UTRA, FDD II HSUPA, Subtest 4, mid channel, 5 MHz, cond.	S01_AS04	2021-09-23	Passed	Passed
UTRA, FDD II HSUPA, Subtest 5, high channel, 5 MHz, cond.	S01_AS04	2021-09-23	Passed	Passed
UTRA, FDD II HSUPA, Subtest 5, low channel, 5 MHz, cond.	S01_AS04	2021-09-23	Passed	Passed
UTRA, FDD II HSUPA, Subtest 5, mid channel, 5 MHz, cond.	S01_AS04	2021-09-23	Passed	Passed
UTRA, FDD II, none, high channel, 5 MHz, conducted	S01_AS04	2021-09-15	Passed	Passed
UTRA, FDD II, none, low channel, 5 MHz, conducted	S01_AS04	2021-09-15	Passed	Passed
UTRA, FDD II, none, mid channel, 5 MHz, conducted	S01_AS04	2021-09-15	Passed	Passed
E-UTRA, eFDD 2 16QAM, high channel, 1.4 MHz, 1, conducted	S01_AR03	2021-10-08	Passed	Passed
E-UTRA, eFDD 2 16QAM, high channel, 1.4 MHz, 6, conducted	S01_AR03	2021-10-08	Passed	Passed
E-UTRA, eFDD 2 16QAM, high channel, 10 MHz, 1, conducted	S01_AR03	2021-10-08	Passed	Passed
E-UTRA, eFDD 2 16QAM, high channel, 15 MHz, 1, conducted	S01_AS04	2021-08-25	Passed	Passed
E-UTRA, eFDD 2 16QAM, high channel, 20 MHz, 1, conducted	S01_AS03	2021-08-12	Passed	Passed
E-UTRA, eFDD 2 16QAM, high channel, 20 MHz, 100, conducted	S01_AS04	2021-08-25	Passed	Passed
E-UTRA, eFDD 2 16QAM, high channel, 3 MHz, 1, conducted	S01_AR03	2021-10-08	Passed	Passed
E-UTRA, eFDD 2 16QAM, high channel, 3 MHz, 15, conducted	S01_AR03	2021-10-08	Passed	Passed
E-UTRA, eFDD 2 16QAM, high channel, 5 MHz, 1, conducted	S01_AR03	2021-10-08	Passed	Passed
E-UTRA, eFDD 2 16QAM, high channel, 5 MHz, 25, conducted	S01_AR03	2021-10-08	Passed	Passed
E-UTRA, eFDD 2 16QAM, low channel, 1.4 MHz, 1, conducted	S01_AR03	2021-10-08	Passed	Passed
E-UTRA, eFDD 2 16QAM, low channel, 1.4 MHz, 6, conducted	S01_AR03	2021-10-08	Passed	Passed
E-UTRA, eFDD 2 16QAM, low channel, 10 MHz, 1, conducted	S01_AR03	2021-10-08	Passed	Passed
E-UTRA, eFDD 2 16QAM, low channel, 15 MHz, 1, conducted	S01_AS03	2021-08-12	Passed	Passed
E-UTRA, eFDD 2 16QAM, low channel, 20 MHz, 1, conducted	S01_AS03	2021-08-12	Passed	Passed
E-UTRA, eFDD 2 16QAM, low channel, 20 MHz, 100, conducted	S01_AS04	2021-08-25	Passed	Passed
E-UTRA, eFDD 2 16QAM, low channel, 3 MHz, 1, conducted	S01_AR03	2021-10-08	Passed	Passed
E-UTRA, eFDD 2 16QAM, low channel, 3 MHz, 15, conducted	S01_AR03	2021-10-08	Passed	Passed
E-UTRA, eFDD 2 16QAM, low channel, 5 MHz, 1, conducted	S01_AS03	2021-08-14	Passed	Passed
E-UTRA, eFDD 2 16QAM, low channel, 5 MHz, 25, conducted	S01_AS03	2021-08-14	Passed	Passed
E-UTRA, eFDD 2 16QAM, mid channel, 1.4 MHz, 1, conducted	S01_AR03	2021-10-08	Passed	Passed
E-UTRA, eFDD 2 16QAM, mid channel, 1.4 MHz, 6, conducted	S01_AR03	2021-10-08	Passed	Passed
E-UTRA, eFDD 2 16QAM, mid channel, 10 MHz, 1, conducted	S01_AR03	2021-10-08	Passed	Passed
E-UTRA, eFDD 2 16QAM, mid channel, 15 MHz, 1, conducted	S01_AS03	2021-08-12	Passed	Passed
E-UTRA, eFDD 2 16QAM, mid channel, 20 MHz, 1, conducted	S01_AS03	2021-08-12	Passed	Passed
E-UTRA, eFDD 2 16QAM, mid channel, 20 MHz, 100, conducted	S01_AS04	2021-08-25	Passed	Passed
E-UTRA, eFDD 2 16QAM, mid channel, 3 MHz, 1, conducted	S01_AR03	2021-10-08	Passed	Passed
E-UTRA, eFDD 2 16QAM, mid channel, 3 MHz, 15, conducted	S01_AR03	2021-10-08	Passed	Passed
E-UTRA, eFDD 2 16QAM, mid channel, 5 MHz, 1, conducted	S01_AR03	2021-10-08	Passed	Passed
E-UTRA, eFDD 2 16QAM, mid channel, 5 MHz, 25, conducted	S01_AR03	2021-10-08	Passed	Passed
E-UTRA, eFDD 2 QPSK, high channel, 1.4 MHz, 1, conducted	S01_AR03	2021-10-08	Passed	Passed
E-UTRA, eFDD 2 QPSK, high channel, 1.4 MHz, 3, conducted	S01_AR03	2021-10-08	Passed	Passed
E-UTRA, eFDD 2 QPSK, high channel, 1.4 MHz, 6, conducted	S01_AR03	2021-10-08	Passed	Passed
E-UTRA, eFDD 2 QPSK, high channel, 10 MHz, 1, conducted	S01_AR03	2021-10-08	Passed	Passed
E-UTRA, eFDD 2 QPSK, high channel, 10 MHz, 50, conducted	S01_AR03	2021-10-08	Passed	Passed
E-UTRA, eFDD 2 QPSK, high channel, 15 MHz, 1, conducted	S01_AS03	2021-08-14	Passed	Passed
E-UTRA, eFDD 2 QPSK, high channel, 15 MHz, 36, conducted	S01_AS03	2021-08-14	Passed	Passed

47 CFR CHAPTER I FCC PART 24

§ 2.1046 § 24.232

Subpart E

RF Output power

The measurement was performed according to ANSI C63.26: 2015

Final Result

OP-Mode	Setup	Date	FCC	IC
Technology, Radio Technology, Operating Frequency, ChBW, Ressource Blocks, Measurement method				
E-UTRA, eFDD 2 QPSK, high channel, 15 MHz, 75, conducted	S01_AS03	2021-08-14	Passed	Passed
E-UTRA, eFDD 2 QPSK, high channel, 20 MHz, 1, conducted	S01_AS03	2021-08-14	Passed	Passed
E-UTRA, eFDD 2 QPSK, high channel, 20 MHz, 100, conducted	S01_AS03	2021-08-14	Passed	Passed
E-UTRA, eFDD 2 QPSK, high channel, 3 MHz, 1, conducted	S01_AR03	2021-10-08	Passed	Passed
E-UTRA, eFDD 2 QPSK, high channel, 3 MHz, 15, conducted	S01_AR03	2021-10-08	Passed	Passed
E-UTRA, eFDD 2 QPSK, high channel, 5 MHz, 1, conducted	S01_AR03	2021-10-08	Passed	Passed
E-UTRA, eFDD 2 QPSK, high channel, 5 MHz, 12, conducted	S01_AR03	2021-10-08	Passed	Passed
E-UTRA, eFDD 2 QPSK, high channel, 5 MHz, 25, conducted	S01_AR03	2021-10-08	Passed	Passed
E-UTRA, eFDD 2 QPSK, low channel, 1.4 MHz, 1, conducted	S01_AR03	2021-10-08	Passed	Passed
E-UTRA, eFDD 2 QPSK, low channel, 1.4 MHz, 3, conducted	S01_AR03	2021-10-08	Passed	Passed
E-UTRA, eFDD 2 QPSK, low channel, 1.4 MHz, 6, conducted	S01_AR03	2021-10-08	Passed	Passed
E-UTRA, eFDD 2 QPSK, low channel, 10 MHz, 1, conducted	S01_AR03	2021-10-08	Passed	Passed
E-UTRA, eFDD 2 QPSK, low channel, 10 MHz, 50, conducted	S01_AR03	2021-10-08	Passed	Passed
E-UTRA, eFDD 2 QPSK, low channel, 15 MHz, 1, conducted	S01_AS03	2021-08-14	Passed	Passed
E-UTRA, eFDD 2 QPSK, low channel, 15 MHz, 36, conducted	S01_AS03	2021-08-14	Passed	Passed
E-UTRA, eFDD 2 QPSK, low channel, 15 MHz, 75, conducted	S01_AS03	2021-08-14	Passed	Passed
E-UTRA, eFDD 2 QPSK, low channel, 20 MHz, 1, conducted	S01_AS03	2021-08-14	Passed	Passed
E-UTRA, eFDD 2 QPSK, low channel, 20 MHz, 100, conducted	S01_AS03	2021-08-14	Passed	Passed
E-UTRA, eFDD 2 QPSK, low channel, 3 MHz, 1, conducted	S01_AR03	2021-10-08	Passed	Passed
E-UTRA, eFDD 2 QPSK, low channel, 3 MHz, 15, conducted	S01_AR03	2021-10-08	Passed	Passed
E-UTRA, eFDD 2 QPSK, low channel, 5 MHz, 1, conducted	S01_AS03	2021-08-14	Passed	Passed
E-UTRA, eFDD 2 QPSK, low channel, 5 MHz, 12, conducted	S01_AS03	2021-08-14	Passed	Passed
E-UTRA, eFDD 2 QPSK, low channel, 5 MHz, 25, conducted	S01_AS03	2021-08-14	Passed	Passed
E-UTRA, eFDD 2 QPSK, mid channel, 1.4 MHz, 1, conducted	S01_AR03	2021-10-08	Passed	Passed
E-UTRA, eFDD 2 QPSK, mid channel, 1.4 MHz, 3, conducted	S01_AR03	2021-10-08	Passed	Passed
E-UTRA, eFDD 2 QPSK, mid channel, 1.4 MHz, 6, conducted	S01_AR03	2021-10-08	Passed	Passed
E-UTRA, eFDD 2 QPSK, mid channel, 10 MHz, 1, conducted	S01_AR03	2021-10-08	Passed	Passed
E-UTRA, eFDD 2 QPSK, mid channel, 10 MHz, 50, conducted	S01_AR03	2021-10-08	Passed	Passed
E-UTRA, eFDD 2 QPSK, mid channel, 15 MHz, 1, conducted	S01_AS03	2021-08-14	Passed	Passed
E-UTRA, eFDD 2 QPSK, mid channel, 15 MHz, 36, conducted	S01_AS03	2021-08-14	Passed	Passed
E-UTRA, eFDD 2 QPSK, mid channel, 15 MHz, 75, conducted	S01_AS03	2021-08-14	Passed	Passed
E-UTRA, eFDD 2 QPSK, mid channel, 20 MHz, 1, conducted	S01_AS03	2021-08-14	Passed	Passed
E-UTRA, eFDD 2 QPSK, mid channel, 20 MHz, 100, conducted	S01_AS03	2021-08-14	Passed	Passed
E-UTRA, eFDD 2 QPSK, mid channel, 3 MHz, 1, conducted	S01_AR03	2021-10-08	Passed	Passed
E-UTRA, eFDD 2 QPSK, mid channel, 3 MHz, 15, conducted	S01_AR03	2021-10-08	Passed	Passed
E-UTRA, eFDD 2 QPSK, mid channel, 5 MHz, 1, conducted	S01_AR03	2021-10-08	Passed	Passed
E-UTRA, eFDD 2 QPSK, mid channel, 5 MHz, 12, conducted	S01_AR03	2021-10-08	Passed	Passed
E-UTRA, eFDD 2 QPSK, mid channel, 5 MHz, 25, conducted	S01_AR03	2021-10-08	Passed	Passed

47 CFR CHAPTER I FCC PART 24

§ 2.1055 § 24.235

Subpart E

Frequency stability

The measurement was performed according to ANSI C63.26: 2015

Final Result

OP-Mode	Setup	Date	FCC	IC
Technology, Radio Technology, Operating Frequency, ChBW, Measurement method				
GSM, GSM 1900 EDGE, mid channel, 0.2 MHz, conducted	S01_AB01	2021-07-23	Passed	Passed
GSM, GSM 1900 GPRS, mid channel, 0.2 MHz, conducted	S01_AB01	2021-07-21	Passed	Passed
UTRA, FDD II HSDPA, Subtest 1, mid channel, 5 MHz, conducted	S01_AS04	2021-09-05	Passed	Passed
UTRA, FDD II HSUPA, Subtest 1, mid channel, 5 MHz, conducted	S01_AS04	2021-09-05	Passed	Passed
UTRA, FDD II, none, mid channel, 5 MHz, conducted	S01_AS04	2021-09-05	Passed	Passed
E-UTRA, eFDD 2 QPSK, mid channel, 1.4 MHz, 1, conducted	S01_AS04	2021-09-05	Passed	Passed

47 CFR CHAPTER I FCC PART 24

§ 2.1051 § 24.238

Subpart E

Spurious emissions at antenna terminal

The measurement was performed according to ANSI C63.26: 2015

Final Result

OP-Mode	Setup	Date	FCC	IC
Technology, Radio Technology, Operating Frequency, ChBW, Measurement method				
GSM, GSM 1900 EDGE, high channel, 0.2 MHz, conducted	S01_AB01	2021-07-19	Passed	Passed
GSM, GSM 1900 EDGE, low channel, 0.2 MHz, conducted	S01_AB01	2021-07-19	Passed	Passed
GSM, GSM 1900 EDGE, mid channel, 0.2 MHz, conducted	S01_AB01	2021-07-19	Passed	Passed
GSM, GSM 1900, high channel, 0.2 MHz, conducted	S01_AB01	2021-07-19	Passed	Passed
GSM, GSM 1900, low channel, 0.2 MHz, conducted	S01_AB01	2021-07-19	Passed	Passed
GSM, GSM 1900, mid channel, 0.2 MHz, conducted	S01_AB01	2021-07-19	Passed	Passed
UTRA, FDD II HSDPA, Subtest 1, high channel, 5 MHz, cond.	S01_AY04	2021-08-28	Passed	Passed
UTRA, FDD II HSDPA, Subtest 1, low channel, 5 MHz, cond.	S01_AY04	2021-08-28	Passed	Passed
UTRA, FDD II HSDPA, Subtest 1, mid channel, 5 MHz, cond.	S01_AY04	2021-08-28	Passed	Passed
UTRA, FDD II HSUPA, Subtest 1, high channel, 5 MHz, cond.	S01_AS04	2021-09-15	Passed	Passed
UTRA, FDD II HSUPA, Subtest 1, low channel, 5 MHz, cond.	S01_AS04	2021-09-15	Passed	Passed
UTRA, FDD II HSUPA, Subtest 1, mid channel, 5 MHz, cond.	S01_AS04	2021-09-15	Passed	Passed
UTRA, FDD II, none, high channel, 5 MHz, conducted	S01_AS04	2021-09-15	Passed	Passed
UTRA, FDD II, none, low channel, 5 MHz, conducted	S01_AS04	2021-09-15	Passed	Passed
UTRA, FDD II, none, mid channel, 5 MHz, conducted	S01_AS04	2021-09-15	Passed	Passed
E-UTRA, eFDD 2 QPSK, high channel, 5 MHz, 1, conducted	S01_AS04	2021-09-17	Passed	Passed
E-UTRA, eFDD 2 QPSK, low channel, 5 MHz, 1, conducted	S01_AS04	2021-09-17	Passed	Passed
E-UTRA, eFDD 2 QPSK, mid channel, 5 MHz, 1, conducted	S01_AS04	2021-09-17	Passed	Passed

47 CFR CHAPTER I FCC PART 24

§ 2.1053 § 24.236

Subpart E

Field strength of spurious radiation

The measurement was performed according to ANSI C63.26: 2015

Final Result

OP-Mode	Setup	Date	FCC	IC
Technology, Radio Technology, Operating Frequency, ChBW, Measurement method				
GSM, GSM 1900 EDGE, high channel, 0.2 MHz, radiated	S01_AB01	2021-07-25	Passed	Passed
GSM, GSM 1900 EDGE, low channel, 0.2 MHz, radiated	S01_AB01	2021-07-25	Passed	Passed
GSM, GSM 1900 EDGE, mid channel, 0.2 MHz, radiated	S01_AB01	2021-07-25	Passed	Passed

47 CFR CHAPTER I FCC PART 24
Subpart E

§ 2.1053 § 24.236

Field strength of spurious radiation

The measurement was performed according to ANSI C63.26: 2015

Final Result

OP-Mode	Setup	Date	FCC	IC
Technology, Radio Technology, Operating Frequency, ChBW, Measurement method				
GSM, GSM 1900, high channel, 0.2 MHz, radiated	S01_AB01	2021-07-25	Passed	Passed
GSM, GSM 1900, low channel, 0.2 MHz, radiated	S01_AB01	2021-07-25	Passed	Passed
GSM, GSM 1900, mid channel, 0.2 MHz, radiated	S01_AB01	2021-07-25	Passed	Passed
UTRA, FDD II HSDPA, Subtest 1, high channel, 5 MHz, radiated	S01_AS04	2021-09-24	Passed	Passed
UTRA, FDD II HSDPA, Subtest 1, low channel, 5 MHz, radiated	S01_AS04	2021-09-24	Passed	Passed
UTRA, FDD II HSDPA, Subtest 1, mid channel, 5 MHz, radiated	S01_AS04	2021-09-24	Passed	Passed
UTRA, FDD II HSUPA, Subtest 1, high channel, 5 MHz, radiated	S01_AS04	2021-09-24	Passed	Passed
UTRA, FDD II HSUPA, Subtest 1, low channel, 5 MHz, radiated	S01_AS04	2021-09-24	Passed	Passed
UTRA, FDD II HSUPA, Subtest 1, mid channel, 5 MHz, radiated	S01_AS04	2021-09-24	Passed	Passed
UTRA, FDD II, none, high channel, 5 MHz, radiated	S01_AY04	2021-08-27	Passed	Passed
UTRA, FDD II, none, low channel, 5 MHz, radiated	S01_AY04	2021-08-27	Passed	Passed
UTRA, FDD II, none, mid channel, 5 MHz, radiated	S01_AY04	2021-08-27	Passed	Passed
E-UTRA, eFDD 2 QPSK, high channel, 5 MHz, 1, radiated	S01_AR04	2021-08-22	Passed	Passed
E-UTRA, eFDD 2 QPSK, low channel, 5 MHz, 1, radiated	S01_AR04	2021-08-22	Passed	Passed
E-UTRA, eFDD 2 QPSK, mid channel, 5 MHz, 1, radiated	S01_AR04	2021-08-22	Passed	Passed

47 CFR CHAPTER I FCC PART 24
Subpart E

§ 2.1049

Emission and occupied bandwidth

The measurement was performed according to ANSI C63.26: 2015

Final Result

OP-Mode	Setup	Date	FCC	IC
Technology, Radio Technology, Operating Frequency, ChBW, Ressource Blocks, Measurement method				
GSM, GSM 1900 EDGE, high channel, 0.2 MHz, conducted	S01_AS04	2021-09-23	Passed	Passed
GSM, GSM 1900 EDGE, low channel, 0.2 MHz, conducted	S01_AS04	2021-09-23	Passed	Passed
GSM, GSM 1900 EDGE, mid channel, 0.2 MHz, conducted	S01_AS04	2021-09-23	Passed	Passed
GSM, GSM 1900, high channel, 0.2 MHz, conducted	S01_AB01	2021-07-05	Passed	Passed
GSM, GSM 1900, low channel, 0.2 MHz, conducted	S01_AB01	2021-07-05	Passed	Passed
GSM, GSM 1900, mid channel, 0.2 MHz, conducted	S01_AB01	2021-07-05	Passed	Passed
UTRA, FDD II HSDPA, Subtest 1, high channel, 5 MHz, conducted	S01_AY04	2021-08-28	Passed	Passed
UTRA, FDD II HSDPA, Subtest 1, low channel, 5 MHz, conducted	S01_AY04	2021-08-28	Passed	Passed
UTRA, FDD II HSDPA, Subtest 1, mid channel, 5 MHz, conducted	S01_AY04	2021-08-28	Passed	Passed
UTRA, FDD II HSUPA, Subtest 1, high channel, 5 MHz, conducted	S01_AY04	2021-09-27	Passed	Passed
UTRA, FDD II HSUPA, Subtest 1, low channel, 5 MHz, conducted	S01_AY04	2021-09-27	Passed	Passed
UTRA, FDD II HSUPA, Subtest 1, mid channel, 5 MHz, conducted	S01_AY04	2021-09-27	Passed	Passed
UTRA, FDD II HSUPA, Subtest 5, high channel, 5 MHz, conducted	S01_AY04	2021-09-27	Passed	Passed
UTRA, FDD II HSUPA, Subtest 5, low channel, 5 MHz, conducted	S01_AY04	2021-09-27	Passed	Passed
UTRA, FDD II HSUPA, Subtest 5, mid channel, 5 MHz, conducted	S01_AY04	2021-09-27	Passed	Passed
UTRA, FDD II, none, high channel, 5 MHz, conducted	S01_AS04	2021-09-15	Passed	Passed
UTRA, FDD II, none, low channel, 5 MHz, conducted	S01_AS04	2021-09-15	Passed	Passed
UTRA, FDD II, none, mid channel, 5 MHz, conducted	S01_AS04	2021-09-15	Passed	Passed
E-UTRA, eFDD 2 16QAM, high channel, 1.4 MHz, 6, conducted	S01_AR03	2021-10-08	Passed	Passed
E-UTRA, eFDD 2 16QAM, high channel, 3 MHz, 15, conducted	S01_AR03	2021-10-08	Passed	Passed
E-UTRA, eFDD 2 16QAM, high channel, 5 MHz, 25, conducted	S01_AR03	2021-10-08	Passed	Passed

47 CFR CHAPTER I FCC PART 24

§ 2.1049

Subpart E

Emission and occupied bandwidth

The measurement was performed according to ANSI C63.26: 2015

Final Result

OP-Mode	Setup	Date	FCC	IC
Technology, Radio Technology, Operating Frequency, ChBW, Ressource Blocks, Measurement method				
E-UTRA, eFDD 2 16QAM, low channel, 1.4 MHz, 6, conducted	S01_AR03	2021-10-08	Passed	Passed
E-UTRA, eFDD 2 16QAM, low channel, 3 MHz, 15, conducted	S01_AR03	2021-10-08	Passed	Passed
E-UTRA, eFDD 2 16QAM, low channel, 5 MHz, 25, conducted	S01_AR03	2021-10-08	Passed	Passed
E-UTRA, eFDD 2 16QAM, mid channel, 1.4 MHz, 6, conducted	S01_AR03	2021-10-08	Passed	Passed
E-UTRA, eFDD 2 16QAM, mid channel, 3 MHz, 15, conducted	S01_AR03	2021-10-08	Passed	Passed
E-UTRA, eFDD 2 16QAM, mid channel, 5 MHz, 25, conducted	S01_AR03	2021-10-08	Passed	Passed
E-UTRA, eFDD 2 QPSK, high channel, 1.4 MHz, 6, conducted	S01_AR03	2021-10-08	Passed	Passed
E-UTRA, eFDD 2 QPSK, high channel, 10 MHz, 50, conducted	S01_AR03	2021-10-08	Passed	Passed
E-UTRA, eFDD 2 QPSK, high channel, 15 MHz, 75, conducted	S01_AR03	2021-10-08	Passed	Passed
E-UTRA, eFDD 2 QPSK, high channel, 20 MHz, 100, conducted	S01_AR03	2021-10-08	Passed	Passed
E-UTRA, eFDD 2 QPSK, high channel, 3 MHz, 15, conducted	S01_AR03	2021-10-08	Passed	Passed
E-UTRA, eFDD 2 QPSK, high channel, 5 MHz, 25, conducted	S01_AR03	2021-10-08	Passed	Passed
E-UTRA, eFDD 2 QPSK, low channel, 1.4 MHz, 6, conducted	S01_AS04	2021-09-20	Passed	Passed
E-UTRA, eFDD 2 QPSK, low channel, 10 MHz, 50, conducted	S01_AR03	2021-10-08	Passed	Passed
E-UTRA, eFDD 2 QPSK, low channel, 15 MHz, 75, conducted	S01_AR03	2021-10-08	Passed	Passed
E-UTRA, eFDD 2 QPSK, low channel, 20 MHz, 100, conducted	S01_AR03	2021-10-08	Passed	Passed
E-UTRA, eFDD 2 QPSK, low channel, 3 MHz, 15, conducted	S01_AR03	2021-10-08	Passed	Passed
E-UTRA, eFDD 2 QPSK, low channel, 5 MHz, 25, conducted	S01_AR03	2021-10-08	Passed	Passed
E-UTRA, eFDD 2 QPSK, mid channel, 1.4 MHz, 6, conducted	S01_AR03	2021-10-08	Passed	Passed
E-UTRA, eFDD 2 QPSK, mid channel, 10 MHz, 50, conducted	S01_AR03	2021-10-08	Passed	Passed
E-UTRA, eFDD 2 QPSK, mid channel, 15 MHz, 75, conducted	S01_AR03	2021-10-08	Passed	Passed
E-UTRA, eFDD 2 QPSK, mid channel, 20 MHz, 100, conducted	S01_AR03	2021-10-08	Passed	Passed
E-UTRA, eFDD 2 QPSK, mid channel, 3 MHz, 15, conducted	S01_AR03	2021-10-08	Passed	Passed
E-UTRA, eFDD 2 QPSK, mid channel, 5 MHz, 25, conducted	S01_AR03	2021-10-08	Passed	Passed

47 CFR CHAPTER I FCC PART 24

§ 2.1051 § 24.238

Subpart E

Band edge compliance

The measurement was performed according to ANSI C63.26: 2015

Final Result

OP-Mode	Setup	Date	FCC	IC
Technology, Radio Technology, Operating Frequency, ChBW, Ressource Blocks, Measurement method				
GSM, GSM 1900 EDGE, high channel, 0.2 MHz, conducted	S01_AB01	2021-07-15	Passed	Passed
GSM, GSM 1900 EDGE, low channel, 0.2 MHz, conducted	S01_AB01	2021-07-15	Passed	Passed
GSM, GSM 1900, high channel, 0.2 MHz, conducted	S01_AB01	2021-07-05	Passed	Passed
GSM, GSM 1900, low channel, 0.2 MHz, conducted	S01_AB01	2021-07-05	Passed	Passed
GSM, GSM 1900 EDGE, high channel, 0.2 MHz, conducted	S01_AB01	2021-07-15	Passed	Passed
GSM, GSM 1900 EDGE, low channel, 0.2 MHz, conducted	S01_AB01	2021-07-15	Passed	Passed
GSM, GSM 1900, high channel, 0.2 MHz, conducted	S01_AB01	2021-05-07	Passed	Passed
UTRA, FDD II, none, high channel, 5 MHz, conducted	S01_AS04	2021-09-15	Passed	Passed
UTRA, FDD II, none, low channel, 5 MHz, conducted	S01_AS04	2021-09-15	Passed	Passed
UTRA, FDD II HSDPA, Subtest 1, high channel, 5 MHz, conducted	S01_AY04	2021-08-28	Passed	Passed
UTRA, FDD II HSDPA, Subtest 1, low channel, 5 MHz, conducted	S01_AY04	2021-08-28	Passed	Passed
UTRA, FDD II HSUPA, Subtest 1, low channel, 5 MHz, conducted	S01_AS04	2021-09-15	Passed	Passed

47 CFR CHAPTER I FCC PART 24

§ 2.1051 § 24.238

Subpart E

Band edge compliance

The measurement was performed according to ANSI C63.26: 2015

Final Result

OP-Mode	Setup	Date	FCC	IC
Technology, Radio Technology, Operating Frequency, ChBW, Ressource Blocks, Measurement method				
UTRA, FDD II HSUPA, Subtest 1, mid channel, 5 MHz, conducted	S01_AS04	2021-09-15	Passed	Passed
UTRA, FDD II HSUPA, Subtest 5, high channel, 5 MHz, conducted	S01_AS04	2021-09-15	Passed	Passed
UTRA, FDD II HSUPA, Subtest 5, low channel, 5 MHz, conducted	S01_AS04	2021-09-15	Passed	Passed
E-UTRA, eFDD 2 16QAM, high channel, 3 MHz, 15, conducted	S01_AS04	2021-08-26	Passed	Passed
E-UTRA, eFDD 2 16QAM, high channel, 5 MHz, 25, conducted	S01_AS04	2021-08-26	Passed	Passed
E-UTRA, eFDD 2 16QAM, low channel, 1.4 MHz, 6, conducted	S01_AS04	2021-08-26	Passed	Passed
E-UTRA, eFDD 2 16QAM, low channel, 3 MHz, 15, conducted	S01_AS04	2021-08-26	Passed	Passed
E-UTRA, eFDD 2 16QAM, low channel, 5 MHz, 25, conducted	S01_AS04	2021-08-26	Passed	Passed
E-UTRA, eFDD 2 QPSK, high channel, 1.4 MHz, 6, conducted	S01_AS03	2021-11-08	Passed	Passed
E-UTRA, eFDD 2 QPSK, high channel, 10 MHz, 50, conducted	S01_AR03	2021-10-08	Passed	Passed
E-UTRA, eFDD 2 QPSK, high channel, 15 MHz, 75, conducted	S01_AR03	2021-10-08	Passed	Passed
E-UTRA, eFDD 2 QPSK, high channel, 20 MHz, 100, conducted	S01_AR03	2021-10-08	Passed	Passed
E-UTRA, eFDD 2 QPSK, high channel, 3 MHz, 15, conducted	S01_AR03	2021-10-08	Passed	Passed
E-UTRA, eFDD 2 QPSK, high channel, 5 MHz, 25, conducted	S01_AR03	2021-10-08	Passed	Passed
E-UTRA, eFDD 2 QPSK, low channel, 1.4 MHz, 6, conducted	S01_AR03	2021-11-08	Passed	Passed
E-UTRA, eFDD 2 QPSK, low channel, 10 MHz, 50, conducted	S01_AR03	2021-10-08	Passed	Passed
E-UTRA, eFDD 2 QPSK, low channel, 15 MHz, 75, conducted	S01_AR03	2021-10-08	Passed	Passed
E-UTRA, eFDD 2 QPSK, low channel, 20 MHz, 100, conducted	S01_AR03	2021-10-08	Passed	Passed
E-UTRA, eFDD 2 QPSK, low channel, 3 MHz, 15, conducted	S01_AR03	2021-10-08	Passed	Passed
E-UTRA, eFDD 2 QPSK, low channel, 5 MHz, 25, conducted	S01_AR03	2021-10-08	Passed	Passed

47 CFR CHAPTER I FCC PART 24

§ 24.232

Subpart E

Peak to Average Ratio

The measurement was performed according to ANSI C63.26: 2015

Final Result

OP-Mode	Setup	Date	FCC	IC
Technology, Radio Technology, Operating Frequency, ChBW, Measurement method				
GSM, GSM 1900 EDGE, high channel, 0.2 MHz, conducted	S01_AB01	2021-07-15	Passed	Passed
GSM, GSM 1900 EDGE, low channel, 0.2 MHz, conducted	S01_AB01	2021-07-15	Passed	Passed
GSM, GSM 1900 EDGE, mid channel, 0.2 MHz, conducted	S01_AB01	2021-07-15	Passed	Passed
GSM, GSM 1900, high channel, 0.2 MHz, conducted	S01_AB01	2021-07-05	Passed	Passed
GSM, GSM 1900, low channel, 0.2 MHz, conducted	S01_AB01	2021-07-05	Passed	Passed
GSM, GSM 1900, mid channel, 0.2 MHz, conducted	S01_AB01	2021-07-05	Passed	Passed
UTRA, FDD II HSDPA, Subtest 1, high channel, 5 MHz, conducted	S01_AY04	2021-08-28	Passed	Passed
UTRA, FDD II HSDPA, Subtest 1, low channel, 5 MHz, conducted	S01_AY04	2021-08-28	Passed	Passed
UTRA, FDD II HSDPA, Subtest 1, mid channel, 5 MHz, conducted	S01_AY04	2021-08-28	Passed	Passed
UTRA, FDD II HSUPA, Subtest 1, high channel, 5 MHz, conducted	S01_AY04	2021-08-28	Passed	Passed
UTRA, FDD II HSUPA, Subtest 1, low channel, 5 MHz, conducted	S01_AY04	2021-08-28	Passed	Passed
UTRA, FDD II HSUPA, Subtest 1, mid channel, 5 MHz, conducted	S01_AY04	2021-08-28	Passed	Passed
UTRA, FDD II HSUPA, Subtest 5, high channel, 5 MHz, conducted	S01_AY04	2021-08-28	Passed	Passed
UTRA, FDD II HSUPA, Subtest 5, low channel, 5 MHz, conducted	S01_AY04	2021-08-28	Passed	Passed
UTRA, FDD II HSUPA, Subtest 5, mid channel, 5 MHz, conducted	S01_AY04	2021-08-28	Passed	Passed

47 CFR CHAPTER I FCC PART 24

§ 24.232

Subpart E

Peak to Average Ratio

The measurement was performed according to ANSI C63.26: 2015

Final Result

OP-Mode Technology, Radio Technology, Operating Frequency, ChBW, Measurement method	Setup	Date	FCC	IC
UTRA, FDD II, none, high channel, 5 MHz, conducted	S01_AS04	2021-09-15	Passed	Passed
UTRA, FDD II, none, low channel, 5 MHz, conducted	S01_AS04	2021-09-15	Passed	Passed
UTRA, FDD II, none, mid channel, 5 MHz, conducted	S01_AS04	2021-09-15	Passed	Passed
E-UTRA, eFDD 2 16QAM, high channel, 1.4 MHz, 6, conducted	S01_AS04	2021-08-26	Passed	Passed
E-UTRA, eFDD 2 16QAM, low channel, 1.4 MHz, 6, conducted	S01_AS04	2021-08-26	Passed	Passed
E-UTRA, eFDD 2 16QAM, mid channel, 1.4 MHz, 6, conducted	S01_AS04	2021-08-26	Passed	Passed
E-UTRA, eFDD 2 QPSK, high channel, 1.4 MHz, 6, conducted	S01_AS04	2021-08-26	Passed	Passed
E-UTRA, eFDD 2 QPSK, low channel, 1.4 MHz, 6, conducted	S01_AS04	2021-08-26	Passed	Passed
E-UTRA, eFDD 2 QPSK, mid channel, 1.4 MHz, 6, conducted	S01_AS04	2021-08-26	Passed	Passed

47 CFR CHAPTER I FCC PART 27

§ 2.1046 § 27.50

Subpart C

RF Output Power

The measurement was performed according to ANSI C63.26: 2015

Final Result

OP-Mode Technology, Radio Technology, Operating Frequency, ChBW, Ressource Blocks, Measurement method	Setup	Date	FCC	IC
E-UTRA, eFDD 12 16QAM, high channel, 1.4 MHz, 1, conducted	S01_AS03	2021-08-14	Passed	Passed
E-UTRA, eFDD 12 16QAM, high channel, 1.4 MHz, 6, conducted	S01_AS03	2021-08-14	Passed	Passed
E-UTRA, eFDD 12 16QAM, high channel, 10 MHz, 1, conducted	S01_AS03	2021-08-14	Passed	Passed
E-UTRA, eFDD 12 16QAM, high channel, 3 MHz, 1, conducted	S01_AS03	2021-08-14	Passed	Passed
E-UTRA, eFDD 12 16QAM, high channel, 3 MHz, 15, conducted	S01_AS03	2021-08-14	Passed	Passed
E-UTRA, eFDD 12 16QAM, high channel, 5 MHz, 1, conducted	S01_AS03	2021-08-14	Passed	Passed
E-UTRA, eFDD 12 16QAM, high channel, 5 MHz, 25, conducted	S01_AS03	2021-08-14	Passed	Passed
E-UTRA, eFDD 12 16QAM, low channel, 1.4 MHz, 1, conducted	S01_AS03	2021-08-14	Passed	Passed
E-UTRA, eFDD 12 16QAM, low channel, 1.4 MHz, 6, conducted	S01_AS03	2021-08-14	Passed	Passed
E-UTRA, eFDD 12 16QAM, low channel, 10 MHz, 1, conducted	S01_AS03	2021-08-14	Passed	Passed
E-UTRA, eFDD 12 16QAM, low channel, 3 MHz, 1, conducted	S01_AS03	2021-08-14	Passed	Passed
E-UTRA, eFDD 12 16QAM, low channel, 3 MHz, 15, conducted	S01_AS03	2021-08-14	Passed	Passed
E-UTRA, eFDD 12 16QAM, low channel, 5 MHz, 1, conducted	S01_AS03	2021-08-14	Passed	Passed
E-UTRA, eFDD 12 16QAM, low channel, 5 MHz, 25, conducted	S01_AS03	2021-08-14	Passed	Passed
E-UTRA, eFDD 12 16QAM, mid channel, 1.4 MHz, 1, conducted	S01_AS03	2021-08-14	Passed	Passed
E-UTRA, eFDD 12 16QAM, mid channel, 1.4 MHz, 6, conducted	S01_AS03	2021-08-14	Passed	Passed
E-UTRA, eFDD 12 16QAM, mid channel, 10 MHz, 1, conducted	S01_AS03	2021-08-14	Passed	Passed
E-UTRA, eFDD 12 16QAM, mid channel, 3 MHz, 1, conducted	S01_AS03	2021-08-14	Passed	Passed
E-UTRA, eFDD 12 16QAM, mid channel, 3 MHz, 15, conducted	S01_AS03	2021-08-14	Passed	Passed
E-UTRA, eFDD 12 16QAM, mid channel, 5 MHz, 1, conducted	S01_AS03	2021-08-14	Passed	Passed
E-UTRA, eFDD 12 16QAM, mid channel, 5 MHz, 25, conducted	S01_AS03	2021-08-14	Passed	Passed
E-UTRA, eFDD 12 QPSK, high channel, 1.4 MHz, 1, conducted	S01_AR03	2021-10-08	Passed	Passed
E-UTRA, eFDD 12 QPSK, high channel, 1.4 MHz, 3, conducted	S01_AR03	2021-10-08	Passed	Passed
E-UTRA, eFDD 12 QPSK, high channel, 1.4 MHz, 6, conducted	S01_AR03	2021-10-08	Passed	Passed
E-UTRA, eFDD 12 QPSK, high channel, 10 MHz, 1, conducted	S01_AR03	2021-10-08	Passed	Passed
E-UTRA, eFDD 12 QPSK, high channel, 10 MHz, 50, conducted	S01_AR03	2021-10-08	Passed	Passed
E-UTRA, eFDD 12 QPSK, high channel, 3 MHz, 1, conducted	S01_AR03	2021-10-08	Passed	Passed

47 CFR CHAPTER I FCC PART 27

§ 2.1046 § 27.50

Subpart C

RF Output Power

The measurement was performed according to ANSI C63.26: 2015

Final Result

OP-Mode	Setup	Date	FCC	IC
Technology, Radio Technology, Operating Frequency, ChBW, Ressource Blocks, Measurement method				
E-UTRA, eFDD 12 QPSK, high channel, 3 MHz, 15, conducted	S01_AR03	2021-10-08	Passed	Passed
E-UTRA, eFDD 12 QPSK, high channel, 5 MHz, 1, conducted	S01_AR03	2021-10-08	Passed	Passed
E-UTRA, eFDD 12 QPSK, high channel, 5 MHz, 12, conducted	S01_AR03	2021-10-08	Passed	Passed
E-UTRA, eFDD 12 QPSK, high channel, 5 MHz, 25, conducted	S01_AR03	2021-10-08	Passed	Passed
E-UTRA, eFDD 12 QPSK, low channel, 1.4 MHz, 1, conducted	S01_AR03	2021-10-08	Passed	Passed
E-UTRA, eFDD 12 QPSK, low channel, 1.4 MHz, 3, conducted	S01_AR03	2021-10-08	Passed	Passed
E-UTRA, eFDD 12 QPSK, low channel, 1.4 MHz, 6, conducted	S01_AR03	2021-10-08	Passed	Passed
E-UTRA, eFDD 12 QPSK, low channel, 10 MHz, 1, conducted	S01_AR03	2021-10-08	Passed	Passed
E-UTRA, eFDD 12 QPSK, low channel, 10 MHz, 50, conducted	S01_AR03	2021-10-08	Passed	Passed
E-UTRA, eFDD 12 QPSK, low channel, 3 MHz, 1, conducted	S01_AS03	2021-08-14	Passed	Passed
E-UTRA, eFDD 12 QPSK, low channel, 3 MHz, 15, conducted	S01_AS03	2021-08-14	Passed	Passed
E-UTRA, eFDD 12 QPSK, low channel, 5 MHz, 1, conducted	S01_AR03	2021-10-08	Passed	Passed
E-UTRA, eFDD 12 QPSK, low channel, 5 MHz, 12, conducted	S01_AR03	2021-10-08	Passed	Passed
E-UTRA, eFDD 12 QPSK, low channel, 5 MHz, 25, conducted	S01_AR03	2021-10-08	Passed	Passed
E-UTRA, eFDD 12 QPSK, mid channel, 1.4 MHz, 1, conducted	S01_AR03	2021-10-08	Passed	Passed
E-UTRA, eFDD 12 QPSK, mid channel, 1.4 MHz, 3, conducted	S01_AR03	2021-10-08	Passed	Passed
E-UTRA, eFDD 12 QPSK, mid channel, 1.4 MHz, 6, conducted	S01_AR03	2021-10-08	Passed	Passed
E-UTRA, eFDD 12 QPSK, mid channel, 10 MHz, 1, conducted	S01_AR03	2021-10-08	Passed	Passed
E-UTRA, eFDD 12 QPSK, mid channel, 10 MHz, 50, conducted	S01_AR03	2021-10-08	Passed	Passed
E-UTRA, eFDD 12 QPSK, mid channel, 3 MHz, 1, conducted	S01_AR03	2021-10-08	Passed	Passed
E-UTRA, eFDD 12 QPSK, mid channel, 3 MHz, 15, conducted	S01_AR03	2021-10-08	Passed	Passed
E-UTRA, eFDD 12 QPSK, mid channel, 5 MHz, 1, conducted	S01_AR03	2021-10-08	Passed	Passed
E-UTRA, eFDD 12 QPSK, mid channel, 5 MHz, 12, conducted	S01_AR03	2021-10-08	Passed	Passed
E-UTRA, eFDD 12 QPSK, mid channel, 5 MHz, 25, conducted	S01_AR03	2021-10-08	Passed	Passed
E-UTRA, eFDD 13 16QAM, high channel, 5 MHz, 1, conducted	S01_AS03	2021-08-14	Passed	Passed
E-UTRA, eFDD 13 16QAM, high channel, 5 MHz, 25, conducted	S01_AS03	2021-08-14	Passed	Passed
E-UTRA, eFDD 13 16QAM, low channel, 5 MHz, 1, conducted	S01_AS03	2021-08-14	Passed	Passed
E-UTRA, eFDD 13 16QAM, low channel, 5 MHz, 25, conducted	S01_AS03	2021-08-14	Passed	Passed
E-UTRA, eFDD 13 16QAM, mid channel, 10 MHz, 1, conducted	S01_AS04	2021-08-26	Passed	Passed
E-UTRA, eFDD 13 16QAM, mid channel, 10 MHz, 50, conducted	S01_AS04	2021-08-26	Passed	Passed
E-UTRA, eFDD 13 16QAM, mid channel, 5 MHz, 1, conducted	S01_AS03	2021-08-14	Passed	Passed
E-UTRA, eFDD 13 16QAM, mid channel, 5 MHz, 25, conducted	S01_AS03	2021-08-14	Passed	Passed
E-UTRA, eFDD 13 QPSK, high channel, 5 MHz, 1, conducted	S01_AS04	2021-09-23	Passed	Passed
E-UTRA, eFDD 13 QPSK, high channel, 5 MHz, 12, conducted	S01_AS03	2021-08-14	Passed	Passed
E-UTRA, eFDD 13 QPSK, high channel, 5 MHz, 25, conducted	S01_AS03	2021-08-14	Passed	Passed
E-UTRA, eFDD 13 QPSK, low channel, 5 MHz, 1, conducted	S01_AR03	2021-10-08	Passed	Passed
E-UTRA, eFDD 13 QPSK, low channel, 5 MHz, 12, conducted	S01_AR03	2021-10-08	Passed	Passed
E-UTRA, eFDD 13 QPSK, low channel, 5 MHz, 25, conducted	S01_AR03	2021-10-08	Passed	Passed
E-UTRA, eFDD 13 QPSK, mid channel, 10 MHz, 1, conducted	S01_AR03	2021-10-08	Passed	Passed
E-UTRA, eFDD 13 QPSK, mid channel, 10 MHz, 50, conducted	S01_AR03	2021-10-08	Passed	Passed
E-UTRA, eFDD 13 QPSK, mid channel, 5 MHz, 1, conducted	S01_AR03	2021-10-08	Passed	Passed
E-UTRA, eFDD 13 QPSK, mid channel, 5 MHz, 12, conducted	S01_AR03	2021-10-08	Passed	Passed
E-UTRA, eFDD 13 QPSK, mid channel, 5 MHz, 25, conducted	S01_AR03	2021-10-08	Passed	Passed
E-UTRA, eFDD 4 16QAM, high channel, 1.4 MHz, 1, conducted	S01_AS03	2021-08-12	Passed	Passed
E-UTRA, eFDD 4 16QAM, high channel, 1.4 MHz, 6, conducted	S01_AS03	2021-08-12	Passed	Passed

47 CFR CHAPTER I FCC PART 27

§ 2.1046 § 27.50

Subpart C

RF Output Power

The measurement was performed according to ANSI C63.26: 2015

Final Result

OP-Mode	Setup	Date	FCC	IC
Technology, Radio Technology, Operating Frequency, ChBW, Ressource Blocks, Measurement method				
E-UTRA, eFDD 4 16QAM, high channel, 10 MHz, 1, conducted	S01_AS03	2021-08-12	Passed	Passed
E-UTRA, eFDD 4 16QAM, high channel, 15 MHz, 1, conducted	S01_AS04	2021-08-26	Passed	Passed
E-UTRA, eFDD 4 16QAM, high channel, 20 MHz, 1, conducted	S01_AS04	2021-09-24	Passed	Passed
E-UTRA, eFDD 4 16QAM, high channel, 3 MHz, 1, conducted	S01_AS03	2021-08-12	Passed	Passed
E-UTRA, eFDD 4 16QAM, high channel, 3 MHz, 15, conducted	S01_AS03	2021-08-12	Passed	Passed
E-UTRA, eFDD 4 16QAM, high channel, 5 MHz, 1, conducted	S01_AS03	2021-08-12	Passed	Passed
E-UTRA, eFDD 4 16QAM, high channel, 5 MHz, 25, conducted	S01_AS03	2021-08-12	Passed	Passed
E-UTRA, eFDD 4 16QAM, low channel, 1.4 MHz, 1, conducted	S01_AS03	2021-08-12	Passed	Passed
E-UTRA, eFDD 4 16QAM, low channel, 1.4 MHz, 6, conducted	S01_AS03	2021-08-12	Passed	Passed
E-UTRA, eFDD 4 16QAM, low channel, 10 MHz, 1, conducted	S01_AS03	2021-08-14	Passed	Passed
E-UTRA, eFDD 4 16QAM, low channel, 15 MHz, 1, conducted	S01_AS03	2021-08-14	Passed	Passed
E-UTRA, eFDD 4 16QAM, low channel, 20 MHz, 1, conducted	S01_AS03	2021-08-12	Passed	Passed
E-UTRA, eFDD 4 16QAM, low channel, 3 MHz, 1, conducted	S01_AS03	2021-08-12	Passed	Passed
E-UTRA, eFDD 4 16QAM, low channel, 3 MHz, 15, conducted	S01_AS03	2021-08-12	Passed	Passed
E-UTRA, eFDD 4 16QAM, low channel, 5 MHz, 1, conducted	S01_AS03	2021-08-12	Passed	Passed
E-UTRA, eFDD 4 16QAM, low channel, 5 MHz, 25, conducted	S01_AS03	2021-08-12	Passed	Passed
E-UTRA, eFDD 4 16QAM, mid channel, 1.4 MHz, 1, conducted	S01_AS03	2021-08-12	Passed	Passed
E-UTRA, eFDD 4 16QAM, mid channel, 1.4 MHz, 6, conducted	S01_AS03	2021-08-12	Passed	Passed
E-UTRA, eFDD 4 16QAM, mid channel, 10 MHz, 1, conducted	S01_AS03	2021-08-12	Passed	Passed
E-UTRA, eFDD 4 16QAM, mid channel, 15 MHz, 1, conducted	S01_AS03	2021-08-12	Passed	Passed
E-UTRA, eFDD 4 16QAM, mid channel, 20 MHz, 1, conducted	S01_AS03	2021-08-12	Passed	Passed
E-UTRA, eFDD 4 16QAM, mid channel, 3 MHz, 1, conducted	S01_AS03	2021-08-12	Passed	Passed
E-UTRA, eFDD 4 16QAM, mid channel, 3 MHz, 15, conducted	S01_AS03	2021-08-12	Passed	Passed
E-UTRA, eFDD 4 16QAM, mid channel, 5 MHz, 1, conducted	S01_AS03	2021-08-12	Passed	Passed
E-UTRA, eFDD 4 16QAM, mid channel, 5 MHz, 25, conducted	S01_AS03	2021-08-12	Passed	Passed
E-UTRA, eFDD 4 QPSK, high channel, 1.4 MHz, 1, conducted	S01_AR03	2021-10-08	Passed	Passed
E-UTRA, eFDD 4 QPSK, high channel, 1.4 MHz, 3, conducted	S01_AR03	2021-10-08	Passed	Passed
E-UTRA, eFDD 4 QPSK, high channel, 1.4 MHz, 6, conducted	S01_AR03	2021-10-08	Passed	Passed
E-UTRA, eFDD 4 QPSK, high channel, 10 MHz, 1, conducted	S01_AR03	2021-10-08	Passed	Passed
E-UTRA, eFDD 4 QPSK, high channel, 10 MHz, 50, conducted	S01_AR03	2021-10-08	Passed	Passed
E-UTRA, eFDD 4 QPSK, high channel, 15 MHz, 1, conducted	S01_AS04	2021-09-24	Passed	Passed
E-UTRA, eFDD 4 QPSK, high channel, 15 MHz, 36, conducted	S01_AS04	2021-09-24	Passed	Passed
E-UTRA, eFDD 4 QPSK, high channel, 15 MHz, 75, conducted	S01_AS03	2021-08-14	Passed	Passed
E-UTRA, eFDD 4 QPSK, high channel, 20 MHz, 1, conducted	S01_AS04	2021-09-24	Passed	Passed
E-UTRA, eFDD 4 QPSK, high channel, 20 MHz, 100, conducted	S01_AS04	2021-09-24	Passed	Passed
E-UTRA, eFDD 4 QPSK, high channel, 3 MHz, 1, conducted	S01_AR03	2021-10-08	Passed	Passed
E-UTRA, eFDD 4 QPSK, high channel, 3 MHz, 15, conducted	S01_AR03	2021-10-08	Passed	Passed
E-UTRA, eFDD 4 QPSK, high channel, 5 MHz, 1, conducted	S01_AR03	2021-10-08	Passed	Passed
E-UTRA, eFDD 4 QPSK, high channel, 5 MHz, 12, conducted	S01_AR03	2021-10-08	Passed	Passed
E-UTRA, eFDD 4 QPSK, high channel, 5 MHz, 25, conducted	S01_AR03	2021-10-08	Passed	Passed
E-UTRA, eFDD 4 QPSK, low channel, 1.4 MHz, 1, conducted	S01_AR03	2021-10-08	Passed	Passed
E-UTRA, eFDD 4 QPSK, low channel, 1.4 MHz, 3, conducted	S01_AR03	2021-10-08	Passed	Passed
E-UTRA, eFDD 4 QPSK, low channel, 1.4 MHz, 6, conducted	S01_AR03	2021-10-08	Passed	Passed
E-UTRA, eFDD 4 QPSK, low channel, 10 MHz, 1, conducted	S01_AS03	2021-08-14	Passed	Passed
E-UTRA, eFDD 4 QPSK, low channel, 10 MHz, 50, conducted	S01_AS03	2021-08-14	Passed	Passed

47 CFR CHAPTER I FCC PART 27

§ 2.1046 § 27.50

Subpart C

RF Output Power

The measurement was performed according to ANSI C63.26: 2015

Final Result

OP-Mode	Setup	Date	FCC	IC
Technology, Radio Technology, Operating Frequency, ChBW, Ressource Blocks, Measurement method				
E-UTRA, eFDD 4 QPSK, low channel, 15 MHz, 1, conducted	S01_AS04	2021-09-24	Passed	Passed
E-UTRA, eFDD 4 QPSK, low channel, 15 MHz, 36, conducted	S01_AS04	2021-09-24	Passed	Passed
E-UTRA, eFDD 4 QPSK, low channel, 15 MHz, 75, conducted	S01_AS04	2021-09-24	Passed	Passed
E-UTRA, eFDD 4 QPSK, low channel, 20 MHz, 1, conducted	S01_AR03	2021-10-08	Passed	Passed
E-UTRA, eFDD 4 QPSK, low channel, 20 MHz, 100, conducted	S01_AR03	2021-10-08	Passed	Passed
E-UTRA, eFDD 4 QPSK, low channel, 3 MHz, 1, conducted	S01_AR03	2021-10-08	Passed	Passed
E-UTRA, eFDD 4 QPSK, low channel, 3 MHz, 15, conducted	S01_AR03	2021-10-08	Passed	Passed
E-UTRA, eFDD 4 QPSK, low channel, 5 MHz, 1, conducted	S01_AR03	2021-10-08	Passed	Passed
E-UTRA, eFDD 4 QPSK, low channel, 5 MHz, 12, conducted	S01_AR03	2021-10-08	Passed	Passed
E-UTRA, eFDD 4 QPSK, low channel, 5 MHz, 25, conducted	S01_AR03	2021-10-08	Passed	Passed
E-UTRA, eFDD 4 QPSK, mid channel, 1.4 MHz, 1, conducted	S01_AR03	2021-10-08	Passed	Passed
E-UTRA, eFDD 4 QPSK, mid channel, 1.4 MHz, 3, conducted	S01_AR03	2021-10-08	Passed	Passed
E-UTRA, eFDD 4 QPSK, mid channel, 1.4 MHz, 6, conducted	S01_AR03	2021-10-08	Passed	Passed
E-UTRA, eFDD 4 QPSK, mid channel, 10 MHz, 1, conducted	S01_AR03	2021-10-08	Passed	Passed
E-UTRA, eFDD 4 QPSK, mid channel, 10 MHz, 50, conducted	S01_AR03	2021-10-08	Passed	Passed
E-UTRA, eFDD 4 QPSK, mid channel, 15 MHz, 1, conducted	S01_AR03	2021-10-08	Passed	Passed
E-UTRA, eFDD 4 QPSK, mid channel, 15 MHz, 36, conducted	S01_AR03	2021-10-08	Passed	Passed
E-UTRA, eFDD 4 QPSK, mid channel, 15 MHz, 75, conducted	S01_AR03	2021-10-08	Passed	Passed
E-UTRA, eFDD 4 QPSK, mid channel, 20 MHz, 1, conducted	S01_AR03	2021-10-08	Passed	Passed
E-UTRA, eFDD 4 QPSK, mid channel, 20 MHz, 100, conducted	S01_AR03	2021-10-08	Passed	Passed
E-UTRA, eFDD 4 QPSK, mid channel, 3 MHz, 1, conducted	S01_AR03	2021-10-08	Passed	Passed
E-UTRA, eFDD 4 QPSK, mid channel, 3 MHz, 15, conducted	S01_AR03	2021-10-08	Passed	Passed
E-UTRA, eFDD 4 QPSK, mid channel, 5 MHz, 1, conducted	S01_AR03	2021-10-08	Passed	Passed
E-UTRA, eFDD 4 QPSK, mid channel, 5 MHz, 12, conducted	S01_AR03	2021-10-08	Passed	Passed
E-UTRA, eFDD 4 QPSK, mid channel, 5 MHz, 25, conducted	S01_AR03	2021-10-08	Passed	Passed
E-UTRA, eFDD 7 16QAM, high channel, 10 MHz, 1, conducted	S01_BC08	2021-11-04	Passed	Passed
E-UTRA, eFDD 7 16QAM, high channel, 15 MHz, 1, conducted	S01_BC08	2021-11-04	Passed	Passed
E-UTRA, eFDD 7 16QAM, high channel, 20 MHz, 1, conducted	S01_BC08	2021-11-04	Passed	Passed
E-UTRA, eFDD 7 16QAM, high channel, 5 MHz, 1, conducted	S01_BC08	2021-11-04	Passed	Passed
E-UTRA, eFDD 7 16QAM, high channel, 5 MHz, 25, conducted	S01_BC08	2021-11-04	Passed	Passed
E-UTRA, eFDD 7 16QAM, low channel, 10 MHz, 1, conducted	S01_BC08	2021-11-04	Passed	Passed
E-UTRA, eFDD 7 16QAM, low channel, 15 MHz, 1, conducted	S01_BC08	2021-11-04	Passed	Passed
E-UTRA, eFDD 7 16QAM, low channel, 20 MHz, 1, conducted	S01_BC08	2021-11-04	Passed	Passed
E-UTRA, eFDD 7 16QAM, low channel, 5 MHz, 1, conducted	S01_BC08	2021-11-04	Passed	Passed
E-UTRA, eFDD 7 16QAM, low channel, 5 MHz, 25, conducted	S01_BC08	2021-11-04	Passed	Passed
E-UTRA, eFDD 7 16QAM, mid channel, 10 MHz, 1, conducted	S01_BC08	2021-11-04	Passed	Passed
E-UTRA, eFDD 7 16QAM, mid channel, 15 MHz, 1, conducted	S01_BC08	2021-11-04	Passed	Passed
E-UTRA, eFDD 7 16QAM, mid channel, 20 MHz, 1, conducted	S01_BC08	2021-11-04	Passed	Passed
E-UTRA, eFDD 7 16QAM, mid channel, 5 MHz, 1, conducted	S01_BC08	2021-11-04	Passed	Passed
E-UTRA, eFDD 7 16QAM, mid channel, 5 MHz, 25, conducted	S01_BC08	2021-11-04	Passed	Passed
E-UTRA, eFDD 7 QPSK, high channel, 10 MHz, 1, conducted	S01_BC08	2021-11-04	Passed	Passed
E-UTRA, eFDD 7 QPSK, high channel, 10 MHz, 50, conducted	S01_BC08	2021-11-04	Passed	Passed
E-UTRA, eFDD 7 QPSK, high channel, 15 MHz, 1, conducted	S01_BC08	2021-11-04	Passed	Passed
E-UTRA, eFDD 7 QPSK, high channel, 15 MHz, 36, conducted	S01_BC08	2021-11-04	Passed	Passed
E-UTRA, eFDD 7 QPSK, high channel, 15 MHz, 75, conducted	S01_BC08	2021-11-04	Passed	Passed

47 CFR CHAPTER I FCC PART 27

§ 2.1046 § 27.50

Subpart C

RF Output Power

The measurement was performed according to ANSI C63.26: 2015

Final Result

OP-Mode	Setup	Date	FCC	IC
Technology, Radio Technology, Operating Frequency, ChBW, Ressource Blocks, Measurement method				
E-UTRA, eFDD 7 QPSK, high channel, 20 MHz, 1, conducted	S01_BC08	2021-11-04	Passed	Passed
E-UTRA, eFDD 7 QPSK, high channel, 20 MHz, 100, conducted	S01_BC08	2021-11-04	Passed	Passed
E-UTRA, eFDD 7 QPSK, high channel, 5 MHz, 1, conducted	S01_BC08	2021-11-04	Passed	Passed
E-UTRA, eFDD 7 QPSK, high channel, 5 MHz, 12, conducted	S01_BC08	2021-11-04	Passed	Passed
E-UTRA, eFDD 7 QPSK, high channel, 5 MHz, 25, conducted	S01_BC08	2021-11-04	Passed	Passed
E-UTRA, eFDD 7 QPSK, low channel, 10 MHz, 1, conducted	S01_BC08	2021-11-04	Passed	Passed
E-UTRA, eFDD 7 QPSK, low channel, 10 MHz, 50, conducted	S01_BC08	2021-11-04	Passed	Passed
E-UTRA, eFDD 7 QPSK, low channel, 15 MHz, 1, conducted	S01_BC08	2021-11-04	Passed	Passed
E-UTRA, eFDD 7 QPSK, low channel, 15 MHz, 36, conducted	S01_BC08	2021-11-04	Passed	Passed
E-UTRA, eFDD 7 QPSK, low channel, 15 MHz, 75, conducted	S01_BC08	2021-11-04	Passed	Passed
E-UTRA, eFDD 7 QPSK, low channel, 20 MHz, 1, conducted	S01_BC08	2021-11-04	Passed	Passed
E-UTRA, eFDD 7 QPSK, low channel, 20 MHz, 100, conducted	S01_BC08	2021-11-04	Passed	Passed
E-UTRA, eFDD 7 QPSK, low channel, 5 MHz, 1, conducted	S01_BC08	2021-11-04	Passed	Passed
E-UTRA, eFDD 7 QPSK, low channel, 5 MHz, 12, conducted	S01_BC08	2021-11-04	Passed	Passed
E-UTRA, eFDD 7 QPSK, low channel, 5 MHz, 25, conducted	S01_BC08	2021-11-04	Passed	Passed
E-UTRA, eFDD 7 QPSK, mid channel, 10 MHz, 1, conducted	S01_BC08	2021-11-04	Passed	Passed
E-UTRA, eFDD 7 QPSK, mid channel, 10 MHz, 50, conducted	S01_BC08	2021-11-04	Passed	Passed
E-UTRA, eFDD 7 QPSK, mid channel, 15 MHz, 1, conducted	S01_BC08	2021-11-04	Passed	Passed
E-UTRA, eFDD 7 QPSK, mid channel, 15 MHz, 36, conducted	S01_BC08	2021-11-04	Passed	Passed
E-UTRA, eFDD 7 QPSK, mid channel, 15 MHz, 75, conducted	S01_BC08	2021-11-04	Passed	Passed
E-UTRA, eFDD 7 QPSK, mid channel, 20 MHz, 1, conducted	S01_BC08	2021-11-04	Passed	Passed
E-UTRA, eFDD 7 QPSK, mid channel, 20 MHz, 100, conducted	S01_BC08	2021-11-04	Passed	Passed
E-UTRA, eFDD 7 QPSK, mid channel, 5 MHz, 1, conducted	S01_BC08	2021-11-04	Passed	Passed
E-UTRA, eFDD 7 QPSK, mid channel, 5 MHz, 12, conducted	S01_BC08	2021-11-04	Passed	Passed
E-UTRA, eFDD 7 QPSK, mid channel, 5 MHz, 25, conducted	S01_BC08	2021-11-04	Passed	Passed
E-UTRA, eTDD 38 16QAM, high channel, 10 MHz, 1, conducted	S01_BC08	2021-11-04	Passed	Passed
E-UTRA, eTDD 38 16QAM, high channel, 15 MHz, 1, conducted	S01_BC08	2021-11-04	Passed	Passed
E-UTRA, eTDD 38 16QAM, high channel, 20 MHz, 1, conducted	S01_BC08	2021-11-04	Passed	Passed
E-UTRA, eTDD 38 16QAM, high channel, 5 MHz, 1, conducted	S01_BC08	2021-11-04	Passed	Passed
E-UTRA, eTDD 38 16QAM, high channel, 5 MHz, 25, conducted	S01_BC08	2021-11-04	Passed	Passed
E-UTRA, eTDD 38 16QAM, low channel, 10 MHz, 1, conducted	S01_BC08	2021-11-04	Passed	Passed
E-UTRA, eTDD 38 16QAM, low channel, 15 MHz, 1, conducted	S01_BC08	2021-11-04	Passed	Passed
E-UTRA, eTDD 38 16QAM, low channel, 20 MHz, 1, conducted	S01_BC08	2021-11-04	Passed	Passed
E-UTRA, eTDD 38 16QAM, low channel, 5 MHz, 1, conducted	S01_BC08	2021-11-04	Passed	Passed
E-UTRA, eTDD 38 16QAM, low channel, 5 MHz, 25, conducted	S01_BC08	2021-11-04	Passed	Passed
E-UTRA, eTDD 38 16QAM, mid channel, 10 MHz, 1, conducted	S01_BC08	2021-11-04	Passed	Passed
E-UTRA, eTDD 38 16QAM, mid channel, 15 MHz, 1, conducted	S01_BC08	2021-11-04	Passed	Passed
E-UTRA, eTDD 38 16QAM, mid channel, 20 MHz, 1, conducted	S01_BC08	2021-11-04	Passed	Passed
E-UTRA, eTDD 38 16QAM, mid channel, 5 MHz, 1, conducted	S01_BC08	2021-11-04	Passed	Passed
E-UTRA, eTDD 38 16QAM, mid channel, 5 MHz, 25, conducted	S01_BC08	2021-11-04	Passed	Passed
E-UTRA, eTDD 38 QPSK, high channel, 10 MHz, 1, conducted	S01_BC08	2021-11-04	Passed	Passed
E-UTRA, eTDD 38 QPSK, high channel, 10 MHz, 50, conducted	S01_BC08	2021-11-04	Passed	Passed
E-UTRA, eTDD 38 QPSK, high channel, 15 MHz, 1, conducted	S01_BC08	2021-11-04	Passed	Passed
E-UTRA, eTDD 38 QPSK, high channel, 15 MHz, 36, conducted	S01_BC08	2021-11-04	Passed	Passed
E-UTRA, eTDD 38 QPSK, high channel, 15 MHz, 75, conducted	S01_BC08	2021-11-04	Passed	Passed

47 CFR CHAPTER I FCC PART 27

§ 2.1046 § 27.50

Subpart C

RF Output Power

The measurement was performed according to ANSI C63.26: 2015

Final Result

OP-Mode	Setup	Date	FCC	IC
Technology, Radio Technology, Operating Frequency, ChBW, Ressource Blocks, Measurement method				
E-UTRA, eTDD 38 QPSK, high channel, 20 MHz, 1, conducted	S01_BC08	2021-11-04	Passed	Passed
E-UTRA, eTDD 38 QPSK, high channel, 20 MHz, 100, conducted	S01_BC08	2021-11-04	Passed	Passed
E-UTRA, eTDD 38 QPSK, high channel, 5 MHz, 1, conducted	S01_BC08	2021-11-04	Passed	Passed
E-UTRA, eTDD 38 QPSK, high channel, 5 MHz, 12, conducted	S01_BC08	2021-11-04	Passed	Passed
E-UTRA, eTDD 38 QPSK, high channel, 5 MHz, 25, conducted	S01_BC08	2021-11-04	Passed	Passed
E-UTRA, eTDD 38 QPSK, low channel, 10 MHz, 1, conducted	S01_BC08	2021-11-04	Passed	Passed
E-UTRA, eTDD 38 QPSK, low channel, 10 MHz, 50, conducted	S01_BC08	2021-11-04	Passed	Passed
E-UTRA, eTDD 38 QPSK, low channel, 15 MHz, 1, conducted	S01_BC08	2021-11-04	Passed	Passed
E-UTRA, eTDD 38 QPSK, low channel, 15 MHz, 36, conducted	S01_BC08	2021-11-04	Passed	Passed
E-UTRA, eTDD 38 QPSK, low channel, 15 MHz, 75, conducted	S01_BC08	2021-11-04	Passed	Passed
E-UTRA, eTDD 38 QPSK, low channel, 20 MHz, 1, conducted	S01_BC08	2021-11-04	Passed	Passed
E-UTRA, eTDD 38 QPSK, low channel, 20 MHz, 100, conducted	S01_BC08	2021-11-04	Passed	Passed
E-UTRA, eTDD 38 QPSK, low channel, 5 MHz, 1, conducted	S01_BC08	2021-11-04	Passed	Passed
E-UTRA, eTDD 38 QPSK, low channel, 5 MHz, 12, conducted	S01_BC08	2021-11-04	Passed	Passed
E-UTRA, eTDD 38 QPSK, low channel, 5 MHz, 25, conducted	S01_BC08	2021-11-04	Passed	Passed
E-UTRA, eTDD 38 QPSK, mid channel, 10 MHz, 1, conducted	S01_BC08	2021-11-04	Passed	Passed
E-UTRA, eTDD 38 QPSK, mid channel, 10 MHz, 50, conducted	S01_BC08	2021-11-04	Passed	Passed
E-UTRA, eTDD 38 QPSK, mid channel, 15 MHz, 1, conducted	S01_BC08	2021-11-04	Passed	Passed
E-UTRA, eTDD 38 QPSK, mid channel, 15 MHz, 36, conducted	S01_BC08	2021-11-04	Passed	Passed
E-UTRA, eTDD 38 QPSK, mid channel, 15 MHz, 75, conducted	S01_BC08	2021-11-04	Passed	Passed
E-UTRA, eTDD 38 QPSK, mid channel, 20 MHz, 1, conducted	S01_BC08	2021-11-04	Passed	Passed
E-UTRA, eTDD 38 QPSK, mid channel, 20 MHz, 100, conducted	S01_BC08	2021-11-04	Passed	Passed
E-UTRA, eTDD 38 QPSK, mid channel, 5 MHz, 1, conducted	S01_BC08	2021-11-04	Passed	Passed
E-UTRA, eTDD 38 QPSK, mid channel, 5 MHz, 12, conducted	S01_BC08	2021-11-04	Passed	Passed
E-UTRA, eTDD 38 QPSK, mid channel, 5 MHz, 25, conducted	S01_BC08	2021-11-04	Passed	Passed
E-UTRA, eTDD 41 16QAM, high channel, 10 MHz, 1, conducted	S01_BC08	2021-11-04	Passed	Passed
E-UTRA, eTDD 41 16QAM, high channel, 15 MHz, 1, conducted	S01_BC08	2021-11-04	Passed	Passed
E-UTRA, eTDD 41 16QAM, high channel, 20 MHz, 1, conducted	S01_BC08	2021-11-04	Passed	Passed
E-UTRA, eTDD 41 16QAM, high channel, 5 MHz, 1, conducted	S01_BC08	2021-11-04	Passed	Passed
E-UTRA, eTDD 41 16QAM, high channel, 5 MHz, 25, conducted	S01_BC08	2021-11-04	Passed	Passed
E-UTRA, eTDD 41 16QAM, low channel, 10 MHz, 1, conducted	S01_BC08	2021-11-04	Passed	Passed
E-UTRA, eTDD 41 16QAM, low channel, 15 MHz, 1, conducted	S01_BC08	2021-11-04	Passed	Passed
E-UTRA, eTDD 41 16QAM, low channel, 20 MHz, 1, conducted	S01_BC08	2021-11-04	Passed	Passed
E-UTRA, eTDD 41 16QAM, low channel, 5 MHz, 1, conducted	S01_BC08	2021-11-04	Passed	Passed
E-UTRA, eTDD 41 16QAM, low channel, 5 MHz, 25, conducted	S01_BC08	2021-11-04	Passed	Passed
E-UTRA, eTDD 41 16QAM, mid channel, 10 MHz, 1, conducted	S01_BC08	2021-11-04	Passed	Passed
E-UTRA, eTDD 41 16QAM, mid channel, 15 MHz, 1, conducted	S01_BC08	2021-11-04	Passed	Passed
E-UTRA, eTDD 41 16QAM, mid channel, 20 MHz, 1, conducted	S01_BC08	2021-11-04	Passed	Passed
E-UTRA, eTDD 41 16QAM, mid channel, 5 MHz, 1, conducted	S01_BC08	2021-11-04	Passed	Passed
E-UTRA, eTDD 41 16QAM, mid channel, 5 MHz, 25, conducted	S01_BC08	2021-11-04	Passed	Passed
E-UTRA, eTDD 41 QPSK, high channel, 10 MHz, 1, conducted	S01_BC08	2021-11-04	Passed	Passed
E-UTRA, eTDD 41 QPSK, high channel, 10 MHz, 50, conducted	S01_BC08	2021-11-04	Passed	Passed
E-UTRA, eTDD 41 QPSK, high channel, 15 MHz, 1, conducted	S01_BC08	2021-11-04	Passed	Passed
E-UTRA, eTDD 41 QPSK, high channel, 15 MHz, 36, conducted	S01_BC08	2021-11-04	Passed	Passed
E-UTRA, eTDD 41 QPSK, high channel, 15 MHz, 75, conducted	S01_BC08	2021-11-04	Passed	Passed

47 CFR CHAPTER I FCC PART 27
Subpart C

§ 2.1046 § 27.50

RF Output Power

The measurement was performed according to ANSI C63.26: 2015

Final Result

OP-Mode	Setup	Date	FCC	IC
Technology, Radio Technology, Operating Frequency, ChBW, Ressource Blocks, Measurement method				
E-UTRA, eTDD 41 QPSK, high channel, 20 MHz, 1, conducted	S01_BC08	2021-11-04	Passed	Passed
E-UTRA, eTDD 41 QPSK, high channel, 20 MHz, 100, conducted	S01_BC08	2021-11-04	Passed	Passed
E-UTRA, eTDD 41 QPSK, high channel, 5 MHz, 1, conducted	S01_BC08	2021-11-04	Passed	Passed
E-UTRA, eTDD 41 QPSK, high channel, 5 MHz, 12, conducted	S01_BC08	2021-11-04	Passed	Passed
E-UTRA, eTDD 41 QPSK, high channel, 5 MHz, 25, conducted	S01_BC08	2021-11-04	Passed	Passed
E-UTRA, eTDD 41 QPSK, low channel, 10 MHz, 1, conducted	S01_BC08	2021-11-04	Passed	Passed
E-UTRA, eTDD 41 QPSK, low channel, 10 MHz, 50, conducted	S01_BC08	2021-11-04	Passed	Passed
E-UTRA, eTDD 41 QPSK, low channel, 15 MHz, 1, conducted	S01_BC08	2021-11-04	Passed	Passed
E-UTRA, eTDD 41 QPSK, low channel, 15 MHz, 36, conducted	S01_BC08	2021-11-04	Passed	Passed
E-UTRA, eTDD 41 QPSK, low channel, 15 MHz, 75, conducted	S01_BC08	2021-11-04	Passed	Passed
E-UTRA, eTDD 41 QPSK, low channel, 20 MHz, 1, conducted	S01_BC08	2021-11-04	Passed	Passed
E-UTRA, eTDD 41 QPSK, low channel, 20 MHz, 100, conducted	S01_BC08	2021-11-04	Passed	Passed
E-UTRA, eTDD 41 QPSK, low channel, 5 MHz, 1, conducted	S01_BC08	2021-11-04	Passed	Passed
E-UTRA, eTDD 41 QPSK, low channel, 5 MHz, 12, conducted	S01_BC08	2021-11-04	Passed	Passed
E-UTRA, eTDD 41 QPSK, low channel, 5 MHz, 25, conducted	S01_BC08	2021-11-04	Passed	Passed
E-UTRA, eTDD 41 QPSK, mid channel, 10 MHz, 1, conducted	S01_BC08	2021-11-04	Passed	Passed
E-UTRA, eTDD 41 QPSK, mid channel, 10 MHz, 50, conducted	S01_BC08	2021-11-04	Passed	Passed
E-UTRA, eTDD 41 QPSK, mid channel, 15 MHz, 1, conducted	S01_BC08	2021-11-04	Passed	Passed
E-UTRA, eTDD 41 QPSK, mid channel, 15 MHz, 36, conducted	S01_BC08	2021-11-04	Passed	Passed
E-UTRA, eTDD 41 QPSK, mid channel, 15 MHz, 75, conducted	S01_BC08	2021-11-04	Passed	Passed
E-UTRA, eTDD 41 QPSK, mid channel, 20 MHz, 1, conducted	S01_BC08	2021-11-04	Passed	Passed
E-UTRA, eTDD 41 QPSK, mid channel, 20 MHz, 100, conducted	S01_BC08	2021-11-04	Passed	Passed
E-UTRA, eTDD 41 QPSK, mid channel, 5 MHz, 1, conducted	S01_BC08	2021-11-04	Passed	Passed
E-UTRA, eTDD 41 QPSK, mid channel, 5 MHz, 12, conducted	S01_BC08	2021-11-04	Passed	Passed
E-UTRA, eTDD 41 QPSK, mid channel, 5 MHz, 25, conducted	S01_BC08	2021-11-04	Passed	Passed

47 CFR CHAPTER I FCC PART 27
Subpart C

§ 2.1055 § 27.54

Frequency stability

The measurement was performed according to ANSI C63.26: 2015

Final Result

OP-Mode	Setup	Date	FCC	IC
Technology, Radio Technology, Operating Frequency, ChBW, Ressource Blocks, Measurement method				
E-UTRA, eFDD 12 QPSK, mid channel, 5 MHz, 1, conducted	S01_AS04	2021-10-21	Passed	Passed
E-UTRA, eFDD 13 QPSK, mid channel, 5 MHz, 1, conducted	S01_AS04	2021-10-21	Passed	Passed
E-UTRA, eFDD 4 QPSK, mid channel, 5 MHz, 1, conducted	S01_AS04	2021-10-21	Passed	Passed
E-UTRA, eFDD 7 QPSK, mid channel, 5 MHz, 1, conducted	S01_BC08	2021-11-07	Passed	Passed
E-UTRA, eTDD 38 QPSK, mid channel, 5 MHz, 1, conducted	S01_BC08	2021-11-07	Passed	Passed
E-UTRA, eTDD 41 QPSK, mid channel, 5 MHz, 1, conducted	S01_BC08	2021-11-07	Passed	Passed

47 CFR CHAPTER I FCC PART 27

§ 2.1051 § 27.53

Subpart C

Spurious emissions at antenna terminals

The measurement was performed according to ANSI C63.26: 2015

Final Result

OP-Mode	Setup	Date	FCC	IC
Technology, Radio Technology, Operating Frequency, ChBW, Ressource Blocks, Measurement method				
E-UTRA, eFDD 12 QPSK, high channel, 5 MHz, 1, conducted	S01_AS03	2021-12-08	Passed	Passed
E-UTRA, eFDD 12 QPSK, low channel, 5 MHz, 1, conducted	S01_AS03	2021-12-08	Passed	Passed
E-UTRA, eFDD 12 QPSK, mid channel, 5 MHz, 1, conducted	S01_AS03	2021-12-08	Passed	Passed
E-UTRA, eFDD 13 QPSK, high channel, 5 MHz, 1, conducted	S01_AS03	2021-12-08	Passed	Passed
E-UTRA, eFDD 13 QPSK, low channel, 5 MHz, 1, conducted	S01_AS03	2021-12-08	Passed	Passed
E-UTRA, eFDD 13 QPSK, mid channel, 5 MHz, 1, conducted	S01_AS03	2021-12-08	Passed	Passed
E-UTRA, eFDD 4 QPSK, high channel, 5 MHz, 1, conducted	S01_AS04	2021-10-21	Passed	Passed
E-UTRA, eFDD 4 QPSK, low channel, 5 MHz, 1, conducted	S01_AS03	2021-12-08	Passed	Passed
E-UTRA, eFDD 4 QPSK, mid channel, 5 MHz, 1, conducted	S01_AS03	2021-12-08	Passed	Passed
E-UTRA, eFDD 7 QPSK, high channel, 5 MHz, 1, conducted	S01_BC08	2021-11-04	Passed	Passed
E-UTRA, eFDD 7 QPSK, low channel, 5 MHz, 1, conducted	S01_BC08	2021-11-04	Passed	Passed
E-UTRA, eFDD 7 QPSK, mid channel, 5 MHz, 1, conducted	S01_BC08	2021-11-04	Passed	Passed
E-UTRA, eTDD 38 QPSK, high channel, 5 MHz, 1, conducted	S01_BC08	2021-11-04	Passed	Passed
E-UTRA, eTDD 38 QPSK, low channel, 5 MHz, 1, conducted	S01_BC08	2021-11-04	Passed	Passed
E-UTRA, eTDD 38 QPSK, mid channel, 5 MHz, 1, conducted	S01_BC08	2021-11-04	Passed	Passed
E-UTRA, eTDD 41 QPSK, high channel, 5 MHz, 1, conducted	S01_BC08	2021-11-04	Passed	Passed
E-UTRA, eTDD 41 QPSK, low channel, 5 MHz, 1, conducted	S01_BC08	2021-11-04	Passed	Passed
E-UTRA, eTDD 41 QPSK, mid channel, 5 MHz, 1, conducted	S01_BC08	2021-11-04	Passed	Passed

47 CFR CHAPTER I FCC PART 27

§ 2.1053 § 27.53

Subpart C

Field strength of spurious radiation

The measurement was performed according to ANSI C63.26: 2015

Final Result

OP-Mode	Setup	Date	FCC	IC
Technology, Radio Technology, Operating Frequency, ChBW, Ressource Blocks, Measurement method				
E-UTRA, eFDD 12 QPSK, high channel, 5 MHz, 1, radiated	S01_AS04	2021-09-29	Passed	Passed
E-UTRA, eFDD 12 QPSK, low channel, 5 MHz, 1, radiated	S01_AS04	2021-09-29	Passed	Passed
E-UTRA, eFDD 12 QPSK, mid channel, 5 MHz, 1, radiated	S01_AS04	2021-09-29	Passed	Passed
E-UTRA, eFDD 13 QPSK, high channel, 5 MHz, 1, radiated	S01_AS04	2021-09-29	Passed	Passed
E-UTRA, eFDD 13 QPSK, low channel, 5 MHz, 1, radiated	S01_AS04	2021-09-29	Passed	Passed
E-UTRA, eFDD 13 QPSK, mid channel, 5 MHz, 1, radiated	S01_AS04	2021-09-29	Passed	Passed
E-UTRA, eFDD 4 QPSK, high channel, 5 MHz, 1, radiated	S01_AS04	2021-09-29	Passed	Passed
E-UTRA, eFDD 4 QPSK, low channel, 5 MHz, 1, radiated	S01_AS04	2021-09-29	Passed	Passed
E-UTRA, eFDD 4 QPSK, mid channel, 5 MHz, 1, radiated	S01_AS04	2021-09-29	Passed	Passed
E-UTRA, eFDD 7 QPSK, high channel, 5 MHz, 1, radiated	S01_BC08	2021-11-04	Passed	Passed
E-UTRA, eFDD 7 QPSK, low channel, 5 MHz, 1, radiated	S01_BC08	2021-11-04	Passed	Passed
E-UTRA, eFDD 7 QPSK, mid channel, 5 MHz, 1, radiated	S01_BC08	2021-11-04	Passed	Passed
E-UTRA, eTDD 38 QPSK, high channel, 5 MHz, 1, radiated	S01_BC08	2021-11-04	Passed	Passed
E-UTRA, eTDD 38 QPSK, low channel, 5 MHz, 1, radiated	S01_BC08	2021-11-04	Passed	Passed
E-UTRA, eTDD 38 QPSK, mid channel, 5 MHz, 1, radiated	S01_BC08	2021-11-04	Passed	Passed
E-UTRA, eTDD 41 QPSK, high channel, 5 MHz, 1, radiated	S01_BC08	2021-11-16	Passed	Passed
E-UTRA, eTDD 41 QPSK, low channel, 5 MHz, 1, radiated	S01_BC08	2021-11-16	Passed	Passed
E-UTRA, eTDD 41 QPSK, mid channel, 5 MHz, 1, radiated	S01_BC08	2021-11-16	Passed	Passed

47 CFR CHAPTER I FCC PART 27
Subpart C

§ 2.1049

Emission and occupied bandwidth

The measurement was performed according to ANSI C63.26: 2015

Final Result

OP-Mode

Technology, Radio Technology, Operating Frequency, ChBW, Ressource Blocks, Measurement method

	Setup	Date	FCC	IC
E-UTRA, eFDD 12 16QAM, high channel, 1.4 MHz, 6, conducted	S01_AS04	2021-08-26	Passed	Passed
E-UTRA, eFDD 12 16QAM, high channel, 3 MHz, 15, conducted	S01_AS04	2021-08-26	Passed	Passed
E-UTRA, eFDD 12 16QAM, high channel, 5 MHz, 25, conducted	S01_AS04	2021-08-26	Passed	Passed
E-UTRA, eFDD 12 16QAM, low channel, 1.4 MHz, 6, conducted	S01_AS04	2021-08-26	Passed	Passed
E-UTRA, eFDD 12 16QAM, low channel, 3 MHz, 15, conducted	S01_AS04	2021-08-26	Passed	Passed
E-UTRA, eFDD 12 16QAM, low channel, 5 MHz, 25, conducted	S01_AS04	2021-08-26	Passed	Passed
E-UTRA, eFDD 12 16QAM, mid channel, 1.4 MHz, 6, conducted	S01_AS04	2021-08-26	Passed	Passed
E-UTRA, eFDD 12 16QAM, mid channel, 3 MHz, 15, conducted	S01_AS04	2021-08-26	Passed	Passed
E-UTRA, eFDD 12 16QAM, mid channel, 5 MHz, 25, conducted	S01_AS04	2021-08-26	Passed	Passed
E-UTRA, eFDD 12 QPSK, high channel, 1.4 MHz, 6, conducted	S01_AR03	2021-10-08	Passed	Passed
E-UTRA, eFDD 12 QPSK, high channel, 10 MHz, 50, conducted	S01_AR03	2021-10-08	Passed	Passed
E-UTRA, eFDD 12 QPSK, high channel, 3 MHz, 15, conducted	S01_AR03	2021-10-08	Passed	Passed
E-UTRA, eFDD 12 QPSK, high channel, 5 MHz, 25, conducted	S01_AR03	2021-10-08	Passed	Passed
E-UTRA, eFDD 12 QPSK, low channel, 1.4 MHz, 6, conducted	S01_AR03	2021-10-08	Passed	Passed
E-UTRA, eFDD 12 QPSK, low channel, 10 MHz, 50, conducted	S01_AR03	2021-10-08	Passed	Passed
E-UTRA, eFDD 12 QPSK, low channel, 3 MHz, 15, conducted	S01_AR03	2021-10-08	Passed	Passed
E-UTRA, eFDD 12 QPSK, low channel, 5 MHz, 25, conducted	S01_AR03	2021-10-08	Passed	Passed
E-UTRA, eFDD 12 QPSK, mid channel, 1.4 MHz, 6, conducted	S01_AR03	2021-10-08	Passed	Passed
E-UTRA, eFDD 12 QPSK, mid channel, 10 MHz, 50, conducted	S01_AR03	2021-10-08	Passed	Passed
E-UTRA, eFDD 12 QPSK, mid channel, 3 MHz, 15, conducted	S01_AR03	2021-10-08	Passed	Passed
E-UTRA, eFDD 12 QPSK, mid channel, 5 MHz, 25, conducted	S01_AR03	2021-10-08	Passed	Passed
E-UTRA, eFDD 13 16QAM, high channel, 5 MHz, 25, conducted	S01_AS04	2021-08-26	Passed	Passed
E-UTRA, eFDD 13 16QAM, low channel, 5 MHz, 25, conducted	S01_AS04	2021-08-26	Passed	Passed
E-UTRA, eFDD 13 16QAM, mid channel, 5 MHz, 25, conducted	S01_AS04	2021-08-26	Passed	Passed
E-UTRA, eFDD 13 QPSK, high channel, 5 MHz, 25, conducted	S01_AR03	2021-10-08	Passed	Passed
E-UTRA, eFDD 13 QPSK, low channel, 5 MHz, 25, conducted	S01_AR03	2021-10-08	Passed	Passed
E-UTRA, eFDD 13 QPSK, mid channel, 10 MHz, 50, conducted	S01_AR03	2021-10-08	Passed	Passed
E-UTRA, eFDD 13 QPSK, mid channel, 5 MHz, 25, conducted	S01_AR03	2021-10-08	Passed	Passed
E-UTRA, eFDD 4 16QAM, high channel, 1.4 MHz, 6, conducted	S01_AS04	2021-08-26	Passed	Passed
E-UTRA, eFDD 4 16QAM, high channel, 3 MHz, 15, conducted	S01_AS04	2021-08-26	Passed	Passed
E-UTRA, eFDD 4 16QAM, high channel, 5 MHz, 25, conducted	S01_AS04	2021-08-26	Passed	Passed
E-UTRA, eFDD 4 16QAM, low channel, 1.4 MHz, 6, conducted	S01_AS04	2021-08-26	Passed	Passed
E-UTRA, eFDD 4 16QAM, low channel, 3 MHz, 15, conducted	S01_AS04	2021-08-26	Passed	Passed
E-UTRA, eFDD 4 16QAM, low channel, 5 MHz, 25, conducted	S01_AS04	2021-08-26	Passed	Passed
E-UTRA, eFDD 4 16QAM, mid channel, 1.4 MHz, 6, conducted	S01_AS04	2021-08-26	Passed	Passed
E-UTRA, eFDD 4 16QAM, mid channel, 3 MHz, 15, conducted	S01_AS04	2021-08-26	Passed	Passed
E-UTRA, eFDD 4 16QAM, mid channel, 5 MHz, 25, conducted	S01_AS04	2021-08-26	Passed	Passed
E-UTRA, eFDD 4 16QAM, high channel, 10 MHz, 12, conducted	S01_AS04	2021-08-26	Passed	Passed
E-UTRA, eFDD 4 16QAM, high channel, 15 MHz, 18, conducted	S01_AS04	2021-08-26	Passed	Passed
E-UTRA, eFDD 4 16QAM, high channel, 20 MHz, 18, conducted	S01_AS04	2021-08-26	Passed	Passed
E-UTRA, eFDD 4 16QAM, low channel, 10 MHz, 12, conducted	S01_AS04	2021-08-26	Passed	Passed
E-UTRA, eFDD 4 16QAM, low channel, 15 MHz, 18, conducted	S01_AS04	2021-08-26	Passed	Passed
E-UTRA, eFDD 4 16QAM, low channel, 20 MHz, 18, conducted	S01_AS04	2021-08-26	Passed	Passed

47 CFR CHAPTER I FCC PART 27
Subpart C

§ 2.1049

Emission and occupied bandwidth

The measurement was performed according to ANSI C63.26: 2015

Final Result

OP-Mode	Setup	Date	FCC	IC
Technology, Radio Technology, Operating Frequency, ChBW, Ressource Blocks, Measurement method				
E-UTRA, eFDD 4 16QAM, mid channel, 10 MHz, 12, conducted	S01_AS04	2021-08-26	Passed	Passed
E-UTRA, eFDD 4 16QAM, mid channel, 15 MHz, 18, conducted	S01_AS04	2021-08-26	Passed	Passed
E-UTRA, eFDD 4 16QAM, mid channel, 20 MHz, 18, conducted	S01_AS04	2021-08-26	Passed	Passed
E-UTRA, eFDD 4 QPSK, high channel, 1.4 MHz, 6, conducted	S01_AR03	2021-10-08	Passed	Passed
E-UTRA, eFDD 4 QPSK, high channel, 10 MHz, 50, conducted	S01_AR03	2021-10-08	Passed	Passed
E-UTRA, eFDD 4 QPSK, high channel, 15 MHz, 75, conducted	S01_AR03	2021-10-08	Passed	Passed
E-UTRA, eFDD 4 QPSK, high channel, 20 MHz, 100, conducted	S01_AR03	2021-10-08	Passed	Passed
E-UTRA, eFDD 4 QPSK, high channel, 3 MHz, 15, conducted	S01_AR03	2021-10-08	Passed	Passed
E-UTRA, eFDD 4 QPSK, high channel, 5 MHz, 25, conducted	S01_AR03	2021-10-08	Passed	Passed
E-UTRA, eFDD 4 QPSK, low channel, 1.4 MHz, 6, conducted	S01_AR03	2021-10-08	Passed	Passed
E-UTRA, eFDD 4 QPSK, low channel, 10 MHz, 50, conducted	S01_AR03	2021-10-08	Passed	Passed
E-UTRA, eFDD 4 QPSK, low channel, 15 MHz, 75, conducted	S01_AR03	2021-10-08	Passed	Passed
E-UTRA, eFDD 4 QPSK, low channel, 20 MHz, 100, conducted	S01_AR03	2021-10-08	Passed	Passed
E-UTRA, eFDD 4 QPSK, low channel, 3 MHz, 15, conducted	S01_AR03	2021-10-08	Passed	Passed
E-UTRA, eFDD 4 QPSK, low channel, 5 MHz, 25, conducted	S01_AR03	2021-10-08	Passed	Passed
E-UTRA, eFDD 4 QPSK, mid channel, 1.4 MHz, 6, conducted	S01_AR03	2021-10-08	Passed	Passed
E-UTRA, eFDD 4 QPSK, mid channel, 10 MHz, 50, conducted	S01_AR03	2021-10-08	Passed	Passed
E-UTRA, eFDD 4 QPSK, mid channel, 15 MHz, 75, conducted	S01_AR03	2021-10-08	Passed	Passed
E-UTRA, eFDD 4 QPSK, mid channel, 20 MHz, 100, conducted	S01_AR03	2021-10-08	Passed	Passed
E-UTRA, eFDD 4 QPSK, mid channel, 3 MHz, 15, conducted	S01_AR03	2021-10-08	Passed	Passed
E-UTRA, eFDD 4 QPSK, mid channel, 5 MHz, 25, conducted	S01_AR03	2021-10-08	Passed	Passed
E-UTRA, eFDD 7 16QAM, high channel, 5 MHz, 25, conducted	S01_BC08	2021-11-10	Passed	Passed
E-UTRA, eFDD 7 16QAM, low channel, 5 MHz, 25, conducted	S01_BC08	2021-11-10	Passed	Passed
E-UTRA, eFDD 7 16QAM, mid channel, 5 MHz, 25, conducted	S01_BC08	2021-11-10	Passed	Passed
E-UTRA, eFDD 7 16QAM, high channel, 10 MHz, 12, conducted	S01_BC08	2021-11-10	Passed	Passed
E-UTRA, eFDD 7 16QAM, high channel, 15 MHz, 18, conducted	S01_BC08	2021-11-10	Passed	Passed
E-UTRA, eFDD 7 16QAM, high channel, 20 MHz, 18, conducted	S01_BC08	2021-11-10	Passed	Passed
E-UTRA, eFDD 7 16QAM, low channel, 10 MHz, 12, conducted	S01_BC08	2021-11-10	Passed	Passed
E-UTRA, eFDD 7 16QAM, low channel, 15 MHz, 18, conducted	S01_BC08	2021-11-10	Passed	Passed
E-UTRA, eFDD 7 16QAM, low channel, 20 MHz, 18, conducted	S01_BC08	2021-11-10	Passed	Passed
E-UTRA, eFDD 7 16QAM, mid channel, 10 MHz, 12, conducted	S01_BC08	2021-11-10	Passed	Passed
E-UTRA, eFDD 7 16QAM, mid channel, 15 MHz, 18, conducted	S01_BC08	2021-11-10	Passed	Passed
E-UTRA, eFDD 7 16QAM, mid channel, 20 MHz, 18, conducted	S01_BC08	2021-11-10	Passed	Passed
E-UTRA, eFDD 7 QPSK, high channel, 10 MHz, 50, conducted	S01_BC08	2021-11-10	Passed	Passed
E-UTRA, eFDD 7 QPSK, high channel, 15 MHz, 75, conducted	S01_BC08	2021-11-10	Passed	Passed
E-UTRA, eFDD 7 QPSK, high channel, 20 MHz, 100, conducted	S01_BC08	2021-11-10	Passed	Passed
E-UTRA, eFDD 7 QPSK, high channel, 5 MHz, 25, conducted	S01_BC08	2021-11-10	Passed	Passed
E-UTRA, eFDD 7 QPSK, low channel, 10 MHz, 50, conducted	S01_BC08	2021-11-10	Passed	Passed
E-UTRA, eFDD 7 QPSK, low channel, 15 MHz, 75, conducted	S01_BC08	2021-11-10	Passed	Passed
E-UTRA, eFDD 7 QPSK, low channel, 20 MHz, 100, conducted	S01_BC08	2021-11-10	Passed	Passed
E-UTRA, eFDD 7 QPSK, low channel, 5 MHz, 25, conducted	S01_BC08	2021-11-10	Passed	Passed
E-UTRA, eFDD 7 QPSK, mid channel, 10 MHz, 50, conducted	S01_BC08	2021-11-10	Passed	Passed
E-UTRA, eFDD 7 QPSK, mid channel, 15 MHz, 75, conducted	S01_BC08	2021-11-10	Passed	Passed
E-UTRA, eFDD 7 QPSK, mid channel, 20 MHz, 100, conducted	S01_BC08	2021-11-10	Passed	Passed
E-UTRA, eFDD 7 QPSK, mid channel, 5 MHz, 25, conducted	S01_BC08	2021-11-10	Passed	Passed

47 CFR CHAPTER I FCC PART 27

§ 2.1049

Subpart C

Emission and occupied bandwidth

The measurement was performed according to ANSI C63.26: 2015

Final Result

OP-Mode	Setup	Date	FCC	IC
Technology, Radio Technology, Operating Frequency, ChBW, Ressource Blocks, Measurement method				
E-UTRA, eTDD 38 16QAM, high channel, 5 MHz, 25, conducted	S01_BC08	2021-11-10	Passed	Passed
E-UTRA, eTDD 38 16QAM, low channel, 5 MHz, 25, conducted	S01_BC08	2021-11-10	Passed	Passed
E-UTRA, eTDD 38 16QAM, mid channel, 5 MHz, 25, conducted	S01_BC08	2021-11-10	Passed	Passed
E-UTRA, eTDD 38 16QAM, high channel, 10 MHz, 12, conducted	S01_BC08	2021-11-10	Passed	Passed
E-UTRA, eTDD 38 16QAM, high channel, 15 MHz, 18, conducted	S01_BC08	2021-11-10	Passed	Passed
E-UTRA, eTDD 38 16QAM, high channel, 20 MHz, 18, conducted	S01_BC08	2021-11-10	Passed	Passed
E-UTRA, eTDD 38 16QAM, low channel, 10 MHz, 12, conducted	S01_BC08	2021-11-10	Passed	Passed
E-UTRA, eTDD 38 16QAM, low channel, 15 MHz, 18, conducted	S01_BC08	2021-11-10	Passed	Passed
E-UTRA, eTDD 38 16QAM, low channel, 20 MHz, 18, conducted	S01_BC08	2021-11-10	Passed	Passed
E-UTRA, eTDD 38 16QAM, mid channel, 10 MHz, 12, conducted	S01_BC08	2021-11-10	Passed	Passed
E-UTRA, eTDD 38 16QAM, mid channel, 15 MHz, 18, conducted	S01_BC08	2021-11-10	Passed	Passed
E-UTRA, eTDD 38 16QAM, mid channel, 20 MHz, 18, conducted	S01_BC08	2021-11-10	Passed	Passed
E-UTRA, eTDD 38 QPSK, high channel, 10 MHz, 50, conducted	S01_BC08	2021-11-10	Passed	Passed
E-UTRA, eTDD 38 QPSK, high channel, 15 MHz, 75, conducted	S01_BC08	2021-11-10	Passed	Passed
E-UTRA, eTDD 38 QPSK, high channel, 20 MHz, 100, conducted	S01_BC08	2021-11-10	Passed	Passed
E-UTRA, eTDD 38 QPSK, high channel, 5 MHz, 25, conducted	S01_BC08	2021-11-10	Passed	Passed
E-UTRA, eTDD 38 QPSK, low channel, 10 MHz, 50, conducted	S01_BC08	2021-11-10	Passed	Passed
E-UTRA, eTDD 38 QPSK, low channel, 15 MHz, 75, conducted	S01_BC08	2021-11-10	Passed	Passed
E-UTRA, eTDD 38 QPSK, low channel, 20 MHz, 100, conducted	S01_BC08	2021-11-10	Passed	Passed
E-UTRA, eTDD 38 QPSK, low channel, 5 MHz, 25, conducted	S01_BC08	2021-11-10	Passed	Passed
E-UTRA, eTDD 38 QPSK, mid channel, 10 MHz, 50, conducted	S01_BC08	2021-11-10	Passed	Passed
E-UTRA, eTDD 38 QPSK, mid channel, 15 MHz, 75, conducted	S01_BC08	2021-11-10	Passed	Passed
E-UTRA, eTDD 38 QPSK, mid channel, 20 MHz, 100, conducted	S01_BC08	2021-11-10	Passed	Passed
E-UTRA, eTDD 38 QPSK, mid channel, 5 MHz, 25, conducted	S01_BC08	2021-11-10	Passed	Passed
E-UTRA, eTDD 41 16QAM, high channel, 5 MHz, 25, conducted	S01_BC08	2021-11-10	Passed	Passed
E-UTRA, eTDD 41 16QAM, low channel, 5 MHz, 25, conducted	S01_BC08	2021-11-10	Passed	Passed
E-UTRA, eTDD 41 16QAM, mid channel, 5 MHz, 25, conducted	S01_BC08	2021-11-10	Passed	Passed
E-UTRA, eTDD 41 16QAM, high channel, 10 MHz, 12, conducted	S01_BC08	2021-11-10	Passed	Passed
E-UTRA, eTDD 41 16QAM, high channel, 15 MHz, 18, conducted	S01_BC08	2021-11-10	Passed	Passed
E-UTRA, eTDD 41 16QAM, high channel, 20 MHz, 18, conducted	S01_BC08	2021-11-10	Passed	Passed
E-UTRA, eTDD 41 16QAM, low channel, 10 MHz, 12, conducted	S01_BC08	2021-11-10	Passed	Passed
E-UTRA, eTDD 41 16QAM, low channel, 15 MHz, 18, conducted	S01_BC08	2021-11-10	Passed	Passed
E-UTRA, eTDD 41 16QAM, low channel, 20 MHz, 18, conducted	S01_BC08	2021-11-10	Passed	Passed
E-UTRA, eTDD 41 16QAM, mid channel, 10 MHz, 12, conducted	S01_BC08	2021-11-10	Passed	Passed
E-UTRA, eTDD 41 16QAM, mid channel, 15 MHz, 18, conducted	S01_BC08	2021-11-10	Passed	Passed
E-UTRA, eTDD 41 16QAM, mid channel, 20 MHz, 18, conducted	S01_BC08	2021-11-10	Passed	Passed
E-UTRA, eTDD 41 QPSK, high channel, 10 MHz, 50, conducted	S01_BC08	2021-11-10	Passed	Passed
E-UTRA, eTDD 41 QPSK, high channel, 15 MHz, 75, conducted	S01_BC08	2021-11-10	Passed	Passed
E-UTRA, eTDD 41 QPSK, high channel, 20 MHz, 100, conducted	S01_BC08	2021-11-10	Passed	Passed
E-UTRA, eTDD 41 QPSK, high channel, 5 MHz, 25, conducted	S01_BC08	2021-11-10	Passed	Passed
E-UTRA, eTDD 41 QPSK, low channel, 10 MHz, 50, conducted	S01_BC08	2021-11-10	Passed	Passed
E-UTRA, eTDD 41 QPSK, low channel, 15 MHz, 75, conducted	S01_BC08	2021-11-10	Passed	Passed
E-UTRA, eTDD 41 QPSK, low channel, 20 MHz, 100, conducted	S01_BC08	2021-11-10	Passed	Passed
E-UTRA, eTDD 41 QPSK, low channel, 5 MHz, 25, conducted	S01_BC08	2021-11-10	Passed	Passed
E-UTRA, eTDD 41 QPSK, mid channel, 10 MHz, 50, conducted	S01_BC08	2021-11-10	Passed	Passed

47 CFR CHAPTER I FCC PART 27

§ 2.1049

Subpart C

Emission and occupied bandwidth

The measurement was performed according to ANSI C63.26: 2015

Final Result

OP-Mode

Technology, Radio Technology, Operating Frequency, ChBW, Ressource Blocks, Measurement method

	Setup	Date	FCC	IC
E-UTRA, eTDD 41 QPSK, mid channel, 15 MHz, 75, conducted	S01_BC08	2021-11-10	Passed	Passed
E-UTRA, eTDD 41 QPSK, mid channel, 20 MHz, 100, conducted	S01_BC08	2021-11-10	Passed	Passed
E-UTRA, eTDD 41 QPSK, mid channel, 5 MHz, 25, conducted	S01_BC08	2021-11-10	Passed	Passed

47 CFR CHAPTER I FCC PART 27

§ 2.1051 § 27.53

Subpart C

Band edge compliance

The measurement was performed according to ANSI C63.26: 2015

Final Result

OP-Mode

Technology, Radio Technology, Operating Frequency, ChBW, Ressource Blocks, Measurement method

	Setup	Date	FCC	IC
E-UTRA, eFDD 12 16QAM, high channel, 1.4 MHz, 6, conducted	S01_AS04	2021-08-26	Passed	Passed
E-UTRA, eFDD 12 16QAM, high channel, 3 MHz, 15, conducted	S01_AS04	2021-08-26	Passed	Passed
E-UTRA, eFDD 12 16QAM, high channel, 5 MHz, 25, conducted	S01_AS04	2021-08-26	Passed	Passed
E-UTRA, eFDD 12 16QAM, low channel, 1.4 MHz, 6, conducted	S01_AS04	2021-08-26	Passed	Passed
E-UTRA, eFDD 12 16QAM, low channel, 3 MHz, 15, conducted	S01_AS04	2021-08-26	Passed	Passed
E-UTRA, eFDD 12 16QAM, low channel, 5 MHz, 25, conducted	S01_AS04	2021-08-26	Passed	Passed
E-UTRA, eFDD 12 QPSK, high channel, 1.4 MHz, 6, conducted	S01_AS03	2021-11-08	Passed	Passed
E-UTRA, eFDD 12 QPSK, high channel, 10 MHz, 50, conducted	S01_AS03	2021-11-08	Passed	Passed
E-UTRA, eFDD 12 QPSK, high channel, 3 MHz, 15, conducted	S01_AS03	2021-11-08	Passed	Passed
E-UTRA, eFDD 12 QPSK, high channel, 5 MHz, 25, conducted	S01_AS03	2021-11-08	Passed	Passed
E-UTRA, eFDD 12 QPSK, low channel, 1.4 MHz, 6, conducted	S01_AS03	2021-11-08	Passed	Passed
E-UTRA, eFDD 12 QPSK, low channel, 10 MHz, 50, conducted	S01_AS03	2021-11-08	Passed	Passed
E-UTRA, eFDD 12 QPSK, low channel, 3 MHz, 15, conducted	S01_AS03	2021-11-08	Passed	Passed
E-UTRA, eFDD 12 QPSK, low channel, 5 MHz, 25, conducted	S01_AS03	2021-11-08	Passed	Passed
E-UTRA, eFDD 4 16QAM, high channel, 1.4 MHz, 6, conducted	S01_AS04	2021-08-26	Passed	Passed
E-UTRA, eFDD 4 16QAM, high channel, 3 MHz, 15, conducted	S01_AS04	2021-08-26	Passed	Passed
E-UTRA, eFDD 4 16QAM, high channel, 5 MHz, 25, conducted	S01_AS04	2021-08-26	Passed	Passed
E-UTRA, eFDD 4 16QAM, low channel, 1.4 MHz, 6, conducted	S01_AS04	2021-08-26	Passed	Passed
E-UTRA, eFDD 4 16QAM, low channel, 3 MHz, 15, conducted	S01_AS04	2021-08-26	Passed	Passed
E-UTRA, eFDD 4 16QAM, low channel, 5 MHz, 25, conducted	S01_AS04	2021-08-26	Passed	Passed
E-UTRA, eFDD 4 16QAM, high channel, 10 MHz, 12, conducted	S01_AS04	2021-08-26	Passed	Passed
E-UTRA, eFDD 4 16QAM, high channel, 15 MHz, 18, conducted	S01_AS04	2021-08-26	Passed	Passed
E-UTRA, eFDD 4 16QAM, high channel, 20 MHz, 18, conducted	S01_AS04	2021-08-26	Passed	Passed
E-UTRA, eFDD 4 16QAM, low channel, 10 MHz, 12, conducted	S01_AS04	2021-08-26	Passed	Passed
E-UTRA, eFDD 4 16QAM, low channel, 15 MHz, 18, conducted	S01_AS04	2021-08-26	Passed	Passed
E-UTRA, eFDD 4 16QAM, low channel, 20 MHz, 18, conducted	S01_AS04	2021-08-26	Passed	Passed
E-UTRA, eFDD 4 QPSK, high channel, 1.4 MHz, 6, conducted	S01_AS03	2021-11-08	Passed	Passed
E-UTRA, eFDD 4 QPSK, high channel, 10 MHz, 50, conducted	S01_AS03	2021-11-08	Passed	Passed
E-UTRA, eFDD 4 QPSK, high channel, 15 MHz, 75, conducted	S01_AS03	2021-11-08	Passed	Passed
E-UTRA, eFDD 4 QPSK, high channel, 20 MHz, 100, conducted	S01_AS03	2021-11-08	Passed	Passed
E-UTRA, eFDD 4 QPSK, high channel, 3 MHz, 15, conducted	S01_AS03	2021-11-08	Passed	Passed
E-UTRA, eFDD 4 QPSK, high channel, 5 MHz, 25, conducted	S01_AS03	2021-11-08	Passed	Passed
E-UTRA, eFDD 4 QPSK, low channel, 1.4 MHz, 6, conducted	S01_AS03	2021-11-08	Passed	Passed

47 CFR CHAPTER I FCC PART 27

§ 2.1051 § 27.53

Subpart C

Band edge compliance

The measurement was performed according to ANSI C63.26: 2015

Final Result

OP-Mode	Setup	Date	FCC	IC
Technology, Radio Technology, Operating Frequency, ChBW, Ressource Blocks, Measurement method				
E-UTRA, eFDD 4 QPSK, low channel, 10 MHz, 50, conducted	S01_AS03	2021-11-08	Passed	Passed
E-UTRA, eFDD 4 QPSK, low channel, 15 MHz, 75, conducted	S01_AS03	2021-11-08	Passed	Passed
E-UTRA, eFDD 4 QPSK, low channel, 20 MHz, 100, conducted	S01_AS03	2021-11-08	Passed	Passed
E-UTRA, eFDD 4 QPSK, low channel, 3 MHz, 15, conducted	S01_AS03	2021-11-08	Passed	Passed
E-UTRA, eFDD 4 QPSK, low channel, 5 MHz, 25, conducted	S01_AS03	2021-11-08	Passed	Passed
E-UTRA, eFDD 7 16QAM, high channel, 5 MHz, 25, conducted	S01_BC08	2021-11-12	Passed	Passed
E-UTRA, eFDD 7 16QAM, low channel, 5 MHz, 25, conducted	S01_BC08	2021-11-12	Passed	Passed
E-UTRA, eFDD 7 16QAM, high channel, 10 MHz, 12, conducted	S01_BC08	2021-11-12	Passed	Passed
E-UTRA, eFDD 7 16QAM, high channel, 15 MHz, 18, conducted	S01_BC08	2021-11-12	Passed	Passed
E-UTRA, eFDD 7 16QAM, high channel, 20 MHz, 18, conducted	S01_BC08	2021-11-12	Passed	Passed
E-UTRA, eFDD 7 16QAM, low channel, 10 MHz, 12, conducted	S01_BC08	2021-11-12	Passed	Passed
E-UTRA, eFDD 7 16QAM, low channel, 15 MHz, 18, conducted	S01_BC08	2021-11-12	Passed	Passed
E-UTRA, eFDD 7 16QAM, low channel, 20 MHz, 18, conducted	S01_BC08	2021-11-12	Passed	Passed
E-UTRA, eFDD 7 QPSK, high channel, 10 MHz, 50, conducted	S01_BC08	2021-11-12	Passed	Passed
E-UTRA, eFDD 7 QPSK, high channel, 15 MHz, 75, conducted	S01_BC08	2021-11-12	Passed	Passed
E-UTRA, eFDD 7 QPSK, high channel, 20 MHz, 100, conducted	S01_BC08	2021-11-12	Passed	Passed
E-UTRA, eFDD 7 QPSK, high channel, 5 MHz, 25, conducted	S01_BC08	2021-11-12	Passed	Passed
E-UTRA, eFDD 7 QPSK, low channel, 10 MHz, 50, conducted	S01_BC08	2021-11-12	Passed	Passed
E-UTRA, eFDD 7 QPSK, low channel, 15 MHz, 75, conducted	S01_BC08	2021-11-12	Passed	Passed
E-UTRA, eFDD 7 QPSK, low channel, 20 MHz, 100, conducted	S01_BC08	2021-11-12	Passed	Passed
E-UTRA, eFDD 7 QPSK, low channel, 5 MHz, 25, conducted	S01_BC08	2021-11-12	Passed	Passed
E-UTRA, eTFDD 38 16QAM, high channel, 5 MHz, 25, conducted	S01_BC08	2021-11-10	Passed	Passed
E-UTRA, eTFDD 38 16QAM, low channel, 5 MHz, 25, conducted	S01_BC08	2021-11-10	Passed	Passed
E-UTRA, eTFDD 38 16QAM, high channel, 10 MHz, 12, conducted	S01_BC08	2021-11-10	Passed	Passed
E-UTRA, eTFDD 38 16QAM, high channel, 15 MHz, 18, conducted	S01_BC08	2021-11-10	Passed	Passed
E-UTRA, eTFDD 38 16QAM, high channel, 20 MHz, 18, conducted	S01_BC08	2021-11-10	Passed	Passed
E-UTRA, eTFDD 38 16QAM, low channel, 10 MHz, 12, conducted	S01_BC08	2021-11-10	Passed	Passed
E-UTRA, eTFDD 38 16QAM, low channel, 15 MHz, 18, conducted	S01_BC08	2021-11-10	Passed	Passed
E-UTRA, eTFDD 38 16QAM, low channel, 20 MHz, 18, conducted	S01_BC08	2021-11-10	Passed	Passed
E-UTRA, eTFDD 38 QPSK, high channel, 10 MHz, 50, conducted	S01_BC08	2021-11-10	Passed	Passed
E-UTRA, eTFDD 38 QPSK, high channel, 15 MHz, 75, conducted	S01_BC08	2021-11-10	Passed	Passed
E-UTRA, eTFDD 38 QPSK, high channel, 20 MHz, 100, conducted	S01_BC08	2021-11-10	Passed	Passed
E-UTRA, eTFDD 38 QPSK, high channel, 5 MHz, 25, conducted	S01_BC08	2021-11-10	Passed	Passed
E-UTRA, eTFDD 38 QPSK, low channel, 10 MHz, 50, conducted	S01_BC08	2021-11-10	Passed	Passed
E-UTRA, eTFDD 38 QPSK, low channel, 15 MHz, 75, conducted	S01_BC08	2021-11-10	Passed	Passed
E-UTRA, eTFDD 38 QPSK, low channel, 20 MHz, 100, conducted	S01_BC08	2021-11-10	Passed	Passed
E-UTRA, eTFDD 38 QPSK, low channel, 5 MHz, 25, conducted	S01_BC08	2021-11-10	Passed	Passed
E-UTRA, eTFDD 41 16QAM, high channel, 5 MHz, 25, conducted	S01_BC08	2021-11-10	Passed	Passed
E-UTRA, eTFDD 41 16QAM, low channel, 5 MHz, 25, conducted	S01_BC08	2021-11-10	Passed	Passed
E-UTRA, eTFDD 41 16QAM, high channel, 10 MHz, 12, conducted	S01_BC08	2021-11-10	Passed	Passed
E-UTRA, eTFDD 41 16QAM, high channel, 15 MHz, 18, conducted	S01_BC08	2021-11-10	Passed	Passed
E-UTRA, eTFDD 41 16QAM, high channel, 20 MHz, 18, conducted	S01_BC08	2021-11-10	Passed	Passed
E-UTRA, eTFDD 41 16QAM, low channel, 10 MHz, 12, conducted	S01_BC08	2021-11-10	Passed	Passed
E-UTRA, eTFDD 41 16QAM, low channel, 15 MHz, 18, conducted	S01_BC08	2021-11-10	Passed	Passed
E-UTRA, eTFDD 41 16QAM, low channel, 20 MHz, 18, conducted	S01_BC08	2021-11-10	Passed	Passed

47 CFR CHAPTER I FCC PART 27

§ 2.1051 § 27.53

Subpart C

Band edge compliance

The measurement was performed according to ANSI C63.26: 2015

Final Result

OP-Mode	Setup	Date	FCC	IC
Technology, Radio Technology, Operating Frequency, ChBW, Ressource Blocks, Measurement method				
E-UTRA, eTFDD 41 QPSK, high channel, 10 MHz, 50, conducted	S01_BC08	2021-11-10	Passed	Passed
E-UTRA, eTFDD 41 QPSK, high channel, 15 MHz, 75, conducted	S01_BC08	2021-11-10	Passed	Passed
E-UTRA, eTFDD 41 QPSK, high channel, 20 MHz, 100, conducted	S01_BC08	2021-11-10	Passed	Passed
E-UTRA, eTFDD 41 QPSK, high channel, 5 MHz, 25, conducted	S01_BC08	2021-11-10	Passed	Passed
E-UTRA, eTFDD 41 QPSK, low channel, 10 MHz, 50, conducted	S01_BC08	2021-11-10	Passed	Passed
E-UTRA, eTFDD 41 QPSK, low channel, 15 MHz, 75, conducted	S01_BC08	2021-11-10	Passed	Passed
E-UTRA, eTFDD 41 QPSK, low channel, 20 MHz, 100, conducted	S01_BC08	2021-11-10	Passed	Passed
E-UTRA, eTFDD 41 QPSK, low channel, 5 MHz, 25, conducted	S01_BC08	2021-11-10	Passed	Passed

47 CFR CHAPTER I FCC PART 27

§ 27.50

Subpart C

Peak to Average Ratio

The measurement was performed according to ANSI C63.26: 2015

Final Result

OP-Mode	Setup	Date	FCC	IC
Technology, Radio Technology, Operating Frequency, ChBW, Ressource Blocks, Measurement method				
E-UTRA, eFDD 12 16QAM, high channel, 1.4 MHz, 6, conducted	S01_AS04	2021-09-23	Passed	Passed
E-UTRA, eFDD 12 16QAM, low channel, 1.4 MHz, 6, conducted	S01_AS04	2021-09-23	Passed	Passed
E-UTRA, eFDD 12 16QAM, mid channel, 1.4 MHz, 6, conducted	S01_AS04	2021-09-23	Passed	Passed
E-UTRA, eFDD 12 QPSK, high channel, 1.4 MHz, 6, conducted	S01_AS04	2021-09-23	Passed	Passed
E-UTRA, eFDD 12 QPSK, low channel, 1.4 MHz, 6, conducted	S01_AS04	2021-09-23	Passed	Passed
E-UTRA, eFDD 12 QPSK, mid channel, 1.4 MHz, 6, conducted	S01_AS04	2021-09-23	Passed	Passed
E-UTRA, eFDD 13 16QAM, high channel, 5 MHz, 25, conducted	S01_AS04	2021-09-23	Passed	Passed
E-UTRA, eFDD 13 16QAM, low channel, 5 MHz, 25, conducted	S01_AS04	2021-09-23	Passed	Passed
E-UTRA, eFDD 13 16QAM, mid channel, 5 MHz, 25, conducted	S01_AS04	2021-09-23	Passed	Passed
E-UTRA, eFDD 13 QPSK, high channel, 5 MHz, 25, conducted	S01_AS04	2021-09-23	Passed	Passed
E-UTRA, eFDD 13 QPSK, low channel, 5 MHz, 25, conducted	S01_AS04	2021-09-23	Passed	Passed
E-UTRA, eFDD 13 QPSK, mid channel, 5 MHz, 25, conducted	S01_AS04	2021-09-23	Passed	Passed
E-UTRA, eFDD 4 16QAM, high channel, 1.4 MHz, 6, conducted	S01_AS04	2021-08-26	Passed	Passed
E-UTRA, eFDD 4 16QAM, low channel, 1.4 MHz, 6, conducted	S01_AS04	2021-08-26	Passed	Passed
E-UTRA, eFDD 4 16QAM, mid channel, 1.4 MHz, 6, conducted	S01_AS04	2021-08-26	Passed	Passed
E-UTRA, eFDD 4 QPSK, high channel, 1.4 MHz, 6, conducted	S01_AS04	2021-08-26	Passed	Passed
E-UTRA, eFDD 4 QPSK, low channel, 1.4 MHz, 6, conducted	S01_AS04	2021-08-26	Passed	Passed
E-UTRA, eFDD 4 QPSK, mid channel, 1.4 MHz, 6, conducted	S01_AS04	2021-08-26	Passed	Passed
E-UTRA, eFDD 7 16QAM, high channel, 5 MHz, 25, conducted	S01_BC08	2021-11-12	Passed	Passed
E-UTRA, eFDD 7 16QAM, low channel, 5 MHz, 25, conducted	S01_BC08	2021-11-12	Passed	Passed
E-UTRA, eFDD 7 16QAM, mid channel, 5 MHz, 25, conducted	S01_BC08	2021-11-12	Passed	Passed
E-UTRA, eFDD 7 QPSK, high channel, 5 MHz, 25, conducted	S01_BC08	2021-11-12	Passed	Passed
E-UTRA, eFDD 7 QPSK, low channel, 5 MHz, 25, conducted	S01_BC08	2021-11-12	Passed	Passed
E-UTRA, eFDD 7 QPSK, mid channel, 5 MHz, 25, conducted	S01_BC08	2021-11-12	Passed	Passed
E-UTRA, eTDD 38 16QAM, high channel, 5 MHz, 25, conducted	S01_BC08	2021-11-12	Passed	Passed
E-UTRA, eTDD 38 16QAM, low channel, 5 MHz, 25, conducted	S01_BC08	2021-11-12	Passed	Passed
E-UTRA, eTDD 38 16QAM, mid channel, 5 MHz, 25, conducted	S01_BC08	2021-11-12	Passed	Passed
E-UTRA, eTDD 38 QPSK, high channel, 5 MHz, 25, conducted	S01_BC08	2021-11-12	Passed	Passed

47 CFR CHAPTER I FCC PART 27 § 27.50

Subpart C

Peak to Average Ratio

The measurement was performed according to ANSI C63.26: 2015

Final Result

OP-Mode Technology, Radio Technology, Operating Frequency, ChBW, Ressource Blocks, Measurement method	Setup	Date	FCC	IC
E-UTRA, eTDD 38 QPSK, low channel, 5 MHz, 25, conducted	S01_BC08	2021-11-12	Passed	Passed
E-UTRA, eTDD 38 QPSK, mid channel, 5 MHz, 25, conducted	S01_BC08	2021-11-12	Passed	Passed
E-UTRA, eTDD 41 16QAM, high channel, 5 MHz, 25, conducted	S01_BC08	2021-11-12	Passed	Passed
E-UTRA, eTDD 41 16QAM, low channel, 5 MHz, 25, conducted	S01_BC08	2021-11-12	Passed	Passed
E-UTRA, eTDD 41 16QAM, mid channel, 5 MHz, 25, conducted	S01_BC08	2021-11-12	Passed	Passed
E-UTRA, eTDD 41 QPSK, high channel, 5 MHz, 25, conducted	S01_BC08	2021-11-12	Passed	Passed
E-UTRA, eTDD 41 QPSK, low channel, 5 MHz, 25, conducted	S01_BC08	2021-11-12	Passed	Passed
E-UTRA, eTDD 41 QPSK, mid channel, 5 MHz, 25, conducted	S01_BC08	2021-11-12	Passed	Passed

47 CFR CHAPTER I FCC PART 27 § 2.1046 § 27.1507

Subpart P

RF Output Power

The measurement was performed according to ANSI C63.26: 2015

Final Result

OP-Mode Technology, Radio Technology, Operating Frequency, ChBW, Ressource Blocks, Measurement method	Setup	Date	FCC	IC
E-UTRA, eFDD 8 16QAM, high channel, 1.4 MHz, 1, conducted	S01_AS04	2021-09-20	Passed	N/A
E-UTRA, eFDD 8 16QAM, high channel, 1.4 MHz, 6, conducted	S01_AS04	2021-09-20	Passed	N/A
E-UTRA, eFDD 8 16QAM, low channel, 1.4 MHz, 1, conducted	S01_AS04	2021-09-20	Passed	N/A
E-UTRA, eFDD 8 16QAM, low channel, 1.4 MHz, 6, conducted	S01_AS04	2021-09-20	Passed	N/A
E-UTRA, eFDD 8 16QAM, mid channel, 1.4 MHz, 1, conducted	S01_AS04	2021-09-20	Passed	N/A
E-UTRA, eFDD 8 16QAM, mid channel, 1.4 MHz, 6, conducted	S01_AS04	2021-09-20	Passed	N/A
E-UTRA, eFDD 8 16QAM, mid channel, 3 MHz, 1, conducted	S01_AS04	2021-09-20	Passed	N/A
E-UTRA, eFDD 8 16QAM, mid channel, 3 MHz, 15, conducted	S01_AS04	2021-09-20	Passed	N/A
E-UTRA, eFDD 8 QPSK, high channel, 1.4 MHz, 1, conducted	S01_AS04	2021-09-20	Passed	N/A
E-UTRA, eFDD 8 QPSK, high channel, 1.4 MHz, 3, conducted	S01_AS04	2021-09-20	Passed	N/A
E-UTRA, eFDD 8 QPSK, high channel, 1.4 MHz, 6, conducted	S01_AS04	2021-09-20	Passed	N/A
E-UTRA, eFDD 8 QPSK, low channel, 1.4 MHz, 1, conducted	S01_AY04	2021-09-27	Passed	N/A
E-UTRA, eFDD 8 QPSK, low channel, 1.4 MHz, 3, conducted	S01_AS04	2021-09-20	Passed	N/A
E-UTRA, eFDD 8 QPSK, low channel, 1.4 MHz, 6, conducted	S01_AS04	2021-09-20	Passed	N/A
E-UTRA, eFDD 8 QPSK, mid channel, 1.4 MHz, 1, conducted	S01_AS04	2021-09-20	Passed	N/A
E-UTRA, eFDD 8 QPSK, mid channel, 1.4 MHz, 3, conducted	S01_AS04	2021-09-20	Passed	N/A
E-UTRA, eFDD 8 QPSK, mid channel, 1.4 MHz, 6, conducted	S01_AS04	2021-09-20	Passed	N/A
E-UTRA, eFDD 8 QPSK, mid channel, 3 MHz, 1, conducted	S01_AS04	2021-09-20	Passed	N/A
E-UTRA, eFDD 8 QPSK, mid channel, 3 MHz, 15, conducted	S01_AS04	2021-09-20	Passed	N/A

47 CFR CHAPTER I FCC PART 27 § 2.1055 § 27.54

Subpart P

Frequency stability

The measurement was performed according to ANSI C63.26: 2015

Final Result

OP-Mode	Setup	Date	FCC	IC
Technology, Radio Technology, Operating Frequency, ChBW, Ressource Blocks, Measurement method				
E-UTRA, eFDD 8 QPSK, mid channel, 5 MHz, 1, conducted	S01_AS04	2021-10-21	Passed	N/A

47 CFR CHAPTER I FCC PART 27 § 2.1051 § 27.1509

Subpart P

Spurious emissions at antenna terminals

The measurement was performed according to ANSI C63.26: 2015

Final Result

OP-Mode	Setup	Date	FCC	IC
Technology, Radio Technology, Operating Frequency, ChBW, Ressource Blocks, Measurement method				
E-UTRA, eFDD 8 QPSK, high channel, 5 MHz, 1, conducted	S01_AS04	2021-09-17	Passed	N/A
E-UTRA, eFDD 8 QPSK, low channel, 5 MHz, 1, conducted	S01_AS04	2021-09-17	Passed	N/A
E-UTRA, eFDD 8 QPSK, mid channel, 5 MHz, 1, conducted	S01_AS04	2021-09-17	Passed	N/A

47 CFR CHAPTER I FCC PART 27 § 2.1053 § 27.1509

Subpart P

Field strength of spurious radiation

The measurement was performed according to ANSI C63.26: 2015

Final Result

OP-Mode	Setup	Date	FCC	IC
Technology, Radio Technology, Operating Frequency, ChBW, Ressource Blocks, Measurement method				
E-UTRA, eFDD 8 QPSK, high channel, 5 MHz, 1, radiated	S01_AS04	2021-09-29	Passed	N/A
E-UTRA, eFDD 8 QPSK, low channel, 5 MHz, 1, radiated	S01_AS04	2021-09-29	Passed	N/A
E-UTRA, eFDD 8 QPSK, mid channel, 5 MHz, 1, radiated	S01_AS04	2021-09-29	Passed	N/A

47 CFR CHAPTER I FCC PART 27 § 2.1049

Subpart P

Emission and occupied bandwidth

The measurement was performed according to ANSI C63.26: 2015

Final Result

OP-Mode	Setup	Date	FCC	IC
Technology, Radio Technology, Operating Frequency, ChBW, Ressource Blocks, Measurement method				
E-UTRA, eFDD 8 16QAM, high channel, 1.4 MHz, 6, conducted	S01_AS04	2021-09-23	Passed	N/A
E-UTRA, eFDD 8 16QAM, low channel, 1.4 MHz, 6, conducted	S01_AS04	2021-09-23	Passed	N/A
E-UTRA, eFDD 8 16QAM, mid channel, 1.4 MHz, 6, conducted	S01_AS04	2021-09-23	Passed	N/A
E-UTRA, eFDD 8 16QAM, mid channel, 3 MHz, 15, conducted	S01_AS04	2021-09-23	Passed	N/A
E-UTRA, eFDD 8 QPSK, high channel, 1.4 MHz, 6, conducted	S01_AS04	2021-09-23	Passed	N/A
E-UTRA, eFDD 8 QPSK, low channel, 1.4 MHz, 6, conducted	S01_AS04	2021-09-23	Passed	N/A
E-UTRA, eFDD 8 QPSK, mid channel, 1.4 MHz, 6, conducted	S01_AS04	2021-09-23	Passed	N/A
E-UTRA, eFDD 8 QPSK, mid channel, 3 MHz, 15, conducted	S01_AS04	2021-09-23	Passed	N/A

47 CFR CHAPTER I FCC PART 27

§ 2.1051 § 27.1509

Subpart P

Band edge compliance

The measurement was performed according to ANSI C63.26: 2015

Final Result

OP-Mode	Setup	Date	FCC	IC
Technology, Radio Technology, Operating Frequency, ChBW, Ressource Blocks, Measurement method				
E-UTRA, eFDD 8 16QAM, high channel, 1.4 MHz, 6, conducted	S01_AS04	2021-09-23	Passed	N/A
E-UTRA, eFDD 8 16QAM, high channel, 3 MHz, 15, conducted	S01_AS04	2021-09-23	Passed	N/A
E-UTRA, eFDD 8 16QAM, low channel, 1.4 MHz, 6, conducted	S01_AS04	2021-09-23	Passed	N/A
E-UTRA, eFDD 8 16QAM, low channel, 3 MHz, 15, conducted	S01_AS04	2021-09-23	Passed	N/A
E-UTRA, eFDD 8 QPSK, high channel, 1.4 MHz, 6, conducted	S01_AS04	2021-09-23	Passed	N/A
E-UTRA, eFDD 8 QPSK, high channel, 3 MHz, 15, conducted	S01_AS04	2021-09-23	Passed	N/A
E-UTRA, eFDD 8 QPSK, low channel, 1.4 MHz, 6, conducted	S01_AS04	2021-09-23	Passed	N/A
E-UTRA, eFDD 8 QPSK, low channel, 3 MHz, 15, conducted	S01_AS04	2021-09-23	Passed	N/A

47 CFR CHAPTER I FCC PART 27

§ 27.1507

Subpart P

Peak to Average Ratio

The measurement was performed according to ANSI C63.26: 2015

Final Result

OP-Mode	Setup	Date	FCC	IC
Technology, Radio Technology, Operating Frequency, ChBW, Ressource Blocks, Measurement method				
E-UTRA, eFDD 8 16QAM, high channel, 1.4 MHz, 6, conducted	S01_AS04	2021-09-23	Passed	N/A
E-UTRA, eFDD 8 16QAM, low channel, 1.4 MHz, 6, conducted	S01_AS04	2021-09-23	Passed	N/A
E-UTRA, eFDD 8 16QAM, mid channel, 1.4 MHz, 6, conducted	S01_AS04	2021-09-23	Passed	N/A
E-UTRA, eFDD 8 QPSK, high channel, 1.4 MHz, 6, conducted	S01_AS04	2021-09-23	Passed	N/A
E-UTRA, eFDD 8 QPSK, low channel, 1.4 MHz, 6, conducted	S01_AS04	2021-09-23	Passed	N/A
E-UTRA, eFDD 8 QPSK, mid channel, 1.4 MHz, 6, conducted	S01_AS04	2021-09-23	Passed	N/A

47 CFR CHAPTER I FCC PART 90

§ 2.1046 § 90.635

Subpart S

RF Output Power

The measurement was performed according to ANSI C63.26: 2015

Final Result

OP-Mode	Setup	Date	FCC	IC
Technology, Radio Technology, Operating Frequency, ChBW, Ressource Blocks, Measurement method				
E-UTRA, eFDD 26 16QAM, high channel, 1.4 MHz, 1, conducted	S01_AS03	2021-08-14	Passed	Passed
E-UTRA, eFDD 26 16QAM, high channel, 1.4 MHz, 6, conducted	S01_AS03	2021-08-14	Passed	Passed
E-UTRA, eFDD 26 16QAM, high channel, 3 MHz, 1, conducted	S01_AS03	2021-08-14	Passed	Passed
E-UTRA, eFDD 26 16QAM, high channel, 3 MHz, 15, conducted	S01_AS03	2021-08-14	Passed	Passed
E-UTRA, eFDD 26 16QAM, high channel, 5 MHz, 1, conducted	S01_AS03	2021-08-14	Passed	Passed
E-UTRA, eFDD 26 16QAM, high channel, 5 MHz, 25, conducted	S01_AS03	2021-08-14	Passed	Passed
E-UTRA, eFDD 26 16QAM, low channel, 1.4 MHz, 1, conducted	S01_AS03	2021-08-14	Passed	Passed
E-UTRA, eFDD 26 16QAM, low channel, 1.4 MHz, 6, conducted	S01_AS03	2021-08-14	Passed	Passed
E-UTRA, eFDD 26 16QAM, low channel, 3 MHz, 1, conducted	S01_AS03	2021-08-14	Passed	Passed
E-UTRA, eFDD 26 16QAM, low channel, 3 MHz, 15, conducted	S01_AS03	2021-08-14	Passed	Passed
E-UTRA, eFDD 26 16QAM, low channel, 5 MHz, 1, conducted	S01_AS03	2021-08-14	Passed	Passed
E-UTRA, eFDD 26 16QAM, low channel, 5 MHz, 25, conducted	S01_AS03	2021-08-14	Passed	Passed

47 CFR CHAPTER I FCC PART 90

§ 2.1046 § 90.635

Subpart S

RF Output Power

The measurement was performed according to ANSI C63.26: 2015

Final Result

OP-Mode	Setup	Date	FCC	IC
Technology, Radio Technology, Operating Frequency, ChBW, Ressource Blocks, Measurement method				
E-UTRA, eFDD 26 16QAM, mid channel, 1.4 MHz, 1, conducted	S01_AS03	2021-08-14	Passed	Passed
E-UTRA, eFDD 26 16QAM, mid channel, 1.4 MHz, 6, conducted	S01_AS03	2021-08-14	Passed	Passed
E-UTRA, eFDD 26 16QAM, mid channel, 10 MHz, 1, conducted	S01_AS04	2021-08-26	Passed	Passed
E-UTRA, eFDD 26 16QAM, mid channel, 10 MHz, 12, conducted	S01_AS04	2021-08-26	Passed	Passed
E-UTRA, eFDD 26 16QAM, mid channel, 3 MHz, 1, conducted	S01_AS03	2021-08-14	Passed	Passed
E-UTRA, eFDD 26 16QAM, mid channel, 3 MHz, 15, conducted	S01_AS03	2021-08-14	Passed	Passed
E-UTRA, eFDD 26 16QAM, mid channel, 5 MHz, 1, conducted	S01_AS03	2021-08-14	Passed	Passed
E-UTRA, eFDD 26 16QAM, mid channel, 5 MHz, 25, conducted	S01_AS03	2021-08-14	Passed	Passed
E-UTRA, eFDD 26 QPSK, high channel, 1.4 MHz, 1, conducted	S01_AS03	2021-08-14	Passed	Passed
E-UTRA, eFDD 26 QPSK, high channel, 1.4 MHz, 3, conducted	S01_AS03	2021-08-14	Passed	Passed
E-UTRA, eFDD 26 QPSK, high channel, 1.4 MHz, 6, conducted	S01_AS03	2021-08-14	Passed	Passed
E-UTRA, eFDD 26 QPSK, high channel, 3 MHz, 1, conducted	S01_AS03	2021-08-14	Passed	Passed
E-UTRA, eFDD 26 QPSK, high channel, 3 MHz, 15, conducted	S01_AS03	2021-08-14	Passed	Passed
E-UTRA, eFDD 26 QPSK, high channel, 5 MHz, 1, conducted	S01_AR03	2021-10-08	Passed	Passed
E-UTRA, eFDD 26 QPSK, high channel, 5 MHz, 12, conducted	S01_AR03	2021-10-08	Passed	Passed
E-UTRA, eFDD 26 QPSK, high channel, 5 MHz, 25, conducted	S01_AR03	2021-10-08	Passed	Passed
E-UTRA, eFDD 26 QPSK, low channel, 1.4 MHz, 1, conducted	S01_AR03	2021-10-08	Passed	Passed
E-UTRA, eFDD 26 QPSK, low channel, 1.4 MHz, 3, conducted	S01_AR03	2021-10-08	Passed	Passed
E-UTRA, eFDD 26 QPSK, low channel, 1.4 MHz, 6, conducted	S01_AR03	2021-10-08	Passed	Passed
E-UTRA, eFDD 26 QPSK, low channel, 3 MHz, 1, conducted	S01_AR03	2021-10-08	Passed	Passed
E-UTRA, eFDD 26 QPSK, low channel, 3 MHz, 15, conducted	S01_AR03	2021-10-08	Passed	Passed
E-UTRA, eFDD 26 QPSK, low channel, 5 MHz, 1, conducted	S01_AR03	2021-10-08	Passed	Passed
E-UTRA, eFDD 26 QPSK, low channel, 5 MHz, 12, conducted	S01_AR03	2021-10-08	Passed	Passed
E-UTRA, eFDD 26 QPSK, low channel, 5 MHz, 25, conducted	S01_AR03	2021-10-08	Passed	Passed
E-UTRA, eFDD 26 QPSK, mid channel, 1.4 MHz, 1, conducted	S01_AR03	2021-10-08	Passed	Passed
E-UTRA, eFDD 26 QPSK, mid channel, 1.4 MHz, 3, conducted	S01_AR03	2021-10-08	Passed	Passed
E-UTRA, eFDD 26 QPSK, mid channel, 1.4 MHz, 6, conducted	S01_AR03	2021-10-08	Passed	Passed
E-UTRA, eFDD 26 QPSK, mid channel, 10 MHz, 1, conducted	S01_AR03	2021-10-08	Passed	Passed
E-UTRA, eFDD 26 QPSK, mid channel, 10 MHz, 50, conducted	S01_AR03	2021-10-08	Passed	Passed
E-UTRA, eFDD 26 QPSK, mid channel, 3 MHz, 1, conducted	S01_AR03	2021-10-08	Passed	Passed
E-UTRA, eFDD 26 QPSK, mid channel, 3 MHz, 15, conducted	S01_AR03	2021-10-08	Passed	Passed
E-UTRA, eFDD 26 QPSK, mid channel, 5 MHz, 1, conducted	S01_AS03	2021-08-14	Passed	Passed
E-UTRA, eFDD 26 QPSK, mid channel, 5 MHz, 12, conducted	S01_AS03	2021-08-14	Passed	Passed
E-UTRA, eFDD 26 QPSK, mid channel, 5 MHz, 25, conducted	S01_AS03	2021-08-14	Passed	Passed

47 CFR CHAPTER I FCC PART 90

§ 2.1046

Subpart S

Frequency stability

The measurement was performed according to ANSI C63.26: 2015

Final Result

OP-Mode	Setup	Date	FCC	IC
Technology, Radio Technology, Operating Frequency, ChBW, Ressource Blocks, Measurement method				
COMMENT: Frequency Stability in LTE Band 26 was preformed according to FCC Part 22 and not repeated for FCC Part 90	-	-	-	-

47 CFR CHAPTER I FCC PART 90 § 2.1051 § 90.543
Subpart S

Spurious Emissions at antenna terminals

The measurement was performed according to ANSI C63.26: 2015

Final Result

OP-Mode	Setup	Date	FCC	IC
Technology, Radio Technology, Operating Frequency, ChBW, Ressource Blocks, Measurement method				
E-UTRA, eFDD 26 QPSK, high channel, 5 MHz, 1, conducted	S01_AS04	2021-10-21	Passed	Passed
E-UTRA, eFDD 26 QPSK, low channel, 5 MHz, 1, conducted	S01_AS04	2021-10-21	Passed	Passed
E-UTRA, eFDD 26 QPSK, mid channel, 5 MHz, 1, conducted	S01_AS04	2021-10-21	Passed	Passed

47 CFR CHAPTER I FCC PART 90 § 2.1053 § 90.543
Subpart S

Field Strength of Spurious Radiation

The measurement was performed according to ANSI C63.26: 2015

Final Result

OP-Mode	Setup	Date	FCC	IC
Technology, Radio Technology, Operating Frequency, ChBW, Ressource Blocks, Measurement method				
E-UTRA, eFDD 26 QPSK, high channel, 5 MHz, 1, radiated	S01_AR04	2021-08-23	Passed	Passed
E-UTRA, eFDD 26 QPSK, low channel, 5 MHz, 1, radiated	S01_AR04	2021-08-23	Passed	Passed
E-UTRA, eFDD 26 QPSK, mid channel, 5 MHz, 1, radiated	S01_AR04	2021-08-23	Passed	Passed

47 CFR CHAPTER I FCC PART 90 § 2.1049
Subpart S

Emission and Occupied Bandwidth

The measurement was performed according to ANSI C63.26: 2015

Final Result

OP-Mode	Setup	Date	FCC	IC
Technology, Radio Technology, Operating Frequency, ChBW, Ressource Blocks, Measurement method				
E-UTRA, eFDD 26 16QAM, high channel, 1.4 MHz, 6, conducted	S01_AS04	2021-08-26	Passed	Passed
E-UTRA, eFDD 26 16QAM, high channel, 3 MHz, 15, conducted	S01_AS04	2021-08-26	Passed	Passed
E-UTRA, eFDD 26 16QAM, high channel, 5 MHz, 25, conducted	S01_AS04	2021-08-26	Passed	Passed
E-UTRA, eFDD 26 16QAM, low channel, 1.4 MHz, 6, conducted	S01_AS04	2021-08-26	Passed	Passed
E-UTRA, eFDD 26 16QAM, low channel, 3 MHz, 15, conducted	S01_AS04	2021-08-26	Passed	Passed
E-UTRA, eFDD 26 16QAM, low channel, 5 MHz, 25, conducted	S01_AS04	2021-08-26	Passed	Passed
E-UTRA, eFDD 26 16QAM, mid channel, 1.4 MHz, 6, conducted	S01_AS04	2021-08-26	Passed	Passed
E-UTRA, eFDD 26 16QAM, mid channel, 3 MHz, 15, conducted	S01_AS04	2021-08-26	Passed	Passed
E-UTRA, eFDD 26 16QAM, mid channel, 5 MHz, 25, conducted	S01_AS04	2021-08-26	Passed	Passed
E-UTRA, eFDD 26 QPSK, high channel, 1.4 MHz, 6, conducted	S01_AR03	2021-10-08	Passed	Passed
E-UTRA, eFDD 26 QPSK, high channel, 3 MHz, 15, conducted	S01_AR03	2021-10-08	Passed	Passed
E-UTRA, eFDD 26 QPSK, high channel, 5 MHz, 25, conducted	S01_AR03	2021-10-08	Passed	Passed
E-UTRA, eFDD 26 QPSK, low channel, 1.4 MHz, 6, conducted	S01_AR03	2021-10-08	Passed	Passed
E-UTRA, eFDD 26 QPSK, low channel, 3 MHz, 15, conducted	S01_AR03	2021-10-08	Passed	Passed
E-UTRA, eFDD 26 QPSK, low channel, 5 MHz, 25, conducted	S01_AR03	2021-10-08	Passed	Passed
E-UTRA, eFDD 26 QPSK, mid channel, 1.4 MHz, 6, conducted	S01_AR03	2021-10-08	Passed	Passed
E-UTRA, eFDD 26 QPSK, mid channel, 10 MHz, 50, conducted	S01_AR03	2021-10-08	Passed	Passed
E-UTRA, eFDD 26 QPSK, mid channel, 3 MHz, 15, conducted	S01_AR03	2021-10-08	Passed	Passed
E-UTRA, eFDD 26 QPSK, mid channel, 5 MHz, 25, conducted	S01_AR03	2021-10-08	Passed	Passed

47 CFR CHAPTER I FCC PART 90

§ 2.1051 § 90.543

Subpart S

Band Edge

The measurement was performed according to ANSI C63.26: 2015

Final Result

OP-Mode	Setup	Date	FCC	IC
Technology, Radio Technology, Operating Frequency, ChBW, Ressource Blocks, Measurement method				
E-UTRA, eFDD 26 QPSK, high channel, 1.4 MHz, 6, conducted	S01_AS03	2021-08-13	Passed	Passed
E-UTRA, eFDD 26 QPSK, high channel, 10 MHz, 50, conducted	S01_AS03	2021-08-13	Passed	Passed
E-UTRA, eFDD 26 QPSK, high channel, 3 MHz, 15, conducted	S01_AS03	2021-08-13	Passed	Passed
E-UTRA, eFDD 26 QPSK, high channel, 5 MHz, 25, conducted	S01_AS03	2021-08-13	Passed	Passed
E-UTRA, eFDD 26 QPSK, low channel, 1.4 MHz, 6, conducted	S01_AS03	2021-08-13	Passed	Passed
E-UTRA, eFDD 26 QPSK, low channel, 10 MHz, 50, conducted	S01_AS03	2021-08-13	Passed	Passed
E-UTRA, eFDD 26 QPSK, low channel, 3 MHz, 15, conducted	S01_AS03	2021-08-13	Passed	Passed
E-UTRA, eFDD 26 QPSK, low channel, 5 MHz, 25, conducted	S01_AS03	2021-08-13	Passed	Passed

47 CFR CHAPTER I FCC PART 90

§ 90.635

Subpart S

Peak to Average Ratio

The measurement was performed according to ANSI C63.26: 2015

Final Result

OP-Mode	Setup	Date	FCC	IC
Technology, Radio Technology, Operating Frequency, ChBW, Ressource Blocks, Measurement method				
E-UTRA, eFDD 26 16QAM, high channel, 5 MHz, 25, conducted	S01_AY04	2021-09-27	Passed	Passed
E-UTRA, eFDD 26 16QAM, low channel, 5 MHz, 25, conducted	S01_AY04	2021-09-27	Passed	Passed
E-UTRA, eFDD 26 16QAM, mid channel, 5 MHz, 25, conducted	S01_AY04	2021-09-27	Passed	Passed
E-UTRA, eFDD 26 QPSK, high channel, 5 MHz, 25, conducted	S01_AY04	2021-09-27	Passed	Passed
E-UTRA, eFDD 26 QPSK, low channel, 5 MHz, 25, conducted	S01_AY04	2021-09-27	Passed	Passed
E-UTRA, eFDD 26 QPSK, mid channel, 5 MHz, 25, conducted	S01_AY04	2021-09-27	Passed	Passed

N/A: Not applicable

N/P: Not performed

2 REVISION HISTORY / SIGNATURES

Report version control			
Version	Release date	Change Description	Version validity
initial	2021-12-10	--	valid
--	--	--	--

COMMENT: -



(responsible for accreditation scope)
Dipl.-Ing. Marco Kullik

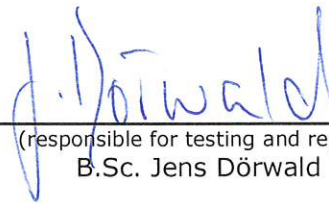

(responsible for testing and report)
B.Sc. Jens Dörwald



7 layers GmbH, Borsigstr. 11
40880 Ratingen, Germany
Phone +49 (0)2102 749 0

3 ADMINISTRATIVE DATA

3.1 TESTING LABORATORY

Company Name: 7layers GmbH
Address: Borsigstr. 11
40880 Ratingen
Germany

The test facility is accredited by the following accreditation organisation:

Laboratory accreditation no: DAKKS D-PL-12140-01-01| -02 | -03
FCC Designation Number: DE0015
FCC Test Firm Registration: 929146
ISED CAB Identifier: DE0007; ISED#: 3699A
Responsible for accreditation scope: Dipl.-Ing. Marco Kullik
Report Template Version: 2021-09-09

3.2 PROJECT DATA

Responsible for testing and report: B.Sc. Jens Dörwald
Employees who performed the tests: documented internally at 7Layers
Date of Report: 2021-12-10
Testing Period: 2021-07-05 to 2021-11-16

3.3 APPLICANT DATA

Company Name: u-blox AG
Address: Zürcherstrasse 68
8800 Thalwil
Switzerland
Contact Person: Mr. Giulio Comar

3.4 MANUFACTURER DATA

Company Name: please see Applicant Data
Address:

Contact Person:

4 TEST OBJECT DATA

4.1 GENERAL EUT DESCRIPTION

Kind of Device product description	2G / 3G / LTE module
Product name	LARA-R6001 / LARA-R6001D
Type	-
Declared EUT data by the supplier	
Power Supply Type	DC
General product description	The EUT is a 2G / 3G / LTE module. It supports the relevant bands for FCC Approval GSM / EGDE: 850 / 1900 WCDMA: FDD2 / FDD5 LTE: eFDD2 / eFDD4 / eFDD5 / eFDD7 / eFDD8 / eFDD12 / eFDD13 / eFDD26 / eTDD38 / eTDD41
Nominal Voltage / Frequency	3.8 V DC

4.2 EUT MAIN COMPONENTS

Sample Name	Sample Code	Description
EUT A	DE1015143ab01	RF sample
Sample Parameter	Value	
Serial No.	358110420000056	
HW Version	UBX-379C00	
SW Version	00.02, A00.00	
Comment	-	

Sample Name	Sample Code	Description
EUT B	DE1015143ab04	RF sample
Sample Parameter	Value	
Serial No.	358110420000056	
HW Version	UBX-379C00	
SW Version	00.04, A00.01	
Comment	-	

Sample Name	Sample Code	Description
EUT C	DE1015143ar03	RF sample
Sample Parameter	Value	
Serial No.	358110420000536	
HW Version	UBX-379C00	
SW Version	00.03, A00.01	
Comment	-	

Sample Name	Sample Code	Description
EUT D	DE1015143ar04	RF sample
Sample Parameter	Value	
Serial No.	358110420000536	
HW Version	UBX-379C00	
SW Version	00.04, A00.01	
Comment	-	

Sample Name	Sample Code	Description
EUT E	DE1015143as03	RF sample
Sample Parameter	Value	
Serial No.	358110420000791	
HW Version	UBX-379C00	
SW Version	00.03, A00.01	
Comment	-	

Sample Name	Sample Code	Description
EUT F	DE1015143as04	RF sample
Sample Parameter	Value	
Serial No.	358110420000791	
HW Version	UBX-379C00	
SW Version	00.04, A00.01	
Comment	-	

Sample Name	Sample Code	Description
EUT G	DE1015143ay04	RF sample
Sample Parameter	Value	
Serial No.	358110420000106	
HW Version	UBX-379C00	
SW Version	00.04, A00.01	
Comment	-	

Sample Name	Sample Code	Description
EUT H	DE1015151bc08	RF sample
Sample Parameter	Value	
Serial No.	353500720000837	
HW Version	UBX-379C01	
SW Version	00.08, A00.01	
Comment	-	

NOTE: The short description is used to simplify the identification of the EUT in this test report.

4.3 ANCILLARY EQUIPMENT

For the purposes of this test report, ancillary equipment is defined as equipment which is used in conjunction with the EUT to provide operational and control features to the EUT. It is necessary to configure the system in a typical fashion, as a customer would normally use it. But nevertheless Ancillary Equipment can influence the test results.

Device	Details (Manufacturer, Type Model, OUT Code)	Description
Evaluation board	U-Blox, EVB-WL3, -	-

4.4 AUXILIARY EQUIPMENT

For the purposes of this test report, auxiliary equipment is defined as equipment which is used temporarily to enable operational and control features especially used for the tests of the EUT which is not used during normal operation or equipment that is used during the tests in combination with the EUT but is not subject of this test report. It is necessary to configure the system in a typical fashion, as a customer would normally use it. But nevertheless Auxiliary Equipment can influence the test results.

Device	Details (Manufacturer, Type Model, HW, SW, S/N)	Description
-	-	-

4.5 EUT SETUPS

This chapter describes the combination of EUTs and equipment used for testing. The rationale for selecting the EUTs, ancillary and auxiliary equipment and interconnecting cables, is to test a representative configuration meeting the requirements of the referenced standards.

Setup	Combination of EUTs	Description and Rationale
S01_AR04	EUT D	radiated & conducted sample
S01_AR03	EUT C	radiated & conducted sample
S01_AB01	EUT A	radiated & conducted sample
S01_AS03	EUT E	radiated & conducted sample
S01_AB04	EUT B	radiated & conducted sample
S01_AY04	EUT G	radiated & conducted sample
S01_AS04	EUT F	radiated & conducted sample
S01_BC08	EUT H	radiated & conducted sample

4.6 OPERATING MODES / TEST CHANNELS

This chapter describes the operating modes of the EUTs used for testing.

GSM / EDGE 850		LOW	MID	HIGH
	Cell BW [MHz]	0.2	0.2	0.2
	CH no.	128	190	251
	f [MHz]	824.2	836.6	848.8

GSM / EDGE 1900		LOW	MID	HIGH
	Cell BW [MHz]	0.2	0.2	0.2
	CH no.	512	661	810
	f [MHz]	1850.2	1880.0	1909.8

UMTS / HSDPA / HSUPA FDD V		LOW	MID	HIGH
	Cell BW [MHz]	5	5	5
	CH no.	4132	4183	4233
	f [MHz]	826.4	836.6	846.6

UMTS / HSDPA / HSUPA FDD II		LOW	MID	HIGH
	Cell BW [MHz]	5	5	5
	CH no.	9262	9400	9538
	f [MHz]	1852.4	1880.0	1907.6

LTE eFDD 2		LOW	MID	HIGH	LOW	MID	HIGH	LOW	MID	HIGH
	Cell BW [MHz]	1.4	1.4	1.4	3	3	3	5	5	5
	CH no.	18607	18900	19193	18615	18900	19185	18625	18900	19175
	f [MHz]	1850.7	1880.0	1909.3	1851.5	1880.0	1908.5	1852.5	1880.0	1907.5
		LOW	MID	HIGH	LOW	MID	HIGH	LOW	MID	HIGH
	Cell BW [MHz]	10	10	10	15	15	15	20	20	20
	CH no.	18650	18900	19150	18675	18900	19125	18700	18900	19100
	f [MHz]	1855.0	1880.0	1905.0	1857.5	1880.0	1902.5	1860.0	1880.0	1900.0

LTE eFDD 4		LOW	MID	HIGH	LOW	MID	HIGH	LOW	MID	HIGH
	Cell BW [MHz]	1.4	1.4	1.4	3	3	3	5	5	5
	CH no.	19957	20175	20393	19965	20175	20385	19975	20175	20375
	f [MHz]	1710.7	1732.5	1754.3	1711.5	1732.5	1753.5	1712.5	1732.5	1752.5
		LOW	MID	HIGH	LOW	MID	HIGH	LOW	MID	HIGH
	Cell BW [MHz]	10	10	10	15	15	15	20	20	20
	CH no.	20000	20175	20350	20025	20175	20325	20050	20175	20300
	f [MHz]	1715.0	1732.5	1750.0	1717.5	1732.5	1747.5	1720.0	1732.5	1745.0

LTE eFDD 5		LOW	MID	HIGH	LOW	MID	HIGH	LOW	MID	HIGH
	Cell BW [MHz]	1.4	1.4	1.4	3	3	3	5	5	5
	CH no.	20407	20525	20643	20415	20525	20635	20425	20525	20625
	f [MHz]	824.7	836.5	848.3	825.5	836.5	847.5	826.5	836.5	846.5
		LOW	MID	HIGH	LOW	MID	HIGH	LOW	MID	HIGH
	Cell BW [MHz]	10	10	10	-	-	-	-	-	-
	CH no.	20450	20525	20600	-	-	-	-	-	-
	f [MHz]	829.0	836.5	844.0	-	-	-	-	-	-

LTE eFDD 7		LOW	MID	HIGH	LOW	MID	HIGH	LOW	MID	HIGH
	Cell BW [MHz]	5	5	5	10	10	10	15	15	15
	CH no.	20775	21100	21425	20800	21100	21400	20825	21100	21375
	f [MHz]	2502.5	2535.0	2567.5	2505.0	2535.0	2565.0	2507.5	2535.0	2562.5
		LOW	MID	HIGH	LOW	MID	HIGH	LOW	MID	HIGH
	Cell BW [MHz]	20	20	20	-	-	-	-	-	-
	CH no.	20850	21100	21350	-	-	-	-	-	-
	f [MHz]	2510.0	2535.0	2560.0	-	-	-	-	-	-

LTE eFDD 8		LOW	MID	HIGH	LOW	MID	HIGH	LOW	MID	HIGH
	Cell BW [MHz]	1.4	1.4	1.4	-	3	-	-	-	-
	CH no.	21632	21640	21649	-	21640	-	-	-	-
	f [MHz]	898.2	899.0	899.8	-	899.0	-	-	-	-
		LOW	MID	HIGH	LOW	MID	HIGH	LOW	MID	HIGH
	Cell BW [MHz]	-	-	-	-	-	-	-	-	-
	CH no.	-	-	-	-	-	-	-	-	-
	f [MHz]	-	-	-	-	-	-	-	-	-

LTE eFDD 12		LOW	MID	HIGH	LOW	MID	HIGH	LOW	MID	HIGH
	Cell BW [MHz]	1.4	1.4	1.4	3	3	3	5	5	5
	CH no.	23017	23095	23173	23025	23095	23165	23035	23095	23155
	f [MHz]	699.7	707.5	715.3	700.5	707.5	714.5	701.5	707.5	713.5
		LOW	MID	HIGH	LOW	MID	HIGH	LOW	MID	HIGH
	Cell BW [MHz]	10	10	10	-	-	-	-	-	-
	f [MHz]	704.0	707.5	711.0	-	-	-	-	-	-

LTE eFDD 13		LOW	MID	HIGH	LOW	MID	HIGH	LOW	MID	HIGH
	Cell BW [MHz]	5	5	5	10	10	10	-	-	-
	CH no.	23205	23230	23255	-	23230	-	-	-	-
	f [MHz]	779.5	782.0	784.5	-	782.0	-	-	-	-
		LOW	MID	HIGH	LOW	MID	HIGH	LOW	MID	HIGH
	Cell BW [MHz]	-	-	-	-	-	-	-	-	-
	f [MHz]	-	-	-	-	-	-	-	-	-

LTE eFDD 26 (Part 90)		LOW	MID	HIGH	LOW	MID	HIGH	LOW	MID	HIGH
	Cell BW [MHz]	1.4	1.4	1.4	3	3	3	5	5	5
	CH no.	26697	26740	26783	26705	26740	26776	26715	26740	26766
	f [MHz]	814.7	819.0	823.3	815.5	819.0	822.5	816.5	819.0	821.5
		LOW	MID	HIGH	LOW	MID	HIGH	LOW	MID	HIGH
	Cell BW [MHz]	-	10	-	-	-	-	-	-	-
	f [MHz]	-	819.0	-	-	-	-	-	-	-

LTE eFDD 26 (Part 22)		LOW	MID	HIGH	LOW	MID	HIGH	LOW	MID	HIGH
	Cell BW [MHz]	1.4	1.4	1.4	3	3	3	5	5	5
	CH no.	26797	26915	27033	26805	26915	27025	26815	26915	27015
	f [MHz]	824.7	836.5	848.3	825.5	836.5	847.5	826.5	836.5	846.5
		LOW	MID	HIGH	LOW	MID	HIGH	LOW	MID	HIGH
	Cell BW [MHz]	10	10	10	-	-	-	-	-	-
	f [MHz]	829.0	836.5	844	-	-	-	-	-	-

LTE eTDD 38		LOW	MID	HIGH	LOW	MID	HIGH	LOW	MID	HIGH
	Cell BW [MHz]	5	5	5	10	10	10	15	15	15
	CH no.	37775	38000	38225	37800	38000	38200	37825	38000	38175
	f [MHz]	2572.5	2595.0	2617.5	2575.0	2595.0	2615.0	2577.5	2595.0	2612.5
		LOW	MID	HIGH	LOW	MID	HIGH	LOW	MID	HIGH
	Cell BW [MHz]	20	20	20	-	-	-	-	-	-
	f [MHz]	2580.0	2595.0	2610.0	-	-	-	-	-	-

LTE eTDD 41		LOW	MID	HIGH	LOW	MID	HIGH	LOW	MID	HIGH
	Cell BW [MHz]	5	5	5	10	10	10	15	15	15
	CH no.	39675	40620	41565	39700	40620	41540	39725	40620	41515
	f [MHz]	2498.5	2593.0	2687.5	2501.0	2593.0	2685.0	2503.5	2593.0	2682.5
		LOW	MID	HIGH	LOW	MID	HIGH	LOW	MID	HIGH
	Cell BW [MHz]	20	20	20	-	-	-	-	-	-
	f [MHz]	2506.0	2593.0	2680.0	-	-	-	-	-	-

4.7 PRODUCT LABELLING

4.7.1 FCC ID LABEL

Please refer to the documentation of the applicant.

4.7.2 LOCATION OF THE LABEL ON THE EUT

Please refer to the documentation of the applicant.

5 TEST RESULTS

5.1 RF OUTPUT POWER

Standard **FCC PART 22 Subpart H**

The test was performed according to:
ANSI C63.26: 2015

5.1.1 TEST DESCRIPTION

This test case is intended to demonstrate compliance to the applicable RF Output power test case per § 2.1046 and RSS-GEN 6.12. The limit and the requirements come from the applicable rule part and ISED RSS-Standard for the operating band of the cellular device.

The EUT was connected to the test setup according to the following diagram:

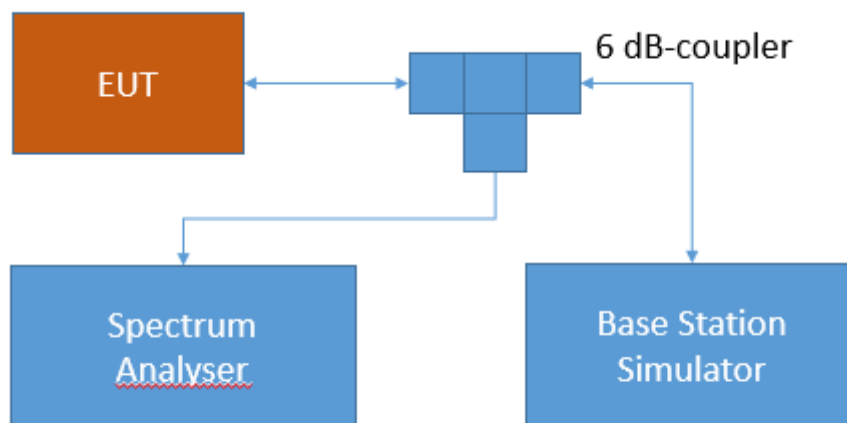

Test Setup FCC Part 22/24/27/90 Cellular;
RF Output power

The attenuation of the measuring and stimulus path are known for each measured frequency and are considered.

The Spectrum Analyzer settings can be directly found in the measurement diagrams.

5.1.2 TEST REQUIREMENTS / LIMITS

FCC Part 22, § 22.913

(a) *Maximum ERP.* The ERP of transmitters in the Cellular Radiotelephone Service must not exceed the limits in this section.

(5) The ERP of mobile transmitters and auxiliary test transmitters must not exceed 7 watts.

RSS-132; 5.4 Transmitter Output Power and Equivalent Isotropically Radiated Power

The transmitter output power shall be measured in terms of average power. The equivalent isotropically radiated power (e.i.r.p.) for mobile equipment shall not exceed 11.5 watts.

5.1.3 TEST PROTOCOL

Ambient temperature: 20 - 28 °C
Relative humidity: 30 - 45 %

Radio Technology	CH	Re-source Blocks	Band-width [MHz]	Peak Cond. Power [dBm]	Average Cond. Power [dBm]	RMS Cond. Power [dBm]	FCC EIRP Limit [W]	IC EIRP Limit [W]	Max. Antenna Gain FCC [dBi]	Max. Antenna Gain IC [dBi]
GSM 850	low	-	0.2	32.05	31.46	31.55	11.5	11.5	8.55	8.55
GSM 850	mid	-	0.2	31.85	31.24	31.35	11.5	11.5	8.75	8.75
GSM 850	high	-	0.2	31.88	31.29	31.38	11.5	11.5	8.72	8.72
GSM 850 EDGE	low	-	0.2	29.40	25.99	26.56	11.5	11.5	11.20	11.20
GSM 850 EDGE	mid	-	0.2	29.42	25.93	26.63	11.5	11.5	11.18	11.18
GSM 850 EDGE	high	-	0.2	29.43	25.78	26.77	11.5	11.5	11.17	11.17
FDD V	low	-	5	28.53	23.09	23.23	11.5	11.5	17.37	17.37
FDD V	mid	-	5	28.65	23.13	23.27	11.5	11.5	17.33	17.33
FDD V	high	-	5	28.78	23.13	23.27	11.5	11.5	17.33	17.33
FDD V HSDPA Subtest 1	low	-	5	28.02	22.43	22.57	11.5	11.5	18.03	18.03
FDD V HSDPA Subtest 1	mid	-	5	27.62	22.23	22.43	11.5	11.5	18.17	18.17
FDD V HSDPA Subtest 1	high	-	5	25.27	22.33	22.49	11.5	11.5	18.11	18.11
FDD V HSDPA Subtest 2	low	-	5	23.15	16.40	16.89	11.5	11.5	23.71	23.71
FDD V HSDPA Subtest 2	mid	-	5	28.14	21.43	21.91	11.5	11.5	18.69	18.69
FDD V HSDPA Subtest 2	high	-	5	28.02	21.80	21.91	11.5	11.5	18.69	18.69
FDD V HSDPA Subtest 3	low	-	5	28.39	21.82	22.74	11.5	11.5	17.86	17.86
FDD V HSDPA Subtest 3	mid	-	5	27.62	21.71	22.57	11.5	11.5	18.03	18.03
FDD V HSDPA Subtest 3	high	-	5	27.77	20.68	22.40	11.5	11.5	18.20	18.20
FDD V HSDPA Subtest 4	low	-	5	28.39	21.79	22.68	11.5	11.5	17.92	17.92
FDD V HSDPA Subtest 4	mid	-	5	28.39	21.43	21.91	11.5	11.5	18.69	18.69
FDD V HSDPA Subtest 4	high	-	5	27.77	21.71	22.27	11.5	11.5	18.33	18.33
FDD V HSUPA Subtest 1	low	-	5	28.39	22.47	21.89	11.5	11.5	18.71	18.71
FDD V HSUPA Subtest 1	mid	-	5	28.02	22.20	22.55	11.5	11.5	18.05	18.05
FDD V HSUPA Subtest 1	high	-	5	28.02	22.22	21.90	11.5	11.5	18.70	18.70
FDD V HSUPA Subtest 2	low	-	5	20.59	12.27	20.32	11.5	11.5	20.28	20.28
FDD V HSUPA Subtest 2	mid	-	5	27.89	21.30	22.67	11.5	11.5	17.93	17.93
FDD V HSUPA Subtest 2	high	-	5	27.37	21.15	21.60	11.5	11.5	19.00	19.00
FDD V HSUPA Subtest 3	low	-	5	28.28	21.74	22.03	11.5	11.5	18.57	18.57

FDD V HSUPA Subtest 3	mid	-	5	28.53	22.09	22.51	11.5	11.5	18.09	18.09
FDD V HSUPA Subtest 3	high	-	5	28.28	22.32	21.95	11.5	11.5	18.65	18.65
FDD V HSUPA Subtest 4	low	-	5	28.28	22.20	22.49	11.5	11.5	18.11	18.11
FDD V HSUPA Subtest 4	mid	-	5	28.28	22.33	22.73	11.5	11.5	17.87	17.87
FDD V HSUPA Subtest 4	high	-	5	28.14	21.49	21.92	11.5	11.5	18.68	18.68
FDD V HSUPA Subtest 5	low	-	5	28.88	21.15	21.93	11.5	11.5	18.67	18.67
FDD V HSUPA Subtest 5	mid	-	5	28.78	21.86	22.79	11.5	11.5	17.81	17.81
FDD V HSUPA Subtest 5	high	-	5	28.14	21.41	22.84	11.5	11.5	17.76	17.76
LTE eFDD 5 QPSK	low	1	1.4	-	-	23.45	11.5	11.5	17.15	17.15
LTE eFDD 5 QPSK	low	3	1.4	-	-	22.92	11.5	11.5	17.68	17.68
LTE eFDD 5 QPSK	low	6	1.4	-	-	22.01	11.5	11.5	18.59	18.59
LTE eFDD 5 QPSK	mid	1	1.4	-	-	23.15	11.5	11.5	17.45	17.45
LTE eFDD 5 QPSK	mid	3	1.4	-	-	22.84	11.5	11.5	17.76	17.76
LTE eFDD 5 QPSK	mid	6	1.4	-	-	21.93	11.5	11.5	18.67	18.67
LTE eFDD 5 QPSK	high	1	1.4	-	-	23.53	11.5	11.5	17.07	17.07
LTE eFDD 5 QPSK	high	3	1.4	-	-	22.99	11.5	11.5	17.61	17.61
LTE eFDD 5 QPSK	high	6	1.4	-	-	21.91	11.5	11.5	18.69	18.69
LTE eFDD 5 16QAM	low	1	1.4	-	-	21.22	11.5	11.5	19.38	19.38
LTE eFDD 5 16QAM	low	6	1.4	-	-	19.94	11.5	11.5	20.66	20.66
LTE eFDD 5 16QAM	mid	1	1.4	-	-	21.87	11.5	11.5	18.73	18.73
LTE eFDD 5 16QAM	mid	6	1.4	-	-	20.08	11.5	11.5	20.52	20.52
LTE eFDD 5 16QAM	high	1	1.4	-	-	21.67	11.5	11.5	18.93	18.93
LTE eFDD 5 16QAM	high	6	1.4	-	-	19.94	11.5	11.5	20.66	20.66
LTE eFDD 5 QPSK	low	1	3	-	-	23.55	11.5	11.5	17.05	17.05
LTE eFDD 5 QPSK	low	15	3	-	-	22.45	11.5	11.5	18.15	18.15
LTE eFDD 5 QPSK	mid	1	3	-	-	23.65	11.5	11.5	16.95	16.95
LTE eFDD 5 QPSK	mid	15	3	-	-	22.46	11.5	11.5	18.14	18.14
LTE eFDD 5 QPSK	high	1	3	-	-	23.63	11.5	11.5	16.97	16.97
LTE eFDD 5 QPSK	high	15	3	-	-	22.42	11.5	11.5	18.18	18.18
LTE eFDD 5 16QAM	low	1	3	-	-	21.78	11.5	11.5	18.82	18.82
LTE eFDD 5 16QAM	low	15	3	-	-	20.38	11.5	11.5	20.22	20.22
LTE eFDD 5 16QAM	mid	1	3	-	-	22.03	11.5	11.5	18.57	18.57
LTE eFDD 5 16QAM	mid	15	3	-	-	20.55	11.5	11.5	20.05	20.05
LTE eFDD 5 16QAM	high	1	3	-	-	21.97	11.5	11.5	18.63	18.63
LTE eFDD 5 16QAM	high	15	3	-	-	20.25	11.5	11.5	20.35	20.35
LTE eFDD 5 QPSK	low	1	5	-	-	22.85	11.5	11.5	17.75	17.75
LTE eFDD 5 QPSK	low	12	5	-	-	21.79	11.5	11.5	18.81	18.81
LTE eFDD 5 QPSK	low	25	5	-	-	21.70	11.5	11.5	18.90	18.90
LTE eFDD 5 QPSK	mid	1	5	-	-	23.55	11.5	11.5	17.05	17.05
LTE eFDD 5 QPSK	mid	12	5	-	-	22.34	11.5	11.5	18.26	18.26
LTE eFDD 5 QPSK	mid	25	5	-	-	22.34	11.5	11.5	18.26	18.26
LTE eFDD 5 QPSK	high	1	5	-	-	22.85	11.5	11.5	17.75	17.75
LTE eFDD 5 QPSK	high	12	5	-	-	21.66	11.5	11.5	18.94	18.94
LTE eFDD 5 QPSK	high	25	5	-	-	21.74	11.5	11.5	18.86	18.86
LTE eFDD 5 16QAM	low	1	5	-	-	22.25	11.5	11.5	18.35	18.35
LTE eFDD 5 16QAM	low	25	5	-	-	20.45	11.5	11.5	20.15	20.15
LTE eFDD 5 16QAM	mid	1	5	-	-	21.75	11.5	11.5	18.85	18.85

LTE eFDD 5 16QAM	mid	25	5	-	-	20.45	11.5	11.5	20.15	20.15
LTE eFDD 5 16QAM	high	1	5	-	-	21.42	11.5	11.5	19.18	19.18
LTE eFDD 5 16QAM	high	25	5	-	-	20.30	11.5	11.5	20.30	20.30
LTE eFDD 5 QPSK	low	1	10	-	-	23.76	11.5	11.5	16.84	16.84
LTE eFDD 5 QPSK	low	50	10	-	-	22.43	11.5	11.5	18.17	18.17
LTE eFDD 5 QPSK	mid	1	10	-	-	24.04	11.5	11.5	16.56	16.56
LTE eFDD 5 QPSK	mid	50	10	-	-	22.53	11.5	11.5	18.07	18.07
LTE eFDD 5 QPSK	high	1	10	-	-	23.68	11.5	11.5	16.92	16.92
LTE eFDD 5 QPSK	high	50	10	-	-	22.50	11.5	11.5	18.10	18.10
LTE eFDD 5 16QAM	low	1	10	-	-	22.10	11.5	11.5	18.50	18.50
LTE eFDD 5 16QAM	low	12	10	-	-	21.90	11.5	11.5	18.70	18.70
LTE eFDD 5 16QAM	mid	1	10	-	-	21.75	11.5	11.5	18.85	18.85
LTE eFDD 5 16QAM	mid	12	10	-	-	21.77	11.5	11.5	18.83	18.83
LTE eFDD 5 16QAM	high	1	10	-	-	22.16	11.5	11.5	18.44	18.44
LTE eFDD 5 16QAM	high	12	10	-	-	21.71	11.5	11.5	18.89	18.89
LTE eFDD 26 QPSK	low	1	1.4	-	-	23.49	11.5	11.5	17.11	17.11
LTE eFDD 26 QPSK	low	3	1.4	-	-	22.92	11.5	11.5	17.68	17.68
LTE eFDD 26 QPSK	low	6	1.4	-	-	21.86	11.5	11.5	18.74	18.74
LTE eFDD 26 QPSK	mid	1	1.4	-	-	23.55	11.5	11.5	17.05	17.05
LTE eFDD 26 QPSK	mid	3	1.4	-	-	22.91	11.5	11.5	17.69	17.69
LTE eFDD 26 QPSK	mid	6	1.4	-	-	22.06	11.5	11.5	18.54	18.54
LTE eFDD 26 QPSK	high	1	1.4	-	-	23.21	11.5	11.5	17.39	17.39
LTE eFDD 26 QPSK	high	3	1.4	-	-	22.90	11.5	11.5	17.70	17.70
LTE eFDD 26 QPSK	high	6	1.4	-	-	21.83	11.5	11.5	18.77	18.77
LTE eFDD 26 16QAM	low	1	1.4	-	-	21.96	11.5	11.5	18.64	18.64
LTE eFDD 26 16QAM	low	6	1.4	-	-	20.73	11.5	11.5	19.87	19.87
LTE eFDD 26 16QAM	mid	1	1.4	-	-	22.20	11.5	11.5	18.40	18.40
LTE eFDD 26 16QAM	mid	6	1.4	-	-	20.44	11.5	11.5	20.16	20.16
LTE eFDD 26 16QAM	high	1	1.4	-	-	22.15	11.5	11.5	18.45	18.45
LTE eFDD 26 16QAM	high	6	1.4	-	-	20.40	11.5	11.5	20.20	20.20
LTE eFDD 26 QPSK	low	1	3	-	-	23.47	11.5	11.5	17.13	17.13
LTE eFDD 26 QPSK	low	15	3	-	-	22.32	11.5	11.5	18.28	18.28
LTE eFDD 26 QPSK	mid	1	3	-	-	23.50	11.5	11.5	17.10	17.10
LTE eFDD 26 QPSK	mid	15	3	-	-	22.45	11.5	11.5	18.15	18.15
LTE eFDD 26 QPSK	high	1	3	-	-	22.88	11.5	11.5	17.72	17.72
LTE eFDD 26 QPSK	high	15	3	-	-	21.75	11.5	11.5	18.85	18.85
LTE eFDD 26 16QAM	low	1	3	-	-	22.65	11.5	11.5	17.95	17.95
LTE eFDD 26 16QAM	low	15	3	-	-	20.98	11.5	11.5	19.62	19.62
LTE eFDD 26 16QAM	mid	1	3	-	-	22.19	11.5	11.5	18.41	18.41
LTE eFDD 26 16QAM	mid	15	3	-	-	20.85	11.5	11.5	19.75	19.75
LTE eFDD 26 16QAM	high	1	3	-	-	22.30	11.5	11.5	18.30	18.30
LTE eFDD 26 16QAM	high	15	3	-	-	20.66	11.5	11.5	19.94	19.94
LTE eFDD 26 QPSK	low	1	5	-	-	23.42	11.5	11.5	17.18	17.18
LTE eFDD 26 QPSK	low	12	5	-	-	22.20	11.5	11.5	18.40	18.40
LTE eFDD 26 QPSK	low	25	5	-	-	22.35	11.5	11.5	18.25	18.25
LTE eFDD 26 QPSK	mid	1	5	-	-	23.67	11.5	11.5	16.93	16.93
LTE eFDD 26 QPSK	mid	12	5	-	-	22.17	11.5	11.5	18.43	18.43

LTE eFDD 26 QPSK	mid	25	5	-	-	22.24	11.5	11.5	18.36	18.36
LTE eFDD 26 QPSK	high	1	5	-	-	23.60	11.5	11.5	17.00	17.00
LTE eFDD 26 QPSK	high	12	5	-	-	22.23	11.5	11.5	18.37	18.37
LTE eFDD 26 QPSK	high	25	5	-	-	22.19	11.5	11.5	18.41	18.41
LTE eFDD 26 16QAM	low	1	5	-	-	22.15	11.5	11.5	18.45	18.45
LTE eFDD 26 16QAM	low	25	5	-	-	21.03	11.5	11.5	19.57	19.57
LTE eFDD 26 16QAM	mid	1	5	-	-	22.27	11.5	11.5	18.33	18.33
LTE eFDD 26 16QAM	mid	25	5	-	-	20.80	11.5	11.5	19.80	19.80
LTE eFDD 26 16QAM	high	1	5	-	-	22.41	11.5	11.5	18.19	18.19
LTE eFDD 26 16QAM	high	25	5	-	-	20.83	11.5	11.5	19.77	19.77
LTE eFDD 26 QPSK	low	1	10	-	-	23.89	11.5	11.5	16.71	16.71
LTE eFDD 26 QPSK	low	50	10	-	-	22.56	11.5	11.5	18.04	18.04
LTE eFDD 26 QPSK	mid	1	10	-	-	24.13	11.5	11.5	16.47	16.47
LTE eFDD 26 QPSK	mid	50	10	-	-	22.52	11.5	11.5	18.08	18.08
LTE eFDD 26 QPSK	high	1	10	-	-	23.65	11.5	11.5	16.95	16.95
LTE eFDD 26 QPSK	high	50	10	-	-	22.47	11.5	11.5	18.13	18.13
LTE eFDD 26 16QAM	low	1	10	-	-	23.17	11.5	11.5	17.43	17.43
LTE eFDD 26 16QAM	low	12	10	-	-	21.03	11.5	11.5	19.57	19.57
LTE eFDD 26 16QAM	mid	1	10	-	-	22.26	11.5	11.5	18.34	18.34
LTE eFDD 26 16QAM	mid	12	10	-	-	20.37	11.5	11.5	20.23	20.23
LTE eFDD 26 16QAM	high	1	10	-	-	22.47	11.5	11.5	18.13	18.13
LTE eFDD 26 16QAM	high	12	10	-	-	20.68	11.5	11.5	19.92	19.92

Remark: Please see next sub-clause for the measurement plot.

5.1.4 MEASUREMENT PLOT (EXAMPLE PLOT, SHOWING WORST CASE, IF APPLICABLE)

GSM 850, Channel = low

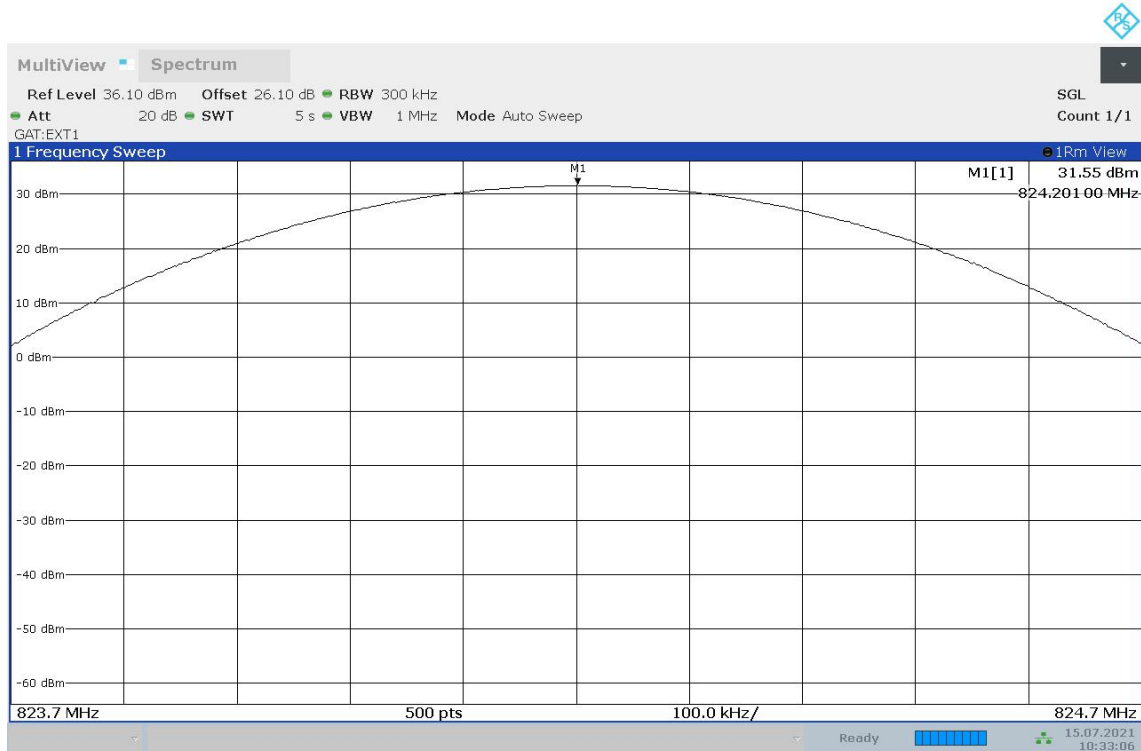

10:33:07 15.07.2021

EDGE 850, Channel = high

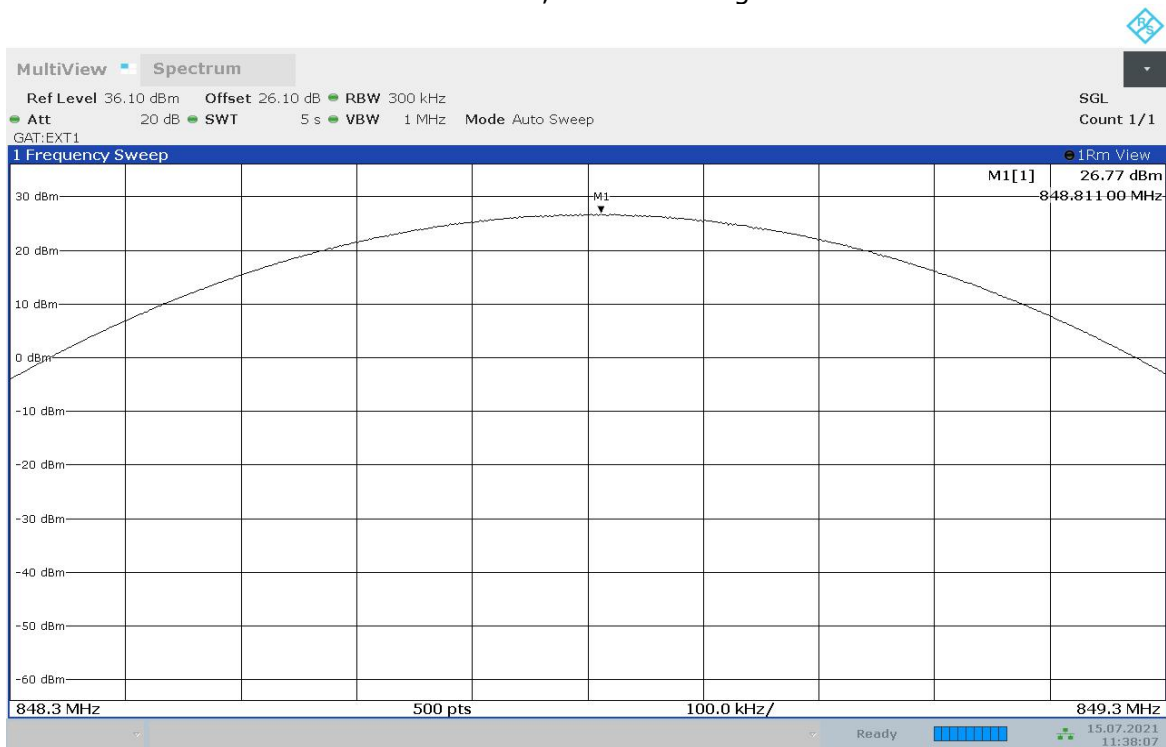

11:38:07 15.07.2021

WCDMA FDD 5, Channel = mid

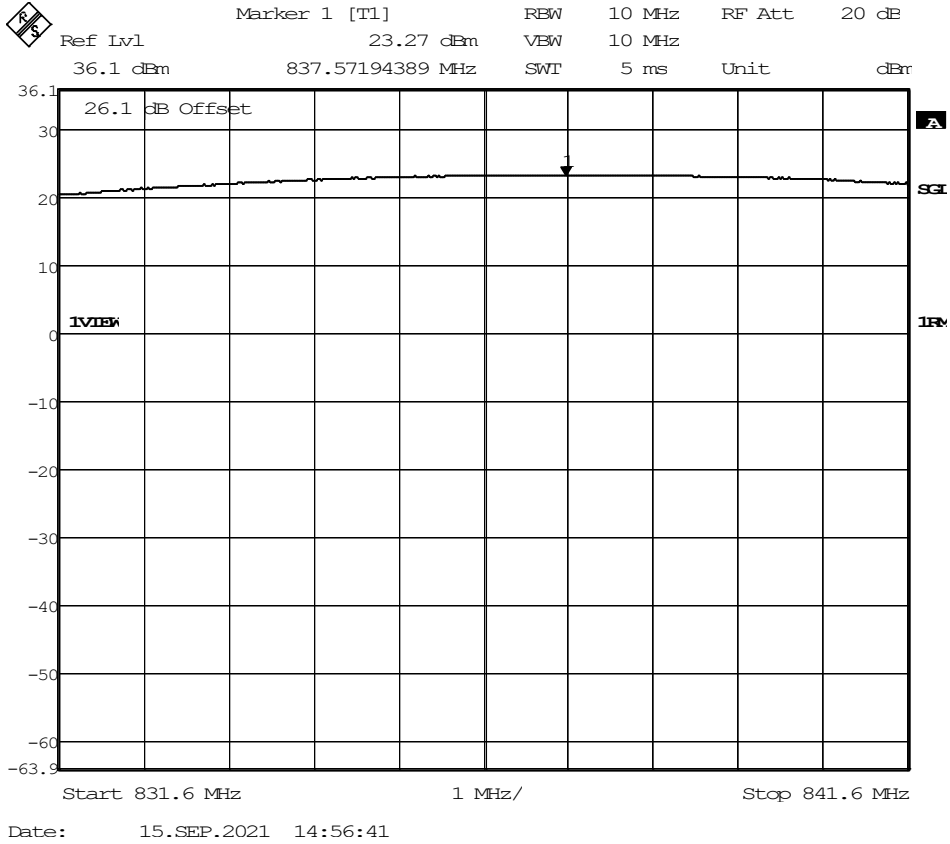

HSDPA FDD 5 Subtest 4, Channel = low

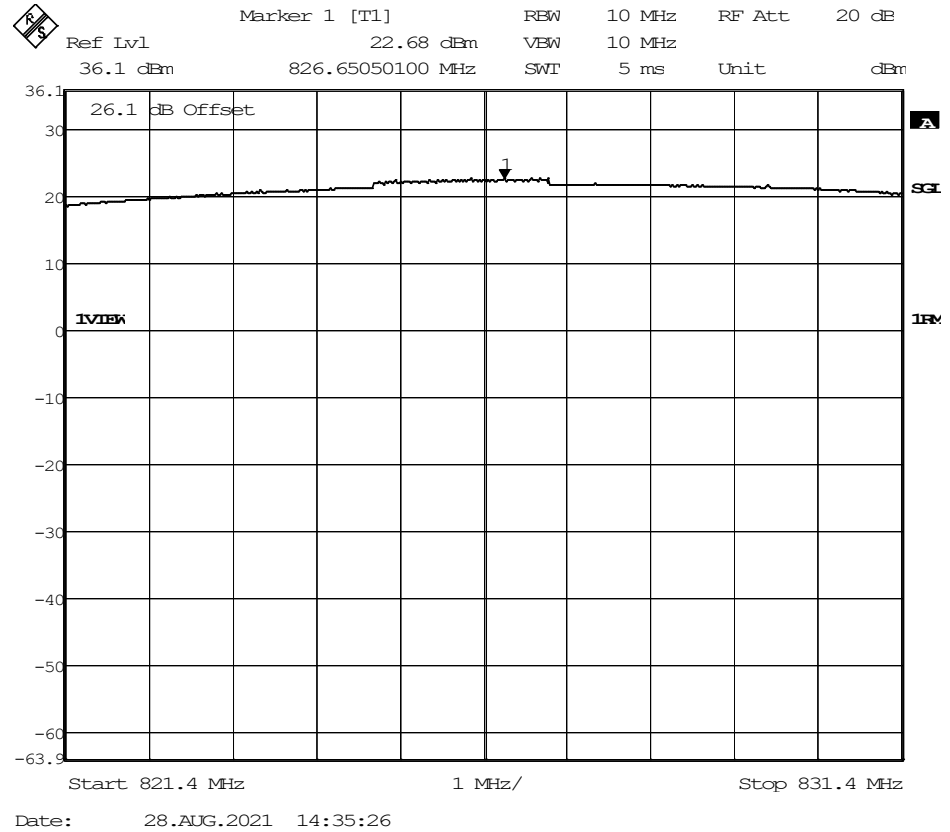

HSUPA FDD 5 Subtest 5, Channel = high

	Marker 1 [T1]	RBW	10 MHz	RF Att	20 dB
Ref Lvl	22.84 dBm	VBW	10 MHz		
36.1 dBm	847.89258517 MHz	SWT	5 ms	Unit	dBm

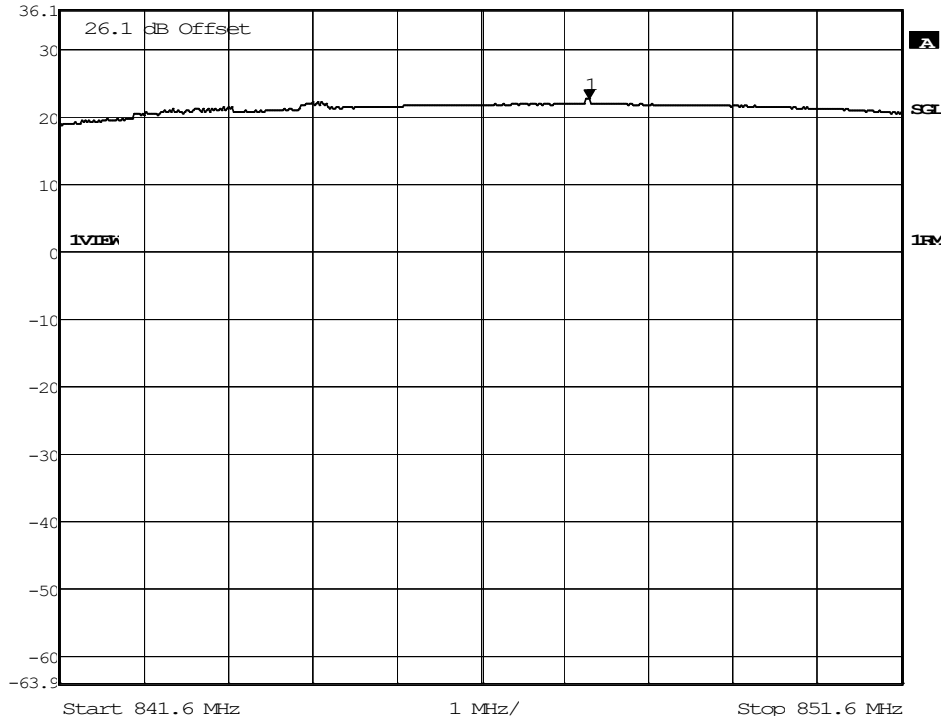

Date: 15.SEP.2021 13:01:12

LTE eFDD 5 QPSK 10 MHz RBs = 1, Channel = mid

	Marker 1 [T1]	RBW	200 kHz	RF Att	20 dB
Ref Lvl	23.50 dBm	VBW	1 MHz		
36.1 dBm	836.60020040 MHz	SWT	10 ms	Unit	dBm

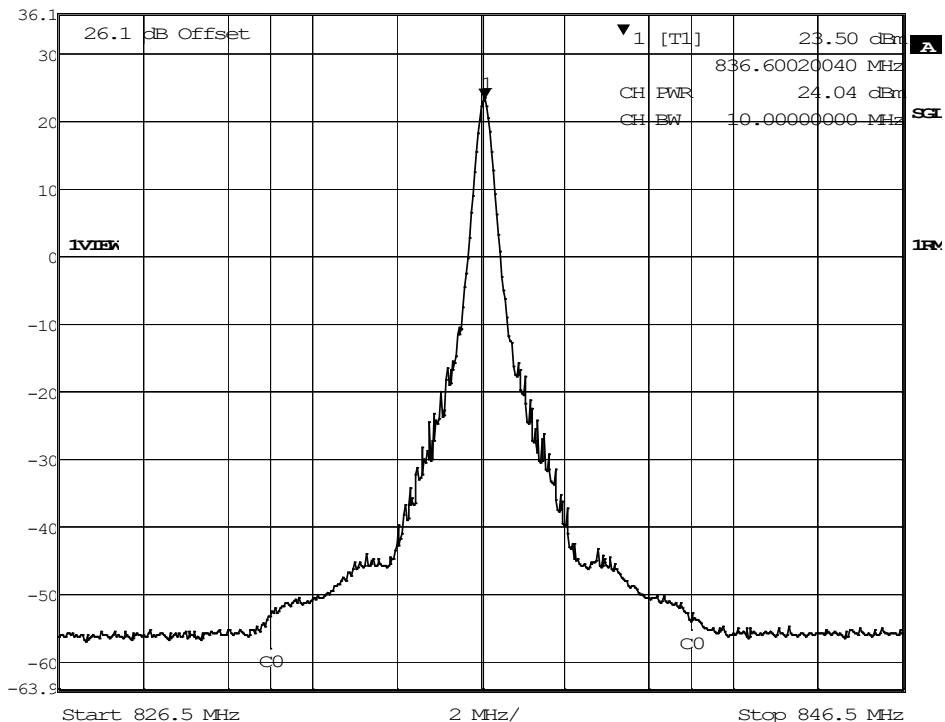

Date: 10.AUG.2021 17:29:08

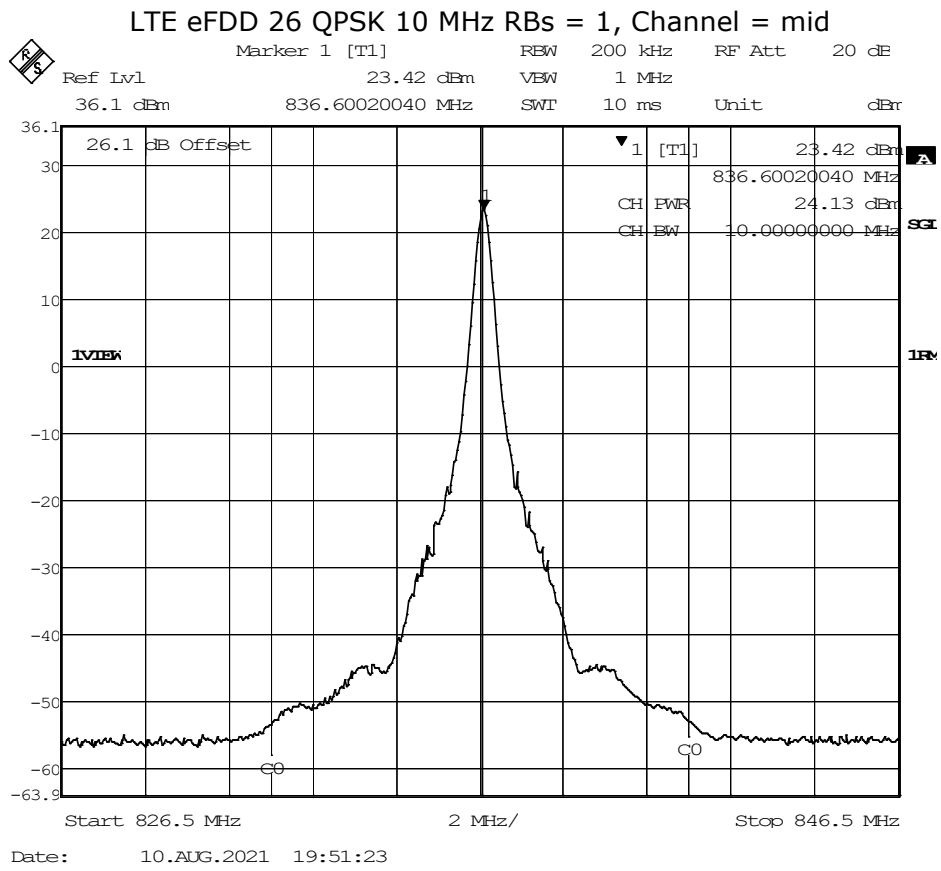

5.1.5 TEST EQUIPMENT USED

- Radio Lab

5.2 FREQUENCY STABILITY

Standard **FCC PART 22 Subpart H**

The test was performed according to:
ANSI C63.26: 2015

5.2.1 TEST DESCRIPTION

This test case is intended to demonstrate compliance to the applicable frequency stability test case per § 2.1055 and RSS-GEN 6.11. The limit and the requirements come from the applicable rule part and ISED RSS-Standard for the operating band of the cellular device.

The EUT was connected to the test setup according to the following diagram:



Test Setup FCC Part 22/24/27/90 Cellular;
Frequency stability

The attenuation of the measuring / stimulus path is known for each measured frequency and are considered.

5.2.2 TEST REQUIREMENTS / LIMITS

FCC Part 22, § 22.355

Except as otherwise provided in this part, the carrier frequency of each transmitter in the Public Mobile Services must be maintained within the tolerances given in Table C-1 of this section.

Table C-1—Frequency Tolerance for Transmitters in the Public Mobile Services

Frequency Range [MHz]	Mobile Devices > 3 W [ppm]	Mobile Devices ≤ 3 W [ppm]
25 – 50	20.0	50.0
50 – 450	5.0	50.0
450 – 512	5.0	5.0
821 – 896	2.5	2.5

928 - 929	n/a	n/a
929 - 960	n/a	n/a
2110 - 2220	n/a	n/a

RSS-132; 5.3 Frequency Stability

The carrier frequency shall not depart from the reference frequency in excess of ± 2.5 ppm for mobile stations.

In lieu of meeting the above stability values, the test report may show that the frequency stability is sufficient to ensure that the occupied bandwidth stays within each of the sub-bands (see Section 5.1) when tested to the temperature and supply voltage variations specified in RSS-Gen.

5.2.3 TEST PROTOCOL

GSM 850

Temp. °C	Duration min	Voltage	Limit Hz	Freq. error Average (Hz)	Freq. error Max. (Hz)	Verdict
-30	0	normal	2095.5	10	17	passed
-30	5			12	14	passed
-30	10			16	22	passed
-20	0	normal	2095.5	14	22	passed
-20	5			18	34	passed
-20	10			16	27	passed
-10	0	normal	2095.5	15	24	passed
-10	5			15	31	passed
-10	10			17	29	passed
0	0	normal	2095.5	14	31	passed
0	5			16	26	passed
0	10			19	24	passed
10	0	normal	2095.5	17	28	passed
10	5			12	32	passed
10	10			10	25	passed
20	0	low	2095.5	11	21	passed
20	5			16	26	passed
20	10			19	29	passed
20	0	normal	2095.5	17	30	passed
20	5			15	27	passed
20	10			18	26	passed
20	0	high	2095.5	13	24	passed
20	5			14	28	passed
20	10			16	26	passed
30	0	normal	2095.5	19	25	passed
30	5			14	27	passed
30	10			16	28	passed
40	0	normal	2095.5	15	24	passed
40	5			15	27	passed
40	10			16	25	passed
50	0	normal	2095.5	17	23	passed
50	5			14	21	passed
50	10			13	26	passed

EDGE 850

Temp. °C	Duration min	Voltage	Limit Hz	Freq. error Average (Hz)	Freq. error Max. (Hz)	Verdict
-30	0	normal	2095.5	9	15	passed
-30	5			13	19	passed
-30	10			12	14	passed
-20	0	normal	2095.5	8	14	passed
-20	5			10	16	passed
-20	10			11	19	passed
-10	0	normal	2095.5	7	15	passed
-10	5			11	19	passed
-10	10			8	18	passed
0	0	normal	2095.5	9	17	passed
0	5			9	15	passed
0	10			6	18	passed
10	0	normal	2095.5	12	19	passed
10	5			8	13	passed
10	10			10	14	passed
20	0	low	2095.5	7	12	passed
20	5			9	16	passed
20	10			10	18	passed
20	0	normal	2095.5	12	14	passed
20	5			9	18	passed
20	10			11	16	passed
20	0	high	2095.5	10	13	passed
20	5			8	18	passed
20	10			6	14	passed
30	0	normal	2095.5	9	16	passed
30	5			13	15	passed
30	10			10	14	passed
40	0	normal	2095.5	8	15	passed
40	5			11	17	passed
40	10			12	15	passed
50	0	normal	2095.5	11	16	passed
50	5			10	13	passed
50	10			12	15	passed

LTE eFDD 5

Temp. °C	Duration min	Voltage	Limit Hz	Freq. error Average (Hz)	Freq. error Max. (Hz)	Verdict
-30	0	normal	2091.25	8	12	passed
-30	5			5	-9	passed
-30	10			-4	-7	passed
-20	0	normal	2091.25	-9	10	passed
-20	5			-6	-8	passed
-20	10			7	-10	passed
-10	0	normal	2091.25	5	8	passed
-10	5			-7	7	passed
-10	10			-6	-7	passed
0	0	normal	2091.25	8	10	passed
0	5			7	11	passed
0	10			4	-12	passed
10	0	normal	2091.25	4	10	passed
10	5			-6	-7	passed
10	10			5	-9	passed
20	0	low	2091.25	-8	7	passed
20	5			-9	6	passed
20	10			-4	-8	passed
20	0	normal	2091.25	7	12	passed
20	5			7	11	passed
20	10			5	11	passed
20	0	high	2091.25	-6	-11	passed
20	5			-7	-12	passed
20	10			-5	13	passed
30	0	normal	2091.25	-8	12	passed
30	5			-6	9	passed
30	10			8	7	passed
40	0	normal	2091.25	7	-8	passed
40	5			5	-9	passed
40	10			-9	-8	passed
50	0	normal	2091.25	-6	10	passed
50	5			-6	9	passed
50	10			-7	9	passed

LTE eFDD 26

Temp. °C	Duration min	Voltage	Limit Hz	Freq. error Average (Hz)	Freq. error Max. (Hz)	Verdict
-30	0	normal	2047.5	3	9	passed
-30	5			1	11	passed
-30	10			2	10	passed
-20	0	normal	2047.5	2	8	passed
-20	5			2	9	passed
-20	10			1	10	passed
-10	0	normal	2047.5	2	10	passed
-10	5			3	10	passed
-10	10			2	12	passed
0	0	normal	2047.5	2	9	passed
0	5			0	8	passed
0	10			1	9	passed
10	0	normal	2047.5	2	10	passed
10	5			0	9	passed
10	10			1	11	passed
20	0	low	2047.5	1	8	passed
20	5			3	8	passed
20	10			2	10	passed
20	0	normal	2047.5	1	8	passed
20	5			1	9	passed
20	10			3	8	passed
20	0	high	2047.5	1	10	passed
20	5			1	7	passed
20	10			2	11	passed
30	0	normal	2047.5	3	12	passed
30	5			2	10	passed
30	10			2	9	passed
40	0	normal	2047.5	2	9	passed
40	5			1	9	passed
40	10			3	8	passed
50	0	normal	2047.5	0	9	passed
50	5			1	8	passed
50	10			3	9	passed

5.2.4 TEST EQUIPMENT USED

- Radio Lab

5.3 SPURIOUS EMISSIONS AT ANTENNA TERMINALS

Standard **FCC PART 22 Subpart H**

The test was performed according to:
ANSI C63.26: 2015

5.3.1 TEST DESCRIPTION

This test case is intended to demonstrate compliance to the applicable conducted spurious emission test case per § 2.1051 and RSS-GEN 6.13. The limit comes from the applicable rule part and ISSED RSS-Standard for the operating band of the cellular device.

The EUT was connected to the test setup according to the following diagram:

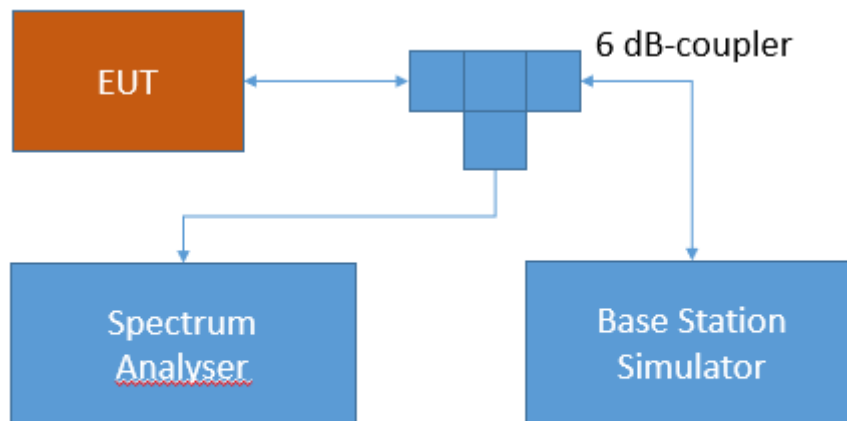

Test Setup FCC Part 22/24/27/90 Cellular;
Spurious Emissions at antenna terminal

The attenuation of the measuring and stimulus path are known for each measured frequency and are considered.

The Spectrum Analyzer settings can be directly found in the measurement diagrams.

5.3.2 TEST REQUIREMENTS / LIMITS

FCC Part 2.1051; Measurement required: Spurious emissions at antenna terminal:

The radio frequency voltage or powers generated within the equipment and appearing on a spurious frequency shall be checked at the equipment output terminals when properly loaded with a suitable artificial antenna. Curves or equivalent data shall show the magnitude of each harmonic and other spurious emission that can be detected when the equipment is operated under the conditions specified in §2.1049 as appropriate. The magnitude of spurious emissions which are attenuated more than 20 dB below the permissible value need not be specified.

Part 22, Subpart H – Cellular Radiotelephone Service

§22 917 – Emission limitations for cellular equipment

(a) *Out of band emissions.* The power of any emission outside of the authorized operating frequency ranges must be attenuated below the transmitting power (P) by a factor of at least $43 + 10 \log(P)$ dB.

RSS-132; 5.5 Transmitter Unwanted Emissions

Mobile and base station equipment shall comply with the limits in (i) and (ii) below.

1. In the first 1.0 MHz band immediately outside and adjacent to each of the sub-bands specified in Section 5.1, the power of emissions per any 1% of the occupied bandwidth shall be attenuated (in dB) below the transmitter output power P (dBW) by at least $43 + 10 \log_{10}p$ (watts).
2. After the first 1.0 MHz immediately outside and adjacent to each of the sub-bands, the power of emissions in any 100 kHz bandwidth shall be attenuated (in dB) below the transmitter output power P (dBW) by at least $43 + 10 \log_{10} p$ (watts). If the measurement is performed using 1% of the occupied bandwidth, power integration over 100 kHz is required.

5.3.3 TEST PROTOCOL

Ambient temperature: 20 - 28 °C
Relative humidity: 30 - 45 %

Radio Technology	Channel	Detector	Trace	Resolution Bandwidth /kHz	Frequency /MHz	Peak Value /dBm	Limit /dBm	Margin to Limit /dB
GSM 850	low	rms	maxhold	3	823.9	-24.33	-13	11.33
GSM 850	mid	rms	maxhold	-	-	-	-13	>20
GSM 850	high	rms	maxhold	3	849.0	-26.73	-13	13.73

Radio Technology	Channel	Detector	Trace	Resolution Bandwidth /kHz	Frequency /MHz	Peak Value /dBm	Limit /dBm	Margin to Limit /dB
EDGE 850	low	rms	maxhold	3	823.9	-32.22	-13	19.22
EDGE 850	mid	rms	maxhold	-	-	-	-13	>20
EDGE 850	high	rms	maxhold	3	849.0	-37.39	-13	24.39

Radio Technology	Channel	Detector	Trace	Resolution Bandwidth /kHz	Frequency /MHz	Peak Value /dBm	Limit /dBm	Margin to Limit /dB
FDD5 WCDMA	low	rms	maxhold	50	824.0	-25.71	-13	12.71
FDD5 WCDMA	mid	rms	maxhold	-	-	-	-13	>20
FDD5 WCDMA	high	rms	maxhold	50	849.1	-29.86	-13	16.86

Radio Technology	Channel	Detector	Trace	Resolution Bandwidth /kHz	Frequency /MHz	Peak Value /dBm	Limit /dBm	Margin to Limit /dB
FDD5 HSDPA	low	rms	maxhold	50	823.8	-29.24	-13	16.24
FDD5 HSDPA	mid	rms	maxhold	-	-	-	-13	>20
FDD5 HSDPA	high	rms	maxhold	50	849.0	-29.08	-13	16.08

Radio Technology	Channel	Detector	Trace	Resolution Bandwidth /kHz	Frequency /MHz	Peak Value /dBm	Limit /dBm	Margin to Limit /dB
FDD5 HSUPA	low	rms	maxhold	50	824.0	-27.40	-13	14.40
FDD5 HSUPA	mid	rms	maxhold	-	-	-	-13	>20
FDD5 HSUPA	high	rms	maxhold	50	849.0	-31.34	-13	18.34

Radio Technology	Channel	Detector	Trace	Resolution Bandwidth /kHz	Frequency /MHz	Peak Value /dBm	Limit /dBm	Margin to Limit /dB
eFDD5 QPSK	low	rms	maxhold	5	824.0	-33.42	-23	10.42
eFDD5 QPSK	mid	rms	maxhold	-	-	-	-13	>20
eFDD5 QPSK	high	rms	maxhold	5	849.0	-33.13	-23	10.13

Radio Technology	Channel	Detector	Trace	Resolution Bandwidth /kHz	Frequency /MHz	Peak Value /dBm	Limit /dBm	Margin to Limit /dB
eFDD26 QPSK	low	rms	maxhold	5	823.9	-32.3	-23	9.30
eFDD26 QPSK	mid	rms	maxhold	-	-	-	-13	>20
eFDD26 QPSK	high	rms	maxhold	5	849.0	-33.52	-23	10.52

Remark: Please see next sub-clause for the measurement plot.

5.3.4 MEASUREMENT PLOT (EXAMPLE PLOT, SHOWING WORST CASE, IF APPLICABLE)

GSM 850, Channel = low

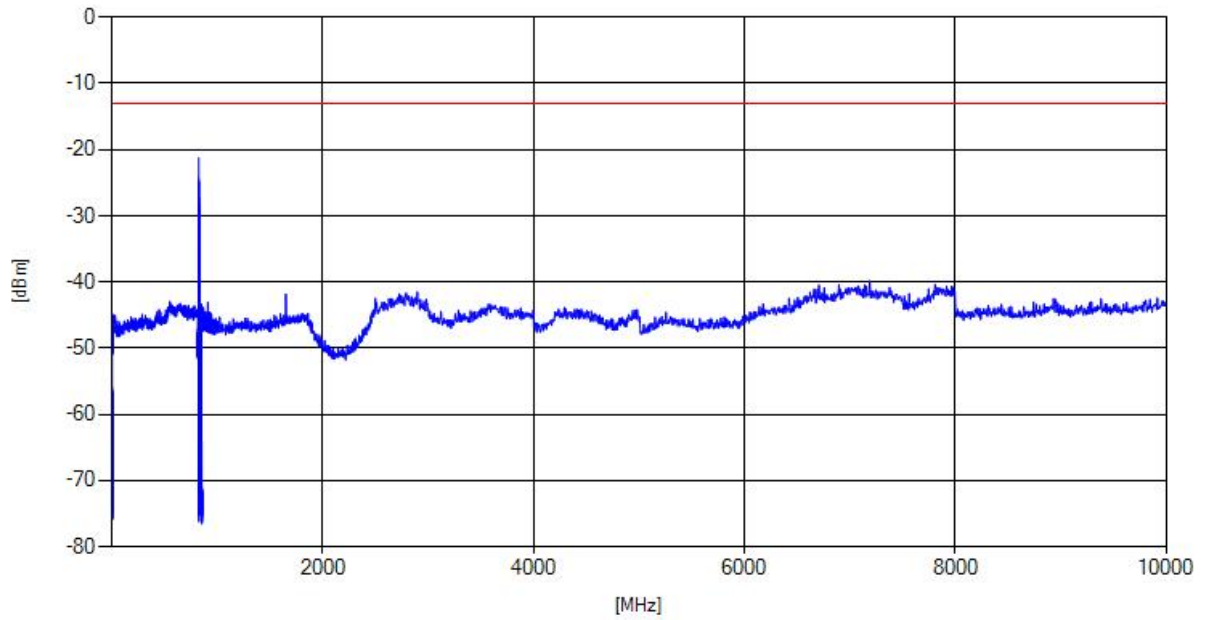

EDGE 850, Channel = low

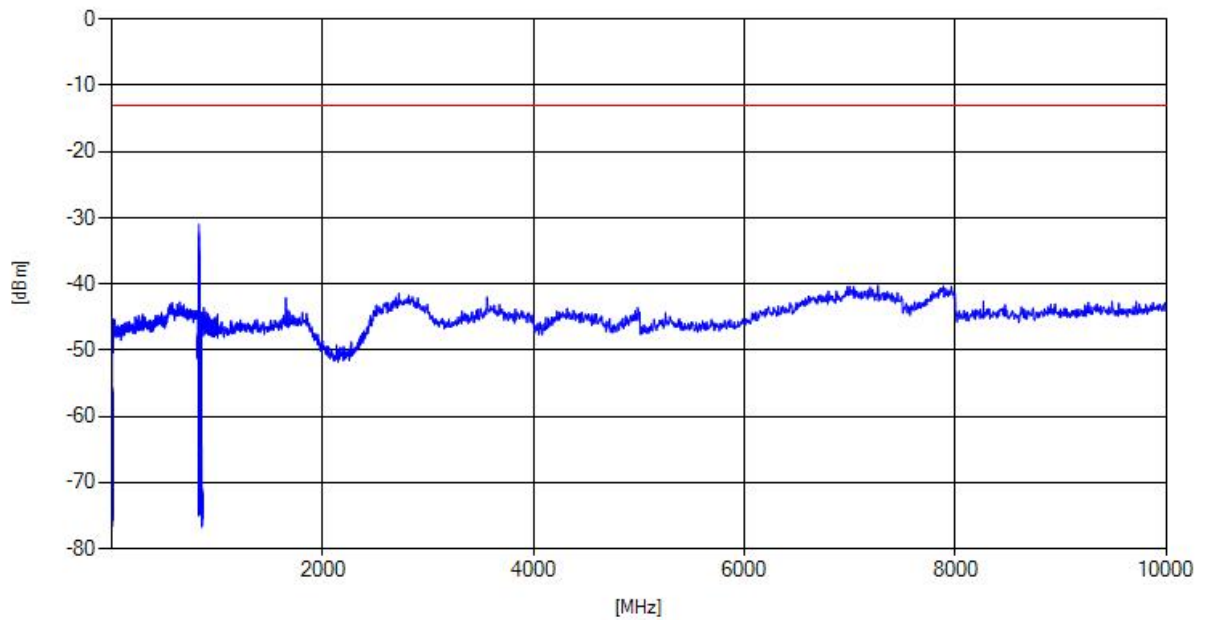

WCDMA FDD 5, Channel = low

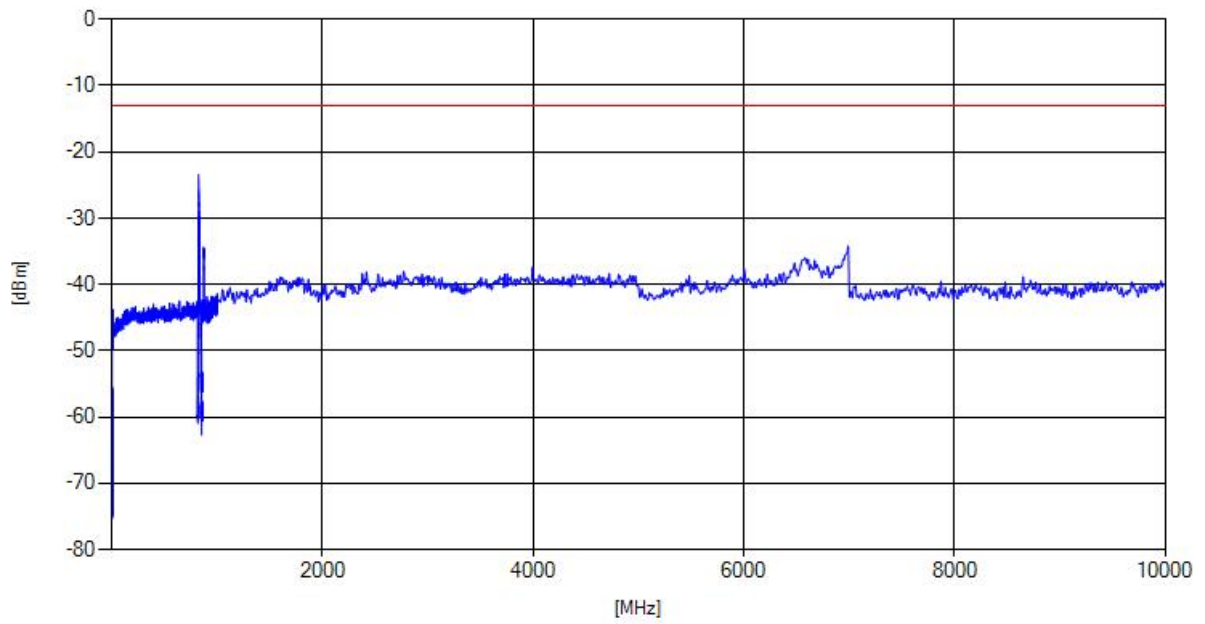

HSDPA FDD 5, Channel = low

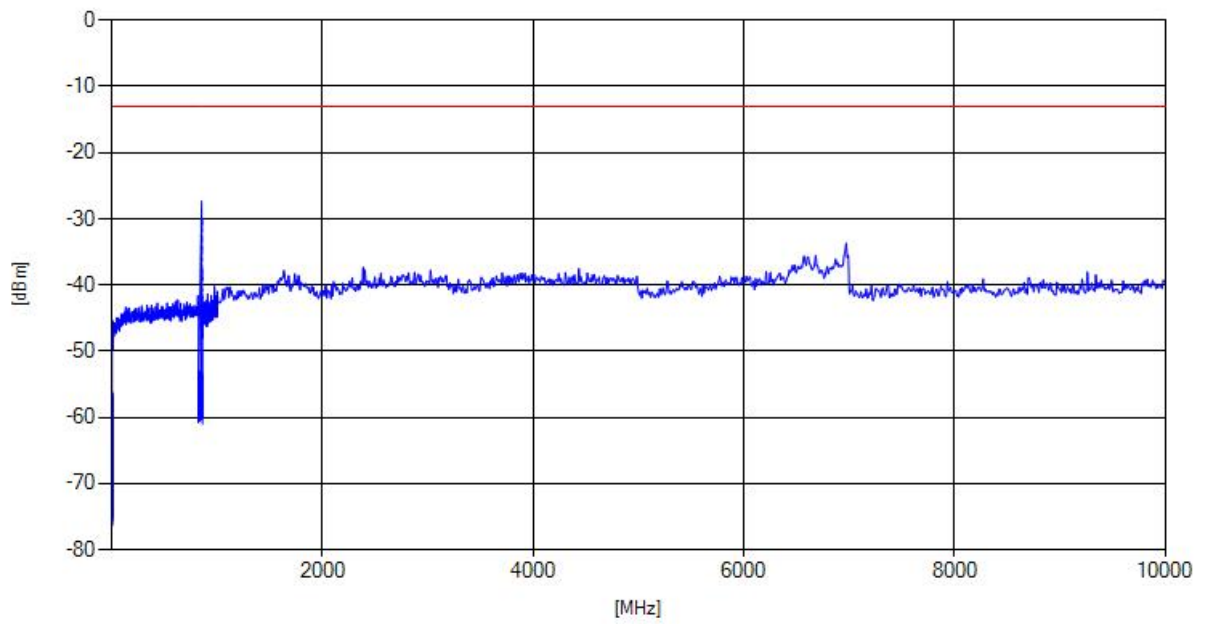

HSUPA FDD 5, Channel = low

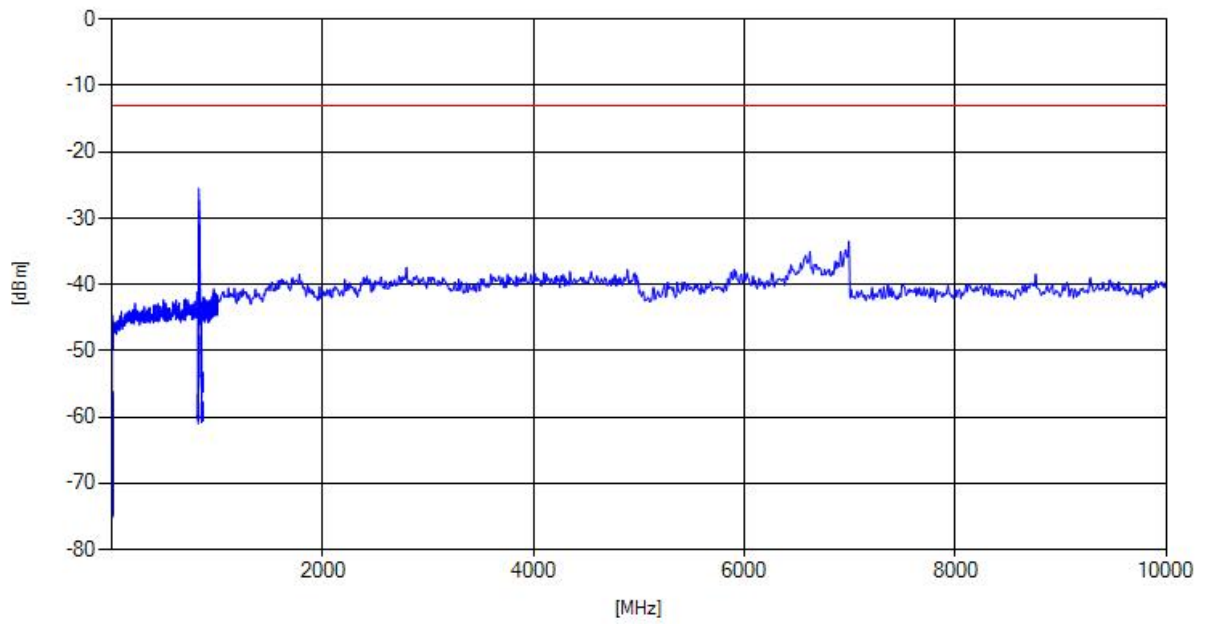

eFDD 5 QPSK, Channel = high

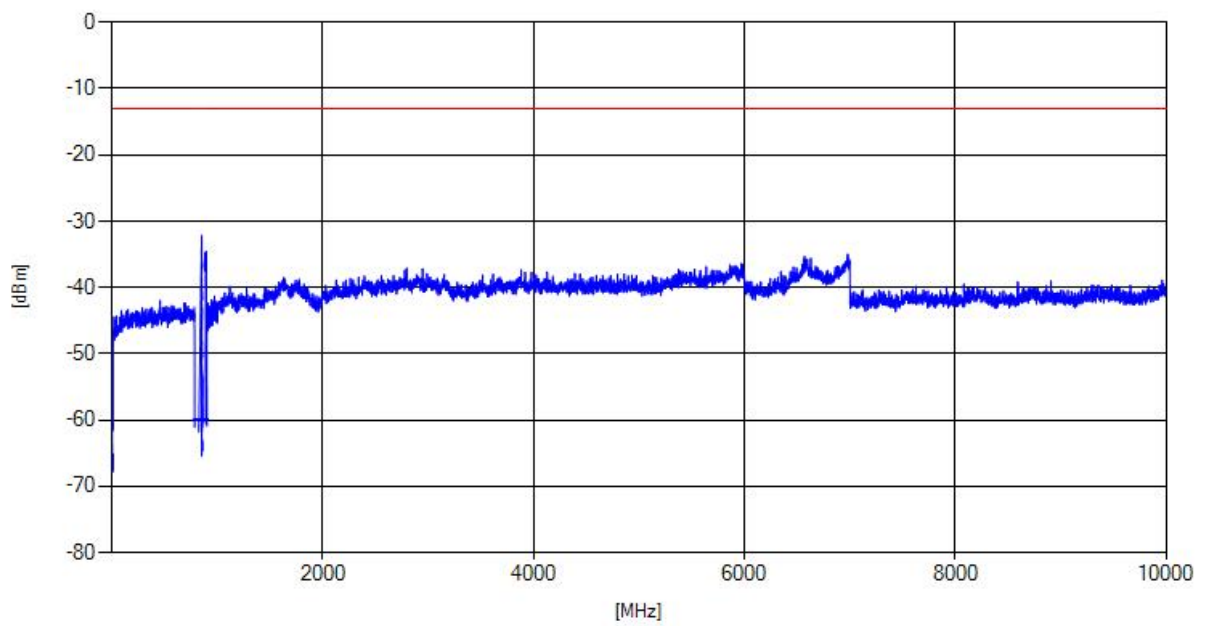

eFDD 26 QPSK, Channel = low

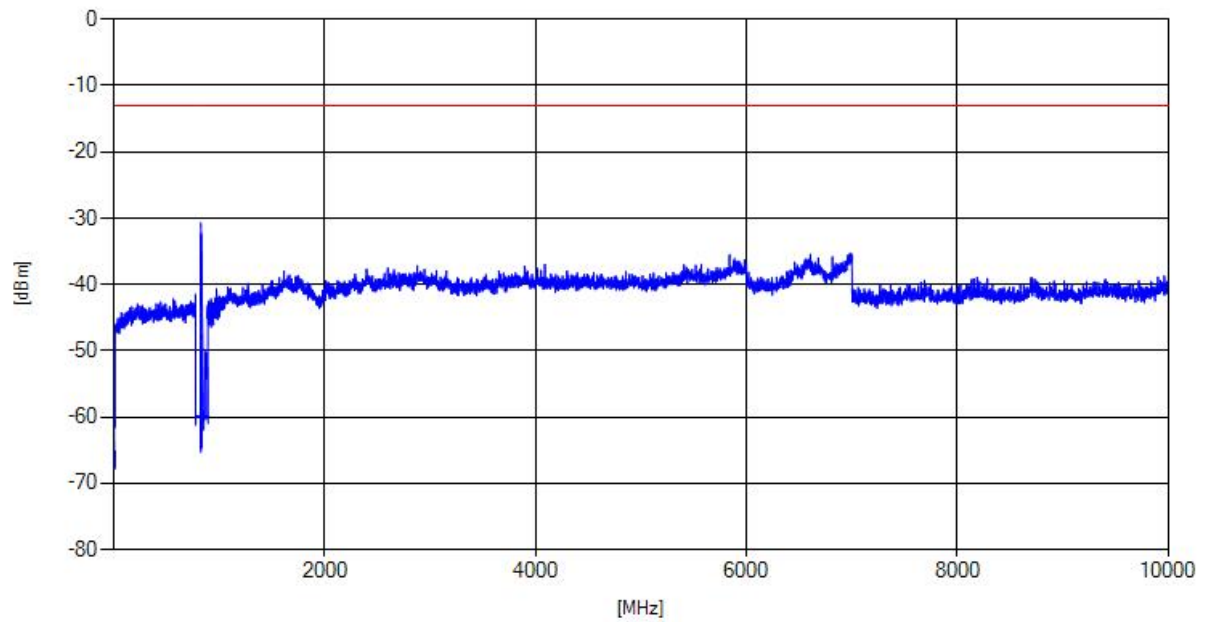

5.3.5 TEST EQUIPMENT USED

- Radio Lab

5.4 FIELD STRENGTH OF SPURIOUS RADIATION

Standard **FCC PART 22 Subpart H**

The test was performed according to:
ANSI C63.26: 2015

5.4.1 TEST DESCRIPTION

This test case is intended to demonstrate compliance to the applicable radiated spurious emission measurements per § 2.1053 and RSS-GEN 6.13. The limit and requirements come from the applicable rule part and ISED RSS-Standard for the operating band of the cellular device.

The EUT was connected to the test setup according to the following diagram:

Frequency Range: 30 MHz – 1 GHz:

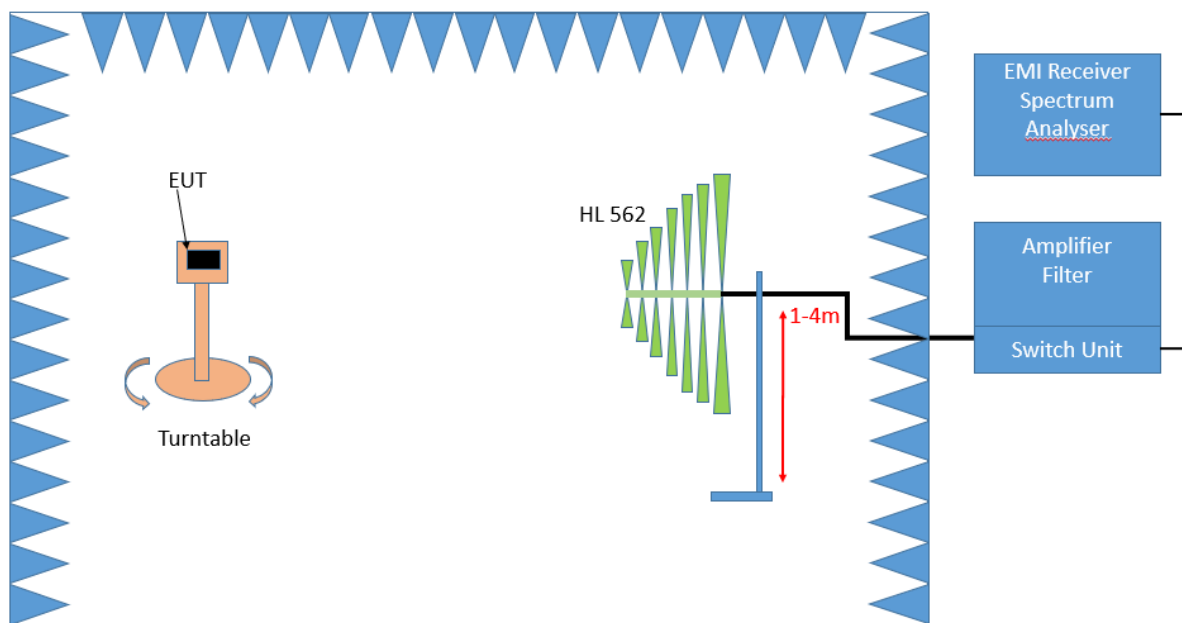

Test Setup; Spurious Emission Radiated (SAC), 30 MHz- 1GHz

Frequency Range: 1 GHz – 26.5 GHz

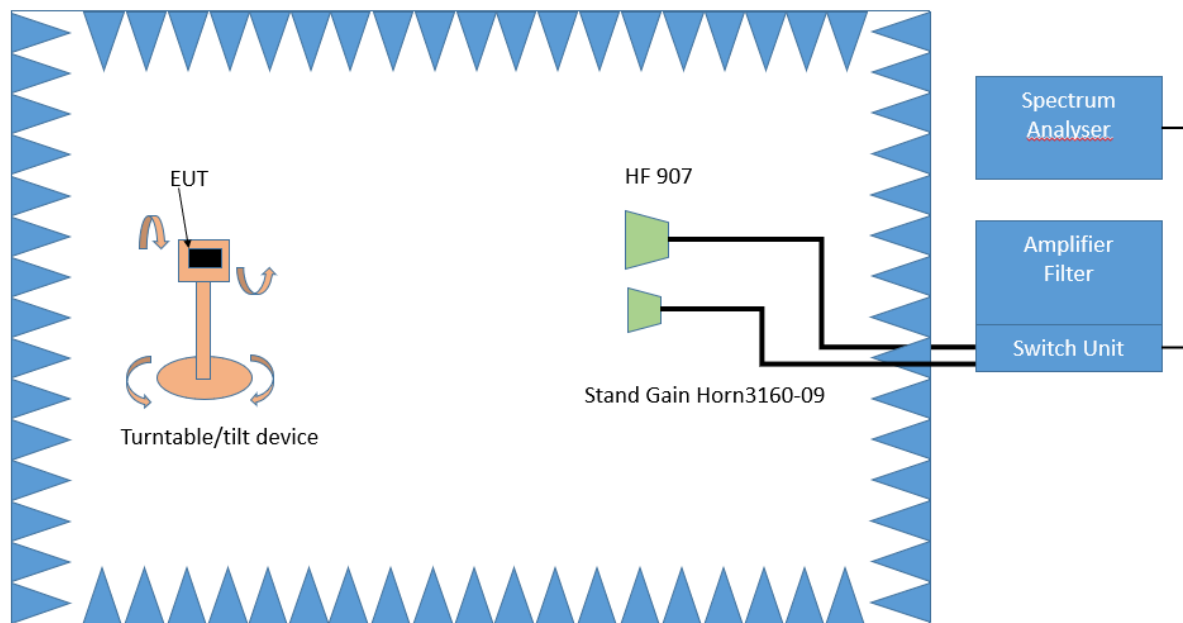

Test Setup; Spurious Emission Radiated (FAC), 1 GHz-26.5 GHz

The test set-up was made in accordance to the general provisions of ANSI C63.26 in a typical installation configuration. The Equipment Under Test (EUT) was set up on a non-conductive table 1.0 x 2.0 m² in the semi-anechoic chamber. The influence of the EUT support table that is used between 30–1000 MHz was evaluated.

The measurement procedure is implemented into the EMI test software EMC32 from R&S. Exploratory tests are performed at 3 orthogonal axes to determine the worst-case orientation of a body-worn or handheld EUT. The final test on all kind of EUTs is also performed at 3 axes. A pre-check is performed while the EUT is powered from a DC power source.

1. Measurement above 30 MHz and up to 1 GHz

Step 1: Preliminary scan

This is a preliminary test to identify the highest amplitudes relative to the limit.

Settings for step 1:

- Antenna distance: 3 m
- Detector: Peak
- RBW: 100 kHz
- VBW: 300 kHz
- Sweep time: coupled
- Turntable angle range: -180° to 90°
- Turntable step size: 90°
- Height variation range: 1 – 4 m
- Height variation step size: 1.5 m
- Polarisation: Horizontal + Vertical

Intention of this step is, to determine the radiated EMI-profile of the EUT. Afterwards the relevant emissions for the final measurement are identified.

Step 2: Adjustment measurement

In this step the accuracy of the turntable azimuth and antenna height will be improved. This is necessary to find out the maximum value of every frequency.

For each frequency, which was determined the turntable azimuth and antenna height will be adjusted. The turntable azimuth will slowly vary by 360° . During this action, the value of emission is continuously measured. The turntable azimuth at the highest emission will be

recorded and adjusted. In this position, the antenna height will also slowly vary from 1 – 4 m. During this action, the value of emission is also continuously measured. The antenna height of the highest emission will also be recorded and adjusted.

- Detector: Peak
- Measured frequencies: in step 1 determined frequencies
- RBW: 100 kHz
- VBW: 300 kHz
- Sweep time: coupled
- Turntable angle range: 360°
- Height variation range: 1 – 4 m
- Antenna Polarisation: max. value determined in step 1

Step 3: Final measurement with RMS detector

With the settings determined in step 3, the final measurement will be performed:

EMI receiver settings for step 4:

- Detector: RMQ
- Measured frequencies: in step 1 determined frequencies
- RBW: 100 kHz
- VBW: 300 kHz
- Sweep time: 1 s

After the measurement a plot will be generated which contains a diagram with the results of the preliminary scan and a chart with the frequencies and values of the results of the final measurement.

3. Measurement above 1 GHz

The following modifications apply to the measurement procedure for the frequency range above 1 GHz:

Step 1:

The Equipment Under Test (EUT) was set up on a non-conductive support (tilt device) at 1.5 m height in the fully-anechoic chamber.

All steps were performed with one height (1.5 m) of the receiving antenna only.

The EUT is turned during the preliminary measurement across the elevation axis, with a step size of 90 °.

The turn table step size (azimuth angle) for the preliminary measurement is 45 °.

- Antenna distance: 3 m
- Detector: Peak
- RBW: 1 MHz
- VBW: 3 MHz
- Sweep time: coupled
- Turntable angle range: -180° to 90°
- Turntable step size: 90°
- Polarisation: Horizontal + Vertical

Step 2:

Due to the fact, that in this frequency range the test is performed in a fully anechoic room, the height scan of the receiving antenna instep 2 is omitted. Instead of this, a maximum search with a step size $\pm 45^\circ$ for the elevation axis is performed.

The turn table azimuth will slowly vary by $\pm 22.5^\circ$.

The elevation angle will slowly vary by $\pm 45^\circ$

EMI receiver settings (for all steps):

- Detector: Peak,
- RBW: 1 MHz
- VBW: 3 MHz
- Sweep time: coupled

Step 3:

Spectrum analyser settings for step 3:

- Detector: RMS
- Measured frequencies: in step 1 determined frequencies
- RBW: 1 MHz
- VBW: 3 MHz
- Sweep Time: 1 s

5.4.2 TEST REQUIREMENTS / LIMITS

FCC Part 2.1053; Measurement required: Field strength of spurious radiation:

Measurements shall be made to detect spurious emissions that may be radiated directly from the cabinet, control circuits, power leads, or intermediate circuit elements under normal conditions of installation and operation. Curves or equivalent data shall be supplied showing the magnitude of each harmonic and other spurious emission. For this test, single sideband, independent sideband, and controlled carrier transmitters shall be modulated under the conditions specified in paragraph (c) of §2.1049, as appropriate.

Part 22, Subpart H – Cellular Radiotelephone Service**§ 22 917 – Emission limitations for cellular equipment**

(a) *Out of band emissions.* The power of any emission outside of the authorized operating frequency ranges must be attenuated below the transmitting power (P) by a factor of at least $43 + 10 \log(P)$ dB.

RSS-132; 5.5 Transmitter Unwanted Emissions

Mobile and base station equipment shall comply with the limits in (i) and (ii) below.

1. In the first 1.0 MHz band immediately outside and adjacent to each of the sub-bands specified in Section 5.1, the power of emissions per any 1% of the occupied bandwidth shall be attenuated (in dB) below the transmitter output power P (dBW) by at least $43 + 10 \log_{10} p$ (watts).
2. After the first 1.0 MHz immediately outside and adjacent to each of the sub-bands, the power of emissions in any 100 kHz bandwidth shall be attenuated (in dB) below the transmitter output power P (dBW) by at least $43 + 10 \log_{10} p$ (watts). If the measurement is performed using 1% of the occupied bandwidth, power integration over 100 kHz is required.

5.4.3 TEST PROTOCOL

Ambient temperature: 20 - 28 °C
 Relative humidity: 30 - 45 %

Radio Technology	Channel	Detector	Trace	Resolution Bandwidth /kHz	Frequency /MHz	Peak Value /dBm	Limit /dBm	Margin to Limit /dB
GSM 850	low	rms	maxhold	-	-	-	-13	>20
GSM 850	mid	rms	maxhold	-	-	-	-13	>20
GSM 850	high	rms	maxhold	3	849	-34.23	-13	21.23

Radio Technology	Channel	Detector	Trace	Resolution Bandwidth /kHz	Frequency /MHz	Peak Value /dBm	Limit /dBm	Margin to Limit /dB
EDGE 850	low	rms	maxhold	-	-	-	-13	>20
EDGE 850	mid	rms	maxhold	-	-	-	-13	>20
EDGE 850	high	peak	maxhold	3	849.0	-25.29	-13	12.29

Radio Technology	Channel	Detector	Trace	Resolution Bandwidth /kHz	Frequency /MHz	Peak Value /dBm	Limit /dBm	Margin to Limit /dB
FDD5 WCDMA	low	rms	maxhold	50	823.9	-27.91	-13	14.91
FDD5 WCDMA	mid	rms	maxhold	-	-	-	-13	>20
FDD5 WCDMA	high	rms	maxhold	50	849	-32.28	-13	19.28

Radio Technology	Channel	Detector	Trace	Resolution Bandwidth /kHz	Frequency /MHz	Peak Value /dBm	Limit /dBm	Margin to Limit /dB
FDD5 HSDPA	low	rms	maxhold	50	823.8	-34.41	-13	21.41
FDD5 HSDPA	mid	rms	maxhold	-	-	-	-13	>20
FDD5 HSDPA	high	rms	maxhold	-	-	-	-13	>20

Radio Technology	Channel	Detector	Trace	Resolution Bandwidth /kHz	Frequency /MHz	Peak Value /dBm	Limit /dBm	Margin to Limit /dB
FDD5 HSUPA	low	rms	maxhold	50	824	-30.38	-13	17.38
FDD5 HSUPA	mid	rms	maxhold	-	-	-	-13	>20
FDD5 HSUPA	high	rms	maxhold	-	-	-	-13	>20

Radio Technology	Channel	Detector	Trace	Resolution Bandwidth /kHz	Frequency /MHz	Peak Value /dBm	Limit /dBm	Margin to Limit /dB
eFDD5 QPSK	low	rms	maxhold	50	823.9	-25.29	-13	12.29
eFDD5 QPSK	mid	rms	maxhold	-	-	-	-13	>20
eFDD5 QPSK	high	rms	maxhold	50	849.0	-26.06	-13	13.06

Radio Technology	Channel	Detector	Trace	Resolution Bandwidth /kHz	Frequency /MHz	Peak Value /dBm	Limit /dBm	Margin to Limit /dB
eFDD26 QPSK	low	rms	maxhold	50	823.9	-24.23	-13	11.23
eFDD26 QPSK	mid	rms	maxhold	-	-	-	-13	>20
eFDD26 QPSK	high	rms	maxhold	50	849.0	-25.94	-13	12.94

Remark: Please see next sub-clause for the measurement plot.

5.4.4 MEASUREMENT PLOT (EXAMPLE PLOT, SHOWING WORST CASE, IF APPLICABLE)

GSM 850, Channel = high
30 MHz – 1 GHz

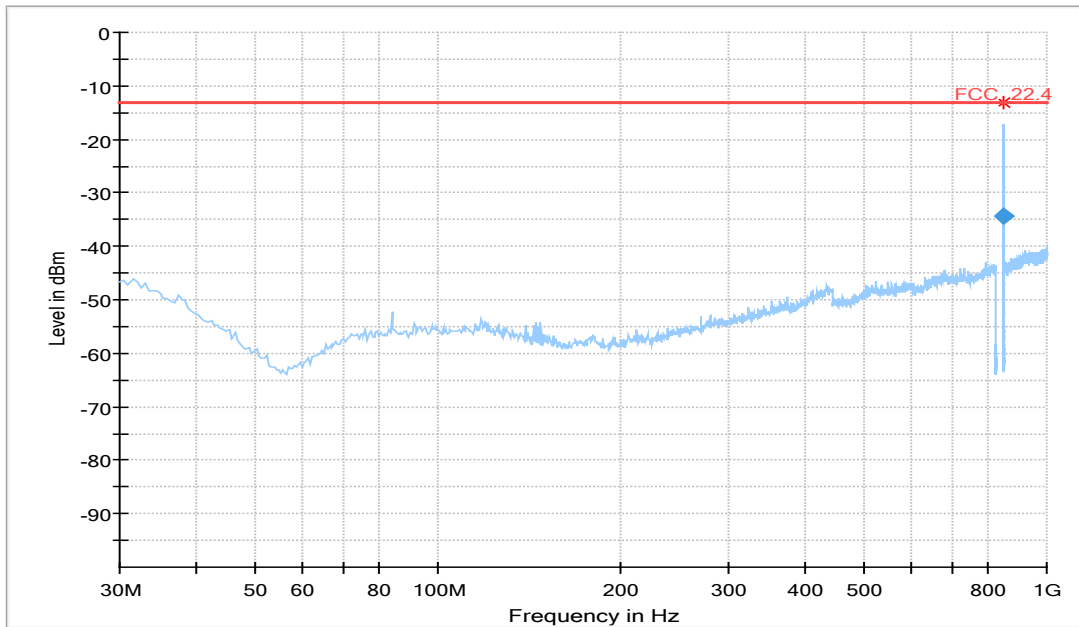

Frequency (MHz)	RMS (dBm)	Limit (dBm)	Margin (dB)	Meas. Time (ms)	Bandwidth (kHz)	Height (cm)	Pol	Azimuth (deg)	Corr. (dB)
849.002000	-34.23	-13.00	21.23	1000.0	3.000	108.0	H	-190.0	-73.9

1 GHz – 10 GHz

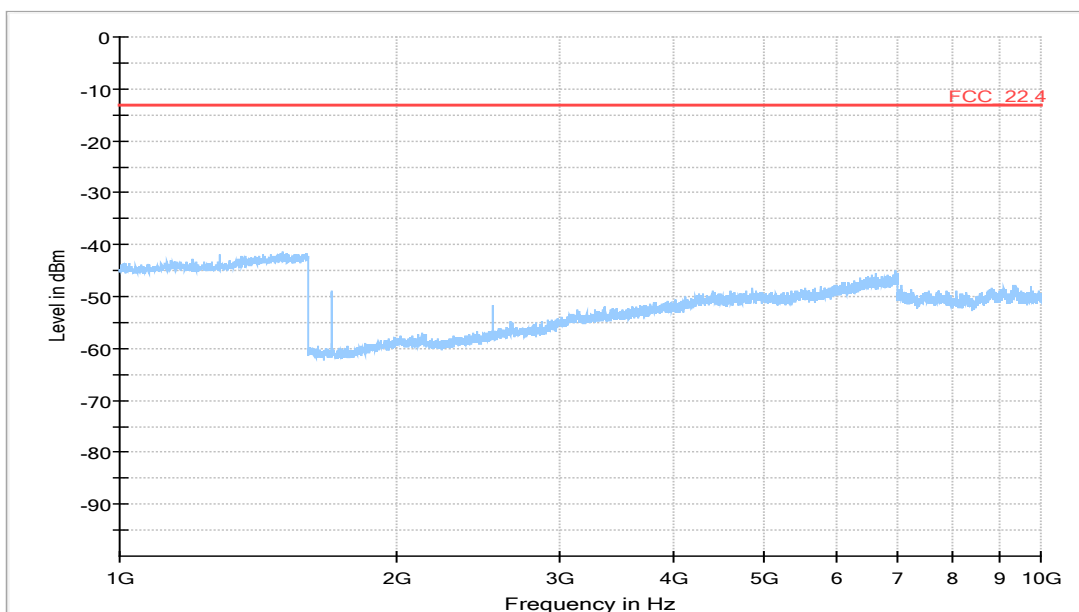

EDGE 850, Channel = high
30 MHz - 1 GHz

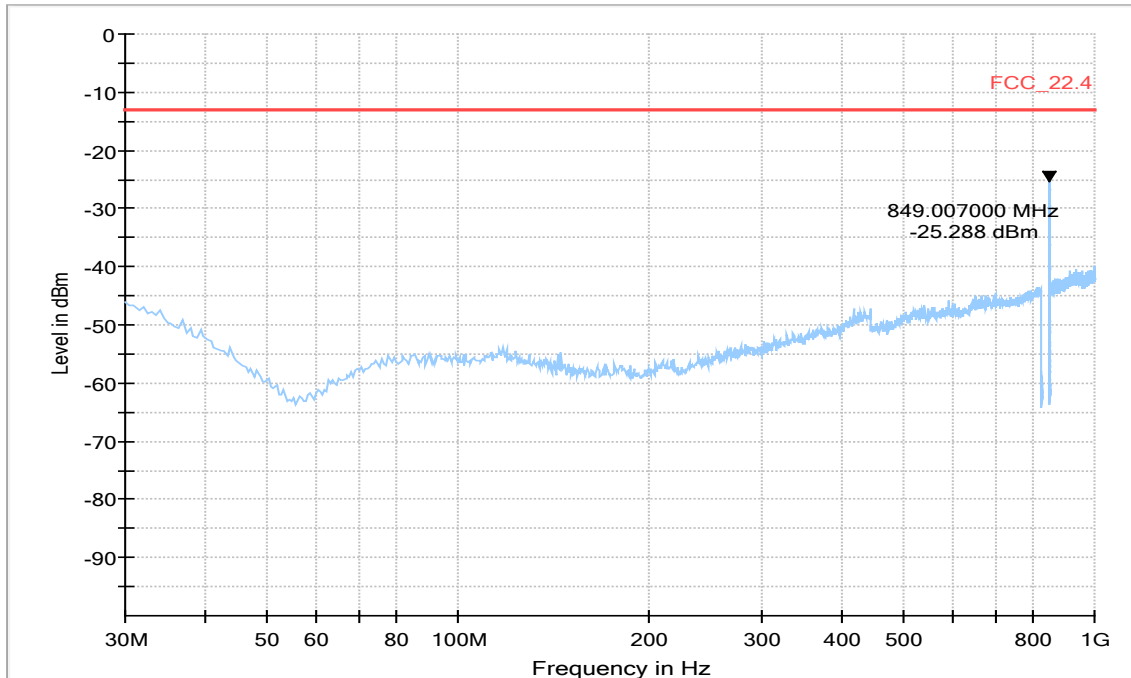

1 GHz - 10 GHz

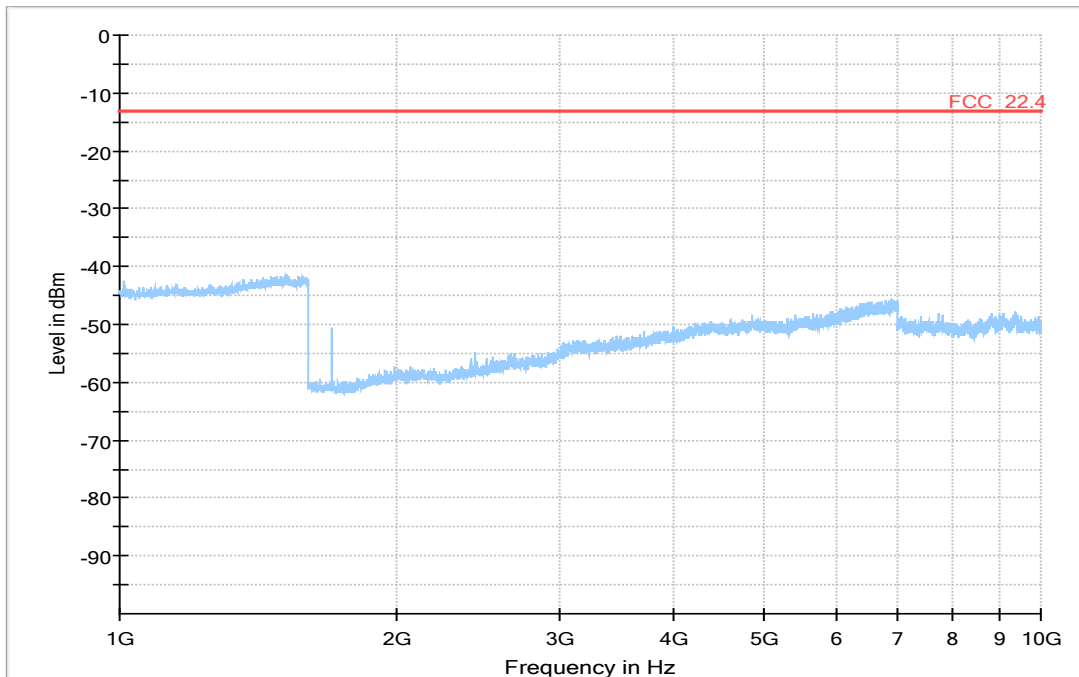

WCDMA FDD 5, Channel = low
30 MHz – 1 GHz

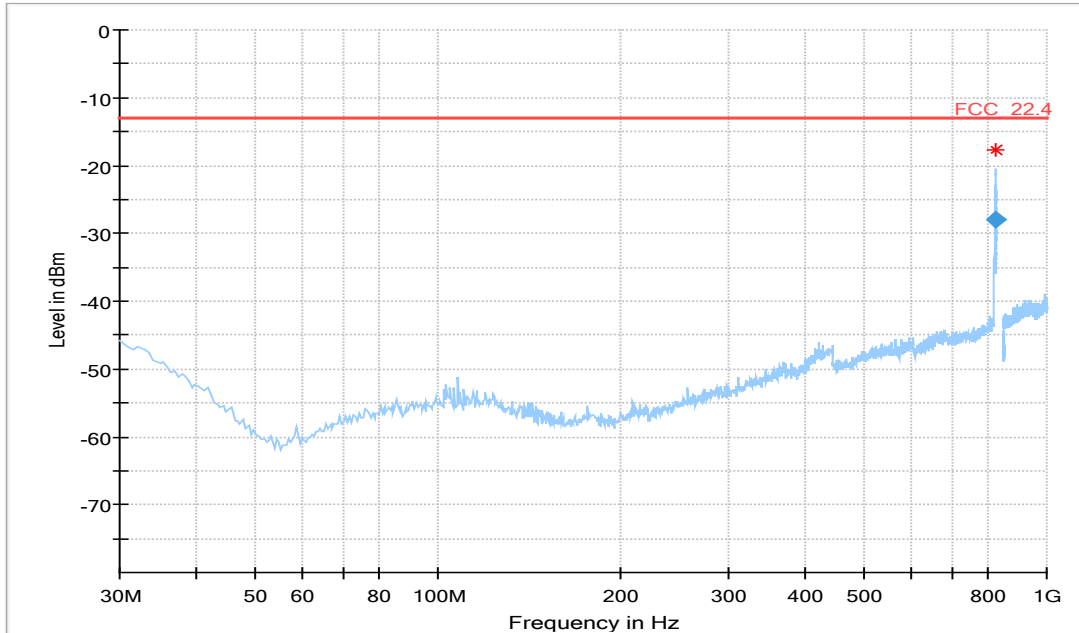

Frequency (MHz)	RMS (dBm)	Limit (dBm)	Margin (dB)	Meas. Time (ms)	Bandwidth (kHz)	Height (cm)	Pol	Azimuth (deg)	Corr. (dB)
823.998000	-27.91	-13.00	14.91	1000.0	50.000	107.0	V	-199.0	-73.1

1 GHz – 10 GHz

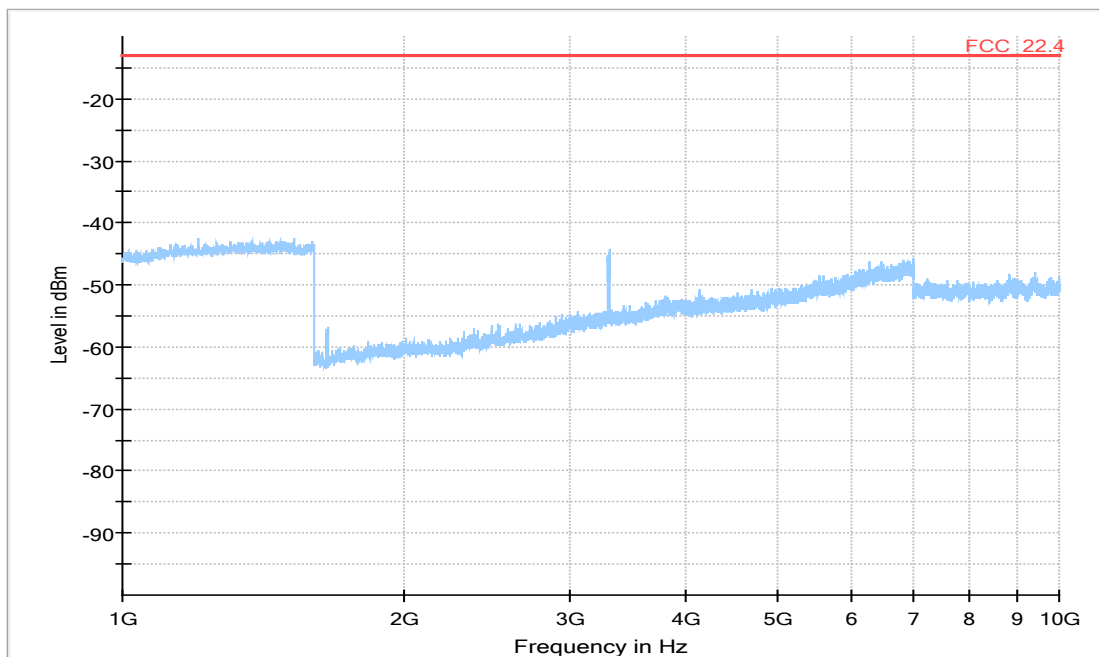

HSDPA FDD 5, Channel = low
30 MHz – 1 GHz

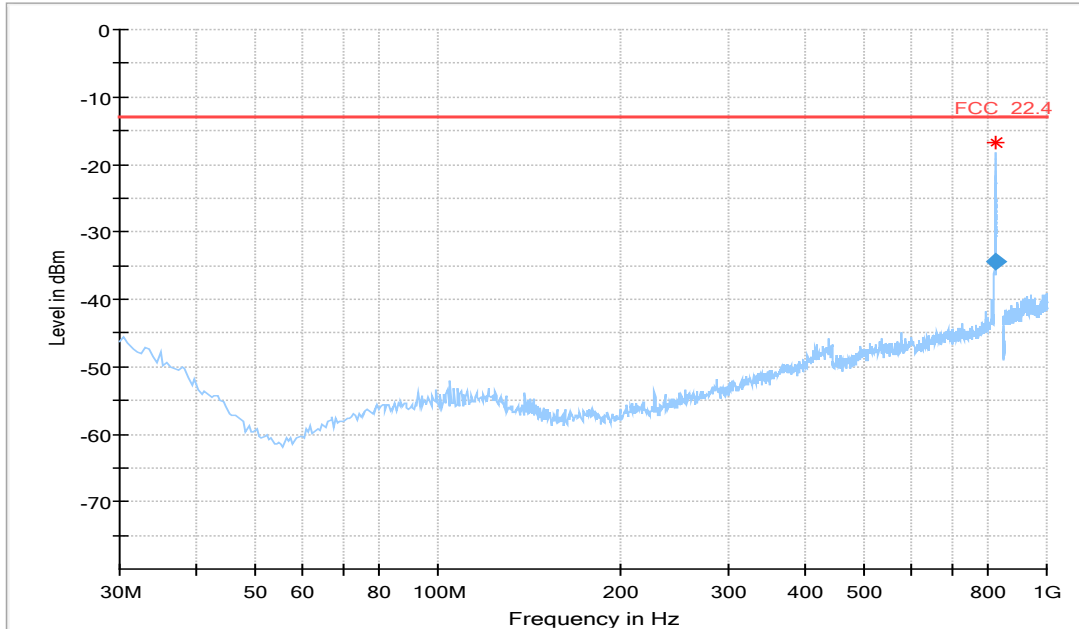

Frequency (MHz)	RMS (dBm)	Limit (dBm)	Margin (dB)	Meas. Time (ms)	Bandwidth (kHz)	Height (cm)	Pol	Azimuth (deg)	Corr. (dB)
823.776000	-34.41	-13.00	21.41	1000.0	50.000	127.0	V	81.0	-73.1

1 GHz – 10 GHz

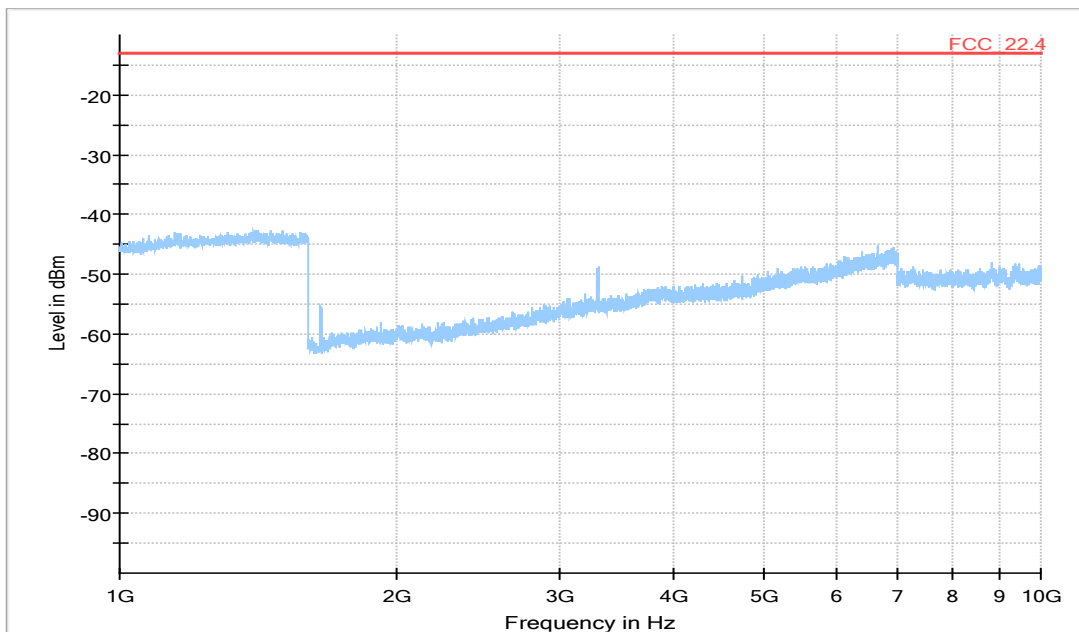

HSUPA FDD 5, Channel = low
30 MHz - 1 GHz

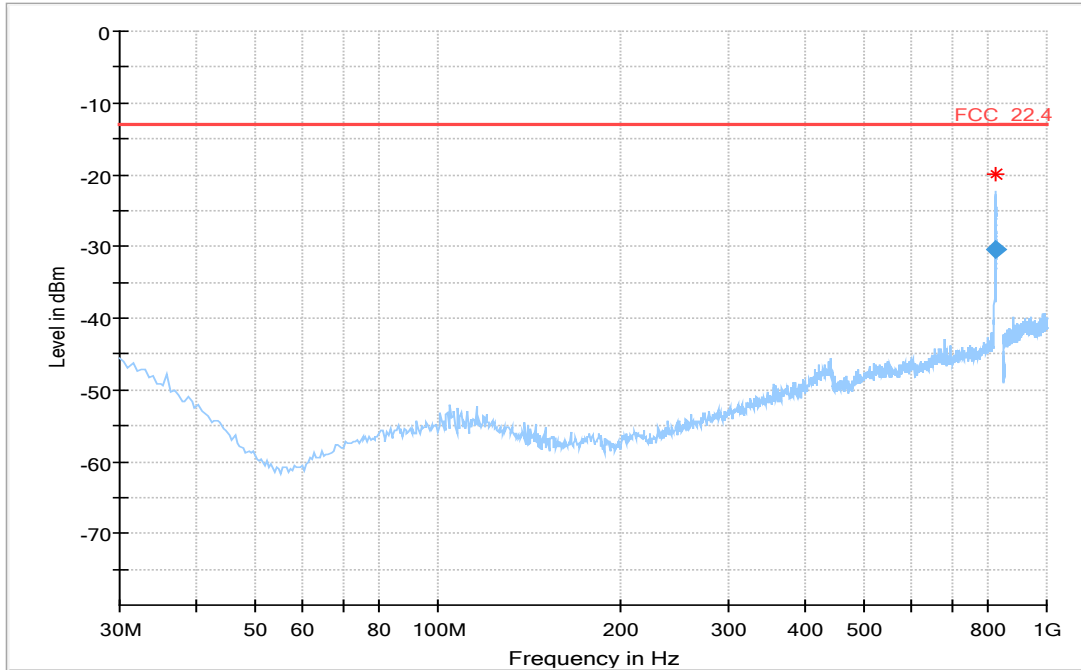

Frequency (MHz)	RMS (dBm)	Limit (dBm)	Margin (dB)	Meas. Time (ms)	Bandwidth (kHz)	Height (cm)	Pol	Azimuth (deg)	Corr. (dB)
824.000000	-30.38	-13.00	17.38	1000.0	50.000	103.0	H	-168.0	-73.1

1 GHz - 10 GHz

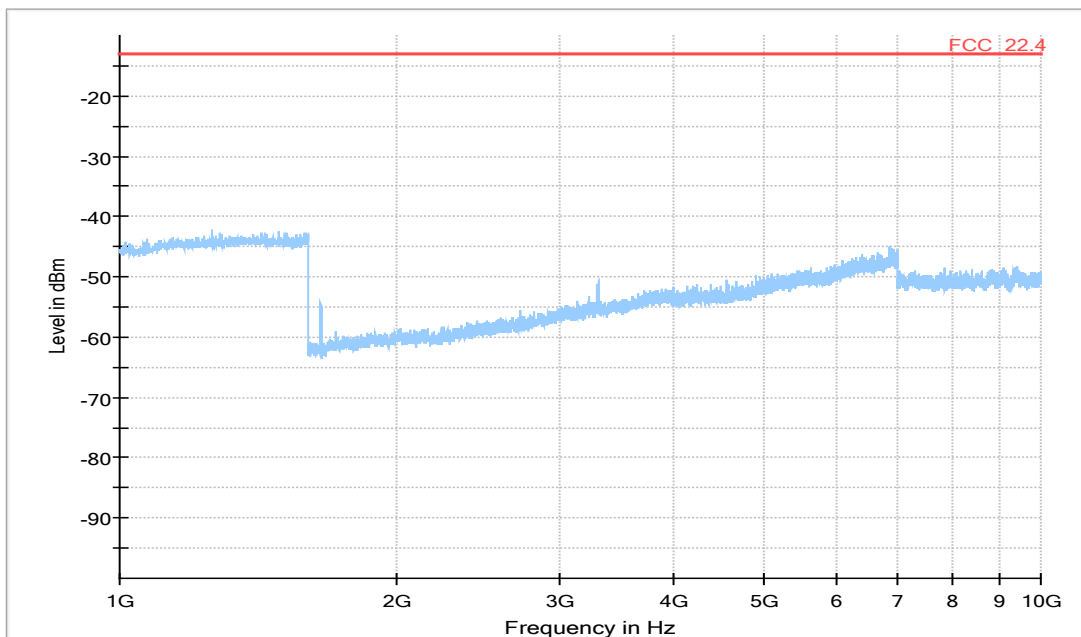

LTE eFDD 5, Channel = low
30 MHz - 1 GHz

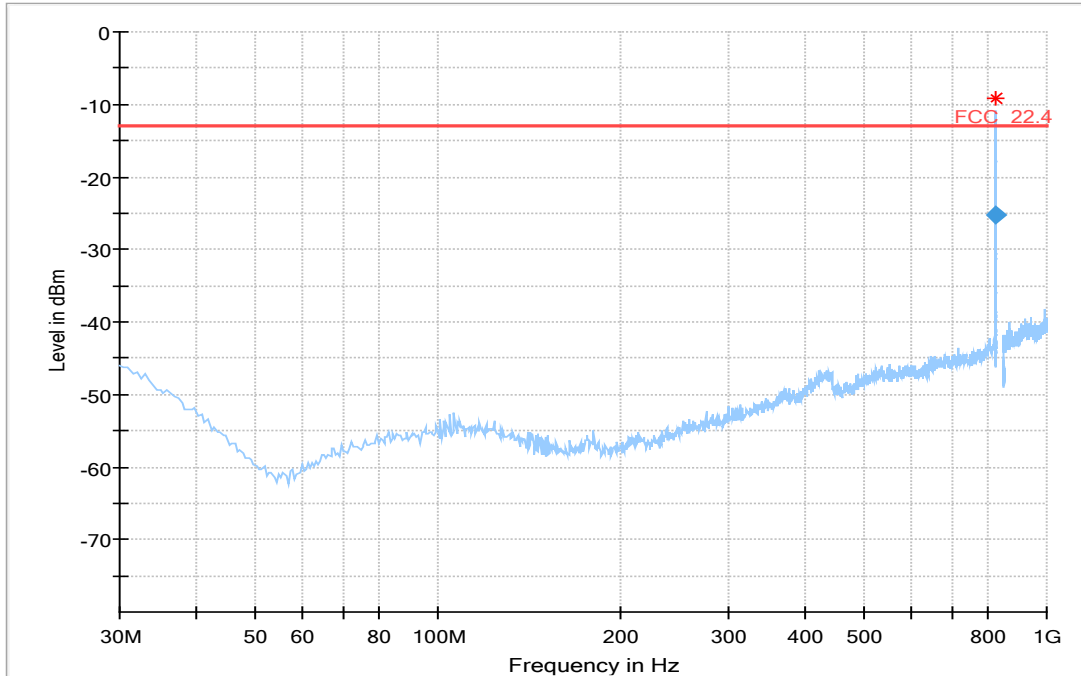

Frequency (MHz)	RMS (dBm)	Limit (dBm)	Margin (dB)	Meas. Time (ms)	Bandwidth (kHz)	Height (cm)	Pol	Azimuth (deg)	Corr. (dB)
823.999000	-25.29	-13.00	12.29	1000.0	50.000	103.0	H	-169.0	-73.1

1 GHz - 10 GHz

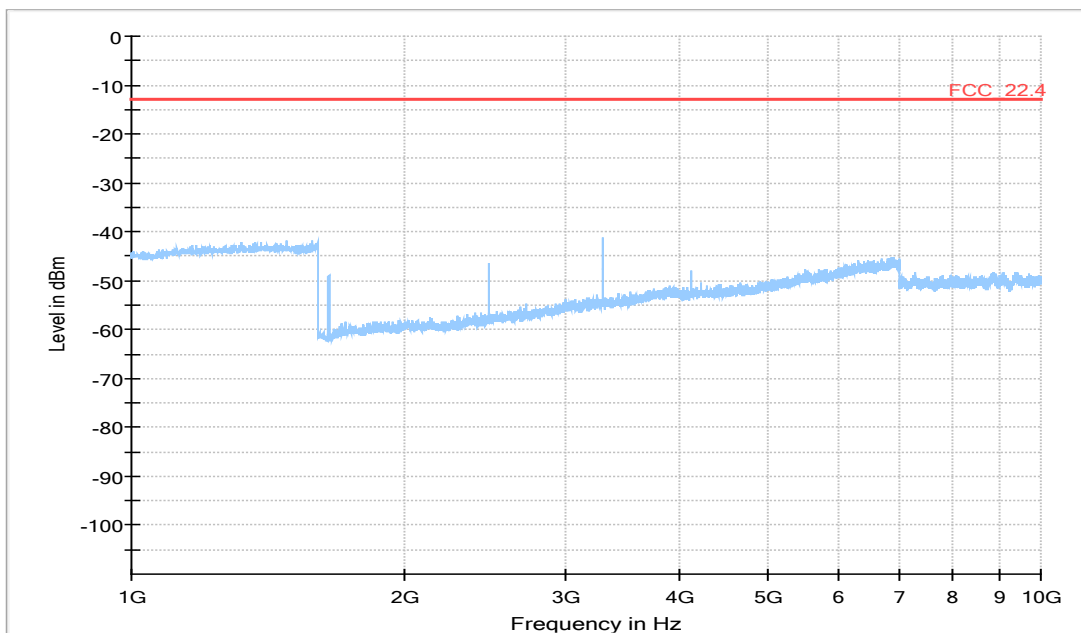

LTE eFDD 26, Channel = low
30 MHz - 1 GHz

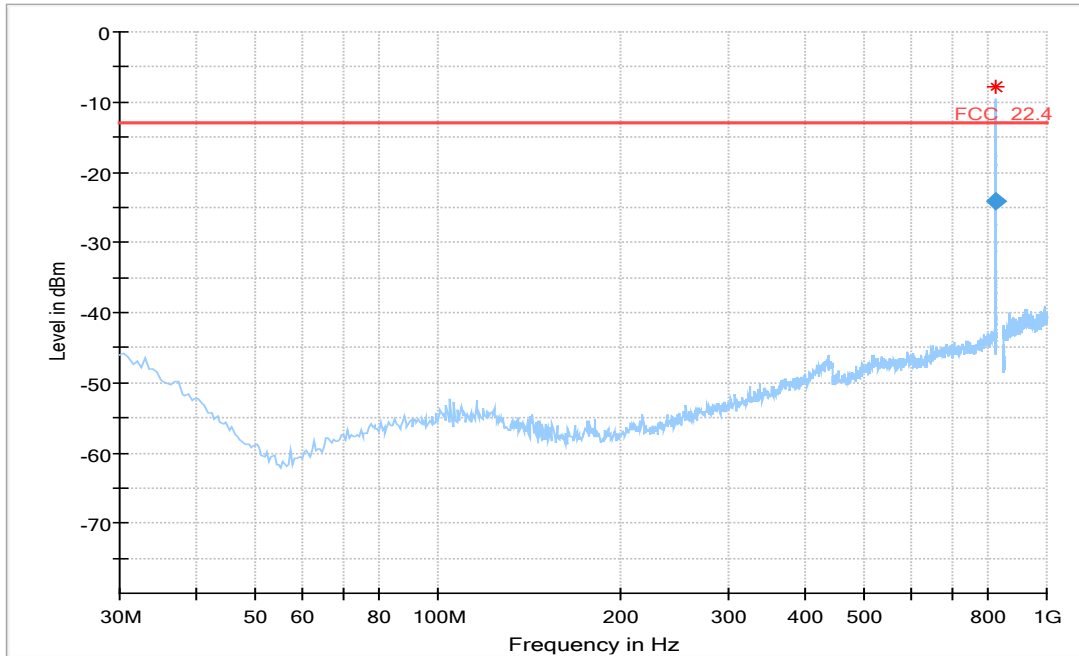

Frequency (MHz)	RMS (dBm)	Limit (dBm)	Margin (dB)	Meas. Time (ms)	Bandwidth (kHz)	Height (cm)	Pol	Azimuth (deg)	Corr. (dB)
823.996000	-24.23	-13.00	11.23	1000.0	50.000	103.0	H	-168.0	-73.1

1 GHz - 10 GHz

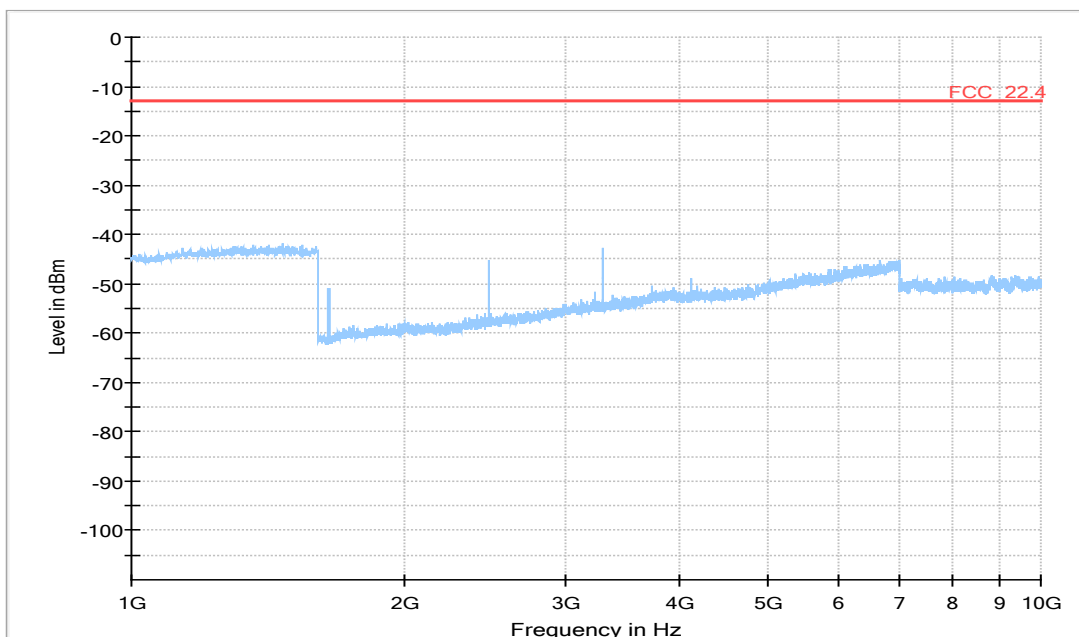

5.4.5 TEST EQUIPMENT USED

- Radiated Emissions

5.5 EMISSION AND OCCUPIED BANDWIDTH

Standard **FCC PART 22 Subpart H**

The test was performed according to:
ANSI C63.26: 2015

5.5.1 TEST DESCRIPTION

This test case is intended to demonstrate compliance to the applicable conducted spurious emission test case per FCC §2.1049 and RSS-GEN 6.7. The limit and the requirements come from the applicable rule part and ISED RSS-Standard for the operating band of the cellular device.

The EUT was connected to the test setups according to the following diagram:

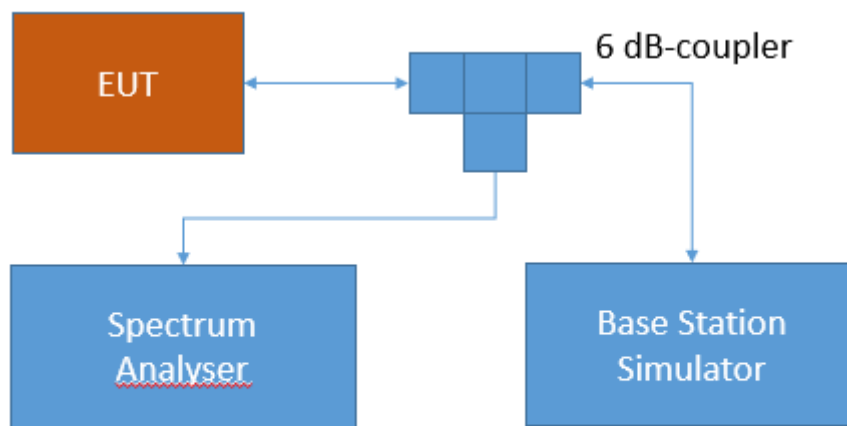

Test Setup FCC Part 22/24/27/90 Cellular;
Spurious Emissions at antenna terminal

The attenuation of the measuring and stimulus path are known for each measured frequency and are considered.

The Spectrum Analyzer settings can be directly found in the measurement diagrams.

5.5.2 TEST REQUIREMENTS / LIMITS

FCC Part 2.1049; Occupied Bandwidth:

The occupied bandwidth, that is the frequency bandwidth such that, below its lower and above its upper frequency limits, the mean powers radiated are each equal to 0.5 percent of the total mean power radiated by a given emission shall be measured under the following conditions as applicable:

(h) Transmitters employing digital modulation techniques—when modulated by an input signal such that its amplitude and symbol rate represent the maximum rated conditions under which the equipment will be operated. The signal shall be applied through any filter networks, pseudo-random generators or other devices required in normal service. Additionally, the occupied bandwidth shall be shown for operation with any devices used for modifying the spectrum when such devices are optional at the discretion of the user.

(i) Transmitters designed for other types of modulation—when modulated by an appropriate signal of sufficient amplitude to be representative of the type of service in which used. A description of the input signal should be supplied.

RSS-GEN; 6.6 Occupied Bandwidth

The emission bandwidth (\times dB) is defined as the frequency range between two points, one above and one below the carrier frequency, at which the spectral density of the emission is attenuated \times dB below the maximum in-band spectral density of the modulated signal. Spectral density (power per unit bandwidth) is to be measured with a detector of resolution bandwidth in the range of 1% to 5% of the anticipated emission bandwidth, and a video bandwidth at least $3\times$ the resolution bandwidth.

When the occupied bandwidth limit is not stated in the applicable RSS or reference measurement method, the transmitted signal bandwidth shall be reported as the 99% emission bandwidth, as calculated or measured.

5.5.3 TEST PROTOCOL

Ambient temperature: 20 - 28 °C
 Relative humidity: 30 - 45 %

Radio Technology	Channel	Re-source Blocks	Bandwidth [MHz]	Nominal BW [MHz]	26 dB BW [kHz]	99 % BW [kHz]
GSM 850	low	-	0.2	0.2	312.63	246.49
GSM 850	mid	-	0.2	0.2	308.62	244.49
GSM 850	high	-	0.2	0.2	310.62	242.48
GSM 850 EDGE	low	-	0.2	0.2	288.58	230.46
GSM 850 EDGE	mid	-	0.2	0.2	292.59	226.45
GSM 850 EDGE	high	-	0.2	0.2	294.59	234.47
FDD V	low	-	5	5	4749.50	4128.26
FDD V	mid	-	5	5	4769.54	4128.26
FDD V	high	-	5	5	4749.50	4128.26
FDD V HSDPA Subtest 1	low	-	5	5	4749.50	4128.26
FDD V HSDPA Subtest 1	mid	-	5	5	4749.50	4128.26
FDD V HSDPA Subtest 1	high	-	5	5	4749.50	4108.22
FDD V HSUPA Subtest 1	low	-	5	5	4789.58	4168.34
FDD V HSUPA Subtest 1	mid	-	5	5	4769.54	4148.29
FDD V HSUPA Subtest 1	high	-	5	5	4769.54	4128.26
FDD V HSUPA Subtest 5	low	-	5	5	4809.62	4168.34
FDD V HSUPA Subtest 5	mid	-	5	5	4769.54	4148.29
FDD V HSUPA Subtest 5	high	-	5	5	4769.54	4148.29
LTE eFDD 5 QPSK	low	6	1.4	1.4	-	1112.22
LTE eFDD 5 QPSK	mid	6	1.4	1.4	-	1106.21
LTE eFDD 5 QPSK	high	6	1.4	1.4	-	1106.21
LTE eFDD 5 16QAM	low	6	1.4	1.4	-	1100.20
LTE eFDD 5 16QAM	mid	6	1.4	1.4	-	1112.22
LTE eFDD 5 16QAM	high	6	1.4	1.4	-	1100.20
LTE eFDD 5 QPSK	low	15	3	3	-	2753.51
LTE eFDD 5 QPSK	mid	15	3	3	-	2753.51
LTE eFDD 5 QPSK	high	15	3	3	-	2753.51
LTE eFDD 5 16QAM	low	15	3	3	-	2777.56
LTE eFDD 5 16QAM	mid	15	3	3	-	2741.48
LTE eFDD 5 16QAM	high	15	3	3	-	2753.51
LTE eFDD 5 QPSK	low	25	5	5	-	4529.06
LTE eFDD 5 QPSK	mid	25	5	5	-	4529.06
LTE eFDD 5 QPSK	high	25	5	5	-	4529.06
LTE eFDD 5 16QAM	low	25	5	5	-	4529.06
LTE eFDD 5 16QAM	mid	25	5	5	-	4529.06
LTE eFDD 5 16QAM	high	25	5	5	-	4549.10
LTE eFDD 5 QPSK	low	50	10	10	-	8977.96
LTE eFDD 5 QPSK	mid	50	10	10	-	9018.04
LTE eFDD 5 QPSK	high	50	10	10	-	8977.96
LTE eFDD 5 16QAM	low	12	10	10	-	2444.89

LTE eFDD 5 16QAM	mid	12	10	10	-	2525.05
LTE eFDD 5 16QAM	high	12	10	10	-	2484.97
LTE eFDD 26 QPSK	low	6	1.4	1.4	-	1106.21
LTE eFDD 26 QPSK	mid	6	1.4	1.4	-	1106.21
LTE eFDD 26 QPSK	high	6	1.4	1.4	-	1100.2
LTE eFDD 26 16QAM	low	6	1.4	1.4	-	1106.21
LTE eFDD 26 16QAM	mid	6	1.4	1.4	-	1100.20
LTE eFDD 26 16QAM	high	6	1.4	1.4	-	1100.20
LTE eFDD 26 QPSK	low	15	3	3	-	2753.51
LTE eFDD 26 QPSK	mid	15	3	3	-	2753.51
LTE eFDD 26 QPSK	high	15	3	3	-	2753.51
LTE eFDD 26 16QAM	low	15	3	3	-	2765.53
LTE eFDD 26 16QAM	mid	15	3	3	-	2741.48
LTE eFDD 26 16QAM	high	15	3	3	-	2753.51
LTE eFDD 26 QPSK	low	25	5	5	-	4529.06
LTE eFDD 26 QPSK	mid	25	5	5	-	4529.06
LTE eFDD 26 QPSK	high	25	5	5	-	4509.02
LTE eFDD 26 16QAM	low	25	5	5	-	4529.06
LTE eFDD 26 16QAM	mid	25	5	5	-	4529.06
LTE eFDD 26 16QAM	high	25	5	5	-	4529.06
LTE eFDD 26 QPSK	low	50	10	10	-	8977.96
LTE eFDD 26 QPSK	mid	50	10	10	-	9018.04
LTE eFDD 26 QPSK	high	50	10	10	-	8977.96
LTE eFDD 26 16QAM	low	12	10	10	-	2525.05
LTE eFDD 26 16QAM	mid	12	10	10	-	2525.05
LTE eFDD 26 16QAM	high	12	10	10	-	2484.97

Remark: Please see next sub-clause for the measurement plot.

5.5.4 MEASUREMENT PLOT (EXAMPLE PLOT, SHOWING WORST CASE, IF APPLICABLE)

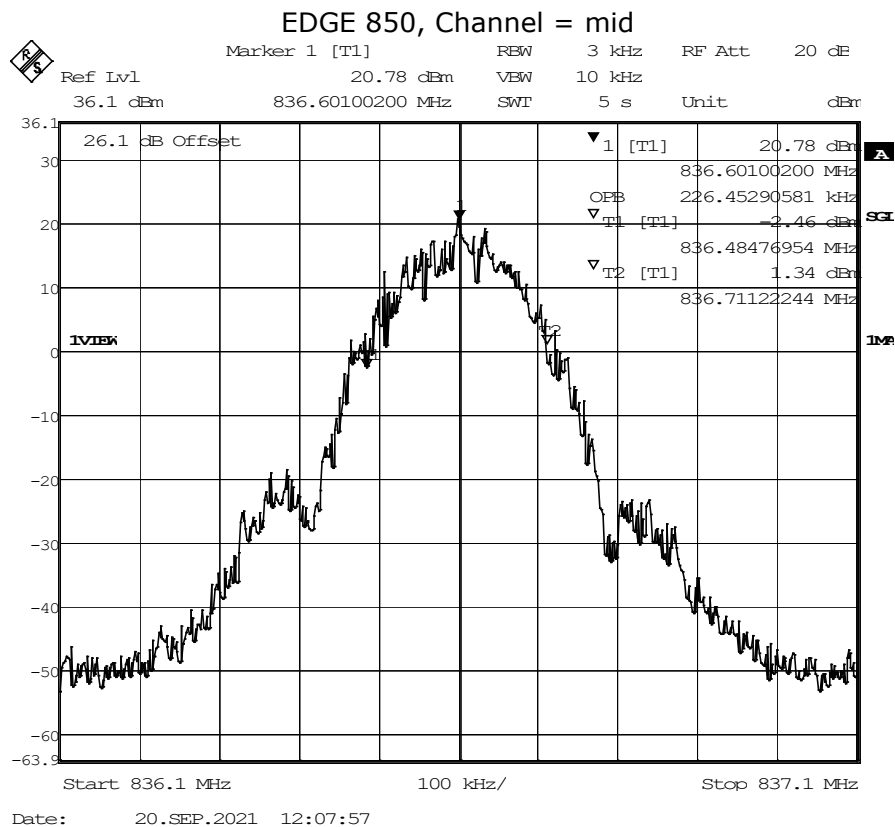
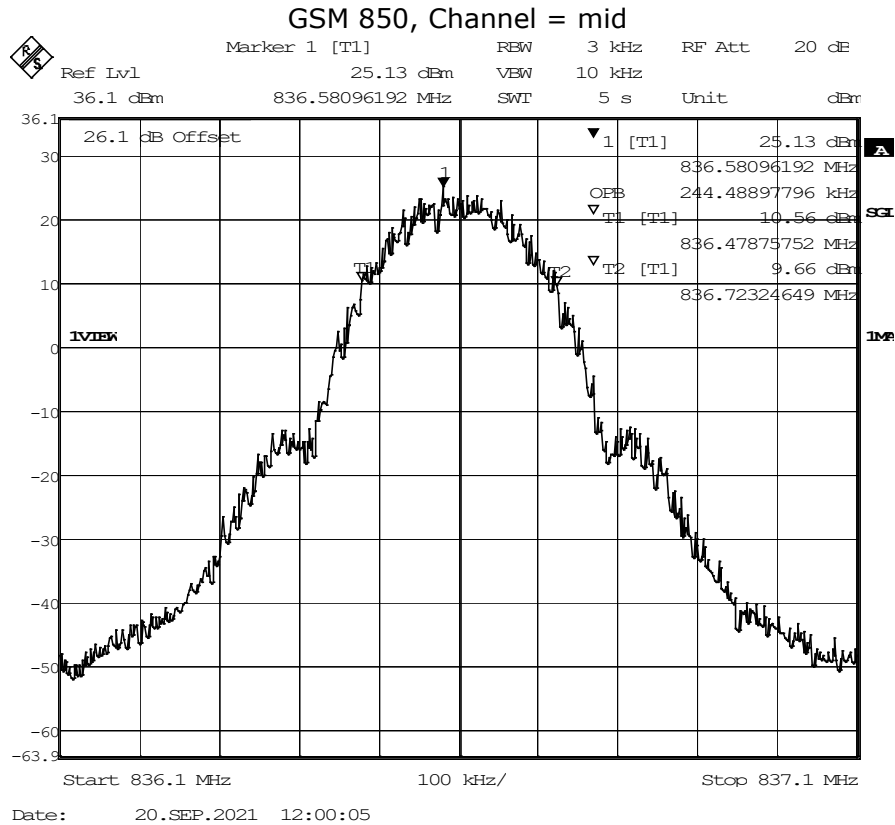

WCDMA FDD 5, Channel = mid

RF Marker 1 [T1] REW 100 kHz RF Att 20 dB
 Ref Lvl 19.71 dBm VEW 300 kHz
 36.1 dBm 835.72825651 MHz SWT 5 s Unit dBm

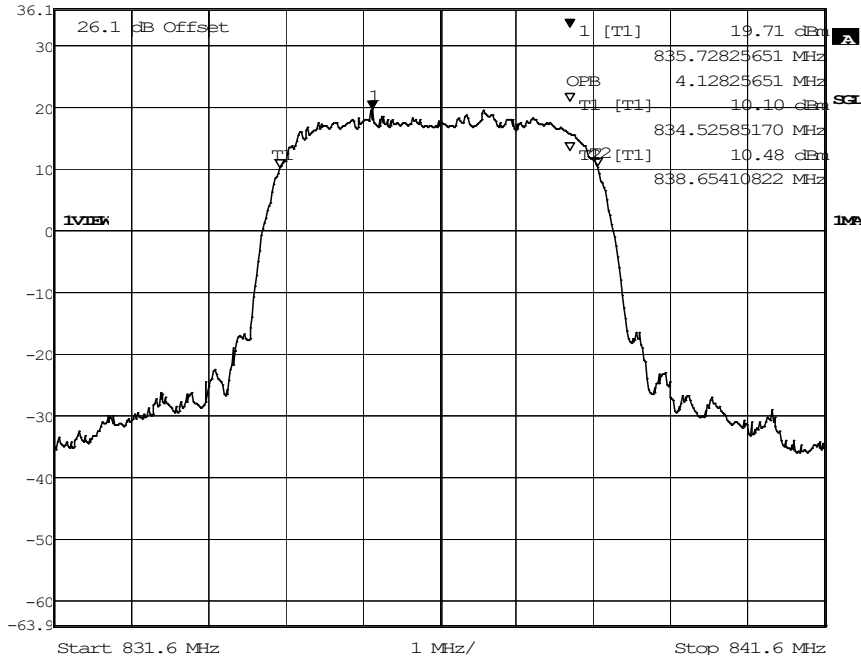

Date: 15.SEP.2021 14:22:48

HSDPA FDD 5, Channel = mid

RF Marker 1 [T1] REW 100 kHz RF Att 20 dB
 Ref Lvl 18.79 dBm VEW 300 kHz
 36.1 dBm 837.29138277 MHz SWT 5 s Unit dBm

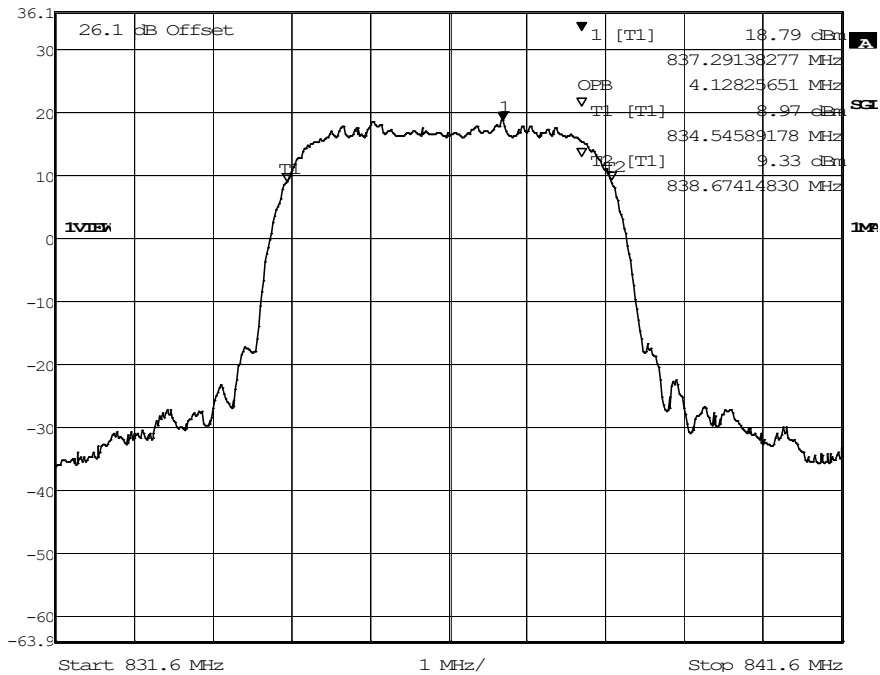

Date: 26.AUG.2021 16:25:14

HSUPA FDD 5, Channel = mid

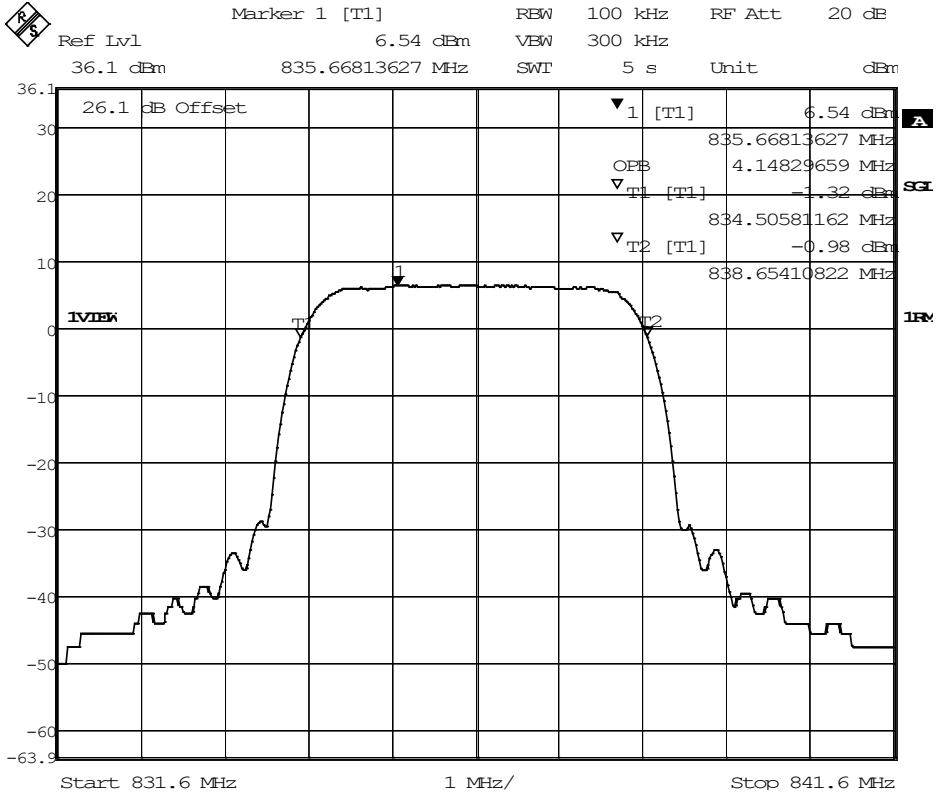

Date: 27.SEP.2021 14:16:43

LTE eFDD 5 QPSK 5 MHz, Channel = mid

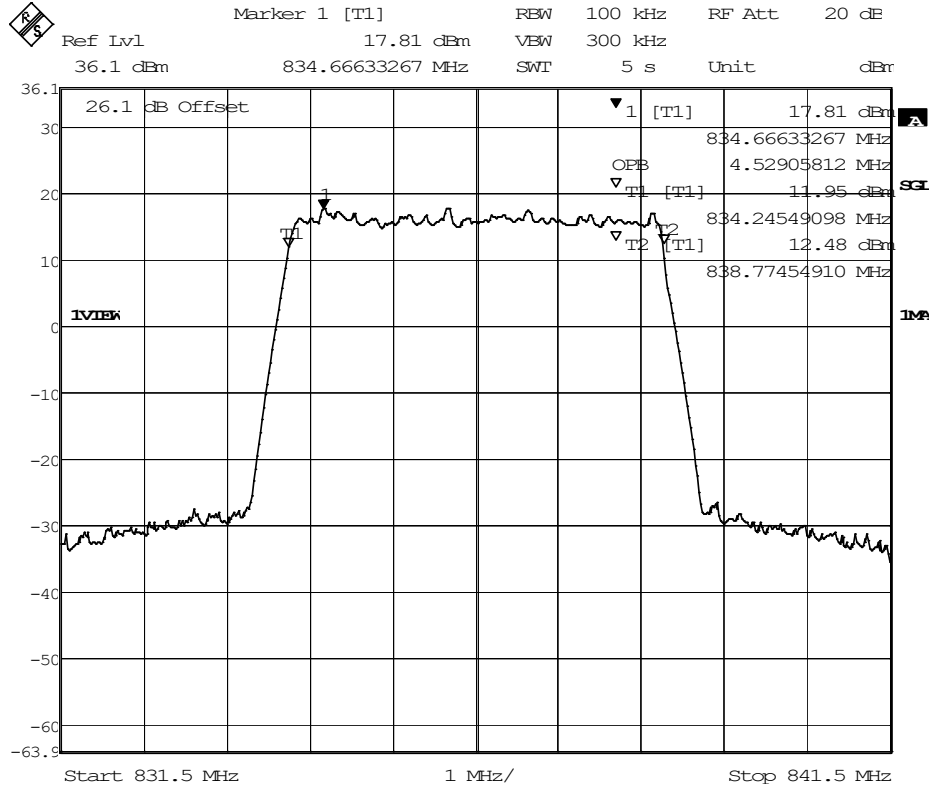

Date: 10.AUG.2021 17:10:04

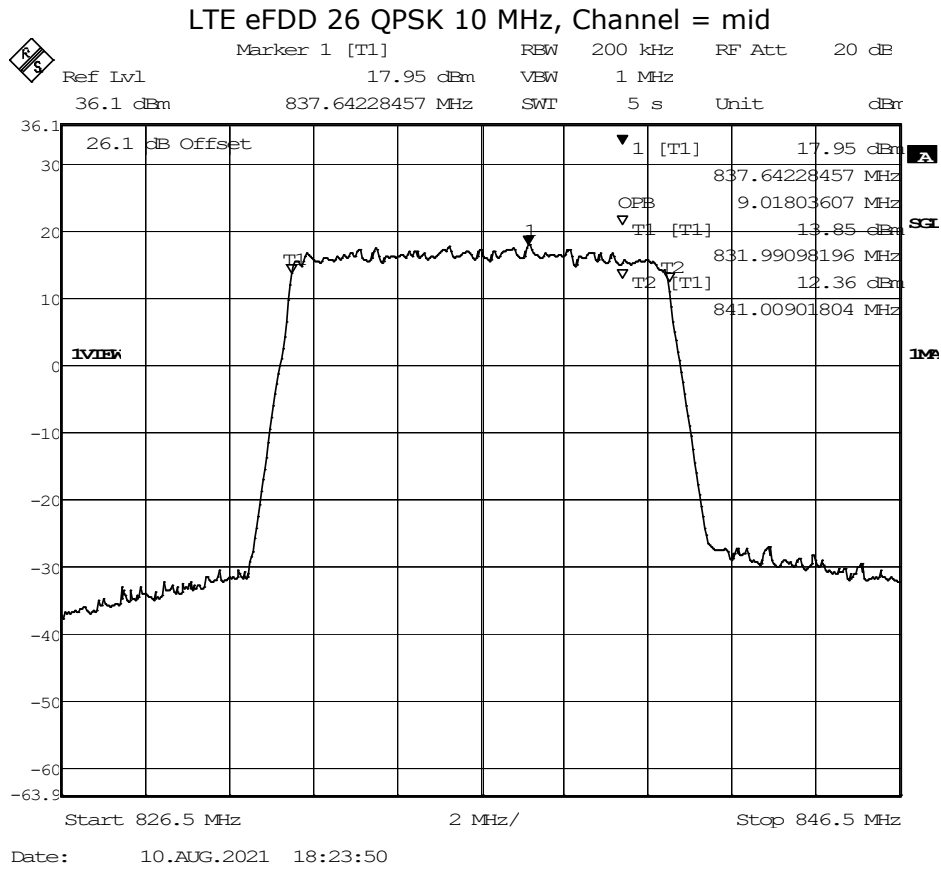

5.5.5 TEST EQUIPMENT USED

- Radio Lab

5.6 BAND EDGE COMPLIANCE

Standard **FCC PART 22 Subpart H**

The test was performed according to:
ANSI C63.26: 2015

5.6.1 TEST DESCRIPTION

This test case is intended to demonstrate compliance to the applicable conducted spurious emission test case per § 2.1051 and RSS-GEN 6.13. The limit comes from the applicable rule part and ISSED RSS-Standard for the operating band of the cellular device.

The EUT was connected to the test setup according to the following diagram:

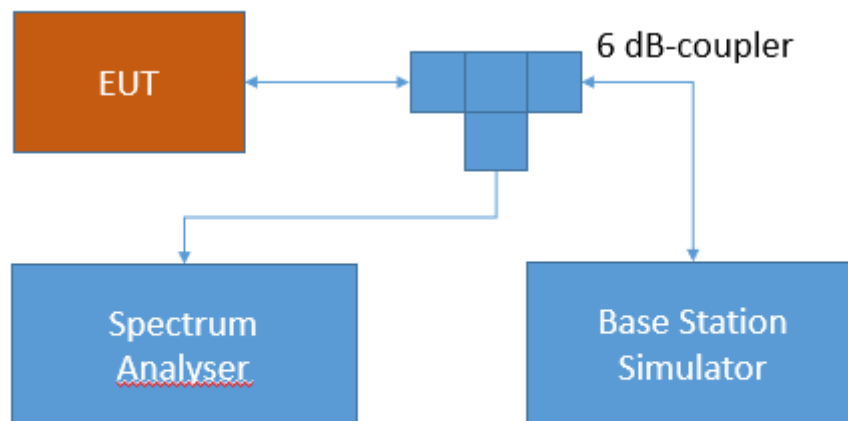

Test Setup FCC Part 22/24/27/90 Cellular;
Band edge compliance

The attenuation of the measuring and stimulus path are known for each measured frequency and are considered.

The Spectrum Analyzer settings can be directly found in the measurement diagrams.

5.6.2 TEST REQUIREMENTS / LIMITS

FCC Part 2.1051; Measurement required: Spurious emissions at antenna terminal:

The radio frequency voltage or powers generated within the equipment and appearing on a spurious frequency shall be checked at the equipment output terminals when properly loaded with a suitable artificial antenna. Curves or equivalent data shall show the magnitude of each harmonic and other spurious emission that can be detected when the equipment is operated under the conditions specified in §2.1049 as appropriate. The magnitude of spurious emissions which are attenuated more than 20 dB below the permissible value need not be specified.

Part 22, Subpart H – Cellular Radiotelephone Service

§22 917 – Emission limitations for cellular equipment

(a) *Out of band emissions.* The power of any emission outside of the authorized operating frequency ranges must be attenuated below the transmitting power (P) by a factor of at least $43 + 10 \log(P)$ dB.

RSS-132; 5.5 Transmitter Unwanted Emissions

Mobile and base station equipment shall comply with the limits in (i) and (ii) below.

1. In the first 1.0 MHz band immediately outside and adjacent to each of the sub-bands specified in Section 5.1, the power of emissions per any 1% of the occupied bandwidth shall be attenuated (in dB) below the transmitter output power P (dBW) by at least $43 + 10 \log_{10} p$ (watts).
2. After the first 1.0 MHz immediately outside and adjacent to each of the sub-bands, the power of emissions in any 100 kHz bandwidth shall be attenuated (in dB) below the transmitter output power P (dBW) by at least $43 + 10 \log_{10} p$ (watts). If the measurement is performed using 1% of the occupied bandwidth, power integration over 100 kHz is required.

5.6.3 TEST PROTOCOL

Ambient temperature: 20 - 28 °C
 Relative humidity: 30 - 45 %

Radio Technology	Channel	Ressource Blocks / Subcarrier	Bandwidth [MHz]	Peak [dBm]	Average [dBm]	RMS [dBm]	Limit [dBm]	Margin to Limit [dB]
GSM 850	low	-	0.2	-17.21	-38.57	-29.69	-13	16.69
GSM 850	high	-	0.2	-19.92	-40.34	-30.2	-13	17.2
GSM 850 EDGE	low	-	0.2	-27.34	-44.82	-36.56	-13	23.56
GSM 850 EDGE	high	-	0.2	-26.69	-47.29	-38.44	-13	25.44
FDD V	low	-	5	-19.54	-28.84	-28.10	-13	15.1
FDD V	high	-	5	-18.25	-28.34	-27.42	-13	14.42
FDD V HSDPA Subtest 1	low	-	5	-20.01	-28.58	-27.64	-13	14.64
FDD V HSDPA Subtest 1	high	-	5	-18.92	-29.10	-28.10	-13	15.1
FDD V HSUPA Subtest 1	low	-	5	-18.20	-28.10	-27.00	-13	14
FDD V HSUPA Subtest 1	high	-	5	-18.85	-29.10	-28.34	-13	15.34
FDD V HSUPA Subtest 5	low	-	5	-18.03	-26.80	-26.40	-13	13.4
FDD V HSUPA Subtest 5	high	-	5	-21.13	-31.17	-30.22	-13	17.22
LTE eFDD 5 QPSK	low	6	1.4	-21.13	-31.19	-29.82	-13	16.82
LTE eFDD 5 QPSK	high	6	1.4	-19.35	-32.44	-30.98	-13	17.98
LTE eFDD 5 16QAM	low	6	1.4	-22.95	-33.44	-31.86	-13	18.86
LTE eFDD 5 16QAM	high	6	1.4	-22.56	-34.86	-33.02	-13	20.02
LTE eFDD 5 QPSK	low	15	3	-15.72	-30.52	-28.1	-13	15.1
LTE eFDD 5 QPSK	high	15	3	-17.41	-31.86	-29.36	-13	16.36
LTE eFDD 5 16QAM	low	15	3	-18.68	-32.62	-29.92	-13	16.92
LTE eFDD 5 16QAM	high	15	3	-18.79	-33.89	-31.51	-13	18.51
LTE eFDD 5 QPSK	low	25	5	-16.4	-32.62	-29.64	-13	16.64
LTE eFDD 5 QPSK	high	25	5	-15.03	-33.44	-29.92	-13	16.92
LTE eFDD 5 16QAM	low	25	5	-15.68	-33.89	-30.52	-13	17.52
LTE eFDD 5 16QAM	high	25	5	-17.91	-35.94	-32.23	-13	19.23
LTE eFDD 5 QPSK	low	50	10	-17.28	-35.38	-33.02	-13	20.02
LTE eFDD 5 QPSK	high	50	10	-17.91	-36.54	-34.36	-13	21.36
LTE eFDD 5 16QAM	low	12	10	-13.41	-31.51	-28.58	-13	15.58
LTE eFDD 5 16QAM	high	12	10	-14.96	-32.23	-29.36	-13	16.36
LTE eFDD 26 QPSK	low	6	1.4	-20.98	-31.86	-30.22	-13	17.22
LTE eFDD 26 QPSK	high	6	1.4	-19.74	-33.02	-31.17	-13	18.17
LTE eFDD 26 16QAM	low	6	1.4	-21.63	-33.02	-31.51	-13	18.51
LTE eFDD 26 16QAM	high	6	1.4	-23.82	-34.86	-33.02	-13	20.02
LTE eFDD 26 QPSK	low	15	3	-16.08	-30.22	-27.64	-13	14.64
LTE eFDD 26 QPSK	high	15	3	-17.63	-33.44	-30.84	-13	17.84
LTE eFDD 26 16QAM	low	15	3	-18.54	-32.62	-30.22	-13	17.22
LTE eFDD 26 16QAM	high	15	3	-19.05	-34.36	-31.51	-13	18.51
LTE eFDD 26 QPSK	low	25	5	-16.20	-32.62	-29.36	-13	16.36
LTE eFDD 26 QPSK	high	25	5	-17.08	-34.86	-31.51	-13	18.51
LTE eFDD 26 16QAM	low	25	5	-15.71	-33.89	-30.52	-13	17.52
LTE eFDD 26 16QAM	high	25	5	-16.76	-35.94	-32.23	-13	19.23

LTE eFDD 26 QPSK	low	50	10	-17.82	-35.94	-33.02	-13	20.02
LTE eFDD 26 QPSK	high	50	10	-18.40	-37.19	-34.86	-13	21.86
LTE eFDD 26 16QAM	low	12	10	-12.54	-28.84	-26.02	-13	13.02
LTE eFDD 26 16QAM	high	12	10	-14.06	-29.92	-27.21	-13	14.21

Remark: Please see next sub-clause for the measurement plot.

5.6.4 MEASUREMENT PLOT (EXAMPLE PLOT, SHOWING WORST CASE, IF APPLICABLE)

GSM 850, Channel = low



10:14:16 15.07.2021

EDGE 850, Channel = low



11:19:12 15.07.2021

WCDMA FDD 5, Channel = high

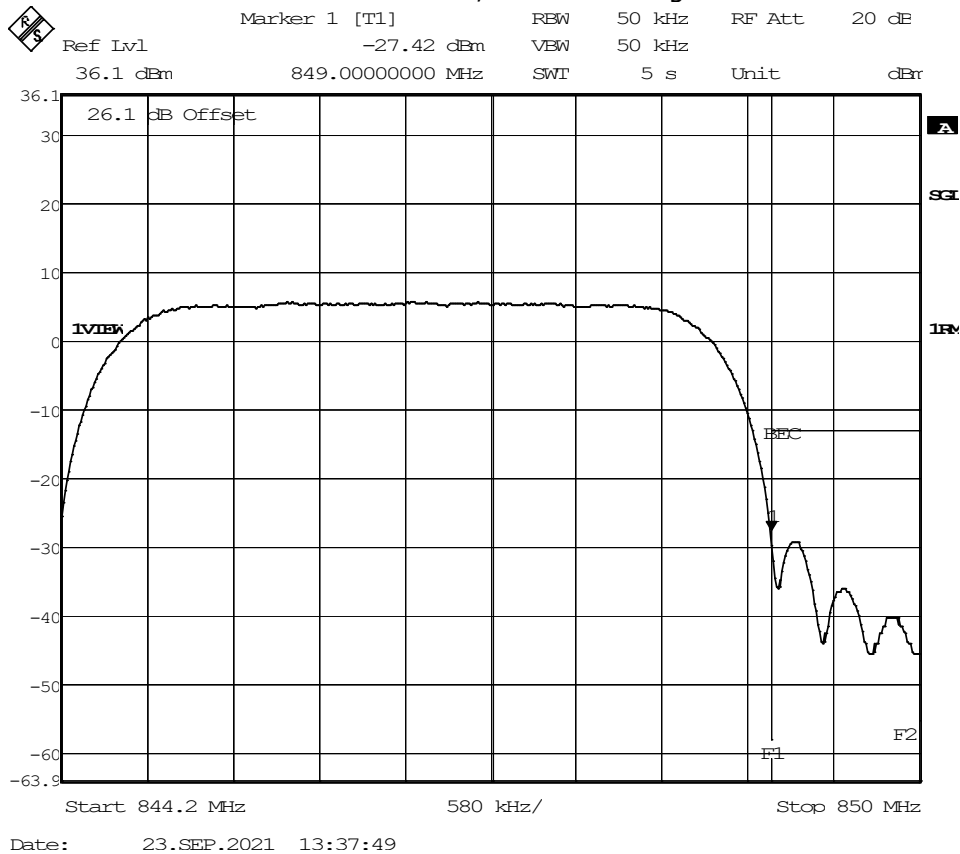

HSDPA FDD 5, Channel = low

R/S
 Marker 1 [T1] RBW 50 kHz RF Att 20 dB
 Ref Lvl -27.64 dBm VEW 50 kHz
 36.1 dBm 824.0000000 MHz SWI 5 s Unit dBm

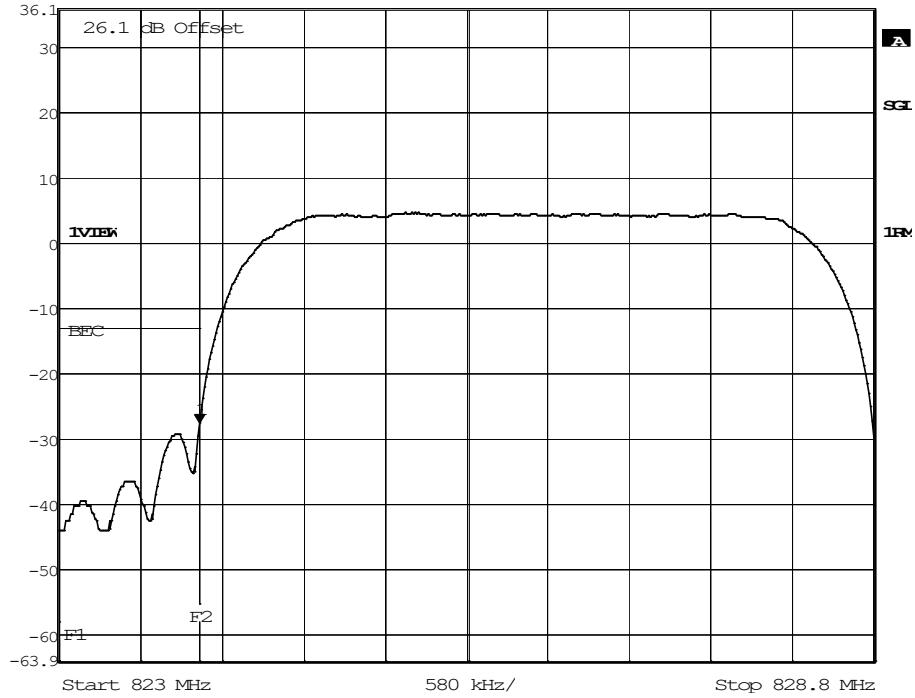

Date: 26.AUG.2021 16:18:41

HSUPA FDD 5 Subtest 5, Channel = low

R/S
 Marker 1 [T1] RBW 50 kHz RF Att 20 dB
 Ref Lvl -26.40 dBm VEW 50 kHz
 36.1 dBm 824.0000000 MHz SWI 5 s Unit dBm

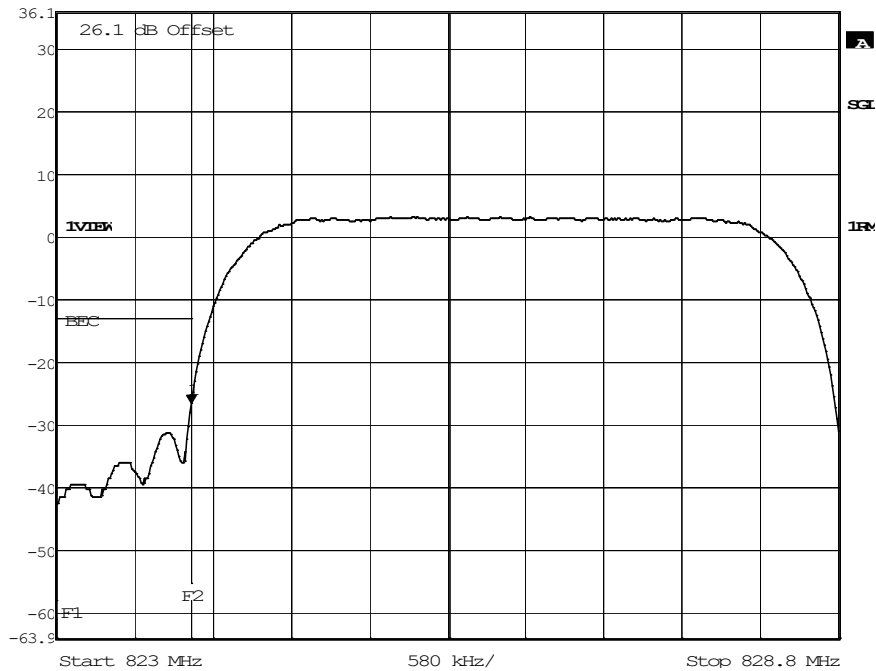

Date: 15.SEP.2021 14:05:35

LTE eFDD 5 QPSK 3 MHz, Channel = low

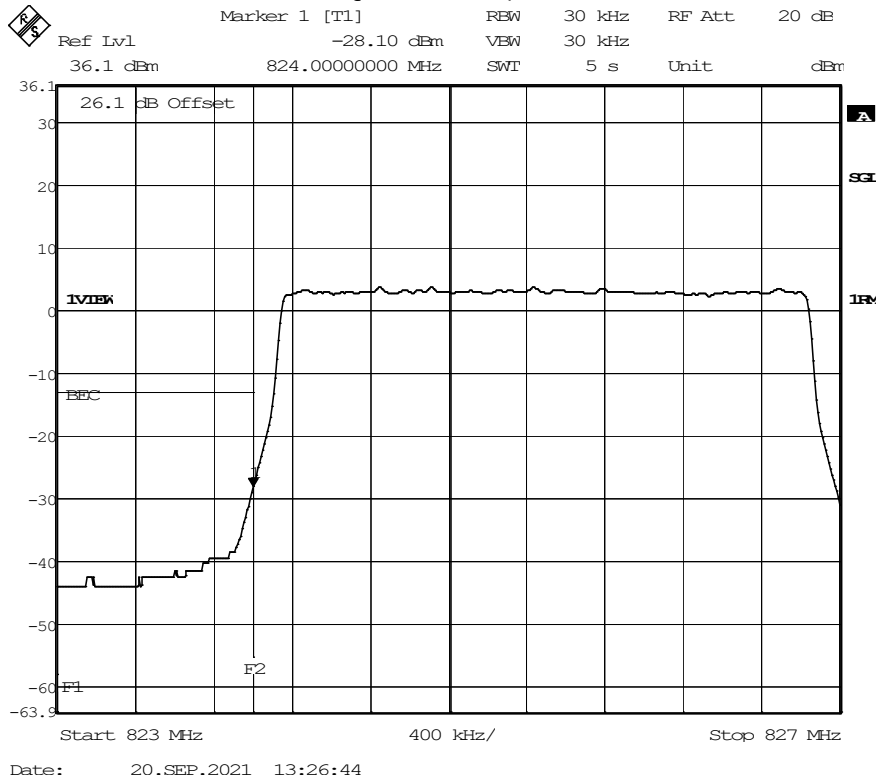

LTE eFDD 26 16QAM 10 MHz, Channel = low

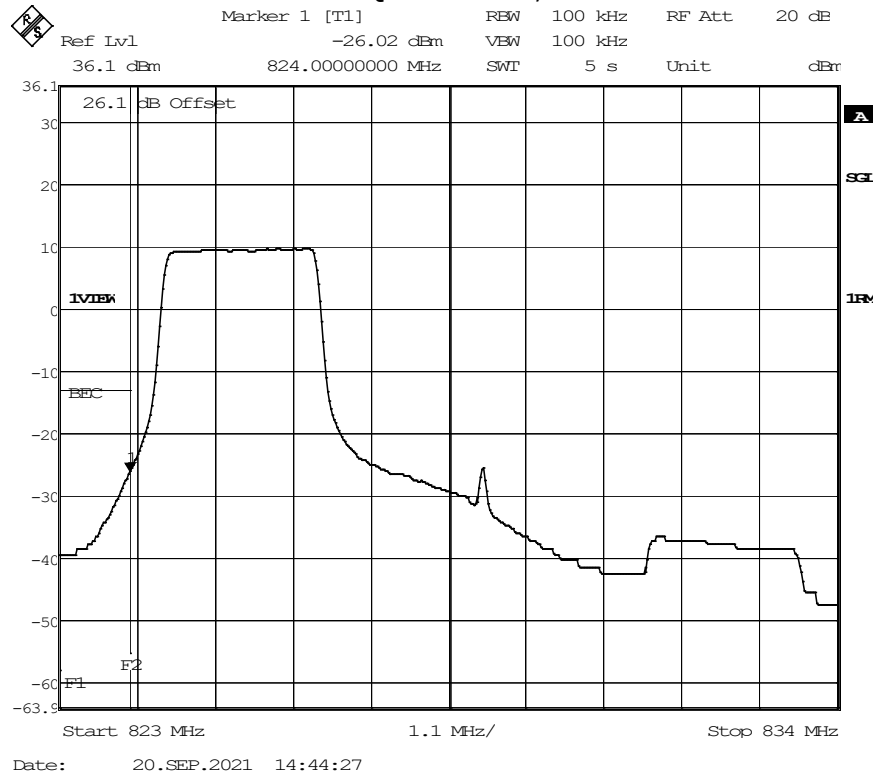

5.6.5 TEST EQUIPMENT USED

- Radio Lab

5.7 PEAK-AVERAGE-RATIO

Standard **FCC PART 22 Subpart H**

The test was performed according to:
ANSI C63.26: 2015

5.7.1 TEST DESCRIPTION

This test case is intended to demonstrate compliance of the EUT to the peak-to-average limits and requirements of the applicable rule part and ISED RSS-Standard for the operating band of the cellular device.

The EUT was connected to the test setup according to the following diagram:

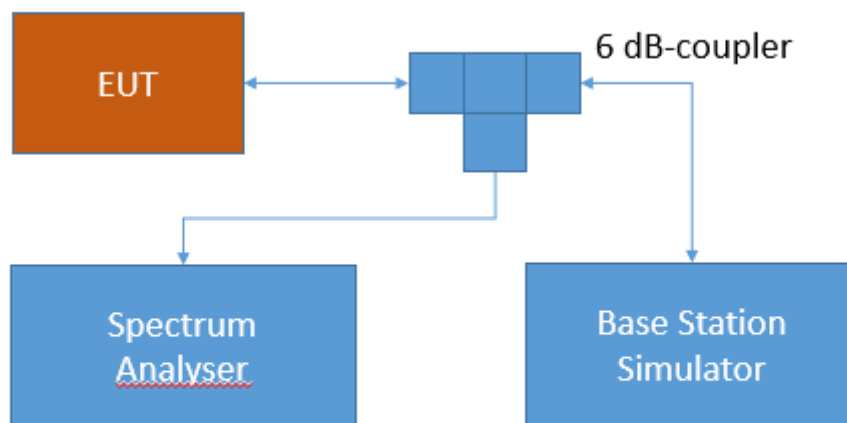

Test Setup FCC Part 22/24/27/90 Cellular;
Peak-average ratio

The attenuation of the measuring and stimulus path are known for each measured frequency and are considered.

The Spectrum Analyser settings can be directly found in the measurement diagrams. The internal CCDF (complementary cumulative distribution function) of the spectrum analyser is used for this measurement

5.7.2 TEST REQUIREMENTS / LIMITS

FCC Part 22, § 22.913

There exists no applicable limit

RSS-132; 5.4 Transmitter Output Power and Equivalent Isotropically Radiated Power

In addition, the peak-to-average power ratio (PAPR) of the transmitter shall not exceed 13 dB for more than 0.1% of the time using a signal corresponding to the highest PAPR during periods of continuous transmission.

5.7.3 TEST PROTOCOL

Ambient temperature: 20 - 28 °C

Relative humidity: 30 - 45 %

Radio Technology	Channel	Re-source Blocks	Bandwidth [MHz]	Peak to Average Ratio [dB]	Limit (IC) [dB]
GSM 850	low	-	0.2	0.59	13
GSM 850	mid	-	0.2	0.61	13
GSM 850	high	-	0.2	0.59	13
GSM 850 EDGE	low	-	0.2	3.41	13
GSM 850 EDGE	mid	-	0.2	3.49	13
GSM 850 EDGE	high	-	0.2	3.65	13
FDD V	low	-	5	5.44	13
FDD V	mid	-	5	5.52	13
FDD V	high	-	5	5.65	13
FDD V HSDPA Subtest 1	low	-	5	5.59	13
FDD V HSDPA Subtest 1	mid	-	5	5.39	13
FDD V HSDPA Subtest 1	high	-	5	2.94	13
FDD V HSUPA Subtest 1	low	-	5	5.92	13
FDD V HSUPA Subtest 1	mid	-	5	5.82	13
FDD V HSUPA Subtest 1	high	-	5	5.8	13
FDD V HSUPA Subtest 5	low	-	5	7.73	13
FDD V HSUPA Subtest 5	mid	-	5	6.92	13
FDD V HSUPA Subtest 5	high	-	5	6.73	13
LTE eFDD 5 QPSK	low	6	1.4	5.42	13
LTE eFDD 5 QPSK	mid	6	1.4	5.54	13
LTE eFDD 5 QPSK	high	6	1.4	5.42	13
LTE eFDD 5 16QAM	low	6	1.4	6.43	13
LTE eFDD 5 16QAM	mid	6	1.4	6.46	13
LTE eFDD 5 16QAM	high	6	1.4	6.38	13
LTE eFDD 26 QPSK	low	6	1.4	5.04	13
LTE eFDD 26 QPSK	mid	6	1.4	5.13	13
LTE eFDD 26 QPSK	high	6	1.4	5.04	13
LTE eFDD 26 16QAM	low	6	1.4	6	13
LTE eFDD 26 16QAM	mid	6	1.4	6.06	13
LTE eFDD 26 16QAM	high	6	1.4	5.94	13

Remark: Please see next sub-clause for the measurement plot.