

5.18.3 TEST PROTOCOL

Ambient temperature: 20 - 25 °C
 Relative humidity: 30 - 40 %

Radio Technology	Channel	Detector	Trace	Resolution Bandwidth /kHz	Frequency /MHz	Peak Value /dBm	Limit /dBm	Margin to Limit /dB
CAT-M1 eFDD4	low	rms	maxhold	100	1708.95	-33.49	-23	10.49
CAT-M1 eFDD4	mid	peak	maxhold	1000	1707.99	-20.81	-13	7.81
CAT-M1 eFDD4	mid	peak	maxhold	1000	1757.42	-22.79	-13	9.79
CAT-M1 eFDD4	high	rms	maxhold	3	1755	-37.34	-13	24.34

Radio Technology	Channel	Detector	Trace	Resolution Bandwidth /kHz	Frequency /MHz	Peak Value /dBm	Limit /dBm	Margin to Limit /dB
CAT-M1 eFDD8	low	rms	maxhold	100	897.4	-32.82	-13	19.82
CAT-M1 eFDD8	low	peak	maxhold	20	897.47	-37.93	-13	24.93
CAT-M1 eFDD8	mid	peak	maxhold	-	-	-	-13	>20
CAT-M1 eFDD8	high	rms	maxhold	-	-	-	-13	>20

Radio Technology	Channel	Detector	Trace	Resolution Bandwidth /kHz	Frequency /MHz	Peak Value /dBm	Limit /dBm	Margin to Limit /dB
CAT-M1 eFDD12	low	rms	maxhold	-	-	-	-13	>20
CAT-M1 eFDD12	mid	rms	maxhold	-	-	-	-13	>20
CAT-M1 eFDD12	high	rms	maxhold	-	-	-	-13	>20

Radio Technology	Channel	Detector	Trace	Resolution Bandwidth /kHz	Frequency /MHz	Peak Value /dBm	Limit /dBm	Margin to Limit /dB
CAT-M1 eFDD13	low	rms	maxhold	-	-	-	-13	>20
CAT-M1 eFDD13	mid	rms	maxhold	-	-	-	-13	>20
CAT-M1 eFDD13	high	rms	maxhold	1000	1565.2	-43.8	-40	3.8

Radio Technology	Channel	Detector	Trace	Resolution Bandwidth /kHz	Frequency /MHz	Peak Value /dBm	Limit /dBm	Margin to Limit /dB
CAT-M1 eFDD66	low	peak	maxhold	1000	1696.75	-20.8	-13	7.8
CAT-M1 eFDD66	mid	rms	maxhold	-	-	-	-13	>20
CAT-M1 eFDD66	high	peak	maxhold	1000	1792.49	-21.4	-13	8.4

Radio Technology	Channel	Detector	Trace	Resolution Bandwidth /kHz	Frequency /MHz	Peak Value /dBm	Limit /dBm	Margin to Limit /dB
NB-IoT eFDD4	low	rms	maxhold	3	1710	-18.55	-13	5.55
NB-IoT eFDD4	mid	rms	maxhold	-	-	-	-13	>20
NB-IoT eFDD4	high	rms	maxhold	3	1755	-17.2	-13	4.2

Radio Technology	Channel	Detector	Trace	Resolution Bandwidth /kHz	Frequency /MHz	Peak Value /dBm	Limit /dBm	Margin to Limit /dB
NB-IoT eFDD8	low	rms	maxhold	100	897.4	-19.0	-13	6.0
NB-IoT eFDD8	low	rms	maxhold	2	897.5	-28.6	-13	15.6
NB-IoT eFDD8	mid	rms	maxhold	-	-	-	-13	>20
NB-IoT eFDD8	high	rms	maxhold	-	-	-	-13	>20

Radio Technology	Channel	Detector	Trace	Resolution Bandwidth /kHz	Frequency /MHz	Peak Value /dBm	Limit /dBm	Margin to Limit /dB
NB-IoT eFDD12	low	rms	maxhold	-	-	-	-13	>20
NB-IoT eFDD12	mid	rms	maxhold	-	-	-	-13	>20
NB-IoT eFDD12	high	rms	maxhold	-	-	-	-13	>20

Radio Technology	Channel	Detector	Trace	Resolution Bandwidth /kHz	Frequency /MHz	Peak Value /dBm	Limit /dBm	Margin to Limit /dB
NB-IoT eFDD13	low	rms	maxhold	-	-	-	-13	>20
NB-IoT eFDD13	mid	rms	maxhold	-	-	-	-13	>20
NB-IoT eFDD13	high	rms	maxhold	1000	1565.2	-43.8	-40	3.8

Radio Technology	Channel	Detector	Trace	Resolution Bandwidth /kHz	Frequency /MHz	Peak Value /dBm	Limit /dBm	Margin to Limit /dB
NB-IoT eFDD66	low	rms	maxhold	2	1710	-14.07	-13	1.07
NB-IoT eFDD66	mid	rms	maxhold	-	-	-	-13	>20
NB-IoT eFDD66	high	rms	maxhold	5	1780	-25.93	-13	12.93

Radio Technology	Channel	Detector	Trace	Resolution Bandwidth /kHz	Frequency /MHz	Peak Value /dBm	Limit /dBm	Margin to Limit /dB
NB-IoT eFDD71	low	peak	maxhold	100	1326.3	-19.96	-13	6.96
NB-IoT eFDD71	mid	peak	maxhold	100	1361.4	-32.22	-13	19.22
NB-IoT eFDD71	high	peak	maxhold	-	-	-	-13	>20

Radio Technology	Channel	Detector	Trace	Resolution Bandwidth /kHz	Frequency /MHz	Peak Value /dBm	Limit /dBm	Margin to Limit /dB
NB-IoT eFDD85	low	rms	maxhold	100	697.89	-29.03	-13	16.03
NB-IoT eFDD85	mid	rms	maxhold	-			-13	>20
NB-IoT eFDD85	high	rms	maxhold	100	716.11	-34.49	-13	21.49

Remark: Please see next sub-clause for the measurement plot.

5.18.4 MEASUREMENT PLOT

CAT-M1 eFDD4, Channel = mid
30 MHz - 1 GHz

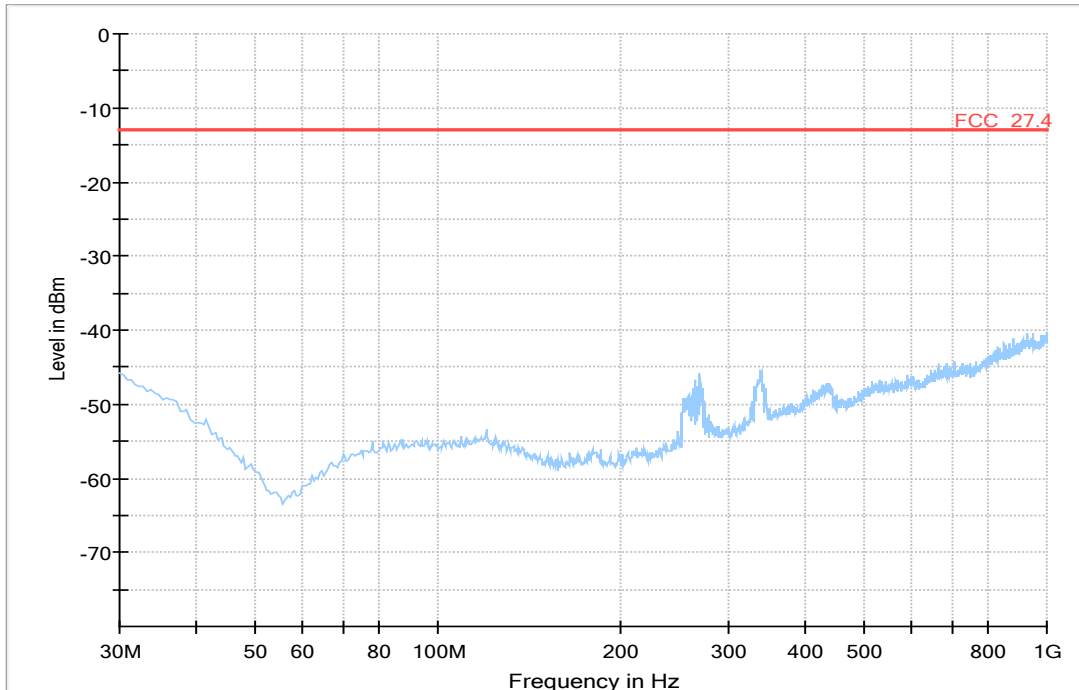

1 GHz - 20 GHz

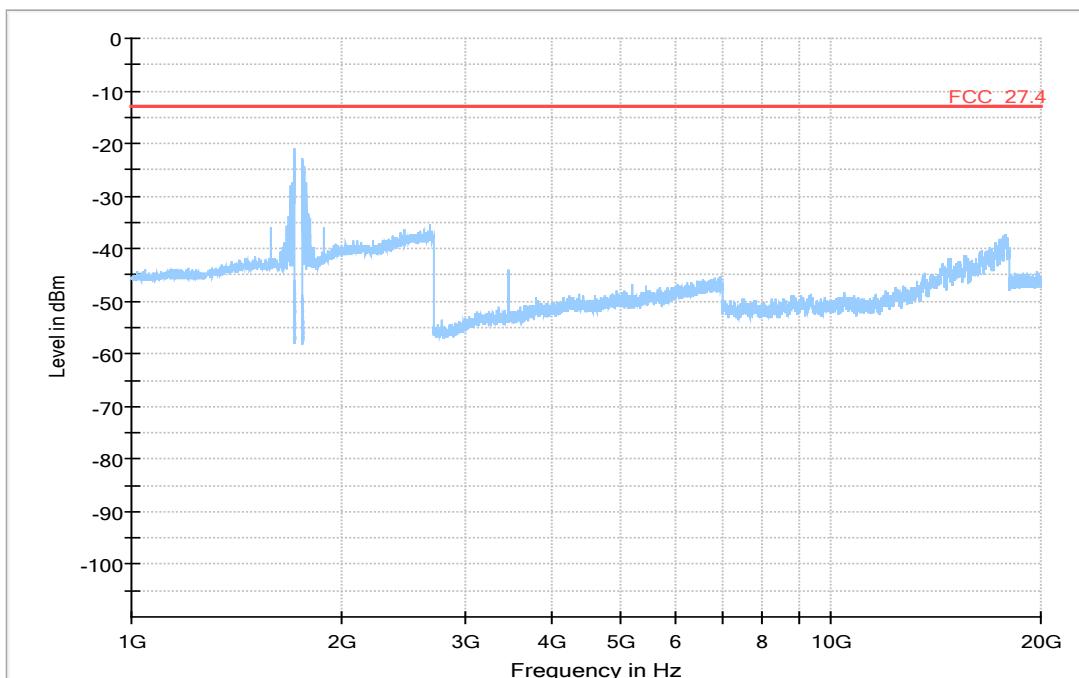

CAT-M1 eFDD8, Channel = low
30 MHz - 1 GHz

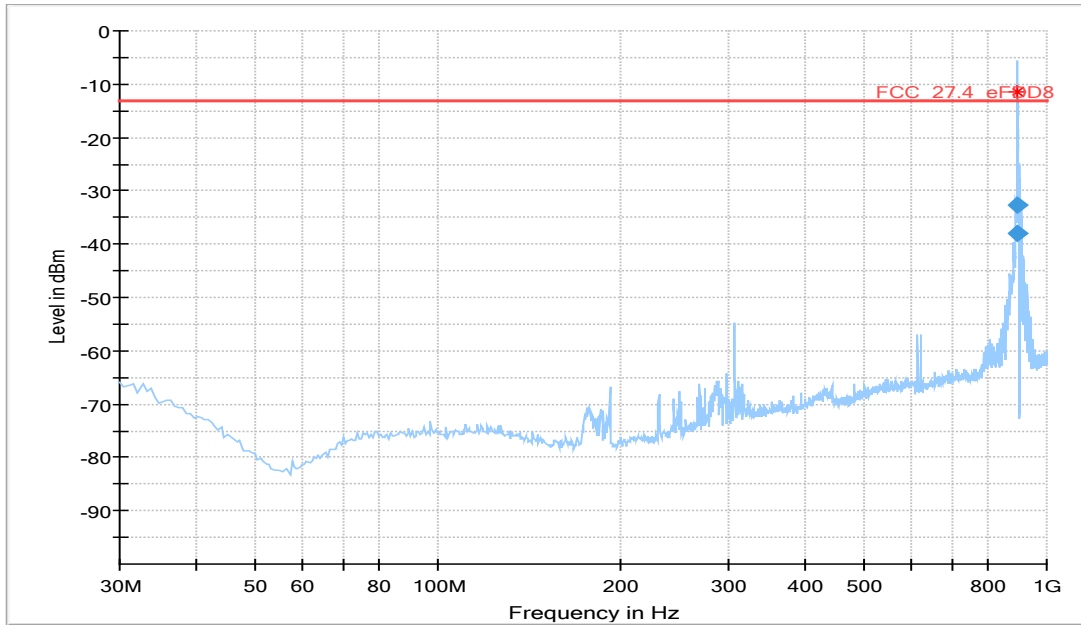

Frequency (MHz)	RMS (dBm)	Limit (dBm)	Margin (dB)	Meas. Time (ms)	Bandwidth (kHz)	Height (cm)	Pol	Azimuth (deg)	Corr. (dB)
897.400000	-32.82	-13.00	19.82	1000.0	100.000	100.0	H	-199.0	-73.1
897.465600	-37.93	-13.00	24.93	1000.0	20.000	100.0	H	45.0	-73.1

1 GHz - 10 GHz

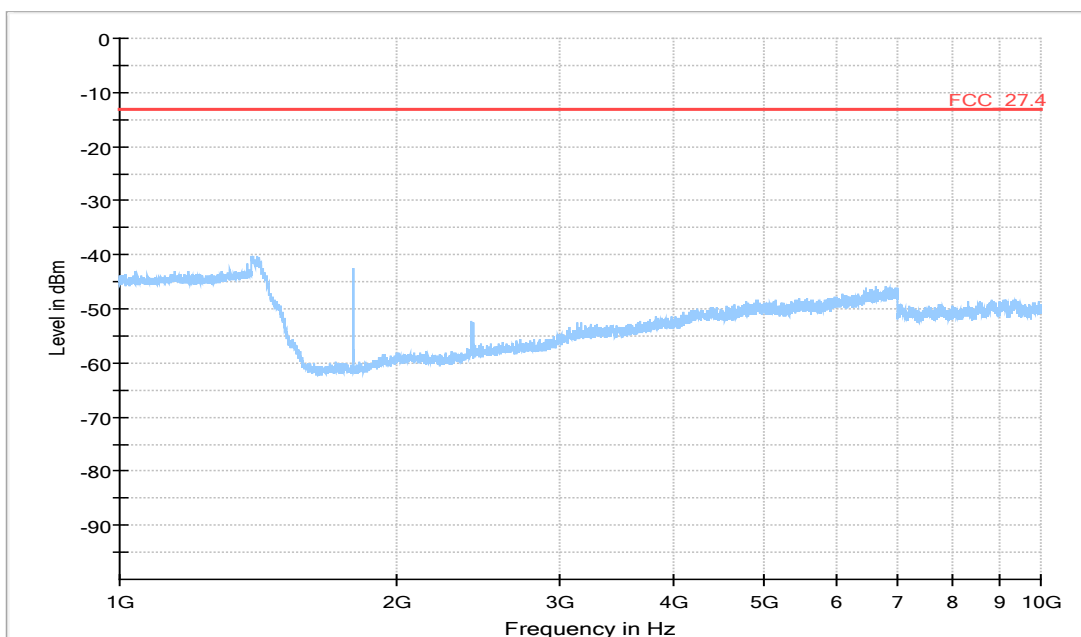

CAT-M1 eFDD12, Channel = mid
30 MHz – 1 GHz

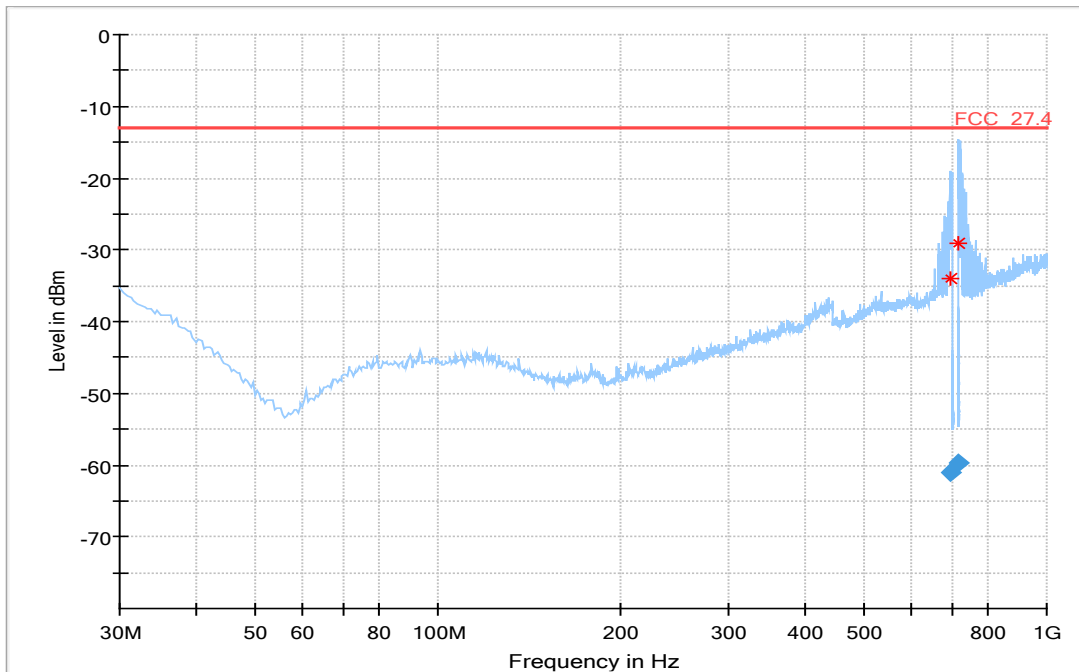

Frequency (MHz)	RMS (dBm)	Limit (dBm)	Margin (dB)	Meas. Time (ms)	Bandwidth (kHz)	Height (cm)	Pol	Azimuth (deg)	Corr. (dB)
696.647688	-60.91	-13.00	47.91	1000.0	100.000	113.0	H	102.0	-75.8
717.519500	-59.74	-13.00	46.74	1000.0	100.000	118.0	H	97.0	-75.3

1 GHz – 10 GHz

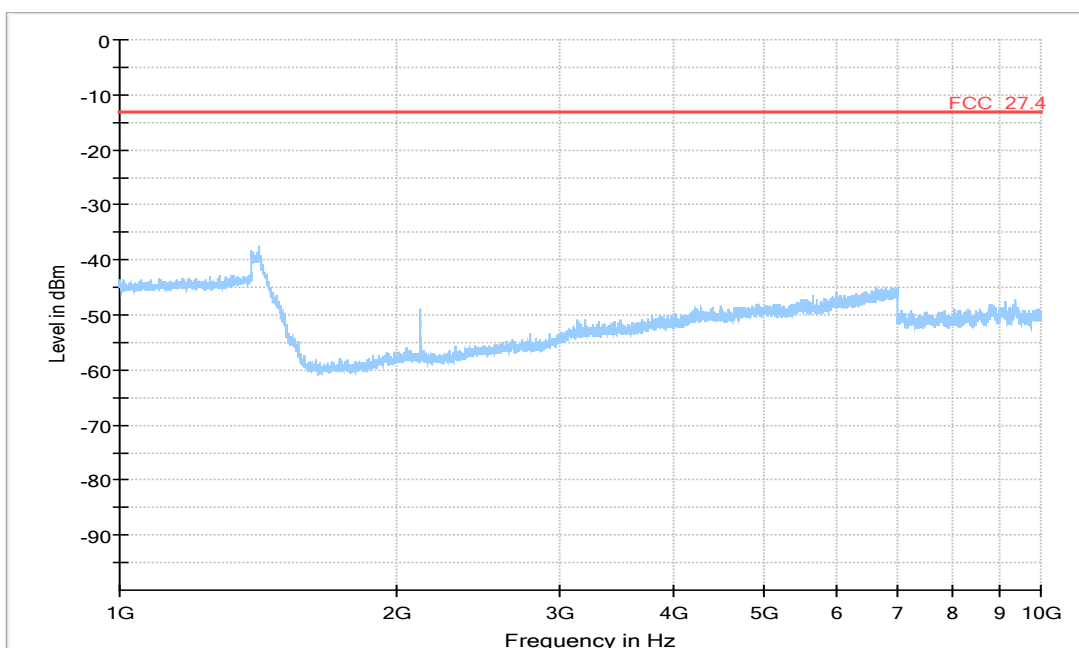

CAT-M1 eFDD13, Channel = high
30 MHz – 1 GHz

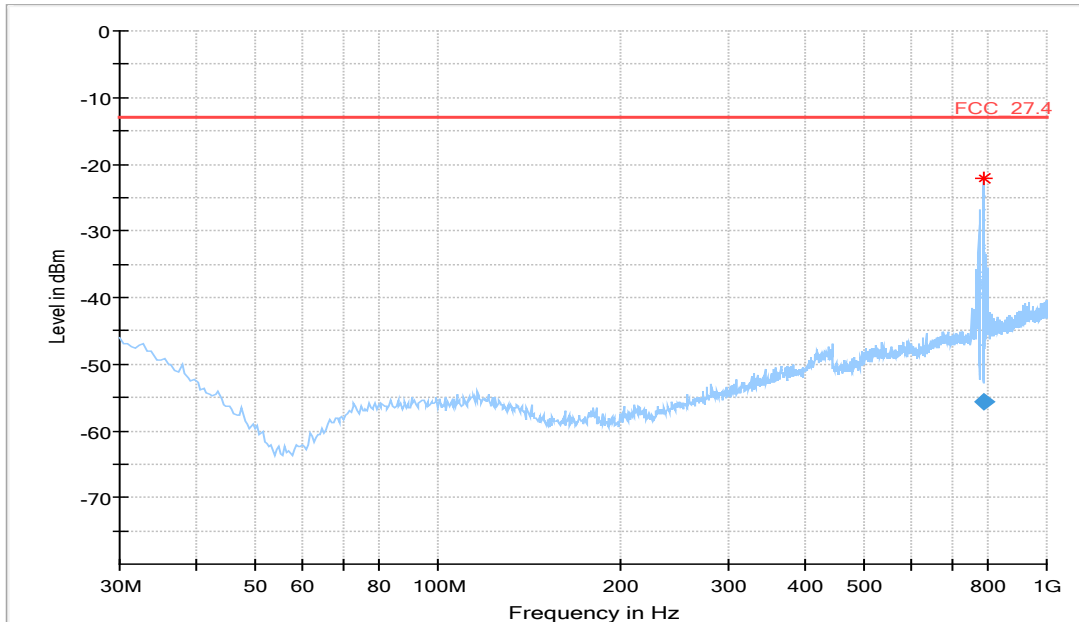

Frequency (MHz)	RMS (dBm)	Limit (dBm)	Margin (dB)	Meas. Time (ms)	Bandwidth (kHz)	Height (cm)	Pol	Azimuth (deg)	Corr. (dB)
787.226875	-55.58	-13.00	42.58	1000.0	100.000	107.0	H	-189.0	-74.6

1 GHz – 10 GHz

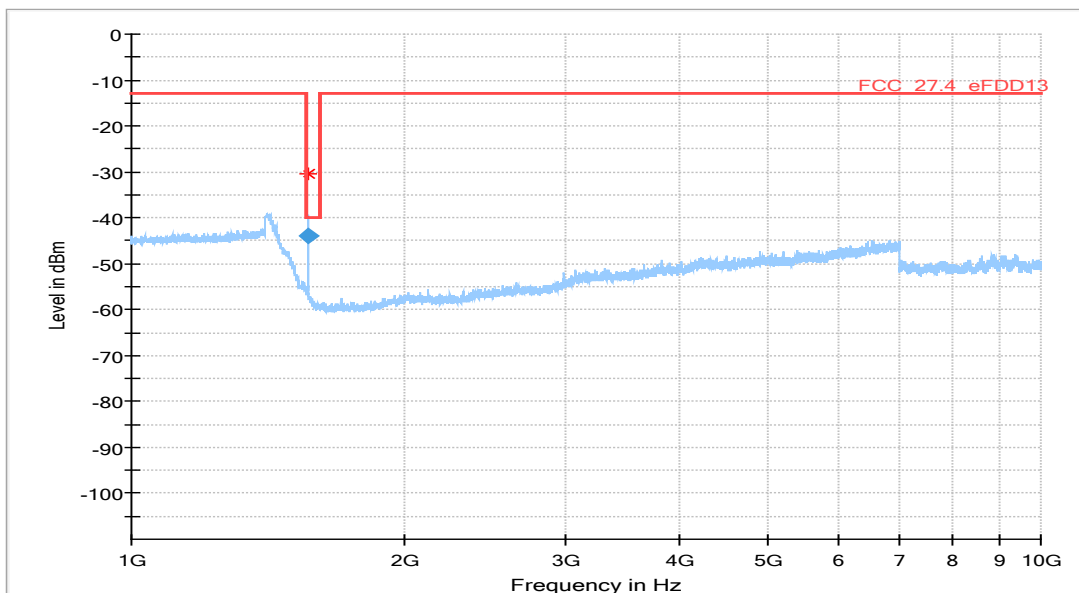

Frequency (MHz)	RMS (dBm)	Limit (dBm)	Margin (dB)	Meas. Time (ms)	Bandwidth (kHz)	Height (cm)	Pol	Azimuth (deg)	Elevation (deg)
1565.200	-43.8	-40.00	3.80	1000.0	1000.000	150.0	V	-12.0	-22.0

CAT-M1 eFDD66, Channel = low
30 MHz – 1 GHz

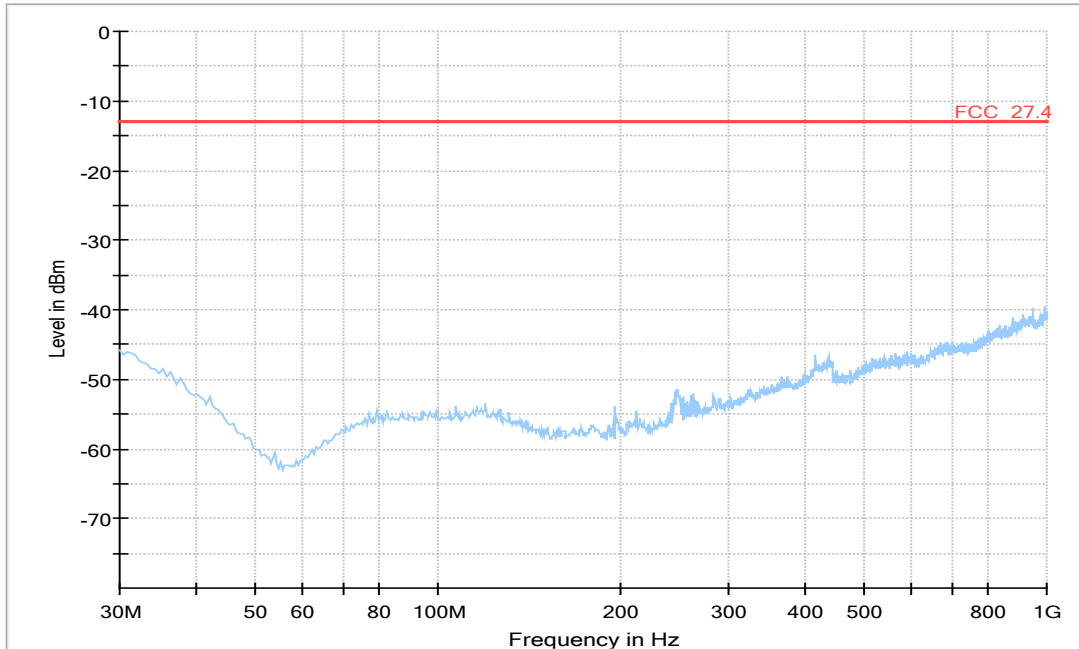

1 GHz – 20 GHz

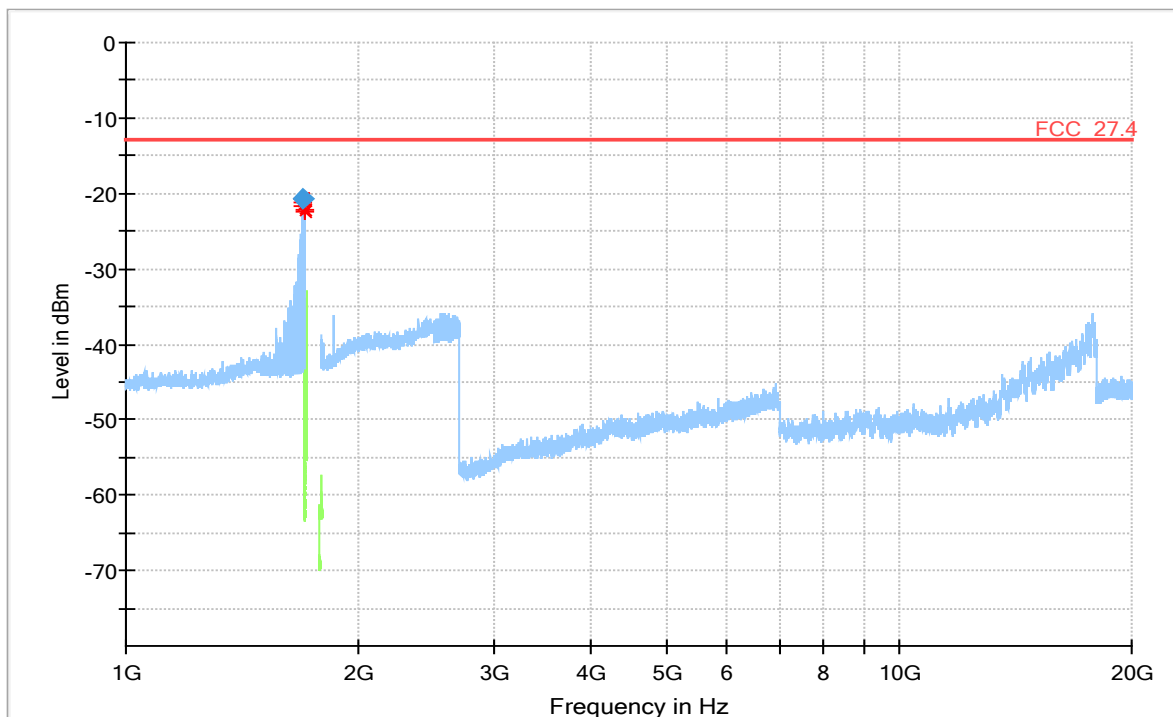

Frequency (MHz)	MaxPeak (dBm)	Limit (dBm)	Margin (dB)	Meas. Time (ms)	Bandwidth (kHz)	Height (cm)	Pol	Azimuth (deg)	Elevation (deg)	Corr. (dB)
1696.750	-20.8	-13.00	7.81	2000.0	1000.000	150.0	H	135.0	0.0	-66.0

NB-IoT eFDD4, Channel = high
30 MHz – 1 GHz

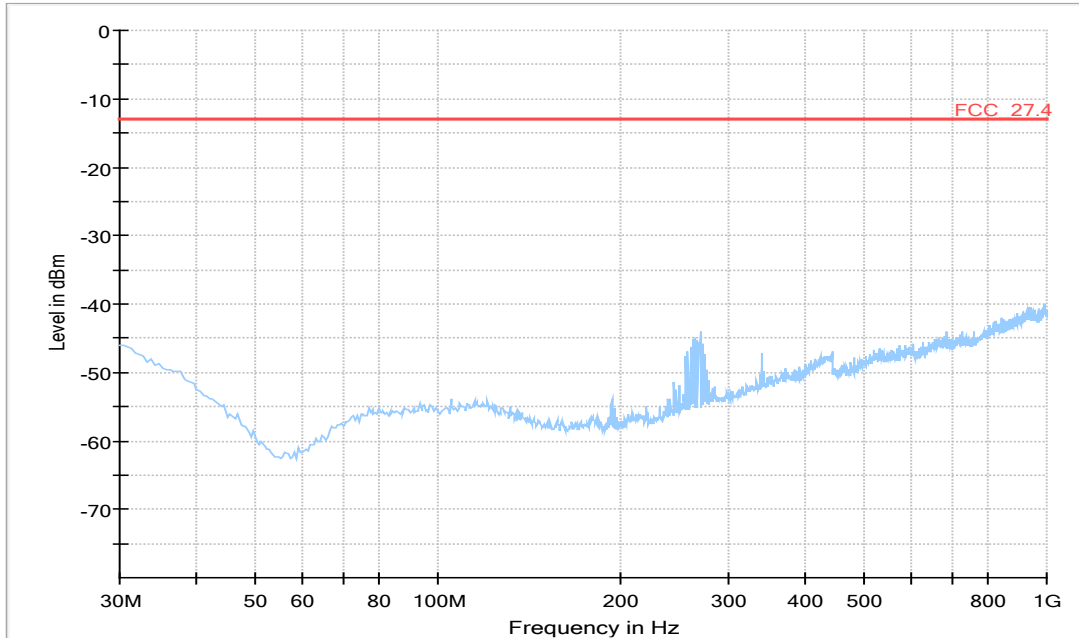

1 GHz – 20 GHz

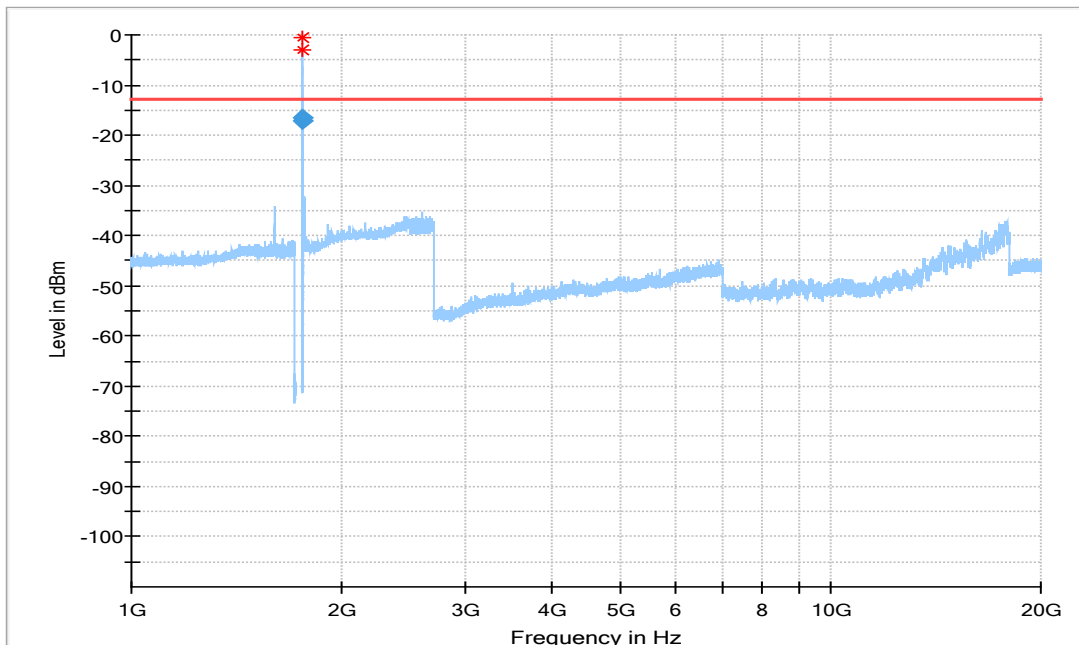

Frequency (MHz)	RMS (dBm)	Limit (dBm)	Margin (dB)	Meas. Time (ms)	Bandwidth (kHz)	Height (cm)	Pol	Azimuth (deg)	Elevation (deg)	Corr. (dB)
1755.002	-17.2	-13.00	4.18	1000.0	3.000	150.0	V	-1.0	100.0	-65.5

NB-IoT eFDD8, Channel = low
30 MHz – 1 GHz

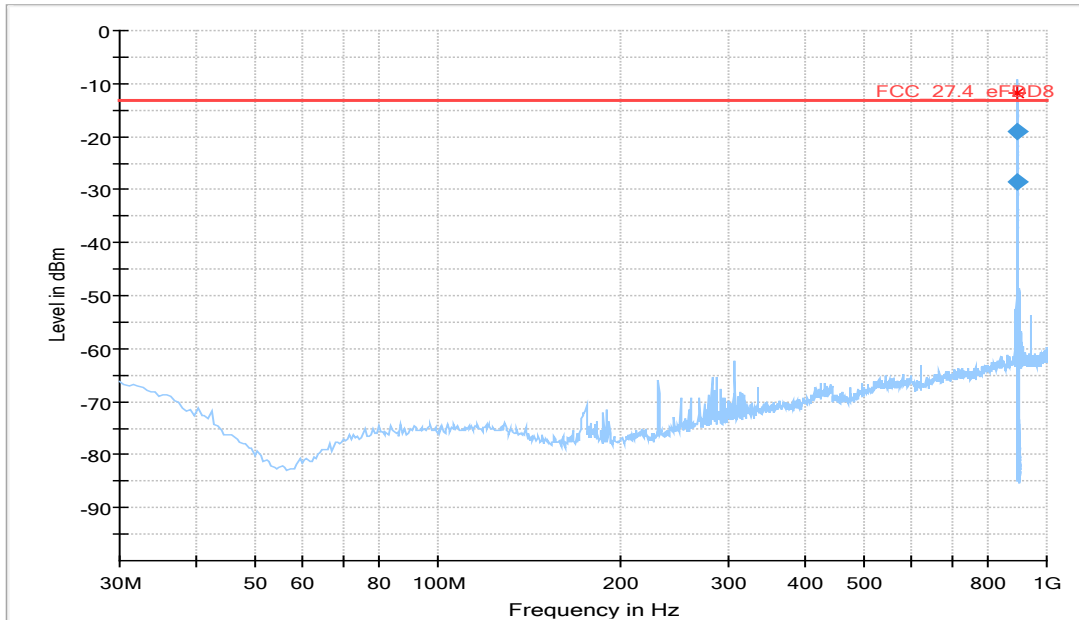

Frequency (MHz)	RMS (dBm)	Limit (dBm)	Margin (dB)	Meas. Time (ms)	Bandwidth (kHz)	Height (cm)	Pol	Azimuth (deg)	Corr. (dB)
897.400000	-19.00	-13.00	6.00	1000.0	100.000	111.0	V	118.0	-73.1
897.498500	-28.56	-13.00	15.56	1000.0	2.000	100.0	H	-170.0	-73.1

1 GHz – 10 GHz

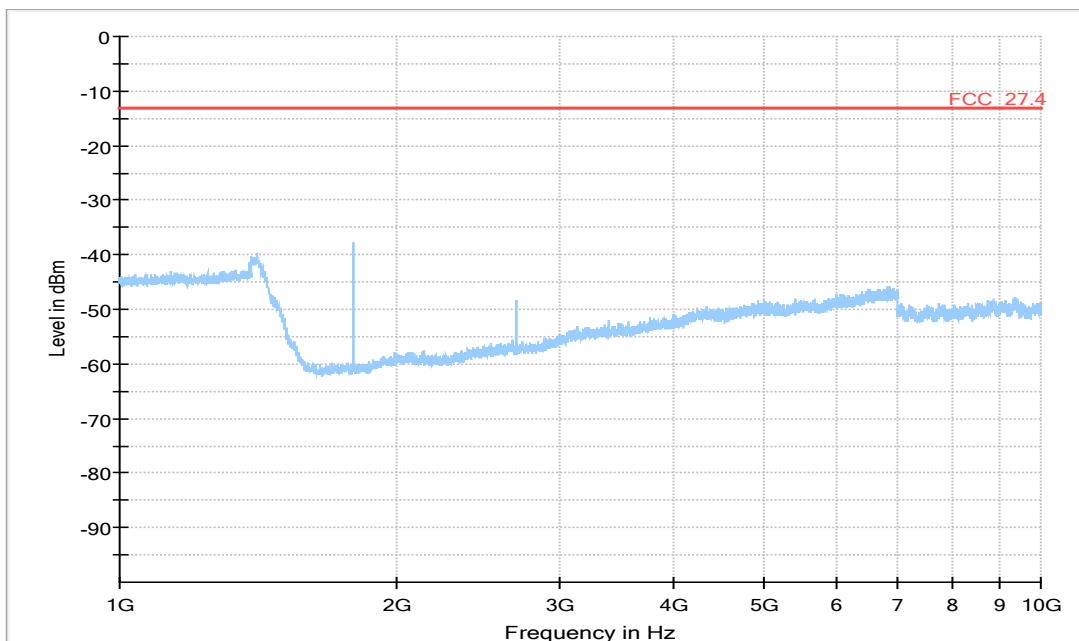

NB-IoT eFDD12, Channel = high
30 MHz – 1 GHz

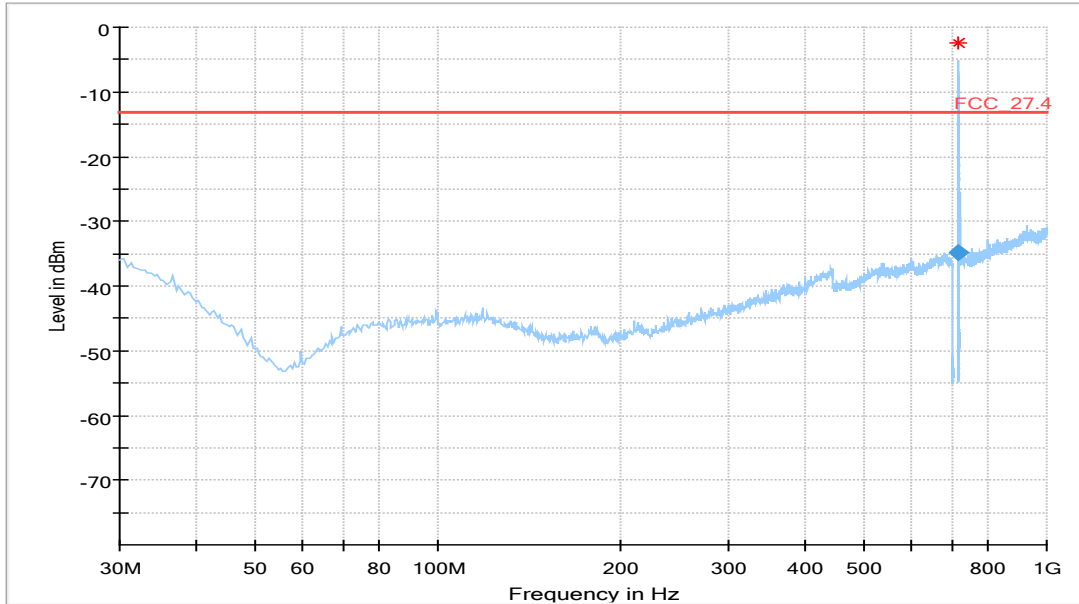

Frequency (MHz)	RMS (dBm)	Limit (dBm)	Margin (dB)	Meas. Time (ms)	Bandwidth (kHz)	Height (cm)	Pol	Azimuth (deg)	Corr. (dB)
716.115667	-34.63	-13.00	21.63	1000.0	100.000	138.0	H	116.0	-75.4

1 GHz – 10 GHz

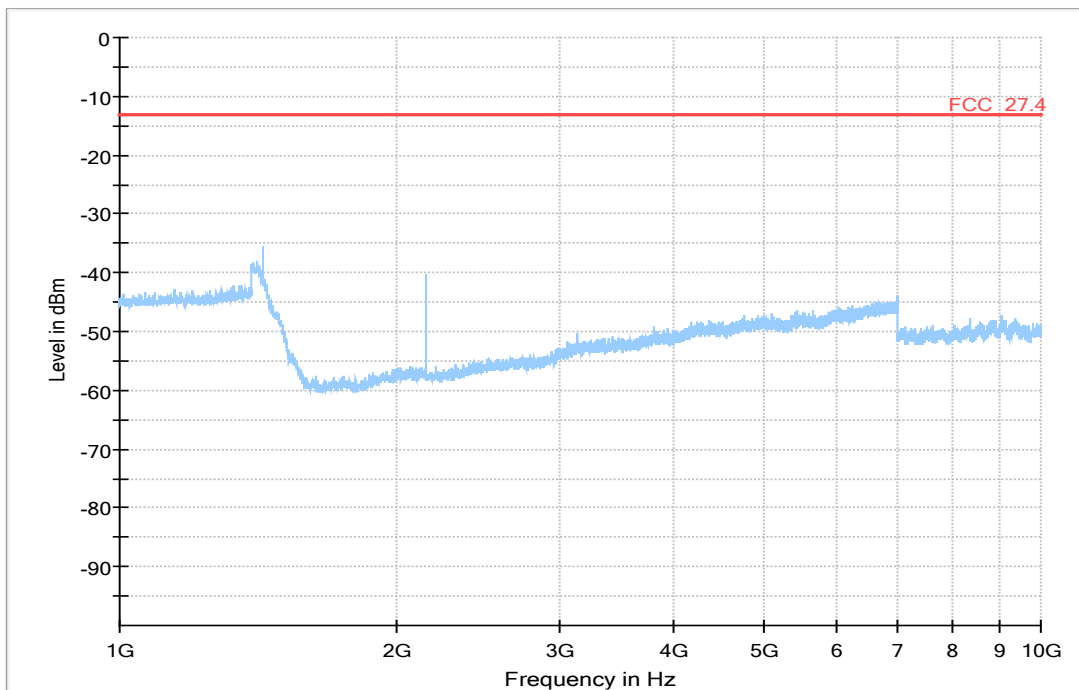

NB-IoT eFDD13, Channel = high
30 MHz – 1 GHz

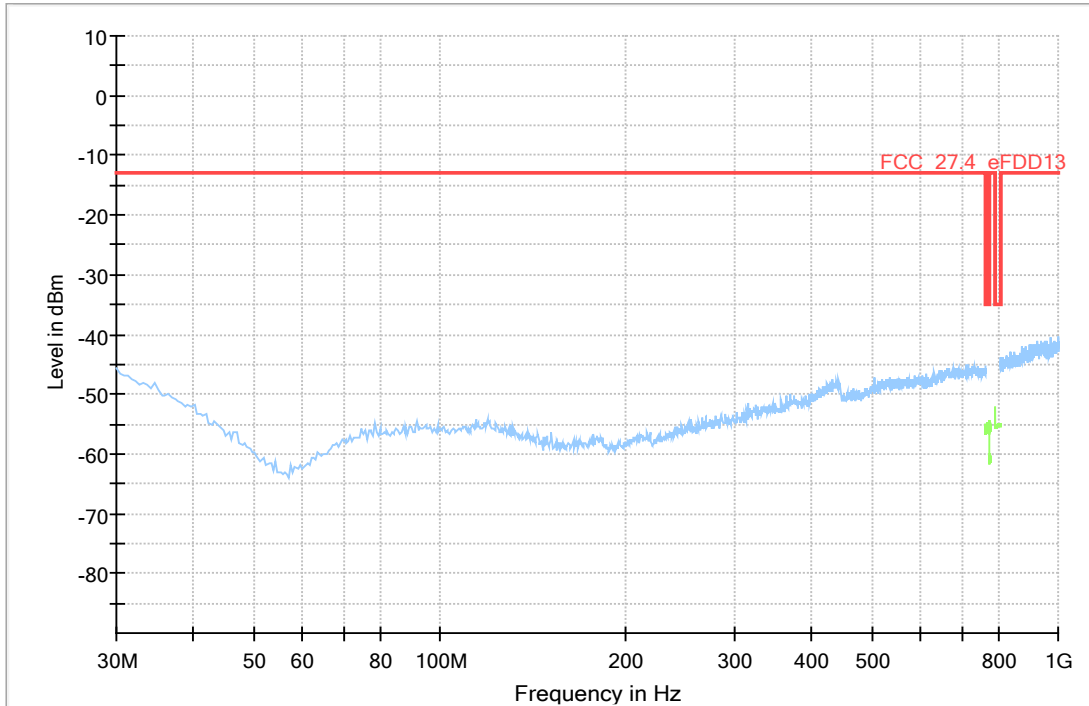

1 GHz – 10 GHz

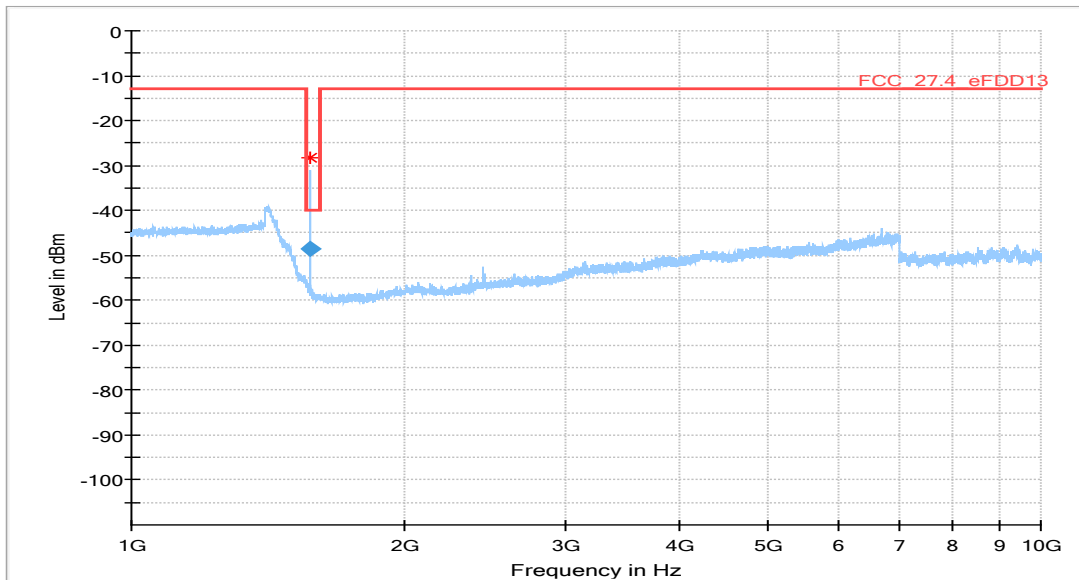

Frequency (MHz)	RMS (dBm)	Limit (dBm)	Margin (dB)	Meas. Time (ms)	Bandwidth (kHz)	Height (cm)	Pol	Azimuth (deg)	Elevation (deg)	Corr. (dB)
1573.600	-48.5	-40.00	8.51	1000.0	1000.000	150.0	H	-26.0	98.0	-102.1

NB-IoT eFDD66, Channel = low
30 MHz – 1 GHz

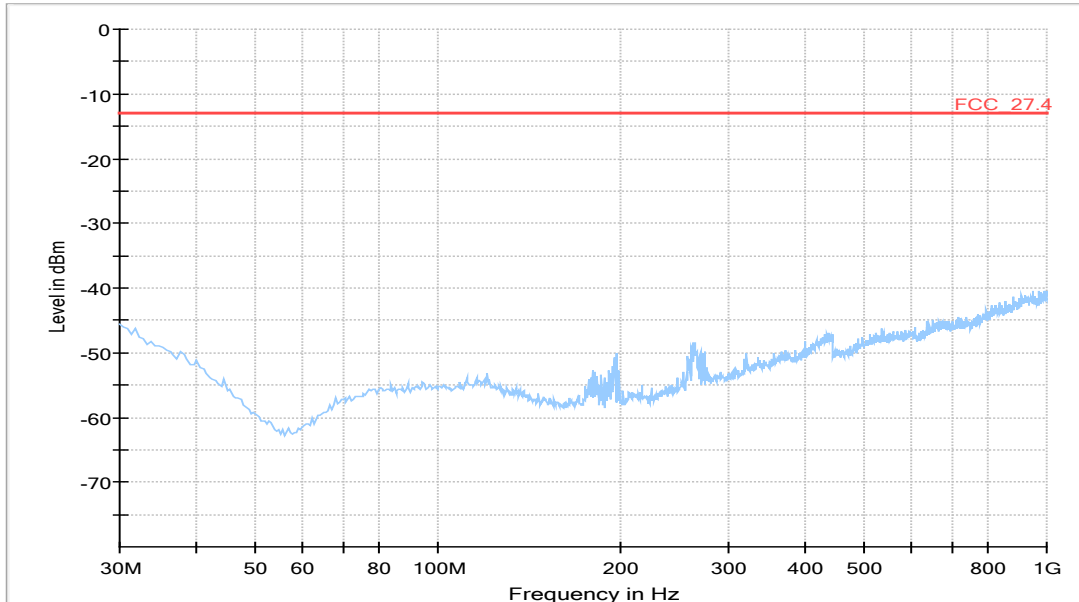

1 GHz – 20 GHz

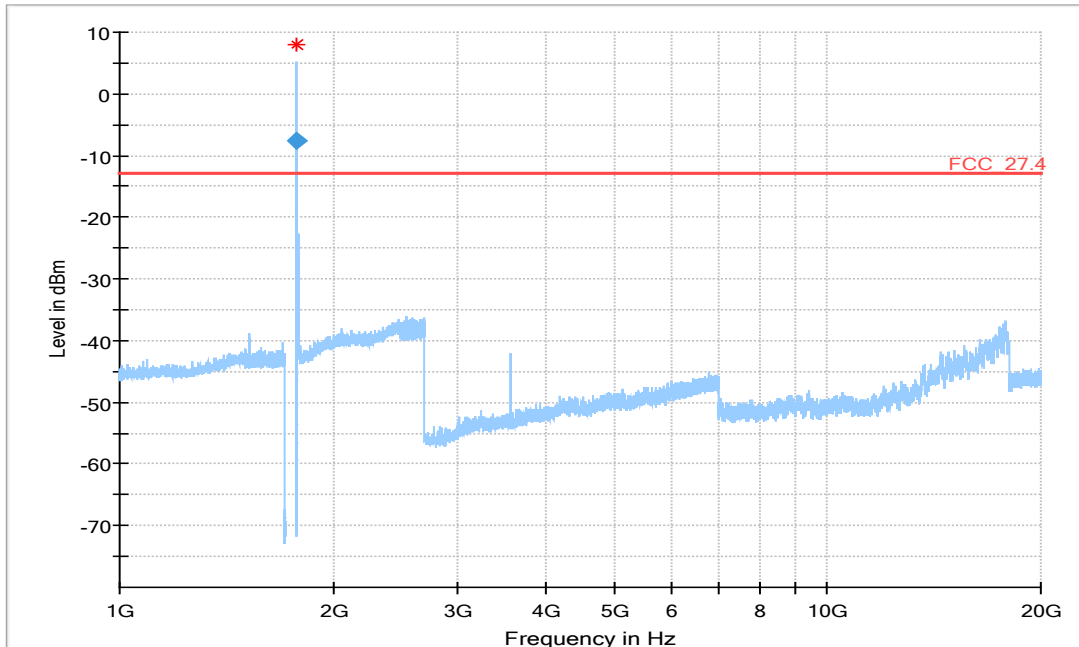

COMMENT: Details see re-measurement on next page

re-measurement at carrier

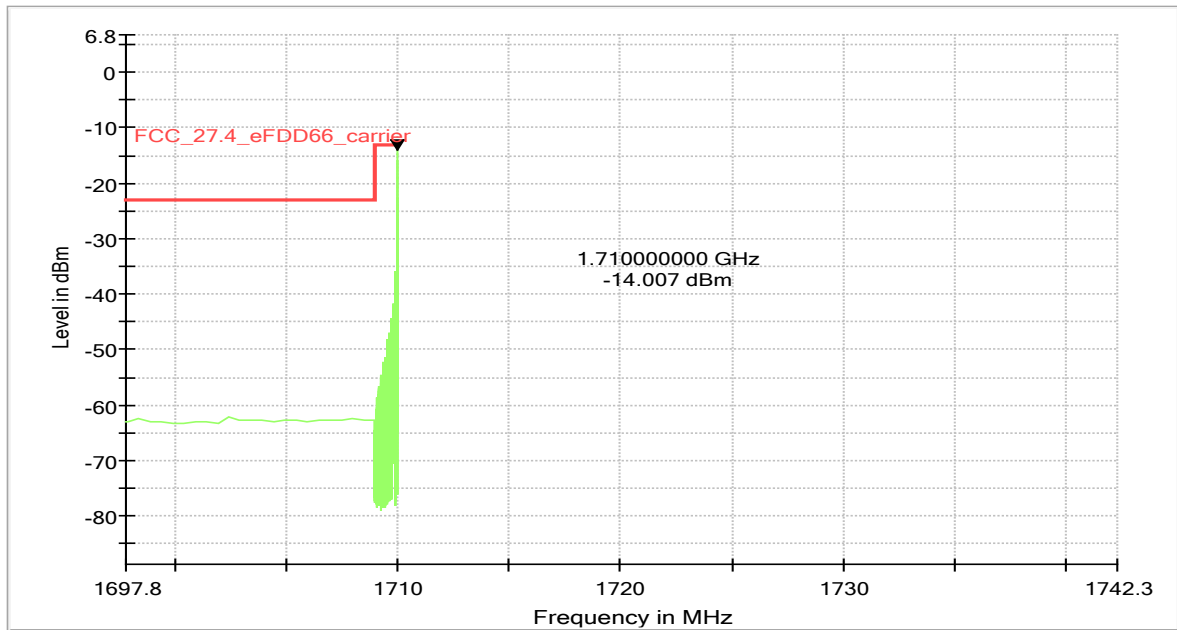

NB-IoT eFDD71, Channel = low
30 MHz – 1 GHz

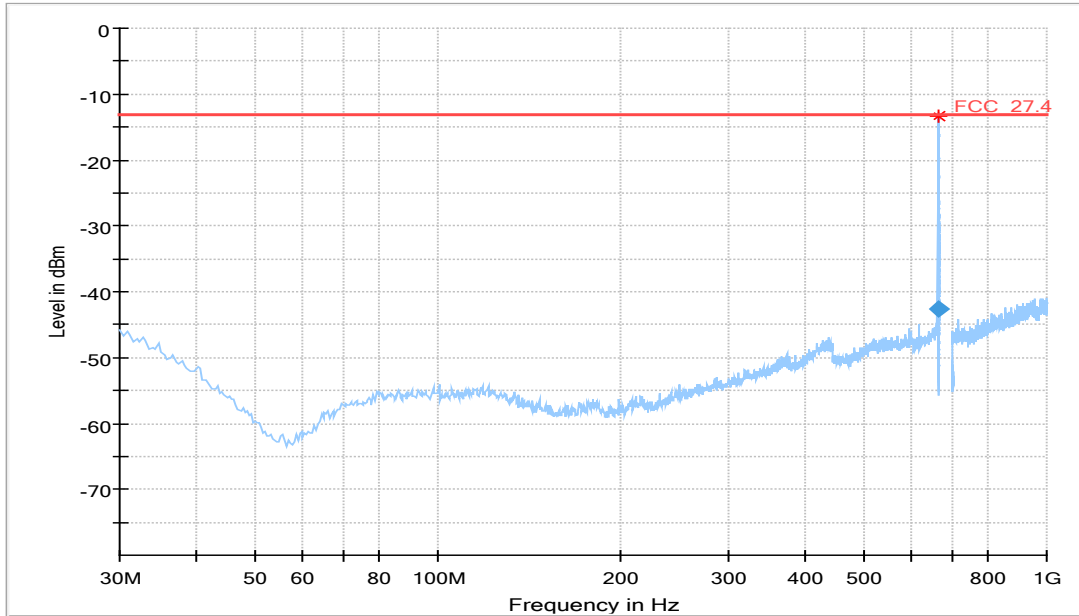

Frequency (MHz)	RMS (dBm)	Limit (dBm)	Margin (dB)	Meas. Time (ms)	Bandwidth (kHz)	Height (cm)	Pol	Azimuth (deg)	Corr. (dB)
662.999900	-42.45	-13.00	29.45	1000.0	30.000	102.0	V	-192.0	-76.1

1 GHz – 10 GHz

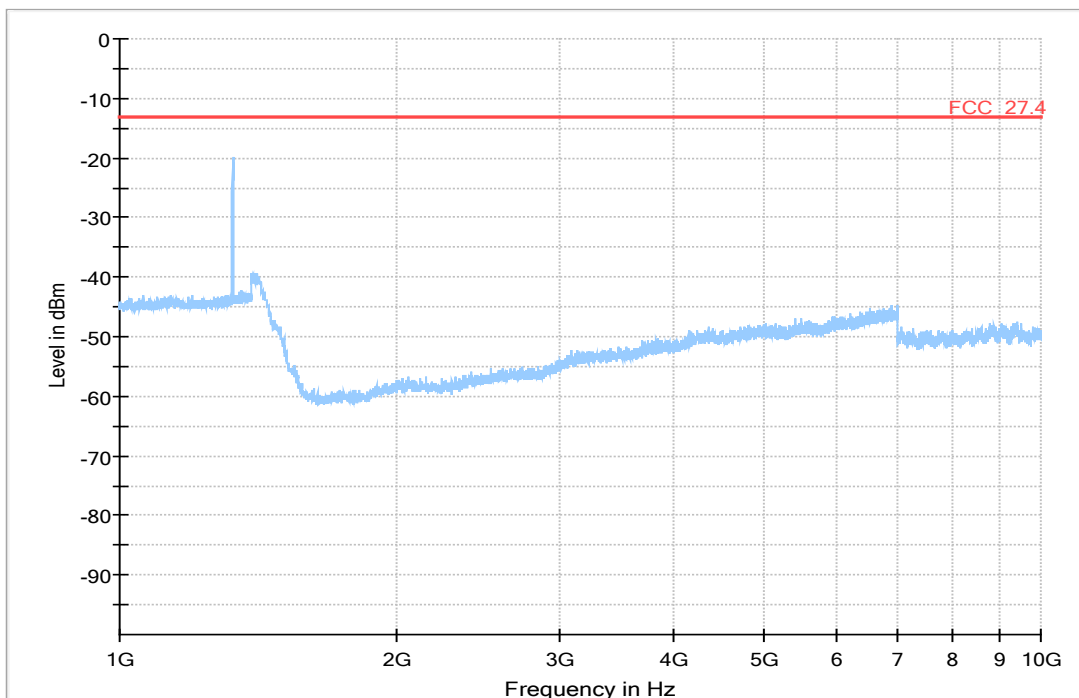

NB-IoT eFDD85, Channel = low
30 MHz – 1 GHz

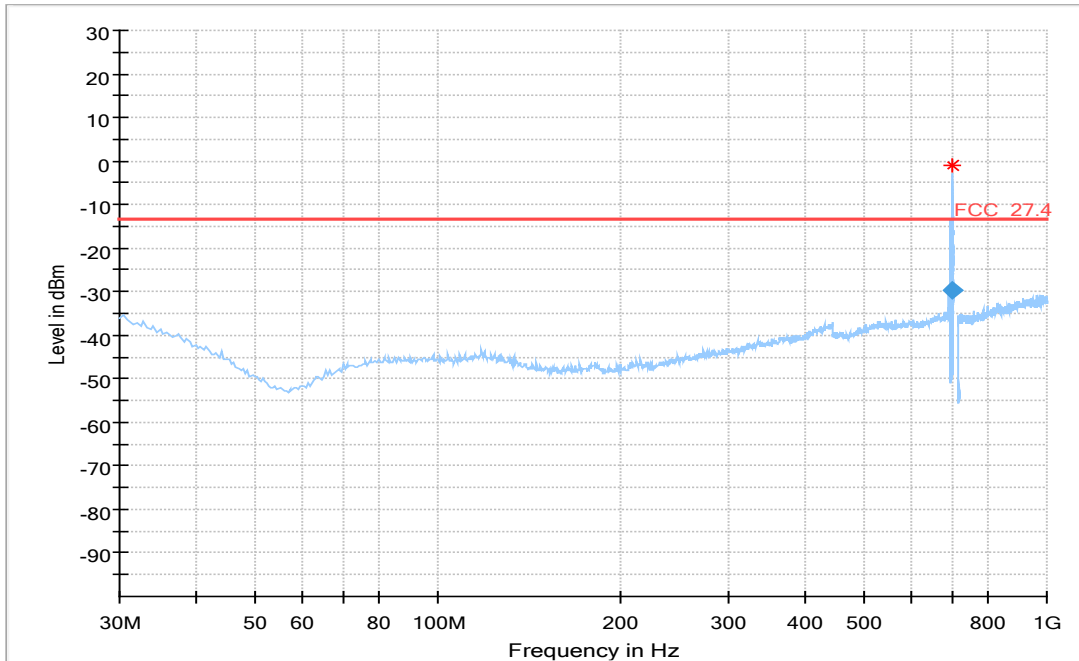

Frequency (MHz)	RMS (dBm)	Limit (dBm)	Margin (dB)	Meas. Time (ms)	Bandwidth (kHz)	Height (cm)	Pol	Azimuth (deg)	Corr. (dB)
697.893000	-29.03	-13.00	16.03	1000.0	100.000	118.0	H	98.0	-75.8

1 GHz – 10 GHz

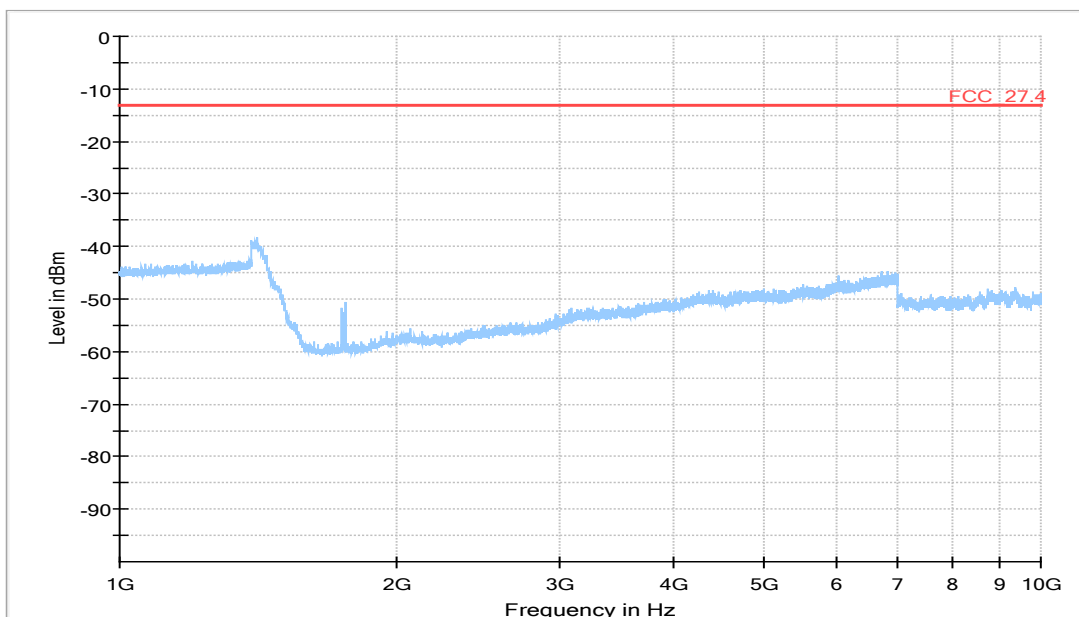

5.18.5 TEST EQUIPMENT USED

Radiated Emissions

5.19 EMISSION AND OCCUPIED BANDWIDTH

Standard **FCC PART 27 Subpart C**

The test was performed according to:
ANSI C63.26: 2015

5.19.1 TEST DESCRIPTION

This test case is intended to demonstrate compliance to the applicable conducted spurious emission test case per FCC §2.1049 and RSS-GEN 6.7. The limit and the requirements come from the applicable rule part and ISED RSS-Standard for the operating band of the cellular device.

The EUT was connected to the test setups according to the following diagram:

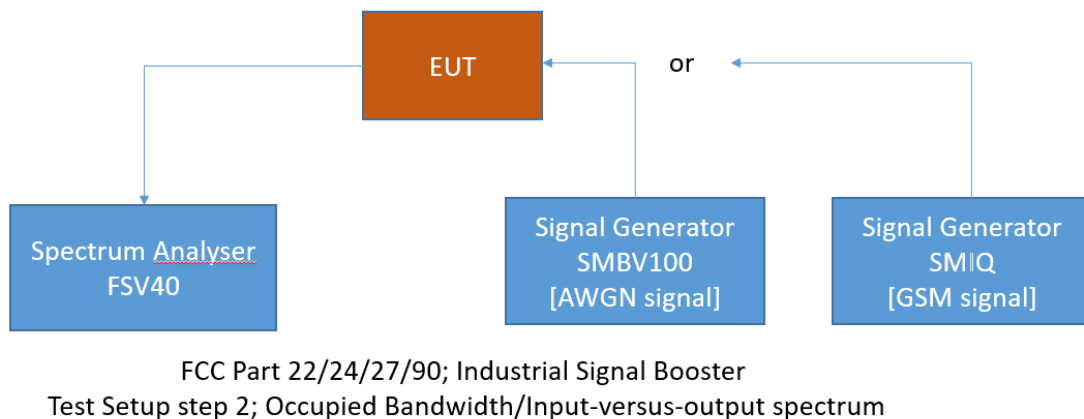
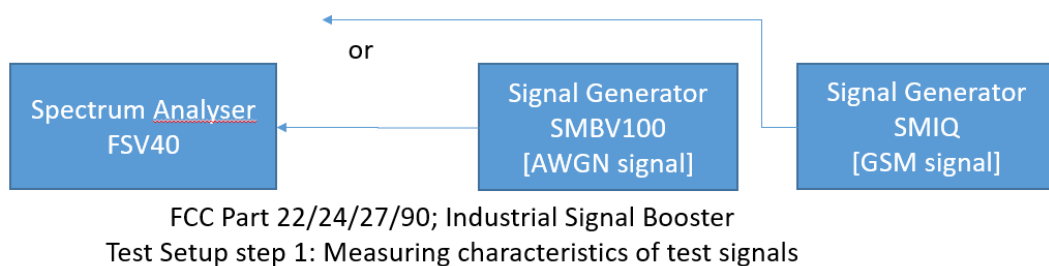

The attenuation of the measuring and stimulus path are known for each measured frequency and are considered.

The Spectrum Analyzer settings can be directly found in the measurement diagrams.

5.19.2 TEST REQUIREMENTS / LIMITS

FCC Part 2.1049; Occupied Bandwidth:

The occupied bandwidth, that is the frequency bandwidth such that, below its lower and above its upper frequency limits, the mean powers radiated are each equal to 0.5 percent of the total mean power radiated by a given emission shall be measured under the following conditions as applicable:

(h) Transmitters employing digital modulation techniques—when modulated by an input signal such that its amplitude and symbol rate represent the maximum rated conditions under which the equipment will be operated. The signal shall be applied through any filter networks, pseudo-random generators or other devices required in normal service. Additionally, the occupied bandwidth shall be shown for operation with any devices used for modifying the spectrum when such devices are optional at the discretion of the user.

(i) Transmitters designed for other types of modulation—when modulated by an appropriate signal of sufficient amplitude to be representative of the type of service in which used. A description of the input signal should be supplied.

RSS-GEN; 6.7 Occupied Bandwidth

The emission bandwidth (\times dB) is defined as the frequency range between two points, one above and one below the carrier frequency, at which the spectral density of the emission is attenuated \times dB below the maximum in-band spectral density of the modulated signal. Spectral density (power per unit bandwidth) is to be measured with a detector of resolution bandwidth in the range of 1% to 5% of the anticipated emission bandwidth, and a video bandwidth at least $3\times$ the resolution bandwidth.

When the occupied bandwidth limit is not stated in the applicable RSS or reference measurement method, the transmitted signal bandwidth shall be reported as the 99% emission bandwidth, as calculated or measured.

The transmitter shall be operated at its maximum carrier power measured under normal test conditions.

The span of the analyzer shall be set to capture all products of the modulation process, including the emission skirts.

The resolution bandwidth (RBW) shall be in the range of 1% to 5% of the occupied bandwidth (OBW) and video bandwidth (VBW) shall be approximately $3\times$ RBW.

Note: Video averaging is not permitted.

A peak, or peak hold, may be used in place of the sampling detector as this may produce a wider bandwidth than the actual bandwidth (worst-case measurement). Use of a peak hold may be necessary to determine the occupied bandwidth if the device is not transmitting continuously.

The trace data points are recovered and are directly summed in linear power level terms. The recovered amplitude data points, beginning at the lowest frequency, are placed in a running sum until 0.5% of the total is reached and that frequency recorded. The process is repeated for the highest frequency data points (starting at the highest frequency, at the right side of the span, and going down in frequency). This frequency is then recorded. The difference between the two recorded frequencies is the 99% occupied bandwidth.

5.19.3 TEST PROTOCOL

Ambient temperature: 20 - 25 °C
Relative humidity: 30 - 40 %

Radio Technology	Channel	Ressource Blocks / Subcarrier	Bandwidth (MHz)	Nominal BW [MHz]	26 dB BW [kHz]	99 % BW [kHz]
CAT-M1 eFDD 4 QPSK	low	6	1.4	1.4	-	1112.2
CAT-M1 eFDD 4 QPSK	mid	6	1.4	1.4	-	1112.2
CAT-M1 eFDD 4 QPSK	high	6	1.4	1.4	-	1100.2
CAT-M1 eFDD 4 16QAM	low	5	1.4	1.4	-	931.86
CAT-M1 eFDD 4 16QAM	mid	5	1.4	1.4	-	931.86
CAT-M1 eFDD 4 16QAM	high	5	1.4	1.4	-	949.9
CAT-M1 eFDD 8 QPSK	low	6	1.4	1.4	-	1100.2
CAT-M1 eFDD 8 QPSK	mid	6	1.4	1.4	-	1106.2
CAT-M1 eFDD 8 QPSK	high	6	1.4	1.4	-	1100.2
CAT-M1 eFDD 8 16QAM	low	5	1.4	1.4	-	937.88
CAT-M1 eFDD 8 16QAM	mid	5	1.4	1.4	-	931.86
CAT-M1 eFDD 8 16QAM	high	5	1.4	1.4	-	931.86
CAT-M1 eFDD 12 QPSK	low	6	1.4	1.4	-	1100.2
CAT-M1 eFDD 12 QPSK	mid	6	1.4	1.4	-	1094.2
CAT-M1 eFDD 12 QPSK	high	6	1.4	1.4	-	1100.2
CAT-M1 eFDD 12 16QAM	low	5	1.4	1.4	-	937.88
CAT-M1 eFDD 12 16QAM	mid	5	1.4	1.4	-	931.86
CAT-M1 eFDD 12 16QAM	high	5	1.4	1.4	-	931.86
CAT-M1 eFDD 13 QPSK	low	6	1.4	1.4	-	1100.2
CAT-M1 eFDD 13 QPSK	mid	6	1.4	1.4	-	1100.2
CAT-M1 eFDD 13 QPSK	high	6	1.4	1.4	-	1100.2
CAT-M1 eFDD 13 16QAM	low	5	1.4	1.4	-	931.86
CAT-M1 eFDD 13 16QAM	mid	5	1.4	1.4	-	937.88
CAT-M1 eFDD 13 16QAM	high	5	1.4	1.4	-	943.89
CAT-M1 eFDD 66 QPSK	low	6	1.4	1.4	-	1106.2
CAT-M1 eFDD 66 QPSK	mid	6	1.4	1.4	-	1100.2
CAT-M1 eFDD 66 QPSK	high	6	1.4	1.4	-	1106.2
CAT-M1 eFDD 66 16QAM	low	5	1.4	1.4	-	931.86
CAT-M1 eFDD 66 16QAM	mid	5	1.4	1.4	-	937.88
CAT-M1 eFDD 66 16QAM	high	5	1.4	1.4	-	943.89
NB-IoT eFDD 4 QPSK	low	12	0.2	0.2	-	186.37
NB-IoT eFDD 4 QPSK	mid	12	0.2	0.2	-	184.37

NB-IoT eFDD 4 QPSK	high	12	0.2	0.2	-	186.37
NB-IoT eFDD 4 BPSK	low	1	0.2	0.2	-	134.27
NB-IoT eFDD 4 BPSK	mid	1	0.2	0.2	-	136.27
NB-IoT eFDD 4 BPSK	high	1	0.2	0.2	-	132.26
NB-IoT eFDD 8 QPSK	low	12	0.2	0.2	-	188.38
NB-IoT eFDD 8 QPSK	mid	12	0.2	0.2	-	188.38
NB-IoT eFDD 8 QPSK	high	12	0.2	0.2	-	186.37
NB-IoT eFDD 8 BPSK	low	1	0.2	0.2	-	136.27
NB-IoT eFDD 8 BPSK	mid	1	0.2	0.2	-	136.27
NB-IoT eFDD 8 BPSK	high	1	0.2	0.2	-	134.27
NB-IoT eFDD 12 QPSK	low	12	0.2	0.2	-	186.37
NB-IoT eFDD 12 QPSK	mid	12	0.2	0.2	-	184.37
NB-IoT eFDD 12 QPSK	high	12	0.2	0.2	-	184.37
NB-IoT eFDD 12 BPSK	low	1	0.2	0.2	-	132.26
NB-IoT eFDD 12 BPSK	mid	1	0.2	0.2	-	132.26
NB-IoT eFDD 12 BPSK	high	1	0.2	0.2	-	132.26
NB-IoT eFDD 13 QPSK	low	12	0.2	0.2	-	186.37
NB-IoT eFDD 13 QPSK	mid	12	0.2	0.2	-	186.37
NB-IoT eFDD 13 QPSK	high	12	0.2	0.2	-	186.37
NB-IoT eFDD 13 BPSK	low	1	0.2	0.2	-	132.26
NB-IoT eFDD 13 BPSK	mid	1	0.2	0.2	-	134.27
NB-IoT eFDD 13 BPSK	high	1	0.2	0.2	-	134.27
NB-IoT eFDD 66 QPSK	low	12	0.2	0.2	-	186.37
NB-IoT eFDD 66 QPSK	mid	12	0.2	0.2	-	184.37
NB-IoT eFDD 66 QPSK	high	12	0.2	0.2	-	188.38
NB-IoT eFDD 66 BPSK	low	1	0.2	0.2	-	136.27
NB-IoT eFDD 66 BPSK	mid	1	0.2	0.2	-	132.26
NB-IoT eFDD 66 BPSK	high	1	0.2	0.2	-	126.25
NB-IoT eFDD 71 QPSK	low	12	0.2	0.2	-	186.37
NB-IoT eFDD 71 QPSK	mid	12	0.2	0.2	-	186.37
NB-IoT eFDD 71 QPSK	high	12	0.2	0.2	-	186.37
NB-IoT eFDD 71 BPSK	low	1	0.2	0.2	-	138.28
NB-IoT eFDD 71 BPSK	mid	1	0.2	0.2	-	134.27
NB-IoT eFDD 71 BPSK	high	1	0.2	0.2	-	138.28
NB-IoT eFDD 85 QPSK	low	12	0.2	0.2	-	186.37
NB-IoT eFDD 85 QPSK	mid	12	0.2	0.2	-	186.37
NB-IoT eFDD 85 QPSK	high	12	0.2	0.2	-	184.37
NB-IoT eFDD 85 BPSK	low	1	0.2	0.2	-	132.26
NB-IoT eFDD 85 BPSK	mid	1	0.2	0.2	-	128.26
NB-IoT eFDD 85 BPSK	high	1	0.2	0.2	-	132.26

Remark: Please see next sub-clause for the measurement plot.

5.19.4 MEASUREMENT PLOT

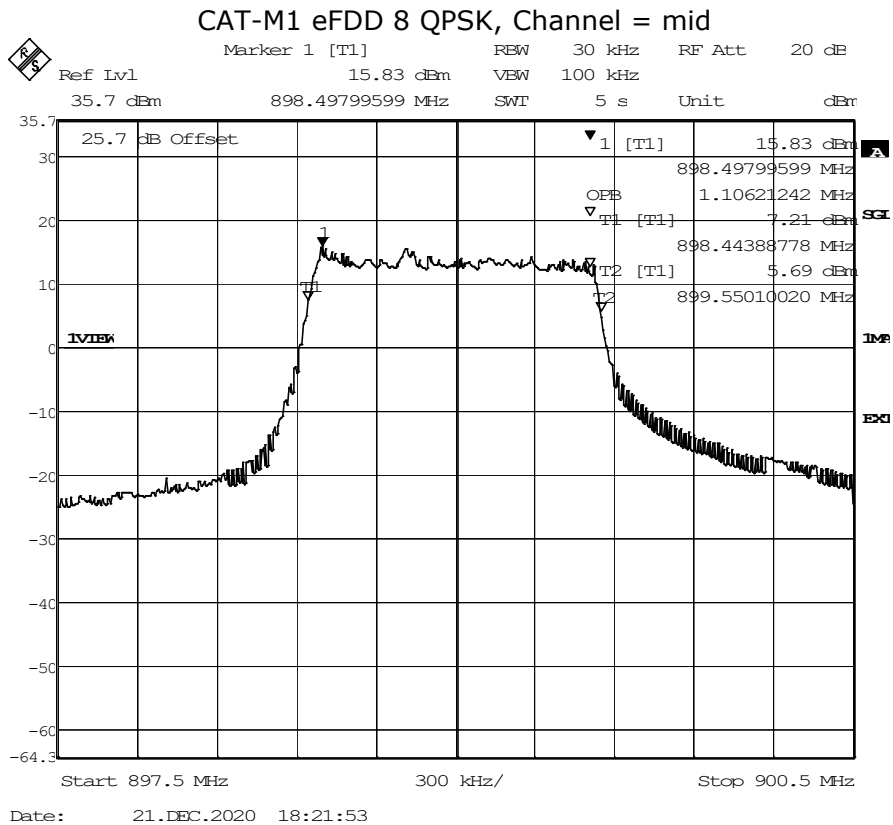
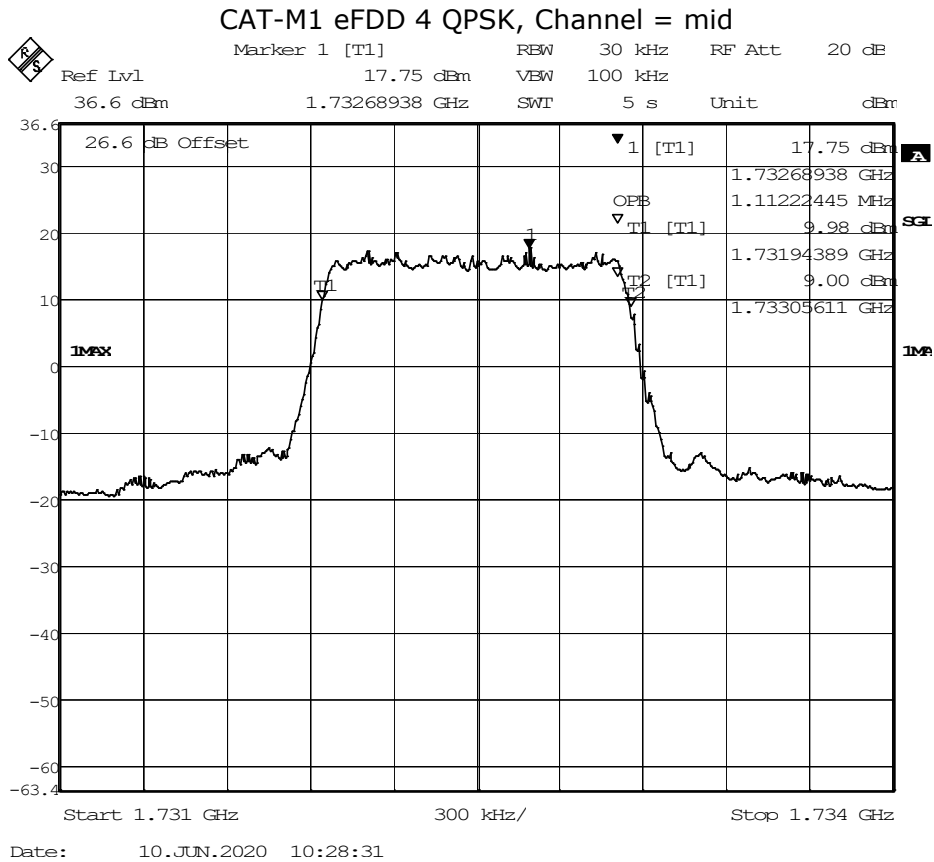

CAT-M1 eFDD 12 QPSK, Channel = low

R/S
 Marker 1 [T1] REW 30 kHz RF Att 20 dB
 Ref Lvl 17.30 dBm VEW 100 kHz
 36.1 dBm 699.51062124 MHz SWT 5 s Unit dBm

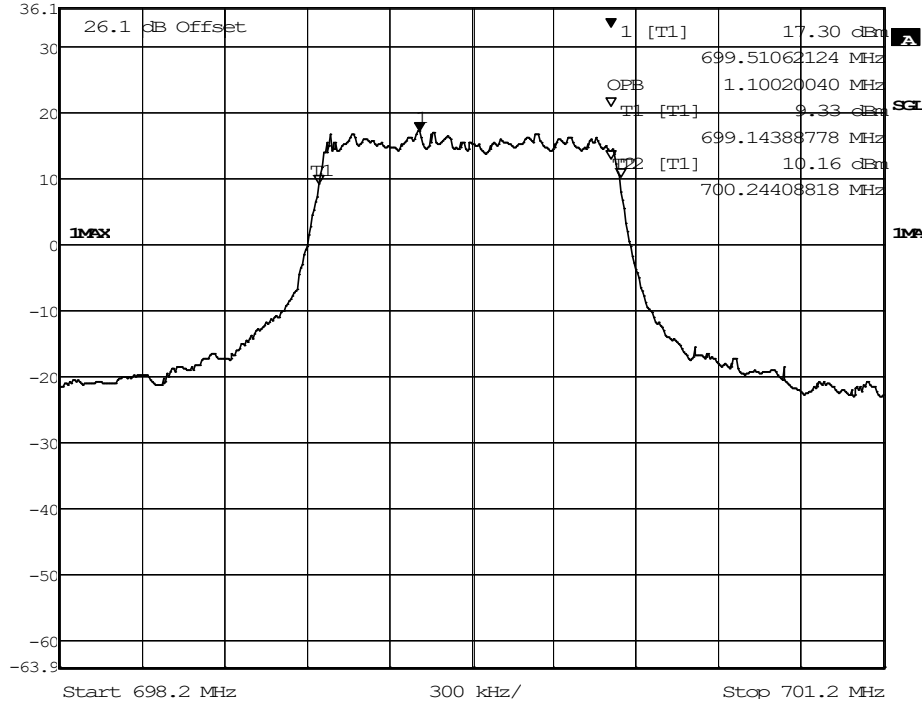

Date: 10.JUN.2020 11:23:25

CAT-M1 eFDD 13 QPSK, Channel = mid

R/S
 Marker 1 [T1] REW 30 kHz RF Att 20 dB
 Ref Lvl 18.19 dBm VEW 100 kHz
 36.1 dBm 780.87995992 MHz SWT 5 s Unit dBm

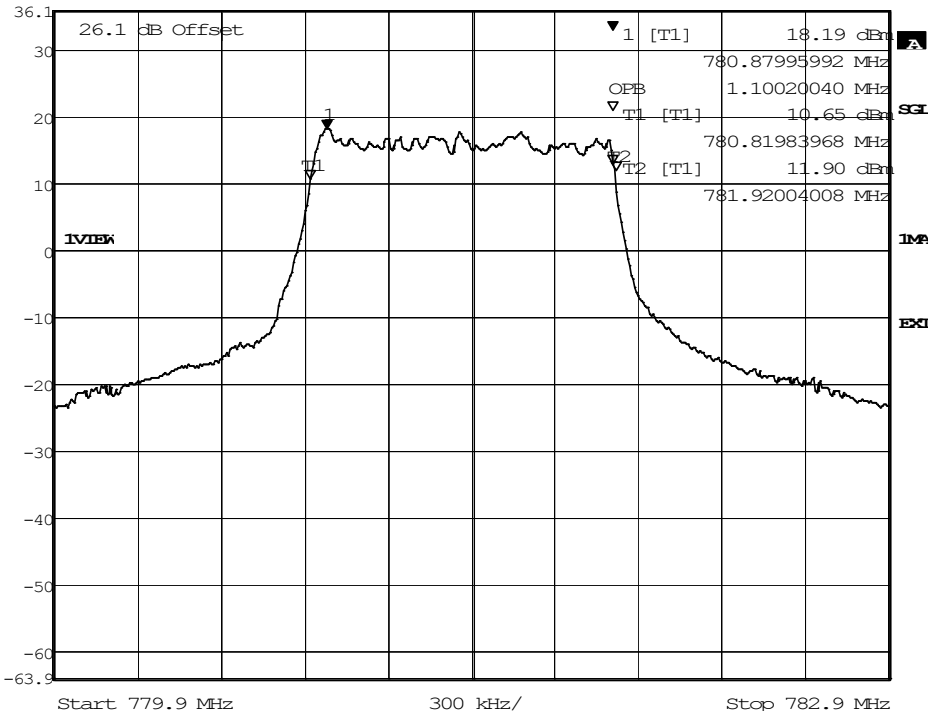

Date: 14.JUL.2020 15:09:49

CAT-M1 eFDD 66 QPSK, Channel = mid

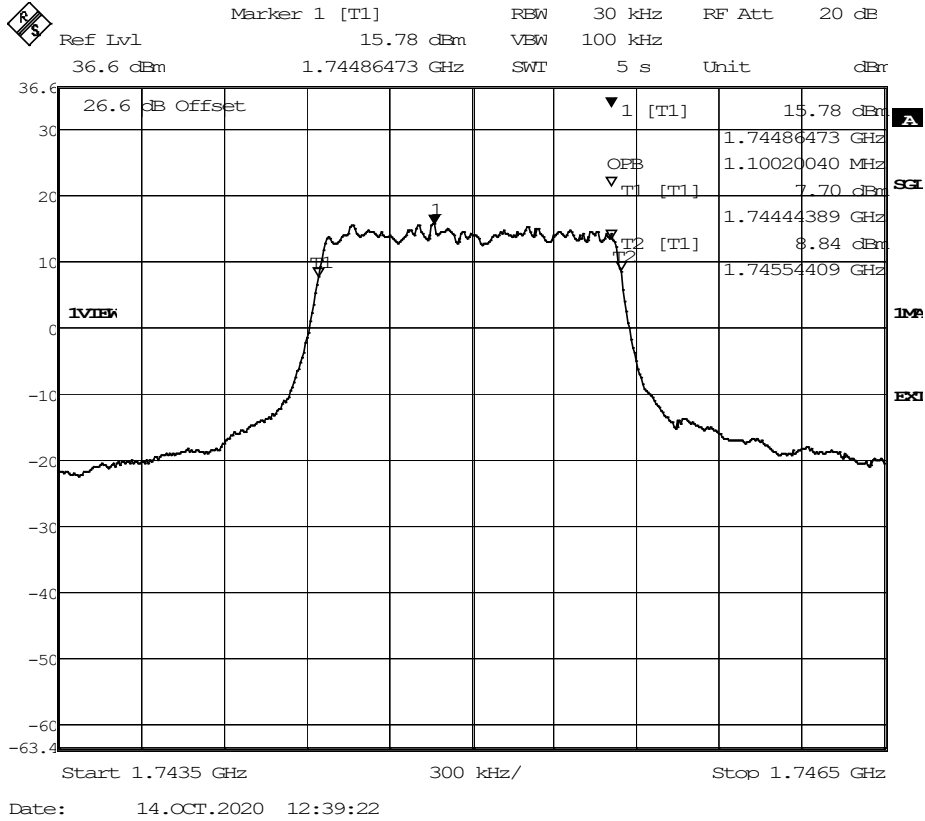

NB-IoT eFDD 4 QPSK, Channel = mid

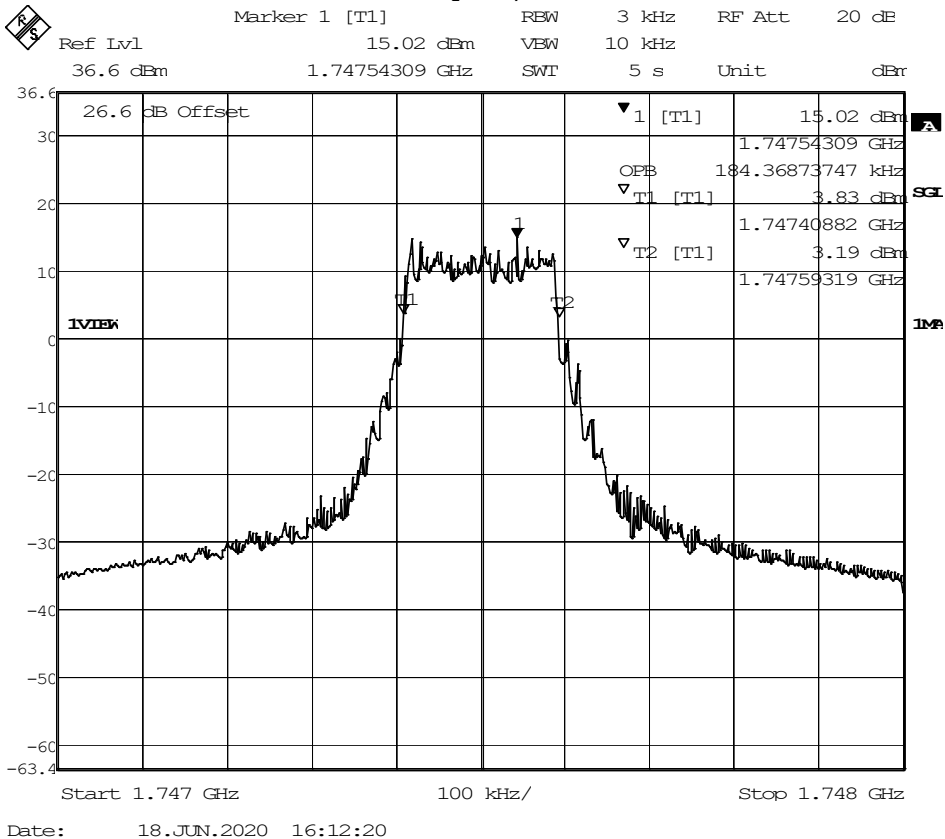

NB-IoT eFDD 8 QPSK, Channel = mid

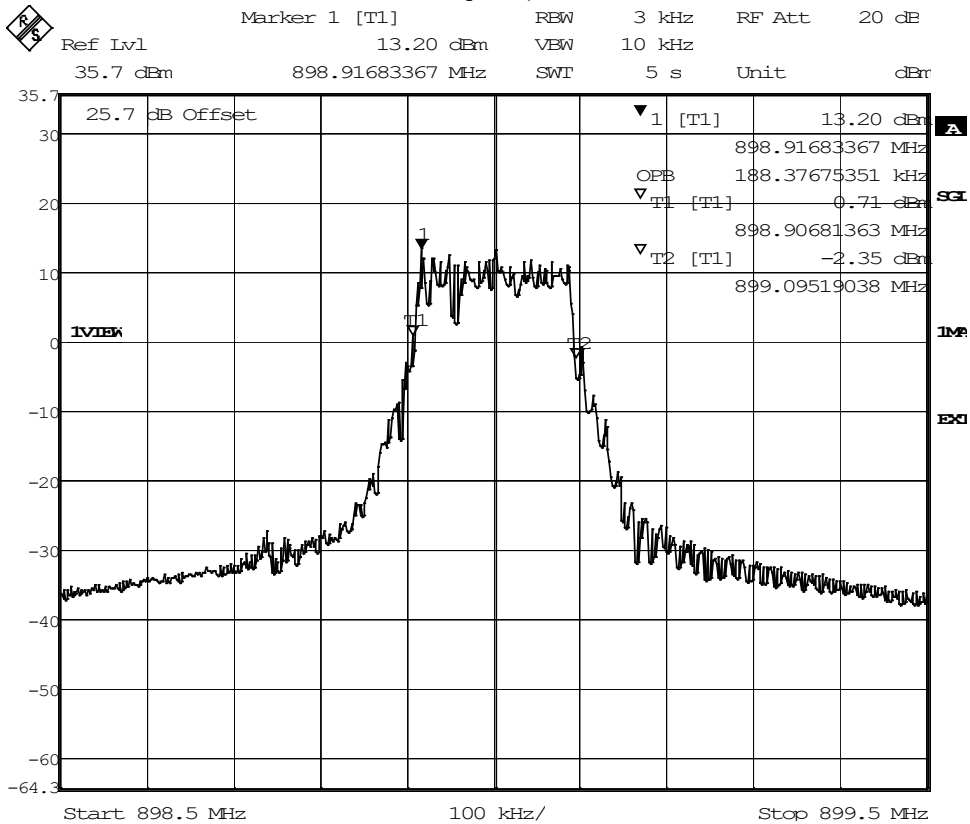

Date: 21.DEC.2020 15:54:59

NB-IoT eFDD 12 QPSK, Channel = mid

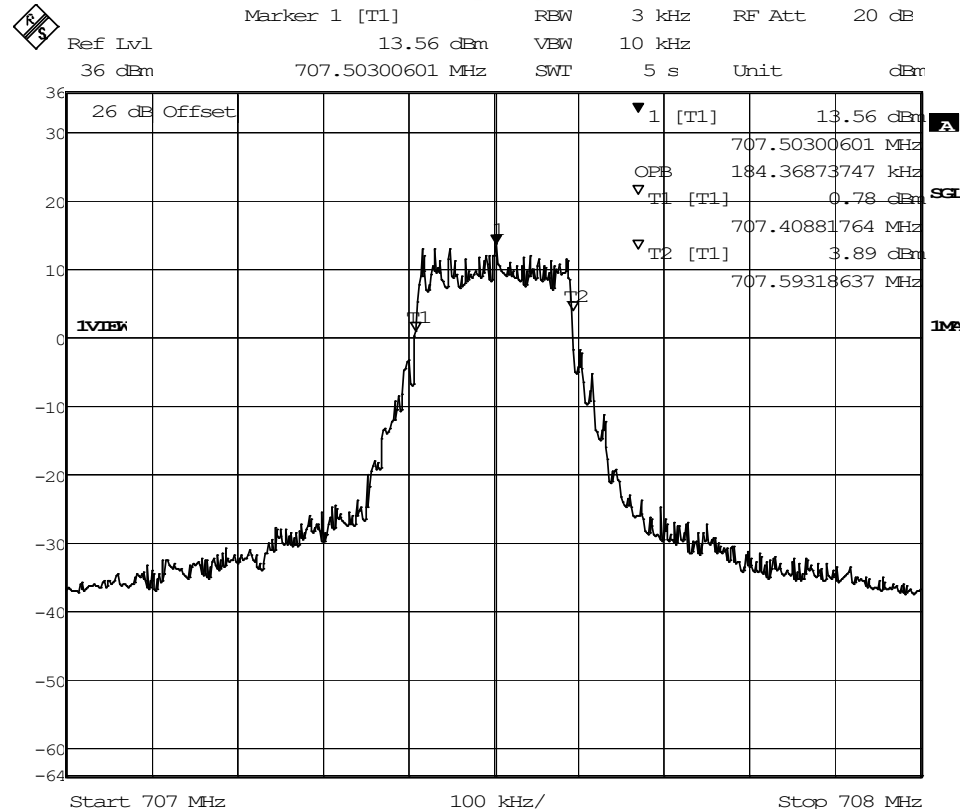

Date: 18.JUN.2020 16:24:35

NB-IoT eFDD 13 QPSK, Channel = mid

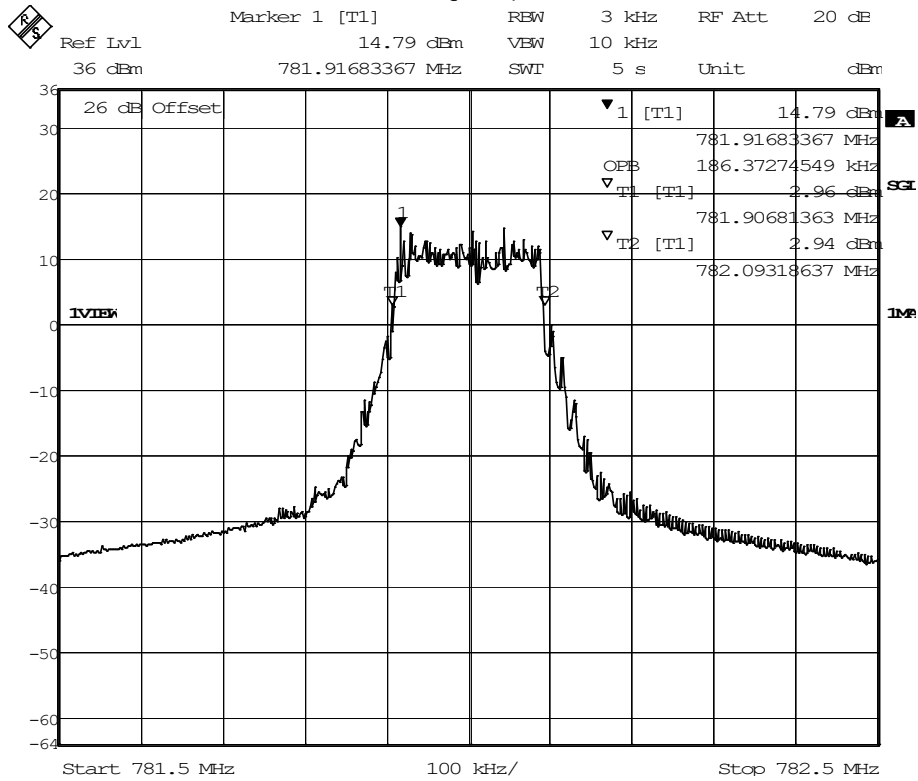

Date: 18.JUN.2020 16:28:50

NB-IoT eFDD 66 QPSK, Channel = mid

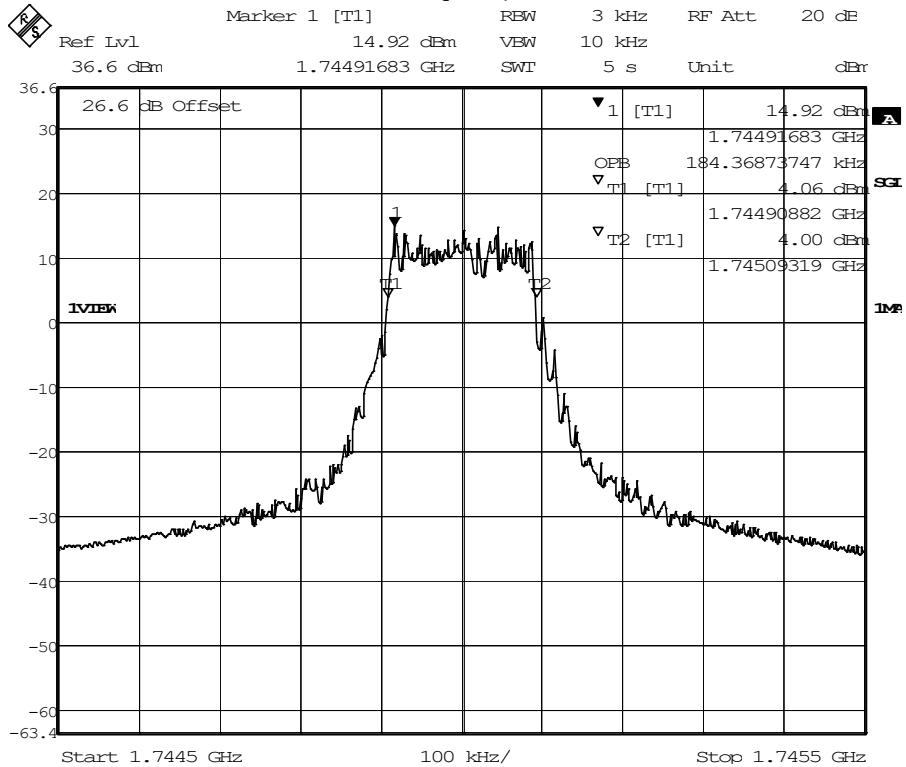

Date: 18.JUN.2020 16:43:04

NB-IoT eFDD 71 QPSK, Channel = mid

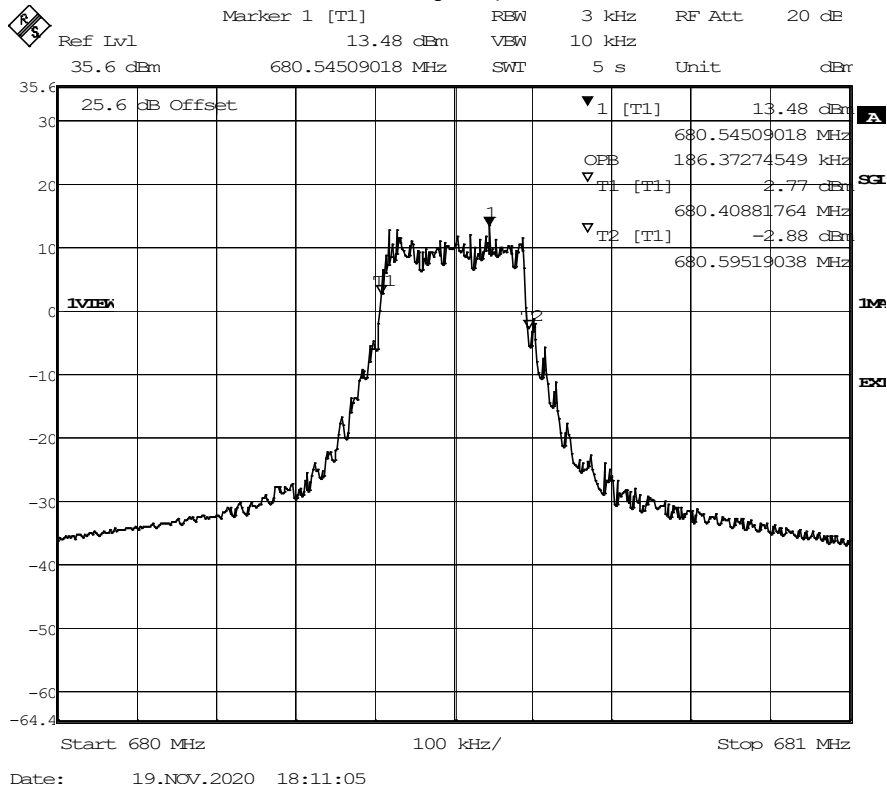

NB-IoT eFDD 85 QPSK, Channel = mid

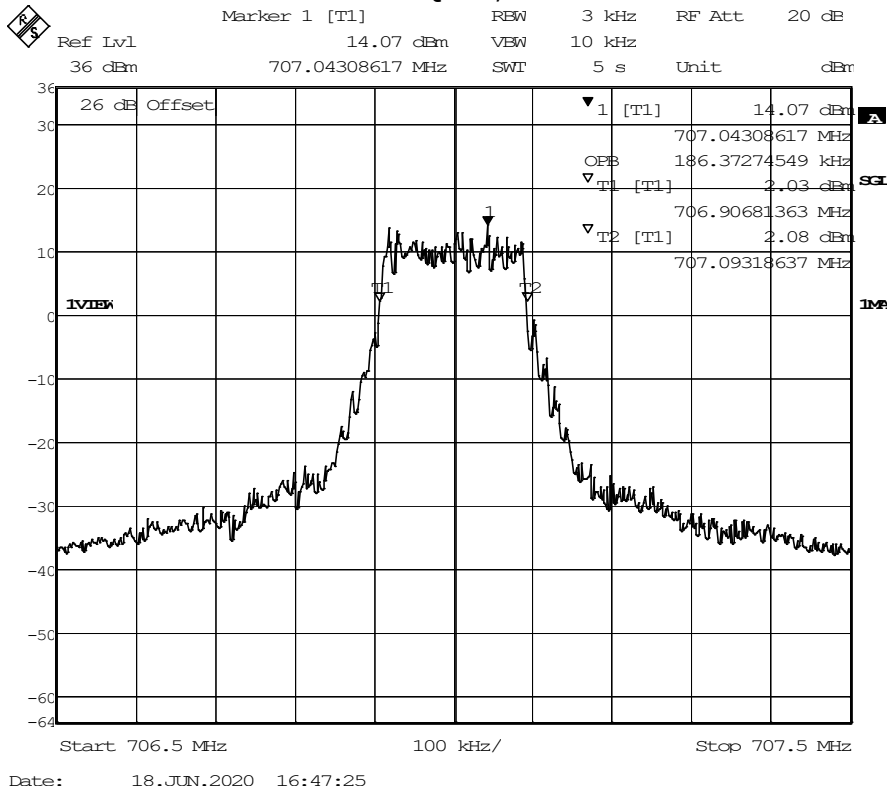

5.19.5 TEST EQUIPMENT USED

- Radio Lab

5.20 BAND EDGE COMPLIANCE

Standard **FCC PART 27 Subpart C**

The test was performed according to:
ANSI C63.26: 2015

5.20.1 TEST DESCRIPTION

This test case is intended to demonstrate compliance to the applicable conducted spurious emission test case per § 2.1051 and RSS-GEN 6.13. The limit comes from the applicable rule part and ISSED RSS-Standard for the operating band of the cellular device.

The EUT was connected to the test setup according to the following diagram:

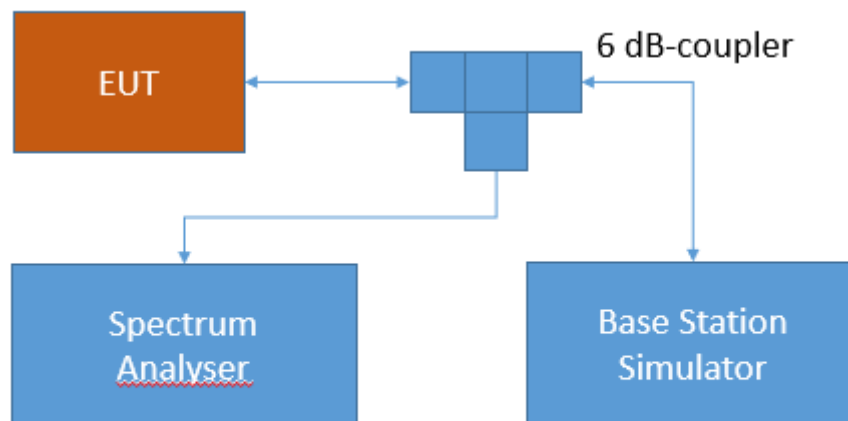

Test Setup FCC Part 22/24/27/90 Cellular;
Band edge compliance

The attenuation of the measuring and stimulus path are known for each measured frequency and are considered.

The Spectrum Analyzer settings can be directly found in the measurement diagrams.

5.20.2 TEST REQUIREMENTS / LIMITS

FCC Part 2.1051; Measurement required: Spurious emissions at antenna terminal:

The radio frequency voltage or powers generated within the equipment and appearing on a spurious frequency shall be checked at the equipment output terminals when properly loaded with a suitable artificial antenna. Curves or equivalent data shall show the magnitude of each harmonic and other spurious emission that can be detected when the equipment is operated under the conditions specified in §2.1049 as appropriate. The magnitude of spurious emissions which are attenuated more than 20 dB below the permissible value need not be specified.

FCC Part 27; Miscellaneous Wireless Communication Services

Subpart C – Technical standards

§27.53 - Emission limits

Band 13

(c) For operations in the 746-758 MHz band and the 776-788 MHz band, the power of any emission outside the licensee's frequency band(s) of operation shall be attenuated below the transmitter power (P) within the licensed band(s) of operation, measured in watts, in accordance with the following:

(1) On any frequency outside the 746-758 MHz band, the power of any emission shall be attenuated outside the band below the transmitter power (P) by at least $43 + 10 \log (P)$ dB;

(2) On any frequency outside the 776-788 MHz band, the power of any emission shall be attenuated outside the band below the transmitter power (P) by at least $43 + 10 \log (P)$ dB;

(3) On all frequencies between 763-775 MHz and 793-805 MHz, by a factor not less than $76 + 10 \log (P)$ dB in a 6.25 kHz band segment, for base and fixed stations;

(4) On all frequencies between 763-775 MHz and 793-805 MHz, by a factor not less than $65 + 10 \log (P)$ dB in a 6.25 kHz band segment, for mobile and portable stations;

(5) Compliance with the provisions of paragraphs (c)(1) and (c)(2) of this section is based on the use of measurement instrumentation employing a resolution bandwidth of 100 kHz or greater. However, in the 100 kHz bands immediately outside and adjacent to the frequency block, a resolution bandwidth of at least 30 kHz may be employed;

(f) For operations in the 746-758 MHz, 775-788 MHz, and 805-806 MHz bands, emissions in the band 1559-1610 MHz shall be limited to -70 dBW/MHz equivalent isotropically radiated power (EIRP) for wideband signals, and -80 dBW EIRP for discrete emissions of less than 700 Hz bandwidth. For the purpose of equipment authorization, a transmitter shall be tested with an antenna that is representative of the type that will be used with the equipment in normal operation.

(6) Compliance with the provisions of paragraphs (c)(3) and (c)(4) of this section is based on the use of measurement instrumentation such that the reading taken with any resolution bandwidth setting should be adjusted to indicate spectral energy in a 6.25 kHz segment.

RSS-130; 4.7.1 General unwanted emissions limits

The unwanted emissions in any 100 kHz bandwidth on any frequency outside the low frequency edge and the high frequency edge of each frequency block range(s), shall be attenuated below the transmitter power, P (dBW), by at least $43 + 10 \log_{10} p$ (watts), dB. However, in the 100 kHz band immediately outside of the equipment's frequency block range, a resolution bandwidth of 30 kHz may be employed.

RSS-130; 4.7.2 Additional unwanted emissions limits

In addition to the limit outlined in section 4.7.1 above, equipment operating in the frequency bands 746-756 MHz and 777-787 MHz shall also comply with the following restrictions:

- a. the power of any unwanted emissions in any 6.25 kHz bandwidth for all frequencies between 763-775 MHz and 793-806 MHz shall be attenuated below the transmitter power, P (dBW), by at least:
 - i. $76 + 10 \log_{10} p$ (watts), dB, for base and fixed equipment and
 - ii. $65 + 10 \log_{10} p$ (watts), dB, for mobile and portable equipment
- b. the e.i.r.p. in the band 1559-1610 MHz shall not exceed -70 dBW/MHz for wideband signal and -80 dBW for discrete emission with bandwidth less than 700 Hz.

Band 12:

(g) For operations in the 600 MHz band and the 698-746 MHz band, the power of any emission outside a licensee's frequency band(s) of operation shall be attenuated below the transmitter power (P) within the licensed band(s) of operation, measured in watts, by at least $43 + 10 \log(P)$ dB. Compliance with this provision is based on the use of measurement instrumentation employing a resolution bandwidth of 100 kilohertz or greater. However, in the 100 kilohertz bands immediately outside and adjacent to a licensee's frequency block, a resolution bandwidth of at least 30 kHz may be employed.

RSS-130; 4.7.1 General unwanted emissions limits

The unwanted emissions in any 100 kHz bandwidth on any frequency outside the low frequency edge and the high frequency edge of each frequency block range(s), shall be attenuated below the transmitter power, P (dBW), by at least $43 + 10 \log_{10} p$ (watts), dB. However, in the 100 kHz band immediately outside of the equipment's frequency block range, a resolution bandwidth of 30 kHz may be employed.

RSS-130; 4.7.2 Additional unwanted emissions limits

In addition to the limit outlined in section 4.7.1 above, equipment operating in the frequency bands 746-756 MHz and 777-787 MHz shall also comply with the following restrictions:

- a. the power of any unwanted emissions in any 6.25 kHz bandwidth for all frequencies between 763-775 MHz and 793-806 MHz shall be attenuated below the transmitter power, P (dBW), by at least:
 - i. $76 + 10 \log_{10} p$ (watts), dB, for base and fixed equipment and
 - ii. $65 + 10 \log_{10} p$ (watts), dB, for mobile and portable equipment
- b. the e.i.r.p. in the band 1559-1610 MHz shall not exceed -70 dBW/MHz for wideband signal and -80 dBW for discrete emission with bandwidth less than 700 Hz.

Band 4/10/66:

(h) *AWS emission limits— (1) General protection levels.* Except as otherwise specified below, for operations in the 1695-1710 MHz, 1710-1755 MHz, 1755-1780 MHz, 1915-1920 MHz, 1995-2000 MHz, 2000-2020 MHz, 2110-2155 MHz, 2155-2180 MHz, and 2180-2200 bands, the power of any emission outside a licensee's frequency block shall be attenuated below the transmitter power (P) in watts by at least $43 + 10 \log_{10}(P)$ dB.

RSS-139; 6.6 Transmitter Unwanted Emissions

Equipment shall comply with the limits in (i) and (ii) below.

- i. In the first 1.0 MHz bands immediately outside and adjacent to the equipment's smallest operating frequency block, which can contain the equipment's occupied bandwidth, the emission power per any 1% of the emission bandwidth shall be attenuated below the transmitter output power P (in dBW) by at least $43 + 10 \log_{10} p$ (watts) dB.
- ii. After the first 1.0 MHz outside the equipment's smallest operating frequency block, which can contain the equipment's occupied bandwidth, the emission power in any 1 MHz bandwidth shall be attenuated below the transmitter output power P (in dBW) by at least $43 + 10 \log_{10} p$ (watts) dB.

Band 7:

(m) For BRS and EBS stations, the power of any emissions outside the licensee's frequency bands of operation shall be attenuated below the transmitter power (P) measured in watts in accordance with the standards below. If a licensee has multiple contiguous channels, out-of-band emissions shall be measured from the upper and lower edges of the contiguous channels.

(4) For mobile digital stations, the attenuation factor shall be not less than $40 + 10 \log (P)$ dB on all frequencies between the channel edge and 5 megahertz from the channel edge, $43 + 10 \log (P)$ dB on all frequencies between 5 megahertz and X megahertz from the channel edge, and $55 + 10 \log (P)$ dB on all frequencies more than X megahertz from the channel edge, where X is the greater of 6 megahertz or the actual emission bandwidth as defined in paragraph (m)(6) of this section. In addition, the attenuation factor shall not be less than $43 + 10 \log (P)$ dB on all frequencies between 2490.5 MHz and 2496 MHz and $55 + 10 \log (P)$ dB at or below 2490.5 MHz. Mobile Satellite Service licensees operating on frequencies below 2495 MHz may also submit a documented interference complaint against BRS licensees operating on channel BRS Channel 1 on the same terms and conditions as adjacent channel BRS or EBS licensees.

RSS-199; 4.5 Transmitter unwanted emissions

In the 1 MHz band immediately outside and adjacent to the channel edge, the unwanted emission power shall be measured with a resolution bandwidth of at least 1% of the occupied bandwidth for base station and fixed subscriber equipment, and 2% for mobile subscriber equipment. Beyond the 1 MHz band, a resolution bandwidth of 1 MHz shall be used. A narrower resolution bandwidth can be used, provided that the measured power is integrated over the full required measurement bandwidth of 1 MHz, or 1% or 2% of the occupied bandwidth, as applicable.

Equipment shall comply with the following unwanted emission limits:

b. for mobile subscriber equipment, the power of any unwanted emissions measured as above shall be attenuated (in dB) below the transmitter power, P (dBW), by at least:

$40 + 10 \log_{10} p$ from the channel edges to 5 MHz away

$43 + 10 \log_{10} p$ between 5 MHz and X MHz from the channel edges, and

$55 + 10 \log_{10} p$ at X MHz and beyond from the channel edges

In addition, the attenuation shall not be less than $43 + 10 \log_{10} p$ on all frequencies between 2490.5 MHz and 2496 MHz, and $55 + 10 \log_{10} p$ at or below 2490.5 MHz.

In (b), p is the transmitter power measured in watts and X is 6 MHz or the equipment occupied bandwidth, whichever is greater.

Band 17:

(g) For operations in the 600 MHz band and the 698-746 MHz band, the power of any emission outside a licensee's frequency band(s) of operation shall be attenuated below the transmitter power (P) within the licensed band(s) of operation, measured in watts, by at least $43 + 10 \log(P)$ dB. Compliance with this provision is based on the use of measurement instrumentation employing a resolution bandwidth of 100 kilohertz or greater. However, in the 100 kilohertz bands immediately outside and adjacent to a licensee's frequency block, a resolution bandwidth of at least 30 kHz may be employed.

RSS-130; 4.7.1 General unwanted emissions limits

The unwanted emissions in any 100 kHz bandwidth on any frequency outside the low frequency edge and the high frequency edge of each frequency block range(s), shall be attenuated below the transmitter power, P (dBW), by at least $43 + 10 \log_{10} p$ (watts), dB. However, in the 100 kHz band immediately outside of the equipment's frequency block range, a resolution bandwidth of 30 kHz may be employed.

RSS-130; 4.7.2 Additional unwanted emissions limits

In addition to the limit outlined in section 4.7.1 above, equipment operating in the frequency bands 746-756 MHz and 777-787 MHz shall also comply with the following restrictions:

- a. the power of any unwanted emissions in any 6.25 kHz bandwidth for all frequencies between 763-775 MHz and 793-806 MHz shall be attenuated below the transmitter power, P (dBW), by at least:
 - i. $76 + 10 \log_{10} p$ (watts), dB, for base and fixed equipment and
 - ii. $65 + 10 \log_{10} p$ (watts), dB, for mobile and portable equipment
- b. the e.i.r.p. in the band 1559-1610 MHz shall not exceed -70 dBW/MHz for wideband signal and -80 dBW for discrete emission with bandwidth less than 700 Hz.

Subpart P – Regulations Governing Licensing and Use of 900 MHz Broadband Service in the 897.5 – 900.5 MHz and 936.5 - 939.5 MHz Bands

§27.1509 Emission limits

The power of any emission outside a licensee's frequency band(s) of operation shall be attenuated below the transmitter power (P) in watts by at least the following amounts:

- (a) For 900 MHz broadband operations in 897.5-900.5 MHz band by at least $43 + 10 \log(P)$ dB.
- (b) For 900 MHz broadband operations in the 936.5-939.5 MHz band, by at least $50 + 10 \log(P)$ dB.
- (c) Compliance with the provisions of paragraphs (a) and (b) of this section is based on the use of measurement instrumentation employing a resolution bandwidth of 100 kHz or greater. However, in the 100 kHz bands immediately outside and adjacent to the licensee's band, a resolution bandwidth of at least 1 percent of the emission bandwidth of the fundamental emission of the transmitter may be employed. The emission bandwidth is defined as the width of the signal between two points, one below the carrier center frequency and one above the carrier center frequency, outside of which all emissions are attenuated at least 26 dB below the transmitter power.
- (d) The measurements of emission power can be expressed in peak or average values, provided they are expressed in the same parameters as the transmitter power.
- (e) When an emission outside of the authorized bandwidth causes harmful interference, the Commission may, at its discretion, require greater attenuation than specified in this section.

5.20.3 TEST PROTOCOL

Ambient temperature: 20 - 25 °C
 Relative humidity: 30 - 40 %

Radio Technology	Channel	Ressource Blocks	Bandwidth (MHz)	Peak [dBm]	Average [dBm]	RMS [dBm]	Limit /dBm	Margin to Limit /dB
CAT-M1 eFDD 4 QPSK	low	6	1.4	-15.54	-28.96	-27.7	-13	14.7
CAT-M1 eFDD 4 QPSK	high	6	1.4	-13.55	-29.42	-26.92	-13	13.92
CAT-M1 eFDD 4 16QAM	low	5	1.4	-18.97	-28.96	-27.7	-13	14.7
CAT-M1 eFDD 4 16QAM	high	5	1.4	-17.06	-30.02	-27.84	-13	14.84
CAT-M1 eFDD 8 QPSK	low	6	1.4	-21.46	-32.23	-30.84	-13	17.84
CAT-M1 eFDD 8 QPSK	high	6	1.4	-15.55	-33.44	-29.92	-13	16.92
CAT-M1 eFDD 8 16QAM	low	5	1.4	-20.78	-32.23	-30.22	-13	17.22
CAT-M1 eFDD 8 16QAM	high	5	1.4	-20.87	-33.44	-30.84	-13	17.84
CAT-M1 eFDD 12 QPSK	low	6	1.4	-14.83	-26.5	-24.92	-13	11.92
CAT-M1 eFDD 12 QPSK	high	6	1.4	-12.13	-27.31	-25.25	-13	12.25
CAT-M1 eFDD 12 16QAM	low	5	1.4	-12.63	-25.76	-24	-13	11
CAT-M1 eFDD 12 16QAM	high	5	1.4	-13.25	-26.5	-25.08	-13	12.08
CAT-M1 eFDD 13 QPSK	low	6	1.4	-15.61	-30.52	-28.58	-13	15.58
CAT-M1 eFDD 13 QPSK	high	6	1.4	-18.06	-43.9	-35.94	-13	22.94
CAT-M1 eFDD 13 16QAM	low	5	1.4	-19.36	-45.49	-36.54	-13	23.54
CAT-M1 eFDD 13 16QAM	high	5	1.4	-15.38	-45.49	-38.64	-13	25.64
CAT-M1 eFDD 66 QPSK	low	6	1.4	-17.93	-31.46	-30.12	-13	17.12
CAT-M1 eFDD 66 QPSK	high	6	1.4	-15.7	-32.12	-29.42	-13	16.42
CAT-M1 eFDD 66 16QAM	low	5	1.4	-20.94	-31.46	-30.44	-13	17.44
CAT-M1 eFDD 66 16QAM	high	5	1.4	-20.17	-36.04	-33.39	-13	20.39
NB-IoT eFDD 4 QPSK	low	12	0.2	-7.4	-28.7	-19.15	-13	6.15
NB-IoT eFDD 4 QPSK	high	12	0.2	-9.94	-32.94	-24	-13	11
NB-IoT eFDD 4 BPSK	low	1	0.2	-9.08	-18.72	-16.27	-13	3.27
NB-IoT eFDD 4 BPSK	high	1	0.2	-25.12	-31.01	-31.01	-13	18.01
NB-IoT eFDD 8 QPSK	low	12	0.2	-8.64	-31.57	-19.61	-13	6.61
NB-IoT eFDD 8 QPSK	high	12	0.2	-10.36	-30.04	-18.65	-13	5.65
NB-IoT eFDD 8 BPSK	low	1	0.2	-6.81	-13.18	-13.72	-13	0.72
NB-IoT eFDD 8 BPSK	high	1	0.2	-9.66	-18.96	-16.4	-13	3.4
NB-IoT eFDD 12 QPSK	low	12	0.2	-34.09	-64	-59.57	-13	46.57
NB-IoT eFDD 12 QPSK	high	12	0.2	-10.42	-45.59	-33.12	-13	20.12
NB-IoT eFDD 12 BPSK	low	1	0.2	-44.27	-64	-64	-13	51
NB-IoT eFDD 12 BPSK	high	1	0.2	-37.87	-47.52	-47.52	-13	34.52
NB-IoT eFDD 13 QPSK	low	12	0.2	-33	-63.9	-59.47	-13	46.47
NB-IoT eFDD 13 QPSK	high	12	0.2	-34	-63.9	-58.2	-13	45.2
NB-IoT eFDD 13 BPSK	low	1	0.2	-44.08	-63.9	-63.9	-13	50.9
NB-IoT eFDD 13 BPSK	high	1	0.2	-44.1	-63.8	-60.7	-13	47.7
NB-IoT eFDD 66 QPSK	low	12	0.2	-4.94	-33.49	-18.56	-13	5.56
NB-IoT eFDD 66 QPSK	high	12	0.2	-6.41	-26.5	-22.98	-13	9.98
NB-IoT eFDD 66 BPSK	low	1	0.2	-6.84	-14.61	-18.89	-13	5.89
NB-IoT eFDD 66 BPSK	high	1	0.2	-28.18	-36.04	-35.44	-13	22.44
NB-IoT eFDD 71 QPSK	low	12	0.2	-11.49	-45.99	-32.01	-13	19.01

NB-IoT eFDD 71 QPSK	high	12	0.2	-9.81	-45.99	-33.52	-13	20.52
NB-IoT eFDD 71 BPSK	low	1	0.2	-18.02	-44.4	-40.88	-13	27.88
NB-IoT eFDD 71 BPSK	high	1	0.2	-17	-47.92	-47.92	-13	34.92
NB-IoT eFDD 85 QPSK	low	12	0.2	-12.99	-45.59	-33.54	-13	20.54
NB-IoT eFDD 85 QPSK	high	12	0.2	-10.54	-45.59	-33.54	-13	20.54
NB-IoT eFDD 85 BPSK	low	1	0.2	-22.12	-47.52	-42.66	-13	29.66
NB-IoT eFDD 85 BPSK	high	1	0.2	-35.81	-45.59	-42.66	-13	29.66

Remark: Please see next sub-clause for the measurement plot.

5.20.4 MEASUREMENT PLOT (SHOWING THE HIGHEST VALUE, "WORST CASE")

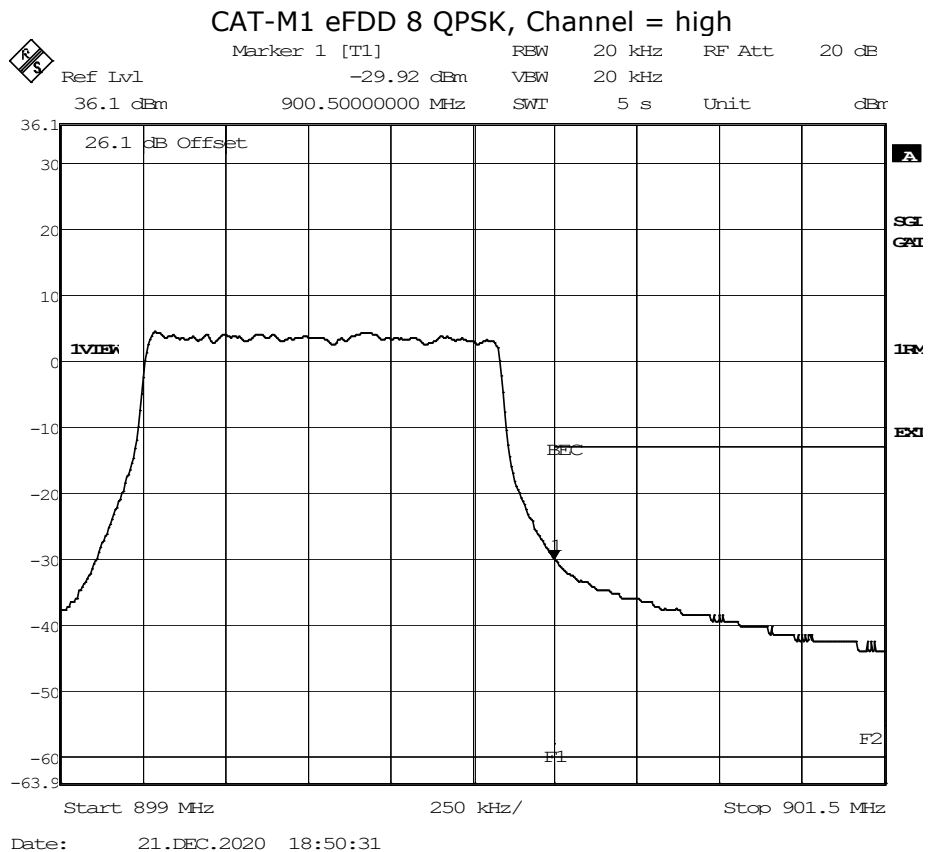
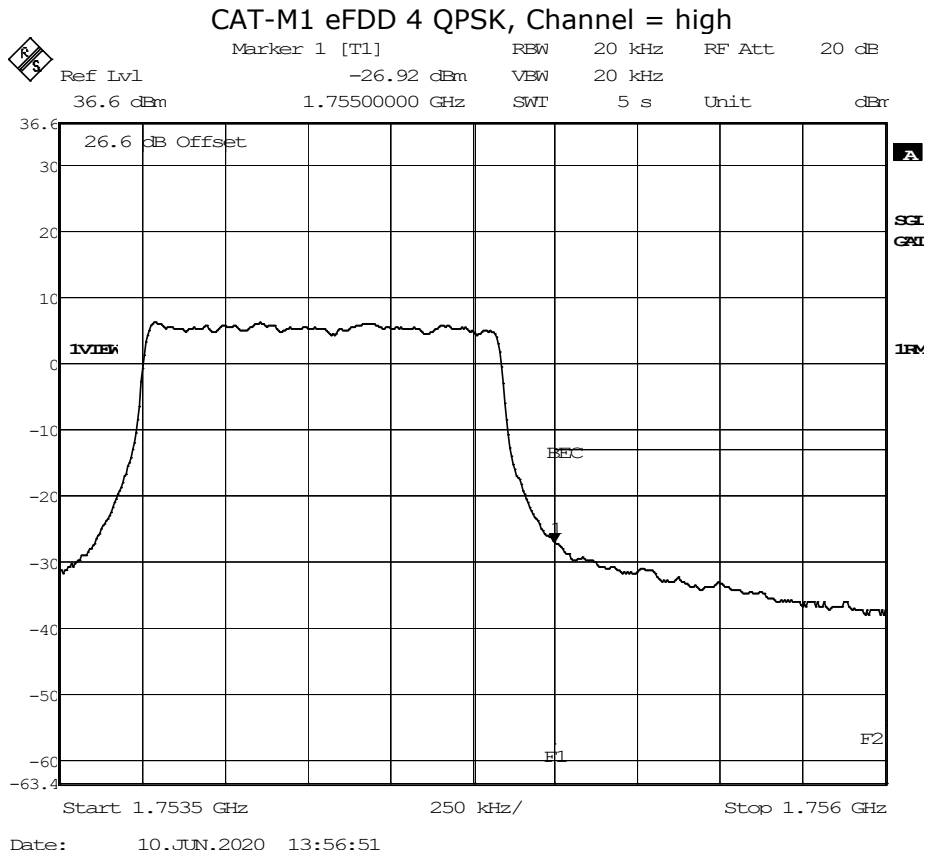

CAT-M1 eFDD 12 16QAM, Channel = low

 Marker 1 [T1] RBW 30 kHz RF Att 20 dB
 Ref Lvl -24.00 dBm VBW 30 kHz
 36 dBm 699.00000000 MHz SWI 5 s Unit dBm

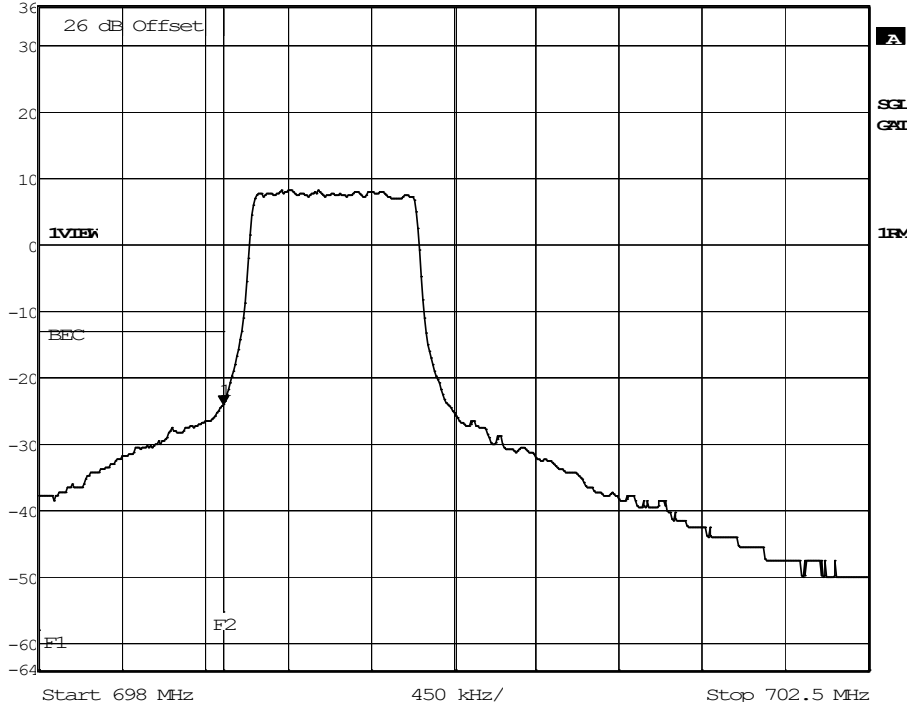

Date: 10.JUN.2020 15:53:14

CAT-M1 eFDD 13 QPSK, Channel = low

 Marker 1 [T1] RBW 30 kHz RF Att 20 dB
 Ref Lvl -28.58 dBm VBW 30 kHz
 36.1 dBm 777.00000000 MHz SWI 5 s Unit dBm

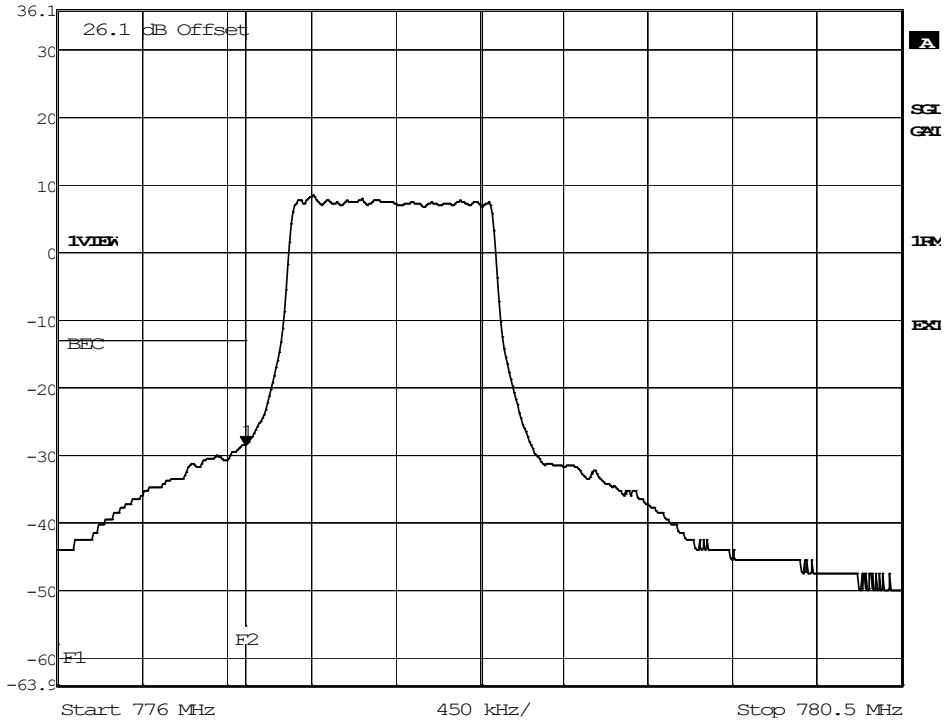

Date: 13.AUG.2020 19:56:04

CAT-M1 eFDD 66 QPSK, Channel = high

	Marker 1 [T1]	REW	20 kHz	RF Att	20 dB
	Ref Lvl	-29.42 dBm	VBW	20 kHz	
	36.6 dBm	1.78000000 GHz	SWT	5 s	Unit dBm

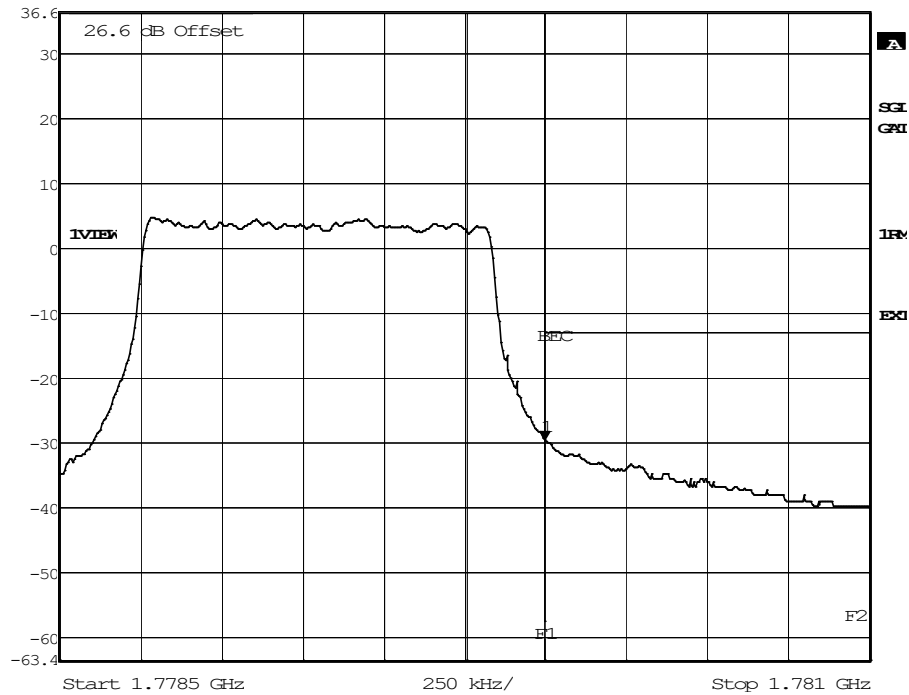

Date: 14.OCT.2020 13:41:10

NB-IoT eFDD 4 BPSK, Channel = low

	Marker 1 [T1]	REW	2 kHz	RF Att	20 dB
	Ref Lvl	-16.27 dBm	VBW	2 kHz	
	36.5 dBm	1.71000000 GHz	SWT	5 s	Unit dBm

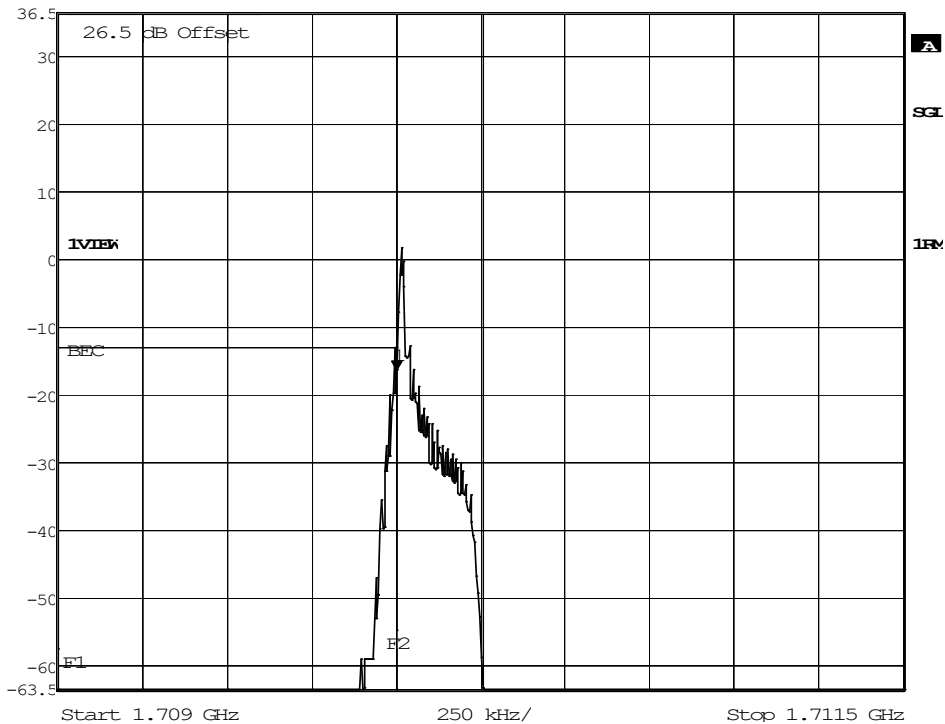

Date: 24.JUN.2020 11:15:34

NB-IoT eFDD 8 BPSK, Channel = low

RS
 Marker 1 [T1] RBW 2 kHz RF Att 20 dB
 Ref Lvl -13.72 dBm VBW 2 kHz
 35.7 dBm 897.5000000 MHz SWI 5 s Unit dBm

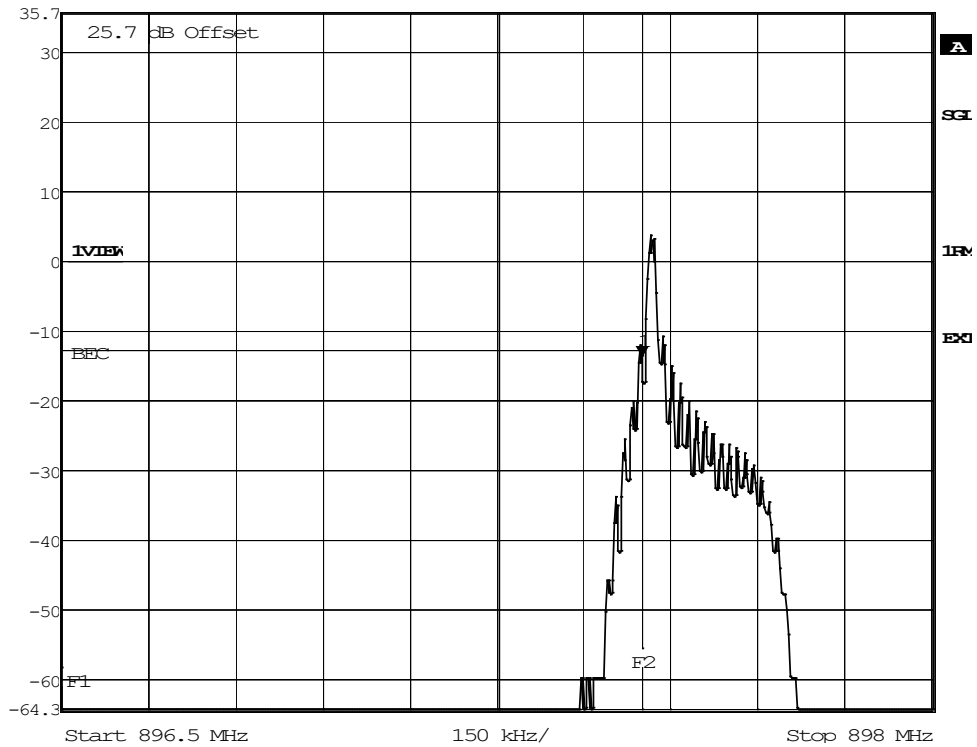

Date: 21.DEC.2020 17:39:45

NB-IoT eFDD 12 QPSK, Channel = high

RS
 Marker 1 [T1] RBW 30 kHz RF Att 20 dB
 Ref Lvl -33.12 dBm VBW 30 kHz
 36 dBm 716.0000000 MHz SWI 5 s Unit dBm

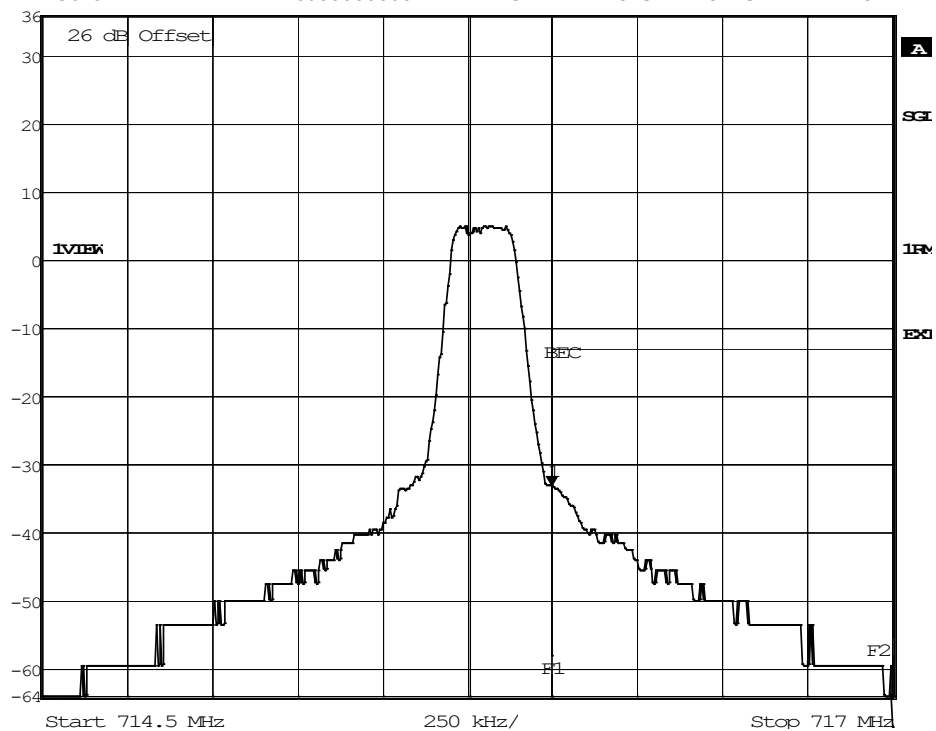

Date: 11.AUG.2020 18:52:58

NB-IoT eFDD 13 QPSK, Channel = low

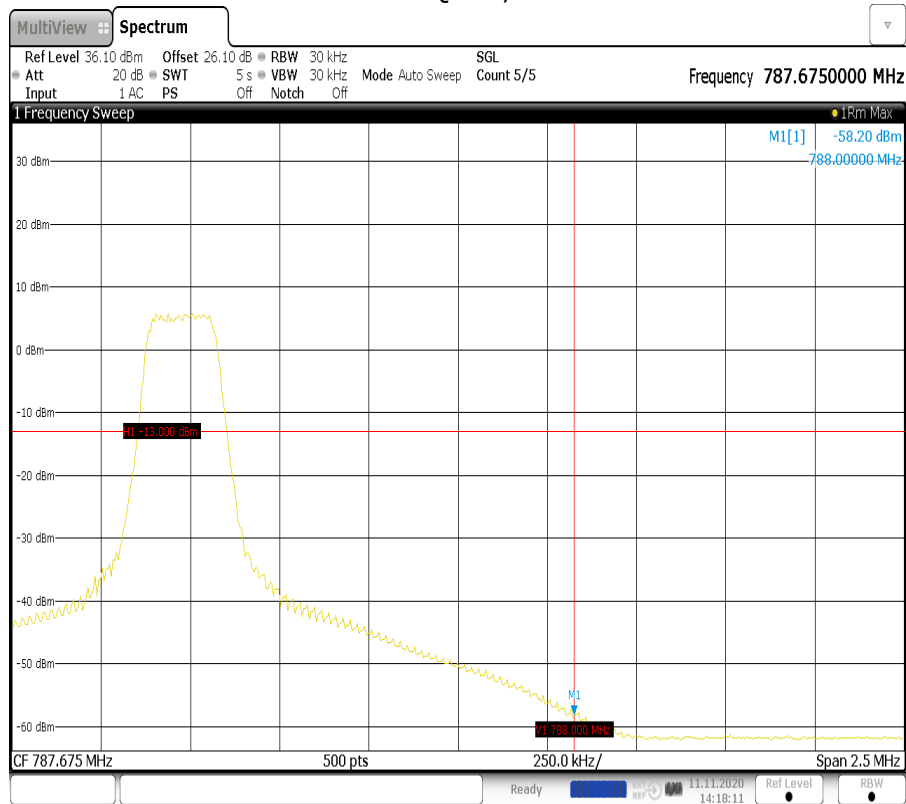

14:18:11 11.11.2020

NB-IoT eFDD 66 QPSK, Channel = low

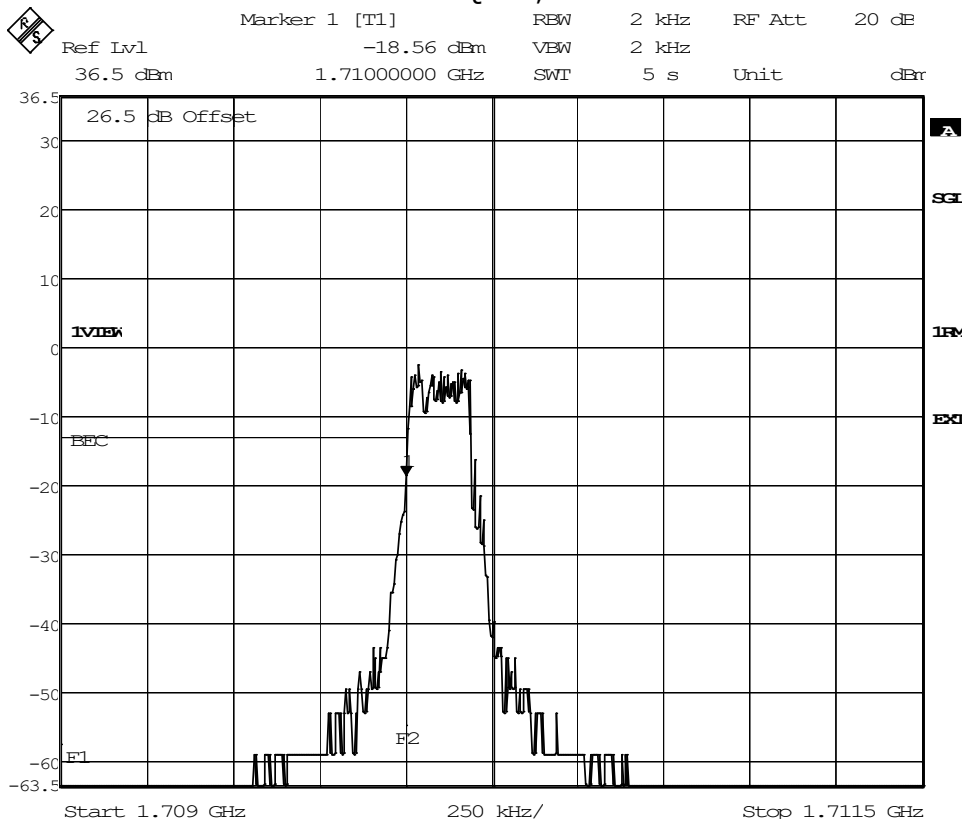

Date: 11.AUG.2020 19:18:13

NB-IoT eFDD 71 QPSK, Channel = low

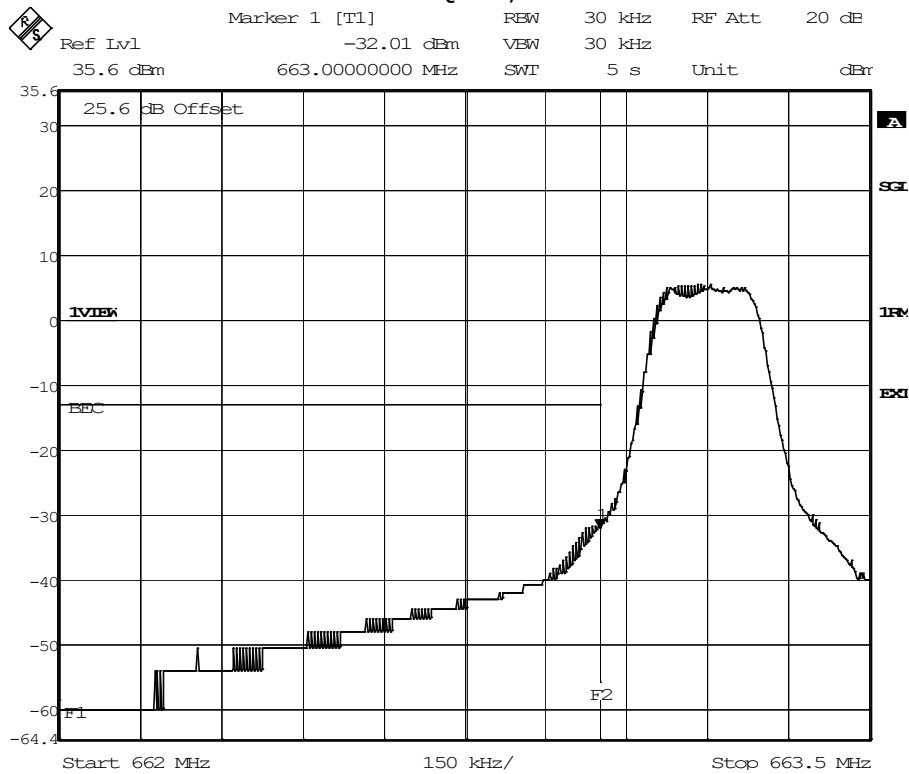

Date: 19.NOV.2020 17:52:29

NB-IoT eFDD 85 QPSK, Channel = low

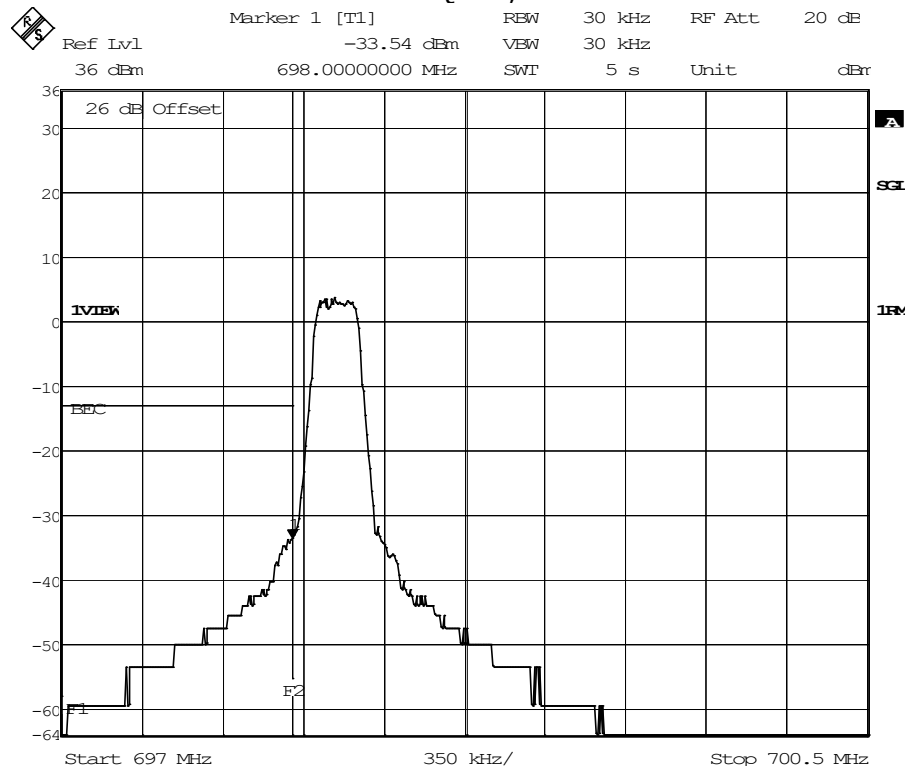

Date: 30.JUN.2020 13:23:41

5.20.5 TEST EQUIPMENT USED

- Radio Lab

5.21 PEAK TO AVERAGE RATIO

Standard **FCC PART 27 Subpart C**

The test was performed according to:
ANSI C63.26: 2015

5.21.1 TEST DESCRIPTION

This test case is intended to demonstrate compliance of the EUT to the peak-to-average limits and requirements of the applicable rule part and ISED RSS-Standard for the operating band of the cellular device.

The EUT was connected to the test setup according to the following diagram:

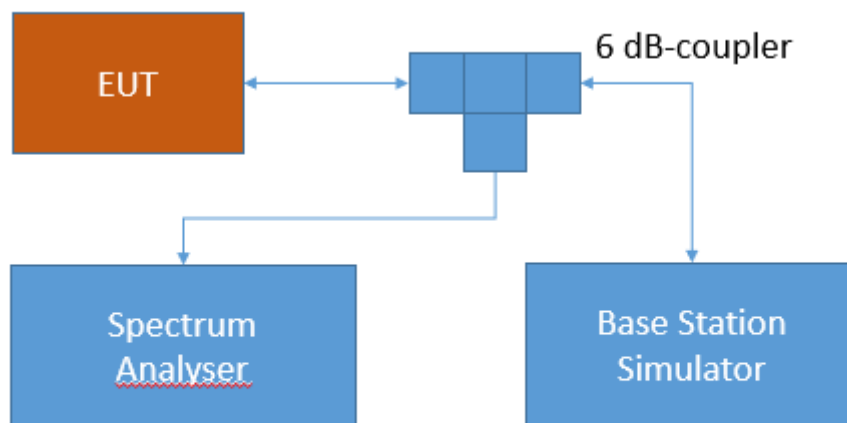

Test Setup FCC Part 22/24/27/90 Cellular;
Peak-average ratio

The attenuation of the measuring and stimulus path are known for each measured frequency and are considered.

The Spectrum Analyser settings can be directly found in the measurement diagrams. The internal CCDF (complementary cumulative distribution function) of the spectrum analyser is used for this measurement

5.21.2 TEST REQUIREMENTS / LIMITS

FCC Part 27; Miscellaneous Wireless Communication Services

Subpart C – Technical standards

§ 27.50 - Power limits and duty cycle

Band 13:

No applicable PAPR limit.

RSS-130; 4.6.1 General

The transmitter output power shall be measured in terms of average power. In addition, the peak-to-average power ratio (PAPR) of the transmitter shall not exceed 13 dB for more than 0.1% of the time and shall use a signal corresponding to the highest PAPR during periods of continuous transmission.

Band 12:

No applicable PAPR limit.

RSS-130; 4.6.1 General

The transmitter output power shall be measured in terms of average power. In addition, the peak-to-average power ratio (PAPR) of the transmitter shall not exceed 13 dB for more than 0.1% of the time and shall use a signal corresponding to the highest PAPR during periods of continuous transmission.

Band 4/10/66:

d) The following power and antenna height requirements apply to stations transmitting in the 1695-1710 MHz, 1710-1755 MHz, 1755-1780 MHz, 1915-1920 MHz, 1995-2000 MHz, 2000-2020 MHz, 2110-2155 MHz, 2155-2180 MHz and 2180-2200 MHz bands:

(5) Equipment employed must be authorized in accordance with the provisions of §24.51. Power measurements for transmissions by stations authorized under this section may be made either in accordance with a Commission-approved average power technique or in compliance with paragraph (d)(6) of this section. In measuring transmissions in this band using an average power technique, the peak-to-average ratio (PAR) of the transmission may not exceed 13 dB.

RSS-139; 6.5 Transmitter Output Power

In addition, the peak to average power ratio (PAPR) of the equipment shall not exceed 13 dB for more than 0.1% of the time, using a signal that corresponds to the highest PAPR during periods of continuous transmission.

Band 17:

No applicable PAPR limit.

RSS-130; 4.6.1 General

The transmitter output power shall be measured in terms of average power. In addition, the peak-to-average power ratio (PAPR) of the transmitter shall not exceed 13 dB for more than

0.1% of the time and shall use a signal corresponding to the highest PAPR during periods of continuous transmission.

Band 7:

No applicable PAPR limit.

RSS-199; 4.4 Transmitter output power and equivalent isotropically power (e.i.r.p.)

In addition, the peak-to-average power ratio (PAPR) of the transmitter shall not exceed 13 dB for more than 0.1% of the time and shall use a signal corresponding to the highest PAPR during periods of continuous transmission.

For equipment with multiple antennas, the transmitter output power and e.i.r.p shall be measured according to ANSI C63.26-2015.

5.21.3 TEST PROTOCOL

Ambient temperature: 20 - 25 °C
Relative humidity: 30 - 40 %

Radio Technology	Channel	Resource Blocks	Bandwidth (MHz)	Peak to Average Ratio	Limit (IC) (dB)
CAT-M1 eFDD 4 QPSK	low	6	1.4	10.32	13
CAT-M1 eFDD 4 QPSK	mid	6	1.4	10.29	13
CAT-M1 eFDD 4 QPSK	high	6	1.4	10.29	13
CAT-M1 eFDD 4 16QAM	low	5	1.4	11.07	13
CAT-M1 eFDD 4 16QAM	mid	5	1.4	11.1	13
CAT-M1 eFDD 4 16QAM	high	5	1.4	11.13	13
CAT-M1 eFDD 8 QPSK	low	6	1.4	10.32	13
CAT-M1 eFDD 8 QPSK	mid	6	1.4	10.99	13
CAT-M1 eFDD 8 QPSK	high	6	1.4	10.23	13
CAT-M1 eFDD 8 16QAM	low	5	1.4	11.1	13
CAT-M1 eFDD 8 16QAM	mid	5	1.4	11.13	13
CAT-M1 eFDD 8 16QAM	high	5	1.4	11.48	13
CAT-M1 eFDD 12 QPSK	low	6	1.4	10.03	13
CAT-M1 eFDD 12 QPSK	mid	6	1.4	10	13
CAT-M1 eFDD 12 QPSK	high	6	1.4	10.03	13
CAT-M1 eFDD 12 16QAM	low	5	1.4	10.84	13
CAT-M1 eFDD 12 16QAM	mid	5	1.4	10.81	13
CAT-M1 eFDD 12 16QAM	high	5	1.4	10.84	13
CAT-M1 eFDD 13 QPSK	low	6	1.4	12.06	13
CAT-M1 eFDD 13 QPSK	mid	6	1.4	12.06	13
CAT-M1 eFDD 13 QPSK	high	6	1.4	12.06	13
CAT-M1 eFDD 13 16QAM	low	5	1.4	12.87	13
CAT-M1 eFDD 13 16QAM	mid	5	1.4	12.87	13
CAT-M1 eFDD 13 16QAM	high	5	1.4	12.87	13
CAT-M1 eFDD 66 QPSK	low	6	1.4	10.35	13
CAT-M1 eFDD 66 QPSK	mid	6	1.4	10.41	13

CAT-M1 eFDD 66 QPSK	high	6	1.4	11.36	13
CAT-M1 eFDD 66 16QAM	low	5	1.4	11.22	13
CAT-M1 eFDD 66 16QAM	mid	5	1.4	11.19	13
CAT-M1 eFDD 66 16QAM	high	5	1.4	11.22	13
NB-IoT eFDD 4 QPSK	low	12	0.2	9.83	13
NB-IoT eFDD 4 QPSK	mid	12	0.2	9.83	13
NB-IoT eFDD 4 QPSK	high	12	0.2	9.8	13
NB-IoT eFDD 4 BPSK	low	1	0.2	3.25	13
NB-IoT eFDD 4 BPSK	mid	1	0.2	3.36	13
NB-IoT eFDD 4 BPSK	high	1	0.2	3.25	13
NB-IoT eFDD 8 QPSK	low	12	0.2	11.65	13
NB-IoT eFDD 8 QPSK	mid	12	0.2	12.38	13
NB-IoT eFDD 8 QPSK	high	12	0.2	11.62	13
NB-IoT eFDD 8 BPSK	low	1	0.2	5.51	13
NB-IoT eFDD 8 BPSK	mid	1	0.2	5.54	13
NB-IoT eFDD 8 BPSK	high	1	0.2	5.83	13
NB-IoT eFDD 12 QPSK	low	12	0.2	10.67	13
NB-IoT eFDD 12 QPSK	mid	12	0.2	10.06	13
NB-IoT eFDD 12 QPSK	high	12	0.2	9.77	13
NB-IoT eFDD 12 BPSK	low	1	0.2	3.1	13
NB-IoT eFDD 12 BPSK	mid	1	0.2	3.1	13
NB-IoT eFDD 12 BPSK	high	1	0.2	3.16	13
NB-IoT eFDD 13 QPSK	low	12	0.2	9.77	13
NB-IoT eFDD 13 QPSK	mid	12	0.2	10.35	13
NB-IoT eFDD 13 QPSK	high	12	0.2	10.81	13
NB-IoT eFDD 13 BPSK	low	1	0.2	3.48	13
NB-IoT eFDD 13 BPSK	mid	1	0.2	3.39	13
NB-IoT eFDD 13 BPSK	high	1	0.2	3.36	13
NB-IoT eFDD 66 QPSK	low	12	0.2	10.78	13
NB-IoT eFDD 66 QPSK	mid	12	0.2	9.94	13
NB-IoT eFDD 66 QPSK	high	12	0.2	10.67	13
NB-IoT eFDD 66 BPSK	low	1	0.2	3.39	13
NB-IoT eFDD 66 BPSK	mid	1	0.2	3.25	13
NB-IoT eFDD 66 BPSK	high	1	0.2	3.3	13
NB-IoT eFDD 71 QPSK	low	12	0.2	12.43	13
NB-IoT eFDD 71 QPSK	mid	12	0.2	12.52	13
NB-IoT eFDD 71 QPSK	high	12	0.2	12.75	13
NB-IoT eFDD 71 BPSK	low	1	0.2	4.96	13
NB-IoT eFDD 71 BPSK	mid	1	0.2	4.99	13
NB-IoT eFDD 71 BPSK	high	1	0.2	5.22	13
NB-IoT eFDD 85 QPSK	low	12	0.2	9.86	13
NB-IoT eFDD 85 QPSK	mid	12	0.2	9.8	13
NB-IoT eFDD 85 QPSK	high	12	0.2	10.93	13
NB-IoT eFDD 85 BPSK	low	1	0.2	3.07	13
NB-IoT eFDD 85 BPSK	mid	1	0.2	3.1	13
NB-IoT eFDD 85 BPSK	high	1	0.2	3.13	13

Remark: Please see next sub-clause for the measurement plot.