

SPOTCHECKS FOR CHILD PRODUCT (S01\_AC01 = SARA-R422)

Radio Technology	Ch	Re-source Blocks / Sub-carrier	Band-width [MHz]	RMS Cond. Power [dBm]	FCC EIRP Limit [W]	IC EIRP Limit [W]	Max. Antenna Gain FCC [dBi]	Max. Antenna Gain IC [dBi]
CAT-M1 eFDD 4 QPSK	mid	1	1.4	22.5	1	1	7.5	7.5
CAT-M1 eFDD 4 QPSK	mid	3	1.4	21.62	1	1	8.38	8.38
CAT-M1 eFDD 4 QPSK	mid	6	1.4	20.66	1	1	9.34	9.34
CAT-M1 eFDD 4 16QAM	mid	1	1.4	21.24	1	1	8.76	8.76
CAT-M1 eFDD 4 16QAM	mid	5	1.4	20.62	1	1	9.38	9.38
CAT-M1 eFDD 13 QPSK	mid	1	5	21.84	1	1	8.16	8.16
CAT-M1 eFDD 13 QPSK	mid	3	5	20.91	1	1	9.09	9.09
CAT-M1 eFDD 13 QPSK	mid	6	5	20.98	1	1	9.02	9.02
CAT-M1 eFDD 13 16QAM	mid	1	5	21.62	1	1	8.38	8.38
CAT-M1 eFDD 13 16QAM	mid	5	5	19.94	1	1	10.06	10.06
NB-IoT eFDD 4 QPSK	mid	1	0.2	23.95	1	1	6.05	6.05
NB-IoT eFDD 4 QPSK	mid	3	0.2	22.31	1	1	7.69	7.69
NB-IoT eFDD 4 QPSK	mid	6	0.2	22.28	1	1	7.72	7.72
NB-IoT eFDD 4 QPSK	mid	12	0.2	22.01	1	1	7.99	7.99
NB-IoT eFDD 4 BPSK	mid	1	0.2	23.71	1	1	6.29	6.29
NB-IoT eFDD 13 QPSK	mid	1	0.2	24.33	1	1	5.67	5.67
NB-IoT eFDD 13 QPSK	mid	3	0.2	22.46	1	1	7.54	7.54
NB-IoT eFDD 13 QPSK	mid	6	0.2	22.62	1	1	7.38	7.38
NB-IoT eFDD 13 QPSK	mid	12	0.2	22.54	1	1	7.46	7.46
NB-IoT eFDD 13 BPSK	mid	1	0.2	24.06	1	1	5.94	5.94

SPOTCHECKS FOR CHILD PRODUCT (S01\_AE01 = SARA-R422S)

Radio Technology	Ch	Re-source Blocks / Sub-carrier	Band-width [MHz]	RMS Cond. Power [dBm]	FCC EIRP Limit [W]	IC EIRP Limit [W]	Max. Antenna Gain FCC [dBi]	Max. Antenna Gain IC [dBi]
CAT-M1 eFDD 4 QPSK	mid	1	1.4	22.31	1	1	7.69	7.69
CAT-M1 eFDD 4 QPSK	mid	3	1.4	21.38	1	1	8.62	8.62
CAT-M1 eFDD 4 QPSK	mid	6	1.4	20.3	1	1	9.7	9.7
CAT-M1 eFDD 4 16QAM	mid	1	1.4	21.1	1	1	8.9	8.9
CAT-M1 eFDD 4 16QAM	mid	5	1.4	20.33	1	1	9.67	9.67
CAT-M1 eFDD 13 QPSK	mid	1	5	22.35	1	1	7.65	7.65
CAT-M1 eFDD 13 QPSK	mid	3	5	21.49	1	1	8.51	8.51
CAT-M1 eFDD 13 QPSK	mid	6	5	21.51	1	1	8.49	8.49
CAT-M1 eFDD 13 16QAM	mid	1	5	22.09	1	1	7.91	7.91
CAT-M1 eFDD 13 16QAM	mid	5	5	20.37	1	1	9.63	9.63
NB-IoT eFDD 4 QPSK	mid	1	0.2	23.85	1	1	6.15	6.15
NB-IoT eFDD 4 QPSK	mid	3	0.2	22.38	1	1	7.62	7.62
NB-IoT eFDD 4 QPSK	mid	6	0.2	22.46	1	1	7.54	7.54
NB-IoT eFDD 4 QPSK	mid	12	0.2	22.2	1	1	7.8	7.8
NB-IoT eFDD 4 BPSK	mid	1	0.2	23.73	1	1	6.27	6.27
NB-IoT eFDD 13 QPSK	mid	1	0.2	24.3	1	1	5.7	5.7
NB-IoT eFDD 13 QPSK	mid	3	0.2	22.56	1	1	7.44	7.44
NB-IoT eFDD 13 QPSK	mid	6	0.2	22.68	1	1	7.32	7.32
NB-IoT eFDD 13 QPSK	mid	12	0.2	22.61	1	1	7.39	7.39
NB-IoT eFDD 13 BPSK	mid	1	0.2	24.16	1	1	5.84	5.84

### 5.15.3 MEASUREMENT PLOT

CAT-M1 eFDD4 QPSK, 1.4 MHz, RB = 1, Channel = low

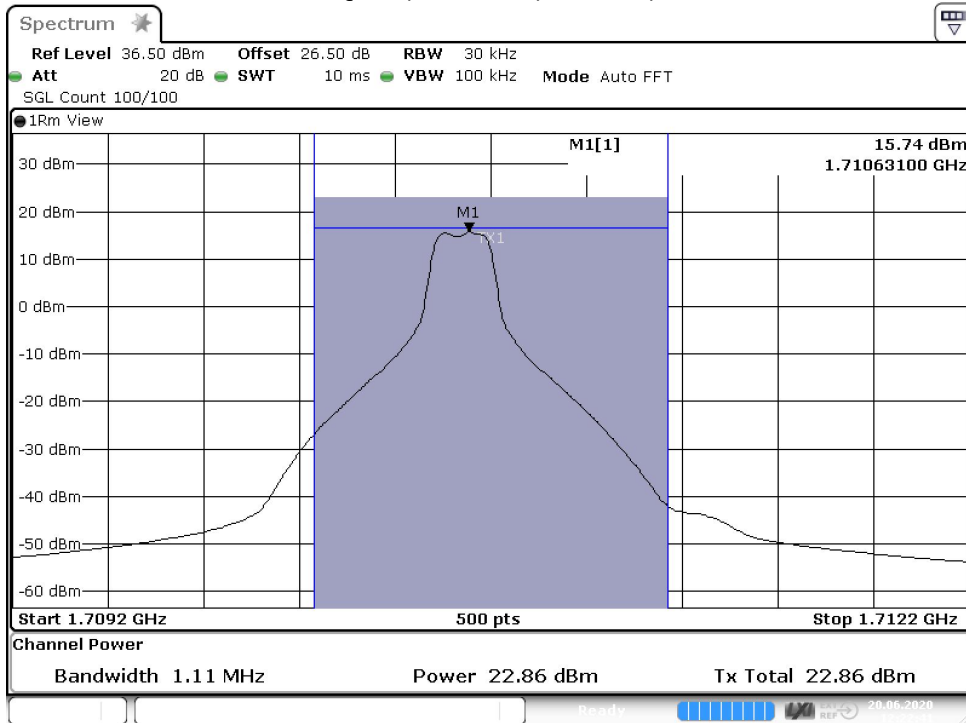

Date: 20.JUN.2020 12:22:41

CAT-M1 eFDD8 QPSK, 3 MHz, RB = 1, Channel = mid

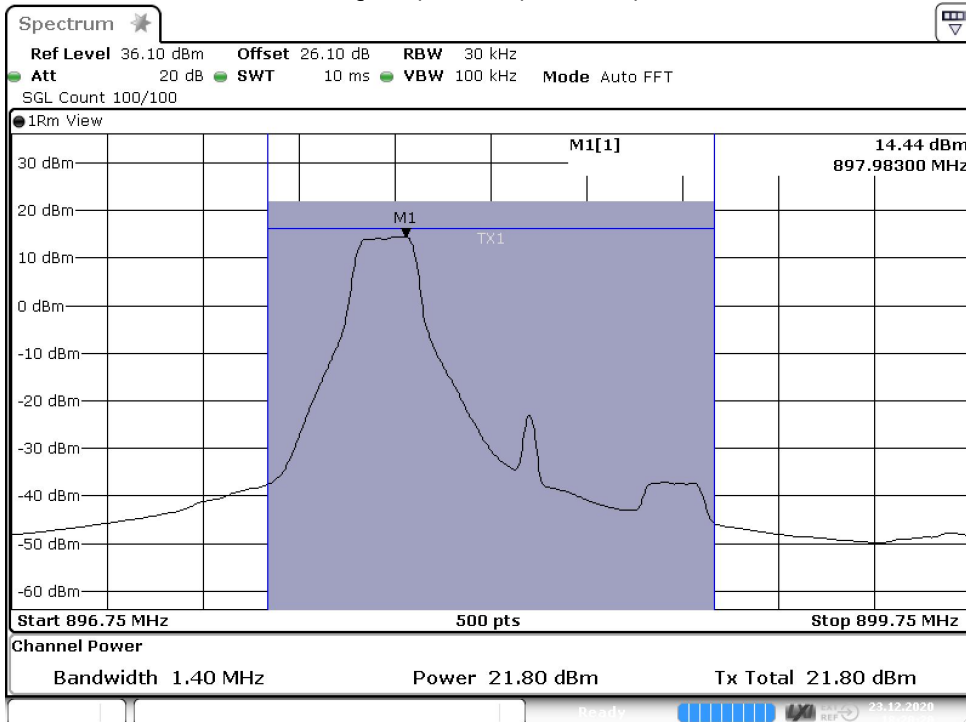

Date: 23.DEC.2020 18:20:20

CAT-M1 eFDD12 16QAM, 5 MHz, RB = 1, Channel = mid

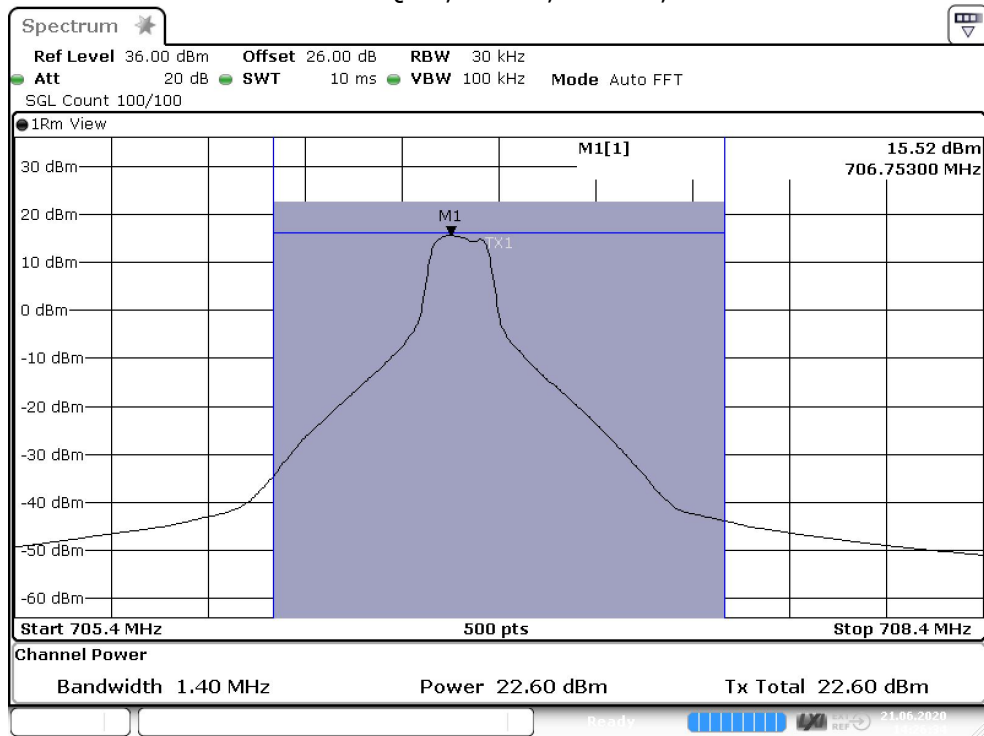

Date: 21. JUN.2020 14:26:34

CAT-M1 eFDD13 16QAM, 5 MHz, RB = 1, Channel = mid

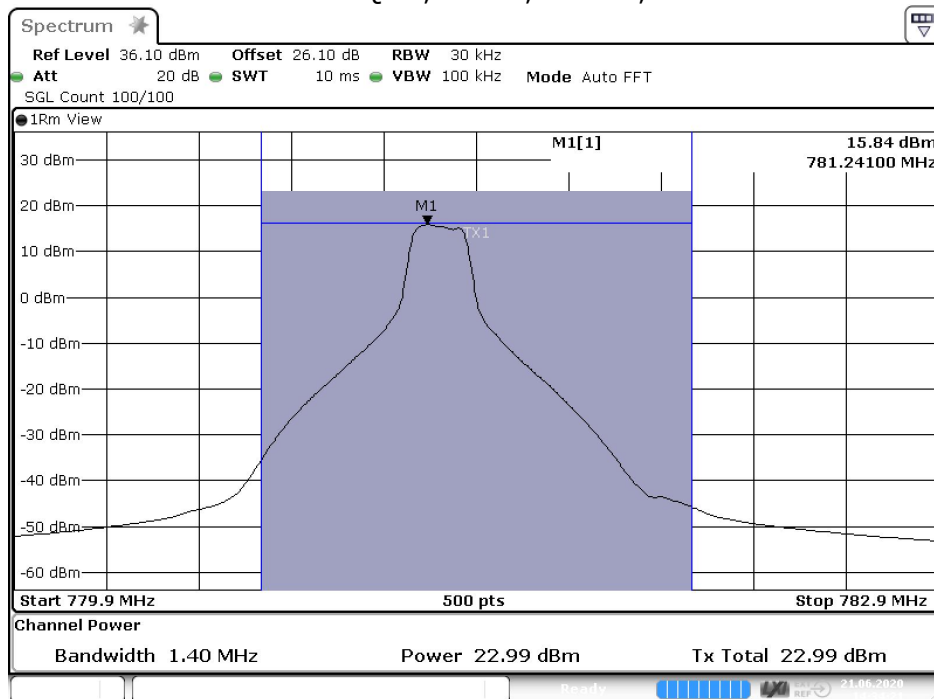

Date: 21. JUN.2020 14:34:21

CAT-M1 eFDD66 QPSK, 10 MHz, RB = 1, Channel = low

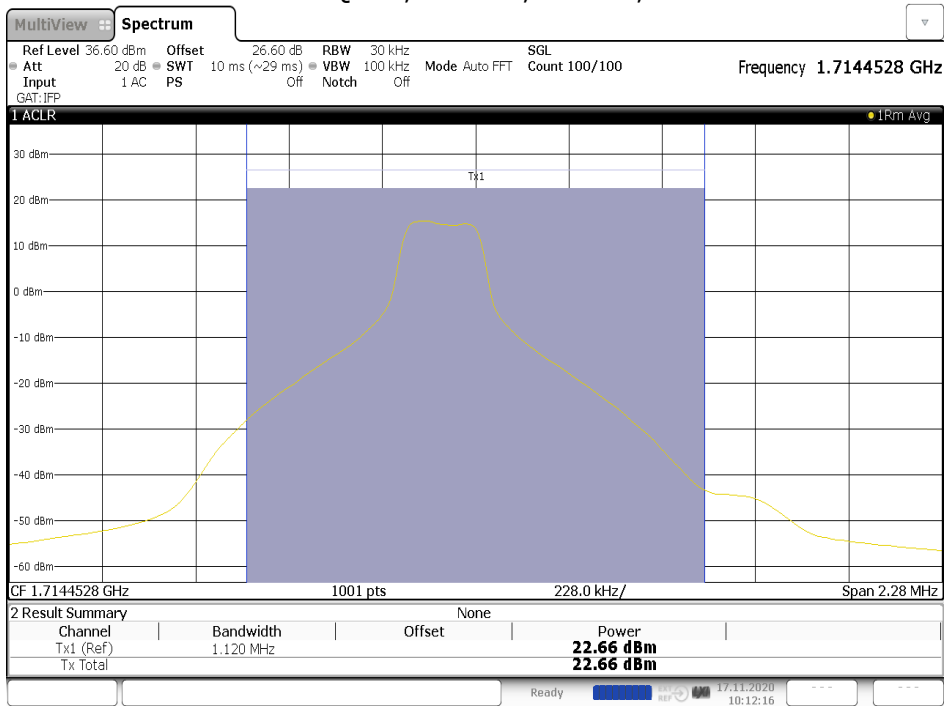

10:12:16 17.11.2020

NB-IoT eFDD4 BPSK, SC = 1, Channel = mid

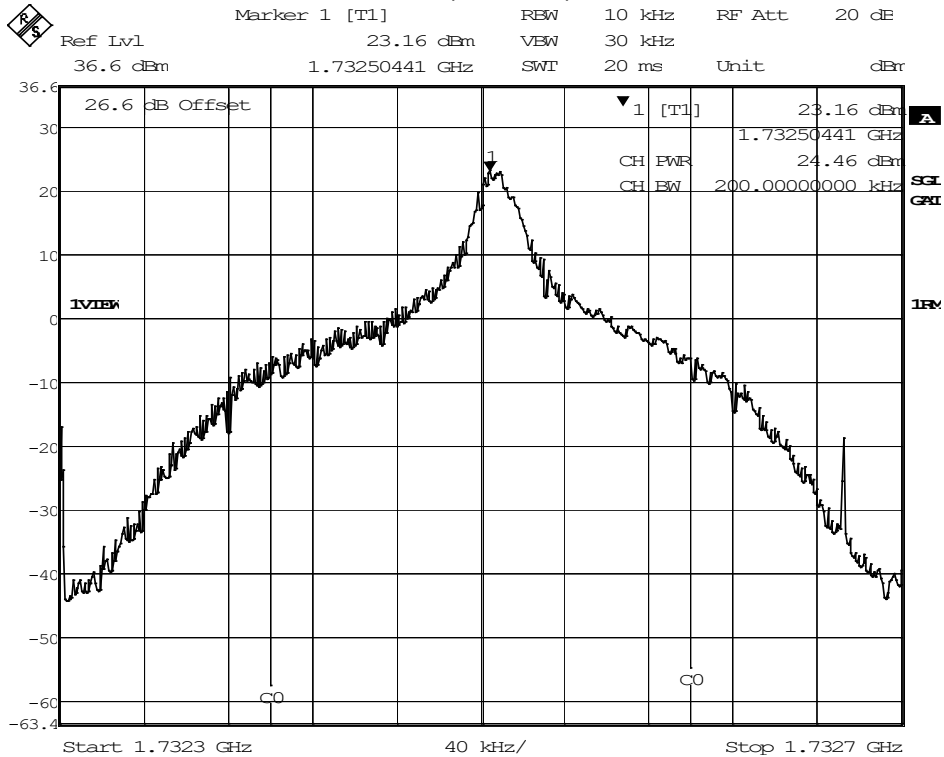

Date: 10.JUL.2020 18:03:43

### NB-IoT eFDD8 QPSK, SC = 6, Channel = low

	Marker 1 [T1]	REW	10 kHz	RF Att	20 dB
	Ref Lvl	16.59 dBm	VEW	30 kHz	
	35.7 dBm	897.58837675 MHz	SWT	20 ms	Unit

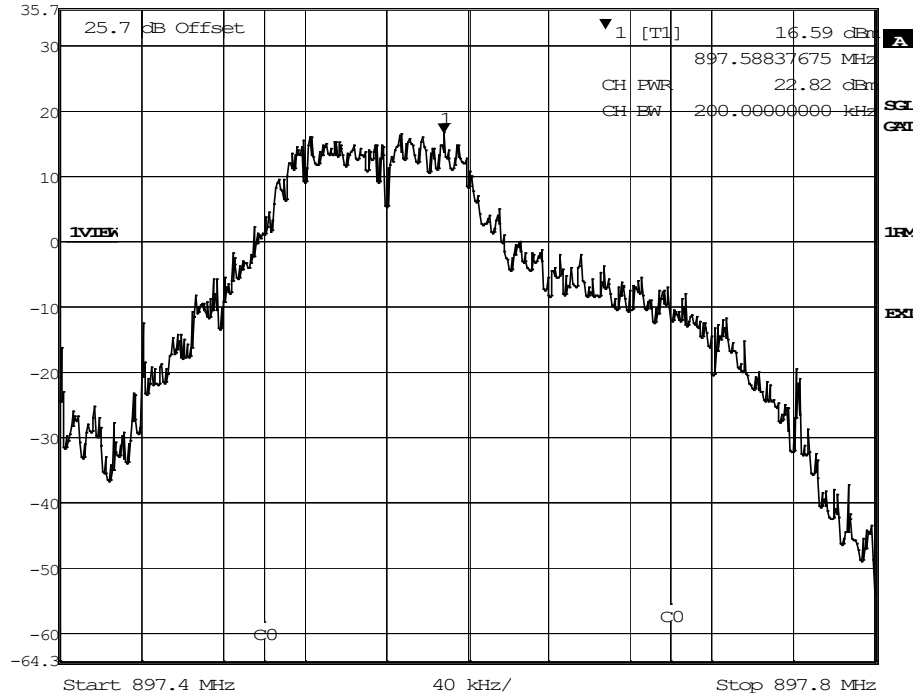

Date: 21.DEC.2020 18:00:48

### NB-IoT eFDD12 QPSK, SC = 1, Channel = low

	Marker 1 [T1]	REW	10 kHz	RF Att	20 dB
	Ref Lvl	25.01 dBm	VEW	30 kHz	
	36 dBm	707.49699399 MHz	SWT	25 ms	Unit

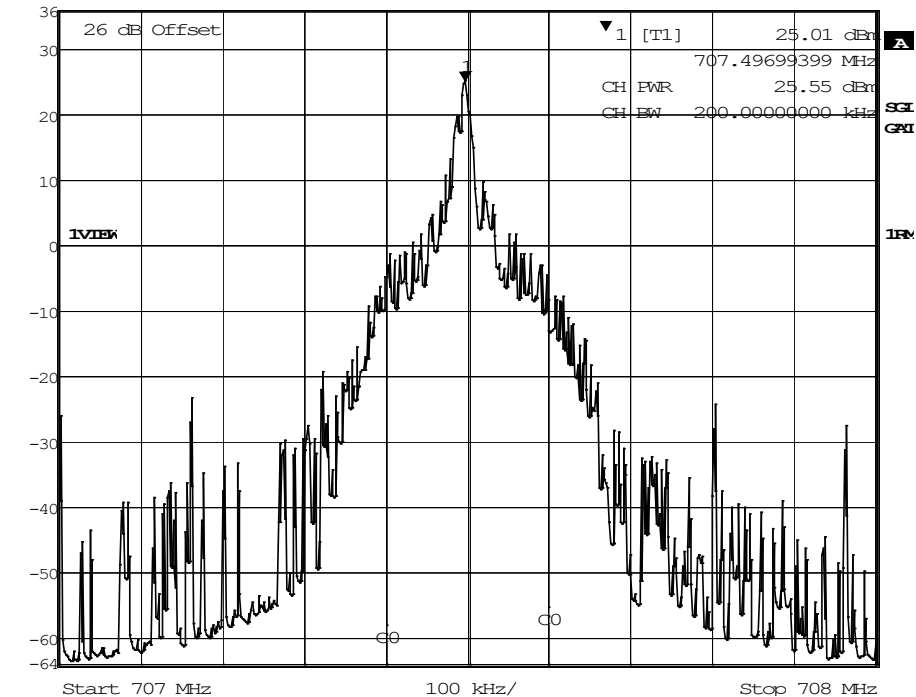

Date: 11.JUL.2020 08:55:49

### NB-IoT eFDD13 QPSK, SC = 1, Channel = high

	Marker 1 [T1]	RBW	10 kHz	RF Att	20 dB
	Ref Lvl	24.45 dBm	VBW	30 kHz	
	36.1 dBm	786.89699399 MHz	SWT	25 ms	Unit dBm

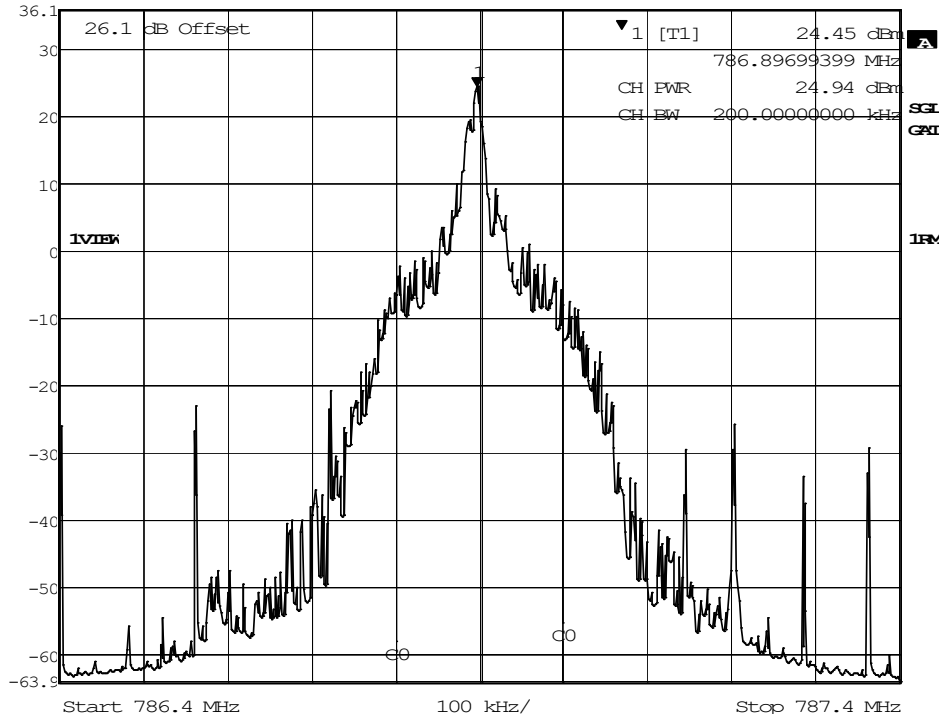

Date: 11.JUL.2020 09:07:43

### NB-IoT eFDD66 QPSK, SC = 3, Channel = low

	Marker 1 [T1]	RBW	10 kHz	RF Att	20 dB
	Ref Lvl	21.68 dBm	VBW	30 kHz	
	36.6 dBm	1.71007645 GHz	SWT	20 ms	Unit dBm

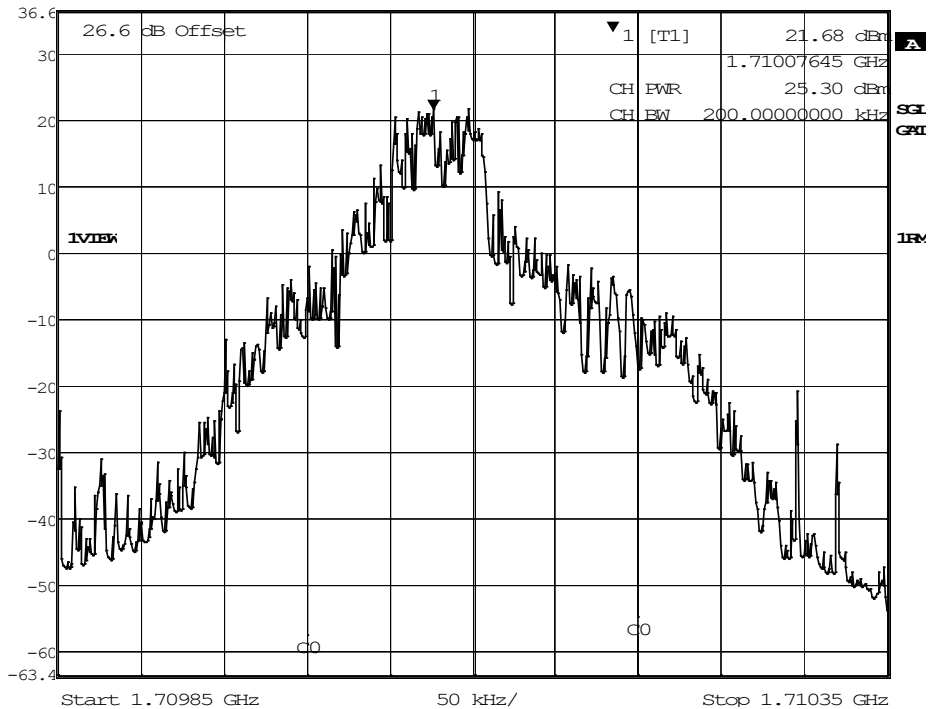

Date: 11.JUL.2020 09:41:51

### NB-IoT eFDD71 QPSK, SC = 1, Channel = low

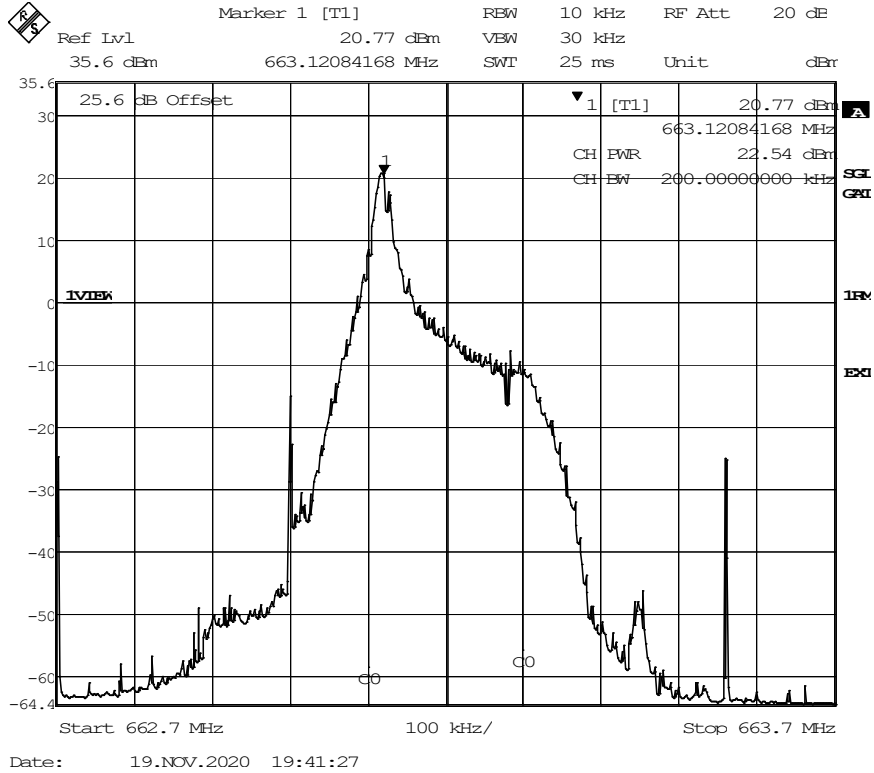

### NB-IoT eFDD85 QPSK, SC = 3, Channel = mid

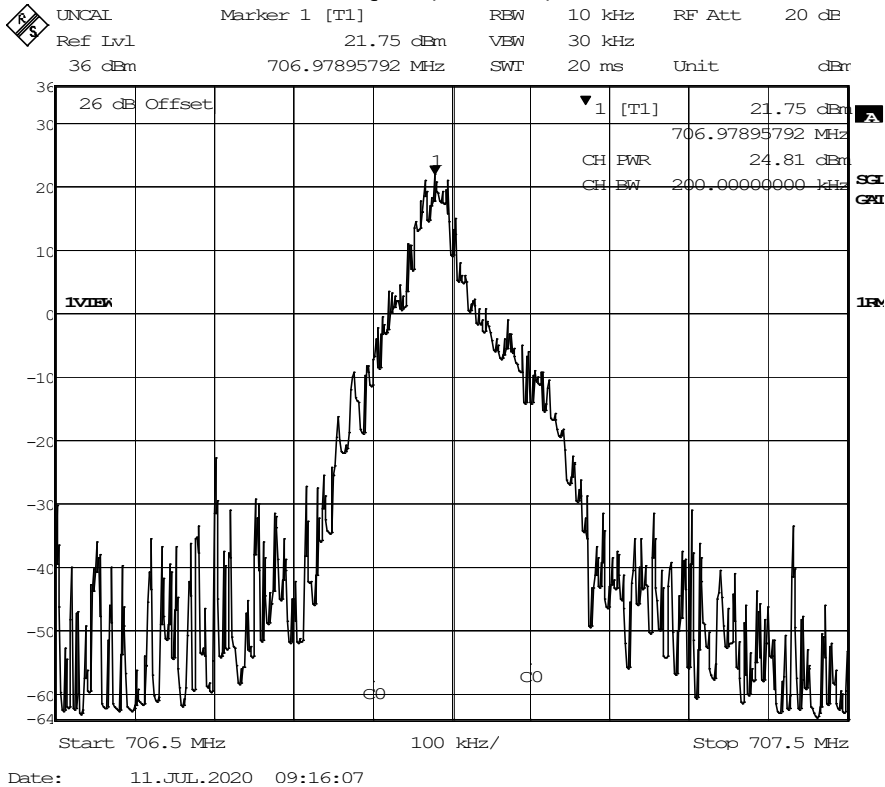

#### 5.15.4 TEST EQUIPMENT USED

- Radio Lab

## 5.16 FREQUENCY STABILITY

Standard **FCC PART 27 Subpart C**

**The test was performed according to:**  
ANSI C63.26: 2015

### 5.16.1 TEST DESCRIPTION

This test case is intended to demonstrate compliance to the applicable frequency stability test case per § 2.1055 and RSS-GEN 6.11. The limit and the requirements come from the applicable rule part and ISED RSS-Standard for the operating band of the cellular device.

The EUT was connected to the test setup according to the following diagram:



Test Setup FCC Part 22/24/27/90 Cellular;  
Frequency stability

The attenuation of the measuring / stimulus path is known for each measured frequency and are considered.

### 5.16.2 TEST REQUIREMENTS / LIMITS

#### **FCC Part 27; Miscellaneous Wireless Communication Services**

#### **Subpart C – Technical standards**

#### **§ 27.54 - Frequency stability**

#### **All Bands**

The frequency stability shall be sufficient to ensure that the fundamental emissions stay within the authorized bands of operation.

#### **Band 12/13/17:**

#### **RSS-130; 4.5 Transmitter frequency stability**

For equipment that is capable of transmitting numerous channels simultaneously for different applications (e.g. LTE and narrowband – Internet of Things (IoT)), the occupied bandwidth shall be the bandwidth representing the sum of the occupied bandwidths of these channels.



The frequency stability shall be sufficient to ensure that the occupied bandwidth remains within each frequency block range when tested at the temperature and supply voltage variations specified in RSS-Gen.

**Band 4/10/66:**

**RSS-139; 6.4 Frequency Stability**

The frequency stability shall be sufficient to ensure that the occupied bandwidth stays within the operating frequency block when tested to the temperature and supply voltage variations specified in RSS-Gen.

**Band 7:**

**RSS-199; 4.3 Transmitter frequency stability**

The transmitter frequency stability limit shall be determined as follows:

- a. the frequency offset shall be measured according to the procedure described in RSS-Gen and recorded.
- b. using a resolution bandwidth equal to that permitted within the 1 MHz band immediately outside the channel edge, as found in section 4.5, reference points will be selected at the unwanted emission limits, which comply with the attenuation specified in section 4.5 for the type of device under test, on the emission mask of the lowest and highest channels. The frequency at these points shall be recorded as fL and fH respectively.

The applicant shall ensure compliance with frequency stability requirements by showing that fL minus the frequency offset and fH plus the frequency offset is within the frequency range in which the equipment is designed to operate.

### 5.16.3 TEST PROTOCOL

#### CAT-M1 eFDD4

Temp. °C	Duration min	Voltage	Limit Hz	Freq. error Average (Hz)	Freq. error Max. (Hz)	Verdict
-30	0	normal	4331.25	0	7	Passed
-30	5			-2	10	Passed
-30	10			1	11	Passed
-20	0	normal	4331.25	2	9	Passed
-20	5			2	4	Passed
-20	10			1	6	Passed
-10	0	normal	4331.25	1	7	Passed
-10	5			3	4	Passed
-10	10			3	5	Passed
0	0	normal	4331.25	1	8	Passed
0	5			1	4	Passed
0	10			1	4	Passed
10	0	normal	4331.25	-2	9	Passed
10	5			-1	7	Passed
10	10			-1	6	Passed
20	0	low	4331.25	-1	4	Passed
20	5			2	8	Passed
20	10			1	4	Passed
20	0	normal	4331.25	3	5	Passed
20	5			4	5	Passed
20	10			1	9	Passed
20	0	high	4331.25	2	6	Passed
20	5			2	9	Passed
20	10			3	4	Passed
30	0	normal	4331.25	1	8	Passed
30	5			-1	5	Passed
30	10			1	4	Passed
40	0	normal	4331.25	2	8	Passed
40	5			1	7	Passed
40	10			-1	8	Passed
50	0	normal	4331.25	-1	6	Passed
50	5			-1	10	Passed
50	10			2	8	Passed

CAT-M1 eFDD8

Temp. °C	Duration min	Voltage	Limit Hz	Freq. error Average (Hz)	Freq. error Max. (Hz)	Verdict
-30	0	normal	2247.5	-19	-34	Passed
-30	5			15	26	Passed
-30	10			-5	-13	Passed
-20	0	normal	2247.5	-5	-11	Passed
-20	5			-7	-17	Passed
-20	10			24	40	Passed
-10	0	normal	2247.5	28	47	Passed
-10	5			-5	-20	Passed
-10	10			-19	-46	Passed
0	0	normal	2247.5	-10	-49	Passed
0	5			-13	-46	Passed
0	10			-12	-27	Passed
10	0	normal	2247.5	33	43	Passed
10	5			34	49	Passed
10	10			25	38	Passed
20	0	low	2247.5	-17	-43	Passed
20	5			-7	-14	Passed
20	10			27	48	Passed
20	0	high	2247.5	32	47	Passed
20	5			12	19	Passed
20	10			12	21	Passed
20	0	high	2247.5	-15	-29	Passed
20	5			18	31	Passed
20	10			-10	-22	Passed
30	0	normal	2247.5	12	22	Passed
30	5			14	23	Passed
30	10			-13	-77	Passed
40	0	normal	2247.5	-22	-82	Passed
40	5			-13	73	Passed
40	10			-16	-79	Passed
50	0	normal	2247.5	-10	-84	Passed
50	5			11	82	Passed
50	10			21	79	Passed

CAT-M1 eFDD12

Temp. °C	Duration min	Voltage	Limit Hz	Freq. error Average (Hz)	Freq. error Max. (Hz)	Verdict
-30	0	normal	1955	2	10	Passed
-30	5			3	12	Passed
-30	10			3	9	Passed
-20	0	normal	1955	3	13	Passed
-20	5			2	11	Passed
-20	10			4	11	Passed
-10	0	normal	1955	3	12	Passed
-10	5			3	13	Passed
-10	10			2	10	Passed
0	0	normal	1955	3	11	Passed
0	5			2	12	Passed
0	10			3	12	Passed
10	0	normal	1955	3	11	Passed
10	5			4	13	Passed
10	10			3	13	Passed
20	0	low	1955	3	12	Passed
20	5			4	11	Passed
20	10			2	14	Passed
20	0	normal	1955	2	13	Passed
20	5			3	12	Passed
20	10			3	12	Passed
20	0	high	1955	3	13	Passed
20	5			2	11	Passed
20	10			3	14	Passed
30	0	normal	1955	2	13	Passed
30	5			2	12	Passed
30	10			4	13	Passed
40	0	normal	1955	3	12	Passed
40	5			3	12	Passed
40	10			2	10	Passed
50	0	normal	1955	3	11	Passed
50	5			2	13	Passed
50	10			2	14	Passed

CAT-M1 eFDD13

Temp. °C	Duration min	Voltage	Limit Hz	Freq. error Average (Hz)	Freq. error Max. (Hz)	Verdict
-30	0	normal	1955	2	-3	Passed
-30	5			1	-4	Passed
-30	10			1	-2	Passed
-20	0	normal	1955	2	-5	Passed
-20	5			0	-6	Passed
-20	10			0	-3	Passed
-10	0	normal	1955	2	-4	Passed
-10	5			1	-3	Passed
-10	10			2	-1	Passed
0	0	normal	1955	2	-4	Passed
0	5			6	-3	Passed
0	10			1	-2	Passed
10	0	normal	1955	2	-5	Passed
10	5			2	-4	Passed
10	10			3	-3	Passed
20	0	low	1955	0	-4	Passed
20	5			0	-6	Passed
20	10			1	-4	Passed
20	0	normal	1955	2	-4	Passed
20	5			1	-5	Passed
20	10			2	-4	Passed
20	0	high	1955	3	-6	Passed
20	5			4	-6	Passed
20	10			1	-3	Passed
30	0	normal	1955	3	-4	Passed
30	5			1	-3	Passed
30	10			2	-5	Passed
40	0	normal	1955	3	-6	Passed
40	5			0	-3	Passed
40	10			2	-2	Passed
50	0	normal	1955	1	-4	Passed
50	5			1	-3	Passed
50	10			2	-6	Passed

CAT-M1 eFDD66

Temp. °C	Duration min	Voltage	Limit Hz	Freq. error Average (Hz)	Freq. error Max. (Hz)	Verdict
-30	0	normal	1768.75	10	21	Passed
-30	5			8	15	Passed
-30	10			13	30	Passed
-20	0	normal	1768.75	14	45	Passed
-20	5			10	24	Passed
-20	10			11	32	Passed
-10	0	normal	1768.75	11	22	Passed
-10	5			11	31	Passed
-10	10			13	33	Passed
0	0	normal	1768.75	11	25	Passed
0	5			19	33	Passed
0	10			7	22	Passed
10	0	normal	1768.75	13	28	Passed
10	5			6	17	Passed
10	10			12	26	Passed
20	0	low	1768.75	-12	-18	Passed
20	5			-16	-23	Passed
20	10			-17	-41	Passed
20	0	Normal	1768.75	11	25	Passed
20	5			13	36	Passed
20	10			13	29	Passed
20	0	High	1768.75	11	22	Passed
20	5			-6	-22	Passed
20	10			-3	-24	Passed
30	0	Normal	1768.75	9	21	Passed
30	5			10	16	Passed
30	10			13	28	Passed
40	0	Normal	1768.75	13	26	Passed
40	5			11	24	Passed
40	10			11	31	Passed
50	0	Normal	1768.75	12	28	Passed
50	5			9	26	Passed
50	10			8	22	Passed

NB-IoT eFDD4

Temp. °C	Duration min	Voltage	Limit Hz	Freq. error Average (Hz)	Freq. error Max. (Hz)	Verdict
-30	0	Normal	4331.25	-4	-11	Passed
-30	5			-2	-11	Passed
-30	10			-2	-14	Passed
-20	0	Normal	4331.25	0	8	Passed
-20	5			-2	-11	Passed
-20	10			-1	-10	Passed
-10	0	Normal	4331.25	1	9	Passed
-10	5			1	-10	Passed
-10	10			-1	-10	Passed
0	0	Normal	4331.25	-2	-9	Passed
0	5			2	9	Passed
0	10			4	12	Passed
10	0	Normal	4331.25	4	16	Passed
10	5			2	11	Passed
10	10			4	11	Passed
20	0	Low	4331.25	5	15	Passed
20	5			3	15	Passed
20	10			5	15	Passed
20	0	Normal	4331.25	5	13	Passed
20	5			4	12	Passed
20	10			6	17	Passed
20	0	High	4331.25	7	18	Passed
20	5			7	18	Passed
20	10			5	15	Passed
30	0	Normal	4331.25	6	15	Passed
30	5			8	17	Passed
30	10			7	16	Passed
40	0	Normal	4331.25	8	15	Passed
40	5			3	14	Passed
40	10			3	16	Passed
50	0	Normal	4331.25	8	16	Passed
50	5			9	17	Passed
50	10			8	14	Passed

NB-IoT eFDD8

Temp. °C	Duration min	Voltage	Limit Hz	Freq. error Average (Hz)	Freq. error Max. (Hz)	Verdict
-30	0	normal	2247.5	-2	-17	Passed
-30	5			-3	-19	Passed
-30	10			-3	-22	Passed
-20	0	normal	2247.5	-2	-18	Passed
-20	5			-2	-18	Passed
-20	10			-1	-17	Passed
-10	0	normal	2247.5	-1	-18	Passed
-10	5			-2	-18	Passed
-10	10			0	-18	Passed
0	0	normal	2247.5	-3	-19	Passed
0	5			-3	-19	Passed
0	10			-3	-17	Passed
10	0	normal	2247.5	-2	-17	Passed
10	5			-3	-20	Passed
10	10			-3	-21	Passed
20	0	low	2247.5	-2	-19	Passed
20	5			-4	-18	Passed
20	10			-3	-19	Passed
20	0	high	2247.5	-3	-20	Passed
20	5			-2	-17	Passed
20	10			-4	-19	Passed
20	0	high	2247.5	-1	-22	Passed
20	5			-3	-17	Passed
20	10			-1	-18	Passed
30	0	normal	2247.5	-4	-20	Passed
30	5			-1	-16	Passed
30	10			-2	-21	Passed
40	0	normal	2247.5	-3	-19	Passed
40	5			-3	-20	Passed
40	10			-2	-17	Passed
50	0	normal	2247.5	-1	-16	Passed
50	5			-2	-19	Passed
50	10			-2	-16	Passed



NB-IoT eFDD12

Temp. °C	Duration min	Voltage	Limit Hz	Freq. error Average (Hz)	Freq. error Max. (Hz)	Verdict
-30	0	Normal	1768.75	0	7	Passed
-30	5			-1	-6	Passed
-30	10			0	7	Passed
-20	0	Normal	1768.75	7	14	Passed
-20	5			8	13	Passed
-20	10			8	14	Passed
-10	0	Normal	1768.75	10	19	Passed
-10	5			9	15	Passed
-10	10			9	14	Passed
0	0	Normal	1768.75	11	18	Passed
0	5			12	19	Passed
0	10			10	17	Passed
10	0	Normal	1768.75	10	16	Passed
10	5			8	15	Passed
10	10			9	15	Passed
20	0	Low	1768.75	5	12	Passed
20	5			5	12	Passed
20	10			5	11	Passed
20	0	Normal	1768.75	6	11	Passed
20	5			7	14	Passed
20	10			6	12	Passed
20	0	High	1768.75	7	13	Passed
20	5			5	11	Passed
20	10			7	12	Passed
30	0	Normal	1768.75	3	10	Passed
30	5			1	9	Passed
30	10			2	9	Passed
40	0	Normal	1768.75	-2	-8	Passed
40	5			-1	-7	Passed
40	10			-1	-6	Passed
50	0	Normal	1768.75	-4	-9	Passed
50	5			-4	-10	Passed
50	10			-4	-10	Passed

NB-IoT eFDD13

Temp. °C	Duration min	Voltage	Limit Hz	Freq. error Average (Hz)	Freq. error Max. (Hz)	Verdict
-30	0	normal	1955	-2	-8	Passed
-30	5			-2	-9	Passed
-30	10			3	8	Passed
-20	0	normal	1955	4	11	Passed
-20	5			4	11	Passed
-20	10			5	12	Passed
-10	0	normal	1955	7	14	Passed
-10	5			7	13	Passed
-10	10			6	13	Passed
0	0	normal	1955	6	12	Passed
0	5			8	15	Passed
0	10			8	15	Passed
10	0	normal	1955	6	11	Passed
10	5			5	10	Passed
10	10			6	10	Passed
20	0	Low	1955	2	10	Passed
20	5			4	11	Passed
20	10			2	8	Passed
20	0	normal	1955	2	9	Passed
20	5			3	8	Passed
20	10			2	7	Passed
20	0	High	1955	2	7	Passed
20	5			4	10	Passed
20	10			2	9	Passed
30	0	normal	1955	-2	-9	Passed
30	5			-1	-10	Passed
30	10			-1	-8	Passed
40	0	normal	1955	-5	-10	Passed
40	5			-5	-10	Passed
40	10			-6	-14	Passed
50	0	normal	1955	-8	-14	Passed
50	5			-8	-14	Passed
50	10			-10	-15	Passed

NB-IoT eFDD66

Temp. °C	Duration min	Voltage	Limit Hz	Freq. error Average (Hz)	Freq. error Max. (Hz)	Verdict
-30	0	Normal	1768.75	1	9	Passed
-30	5			4	7	Passed
-30	10			3	6	Passed
-20	0	Normal	1768.75	6	12	Passed
-20	5			4	11	Passed
-20	10			2	12	Passed
-10	0	Normal	1768.75	5	12	Passed
-10	5			1	8	Passed
-10	10			3	7	Passed
0	0	Normal	1768.75	5	12	Passed
0	5			5	7	Passed
0	10			2	6	Passed
10	0	Normal	1768.75	4	11	Passed
10	5			6	13	Passed
10	10			2	15	Passed
20	0	Low	1768.75	4	10	Passed
20	5			6	12	Passed
20	10			4	10	Passed
20	0	Normal	1768.75	4	9	Passed
20	5			2	8	Passed
20	10			4	10	Passed
20	0	High	1768.75	6	11	Passed
20	5			5	7	Passed
20	10			1	14	Passed
30	0	Normal	1768.75	6	10	Passed
30	5			4	6	Passed
30	10			1	6	Passed
40	0	Normal	1768.75	6	10	Passed
40	5			5	6	Passed
40	10			5	8	Passed
50	0	Normal	1768.75	3	7	Passed
50	5			3	13	Passed
50	10			4	12	Passed

NB-IoT eFDD71

Temp. °C	Duration min	Voltage	Limit Hz	Freq. error Average (Hz)	Freq. error Max. (Hz)	Verdict
-30	0	normal	1995	4	14	Passed
-30	5			6	11	Passed
-30	10			3	10	Passed
-20	0	normal	1995	9	12	Passed
-20	5			4	9	Passed
-20	10			6	13	Passed
-10	0	normal	1995	2	10	Passed
-10	5			7	12	Passed
-10	10			6	14	Passed
0	0	normal	1995	10	19	Passed
0	5			3	11	Passed
0	10			3	13	Passed
10	0	normal	1995	5	16	Passed
10	5			4	14	Passed
10	10			8	11	Passed
20	0	Low	1995	5	15	Passed
20	5			1	9	Passed
20	10			1	8	Passed
20	0	normal	1995	6	13	Passed
20	5			7	10	Passed
20	10			7	11	Passed
20	0	High	1995	6	12	Passed
20	5			4	13	Passed
20	10			6	13	Passed
30	0	normal	1995	5	13	Passed
30	5			6	18	Passed
30	10			8	16	Passed
40	0	normal	1995	3	12	Passed
40	5			7	15	Passed
40	10			5	17	Passed
50	0	normal	1995	4	16	Passed
50	5			8	10	Passed
50	10			7	13	Passed

NB-IoT eFDD85

Temp. °C	Duration min	Voltage	Limit Hz	Freq. error Average (Hz)	Freq. error Max. (Hz)	Verdict
-30	0	normal	1955	4	10	Passed
-30	5			4	11	Passed
-30	10			4	9	Passed
-20	0	normal	1955	4	10	Passed
-20	5			4	10	Passed
-20	10			5	15	Passed
-10	0	normal	1955	5	9	Passed
-10	5			5	9	Passed
-10	10			4	8	Passed
0	0	normal	1955	5	13	Passed
0	5			6	12	Passed
0	10			4	11	Passed
10	0	normal	1955	5	13	Passed
10	5			5	11	Passed
10	10			5	11	Passed
20	0	Low	1955	4	9	Passed
20	5			4	8	Passed
20	10			5	14	Passed
20	0	normal	1955	6	13	Passed
20	5			6	8	Passed
20	10			4	12	Passed
20	0	High	1955	5	13	Passed
20	5			4	11	Passed
20	10			6	8	Passed
30	0	normal	1955	4	14	Passed
30	5			5	11	Passed
30	10			5	8	Passed
40	0	normal	1955	6	9	Passed
40	5			4	11	Passed
40	10			4	12	Passed
50	0	normal	1955	4	8	Passed
50	5			5	7	Passed
50	10			4	7	Passed

5.16.4 TEST EQUIPMENT USED

- Radio Lab

## 5.17 SPURIOUS EMISSIONS AT ANTENNA TERMINALS

Standard **FCC PART 27 Subpart C**

**The test was performed according to:**  
ANSI C63.26: 2015

### 5.17.1 TEST DESCRIPTION

This test case is intended to demonstrate compliance to the applicable conducted spurious emission test case per § 2.1051 and RSS-GEN 6.13. The limit comes from the applicable rule part and ISSED RSS-Standard for the operating band of the cellular device.

The EUT was connected to the test setup according to the following diagram:

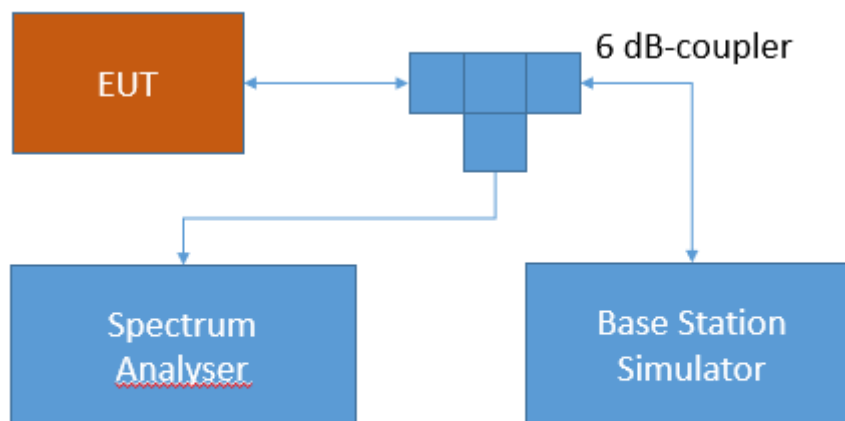

Test Setup FCC Part 22/24/27/90 Cellular;  
Spurious Emissions at antenna terminal

The attenuation of the measuring and stimulus path are known for each measured frequency and are considered.

The Spectrum Analyzer settings can be directly found in the measurement diagrams.

### 5.17.2 TEST REQUIREMENTS / LIMITS

#### **FCC Part 2.1051; Measurement required: Spurious emissions at antenna terminal:**

The radio frequency voltage or powers generated within the equipment and appearing on a spurious frequency shall be checked at the equipment output terminals when properly loaded with a suitable artificial antenna. Curves or equivalent data shall show the magnitude of each harmonic and other spurious emission that can be detected when the equipment is operated under the conditions specified in §2.1049 as appropriate. The magnitude of spurious emissions which are attenuated more than 20 dB below the permissible value need not be specified.

## **FCC Part 27; Miscellaneous Wireless Communication Services**

### **Subpart C – Technical standards**

#### **§27.53 – Emission limits**

##### **Band 13**

(c) For operations in the 746-758 MHz band and the 776-788 MHz band, the power of any emission outside the licensee's frequency band(s) of operation shall be attenuated below the transmitter power (P) within the licensed band(s) of operation, measured in watts, in accordance with the following:

(1) On any frequency outside the 746-758 MHz band, the power of any emission shall be attenuated outside the band below the transmitter power (P) by at least  $43 + 10 \log (P)$  dB;

(2) On any frequency outside the 776-788 MHz band, the power of any emission shall be attenuated outside the band below the transmitter power (P) by at least  $43 + 10 \log (P)$  dB;

(3) On all frequencies between 763-775 MHz and 793-805 MHz, by a factor not less than  $76 + 10 \log (P)$  dB in a 6.25 kHz band segment, for base and fixed stations;

(4) On all frequencies between 763-775 MHz and 793-805 MHz, by a factor not less than  $65 + 10 \log (P)$  dB in a 6.25 kHz band segment, for mobile and portable stations;

(5) Compliance with the provisions of paragraphs (c)(1) and (c)(2) of this section is based on the use of measurement instrumentation employing a resolution bandwidth of 100 kHz or greater. However, in the 100 kHz bands immediately outside and adjacent to the frequency block, a resolution bandwidth of at least 30 kHz may be employed;

(f) For operations in the 746-758 MHz, 775-788 MHz, and 805-806 MHz bands, emissions in the band 1559-1610 MHz shall be limited to  $-70$  dBW/MHz equivalent isotropically radiated power (EIRP) for wideband signals, and  $-80$  dBW EIRP for discrete emissions of less than 700 Hz bandwidth. For the purpose of equipment authorization, a transmitter shall be tested with an antenna that is representative of the type that will be used with the equipment in normal operation.

(6) Compliance with the provisions of paragraphs (c)(3) and (c)(4) of this section is based on the use of measurement instrumentation such that the reading taken with any resolution bandwidth setting should be adjusted to indicate spectral energy in a 6.25 kHz segment.

##### **RSS-130; 4.7.1 General unwanted emissions limits**

The unwanted emissions in any 100 kHz bandwidth on any frequency outside the low frequency edge and the high frequency edge of each frequency block range(s), shall be attenuated below the transmitter power, P (dBW), by at least  $43 + 10 \log_{10} p$  (watts), dB. However, in the 100 kHz band immediately outside of the equipment's frequency block range, a resolution bandwidth of 30 kHz may be employed.

##### **RSS-130; 4.7.2 Additional unwanted emissions limits**

In addition to the limit outlined in section 4.7.1 above, equipment operating in the frequency bands 746-756 MHz and 777-787 MHz shall also comply with the following restrictions:

- a. the power of any unwanted emissions in any 6.25 kHz bandwidth for all frequencies between 763-775 MHz and 793-806 MHz shall be attenuated below the transmitter power, P (dBW), by at least:
  - i.  $76 + 10 \log_{10} p$  (watts), dB, for base and fixed equipment and
  - ii.  $65 + 10 \log_{10} p$  (watts), dB, for mobile and portable equipment
- b. the e.i.r.p. in the band 1559-1610 MHz shall not exceed  $-70$  dBW/MHz for wideband signal and  $-80$  dBW for discrete emission with bandwidth less than 700 Hz.

### **Band 12:**

(g) For operations in the 600 MHz band and the 698-746 MHz band, the power of any emission outside a licensee's frequency band(s) of operation shall be attenuated below the transmitter power (P) within the licensed band(s) of operation, measured in watts, by at least  $43 + 10 \log(P)$  dB. Compliance with this provision is based on the use of measurement instrumentation employing a resolution bandwidth of 100 kilohertz or greater. However, in the 100 kilohertz bands immediately outside and adjacent to a licensee's frequency block, a resolution bandwidth of at least 30 kHz may be employed.

### **RSS-130; 4.7.1 General unwanted emissions limits**

The unwanted emissions in any 100 kHz bandwidth on any frequency outside the low frequency edge and the high frequency edge of each frequency block range(s), shall be attenuated below the transmitter power, P (dBW), by at least  $43 + 10 \log_{10} p$  (watts), dB. However, in the 100 kHz band immediately outside of the equipment's frequency block range, a resolution bandwidth of 30 kHz may be employed.

### **RSS-130; 4.7.2 Additional unwanted emissions limits**

In addition to the limit outlined in section 4.7.1 above, equipment operating in the frequency bands 746-756 MHz and 777-787 MHz shall also comply with the following restrictions:

- a. the power of any unwanted emissions in any 6.25 kHz bandwidth for all frequencies between 763-775 MHz and 793-806 MHz shall be attenuated below the transmitter power, P (dBW), by at least:
  - i.  $76 + 10 \log_{10} p$  (watts), dB, for base and fixed equipment and
  - ii.  $65 + 10 \log_{10} p$  (watts), dB, for mobile and portable equipment
- b. the e.i.r.p. in the band 1559-1610 MHz shall not exceed  $-70$  dBW/MHz for wideband signal and  $-80$  dBW for discrete emission with bandwidth less than 700 Hz.

### **Band 4/10/66:**

(h) *AWS emission limits— (1) General protection levels.* Except as otherwise specified below, for operations in the 1695-1710 MHz, 1710-1755 MHz, 1755-1780 MHz, 1915-1920 MHz, 1995-2000 MHz, 2000-2020 MHz, 2110-2155 MHz, 2155-2180 MHz, and 2180-2200 bands, the power of any emission outside a licensee's frequency block shall be attenuated below the transmitter power (P) in watts by at least  $43 + 10 \log_{10}(P)$  dB.

### **RSS-139; 6.6 Transmitter Unwanted Emissions**

Equipment shall comply with the limits in (i) and (ii) below.

- i. In the first 1.0 MHz bands immediately outside and adjacent to the equipment's smallest operating frequency block, which can contain the equipment's occupied bandwidth, the emission power per any 1% of the emission bandwidth shall be attenuated below the transmitter output power P (in dBW) by at least  $43 + 10 \log_{10} p$  (watts) dB.
- ii. After the first 1.0 MHz outside the equipment's smallest operating frequency block, which can contain the equipment's occupied bandwidth, the emission power in any 1 MHz bandwidth shall be attenuated below the transmitter output power P (in dBW) by at least  $43 + 10 \log_{10} p$  (watts) dB.



### **Band 7:**

(m) For BRS and EBS stations, the power of any emissions outside the licensee's frequency bands of operation shall be attenuated below the transmitter power (P) measured in watts in accordance with the standards below. If a licensee has multiple contiguous channels, out-of-band emissions shall be measured from the upper and lower edges of the contiguous channels.

(4) For mobile digital stations, the attenuation factor shall be not less than  $40 + 10 \log (P)$  dB on all frequencies between the channel edge and 5 megahertz from the channel edge,  $43 + 10 \log (P)$  dB on all frequencies between 5 megahertz and X megahertz from the channel edge, and  $55 + 10 \log (P)$  dB on all frequencies more than X megahertz from the channel edge, where X is the greater of 6 megahertz or the actual emission bandwidth as defined in paragraph (m)(6) of this section. In addition, the attenuation factor shall not be less than  $43 + 10 \log (P)$  dB on all frequencies between 2490.5 MHz and 2496 MHz and  $55 + 10 \log (P)$  dB at or below 2490.5 MHz. Mobile Satellite Service licensees operating on frequencies below 2495 MHz may also submit a documented interference complaint against BRS licensees operating on channel BRS Channel 1 on the same terms and conditions as adjacent channel BRS or EBS licensees.

### **RSS-199; 4.5 Transmitter unwanted emissions**

In the 1 MHz band immediately outside and adjacent to the channel edge, the unwanted emission power shall be measured with a resolution bandwidth of at least 1% of the occupied bandwidth for base station and fixed subscriber equipment, and 2% for mobile subscriber equipment. Beyond the 1 MHz band, a resolution bandwidth of 1 MHz shall be used. A narrower resolution bandwidth can be used, provided that the measured power is integrated over the full required measurement bandwidth of 1 MHz, or 1% or 2% of the occupied bandwidth, as applicable.

Equipment shall comply with the following unwanted emission limits:

b. for mobile subscriber equipment, the power of any unwanted emissions measured as above shall be attenuated (in dB) below the transmitter power, P (dBW), by at least:

$40 + 10 \log_{10} p$  from the channel edges to 5 MHz away

$43 + 10 \log_{10} p$  between 5 MHz and X MHz from the channel edges, and

$55 + 10 \log_{10} p$  at X MHz and beyond from the channel edges

In addition, the attenuation shall not be less than  $43 + 10 \log_{10} p$  on all frequencies between 2490.5 MHz and 2496 MHz, and  $55 + 10 \log_{10} p$  at or below 2490.5 MHz.

In (b), p is the transmitter power measured in watts and X is 6 MHz or the equipment occupied bandwidth, whichever is greater.

### **Band 17:**

(g) For operations in the 600 MHz band and the 698-746 MHz band, the power of any emission outside a licensee's frequency band(s) of operation shall be attenuated below the transmitter power (P) within the licensed band(s) of operation, measured in watts, by at least  $43 + 10 \log(P)$  dB. Compliance with this provision is based on the use of measurement instrumentation employing a resolution bandwidth of 100 kilohertz or greater. However, in the 100 kilohertz bands immediately outside and adjacent to a licensee's frequency block, a resolution bandwidth of at least 30 kHz may be employed.

### **RSS-130; 4.7.1 General unwanted emissions limits**

The unwanted emissions in any 100 kHz bandwidth on any frequency outside the low frequency edge and the high frequency edge of each frequency block range(s), shall be attenuated below the transmitter power, P (dBW), by at least  $43 + 10 \log_{10} p$  (watts), dB. However, in the 100 kHz band immediately outside of the equipment's frequency block range, a resolution bandwidth of 30 kHz may be employed.

### **RSS-130; 4.7.2 Additional unwanted emissions limits**

In addition to the limit outlined in section 4.7.1 above, equipment operating in the frequency bands 746-756 MHz and 777-787 MHz shall also comply with the following restrictions:

- a. the power of any unwanted emissions in any 6.25 kHz bandwidth for all frequencies between 763-775 MHz and 793-806 MHz shall be attenuated below the transmitter power, P (dBW), by at least:
  - i.  $76 + 10 \log_{10} p$  (watts), dB, for base and fixed equipment and
  - ii.  $65 + 10 \log_{10} p$  (watts), dB, for mobile and portable equipment
- b. the e.i.r.p. in the band 1559-1610 MHz shall not exceed  $-70$  dBW/MHz for wideband signal and  $-80$  dBW for discrete emission with bandwidth less than 700 Hz.

## **Subpart P – Regulations Governing Licensing and Use of 900 MHz Broadband Service in the 897.5 – 900.5 MHz and 936.5 - 939.5 MHz Bands**

### **§27.1509 Emission limits**

The power of any emission outside a licensee's frequency band(s) of operation shall be attenuated below the transmitter power (P) in watts by at least the following amounts:

- (a) For 900 MHz broadband operations in 897.5-900.5 MHz band by at least  $43 + 10 \log(P)$  dB.
- (b) For 900 MHz broadband operations in the 936.5-939.5 MHz band, by at least  $50 + 10 \log(P)$  dB.
- (c) Compliance with the provisions of paragraphs (a) and (b) of this section is based on the use of measurement instrumentation employing a resolution bandwidth of 100 kHz or greater. However, in the 100 kHz bands immediately outside and adjacent to the licensee's band, a resolution bandwidth of at least 1 percent of the emission bandwidth of the fundamental emission of the transmitter may be employed. The emission bandwidth is defined as the width of the signal between two points, one below the carrier center frequency and one above the carrier center frequency, outside of which all emissions are attenuated at least 26 dB below the transmitter power.
- (d) The measurements of emission power can be expressed in peak or average values, provided they are expressed in the same parameters as the transmitter power.
- (e) When an emission outside of the authorized bandwidth causes harmful interference, the Commission may, at its discretion, require greater attenuation than specified in this section.

### 5.17.3 TEST PROTOCOL

Ambient temperature: 20 - 25 °C  
 Relative humidity: 30 - 40 %

Radio Technology	Channel	Detector	Trace	Resolution Bandwidth /kHz	Frequency /MHz	Peak Value /dBm	Limit /dBm	Margin to Limit /dB
CAT-M1 eFDD4	low	rms	maxhold	100	1708.9	-37.88	-23	14.88
CAT-M1 eFDD4	low	rms	maxhold	20	1710	-29.36	-13	16.36
CAT-M1 eFDD4	mid	rms	maxhold	-	-	-	-13	>20
CAT-M1 eFDD4	high	rms	maxhold	20	1755	-32.27	-13	19.27
CAT-M1 eFDD4	high	rms	maxhold	100	1756.06	-35.48	-23	12.48

Radio Technology	Channel	Detector	Trace	Resolution Bandwidth /kHz	Frequency /MHz	Peak Value /dBm	Limit /dBm	Margin to Limit /dB
CAT-M1 eFDD8	low	rms	maxhold	20	897.5	-25.06	-13	12.06
CAT-M1 eFDD8	mid	rms	maxhold	-	-	-	-13	>20
CAT-M1 eFDD8	high	rms	maxhold	20	900.5	-28.98	-13	15.98

Radio Technology	Channel	Detector	Trace	Resolution Bandwidth /kHz	Frequency /MHz	Peak Value /dBm	Limit /dBm	Margin to Limit /dB
CAT-M1 eFDD12	low	rms	maxhold	-	-	-	-13	>20
CAT-M1 eFDD12	mid	rms	maxhold	-	-	-	-13	>20
CAT-M1 eFDD12	high	rms	maxhold	30	716	-23.44	-13	10.44

Radio Technology	Channel	Detector	Trace	Resolution Bandwidth /kHz	Frequency /MHz	Peak Value /dBm	Limit /dBm	Margin to Limit /dB
CAT-M1 eFDD13	low	rms	maxhold	-	-	-	-13	>20
CAT-M1 eFDD13	mid	rms	maxhold	-	-	-	-13	>20
CAT-M1 eFDD13	high	rms	maxhold	-	-	-	-13	>20

Radio Technology	Channel	Detector	Trace	Resolution Bandwidth /kHz	Frequency /MHz	Peak Value /dBm	Limit /dBm	Margin to Limit /dB
CAT-M1 eFDD66	low	peak	maxhold	1000	1698.8	-21.3	-13	8.3
CAT-M1 eFDD66	mid	rms	maxhold	-	-	-	-13	>20
CAT-M1 eFDD66	high	peak	maxhold	1000	1790.8	-22.49	-13	9.49

Radio Technology	Channel	Detector	Trace	Resolution Bandwidth /kHz	Frequency /MHz	Peak Value /dBm	Limit /dBm	Margin to Limit /dB
NB-IoT eFDD4	low	rms	maxhold	2	1710	-23.9	-13	10.9
NB-IoT eFDD4	mid	rms	maxhold	-	-	-	-13	>20
NB-IoT eFDD4	high	rms	maxhold	2	1755	-17.09	-13	4.09

Radio Technology	Channel	Detector	Trace	Resolution Bandwidth /kHz	Frequency /MHz	Peak Value /dBm	Limit /dBm	Margin to Limit /dB
NB-IoT eFDD8	low	rms	maxhold	2	897.5	-15.36	-13	2.36
NB-IoT eFDD8	mid	rms	maxhold	-	-	-	-13	>20
NB-IoT eFDD8	high	rms	maxhold	2	900.5	-22.96	-13	9.96

Radio Technology	Channel	Detector	Trace	Resolution Bandwidth /kHz	Frequency /MHz	Peak Value /dBm	Limit /dBm	Margin to Limit /dB
NB-IoT eFDD12	low	rms	maxhold	-	-	-	-13	>20
NB-IoT eFDD12	mid	rms	maxhold	-	-	-	-13	>20
NB-IoT eFDD12	high	rms	maxhold	30	716	-28.14	-13	15.14

Radio Technology	Channel	Detector	Trace	Resolution Bandwidth /kHz	Frequency /MHz	Peak Value /dBm	Limit /dBm	Margin to Limit /dB
NB-IoT eFDD13	low	rms	maxhold	-	-	-	-13	>20
NB-IoT eFDD13	mid	rms	maxhold	-	-	-	-13	>20
NB-IoT eFDD13	high	rms	maxhold	-	-	-	-13	>20

Radio Technology	Channel	Detector	Trace	Resolution Bandwidth /kHz	Frequency /MHz	Peak Value /dBm	Limit /dBm	Margin to Limit /dB
NB-IoT eFDD66	low	rms	maxhold	2	1710	-19.47	-13	6.47
NB-IoT eFDD66	mid	rms	maxhold	-	-	-	-13	>20
NB-IoT eFDD66	high	rms	maxhold	2	1780	-16.36	-13	3.36

Radio Technology	Channel	Detector	Trace	Resolution Bandwidth /kHz	Frequency /MHz	Peak Value /dBm	Limit /dBm	Margin to Limit /dB
NB-IoT eFDD71	low	rms	maxhold	30	662.99	-23.61	-13	10.61
NB-IoT eFDD71	low	peak	maxhold	100	1326.65	-30.3	-13	17.3
NB-IoT eFDD71	mid	rms	maxhold	-	-	-	-13	>20
NB-IoT eFDD71	high	rms	maxhold	30	698	-27.3	-13	14.3

Radio Technology	Channel	Detector	Trace	Resolution Bandwidth /kHz	Frequency /MHz	Peak Value /dBm	Limit /dBm	Margin to Limit /dB
NB-IoT eFDD85	low	rms	maxhold	100	697.86	-22.58	-13	9.58
NB-IoT eFDD85	low	rms	maxhold	30	698	-25.99	-13	12.99
NB-IoT eFDD85	mid	rms	maxhold	-	-	-	-13	>20
NB-IoT eFDD85	mid	rms	maxhold	30	716	-26.9	-13	13.9
NB-IoT eFDD85	high	rms	maxhold	100	716.1	-17.62	-13	4.62

Remark: Please see next sub-clause for the measurement plot.

### 5.17.4 MEASUREMENT PLOT

CAT-M1 eFDD4, Channel = low

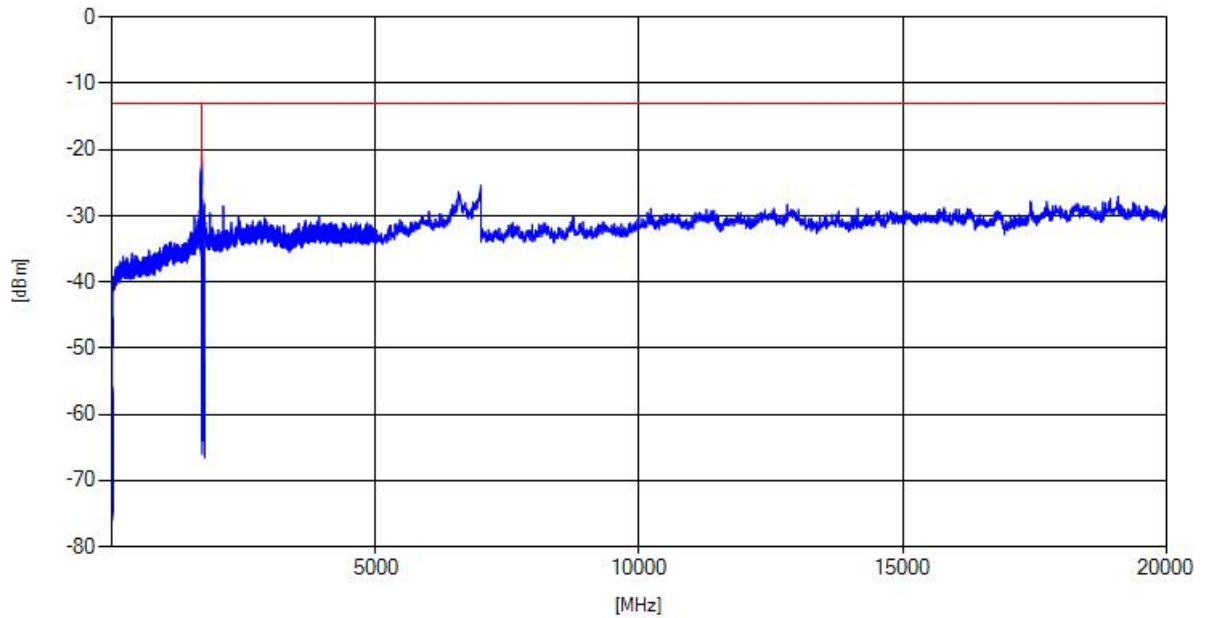

CAT-M1 eFDD8, Channel = low

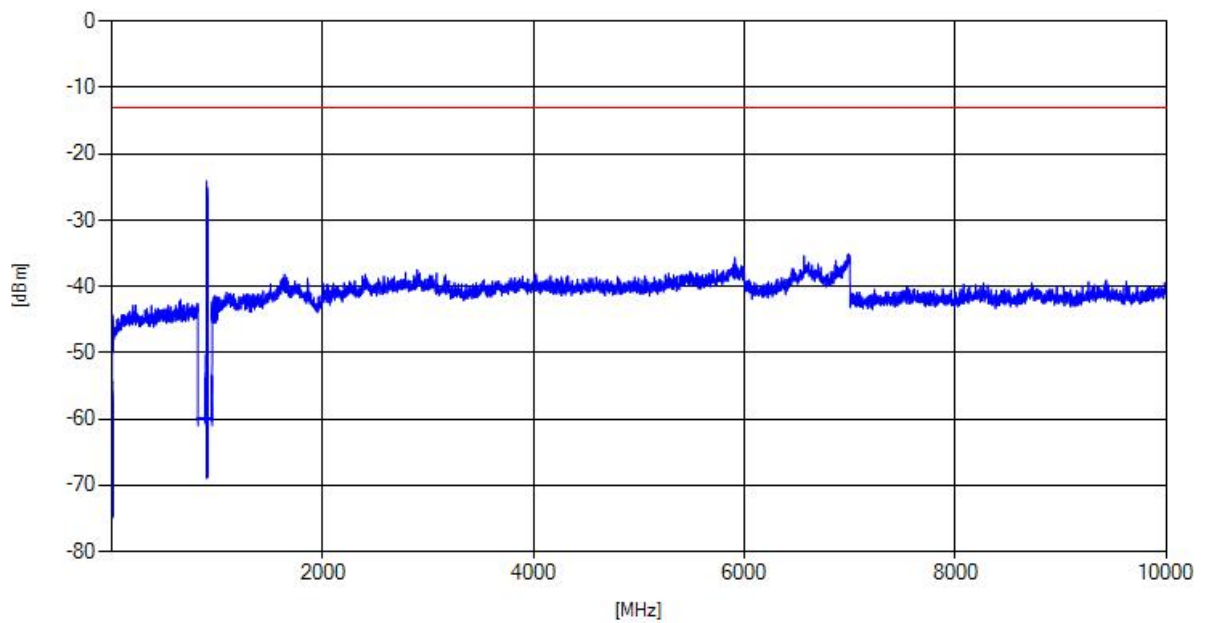

CAT-M1 eFDD12, Channel = high

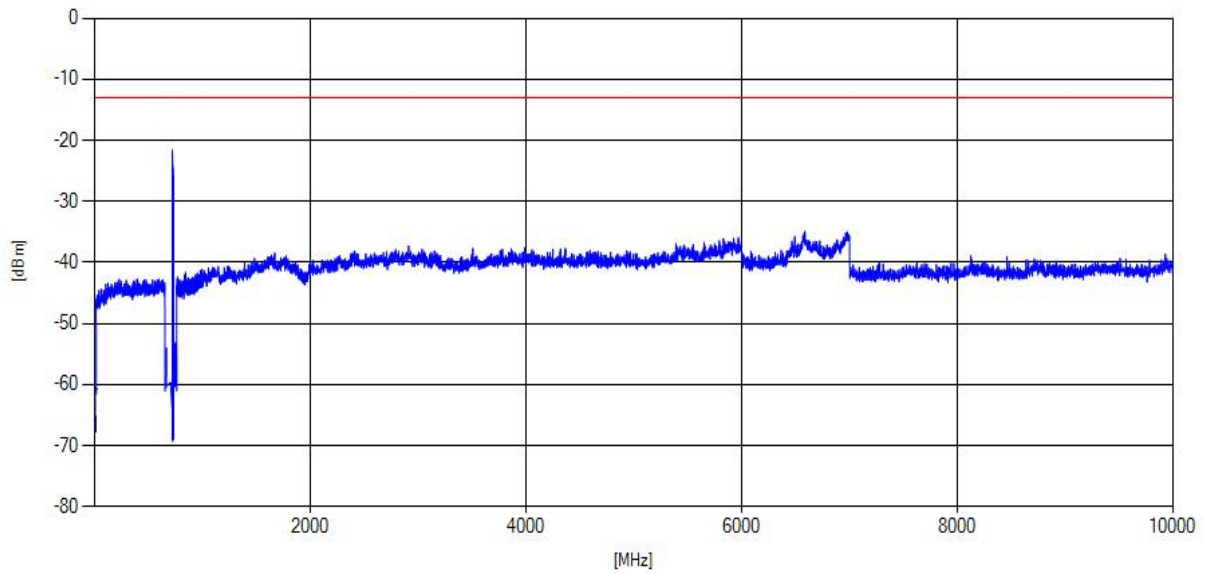

CAT-M1 eFDD13, Channel = mid

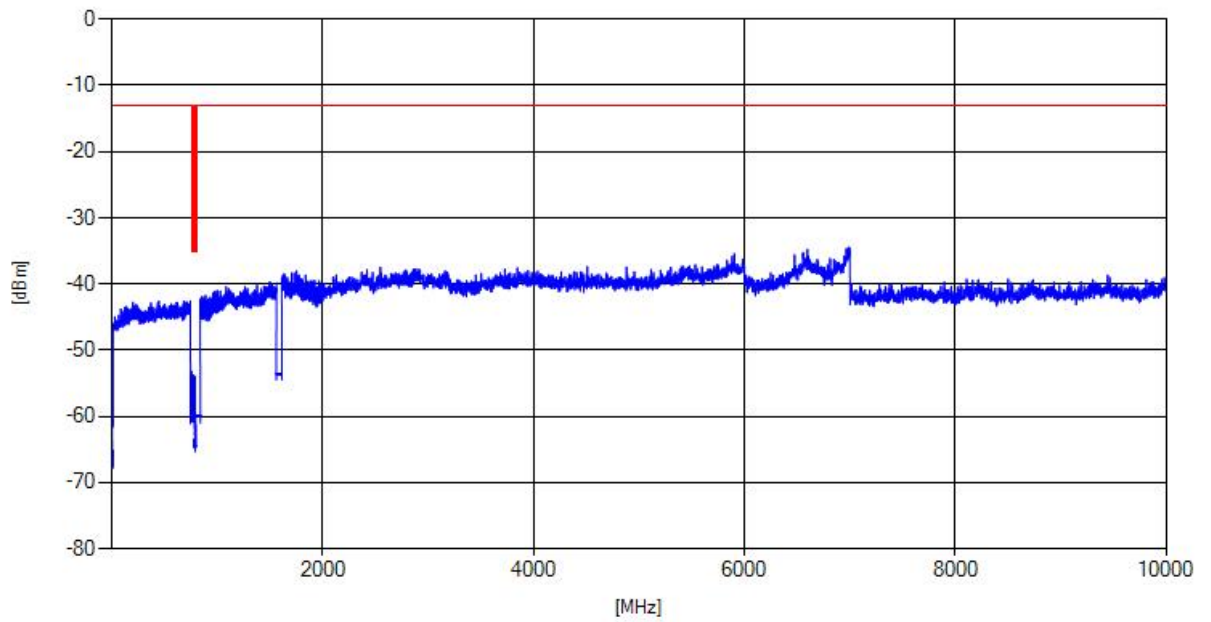

CAT-M1 eFDD66, Channel = low

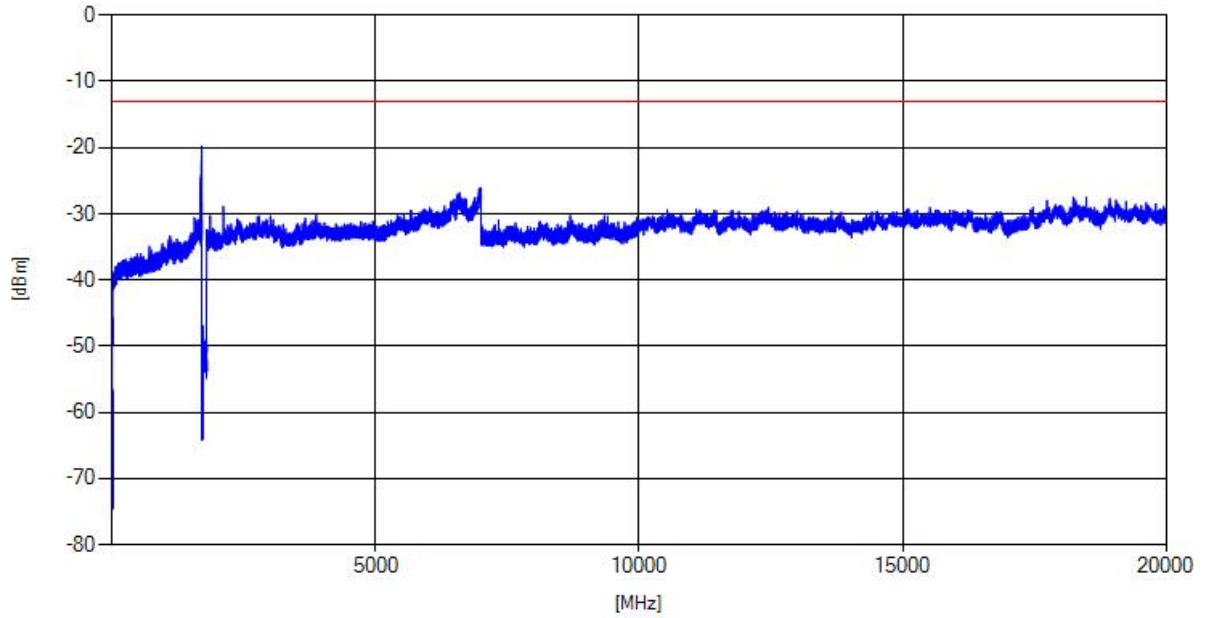

NB-IoT eFDD4, Channel = high

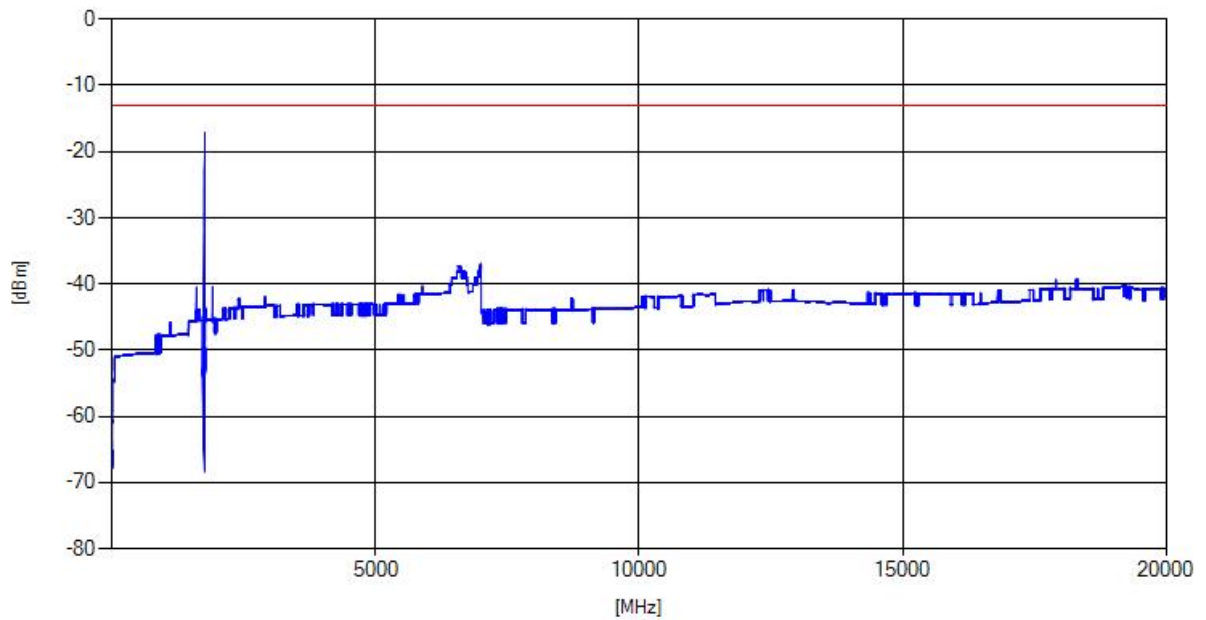



NB-IoT eFDD8, Channel = low

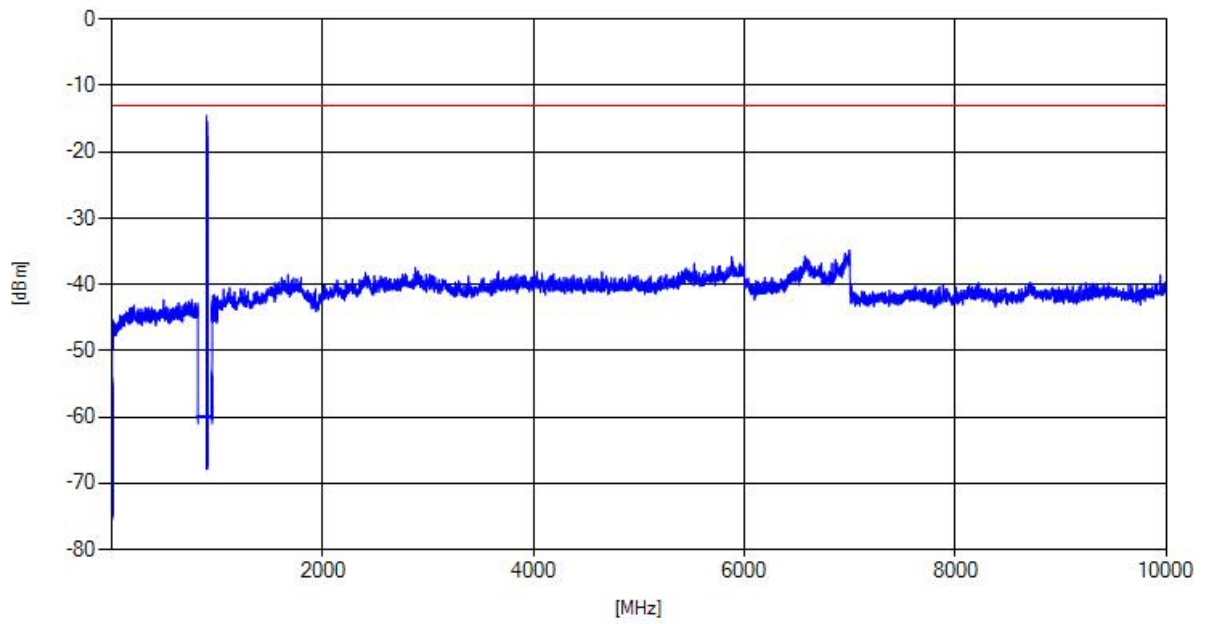

NB-IoT eFDD12, Channel = high

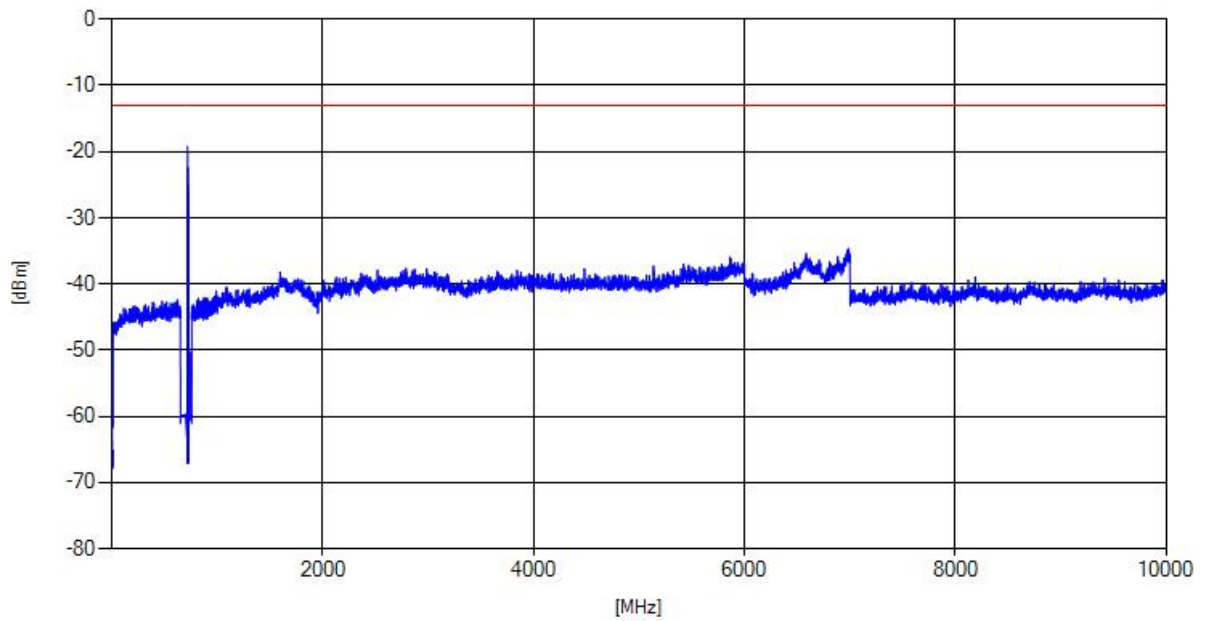

NB-IoT eFDD13, Channel = mid

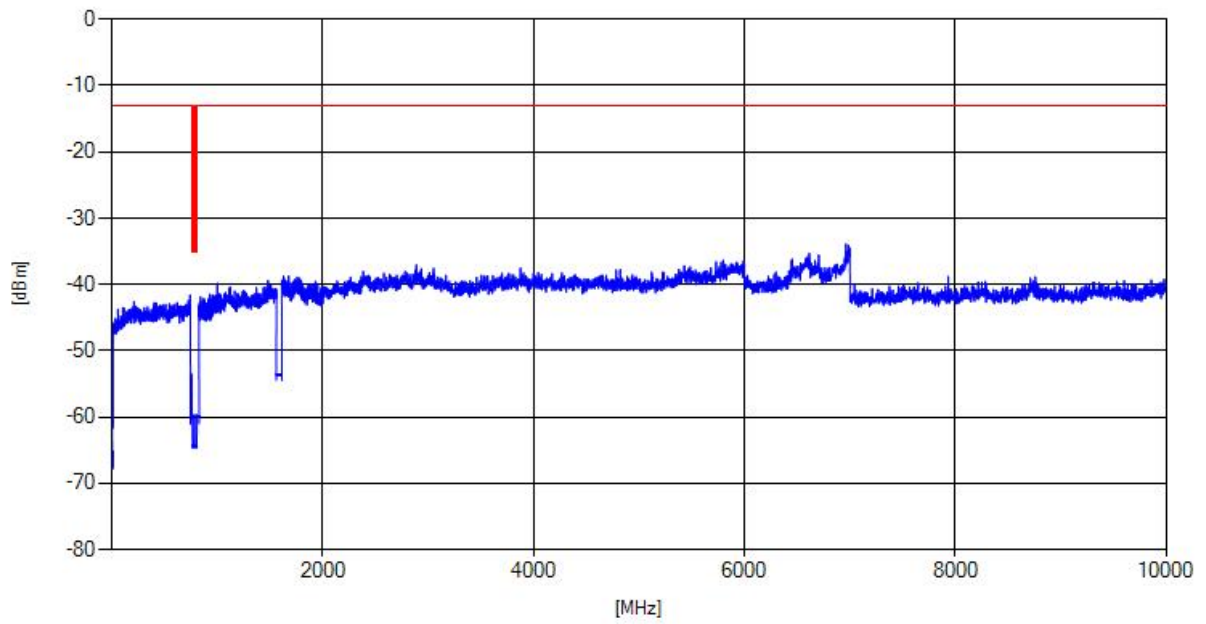

NB-IoT eFDD66, Channel = high

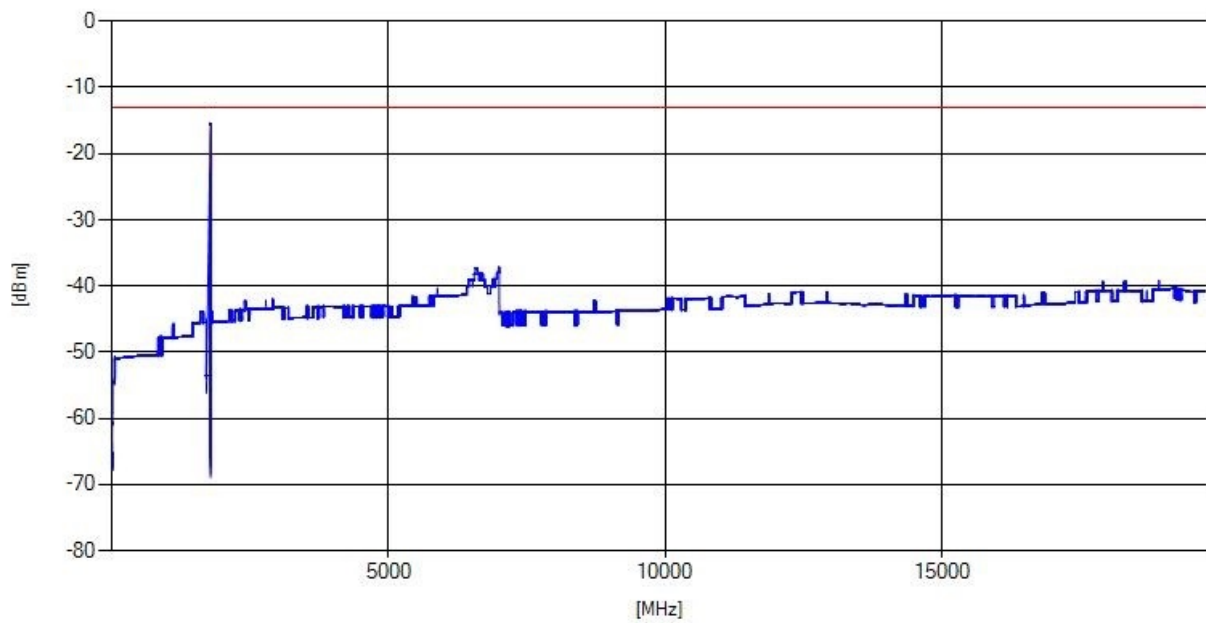

NB-IoT eFDD71, Channel = low

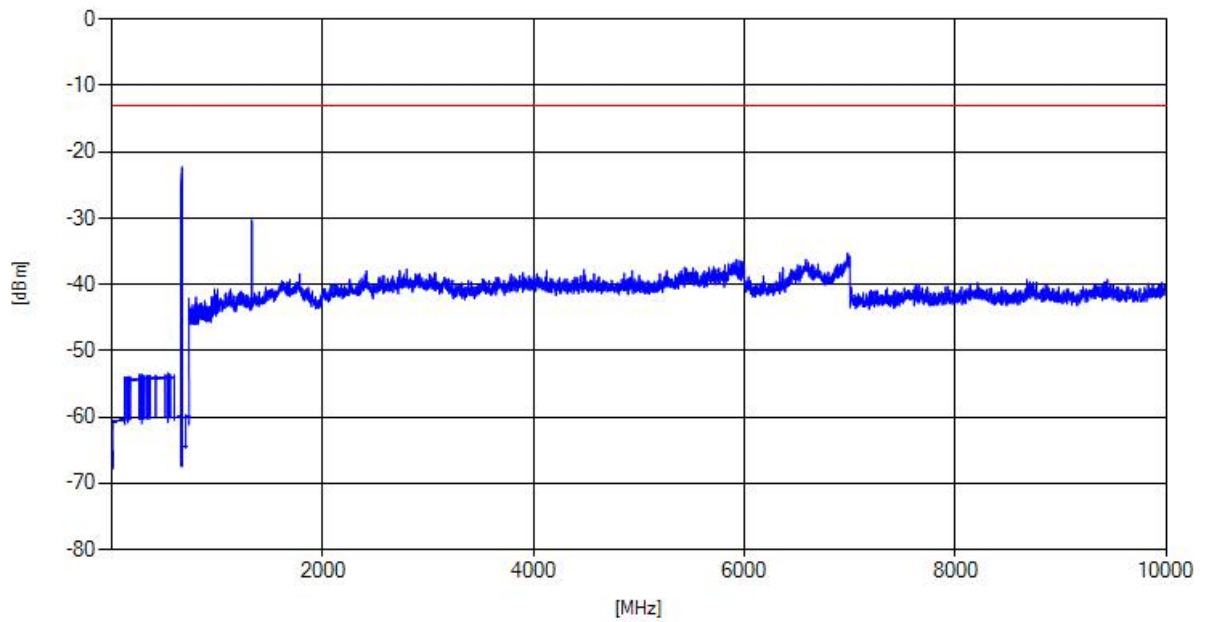

NB-IoT eFDD85, Channel = high

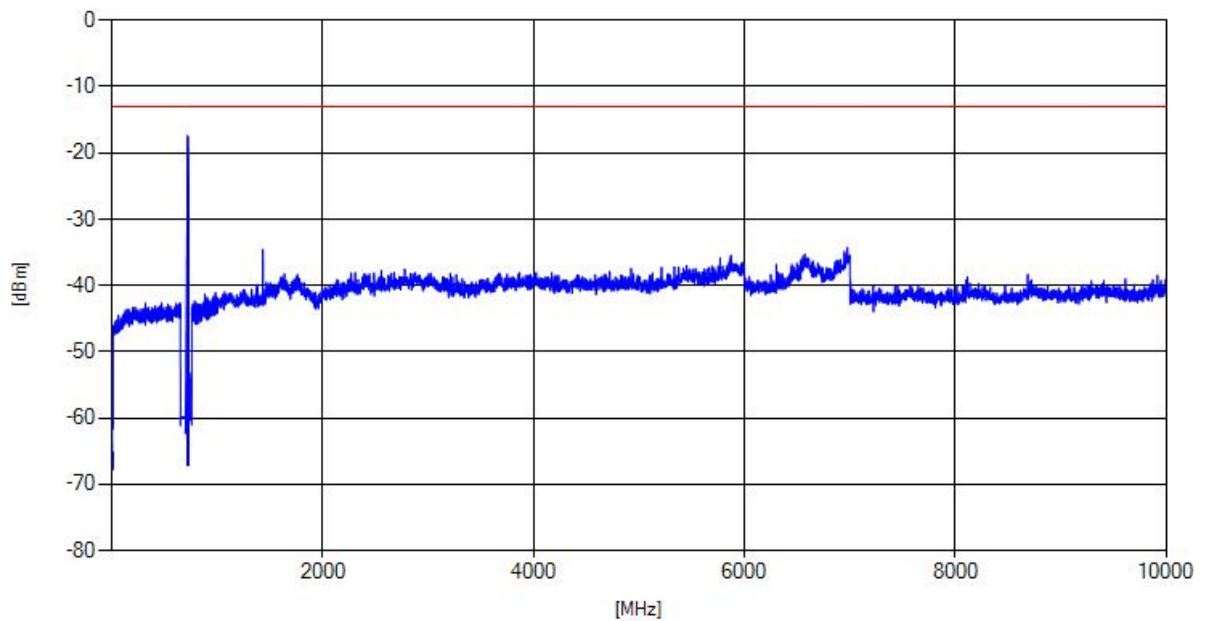

### 5.17.5 TEST EQUIPMENT USED

- Radio Lab

## 5.18 FIELD STRENGTH OF SPURIOUS RADIATION

Standard **FCC PART 27 Subpart C**

**The test was performed according to:**  
ANSI C63.26: 2015

### 5.18.1 TEST DESCRIPTION

This test case is intended to demonstrate compliance to the applicable radiated spurious emission measurements per § 2.1053 and RSS-GEN 6.13. The limit and requirements come from the applicable rule part and ISED RSS-Standard for the operating band of the cellular device.

The EUT was connected to the test setup according to the following diagram:

Frequency Range: 30 MHz – 1 GHz:

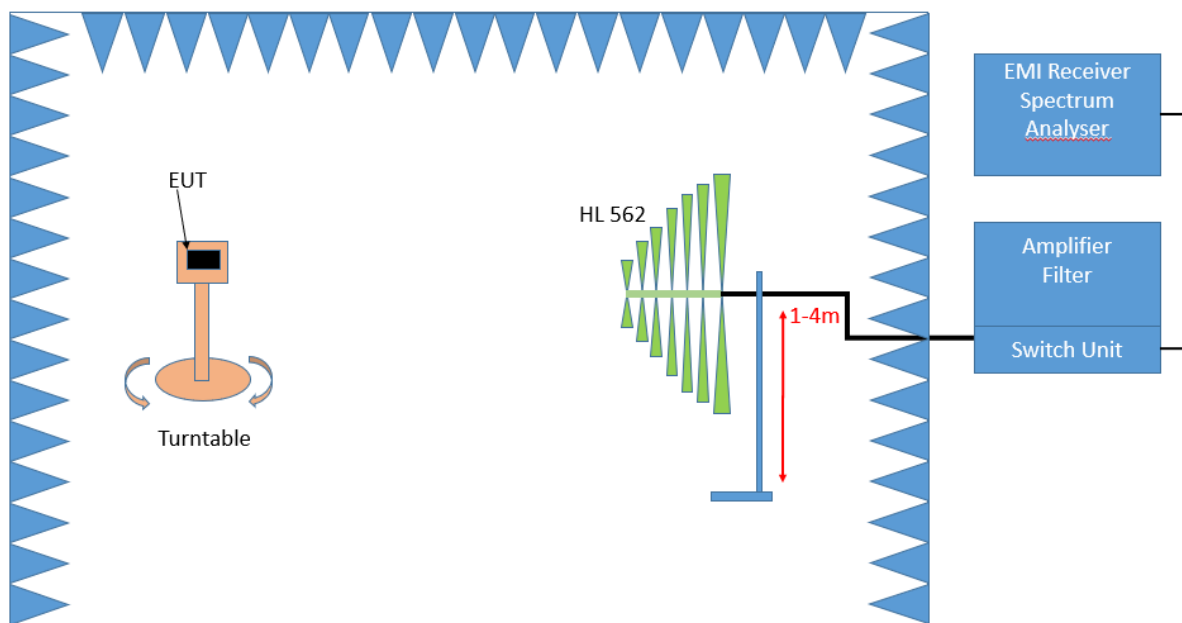

Test Setup; Spurious Emission Radiated (SAC), 30 MHz- 1GHz

Frequency Range: 1 GHz – 26.5 GHz

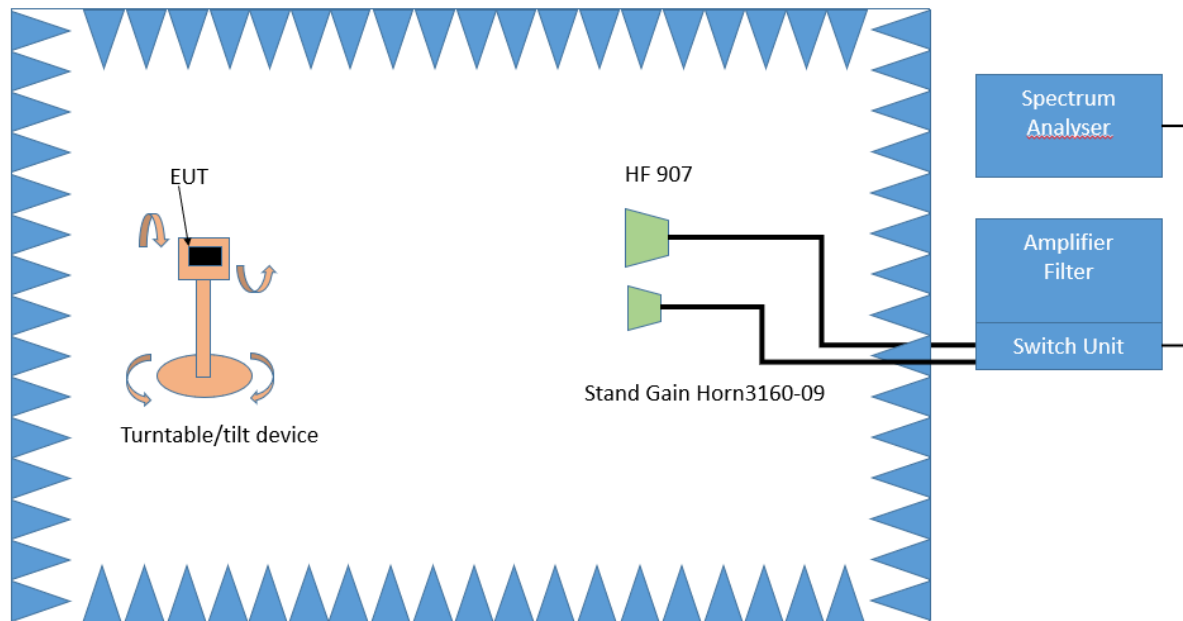

Test Setup; Spurious Emission Radiated (FAC), 1 GHz-26.5 GHz

The test set-up was made in accordance to the general provisions of ANSI C63.26 in a typical installation configuration. The Equipment Under Test (EUT) was set up on a non-conductive table 1.0 x 2.0 m<sup>2</sup> in the semi-anechoic chamber. The influence of the EUT support table that is used between 30–1000 MHz was evaluated.

The measurement procedure is implemented into the EMI test software EMC32 from R&S. Exploratory tests are performed at 3 orthogonal axes to determine the worst-case orientation of a body-worn or handheld EUT. The final test on all kind of EUTs is also performed at 3 axes. A pre-check is performed while the EUT is powered from a DC power source.

## 1. Measurement above 30 MHz and up to 1 GHz

### Step 1: Preliminary scan

This is a preliminary test to identify the highest amplitudes relative to the limit.

Settings for step 1:

- Antenna distance: 3 m
- Detector: Peak
- RBW: 100 kHz
- VBW: 300 kHz
- Sweep time: coupled
- Turntable angle range: -180° to 90°
- Turntable step size: 90°
- Height variation range: 1 – 4 m
- Height variation step size: 1.5 m
- Polarisation: Horizontal + Vertical

Intention of this step is, to determine the radiated EMI-profile of the EUT. Afterwards the relevant emissions for the final measurement are identified.

### Step 2: Adjustment measurement

In this step the accuracy of the turntable azimuth and antenna height will be improved. This is necessary to find out the maximum value of every frequency.

For each frequency, which was determined the turntable azimuth and antenna height will be adjusted. The turntable azimuth will slowly vary by 360°. During this action, the value of emission is continuously measured. The turntable azimuth at the highest emission will be recorded and adjusted. In this position, the antenna height will also slowly vary by 1 – 4 m.

During this action, the value of emission is also continuously measured. The antenna height of the highest emission will also be recorded and adjusted.

- Detector: Peak
- Measured frequencies: in step 1 determined frequencies
- RBW: 100 kHz
- VBW: 300 kHz
- Sweep time: coupled
- Turntable angle range: 360°
- Height variation range: 1 - 4 m
- Antenna Polarisation: max. value determined in step 1

**Step 3:** Final measurement with RMS detector

With the settings determined in step 3, the final measurement will be performed:

EMI receiver settings for step 4:

- Detector: RMQ
- Measured frequencies: in step 1 determined frequencies
- RBW: 100 kHz
- VBW: 300 kHz
- Sweep time: 1 s

After the measurement a plot will be generated which contains a diagram with the results of the preliminary scan and a chart with the frequencies and values of the results of the final measurement.

**3. Measurement above 1 GHz**

The following modifications apply to the measurement procedure for the frequency range above 1 GHz:

**Step 1:**

The Equipment Under Test (EUT) was set up on a non-conductive support (tilt device) at 1.5 m height in the fully-anechoic chamber.

All steps were performed with one height (1.5 m) of the receiving antenna only.

The EUT is turned during the preliminary measurement across the elevation axis, with a step size of 45 °.

The turn table step size (azimuth angle) for the preliminary measurement is 45 °.

- Antenna distance: 3 m
- Detector: Peak
- RBW: 1 MHz
- VBW: 3 MHz
- Sweep time: coupled
- Turntable angle range: -180° to 135°
- Turntable step size: 45°
- Polarisation: Horizontal + Vertical

**Step 2:**

Due to the fact, that in this frequency range the test is performed in a fully anechoic room, the height scan of the receiving antenna instep 2 is omitted. Instead of this, a maximum search with a step size  $\pm 45^\circ$  for the elevation axis is performed.

The turn table azimuth will slowly vary by  $\pm 22.5^\circ$ .

The elevation angle will slowly vary by  $\pm 45^\circ$

EMI receiver settings (for all steps):

- Detector: Peak,
- RBW: 1 MHz
- VBW: 3 MHz
- Sweep time: coupled

**Step 3:**

Spectrum analyser settings for step 3:

- Detector: RMS
- Measured frequencies: in step 1 determined frequencies
- RBW: 1 MHz
- VBW: 3 MHz
- Sweep Time: 1 s

## 5.18.2 TEST REQUIREMENTS / LIMITS

### **FCC Part 2.1053; Measurement required: Field strength of spurious radiation:**

Measurements shall be made to detect spurious emissions that may be radiated directly from the cabinet, control circuits, power leads, or intermediate circuit elements under normal conditions of installation and operation. Curves or equivalent data shall be supplied showing the magnitude of each harmonic and other spurious emission. For this test, single sideband, independent sideband, and controlled carrier transmitters shall be modulated under the conditions specified in paragraph (c) of §2.1049, as appropriate.

### **FCC Part 27; Miscellaneous Wireless Communication Services**

#### **Subpart C – Technical standards**

#### **§27.53 – Emission limits**

##### **Band 13**

(c) For operations in the 746-758 MHz band and the 776-788 MHz band, the power of any emission outside the licensee's frequency band(s) of operation shall be attenuated below the transmitter power (P) within the licensed band(s) of operation, measured in watts, in accordance with the following:

- (1) On any frequency outside the 746-758 MHz band, the power of any emission shall be attenuated outside the band below the transmitter power (P) by at least  $43 + 10 \log (P)$  dB;
- (2) On any frequency outside the 776-788 MHz band, the power of any emission shall be attenuated outside the band below the transmitter power (P) by at least  $43 + 10 \log (P)$  dB;
- (3) On all frequencies between 763-775 MHz and 793-805 MHz, by a factor not less than  $76 + 10 \log (P)$  dB in a 6.25 kHz band segment, for base and fixed stations;
- (4) On all frequencies between 763-775 MHz and 793-805 MHz, by a factor not less than  $65 + 10 \log (P)$  dB in a 6.25 kHz band segment, for mobile and portable stations;
- (5) Compliance with the provisions of paragraphs (c)(1) and (c)(2) of this section is based on the use of measurement instrumentation employing a resolution bandwidth of 100 kHz or greater. However, in the 100 kHz bands immediately outside and adjacent to the frequency block, a resolution bandwidth of at least 30 kHz may be employed;
- (f) For operations in the 746-758 MHz, 775-788 MHz, and 805-806 MHz bands, emissions in the band 1559-1610 MHz shall be limited to  $-70$  dBW/MHz equivalent isotropically radiated power (EIRP) for wideband signals, and  $-80$  dBW EIRP for discrete emissions of less than 700 Hz bandwidth. For the purpose of equipment authorization, a transmitter shall be tested with an antenna that is representative of the type that will be used with the equipment in normal operation.
- (6) Compliance with the provisions of paragraphs (c)(3) and (c)(4) of this section is based on the use of measurement instrumentation such that the reading taken with any resolution bandwidth setting should be adjusted to indicate spectral energy in a 6.25 kHz segment.

### **RSS-130; 4.7.1 General unwanted emissions limits**

The unwanted emissions in any 100 kHz bandwidth on any frequency outside the low frequency edge and the high frequency edge of each frequency block range(s), shall be attenuated below the transmitter power, P (dBW), by at least  $43 + 10 \log_{10} p$  (watts), dB. However, in the 100 kHz band immediately outside of the equipment's frequency block range, a resolution bandwidth of 30 kHz may be employed.

### **RSS-130; 4.7.2 Additional unwanted emissions limits**

In addition to the limit outlined in section 4.7.1 above, equipment operating in the frequency bands 746-756 MHz and 777-787 MHz shall also comply with the following restrictions:

- a. the power of any unwanted emissions in any 6.25 kHz bandwidth for all frequencies between 763-775 MHz and 793-806 MHz shall be attenuated below the transmitter power, P (dBW), by at least:
  - i.  $76 + 10 \log_{10} p$  (watts), dB, for base and fixed equipment and
  - ii.  $65 + 10 \log_{10} p$  (watts), dB, for mobile and portable equipment
- b. the e.i.r.p. in the band 1559-1610 MHz shall not exceed  $-70$  dBW/MHz for wideband signal and  $-80$  dBW for discrete emission with bandwidth less than 700 Hz.

### **Band 12:**

(g) For operations in the 600 MHz band and the 698-746 MHz band, the power of any emission outside a licensee's frequency band(s) of operation shall be attenuated below the transmitter power (P) within the licensed band(s) of operation, measured in watts, by at least  $43 + 10 \log(P)$  dB. Compliance with this provision is based on the use of measurement instrumentation employing a resolution bandwidth of 100 kilohertz or greater. However, in the 100 kilohertz bands immediately outside and adjacent to a licensee's frequency block, a resolution bandwidth of at least 30 kHz may be employed.

### **RSS-130; 4.7.1 General unwanted emissions limits**

The unwanted emissions in any 100 kHz bandwidth on any frequency outside the low frequency edge and the high frequency edge of each frequency block range(s), shall be attenuated below the transmitter power, P (dBW), by at least  $43 + 10 \log_{10} p$  (watts), dB. However, in the 100 kHz band immediately outside of the equipment's frequency block range, a resolution bandwidth of 30 kHz may be employed.

### **RSS-130; 4.7.2 Additional unwanted emissions limits**

In addition to the limit outlined in section 4.7.1 above, equipment operating in the frequency bands 746-756 MHz and 777-787 MHz shall also comply with the following restrictions:

- a. the power of any unwanted emissions in any 6.25 kHz bandwidth for all frequencies between 763-775 MHz and 793-806 MHz shall be attenuated below the transmitter power, P (dBW), by at least:
  - i.  $76 + 10 \log_{10} p$  (watts), dB, for base and fixed equipment and
  - ii.  $65 + 10 \log_{10} p$  (watts), dB, for mobile and portable equipment
- b. the e.i.r.p. in the band 1559-1610 MHz shall not exceed  $-70$  dBW/MHz for wideband signal and  $-80$  dBW for discrete emission with bandwidth less than 700 Hz.



#### **Band 4/10/66:**

(h) *AWS emission limits*—(1) *General protection levels.* Except as otherwise specified below, for operations in the 1695-1710 MHz, 1710-1755 MHz, 1755-1780 MHz, 1915-1920 MHz, 1995-2000 MHz, 2000-2020 MHz, 2110-2155 MHz, 2155-2180 MHz, and 2180-2200 bands, the power of any emission outside a licensee's frequency block shall be attenuated below the transmitter power (P) in watts by at least  $43 + 10 \log_{10} (P)$  dB.

#### **RSS-139; 6.6 Transmitter Unwanted Emissions**

Equipment shall comply with the limits in (i) and (ii) below.

- i. In the first 1.0 MHz bands immediately outside and adjacent to the equipment's smallest operating frequency block, which can contain the equipment's occupied bandwidth, the emission power per any 1% of the emission bandwidth shall be attenuated below the transmitter output power P (in dBW) by at least  $43 + 10 \log_{10} p$  (watts) dB.
- ii. After the first 1.0 MHz outside the equipment's smallest operating frequency block, which can contain the equipment's occupied bandwidth, the emission power in any 1 MHz bandwidth shall be attenuated below the transmitter output power P (in dBW) by at least  $43 + 10 \log_{10} p$  (watts) dB.

#### **Band 7:**

(m) For BRS and EBS stations, the power of any emissions outside the licensee's frequency bands of operation shall be attenuated below the transmitter power (P) measured in watts in accordance with the standards below. If a licensee has multiple contiguous channels, out-of-band emissions shall be measured from the upper and lower edges of the contiguous channels.

(4) For mobile digital stations, the attenuation factor shall be not less than  $40 + 10 \log (P)$  dB on all frequencies between the channel edge and 5 megahertz from the channel edge,  $43 + 10 \log (P)$  dB on all frequencies between 5 megahertz and X megahertz from the channel edge, and  $55 + 10 \log (P)$  dB on all frequencies more than X megahertz from the channel edge, where X is the greater of 6 megahertz or the actual emission bandwidth as defined in paragraph (m)(6) of this section. In addition, the attenuation factor shall not be less than  $43 + 10 \log (P)$  dB on all frequencies between 2490.5 MHz and 2496 MHz and  $55 + 10 \log (P)$  dB at or below 2490.5 MHz. Mobile Satellite Service licensees operating on frequencies below 2495 MHz may also submit a documented interference complaint against BRS licensees operating on channel BRS Channel 1 on the same terms and conditions as adjacent channel BRS or EBS licensees.

#### **RSS-199; 4.5 Transmitter unwanted emissions**

In the 1 MHz band immediately outside and adjacent to the channel edge, the unwanted emission power shall be measured with a resolution bandwidth of at least 1% of the occupied bandwidth for base station and fixed subscriber equipment, and 2% for mobile subscriber equipment. Beyond the 1 MHz band, a resolution bandwidth of 1 MHz shall be used. A narrower resolution bandwidth can be used, provided that the measured power is integrated over the full required measurement bandwidth of 1 MHz, or 1% or 2% of the occupied bandwidth, as applicable.

Equipment shall comply with the following unwanted emission limits:

b. for mobile subscriber equipment, the power of any unwanted emissions measured as above shall be attenuated (in dB) below the transmitter power, P (dBW), by at least:

$40 + 10 \log_{10} p$  from the channel edges to 5 MHz away

$43 + 10 \log_{10} p$  between 5 MHz and X MHz from the channel edges, and

$55 + 10 \log_{10} p$  at X MHz and beyond from the channel edges

In addition, the attenuation shall not be less than  $43 + 10 \log_{10} p$  on all frequencies between 2490.5 MHz and 2496 MHz, and  $55 + 10 \log_{10} p$  at or below 2490.5 MHz.

In (b), p is the transmitter power measured in watts and X is 6 MHz or the equipment occupied bandwidth, whichever is greater.

#### **Band 17:**

(g) For operations in the 600 MHz band and the 698-746 MHz band, the power of any emission outside a licensee's frequency band(s) of operation shall be attenuated below the transmitter power (P) within the licensed band(s) of operation, measured in watts, by at least  $43 + 10 \log (P)$  dB. Compliance with this provision is based on the use of measurement instrumentation employing a resolution bandwidth of 100 kilohertz or greater. However, in the 100 kilohertz bands immediately outside and adjacent to a licensee's frequency block, a resolution bandwidth of at least 30 kHz may be employed.

#### **RSS-130; 4.7.1 General unwanted emissions limits**

The unwanted emissions in any 100 kHz bandwidth on any frequency outside the low frequency edge and the high frequency edge of each frequency block range(s), shall be below the transmitter power, P (dBW), by at least  $43 + 10 \log_{10} p$  (watts), dB. However, in the 100 kHz band immediately outside of the equipment's frequency block range, a resolution bandwidth of 30 kHz may be employed.

#### **RSS-130; 4.7.2 Additional unwanted emissions limits**

In attenuated addition to the limit outlined in section 4.7.1 above, equipment operating in the frequency bands 746-756 MHz and 777-787 MHz shall also comply with the following restrictions:

- a. the power of any unwanted emissions in any 6.25 kHz bandwidth for all frequencies between 763-775 MHz and 793-806 MHz shall be attenuated below the transmitter power, P (dBW), by at least:
  - i.  $76 + 10 \log_{10} p$  (watts), dB, for base and fixed equipment and
  - ii.  $65 + 10 \log_{10} p$  (watts), dB, for mobile and portable equipment
- b. the e.i.r.p. in the band 1559-1610 MHz shall not exceed  $-70$  dBW/MHz for wideband signal and  $-80$  dBW for discrete emission with bandwidth less than 700 Hz.

### **Subpart P – Regulations Governing Licensing and Use of 900 MHz Broadband Service in the 897.5 – 900.5 MHz and 936.5 - 939.5 MHz Bands**

#### **§27.1509 Emission limits**

The power of any emission outside a licensee's frequency band(s) of operation shall be attenuated below the transmitter power (P) in watts by at least the following amounts:

(a) For 900 MHz broadband operations in 897.5-900.5 MHz band by at least  $43 + 10 \log (P)$  dB.

(b) For 900 MHz broadband operations in the 936.5-939.5 MHz band, by at least  $50 + 10 \log (P)$  dB.

(c) Compliance with the provisions of paragraphs (a) and (b) of this section is based on the use of measurement instrumentation employing a resolution bandwidth of 100 kHz or greater. However, in the 100 kHz bands immediately outside and adjacent to the licensee's band, a resolution bandwidth of at least 1 percent of the emission bandwidth of the fundamental emission of the transmitter may be employed. The emission bandwidth is defined as the width

of the signal between two points, one below the carrier center frequency and one above the carrier center frequency, outside of which all emissions are attenuated at least 26 dB below the transmitter power.

(d) The measurements of emission power can be expressed in peak or average values, provided they are expressed in the same parameters as the transmitter power.

(e) When an emission outside of the authorized bandwidth causes harmful interference, the Commission may, at its discretion, require greater attenuation than specified in this section.