

EDGE 1900, Channel = high  
30 MHz - 1 GHz

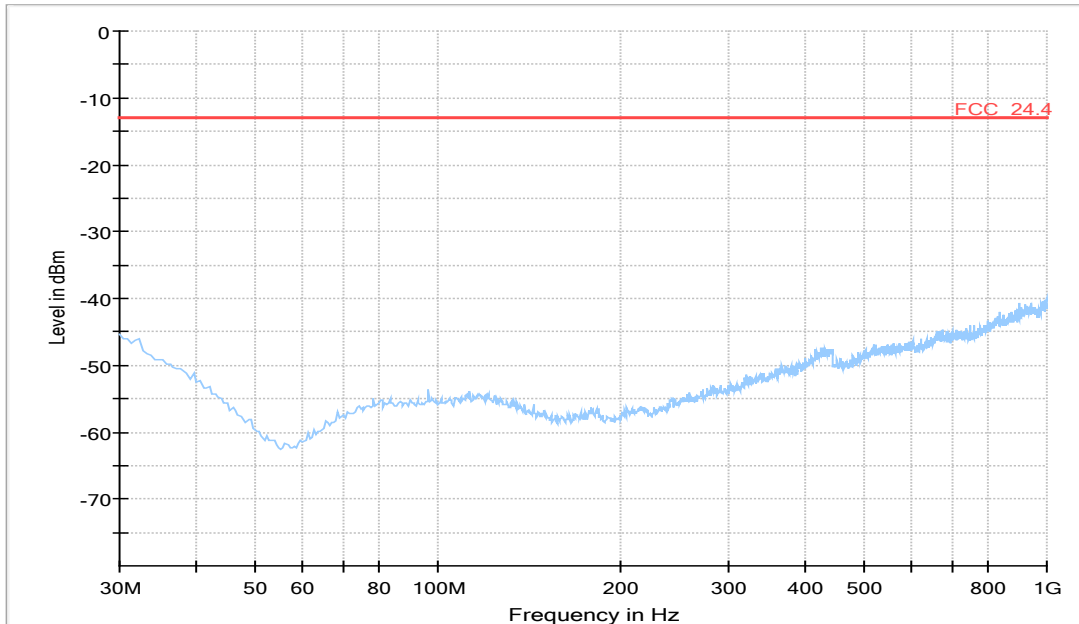

1 GHz - 20 GHz

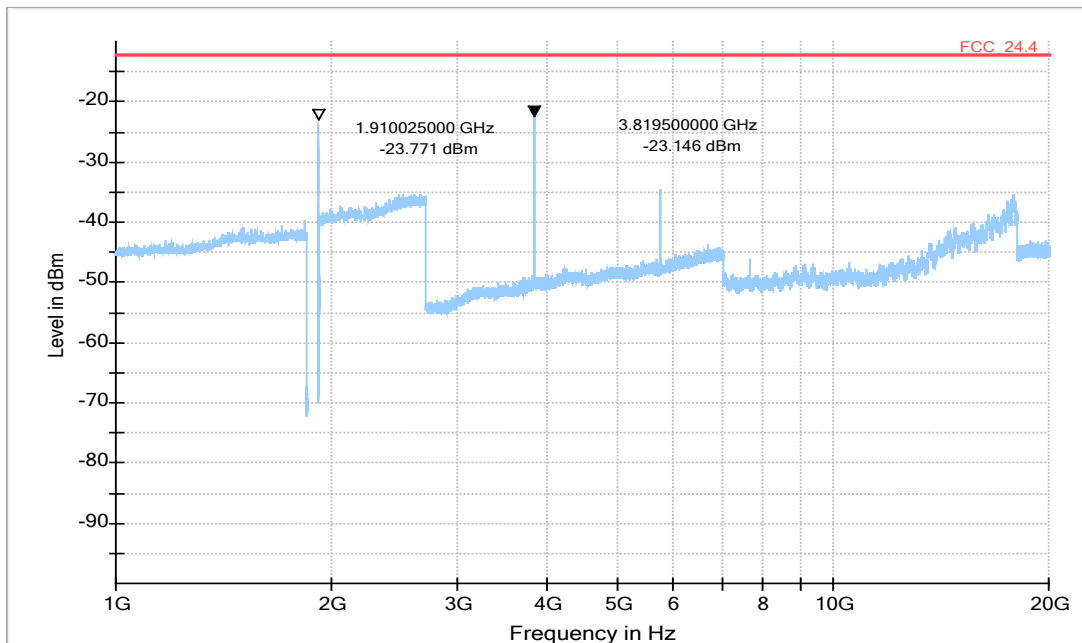

CAT-M1 eFDD2, Channel = mid  
30 MHz – 1 GHz

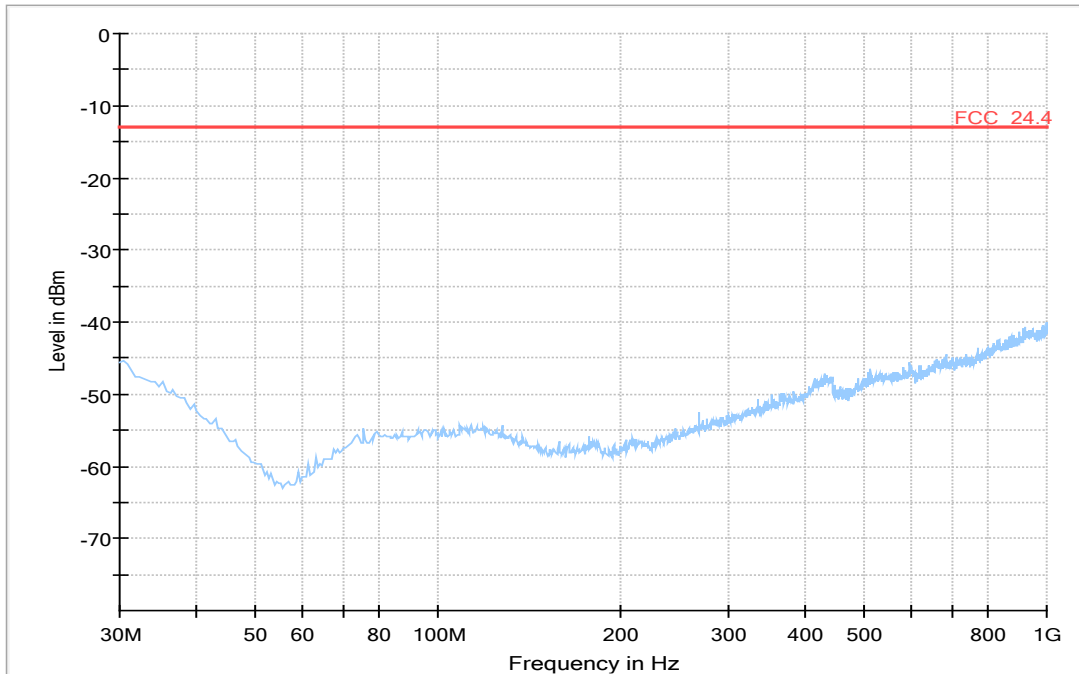

1 GHz – 20 GHz

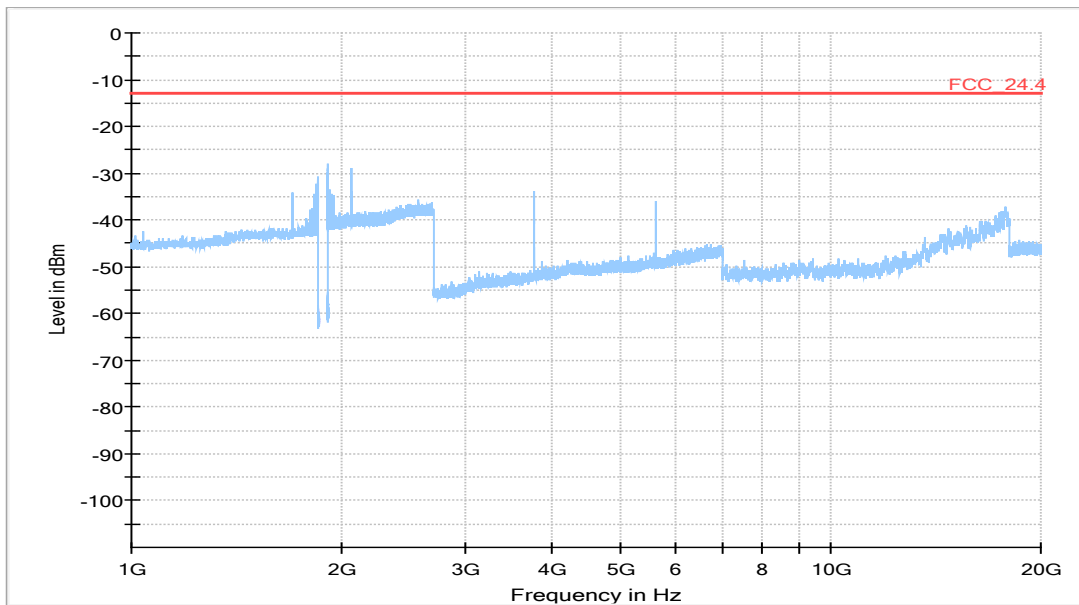

CAT-M1 eFDD25, Channel = low  
30 MHz – 1 GHz

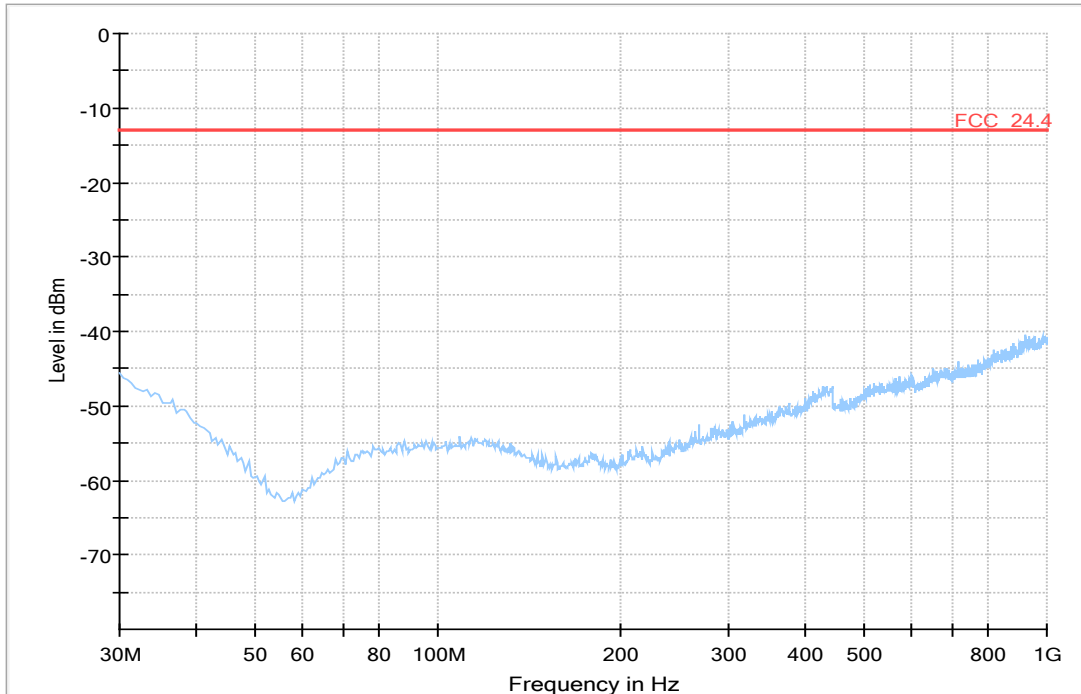

1 GHz – 20 GHz

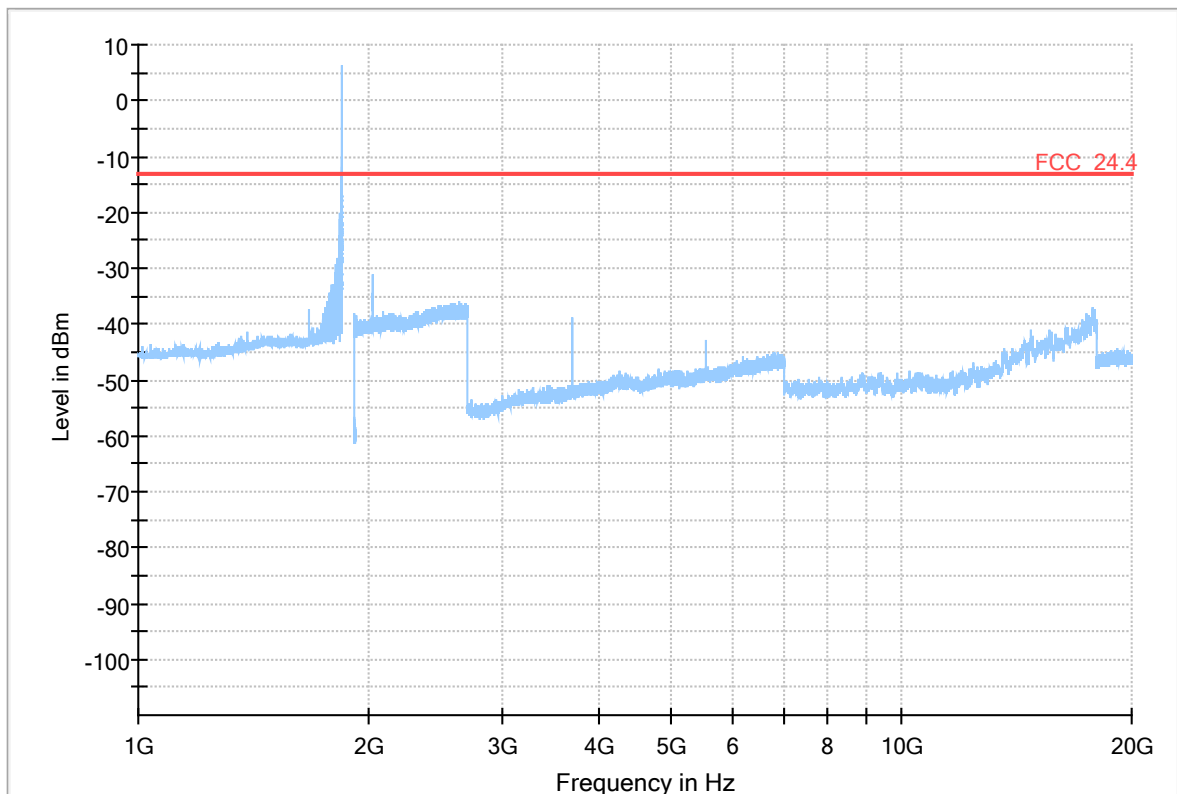

re-measurement at carrier

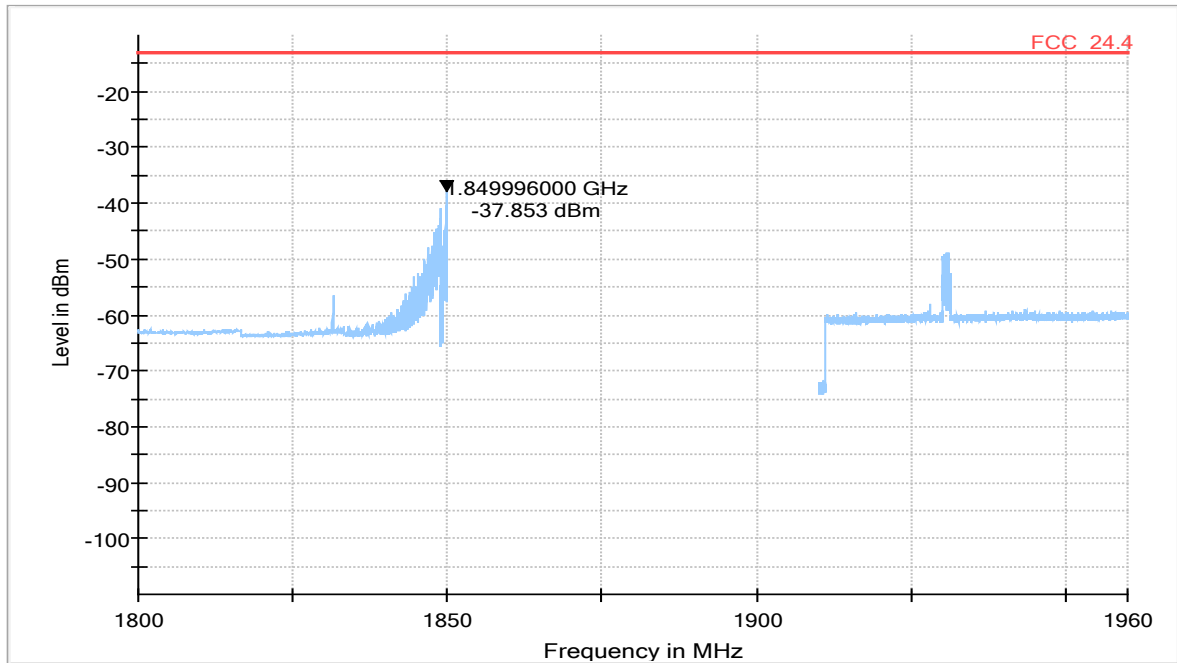

NB-IoT eFDD2, Channel = low  
30 MHz – 1 GHz

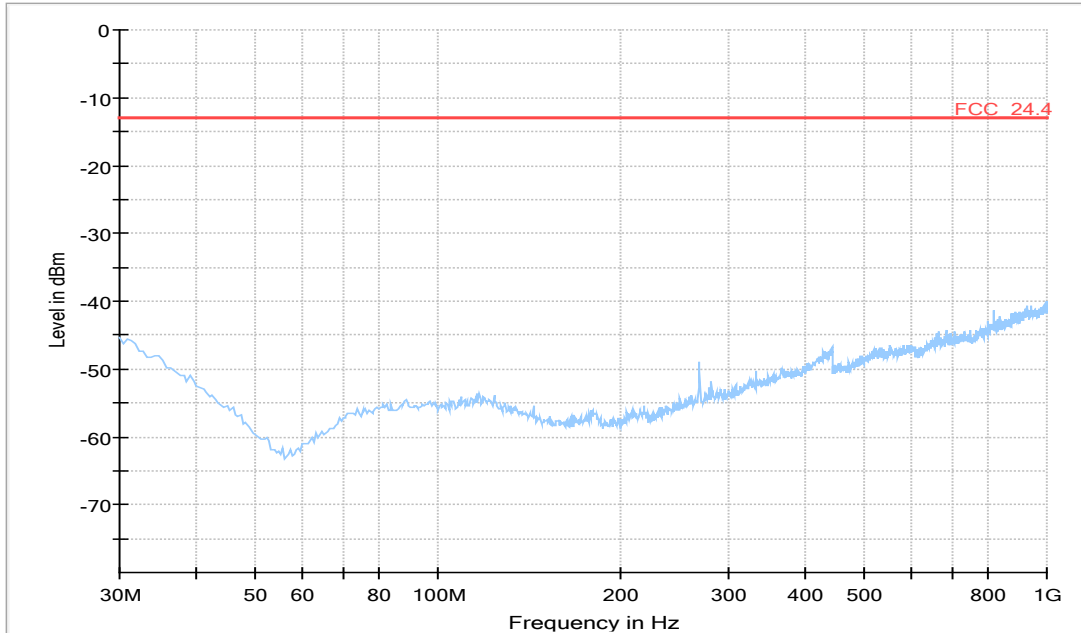

1 GHz – 20 GHz

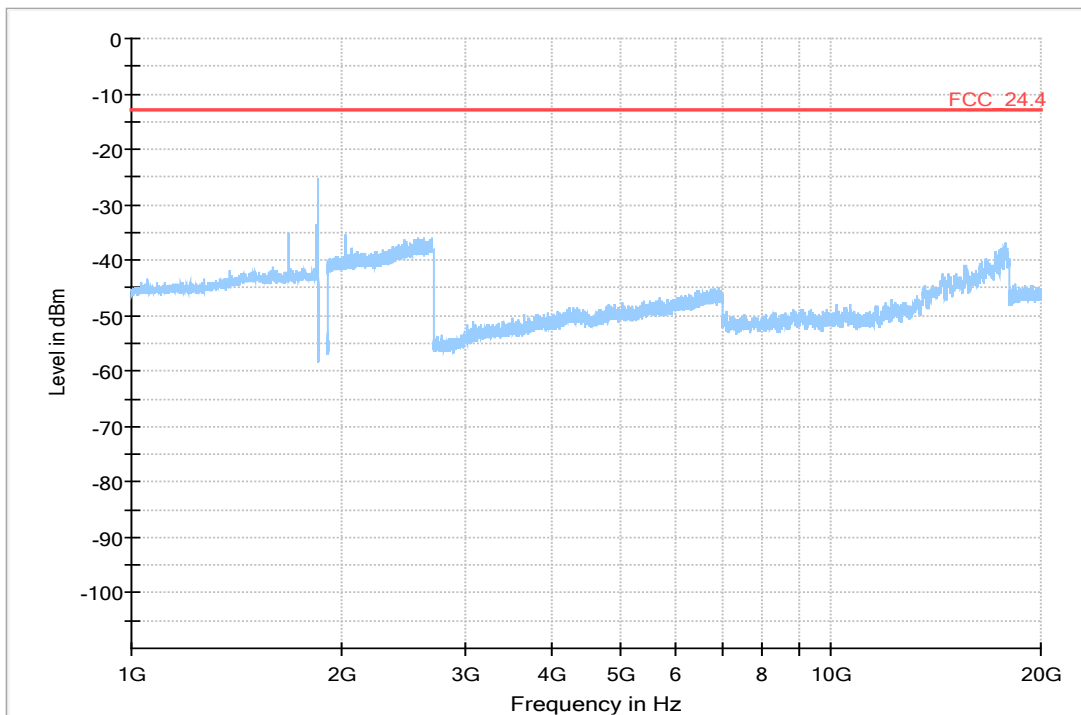

### 5.11.5 TEST EQUIPMENT USED

- Radiated Emissions

## 5.12 EMISSION AND OCCUPIED BANDWIDTH

Standard **FCC PART 24 Subpart E**

**The test was performed according to:**  
ANSI C63.26: 2015

### 5.12.1 TEST DESCRIPTION

This test case is intended to demonstrate compliance to the applicable conducted spurious emission test case per FCC §2.1049 and RSS-GEN 6.7. The limit and the requirements come from the applicable rule part and ISED RSS-Standard for the operating band of the cellular device.

The EUT was connected to the test setups according to the following diagram:

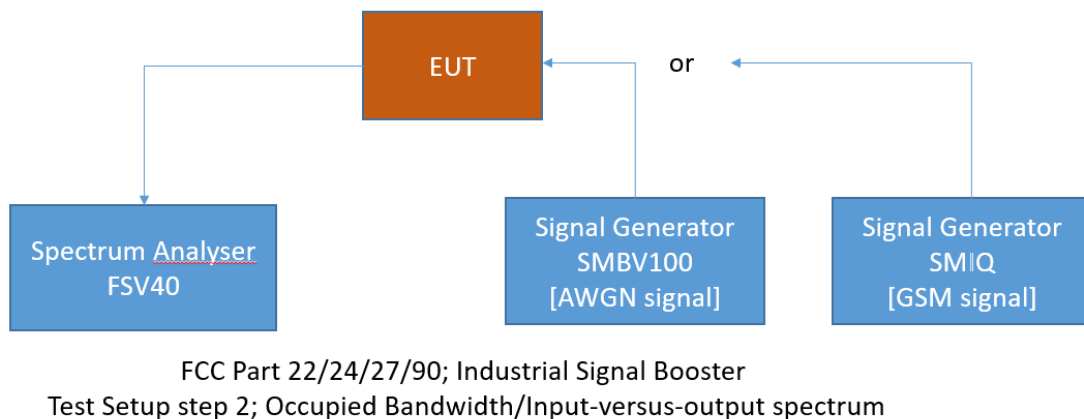
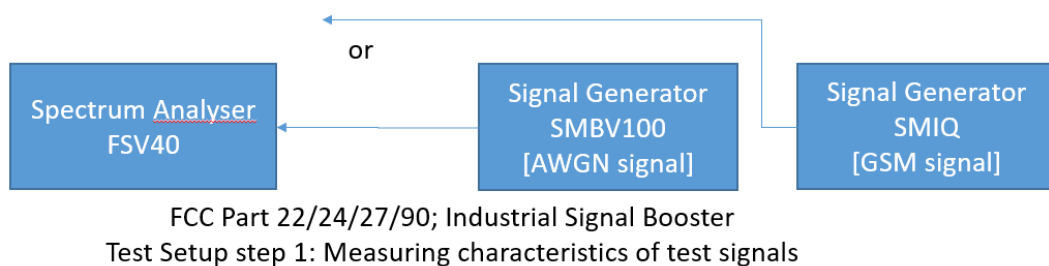

The attenuation of the measuring and stimulus path are known for each measured frequency and are considered.

The Spectrum Analyzer settings can be directly found in the measurement diagrams.

## 5.12.2 TEST REQUIREMENTS / LIMITS

### **FCC Part 2.1049; Occupied Bandwidth:**

The occupied bandwidth, that is the frequency bandwidth such that, below its lower and above its upper frequency limits, the mean powers radiated are each equal to 0.5 percent of the total mean power radiated by a given emission shall be measured under the following conditions as applicable:

(h) Transmitters employing digital modulation techniques—when modulated by an input signal such that its amplitude and symbol rate represent the maximum rated conditions under which the equipment will be operated. The signal shall be applied through any filter networks, pseudo-random generators or other devices required in normal service. Additionally, the occupied bandwidth shall be shown for operation with any devices used for modifying the spectrum when such devices are optional at the discretion of the user.

(i) Transmitters designed for other types of modulation—when modulated by an appropriate signal of sufficient amplitude to be representative of the type of service in which used. A description of the input signal should be supplied.

### **RSS-GEN; 6.7 Occupied Bandwidth (or 99% emission bandwidth) and x dB bandwidth**

The occupied bandwidth or the “99% emission bandwidth” is defined as the frequency range between two points, one above and the other below the carrier frequency, within which 99% of the total transmitted power of the fundamental transmitted emission is contained. The occupied bandwidth shall be reported for all equipment in addition to the specified bandwidth required in the applicable RSSs.

In some cases, the “x dB bandwidth” is required, which is defined as the frequency range between two points, one at the lowest frequency below and one at the highest frequency above the carrier frequency, at which the maximum power level of the transmitted emission is attenuated x dB below the maximum in-band power level of the modulated signal, where the two points are on the outskirts of the in-band emission.

The following conditions shall be observed for measuring the occupied bandwidth and x dB bandwidth:

The transmitter shall be operated at its maximum carrier power measured under normal test conditions.

The span of the spectrum analyzer shall be set large enough to capture all products of the modulation process, including the emission skirts, around the carrier frequency, but small enough to avoid having other emissions (e.g. on adjacent channels) within the span. The detector of the spectrum analyzer shall be set to “Sample”. However, a peak, or peak hold, may be used in place of the sampling detector since this usually produces a wider bandwidth than the actual bandwidth (worst-case measurement). Use of a peak hold (or “Max Hold”) may be necessary to determine the occupied / x dB bandwidth if the device is not transmitting continuously.

The resolution bandwidth (RBW) shall be in the range of 1% to 5% of the actual occupied / x dB bandwidth and the video bandwidth (VBW) shall not be smaller than three times the RBW value. Video averaging is not permitted.

Note: It may be necessary to repeat the measurement a few times until the RBW and VBW are in compliance with the above requirement.

For the 99% emission bandwidth, the trace data points are recovered and directly summed in linear power level terms. The recovered amplitude data points, beginning at the lowest frequency, are placed in a running sum until 0.5% of the total is reached, and that frequency recorded. The process is repeated for the highest frequency data points (starting at the highest frequency, at the right side of the span, and going down in frequency). This frequency is then recorded. The difference between the two recorded frequencies is the occupied bandwidth (or the 99% emission bandwidth).

### 5.12.3 TEST PROTOCOL

Ambient temperature: 20 - 25 °C  
Relative humidity: 30 - 40 %

Radio Technology	Channel	Ressource Blocks / Subcarrier	Bandwidth [MHz]	Nominal BW [MHz]	26 dB BW [kHz]	99 % BW [kHz]
GSM 1900	low	-	0.2	0.2	312.63	242.48
GSM 1900	mid	-	0.2	0.2	316.63	246.49
GSM 1900	high	-	0.2	0.2	314.63	246.49
GSM 1900 EDGE	low	-	0.2	0.2	290.58	234.47
GSM 1900 EDGE	mid	-	0.2	0.2	282.57	236.47
GSM 1900 EDGE	high	-	0.2	0.2	300.60	232.46
CAT-M1 eFDD 2 QPSK	low	6	1.4	1.4	-	1106.21
CAT-M1 eFDD 2 QPSK	mid	6	1.4	1.4	-	1100.20
CAT-M1 eFDD 2 QPSK	high	6	1.4	1.4	-	1094.19
CAT-M1 eFDD 2 16QAM	low	5	1.4	1.4	-	937.88
CAT-M1 eFDD 2 16QAM	mid	5	1.4	1.4	-	937.88
CAT-M1 eFDD 2 16QAM	high	5	1.4	1.4	-	937.88
CAT-M1 eFDD 25 QPSK	low	6	1.4	1.4	-	1100.20
CAT-M1 eFDD 25 QPSK	mid	6	1.4	1.4	-	1106.21
CAT-M1 eFDD 25 QPSK	high	6	1.4	1.4	-	1100.20
CAT-M1 eFDD 25 16QAM	low	5	1.4	1.4	-	931.86
CAT-M1 eFDD 25 16QAM	mid	5	1.4	1.4	-	937.88
CAT-M1 eFDD 25 16QAM	high	5	1.4	1.4	-	931.86
NB-IoT eFDD 2 QPSK	low	12	0.2	0.2	-	186.37
NB-IoT eFDD 2 QPSK	mid	12	0.2	0.2	-	188.38
NB-IoT eFDD 2 QPSK	high	12	0.2	0.2	-	184.37
NB-IoT eFDD 2 BPSK	low	1	0.2	0.2	-	134.27
NB-IoT eFDD 2 BPSK	mid	1	0.2	0.2	-	132.26
NB-IoT eFDD 2 BPSK	high	1	0.2	0.2	-	132.26

Remark: Please see next sub-clause for the measurement plot.



### 5.12.4 MEASUREMENT PLOT

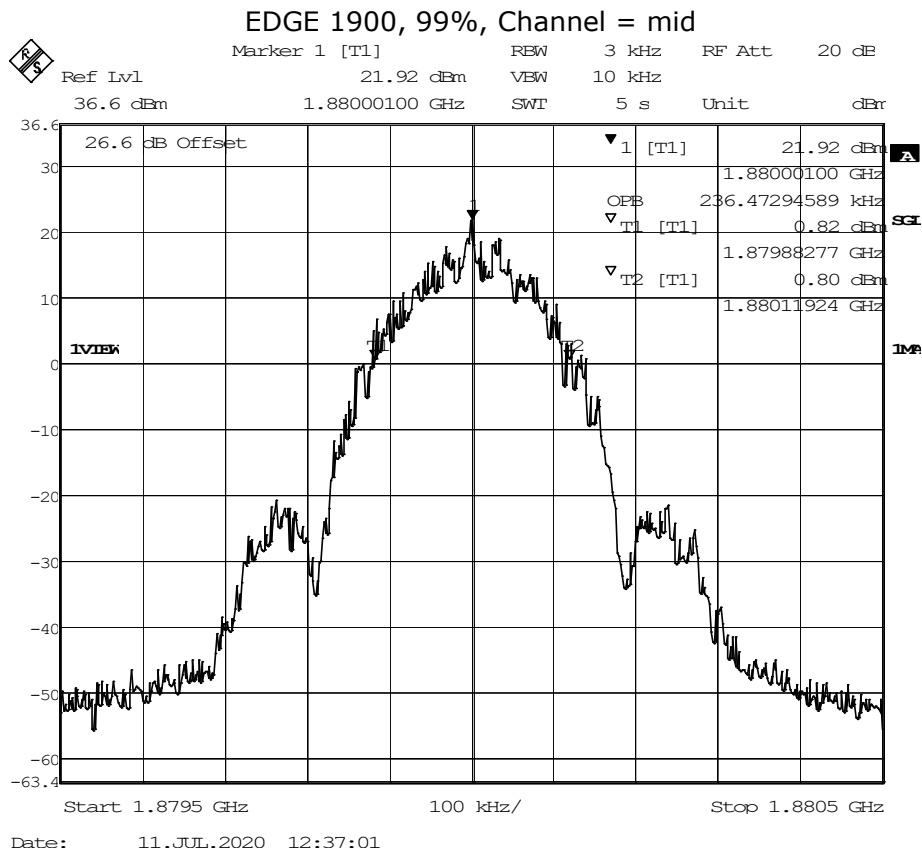
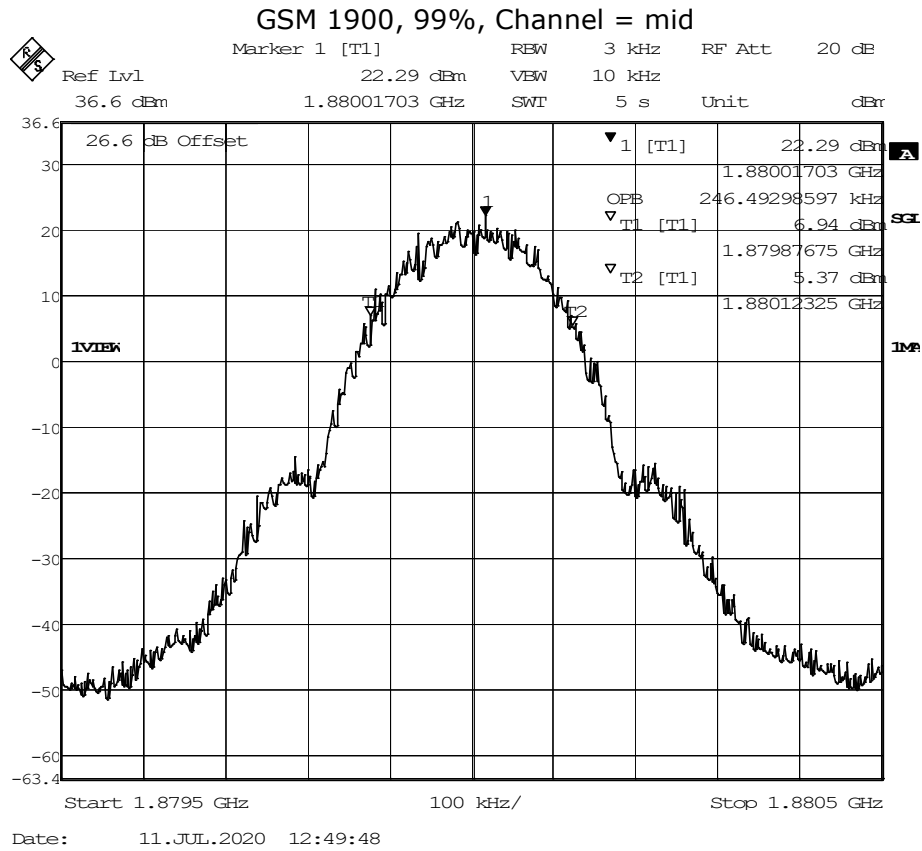

### CAT-M1 eFDD2 QPSK, Channel = mid

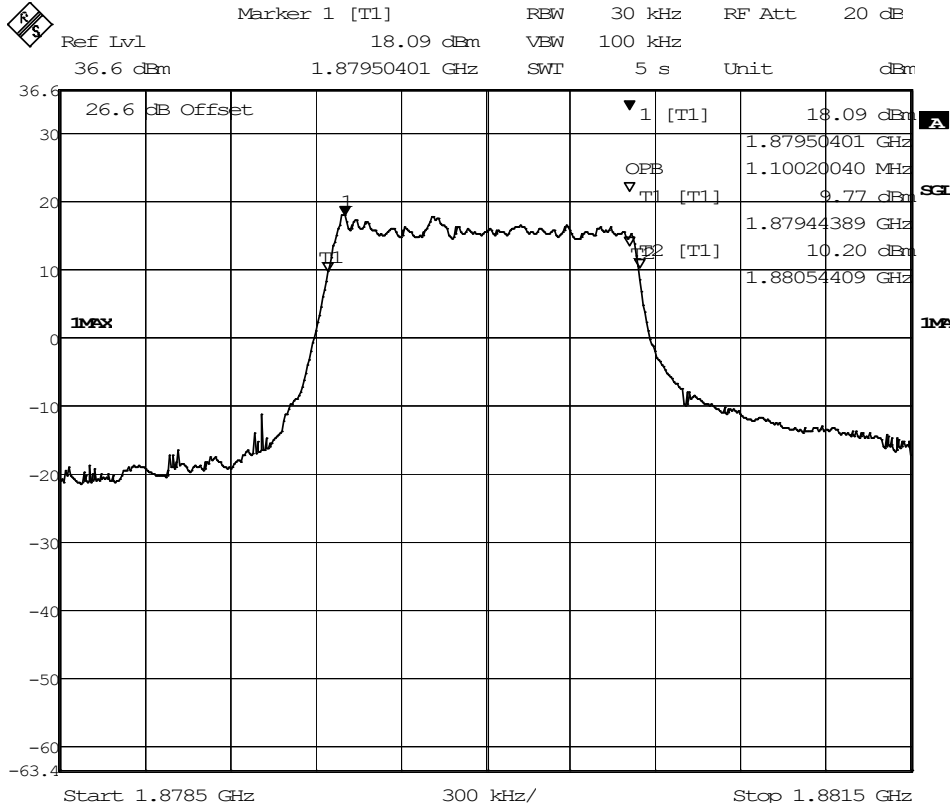

Date: 10.JUN.2020 09:46:40

### CAT-M1 eFDD25 QPSK, Channel = mid

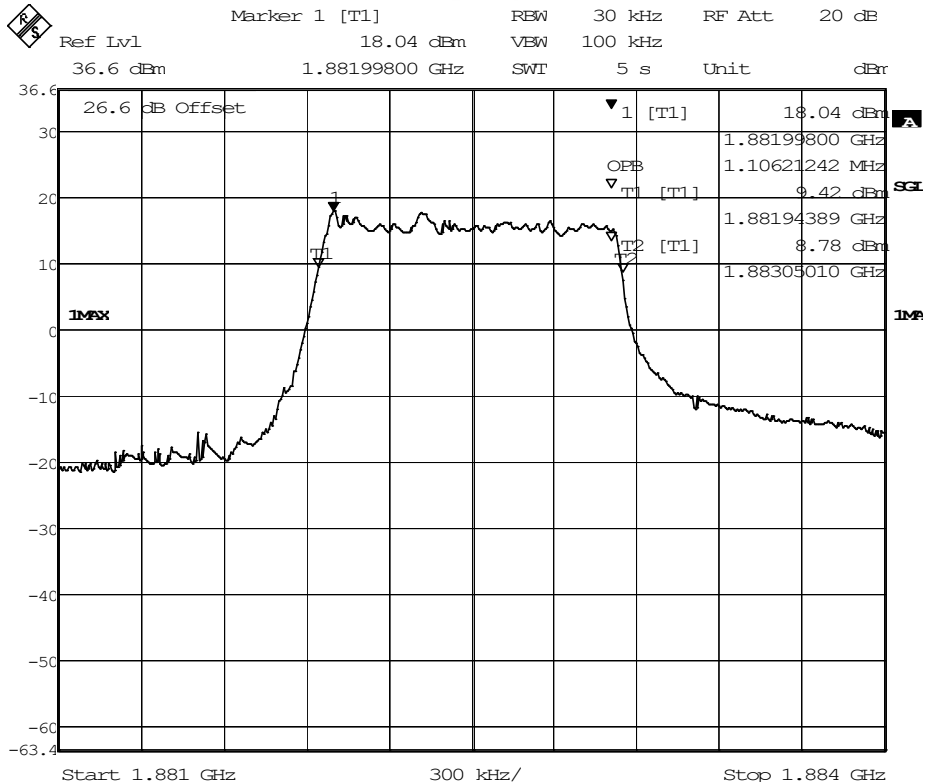

Date: 10.JUN.2020 11:52:41

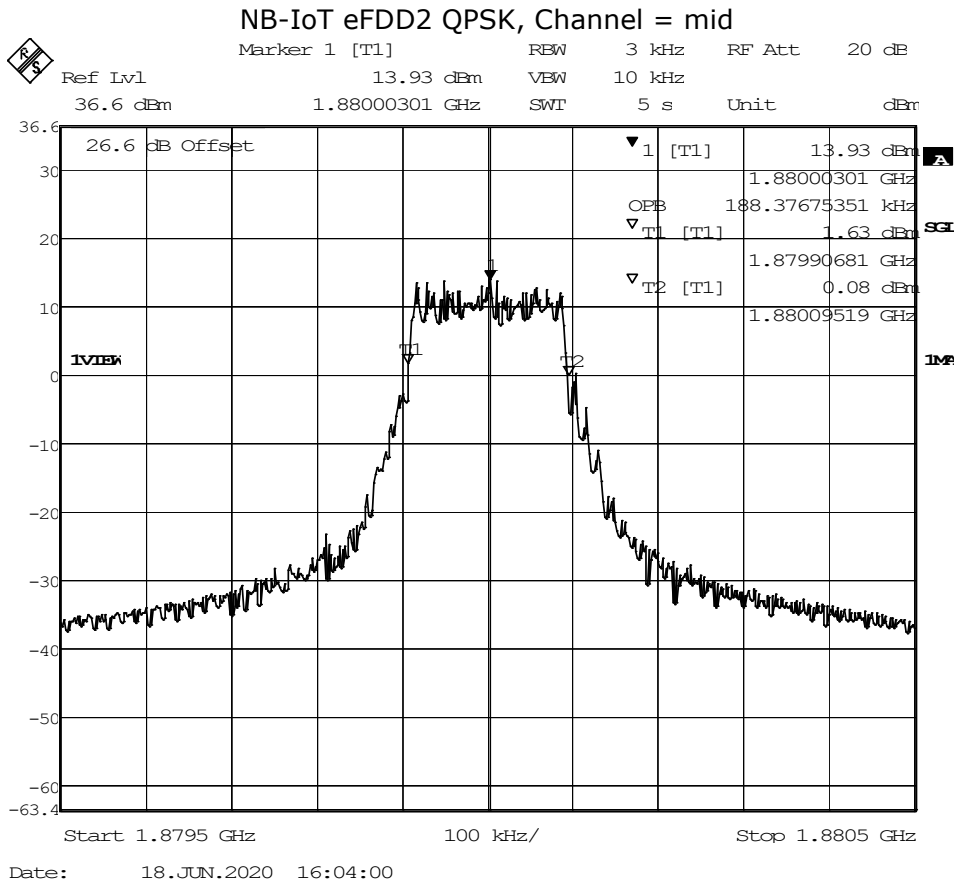

### 5.12.5 TEST EQUIPMENT USED

- Radio Lab

## 5.13 BAND EDGE COMPLIANCE

Standard **FCC PART 24 Subpart E**

**The test was performed according to:**  
ANSI C63.26: 2015

### 5.13.1 TEST DESCRIPTION

This test case is intended to demonstrate compliance to the applicable conducted spurious emission test case per § 2.1051 and RSS-GEN 6.13. The limit comes from the applicable rule part and ISSED RSS-Standard for the operating band of the cellular device.

The EUT was connected to the test setup according to the following diagram:

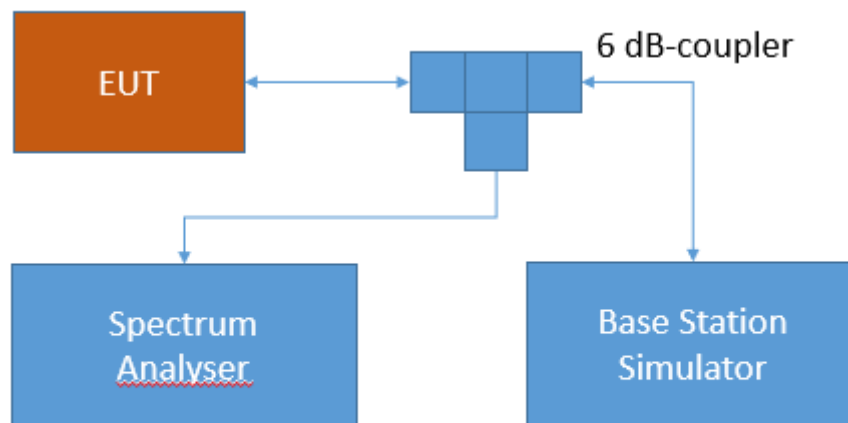

Test Setup FCC Part 22/24/27/90 Cellular;  
Band edge compliance

The attenuation of the measuring and stimulus path are known for each measured frequency and are considered.

The Spectrum Analyzer settings can be directly found in the measurement diagrams.

### 5.13.2 TEST REQUIREMENTS / LIMITS

#### **FCC Part 2.1051; Measurement required: Spurious emissions at antenna terminal:**

The radio frequency voltage or powers generated within the equipment and appearing on a spurious frequency shall be checked at the equipment output terminals when properly loaded with a suitable artificial antenna. Curves or equivalent data shall show the magnitude of each harmonic and other spurious emission that can be detected when the equipment is operated under the conditions specified in §2.1049 as appropriate. The magnitude of spurious emissions which are attenuated more than 20 dB below the permissible value need not be specified.

## Part 24, Subpart E – Broadband PCS

### §24.238 – Emission limitations for Broadband PCS equipment

- a) Out of band emissions. The power of any emission outside of the authorized operating frequency ranges must be attenuated below the transmitting power (P) by a factor of at least  $43 + 10 \log(P)$  dB.
- b) Measurement procedure. Compliance with these rules is based on the use of measurement instrumentation employing a resolution bandwidth of 1 MHz or greater. However, in the 1 MHz bands immediately outside and adjacent to the frequency block a resolution bandwidth of at least one percent of the emission bandwidth of the fundamental emission of the transmitter may be employed. A narrower resolution bandwidth is permitted in all cases to improve measurement accuracy provided the measured power is integrated over the full required measurement bandwidth (i.e. 1 MHz or 1 percent of emission bandwidth, as specified). The emission bandwidth is defined as the width of the signal between two points, one below the carrier center frequency and one above the carrier center frequency, outside of which all emissions are attenuated at least 26 dB below the transmitter power.

### RSS-133; 6.5 Transmitter Unwanted Emissions

Mobile and base station equipment shall comply with the limits in (1) and (2) below.

1. In the 1.0 MHz bands immediately outside and adjacent to the equipment's operating frequency block, the emission power per any 1% of the emission bandwidth shall be attenuated (in dB) below the transmitter output power P (dBW) by at least  $43 + 10 \log_{10}P$  (watts).
2. After the first 1.0 MHz, the emission power in any 1 MHz bandwidth shall be attenuated (in dB) below the transmitter output power P (dBW) by at least  $43 + 10 \log_{10}P$  (watts). If the measurement is performed using 1% of the emission bandwidth, power integration over 1.0 MHz is required.

### 5.13.3 TEST PROTOCOL

Ambient temperature: 20 - 25 °C  
 Relative humidity: 30 - 40 %

Radio Technology	Channel	Ressource Blocks / Subcarrier	Bandwidth [MHz]	Peak [dBm]	Average [dBm]	RMS [dBm]	Limit /dBm	Margin to Limit /dB
GSM 1900	low	-	0.2	-15.14	-39.88	-30.34	-13	17.34
GSM 1900	high	-	0.2	-19.97	-39.88	-31.36	-13	18.36
GSM 1900 EDGE	low	-	0.2	-28.07	-49.42	-36.04	-13	23.04
GSM 1900 EDGE	high	-	0.2	-27.92	-49.42	-39.88	-13	26.88
CAT-M1 eFDD 2 QPSK	low	6	1.4	-16.5	-29.14	-27.37	-13	14.37
CAT-M1 eFDD 2 QPSK	high	6	1.4	-13.96	-30.34	-27.6	-13	14.6
CAT-M1 eFDD 2 16QAM	low	5	1.4	-11.92	-28.34	-26.1	-13	13.1
CAT-M1 eFDD 2 16QAM	high	5	1.4	-19.14	-30.67	-28.6	-13	15.6
CAT-M1 eFDD 25 QPSK	low	6	1.4	-17.03	-28.86	-27.6	-13	14.6
CAT-M1 eFDD 25 QPSK	high	6	1.4	-16.6	-30.34	-28.6	-13	15.6
CAT-M1 eFDD 25 16QAM	low	5	1.4	-17.7	-27.6	-26.71	-13	13.71
CAT-M1 eFDD 25 16QAM	high	5	1.4	-18.54	-34.88	-32.12	-13	19.12
NB-IoT eFDD 2 QPSK	low	12	0.2	-9.24	-30.67	-21.35	-13	8.35
NB-IoT eFDD 2 QPSK	high	12	0.2	-3.66	-24.81	-16.75	-13	3.75
NB-IoT eFDD 2 BPSK	low	1	0.2	-8.39	-16.36	-13.39	-13	0.39
NB-IoT eFDD 2 BPSK	low	1	0.2	-28.77	-34.88	-36.04	-13	23.04

Remark: Please see next sub-clause for the measurement plot.

### 5.13.4 MEASUREMENT PLOT

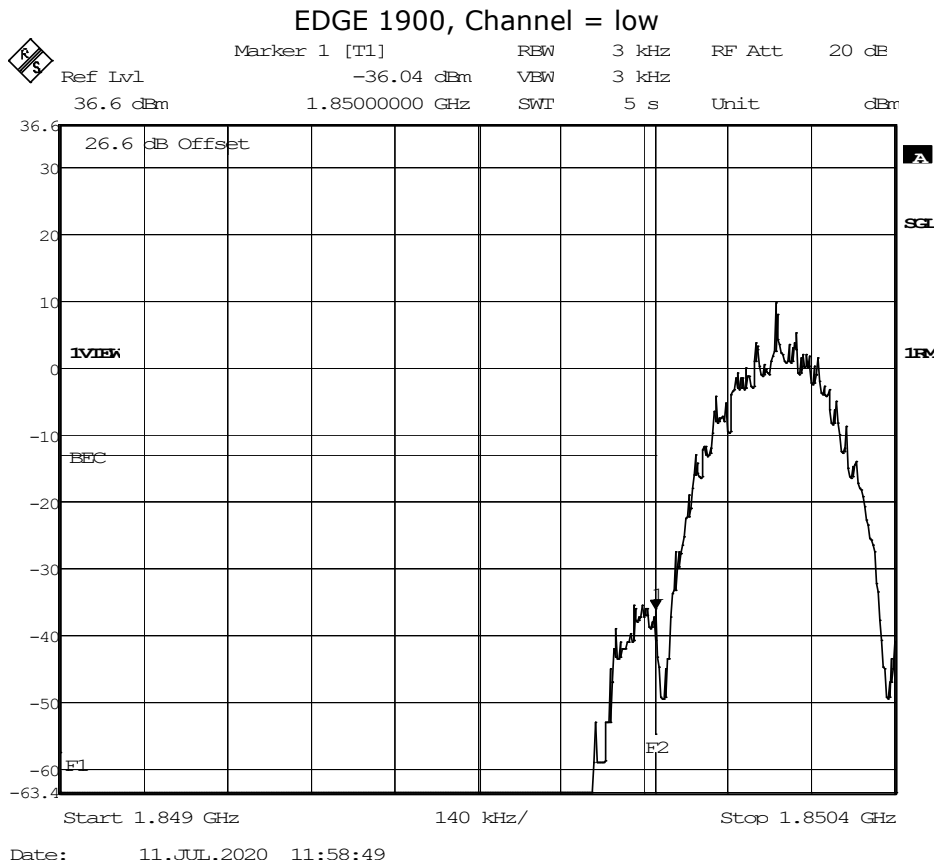
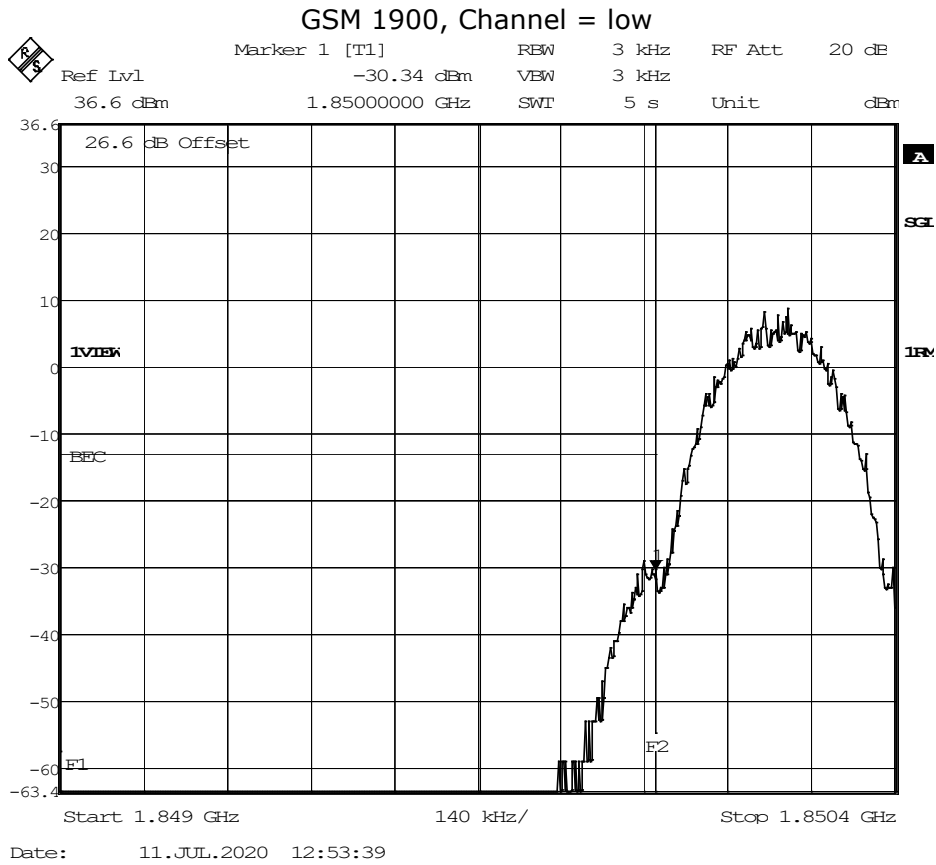

### CAT-M1 eFDD2 16QAM, Channel = low

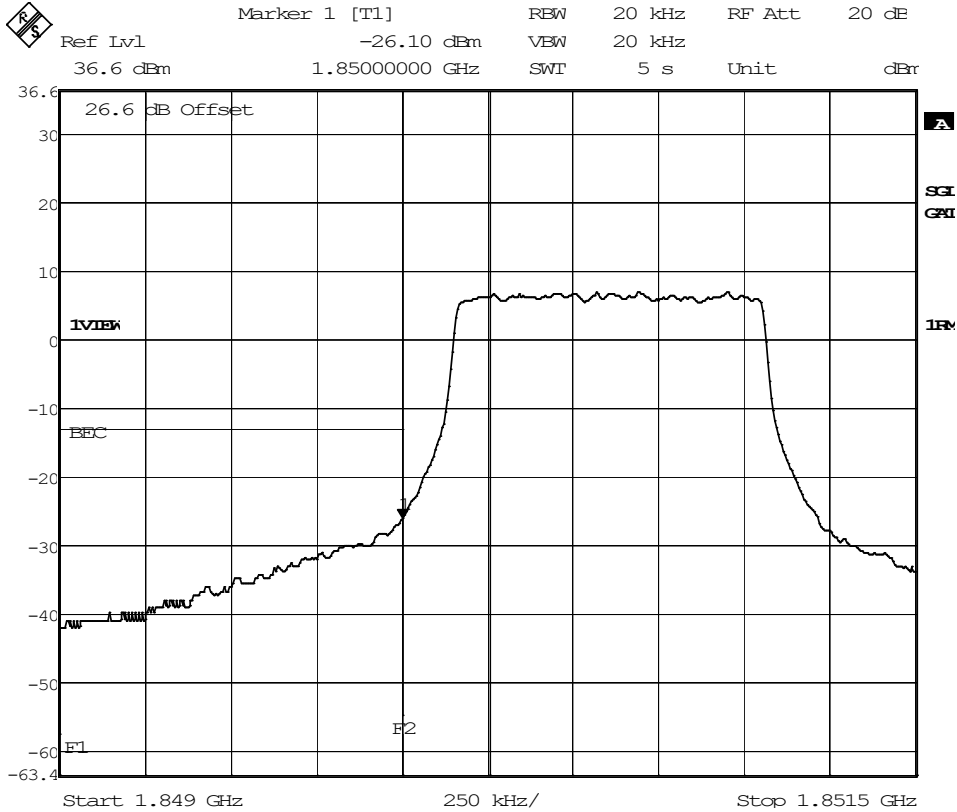

Date: 10.JUN.2020 13:36:27

### CAT-M1 eFDD25 16QAM, Channel = low

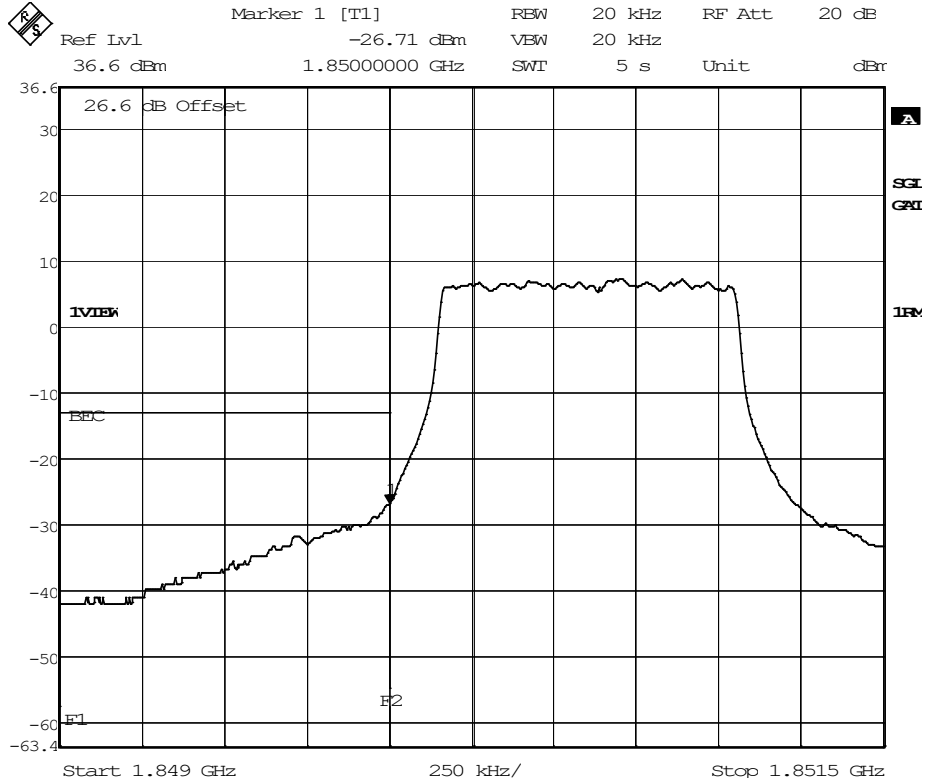

Date: 10.JUN.2020 12:38:05



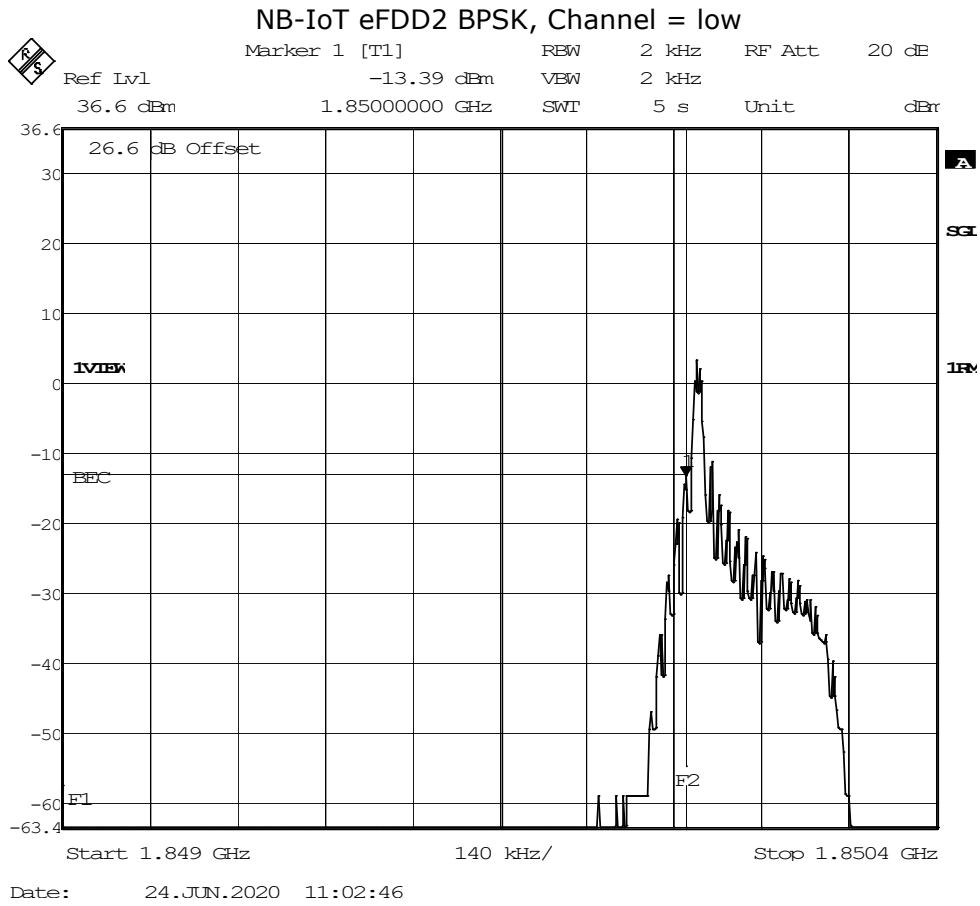

### 5.13.5 TEST EQUIPMENT USED

- Radio Lab

## 5.14 PEAK TO AVERAGE RATIO

Standard **FCC PART 24 Subpart E**

**The test was performed according to:**  
ANSI C63.26: 2015

### 5.14.1 TEST DESCRIPTION

This test case is intended to demonstrate compliance of the EUT to the peak-to-average limits and requirements of the applicable rule part and ISED RSS-Standard for the operating band of the cellular device.

The EUT was connected to the test setup according to the following diagram:

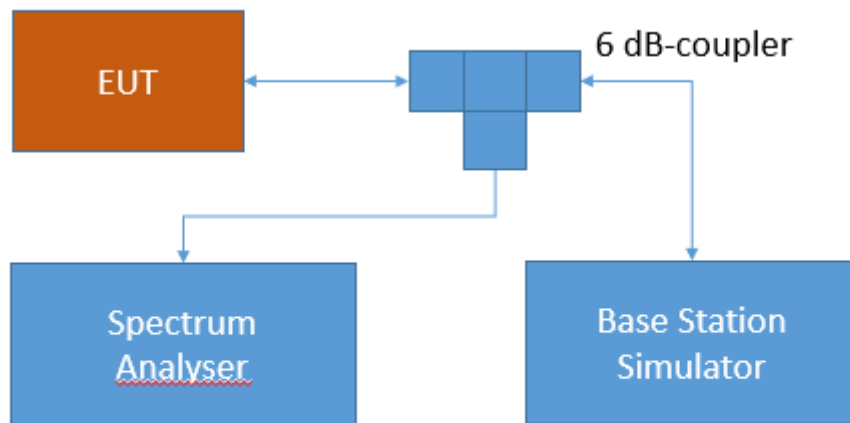

Test Setup FCC Part 22/24/27/90 Cellular;  
Peak-average ratio

The attenuation of the measuring and stimulus path are known for each measured frequency and are considered.

The Spectrum Analyser settings can be directly found in the measurement diagrams. The internal CCDF (complementary cumulative distribution function) of the spectrum analyser is used for this measurement

### 5.14.2 TEST REQUIREMENTS / LIMITS

#### **FCC Part 24, § 24.232**

(d) Power measurements for transmissions by stations authorized under this section may be made either in accordance with a Commission-approved average power technique or in compliance with paragraph (e) of this section. In both instances, equipment employed must be authorized in accordance with the provisions of §24.51. In measuring transmissions in this

band using an average power technique, the peak-to-average ratio (PAR) of the transmission may not exceed 13 dB.

### **RSS-133; 6.4 Transmitter Output Power and Equivalent Isotropically Radiated Power**

In addition, the peak-to-average power ratio (PAPR) of the transmitter shall not exceed 13 dB for more than 0.1% of the time using a signal corresponding to the highest PAPR during periods of continuous transmission.

#### 5.14.3 TEST PROTOCOL

Ambient temperature: 20 - 25 °C  
Relative humidity: 30 - 40 %

Radio Technology	Channel	Ressource Blocks / Subcarrier	Bandwidth [MHz]	Peak to Average Ratio	Limit (IC) [dB]
GSM 1900	low	-	0.2	0.52	13
GSM 1900	mid	-	0.2	0.50	13
GSM 1900	high	-	0.2	0.46	13
GSM 1900 EDGE	low	-	0.2	2.61	13
GSM 1900 EDGE	mid	-	0.2	2.68	13
GSM 1900 EDGE	high	-	0.2	2.92	13
CAT-M1 eFDD 2 QPSK	low	6	1.4	10.38	13
CAT-M1 eFDD 2 QPSK	mid	6	1.4	10.35	13
CAT-M1 eFDD 2 QPSK	high	6	1.4	10.38	13
CAT-M1 eFDD 2 16QAM	low	5	1.4	11.13	13
CAT-M1 eFDD 2 16QAM	mid	5	1.4	11.16	13
CAT-M1 eFDD 2 16QAM	high	5	1.4	11.1	13
CAT-M1 eFDD 25 QPSK	low	6	1.4	10.38	13
CAT-M1 eFDD 25 QPSK	mid	6	1.4	10.35	13
CAT-M1 eFDD 25 QPSK	high	6	1.4	10.32	13
CAT-M1 eFDD 25 16QAM	low	5	1.4	11.13	13
CAT-M1 eFDD 25 16QAM	mid	5	1.4	11.16	13
CAT-M1 eFDD 25 16QAM	high	5	1.4	11.04	13
NB-IoT eFDD 2 QPSK	low	12	0.2	10.29	13
NB-IoT eFDD 2 QPSK	mid	12	0.2	10.23	13
NB-IoT eFDD 2 QPSK	high	12	0.2	9.97	13
NB-IoT eFDD 2 BPSK	low	1	0.2	3.13	13
NB-IoT eFDD 2 BPSK	mid	1	0.2	3.13	13
NB-IoT eFDD 2 BPSK	high	1	0.2	3.13	13

Remark: Please see next sub-clause for the measurement plot.

### 5.14.4 MEASUREMENT PLOT

CAT-M1 eFDD2 16QAM, Channel = mid

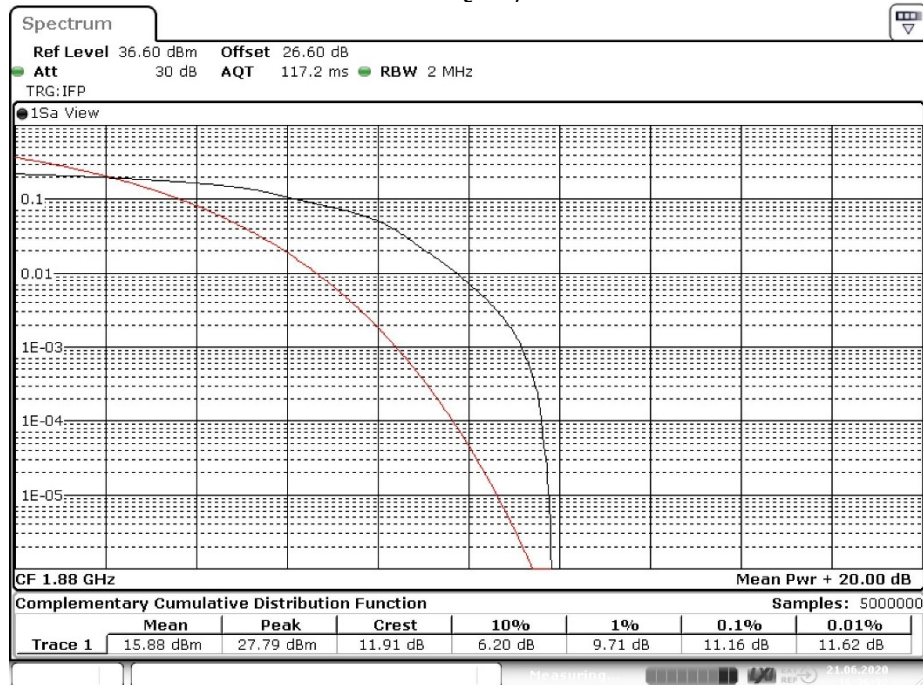

Date: 21.JUN.2020 16:36:33

CAT-M1 eFDD25 16QAM, Channel = mid

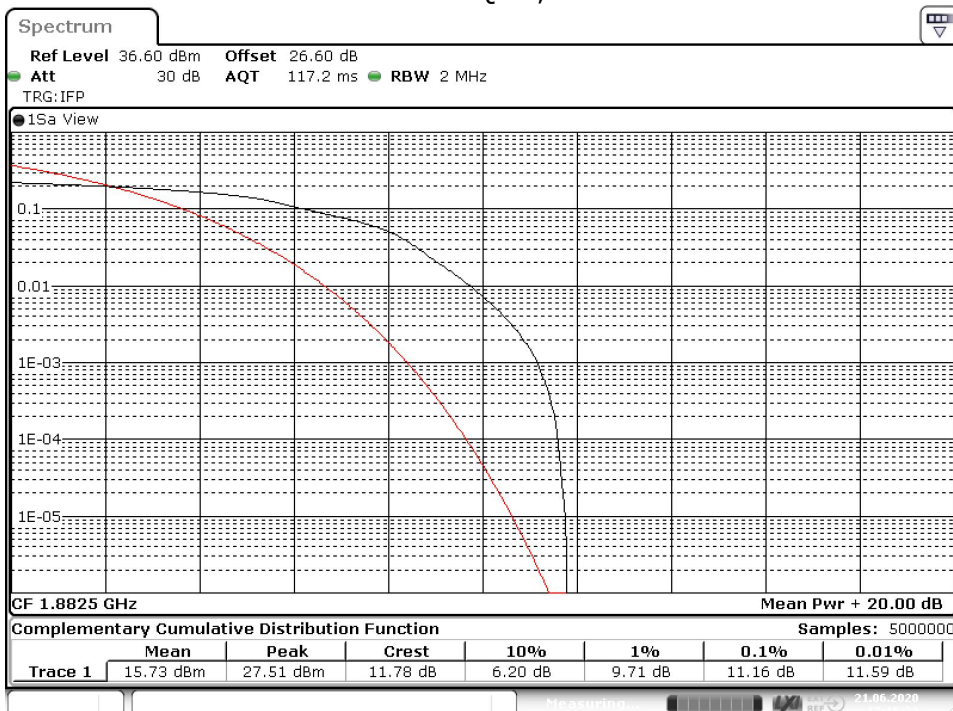

Date: 21.JUN.2020 17:16:33

NB-IoT eFDD2 QPSK, Channel = low

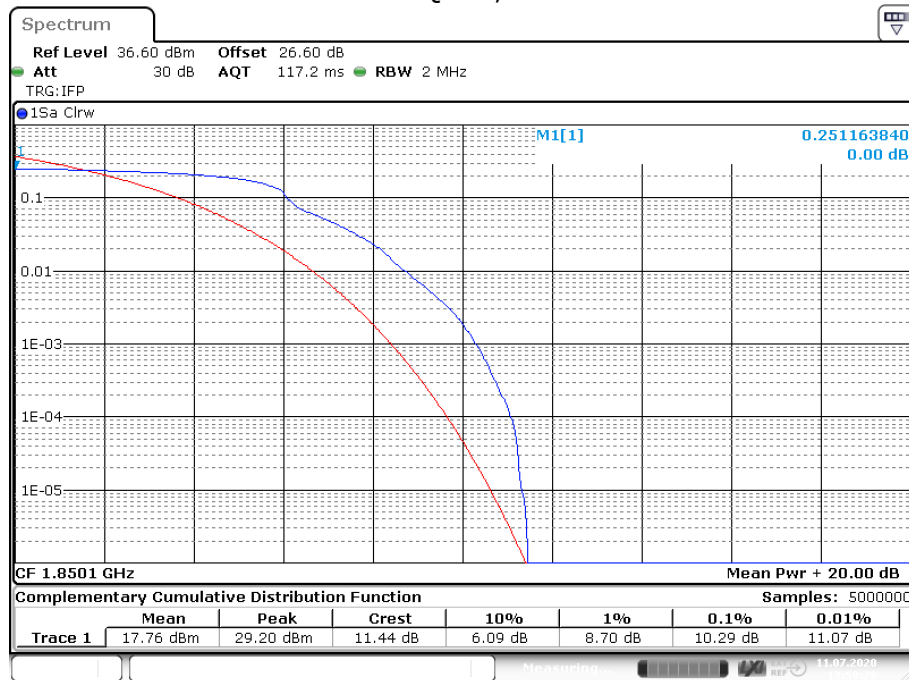

Date: 11.JUL.2020 13:59:28

### 5.14.5 TEST EQUIPMENT USED

- Radio Lab

## 5.15 RF OUTPUT POWER

Standard **FCC PART 27 Subpart C**

**The test was performed according to:**  
ANSI C63.26: 2015

### 5.15.1 TEST DESCRIPTION

This test case is intended to demonstrate compliance to the applicable RF Output power test case per § 2.1046 and RSS-GEN 6.12. The limit and the requirements come from the applicable rule part and ISED RSS-Standard for the operating band of the cellular device.

The EUT was connected to the test setup according to the following diagram:

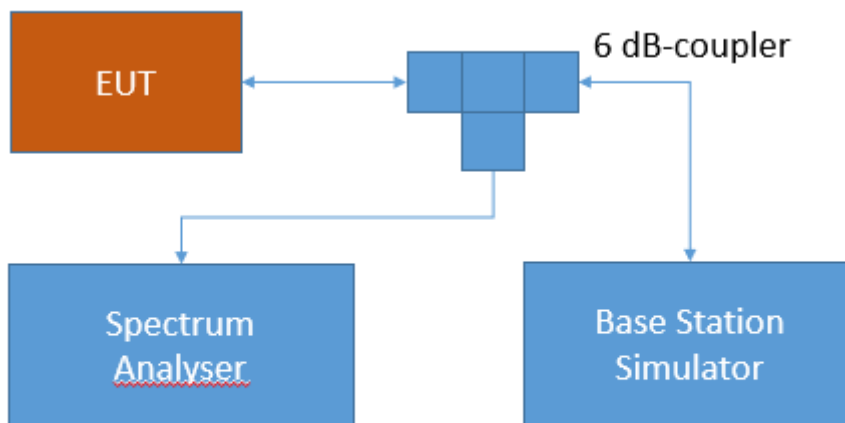

Test Setup FCC Part 22/24/27/90 Cellular;  
RF Output power

The attenuation of the measuring and stimulus path are known for each measured frequency and are considered.

The Spectrum Analyser settings can be directly found in the measurement diagrams.

### 5.15.2 TEST REQUIREMENTS / LIMITS

**FCC Part 27; Miscellaneous Wireless Communication Services**

**Subpart C – Technical standards**

**§ 27.50 - Power limits and duty cycle**

**Band 13:**

(b) The following power limits apply to transmitters operating in the 746-758 MHz, 775-788 MHz and 805-806 MHz bands:

(10) Portable stations (hand-held devices) transmitting in the 746-757 MHz, 776-788 MHz, and 805-806 MHz bands are limited to 3 watts ERP.

**RSS-130; 4.6.3 Transmitter Output Power**

The e.r.p. shall not exceed 3 watts for portable equipment and indoor fixed subscriber equipment.

**Band 12:**

(c) The following power and antenna height requirements apply to stations transmitting in the 600 MHz band and the 698-746 MHz band:

(10) Portable stations (hand-held devices) in the 600 MHz uplink band and the 698-746 MHz band, and fixed and mobile stations in the 600 MHz uplink band are limited to 3 watts ERP.

**RSS-130; 4.6.3 Transmitter Output Power**

The e.r.p. shall not exceed 3 watts for portable equipment and indoor fixed subscriber equipment.

**Band 4/10/66:**

(d) The following power and antenna height requirements apply to stations transmitting in the 1695-1710 MHz, 1710-1755 MHz, 1755-1780 MHz, 1915-1920 MHz, 1995-2000 MHz, 2000-2020 MHz, 2110-2155 MHz, 2155-2180 MHz and 2180-2200 MHz bands:

(4) Fixed, mobile, and portable (hand-held) stations operating in the 1710-1755 MHz band and mobile and portable stations operating in the 1695-1710 MHz and 1755-1780 MHz bands are limited to 1 watt EIRP. Fixed stations operating in the 1710-1755 MHz band are limited to a maximum antenna height of 10 meters above ground. Mobile and portable stations operating in these bands must employ a means for limiting power to the minimum.

**RSS-139; 6.5 Transmitter Output Power**

The equivalent isotropically radiated power (e.i.r.p.) for mobile and portable transmitters shall not exceed one watt.

**Band 17:**

(c) The following power requirements apply to stations transmitting in the 600 MHz band and the 698-746 MHz band:

(10) Portable stations (hand-held devices) in the 600 MHz uplink band and the 698-746 MHz band, and fixed and mobile stations in the 600 MHz uplink band are limited to 3 watts ERP.

**RSS-130; 4.6.3 Transmitter Output**

The e.r.p. shall not exceed 3 watts for portable equipment and indoor fixed subscriber equipment.

**Band 7:**

(h) The following power limits shall apply in the BRS and EBS:

(2) Mobile and other user stations. Mobile stations are limited to 2.0 watts EIRP. All user stations are limited to 2.0 watts transmitter output power.

**RSS-199; 4.4 Transmitter output power and equivalent isotropically power (e.i.r.p.)**

The transmitter output power shall be measured in terms of average value.

For mobile subscriber equipment, the e.i.r.p. shall not exceed 2 W. For fixed subscriber equipment, the transmitter output power shall not exceed 2 W and the e.i.r.p. shall be limited to 40 W.

For equipment with multiple antennas, the transmitter output power and e.i.r.p shall be measured according to ANSI C63.26-2015.

### Band 71 / 85:

(10) Portable stations (hand-held devices) in the 600 MHz uplink band and the 698-746 MHz band, and fixed and mobile stations in the 600 MHz uplink band are limited to 3 watts ERP.

### Subpart P

### §27.1507 Effective radiated power limits for 900 MHz broadband systems

#### Band 8:

(4) *Portable stations.* Portable stations must not exceed 3 watts ERP.

Ambient temperature: 20 - 25 °C  
Relative humidity: 30 - 40 %

Radio Technology	Channel	Resource Blocks / Subcarrier	Bandwidth [MHz]	RMS Cond. Power (dBm)	FCC ERP / EIRP Limit (W)	IC ERP / EIRP Limit (W)	Max. Antenna Gain FCC (dBi)	Max. Antenna Gain IC (dBi)
CAT-M1 eFDD 4 QPSK	low	1	1.4	22.86	1	1	7.14	7.14
CAT-M1 eFDD 4 QPSK	low	3	1.4	21.73	1	1	8.27	8.27
CAT-M1 eFDD 4 QPSK	low	6	1.4	20.69	1	1	9.31	9.31
CAT-M1 eFDD 4 QPSK	mid	1	1.4	22.71	1	1	7.29	7.29
CAT-M1 eFDD 4 QPSK	mid	3	1.4	21.83	1	1	8.17	8.17
CAT-M1 eFDD 4 QPSK	mid	6	1.4	20.76	1	1	9.24	9.24
CAT-M1 eFDD 4 QPSK	high	1	1.4	22.72	1	1	7.28	7.28
CAT-M1 eFDD 4 QPSK	high	3	1.4	21.78	1	1	8.22	8.22
CAT-M1 eFDD 4 QPSK	high	6	1.4	20.74	1	1	9.26	9.26
CAT-M1 eFDD 4 16QAM	low	1	1.4	22.05	1	1	7.95	7.95
CAT-M1 eFDD 4 16QAM	low	5	1.4	20.23	1	1	9.77	9.77
CAT-M1 eFDD 4 16QAM	mid	1	1.4	21.99	1	1	8.01	8.01
CAT-M1 eFDD 4 16QAM	mid	5	1.4	20.74	1	1	9.26	9.26
CAT-M1 eFDD 4 16QAM	high	1	1.4	22.09	1	1	7.91	7.91
CAT-M1 eFDD 4 16QAM	high	5	1.4	20.25	1	1	9.75	9.75
CAT-M1 eFDD 4 QPSK	low	1	3	22.86	1	1	7.14	7.14
CAT-M1 eFDD 4 QPSK	low	3	3	21.73	1	1	8.27	8.27
CAT-M1 eFDD 4 QPSK	low	6	3	20.69	1	1	9.31	9.31
CAT-M1 eFDD 4 QPSK	mid	1	3	22.79	1	1	7.21	7.21
CAT-M1 eFDD 4 QPSK	mid	3	3	21.78	1	1	8.22	8.22
CAT-M1 eFDD 4 QPSK	mid	6	3	20.85	1	1	9.15	9.15
CAT-M1 eFDD 4 QPSK	high	1	3	22.62	1	1	7.38	7.38
CAT-M1 eFDD 4 QPSK	high	3	3	21.69	1	1	8.31	8.31
CAT-M1 eFDD 4 QPSK	high	6	3	20.74	1	1	9.26	9.26
CAT-M1 eFDD 4 16QAM	low	1	3	22.05	1	1	7.95	7.95
CAT-M1 eFDD 4 16QAM	low	5	3	20.23	1	1	9.77	9.77
CAT-M1 eFDD 4 16QAM	mid	1	3	21.86	1	1	8.14	8.14
CAT-M1 eFDD 4 16QAM	mid	5	3	20.80	1	1	9.20	9.20
CAT-M1 eFDD 4 16QAM	high	1	3	21.94	1	1	8.06	8.06
CAT-M1 eFDD 4 16QAM	high	5	3	20.73	1	1	9.27	9.27
CAT-M1 eFDD 4 QPSK	low	1	5	22.47	1	1	7.53	7.53
CAT-M1 eFDD 4 QPSK	low	3	5	21.53	1	1	8.47	8.47
CAT-M1 eFDD 4 QPSK	low	6	5	21.67	1	1	8.33	8.33
CAT-M1 eFDD 4 QPSK	mid	1	5	22.65	1	1	7.35	7.35
CAT-M1 eFDD 4 QPSK	mid	3	5	21.69	1	1	8.31	8.31
CAT-M1 eFDD 4 QPSK	mid	6	5	21.77	1	1	8.23	8.23
CAT-M1 eFDD 4 QPSK	high	1	5	22.73	1	1	7.27	7.27



CAT-M1 eFDD 4 QPSK	high	3	5	21.66	1	1	8.34	8.34
CAT-M1 eFDD 4 QPSK	high	6	5	21.70	1	1	8.30	8.30
CAT-M1 eFDD 4 16QAM	low	1	5	22.79	1	1	7.21	7.21
CAT-M1 eFDD 4 16QAM	low	5	5	21.62	1	1	8.38	8.38
CAT-M1 eFDD 4 16QAM	mid	1	5	22.84	1	1	7.16	7.16
CAT-M1 eFDD 4 16QAM	mid	5	5	20.82	1	1	9.18	9.18
CAT-M1 eFDD 4 16QAM	high	1	5	22.23	1	1	7.77	7.77
CAT-M1 eFDD 4 16QAM	high	5	5	21.70	1	1	8.30	8.30
CAT-M1 eFDD 4 QPSK	low	1	10	22.51	1	1	7.49	7.49
CAT-M1 eFDD 4 QPSK	low	3	10	22.62	1	1	7.38	7.38
CAT-M1 eFDD 4 QPSK	low	6	10	21.65	1	1	8.35	8.35
CAT-M1 eFDD 4 QPSK	mid	1	10	22.79	1	1	7.21	7.21
CAT-M1 eFDD 4 QPSK	mid	3	10	21.77	1	1	8.23	8.23
CAT-M1 eFDD 4 QPSK	mid	6	10	20.81	1	1	9.19	9.19
CAT-M1 eFDD 4 QPSK	high	1	10	22.63	1	1	7.37	7.37
CAT-M1 eFDD 4 QPSK	high	3	10	22.55	1	1	7.45	7.45
CAT-M1 eFDD 4 QPSK	high	6	10	21.71	1	1	8.29	8.29
CAT-M1 eFDD 4 16QAM	low	1	10	22.89	1	1	7.11	7.11
CAT-M1 eFDD 4 16QAM	low	5	10	21.56	1	1	8.44	8.44
CAT-M1 eFDD 4 16QAM	mid	1	10	21.71	1	1	8.29	8.29
CAT-M1 eFDD 4 16QAM	mid	5	10	20.80	1	1	9.20	9.20
CAT-M1 eFDD 4 16QAM	high	1	10	22.43	1	1	7.57	7.57
CAT-M1 eFDD 4 16QAM	high	5	10	21.65	1	1	8.35	8.35
CAT-M1 eFDD 8 QPSK	low	1	1.4	21.37	3	3	8.63	8.63
CAT-M1 eFDD 8 QPSK	low	3	1.4	20.27	3	3	9.73	9.73
CAT-M1 eFDD 8 QPSK	low	6	1.4	19.12	3	3	10.88	10.88
CAT-M1 eFDD 8 QPSK	mid	1	1.4	21.26	3	3	8.74	8.74
CAT-M1 eFDD 8 QPSK	mid	3	1.4	20.35	3	3	9.65	9.65
CAT-M1 eFDD 8 QPSK	mid	6	1.4	19.08	3	3	10.92	10.92
CAT-M1 eFDD 8 QPSK	high	1	1.4	21.31	3	3	8.69	8.69
CAT-M1 eFDD 8 QPSK	high	3	1.4	20.23	3	3	9.77	9.77
CAT-M1 eFDD 8 QPSK	high	6	1.4	19.13	3	3	10.87	10.87
CAT-M1 eFDD 8 16QAM	low	1	1.4	20.3	3	3	9.7	9.7
CAT-M1 eFDD 8 16QAM	low	5	1.4	19.05	3	3	10.95	10.95
CAT-M1 eFDD 8 16QAM	mid	1	1.4	19.6	3	3	10.4	10.4
CAT-M1 eFDD 8 16QAM	mid	5	1.4	19.2	3	3	10.8	10.8
CAT-M1 eFDD 8 16QAM	high	1	1.4	20.09	3	3	9.91	9.91
CAT-M1 eFDD 8 16QAM	high	5	1.4	19.24	3	3	10.76	10.76
CAT-M1 eFDD 8 QPSK	mid	1	3	21.8	3	3	8.2	8.2
CAT-M1 eFDD 8 QPSK	mid	3	3	20.71	3	3	9.29	9.29
CAT-M1 eFDD 8 QPSK	mid	6	3	19.61	3	3	10.39	10.39
CAT-M1 eFDD 8 16QAM	mid	1	3	20.63	3	3	9.37	9.37
CAT-M1 eFDD 8 16QAM	mid	5	3	19.7	3	3	10.3	10.3
CAT-M1 eFDD 12 QPSK	low	1	1.4	22.53	3	3	12.24	12.24
CAT-M1 eFDD 12 QPSK	low	3	1.4	21.66	3	3	13.11	13.11
CAT-M1 eFDD 12 QPSK	low	6	1.4	20.44	3	3	14.33	14.33
CAT-M1 eFDD 12 QPSK	mid	1	1.4	22.3	3	3	12.47	12.47
CAT-M1 eFDD 12 QPSK	mid	3	1.4	21.49	3	3	13.28	13.28
CAT-M1 eFDD 12 QPSK	mid	6	1.4	20.17	3	3	14.6	14.6
CAT-M1 eFDD 12 QPSK	high	1	1.4	22.27	3	3	12.5	12.5
CAT-M1 eFDD 12 QPSK	high	3	1.4	21.37	3	3	13.4	13.4
CAT-M1 eFDD 12 QPSK	high	6	1.4	20.12	3	3	14.65	14.65
CAT-M1 eFDD 12 16QAM	low	1	1.4	21.8	3	3	12.97	12.97
CAT-M1 eFDD 12 16QAM	low	5	1.4	20.41	3	3	14.36	14.36
CAT-M1 eFDD 12 16QAM	mid	1	1.4	21.54	3	3	13.23	13.23
CAT-M1 eFDD 12 16QAM	mid	5	1.4	20.2	3	3	14.57	14.57
CAT-M1 eFDD 12 16QAM	high	1	1.4	21.14	3	3	13.63	13.63
CAT-M1 eFDD 12 16QAM	high	5	1.4	20.1	3	3	14.67	14.67
CAT-M1 eFDD 12 QPSK	low	1	3	22.55	3	3	12.22	12.22
CAT-M1 eFDD 12 QPSK	low	3	3	21.48	3	3	13.29	13.29
CAT-M1 eFDD 12 QPSK	low	6	3	20.30	3	3	14.47	14.47
CAT-M1 eFDD 12 QPSK	mid	1	3	22.29	3	3	12.48	12.48
CAT-M1 eFDD 12 QPSK	mid	3	3	21.32	3	3	13.45	13.45
CAT-M1 eFDD 12 QPSK	mid	6	3	20.09	3	3	14.68	14.68
CAT-M1 eFDD 12 QPSK	high	1	3	22.42	3	3	12.35	12.35
CAT-M1 eFDD 12 QPSK	high	3	3	21.39	3	3	13.38	13.38
CAT-M1 eFDD 12 QPSK	high	6	3	20.05	3	3	14.72	14.72
CAT-M1 eFDD 12 16QAM	low	1	3	21.75	3	3	13.02	13.02
CAT-M1 eFDD 12 16QAM	low	5	3	20.33	3	3	14.44	14.44
CAT-M1 eFDD 12 16QAM	mid	1	3	21.51	3	3	13.26	13.26
CAT-M1 eFDD 12 16QAM	mid	5	3	20.10	3	3	14.67	14.67
CAT-M1 eFDD 12 16QAM	high	1	3	21.36	3	3	13.41	13.41
CAT-M1 eFDD 12 16QAM	high	5	3	20.04	3	3	14.73	14.73

CAT-M1 eFDD 12 QPSK	low	1	5	22.48	3	3	12.29	12.29
CAT-M1 eFDD 12 QPSK	low	3	5	21.52	3	3	13.25	13.25
CAT-M1 eFDD 12 QPSK	low	6	5	21.45	3	3	13.32	13.32
CAT-M1 eFDD 12 QPSK	mid	1	5	22.36	3	3	12.41	12.41
CAT-M1 eFDD 12 QPSK	mid	3	5	21.29	3	3	13.48	13.48
CAT-M1 eFDD 12 QPSK	mid	6	5	21.22	3	3	13.55	13.55
CAT-M1 eFDD 12 QPSK	high	1	5	22.32	3	3	12.45	12.45
CAT-M1 eFDD 12 QPSK	high	3	5	21.38	3	3	13.39	13.39
CAT-M1 eFDD 12 QPSK	high	6	5	21.29	3	3	13.48	13.48
CAT-M1 eFDD 12 16QAM	low	1	5	22.78	3	3	11.99	11.99
CAT-M1 eFDD 12 16QAM	low	5	5	21.45	3	3	13.32	13.32
CAT-M1 eFDD 12 16QAM	mid	1	5	22.60	3	3	12.17	12.17
CAT-M1 eFDD 12 16QAM	mid	5	5	20.10	3	3	14.67	14.67
CAT-M1 eFDD 12 16QAM	high	1	5	22.53	3	3	12.24	12.24
CAT-M1 eFDD 12 16QAM	high	5	5	21.39	3	3	13.38	13.38
CAT-M1 eFDD 12 QPSK	low	1	10	22.49	3	3	12.24	12.24
CAT-M1 eFDD 12 QPSK	low	3	10	22.36	3	3	13.11	13.11
CAT-M1 eFDD 12 QPSK	low	6	10	21.37	3	3	14.33	14.33
CAT-M1 eFDD 12 QPSK	mid	1	10	22.36	3	3	12.47	12.47
CAT-M1 eFDD 12 QPSK	mid	3	10	22.36	3	3	13.28	13.28
CAT-M1 eFDD 12 QPSK	mid	6	10	21.31	3	3	14.6	14.6
CAT-M1 eFDD 12 QPSK	high	1	10	22.33	3	3	12.5	12.5
CAT-M1 eFDD 12 QPSK	high	3	10	22.27	3	3	13.4	13.4
CAT-M1 eFDD 12 QPSK	high	6	10	21.28	3	3	14.65	14.65
CAT-M1 eFDD 12 16QAM	low	1	10	22.61	3	3	12.97	12.97
CAT-M1 eFDD 12 16QAM	low	5	10	21.29	3	3	14.36	14.36
CAT-M1 eFDD 12 16QAM	mid	1	10	22.48	3	3	13.23	13.23
CAT-M1 eFDD 12 16QAM	mid	5	10	21.32	3	3	14.57	14.57
CAT-M1 eFDD 12 16QAM	high	1	10	22.25	3	3	13.63	13.63
CAT-M1 eFDD 12 16QAM	high	5	10	21.44	3	3	14.67	14.67
CAT-M1 eFDD 13 QPSK	low	1	5	22.59	3	3	12.22	12.22
CAT-M1 eFDD 13 QPSK	low	3	5	21.64	3	3	13.29	13.29
CAT-M1 eFDD 13 QPSK	low	6	5	21.63	3	3	14.47	14.47
CAT-M1 eFDD 13 QPSK	mid	1	5	22.82	3	3	12.48	12.48
CAT-M1 eFDD 13 QPSK	mid	3	5	21.79	3	3	13.45	13.45
CAT-M1 eFDD 13 QPSK	mid	6	5	21.77	3	3	14.68	14.68
CAT-M1 eFDD 13 QPSK	high	1	5	22.64	3	3	12.35	12.35
CAT-M1 eFDD 13 QPSK	high	3	5	21.67	3	3	13.38	13.38
CAT-M1 eFDD 13 QPSK	high	6	5	21.68	3	3	14.72	14.72
CAT-M1 eFDD 13 16QAM	low	1	5	22.86	3	3	13.02	13.02
CAT-M1 eFDD 13 16QAM	low	5	5	21.62	3	3	14.44	14.44
CAT-M1 eFDD 13 16QAM	mid	1	5	22.99	3	3	13.26	13.26
CAT-M1 eFDD 13 16QAM	mid	5	5	20.78	3	3	14.67	14.67
CAT-M1 eFDD 13 16QAM	high	1	5	22.87	3	3	13.41	13.41
CAT-M1 eFDD 13 16QAM	high	5	5	21.69	3	3	14.73	14.73
CAT-M1 eFDD 13 QPSK	mid	1	10	22.86	3	3	12.29	12.29
CAT-M1 eFDD 13 QPSK	mid	3	10	22.74	3	3	13.25	13.25
CAT-M1 eFDD 13 QPSK	mid	6	10	21.74	3	3	13.32	13.32
CAT-M1 eFDD 13 16QAM	mid	1	10	22.95	3	3	12.41	12.41
CAT-M1 eFDD 13 16QAM	mid	5	10	21.67	3	3	13.48	13.48
CAT-M1 eFDD 66 QPSK	low	1	1.4	22.58	1	1	7.42	7.42
CAT-M1 eFDD 66 QPSK	low	3	1.4	21.51	1	1	8.49	8.49
CAT-M1 eFDD 66 QPSK	low	6	1.4	20.21	1	1	9.79	9.79
CAT-M1 eFDD 66 QPSK	mid	1	1.4	22.67	1	1	7.33	7.33
CAT-M1 eFDD 66 QPSK	mid	3	1.4	21.72	1	1	8.28	8.28
CAT-M1 eFDD 66 QPSK	mid	6	1.4	20.28	1	1	9.72	9.72
CAT-M1 eFDD 66 QPSK	high	1	1.4	22.48	1	1	7.52	7.52
CAT-M1 eFDD 66 QPSK	high	3	1.4	21.31	1	1	8.69	8.69
CAT-M1 eFDD 66 QPSK	high	6	1.4	20.2	1	1	9.8	9.8
CAT-M1 eFDD 66 16QAM	low	1	1.4	20.42	1	1	9.58	9.58
CAT-M1 eFDD 66 16QAM	low	5	1.4	20.48	1	1	9.52	9.52
CAT-M1 eFDD 66 16QAM	mid	1	1.4	20.22	1	1	9.78	9.78
CAT-M1 eFDD 66 16QAM	mid	5	1.4	20.32	1	1	9.68	9.68
CAT-M1 eFDD 66 16QAM	high	1	1.4	20.74	1	1	9.26	9.26
CAT-M1 eFDD 66 QPSK	low	1	3	22.48	1	1	7.52	7.52
CAT-M1 eFDD 66 QPSK	low	3	3	21.64	1	1	8.36	8.36
CAT-M1 eFDD 66 QPSK	low	6	3	20.48	1	1	9.52	9.52
CAT-M1 eFDD 66 QPSK	mid	1	3	22.84	1	1	7.16	7.16
CAT-M1 eFDD 66 QPSK	mid	3	3	21.45	1	1	8.55	8.55
CAT-M1 eFDD 66 QPSK	mid	6	3	22.69	1	1	7.31	7.31
CAT-M1 eFDD 66 QPSK	high	1	3	22.39	1	1	7.61	7.61
CAT-M1 eFDD 66 QPSK	high	3	3	21.22	1	1	8.78	8.78
CAT-M1 eFDD 66 QPSK	high	6	3	20.56	1	1	9.44	9.44

CAT-M1 eFDD 66 16QAM	low	1	3	21.5	1	1	8.5	8.5
CAT-M1 eFDD 66 16QAM	low	5	3	20.38	1	1	9.62	9.62
CAT-M1 eFDD 66 16QAM	mid	1	3	21.59	1	1	8.41	8.41
CAT-M1 eFDD 66 16QAM	mid	5	3	20.53	1	1	9.47	9.47
CAT-M1 eFDD 66 16QAM	high	1	3	21.2	1	1	8.8	8.8
CAT-M1 eFDD 66 16QAM	high	5	3	20.09	1	1	9.91	9.91
CAT-M1 eFDD 66 QPSK	low	1	5	22.61	1	1	7.39	7.39
CAT-M1 eFDD 66 QPSK	low	3	5	21.38	1	1	8.62	8.62
CAT-M1 eFDD 66 QPSK	low	6	5	21.34	1	1	8.66	8.66
CAT-M1 eFDD 66 QPSK	mid	1	5	22.66	1	1	7.34	7.34
CAT-M1 eFDD 66 QPSK	mid	3	5	21.51	1	1	8.49	8.49
CAT-M1 eFDD 66 QPSK	mid	6	5	21.55	1	1	8.45	8.45
CAT-M1 eFDD 66 QPSK	high	1	5	22.49	1	1	7.51	7.51
CAT-M1 eFDD 66 QPSK	high	3	5	21.08	1	1	8.92	8.92
CAT-M1 eFDD 66 QPSK	high	6	5	21.05	1	1	8.95	8.95
CAT-M1 eFDD 66 16QAM	low	1	5	22.51	1	1	7.49	7.49
CAT-M1 eFDD 66 16QAM	low	5	5	20.1	1	1	9.9	9.9
CAT-M1 eFDD 66 16QAM	mid	1	5	21.97	1	1	8.03	8.03
CAT-M1 eFDD 66 16QAM	mid	5	5	20.47	1	1	9.53	9.53
CAT-M1 eFDD 66 16QAM	high	1	5	22.12	1	1	7.88	7.88
CAT-M1 eFDD 66 16QAM	high	5	5	20.15	1	1	9.85	9.85
CAT-M1 eFDD 66 QPSK	low	1	10	22.66	1	1	7.34	7.34
CAT-M1 eFDD 66 QPSK	low	3	10	22.71	1	1	7.29	7.29
CAT-M1 eFDD 66 QPSK	low	6	10	21.6	1	1	8.4	8.4
CAT-M1 eFDD 66 QPSK	mid	1	10	22.41	1	1	7.59	7.59
CAT-M1 eFDD 66 QPSK	mid	3	10	22.51	1	1	7.49	7.49
CAT-M1 eFDD 66 QPSK	mid	6	10	21.4	1	1	8.6	8.6
CAT-M1 eFDD 66 QPSK	high	1	10	21.91	1	1	8.09	8.09
CAT-M1 eFDD 66 QPSK	high	3	10	21.99	1	1	8.01	8.01
CAT-M1 eFDD 66 QPSK	high	6	10	20.82	1	1	9.18	9.18
CAT-M1 eFDD 66 16QAM	low	1	10	22.45	1	1	7.55	7.55
CAT-M1 eFDD 66 16QAM	low	5	10	21.7	1	1	8.3	8.3
CAT-M1 eFDD 66 16QAM	mid	1	10	22.29	1	1	7.71	7.71
CAT-M1 eFDD 66 16QAM	mid	5	10	21.51	1	1	8.49	8.49
CAT-M1 eFDD 66 16QAM	high	1	10	21.68	1	1	8.32	8.32
CAT-M1 eFDD 66 16QAM	high	5	10	20.67	1	1	9.33	9.33
NB-IoT eFDD 4 QPSK	low	1	0.2	24.01	1	1	5.99	5.99
NB-IoT eFDD 4 QPSK	low	3	0.2	23.51	1	1	6.49	6.49
NB-IoT eFDD 4 QPSK	low	6	0.2	22.86	1	1	7.14	7.14
NB-IoT eFDD 4 QPSK	low	12	0.2	21.36	1	1	8.64	8.64
NB-IoT eFDD 4 QPSK	mid	1	0.2	24.61	1	1	5.39	5.39
NB-IoT eFDD 4 QPSK	mid	3	0.2	24.62	1	1	5.38	5.38
NB-IoT eFDD 4 QPSK	mid	6	0.2	23.35	1	1	6.65	6.65
NB-IoT eFDD 4 QPSK	mid	12	0.2	21.91	1	1	8.09	8.09
NB-IoT eFDD 4 QPSK	high	1	0.2	24.43	1	1	5.57	5.57
NB-IoT eFDD 4 QPSK	high	3	0.2	24.7	1	1	5.3	5.3
NB-IoT eFDD 4 QPSK	high	6	0.2	22.99	1	1	7.01	7.01
NB-IoT eFDD 4 QPSK	high	12	0.2	21.69	1	1	8.31	8.31
NB-IoT eFDD 4 BPSK	low	1	0.2	24.24	1	1	5.76	5.76
NB-IoT eFDD 4 BPSK	mid	1	0.2	24.46	1	1	5.54	5.54
NB-IoT eFDD 4 BPSK	high	1	0.2	24.16	1	1	5.84	5.84
NB-IoT eFDD 8 QPSK	low	1	0.2	22.28	3	3	7.72	7.72
NB-IoT eFDD 8 QPSK	low	3	0.2	22.06	3	3	7.94	7.94
NB-IoT eFDD 8 QPSK	low	6	0.2	22.82	3	3	7.18	7.18
NB-IoT eFDD 8 QPSK	low	12	0.2	21.57	3	3	8.43	8.43
NB-IoT eFDD 8 QPSK	mid	1	0.2	22.43	3	3	7.57	7.57
NB-IoT eFDD 8 QPSK	mid	3	0.2	22.07	3	3	7.93	7.93
NB-IoT eFDD 8 QPSK	mid	6	0.2	22.64	3	3	7.36	7.36
NB-IoT eFDD 8 QPSK	mid	12	0.2	21.73	3	3	8.27	8.27
NB-IoT eFDD 8 QPSK	high	1	0.2	22.27	3	3	7.73	7.73
NB-IoT eFDD 8 QPSK	high	3	0.2	22.25	3	3	7.75	7.75
NB-IoT eFDD 8 QPSK	high	6	0.2	22.71	3	3	7.29	7.29
NB-IoT eFDD 8 QPSK	high	12	0.2	21.68	3	3	8.32	8.32
NB-IoT eFDD 8 BPSK	low	1	0.2	22.39	3	3	7.61	7.61
NB-IoT eFDD 8 BPSK	mid	1	0.2	22.66	3	3	7.34	7.34
NB-IoT eFDD 8 BPSK	high	1	0.2	22.39	3	3	7.61	7.61
NB-IoT eFDD 12 QPSK	low	1	0.2	23.7	3	3	11.07	11.07
NB-IoT eFDD 12 QPSK	low	3	0.2	22.44	3	3	12.33	12.33
NB-IoT eFDD 12 QPSK	low	6	0.2	22.04	3	3	12.73	12.73
NB-IoT eFDD 12 QPSK	low	12	0.2	20.48	3	3	14.29	14.29
NB-IoT eFDD 12 QPSK	mid	1	0.2	23.62	3	3	11.15	11.15
NB-IoT eFDD 12 QPSK	mid	3	0.2	22.09	3	3	12.68	12.68
NB-IoT eFDD 12 QPSK	mid	6	0.2	21.95	3	3	12.82	12.82

NB-IoT eFDD 12 QPSK	mid	12	0.2	20.28	3	3	14.49	14.49
NB-IoT eFDD 12 QPSK	high	1	0.2	23.48	3	3	11.29	11.29
NB-IoT eFDD 12 QPSK	high	3	0.2	22.14	3	3	12.63	12.63
NB-IoT eFDD 12 QPSK	high	6	0.2	22.01	3	3	12.76	12.76
NB-IoT eFDD 12 QPSK	high	12	0.2	20.46	3	3	14.31	14.31
NB-IoT eFDD 12 BPSK	low	1	0.2	23.67	3	3	11.1	11.1
NB-IoT eFDD 12 BPSK	mid	1	0.2	23.55	3	3	11.22	11.22
NB-IoT eFDD 12 BPSK	high	1	0.2	23.48	3	3	11.29	11.29
NB-IoT eFDD 13 QPSK	low	1	0.2	24.82	3	3	9.95	9.95
NB-IoT eFDD 13 QPSK	low	3	0.2	24.43	3	3	10.34	10.34
NB-IoT eFDD 13 QPSK	low	6	0.2	23.7	3	3	11.07	11.07
NB-IoT eFDD 13 QPSK	low	12	0.2	21.48	3	3	13.29	13.29
NB-IoT eFDD 13 QPSK	mid	1	0.2	24.05	3	3	10.72	10.72
NB-IoT eFDD 13 QPSK	mid	3	0.2	23.86	3	3	10.91	10.91
NB-IoT eFDD 13 QPSK	mid	6	0.2	23.82	3	3	10.95	10.95
NB-IoT eFDD 13 QPSK	mid	12	0.2	20.2	3	3	14.57	14.57
NB-IoT eFDD 13 QPSK	high	1	0.2	24.94	3	3	9.83	9.83
NB-IoT eFDD 13 QPSK	high	3	0.2	23.7	3	3	11.07	11.07
NB-IoT eFDD 13 QPSK	high	6	0.2	23.61	3	3	11.16	11.16
NB-IoT eFDD 13 QPSK	high	12	0.2	21.57	3	3	13.2	13.2
NB-IoT eFDD 13 BPSK	low	1	0.2	23.66	3	3	11.11	11.11
NB-IoT eFDD 13 BPSK	mid	1	0.2	24.86	3	3	9.91	9.91
NB-IoT eFDD 13 BPSK	high	1	0.2	23.84	3	3	11.07	11.07
NB-IoT eFDD 66 QPSK	low	1	0.2	25.19	1	1	4.81	4.81
NB-IoT eFDD 66 QPSK	low	3	0.2	25.3	1	1	4.7	4.7
NB-IoT eFDD 66 QPSK	low	6	0.2	22.65	1	1	7.35	7.35
NB-IoT eFDD 66 QPSK	low	12	0.2	19.8	1	1	10.2	10.2
NB-IoT eFDD 66 QPSK	mid	1	0.2	24.86	1	1	5.14	5.14
NB-IoT eFDD 66 QPSK	mid	3	0.2	24.71	1	1	5.29	5.29
NB-IoT eFDD 66 QPSK	mid	6	0.2	23.41	1	1	6.59	6.59
NB-IoT eFDD 66 QPSK	mid	12	0.2	20.07	1	1	9.93	9.93
NB-IoT eFDD 66 QPSK	high	1	0.2	24.63	1	1	5.37	5.37
NB-IoT eFDD 66 QPSK	high	3	0.2	24.62	1	1	5.38	5.38
NB-IoT eFDD 66 QPSK	high	6	0.2	23.41	1	1	6.59	6.59
NB-IoT eFDD 66 QPSK	high	12	0.2	20.1	1	1	9.9	9.9
NB-IoT eFDD 66 BPSK	low	1	0.2	24.65	1	1	5.35	5.35
NB-IoT eFDD 66 BPSK	mid	1	0.2	24.28	1	1	5.72	5.72
NB-IoT eFDD 66 BPSK	high	1	0.2	24.06	1	1	5.94	5.94
NB-IoT eFDD 71 QPSK	low	1	0.2	22.54	3	3	12.23	12.23
NB-IoT eFDD 71 QPSK	low	3	0.2	22.14	3	3	12.63	12.63
NB-IoT eFDD 71 QPSK	low	6	0.2	22.57	3	3	12.2	12.2
NB-IoT eFDD 71 QPSK	low	12	0.2	20.91	3	3	13.86	13.86
NB-IoT eFDD 71 QPSK	mid	1	0.2	22.05	3	3	12.72	12.72
NB-IoT eFDD 71 QPSK	mid	3	0.2	21.15	3	3	13.62	13.62
NB-IoT eFDD 71 QPSK	mid	6	0.2	22.2	3	3	12.57	12.57
NB-IoT eFDD 71 QPSK	mid	12	0.2	20.45	3	3	14.32	14.32
NB-IoT eFDD 71 QPSK	high	1	0.2	22.19	3	3	12.58	12.58
NB-IoT eFDD 71 QPSK	high	3	0.2	21.19	3	3	13.58	13.58
NB-IoT eFDD 71 QPSK	high	6	0.2	21.98	3	3	12.79	12.79
NB-IoT eFDD 71 QPSK	high	12	0.2	20.03	3	3	14.74	14.74
NB-IoT eFDD 71 BPSK	low	1	0.2	22.36	3	3	12.41	12.41
NB-IoT eFDD 71 BPSK	mid	1	0.2	22.12	3	3	12.65	12.65
NB-IoT eFDD 71 BPSK	high	1	0.2	22.19	3	3	12.58	12.58
NB-IoT eFDD 85 QPSK	low	1	0.2	24.06	3	3	10.71	10.71
NB-IoT eFDD 85 QPSK	low	3	0.2	23.49	3	3	11.28	11.28
NB-IoT eFDD 85 QPSK	low	6	0.2	22.49	3	3	12.28	12.28
NB-IoT eFDD 85 QPSK	low	12	0.2	19.14	3	3	15.63	15.63
NB-IoT eFDD 85 QPSK	mid	1	0.2	24.53	3	3	10.24	10.24
NB-IoT eFDD 85 QPSK	mid	3	0.2	24.81	3	3	9.96	9.96
NB-IoT eFDD 85 QPSK	mid	6	0.2	22.66	3	3	12.11	12.11
NB-IoT eFDD 85 QPSK	mid	12	0.2	19.3	3	3	15.47	15.47
NB-IoT eFDD 85 QPSK	high	1	0.2	22.93	3	3	11.84	11.84
NB-IoT eFDD 85 QPSK	high	3	0.2	24.23	3	3	10.54	10.54
NB-IoT eFDD 85 QPSK	high	6	0.2	22.23	3	3	12.54	12.54
NB-IoT eFDD 85 QPSK	high	12	0.2	20.63	3	3	14.14	14.14
NB-IoT eFDD 85 BPSK	low	1	0.2	23.95	3	3	10.82	10.82
NB-IoT eFDD 85 BPSK	mid	1	0.2	23.57	3	3	11.2	11.2
NB-IoT eFDD 85 BPSK	high	1	0.2	23.62	3	3	11.15	11.15

Remark: Please see next sub-clause for the measurement plot.