

InterLab[®]

Final Report on

TOBY-L280 Data Module
FCC ID: XPYTOBYL280
IC:8595A-TOBYL280

Report Reference: MDE_UBLOX_1510_FCCa_rev1
according to FCC Part 22, Subpart H Part 24, subpart E

Date: June 23, 2015

Test Laboratory:

7Layers AG
Borsigstr. 11
40880 Ratingen
Germany



Note:

The following test results relate only to the devices specified in this document. This report shall not be reproduced in parts without the written approval of the test laboratory.

7Layers AG
Borsigstrasse 11
40880 Ratingen, Germany
Phone: +49 (0) 2102 749 0
Fax: +49 (0) 2102 749 350
www.7Layers.com

Aufsichtsratsvorsitzender • Chairman
of the Supervisory Board: Peter
Mertel
Vorstand • Board:
Dr. H. Ansorge

Registergericht • registered in:
Düsseldorf, HRB 44096
USt-IdNr • VAT No.:
DE 203159652
TAX No. 147/5869/0385

1 Administrative Data

1.1 Project Data

Project Responsible: Dirk Bratsch
Date Of Test Report: 2015/06/23
Date of first test: 2014/07/14
Date of last test: 2014/08/20

1.2 Applicant Data

Company Name: u-blox AG
Street: Zürcherstrasse 68,
CH-8800 Thalwil
Country: Switzerland
Contact Person: Mr. Giulio Comar
Function: Certification Manager
Department: Wireless R&D center
Phone: +41 44 722 7462
Fax: +41 44 722 7447
E-Mail: giulio.comar@u-blox.com

1.3 Test Laboratory Data

The following list shows all places and laboratories involved for test result generation:

7 layers DE

Company Name : 7 layers AG
Street : Borsigstrasse 11
City : 40880 Ratingen
Country : Germany
Contact Person : Mr. Michael Albert
Phone : +49 2102 749 201
Fax : +49 2102 749 444
E Mail : Michael.Albert@7Layers.com

Laboratory Details

<i>Lab ID</i>	<i>Identification</i>	<i>Accreditation Info</i>
Lab 1	Radiated Emissions	DAkKS-Registration no. D-PL-12140-01-01
Lab 2	Radio Lab	DAkKS-Registration no. D-PL-12140-01-01

1.4 Signature of the Testing Responsible

 Daniel Gall
 responsible for tests performed in: Lab 1, Lab 2

1.5 Signature of the Accreditation Responsible

Accreditation scope responsible person
responsible for Lab 1, Lab 2

Revision History

Report version control			
Version	Release date	Change Description	Version validity
initial	2015-06-02	--	invalid
rev1	2015-06-23	Changed writing of values spurious emissions at antenna terminal original report, added IC number, changed description of testcase Field strength of spurious radiation. Added IC cross reference table.	valid

2 Test Object Data TOBY-L210

2.1 General OUT Description

The following section lists all OUTs (Object's Under Test) involved during testing.

OUT: TOBY L210

<i>Type / Model / Family:</i>	TOBY L210 Data Module
	FCC ID: XPYTOBYL210 IC:8595A-TOBYL210
<i>Product Category:</i>	Module
Manufacturer:	
<i>Company Name:</i>	Please see applicant data
<i>Contact Person:</i>	-
	<i>Value</i>

Parameter List:

Parameter name

Parameter for Scope FCC_v2:

AC Power Supply	120/60Hz (AC Adapter) (AC)
Antenna gain 1700 band	0 (dBi)
Antenna gain 1900 band	0 (dBi)
Antenna gain 850 band	0 (dBi)
highest channel	251 (848.8MHz) for GSM850, 810 (1909.8MHz) for GSM1900, 4233 (846.6MHz) for FDD5, 9538 (1907.6MHz) for FDD2
lowest channel	128 (824.2MHz) for GSM850, 512 (1850.2MHz) for GSM1900, 4132 (826.4MHz) for FDD5, 9262 (1852.4MHz)for FDD2 (MHz)
mid channel	190 (836.6MHz) for GSM850, 661 (1880.0MHz) for GSM1900, 4183 (836.6MHz) for FDD5, 9400 (1880MHz) for FDD2, 1412 (1732.4MHz)

2.2 Detailed Description of OUT Samples

Sample : AS06

<i>OUT Identifier</i>	TOBY L210		
<i>Sample Description</i>	Standard sample		
<i>Serial No.</i>	352255060018326		
<i>HW Status</i>	192B00		
<i>SW Status</i>	09.32		
<i>Date of Receipt</i>	2014/07/10		
<i>Low Voltage</i>	3.3 V	<i>Low Temp.</i>	-20 °C
<i>High Voltage</i>	4.4 V	<i>High Temp.</i>	55 °C
<i>Nominal Voltage</i>	3.8 V	<i>Normal Temp.</i>	25 °C

2.3 OUT Features

Supported Features for OUT: TOBY L210

<i>Designation</i>	<i>Description</i>	<i>Supported Value(s)</i>
Features for scope: FCC_v2		
AC	The OUT is powered by or connected to AC Mains	
Dant	removable antenna supplied and type tested with the radio equipment, designed as an example part of the equipment	
EDGE850	EUT supports EDGE in the band 824 MHz - 849 MHz	
EDGE1900	EUT supports EDGE in the band 1850 MHz - 1910 MHz	
FDD2	EUT supports UMTS FDD2 in the band 1850 MHz - 1910 MHz	
FDD5	EUT supports UMTS FDD5 in the band 824 MHz - 849 MHz	
GSM850	EUT supports GSM850 band 824MHz - 849MHz	
HSDPA-FDD2	EUT supports UMTS FDD2 HSDPA in the band 1850 MHz - 1910 MHz	
HSDPA-FDD5	EUT supports UMTS FDD5 HSDPA in the band 824 MHz - 849 MHz	
HSUPA-FDD2	EUT supports UMTS FDD2 HSUPA in the band 1850 MHz - 1910 MHz	
HSUPA-FDD5	EUT supports UMTS FDD5 HSUPA in the band 824 MHz - 849 MHz	
PantC	permanent fixed antenna connector, which may be built-in, designed as an indispensable part of the equipment	
PCS1900	EUT supports PCS1900 band 1850MHz - 1910MHz	

2.4 Setups used for Testing

For each setup a relation is given to determine if and which samples and auxiliary equipment is used. The left side list all OUT samples and the right side lists all auxiliary equipment for the given setup.

<i>Setup No.</i>	<i>List of OUT samples</i>	<i>List of auxiliary equipment</i>		
	<i>Sample No.</i>	<i>Sample Description</i>	<i>AE No.</i>	<i>AE Description</i>

S01_AS06

<i>Sample:</i> AS06	Standard sample
---------------------	-----------------

3 Results for TOBY-L210

3.1 General

Documentation of tested devices:

Available at the test laboratory.

Interpretation of the test results:

The results of the inspection are described on the following pages, where 'Conformity' or 'Passed' means that the certification criteria were verified and that the tested device is conform to the applied standard.

In cases where 'Declaration' is printed, the required documents are available in the manufacturers product documentation.

In cases where 'not applicable' is printed, the test case requirements are not relevant to the specific equipment implementation.

- Note:**
1. All tests are performed under environmental conditions within the requirements of the specifications. Environmental conditions are available at the laboratory.
 2. This test report incorporated results of variants of this module that were previously already tested (original results: TOBY-L210 test report reference: MDE_UBLOX_1409_FCCa). For this variant the eFDD20 band was removed while the non FCC relevant band eFDD28 was added. According to the applicant the changes in Hard- and Software are only related to these two bands and will not affect the other bands. Due to this the old results were reused and only partial testing of the previous worst case results were performed. These results and a comparison to the old results are added to this report as an additional chapter (chapter 6).
 3. The results in chapter 3 shows the results of the original variant of the module, report reference: MDE_UBLOX_1409_FCCa. Chapter 6 provides the measurement of the new version of the module and a comparison of the original values.

3.2 List of the Applicable Body

(Bodies for Scope: FCC_v2)

<i>Designation</i>	<i>Description</i>
FCC47CFRChIPART22PUBLIC MOBILE SERVICES	Part 22, Subpart H - Cellular Radiotelephone Service
FCC47CFRChIPART24PERSONAL COMMUNICATIONS SERVICES	Part 24, Subpart E - Broadband PCS

3.3 List of Test Specification

<i>Test Specification:</i>	FCC part 2 and 22
<i>Version</i>	10-1-13 Edition
<i>Title:</i>	PART 2 - GENERAL RULES AND REGULATIONS PART 22 - PUBLIC MOBILE SERVICES
<i>Test Specification:</i>	FCC part 2 and 24
<i>Version</i>	10-1-13 Edition
<i>Title:</i>	PART 2 - GENERAL RULES AND REGULATIONS PART 24 - PERSONAL COMMUNICATIONS SERVICES

3.4 Summary

<i>Test Case Identifier / Name</i>	<i>Cat</i>	<i>Verdict</i>	<i>Date of Test</i>	<i>Lab Ref.</i>	<i>Setup</i>
Test Specification: FCC part 2 and 22					
22.1 RF Power Output §2.1046, §22.913					
22.1; RF Power Output Summary §2.1046, §22.913	-	Passed	2014/08/20	Lab 2	S01_AS06
22.2 Frequency stability §2.1055					
22.2; Frequency stability Summary §2.1055	-	Passed	2014/08/18	Lab 2	S01_AS06
22.3 Spurious emissions at antenna terminals §2.1051, §22.917					
22.3; Spurious emissions at antenna terminals summary §2.1051, §22.917	-	Passed	2014/07/22	Lab 2	S01_AS06
22.4 Field strength of spurious radiation §2.1053, §22.917					
22.4; Frequency Band = 850, Mode = EDGE, Channel = 128, Frequency = 824.2MHz	-	Passed	2014/08/08	Lab 1	S01_AS06
22.4; Frequency Band = 850, Mode = EDGE, Channel = 190, Frequency = 836.6MHz	-	Passed	2014/08/08	Lab 1	S01_AS06
22.4; Frequency Band = 850, Mode = EDGE, Channel = 251, Frequency = 848.8MHz	-	Passed	2014/08/08	Lab 1	S01_AS06
22.4; Frequency Band = 850, Mode = GSM, Channel = 128, Frequency = 824.2MHz	-	Passed	2014/08/07	Lab 1	S01_AS06
22.4; Frequency Band = 850, Mode = GSM, Channel = 190, Frequency = 836.6MHz	-	Passed	2014/08/07	Lab 1	S01_AS06
22.4; Frequency Band = 850, Mode = GSM, Channel = 251, Frequency = 848.8MHz	-	Passed	2014/08/07	Lab 1	S01_AS06
22.4; Frequency Band = FDD5, Mode = HSDPA, Channel = 4132, Frequency = 826.4MHz	-	Passed	2014/08/07	Lab 1	S01_AS06
22.4; Frequency Band = FDD5, Mode = HSDPA, Channel = 4183, Frequency = 836.6MHz	-	Passed	2014/08/07	Lab 1	S01_AS06
22.4; Frequency Band = FDD5, Mode = HSDPA, Channel = 4233, Frequency = 846.6MHz	-	Passed	2014/08/07	Lab 1	S01_AS06
22.4; Frequency Band = FDD5, Mode = HSUPA, Channel = 4132, Frequency = 826.4MHz	-	Passed	2014/08/05	Lab 1	S01_AS06
22.4; Frequency Band = FDD5, Mode = HSUPA, Channel = 4183, Frequency = 836.6MHz	-	Passed	2014/08/08	Lab 1	S01_AS06
22.4; Frequency Band = FDD5, Mode = HSUPA, Channel = 4233, Frequency = 846.6MHz	-	Passed	2014/08/08	Lab 1	S01_AS06
22.4; Frequency Band = FDD5, Mode = W-CDMA, Channel = 4132, Frequency = 826.4MHz	-	Passed	2014/08/08	Lab 1	S01_AS06
22.4; Frequency Band = FDD5, Mode = W-CDMA, Channel = 4183, Frequency = 836.6MHz	-	Passed	2014/08/08	Lab 1	S01_AS06
22.4; Frequency Band = FDD5, Mode = W-CDMA, Channel = 4233, Frequency = 846.6MHz	-	Passed	2014/08/08	Lab 1	S01_AS06
22.5 Emission and Occupied Bandwidth §2.1049, §22.917					
22.5; Emission and Occupied Bandwidth Summary §2.1049, §22.917	-	Passed	2014/07/14	Lab 2	S01_AS06
22.6 Band edge compliance §2.1053, §22.917					
22.6; Band edge compliance Summary §2.1053, §22.917	-	Passed	2014/07/14	Lab 2	S01_AS06

Test Specification: FCC part 2 and 24

<i>Test Case Identifier / Name</i>	<i>Cat</i>	<i>Verdict</i>	<i>Date of Test</i>	<i>Lab Ref.</i>	<i>Setup</i>
24.1 RF Power Output §2.1046, §24.232					
24.1; RF Power Output Summary §2.1046, §24.232	-	Passed	2014/08/20	Lab 2	S01_AS06
24.2 Frequency stability §2.1055, §24.235					
24.2; Frequency stability Summary §2.1055, 24.235	-	Passed	2014/08/18	Lab 2	S01_AS06
24.3 Spurious emissions at antenna terminals §2.1051, §24.238					
24.3; Spurious emissions at antenna terminals Summary §2.1051, §24.238	-	Passed	2014/07/20	Lab 2	S01_AS06
24.4 Field strength of spurious radiation §2.1053, §24.238					
24.4; Frequency Band = 1900, Mode = EDGE, Channel = 512, Frequency = 1850.2MHz	-	Passed	2014/08/08	Lab 1	S01_AS06
24.4; Frequency Band = 1900, Mode = EDGE, Channel = 661, Frequency = 1880.0MHz	-	Passed	2014/08/08	Lab 1	S01_AS06
24.4; Frequency Band = 1900, Mode = EDGE, Channel = 810, Frequency = 1909.8MHz	-	Passed	2014/08/08	Lab 1	S01_AS06
24.4; Frequency Band = 1900, Mode = GSM, Channel = 512, Frequency = 1850.2MHz	-	Passed	2014/08/06	Lab 1	S01_AS06
24.4; Frequency Band = 1900, Mode = GSM, Channel = 661, Frequency = 1880.0MHz	-	Passed	2014/08/07	Lab 1	S01_AS06
24.4; Frequency Band = 1900, Mode = GSM, Channel = 810, Frequency = 1909.8MHz	-	Passed	2014/08/07	Lab 1	S01_AS06
24.4; Frequency Band = FDD2, Mode = HSDPA, Channel = 9262, Frequency = 1852.4MHz	-	Passed	2014/08/08	Lab 1	S01_AS06
24.4; Frequency Band = FDD2, Mode = HSDPA, Channel = 9400, Frequency = 1880MHz	-	Passed	2014/08/08	Lab 1	S01_AS06
24.4; Frequency Band = FDD2, Mode = HSDPA, Channel = 9538, Frequency = 1907.6MHz	-	Passed	2014/08/08	Lab 1	S01_AS06
24.4; Frequency Band = FDD2, Mode = HSUPA, Channel = 9262, Frequency = 1852.4MHz	-	Passed	2014/08/10	Lab 1	S01_AS06
24.4; Frequency Band = FDD2, Mode = HSUPA, Channel = 9400, Frequency = 1880MHz	-	Passed	2014/08/11	Lab 1	S01_AS06
24.4; Frequency Band = FDD2, Mode = HSUPA, Channel = 9538, Frequency = 1907.6MHz	-	Passed	2014/08/08	Lab 1	S01_AS06
24.4; Frequency Band = FDD2, Mode = W-CDMA, Channel = 9262, Frequency = 1852.4MHz	-	Passed	2014/08/08	Lab 1	S01_AS06
24.4; Frequency Band = FDD2, Mode = W-CDMA, Channel = 9400, Frequency = 1880MHz	-	Passed	2014/08/08	Lab 1	S01_AS06
24.4; Frequency Band = FDD2, Mode = W-CDMA, Channel = 9538, Frequency = 1907.6MHz	-	Passed	2014/08/08	Lab 1	S01_AS06
24.5 Emission and Occupied Bandwidth §2.1049, §24.238					
24.5; Emission and Occupied Bandwidth Summary §2.1049, §24.238	-	Passed	2014/07/14	Lab 2	S01_AS06
24.6 Band edge compliance §2.1053, §24.238					
24.6; Frequency Band = 1900 / FDD2	-	Passed	2014/07/14	Lab 2	S01_AS06

3.5 Detailed Results

3.5.1 22.1 RF Power Output §2.1046, §22.913

Test: 22.1; RF Power Output Summary §2.1046, §22.913

<i>Result:</i>	Passed
<i>Setup No.:</i>	S01_AS06
<i>Date of Test:</i>	2014/08/20 11:43
<i>Body:</i>	FCC47CFRChIPART22PUBLIC MOBILE SERVICES
<i>Test Specification:</i>	FCC part 2 and 22

Detailed Results:

Band	Mode	Modulation	Channel	Frequency (MHz)	Peak Conducted power	Average Conducted power	RMS Conducted power	FCC EIRP limit (W)	IC EIRP limit per SRSP-503 (W)	Maximum antenna gain (dBi)	Verdict
850	GSM/GPRS	GFSK	Low	824,2	32.73	32.24	32.26	11.48	11.5	8.34	Pass
			Mid	836,6	32.81	32.33	32.35			8.25	Pass
			High	848,8	32.81	32.36	32.36			8.24	Pass
850	EDGE	8PSK	Low	824,2	30.36	26.41	26.89	11.48	11.5	13.71	Pass
			Mid	836,6	30.7	27.08	27.49			13.11	Pass
			High	848,8	30.92	27.35	27.84			12.76	Pass
FDD 5	W-CDMA	QPSK	Low	826.4	26.61	21.15	21.37	11.48	11.5	19.23	Pass
			Mid	836.6	26.9	21.47	21.69			18.91	Pass
			High	846.6	27.03	21.53	21.73			18.87	Pass
FDD 5	HSDPA Subtest 1	QPSK	Low	826.4	26.48	21.14	21.36	11.48	11.5	19.24	Pass
			Mid	836.6	27.03	21.43	21.64			18.96	Pass
			High	846.6	26.9	21.43	21.68			18.92	Pass
FDD 5	HSDPA Subtest 2	QPSK	Low	826.4	27.69	19.68	20.31	11.48	11.5	20.29	Pass
			Mid	836.6	28.45	20.07	20.61			19.99	Pass
			High	846.6	27.94	19.83	20.42			20.18	Pass
FDD 5	HSDPA Subtest 3	QPSK	Low	826.4	27.82	18.47	19.46	11.48	11.5	21.14	Pass
			Mid	836.6	27.82	18.91	20.02			20.58	Pass
			High	846.6	27.94	18.75	19.77			20.83	Pass
FDD 5	HSDPA Subtest 4	QPSK	Low	826.4	27.82	18.37	19.48	11.48	11.5	21.12	Pass
			Mid	836.6	28.08	18.59	19.81			20.79	Pass
			High	846.6	28.08	18.66	19.77			20.83	Pass
FDD 5	HSUPA Subtest 1	QPSK	Low	826.4	28.92	21.57	21.95	11.48	11.5	18.65	Pass
			Mid	836.6	29.17	21.68	22.08			18.52	Pass
			High	846.6	28.79	21.75	22.14			18.46	Pass
FDD 5	HSUPA Subtest 2	QPSK	Low	826.4	28.4	18.92	19.91	11.48	11.5	20.69	Pass
			Mid	836.6	29.06	19.08	20.13			20.47	Pass
			High	846.6	28.92	19.16	20.15			20.45	Pass
FDD 5	HSUPA Subtest 3	QPSK	Low	826.4	28.79	19.55	20.37	11.48	11.5	20.23	Pass
			Mid	836.6	29.17	19.74	20.61			19.99	Pass
			High	846.6	28.03	19.5	20.3			20.3	Pass
FDD 5	HSUPA Subtest 4	QPSK	Low	826.4	28.4	18.93	20.23	11.48	11.5	20.37	Pass
			Mid	836.6	28.4	19.05	20.33			20.27	Pass
			High	846.6	28.4	19.15	20.38			20.22	Pass
FDD 5	HSUPA Subtest 5	QPSK	Low	826.4	27.62	20.52	20.87	11.48	11.5	19.73	Pass
			Mid	836.6	28.03	20.8	21.17			19.43	Pass
			High	846.6	27.76	20.85	21.22			19.38	Pass

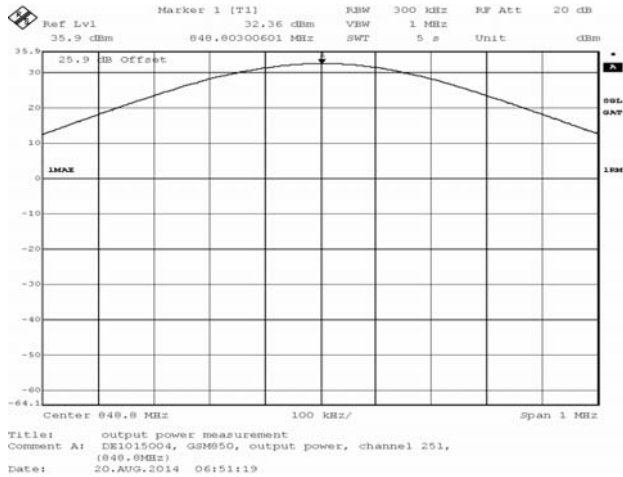

GSM 850 Band

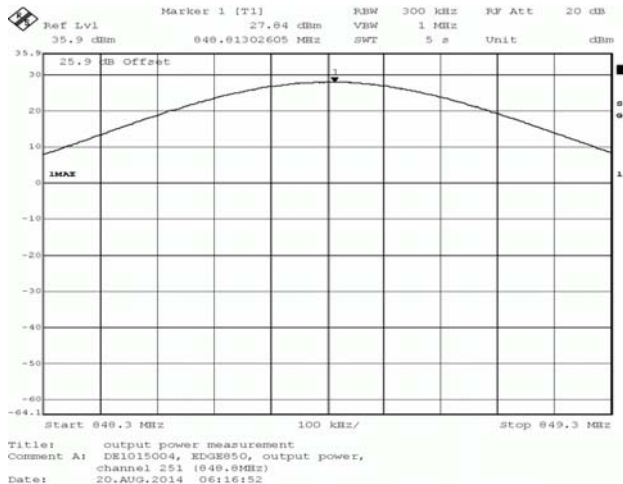

EDGE 850 Band

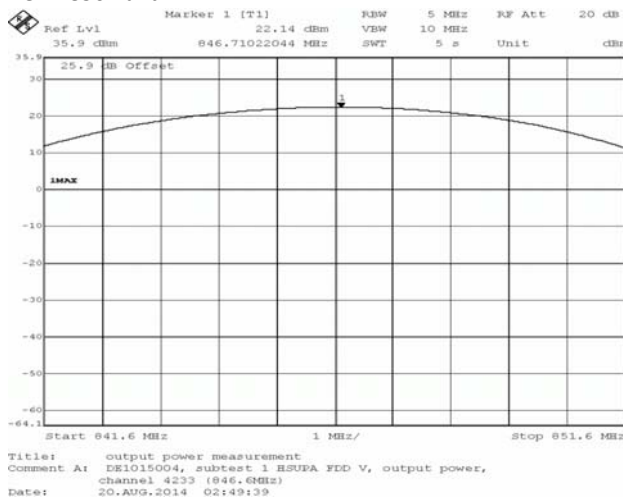

HSPA FDD5

3.5.2 22.2 Frequency stability §2.1055

Test: 22.2; Frequency stability Summary §2.1055

<i>Result:</i>	Passed
<i>Setup No.:</i>	S01_AS06
<i>Date of Test:</i>	2014/08/18 11:46
<i>Body:</i>	FCC47CFRChIPART22PUBLIC MOBILE SERVICES
<i>Test Specification:</i>	FCC part 2 and 22

Detailed Results:

22.2: Frequency stability §2.1055 GSM 850 band, Channel 190

Temp. °C	Duration min	Voltage	Limit Hz	Freq. error Average (Hz)	Freq. error Max. (Hz)	Verdict	Tested sample
-30	0	normal	2095.5	-7	-34	passed	ax06
-30	5			2	-34	passed	ax06
-30	10			-5	-28	passed	ax06
-20	0	normal	2095.5	4	25	passed	ax06
-20	5			-1	33	passed	ax06
-20	10			-3	-24	passed	ax06
-10	0	normal	2095.5	0	24	passed	ax06
-10	5			2	-29	passed	ax06
-10	10			-3	-23	passed	ax06
0	0	normal	2095.5	-3	-22	passed	ax06
0	5			-5	-30	passed	ax06
0	10			-4	-24	passed	ax06
10	0	normal	2095.5	-2	-26	passed	ax06
10	5			-2	-37	passed	ax06
10	10			1	-24	passed	ax06
20	0	low	2095.5	-4	-28	passed	an07
20	5			-2	-26	passed	an07
20	10			-5	-29	passed	an07
20	0	normal = high ¹⁾	2095.5	1	27	passed	ax05
20	5			2	-19	passed	ax05
20	10			1	24	passed	ax05
20	0	high	2095.5	0	-24	passed	an07
20	5			-5	-21	passed	an07
20	10			-2	-23	passed	an07
30	0	normal	2095.5	-2	-32	passed	ax05
30	5			1	23	passed	ax05
30	10			-5	-34	passed	ax05
40	0	normal	2095.5	-3	-29	passed	ax05
40	5			-1	-30	passed	ax05
40	10			-4	-26	passed	ax05
50	0	normal	2095.5	1	-30	passed	ax05
50	5			1	24	passed	ax05
50	10			-6	-29	passed	ax05

1) The manufacturer declared that normal voltage is equivalent with high voltage.

22.2: Frequency stability §2.1055, UMTS FDD5, Channel 4183

Temp. °C	Duration min	Voltage	Limit Hz	Freq. error Average (Hz)	Freq. error Max. (Hz)	Verdict	Tested Sample
-30	0	normal	2095.5	4	9	passed	ax07
-30	5			4	10	passed	ax07
-30	10			5	9	passed	ax07
-20	0	normal	2095.5	5	12	passed	ax07
-20	5			6	11	passed	ax07
-20	10			5	8	passed	ax07
-10	0	normal	2095.5	5	11	passed	ax07
-10	5			0	-5	passed	ax07
-10	10			4	9	passed	ax07
0	0	normal	2095.5	4	11	passed	ax07
0	5			-5	-9	passed	ax07
0	10			0	5	passed	ax07
10	0	normal	2095.5	-5	-10	passed	ax07
10	5			0	-5	passed	ax07
10	10			-2	-7	passed	ax07
20	0	low	2095.5	2	6	passed	an07
20	5			6	11	passed	an07
20	10			-1	-4	passed	an07
20	0	normal = high ¹⁾	2095.5	7	12	passed	ax06
20	5			4	11	passed	ax06
20	10			-1	-7	passed	ax06
20	0	high	2095.5	4	13	passed	an07
20	5			2	7	passed	an07
20	10			1	7	passed	an07
30	0	normal	2095.5	5	13	passed	ax06
30	5			-1	-5	passed	ax06
30	10			1	5	passed	ax06
40	0	normal	2095.5	0	-8	passed	ax06
40	5			-5	-11	passed	ax06
40	10			-1	-6	passed	ax06
50	0	normal	2095.5	0	-5	passed	ax06
50	5			-4	-8	passed	ax06
50	10			-8	-14	passed	ax06

- 1) The manufacturer declared that normal voltage is equivalent with high voltage.
- 2) The manufacturer declared that low voltage value of 3.3v.

3.5.3 22.3 Spurious emissions at antenna terminals §2.1051, §22.917

Test: 22.3; Spurious emissions at antenna terminals summary §2.1051, §22.917

Result: Passed
 Setup No.: S01_AS06
 Date of Test: 2014/07/22 13:59
 Body: FCC47CFRChIPART22PUBLIC MOBILE SERVICES
 Test Specification: FCC part 2 and 22

Detailed Results:

Spurious emissions at antenna terminals §2.1051, §22.917									
Mode / Band	Channel	detector	trace	resolution bandwidth /kHz	frequency /MHz	peak value /dBm	margin to limit /dB	limit /dBm	verdict
GSM/850	128	peak	maxhold	3	823.9038	-32.8	19.8	-13.0	passed
		peak	maxhold	3	823.9218	-29.2	16.2	-13.0	passed
		peak	maxhold	3	823.9279	-28.8	15.8	-13.0	passed
		peak	maxhold	3	823.9599	-21.0	8.0	-13.0	passed
		peak	maxhold	3	823.9800	-14.9	1.9	-13.0	passed
		peak	maxhold	3	823.9920	-16.2	3.2	-13.0	passed
	160	peak	maxhold	100	6993.988	-34.74	21.74	-13	passed
	251	peak	maxhold	3	849.0200	-14.6	1.6	-13.0	passed
		peak	maxhold	3	849.0281	-19.4	6.4	-13.0	passed
		peak	maxhold	3	849.0581	-23.4	10.4	-13.0	passed
peak		maxhold	3	849.0902	-29.5	16.5	-13.0	passed	
UMTS / FDD5	4132	rms	maxhold	50	824	-31.4	18.4	-13	passed
		rms	maxhold	50	824	-27.8	14.8	-13	passed
	4183	peak	maxhold	100	6994	-35.13	22.13	-13	passed
	4233	rms	maxhold	50	849	-29.6	16.6	-13	passed
HSUPA / FDD5	4132	rms	maxhold	50	824	-32.3	19.3	-13	passed
		rms	maxhold	50	824	-27.9	14.9	-13	passed
	4183	peak	maxhold	100	6984	-34.42	21.42	-13	passed
	4233	rms	maxhold	50	849	-27.5	14.5	-13	passed
HSDPA / FDD5	4132	rms	maxhold	50	823.81	-31.3	18.3	-13.0	passed
		rms	maxhold	50	824.00	-27.9	14.9	-13.0	passed
		peak	maxhold	100	872.85	-30.6	17.6	-13.0	passed
	4183	rms	maxhold	50	849.00	-28.8	15.8	-13.0	passed
		rms	maxhold	50	849.17	-32.9	19.9	-13.0	passed
		peak	maxhold	100	890.65	-31.7	18.7	-13.0	passed
		peak	maxhold	100	879.76	-29.8	16.8	-13.0	passed

3.5.4 22.4 Field strength of spurious radiation §2.1053, §22.917

Test: 22.4; Frequency Band = 850, Mode = EDGE, Channel = 128, Frequency = 824.2MHz

Result: Passed
Setup No.: S01_AS06
Date of Test: 2014/08/08 14:07
Body: FCC47CFRChIPART22PUBLIC MOBILE SERVICES
Test Specification: FCC part 2 and 22

Detailed Results:

detector	trace	resolution bandwidth /kHz	frequency /MHz	peak value /dBm	limit /dBm	margin to limit /dB	azimuth /°	antenna polarization	EUT orientation	verdict
peak	maxhold	3	823.9499	-32.16	-13.00	19.16	-180.0	vertical	vertical	passed
peak	maxhold	3	823.9639	-32.23	-13.00	19.23	0.0	vertical	vertical	passed
peak	maxhold	3	823.9699	-32.28	-13.00	19.28	-180.0	horizontal	horizontal	passed
peak	maxhold	3	823.9760	-28.05	-13.00	15.05	-180.0	vertical	vertical	passed
peak	maxhold	3	823.9840	-25.91	-13.00	12.91	-180.0	vertical	vertical	passed
peak	maxhold	3	823.9920	-27.23	-13.00	14.23	-180.0	vertical	vertical	passed
peak	maxhold	3	823.9960	-30.45	-13.00	17.45	-180.0	horizontal	horizontal	passed

no further values have been found with a margin of less than 20 dB

Test: 22.4; Frequency Band = 850, Mode = EDGE, Channel = 190, Frequency = 836.6MHz

Result: Passed
Setup No.: S01_AS06
Date of Test: 2014/08/08 15:32
Body: FCC47CFRChIPART22PUBLIC MOBILE SERVICES
Test Specification: FCC part 2 and 22

Detailed Results:

detector	trace	resolution bandwidth /kHz	frequency /MHz	peak value /dBm	limit /dBm	margin to limit /dB	azimuth /°	antenna polarization	EUT orientation	verdict
peak	maxhold	1000	349.4	-27.39	-13.00	14.39	0.0	vertical	vertical	passed
peak	maxhold	1000	778.5	-32.35	-13.00	19.35	0.0	vertical	vertical	passed

no further values have been found with a margin of less than 20 dB

Test: 22.4; Frequency Band = 850, Mode = EDGE, Channel = 251, Frequency = 848.8MHz

Result: Passed
Setup No.: S01_AS06
Date of Test: 2014/08/08 13:05
Body: FCC47CFRChIPART22PUBLIC MOBILE SERVICES
Test Specification: FCC part 2 and 22

Detailed Results:

detector	trace	resolution bandwidth /kHz	frequency /MHz	peak value /dBm	limit /dBm	margin to limit /dB	azimuth /°	antenna polarization	EUT orientation	verdict
peak	maxhold	3	849.0020	-29.98	-13.00	16.98	-180.0	vertical	vertical	passed
peak	maxhold	3	849.0140	-30.95	-13.00	17.95	-180.0	horizontal	horizontal	passed
peak	maxhold	3	849.0220	-31.84	-13.00	18.84	90.0	vertical	vertical	passed
peak	maxhold	3	849.0261	-31.79	-13.00	18.79	-180.0	horizontal	horizontal	passed
peak	maxhold	3	849.0321	-27.63	-13.00	14.63	-180.0	vertical	vertical	passed
peak	maxhold	3	849.0561	-31.36	-13.00	18.36	-180.0	vertical	vertical	passed

no further values have been found with a margin of less than 20 dB

Test: 22.4; Frequency Band = 850, Mode = GSM, Channel = 128, Frequency = 824.2MHz

Result: Passed
Setup No.: S01_AS06
Date of Test: 2014/08/07 12:06
Body: FCC47CFRChIPART22PUBLIC MOBILE SERVICES
Test Specification: FCC part 2 and 22

Detailed Results:

detector	trace	resolution bandwidth /kHz	frequency /MHz	peak value /dBm	limit /dBm	margin to limit /dB	azimuth /°	antenna polarization	EUT orientation	verdict
peak	maxhold	3	823.9319	-27.26	-13.00	14.26	90.0	vertical	vertical	passed
peak	maxhold	3	823.9419	-31.36	-13.00	18.36	-90.0	vertical	vertical	passed
peak	maxhold	3	823.9459	-26.09	-13.00	13.09	90.0	vertical	vertical	passed
peak	maxhold	3	823.9559	-31.72	-13.00	18.72	-180.0	horizontal	vertical	passed
peak	maxhold	3	823.9619	-28.88	-13.00	15.88	0.0	vertical	horizontal	passed
peak	maxhold	3	823.9800	-15.98	-13.00	2.98	90.0	vertical	vertical	passed
peak	maxhold	3	823.9980	-16.09	-13.00	3.09	90.0	vertical	vertical	passed

no further values have been found with a margin of less than 20 dB

Test: 22.4; Frequency Band = 850, Mode = GSM, Channel = 190, Frequency = 836.6MHz

Result: Passed
Setup No.: S01_AS06
Date of Test: 2014/08/07 21:13
Body: FCC47CFRChIPART22PUBLIC MOBILE SERVICES
Test Specification: FCC part 2 and 22

Detailed Results:

detector	trace	resolution bandwidth /kHz	frequency /MHz	peak value /dBm	limit /dBm	margin to limit /dB	azimuth /°	antenna polarization	EUT orientation	verdict
peak	maxhold	1000	1309.0	-32.25	-13.00	19.25	60.0	vertical	horizontal	passed
peak	maxhold	1000	1388.4	-28.39	-13.00	15.39	60.0	vertical	horizontal	passed

no further values have been found with a margin of less than 20 dB

Test: 22.4; Frequency Band = 850, Mode = GSM, Channel = 251, Frequency = 848.8MHz

Result: Passed
Setup No.: S01_AS06
Date of Test: 2014/08/07 22:15
Body: FCC47CFRChIPART22PUBLIC MOBILE SERVICES
Test Specification: FCC part 2 and 22

Detailed Results:

detector	trace	resolution bandwidth /kHz	frequency /MHz	peak value /dBm	limit /dBm	margin to limit /dB	azimuth /°	antenna polarization	EUT orientation	verdict
peak	maxhold	3	849.0100	-23.60	-13.00	10.60	0.0	horizontal	vertical	passed
peak	maxhold	3	849.0220	-22.00	-13.00	9.00	0.0	horizontal	vertical	passed
peak	maxhold	3	849.0361	-25.68	-13.00	12.68	-90.0	horizontal	vertical	passed
peak	maxhold	3	849.0421	-24.80	-13.00	11.80	0.0	horizontal	vertical	passed
peak	maxhold	3	849.0461	-27.14	-13.00	14.14	-180.0	horizontal	horizontal	passed
peak	maxhold	3	849.0521	-30.06	-13.00	17.06	-90.0	horizontal	vertical	passed
peak	maxhold	3	849.0601	-30.25	-13.00	17.25	0.0	horizontal	vertical	passed
peak	maxhold	3	849.0661	-32.49	-13.00	19.49	-90.0	horizontal	vertical	passed

no further values have been found with a margin of less than 20 dB

Test: 22.4; Frequency Band = FDD5, Mode = HSDPA, Channel = 4132, Frequency = 826.4MHz

Result: Passed
Setup No.: S01_AS06
Date of Test: 2014/08/07 0:39
Body: FCC47CFRChIPART22PUBLIC MOBILE SERVICES
Test Specification: FCC part 2 and 22

Detailed Results:

detector	trace	resolution bandwidth /kHz	frequency /MHz	peak value /dBm	limit /dBm	margin to limit /dB	azimuth /°	antenna polarization	EUT orientation	verdict
peak	maxhold	100	820.89	-32.32	-13.00	19.32	90.0	vertical	vertical	passed
peak	maxhold	50	823.55	-29.77	-13.00	16.77	90.0	vertical	vertical	passed
peak	maxhold	50	823.79	-24.72	-13.00	11.72	90.0	vertical	vertical	passed
peak	maxhold	50	823.90	-28.28	-13.00	15.28	0.0	horizontal	vertical	passed
peak	maxhold	50	824.00	-22.75	-13.00	9.75	90.0	vertical	vertical	passed

no further values have been found with a margin of less than 20 dB

Test: 22.4; Frequency Band = FDD5, Mode = HSDPA, Channel = 4183, Frequency = 836.6MHz

Result: Passed
Setup No.: S01_AS06
Date of Test: 2014/08/07 0:39
Body: FCC47CFRChIPART22PUBLIC MOBILE SERVICES
Test Specification: FCC part 2 and 22

Detailed Results:

detector	trace	resolution bandwidth /kHz	frequency /MHz	peak value /dBm	limit /dBm	margin to limit /dB	azimuth /°	antenna polarization	EUT orientation	verdict
peak	maxhold	1000	880.4	-32.51	-13.00	19.51	-180.0	horizontal	horizontal	passed

no further values have been found with a margin of less than 20 dB

Test: 22.4; Frequency Band = FDD5, Mode = HSDPA, Channel = 4233, Frequency = 846.6MHz

Result: Passed
Setup No.: S01_AS06
Date of Test: 2014/08/07 0:39
Body: FCC47CFRChIPART22PUBLIC MOBILE SERVICES
Test Specification: FCC part 2 and 22

Detailed Results:

detector	trace	resolution bandwidth /kHz	frequency /MHz	peak value /dBm	limit /dBm	margin to limit /dB	azimuth /°	antenna polarization	EUT orientation	verdict
peak	maxhold	50	849.00	-24.50	-13.00	11.50	90.0	vertical	vertical	passed
peak	maxhold	50	849.49	-30.81	-13.00	17.81	90.0	vertical	vertical	passed

no further values have been found with a margin of less than 20 dB

Test: 22.4; Frequency Band = FDD5, Mode = HSUPA, Channel = 4132, Frequency = 826.4MHz

Result: Passed
Setup No.: S01_AS06
Date of Test: 2014/08/05 7:25
Body: FCC47CFRChIPART22PUBLIC MOBILE SERVICES
Test Specification: FCC part 2 and 22

Detailed Results:

detector	trace	resolution bandwidth /kHz	frequency /MHz	peak value /dBm	limit /dBm	margin to limit /dB	azimuth /°	antenna polarization	EUT orientation	verdict
peak	maxhold	1000	744.9	-31.81	-13.00	18.81	0.0	vertical	horizontal	passed

no further values have been found with a margin of less than 20 dB

Test: 22.4; Frequency Band = FDD5, Mode = HSUPA, Channel = 4183, Frequency = 836.6MHz

Result: Passed
Setup No.: S01_AS06
Date of Test: 2014/08/08 8:27
Body: FCC47CFRChIPART22PUBLIC MOBILE SERVICES
Test Specification: FCC part 2 and 22

Detailed Results:

detector	trace	resolution bandwidth /kHz	frequency /MHz	peak value /dBm	limit /dBm	margin to limit /dB	azimuth /°	antenna polarization	EUT orientation	verdict
peak	maxhold	1000	850.9	-42.44	-13.00	29.44	0.0	vertical	vertical	passed

no further values have been found with a margin of less than 20 dB

Test: 22.4; Frequency Band = FDD5, Mode = HSUPA, Channel = 4233, Frequency = 846.6MHz

Result: Passed
Setup No.: S01_AS06
Date of Test: 2014/08/08 9:04
Body: FCC47CFRChIPART22PUBLIC MOBILE SERVICES
Test Specification: FCC part 2 and 22

Detailed Results:

detector	trace	resolution bandwidth /kHz	frequency /MHz	peak value /dBm	limit /dBm	margin to limit /dB	azimuth /°	antenna polarization	EUT orientation	verdict
peak	maxhold	1000	505.2	-32.72	-13.00	19.72	0.0	horizontal	vertical	passed
peak	maxhold	1000	1632.5	-30.31	-13.00	17.31	0.0	vertical	horizontal	passed
peak	maxhold	1000	1686.6	-27.43	-13.00	14.43	0.0	vertical	horizontal	passed
peak	maxhold	1000	1719.0	-32.41	-13.00	19.41	0.0	vertical	horizontal	passed
peak	maxhold	1000	2108.6	-31.50	-13.00	18.50	0.0	vertical	horizontal	passed

no further values have been found with a margin of less than 20 dB

Test: 22.4; Frequency Band = FDD5, Mode = W-CDMA, Channel = 4132, Frequency = 826.4MHz

Result: Passed
Setup No.: S01_AS06
Date of Test: 2014/08/08 6:17
Body: FCC47CFRChIPART22PUBLIC MOBILE SERVICES
Test Specification: FCC part 2 and 22

Detailed Results:

detector	trace	resolution bandwidth /kHz	frequency /MHz	peak value /dBm	limit /dBm	margin to limit /dB	azimuth /°	antenna polarization	EUT orientation	verdict
peak	maxhold	50	824.00	-39.05	-13.00	26.05	-180.0	vertical	vertical	passed

no further values have been found with a margin of less than 20 dB

Test: 22.4; Frequency Band = FDD5, Mode = W-CDMA, Channel = 4183, Frequency = 836.6MHz

Result: Passed
Setup No.: S01_AS06
Date of Test: 2014/08/08 4:16
Body: FCC47CFRChIPART22PUBLIC MOBILE SERVICES
Test Specification: FCC part 2 and 22

Detailed Results:

detector	trace	resolution bandwidth /kHz	frequency /MHz	peak value /dBm	limit /dBm	margin to limit /dB	azimuth /°	antenna polarization	EUT orientation	verdict
peak	maxhold	1000	50.7	-43.66	-13.00	30.66	90.0	vertical	vertical	passed

no further values have been found with a margin of less than 20 dB

Test: 22.4; Frequency Band = FDD5, Mode = W-CDMA, Channel = 4233, Frequency = 846.6MHz

Result: Passed
Setup No.: S01_AS06
Date of Test: 2014/08/08 7:18
Body: FCC47CFRChIPART22PUBLIC MOBILE SERVICES
Test Specification: FCC part 2 and 22

Detailed Results:

detector	trace	resolution bandwidth /kHz	frequency /MHz	peak value /dBm	limit /dBm	margin to limit /dB	azimuth /°	antenna polarization	EUT orientation	verdict
peak	maxhold	50	849.00	-41.78	-13.00	28.78	-180.0	vertical	vertical	passed

no further values have been found with a margin of less than 20 dB

3.5.5 22.5 Emission and Occupied Bandwidth §2.1049, §22.917

Test: 22.5; Emission and Occupied Bandwidth Summary §2.1049, §22.917

<i>Result:</i>	Passed
<i>Setup No.:</i>	S01_AS06
<i>Date of Test:</i>	2014/07/14 12:02
<i>Body:</i>	FCC47CFRChIPART22PUBLIC MOBILE SERVICES
<i>Test Specification:</i>	FCC part 2 and 22

Detailed Results:

Band	Mode	Channel	-26dB BW KHz	99% BW /KHz	Verdict
850	GSM	128	308.6	242.5	Passed
		190	304.6	242.5	Passed
		251	310.6	242.5	Passed
	EDGE	128	302.6	252.5	Passed
		190	308.6	246.5	Passed
		251	308.6	244.5	Passed
FDD 5	UMTS	4132	4729.5	4148.3	Passed
		4183	4729.5	4148.3	Passed
		4233	4709.4	4128.3	Passed
	HSUPA	4132	4729.5	4148.3	Passed
		4183	4749.5	4148.3	Passed
		4233	4749.5	4128.3	Passed
	HSDPA	4132	4729.5	4108.2	Passed
		4183	4729.5	4148.3	Passed
		4233	4729.5	4128.3	Passed

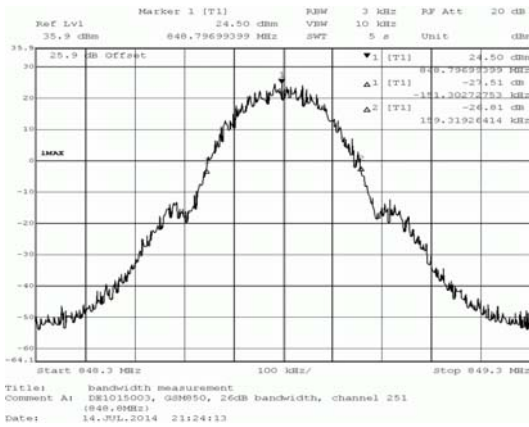

GSM 850 Band

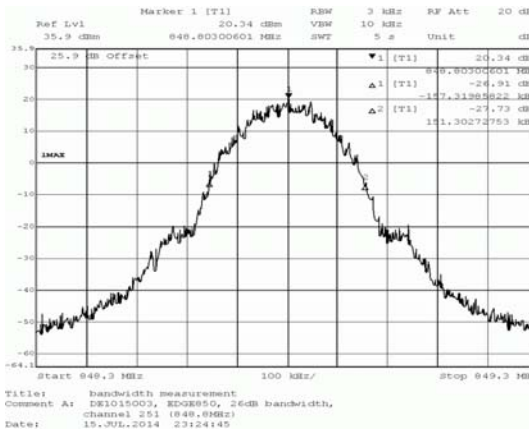
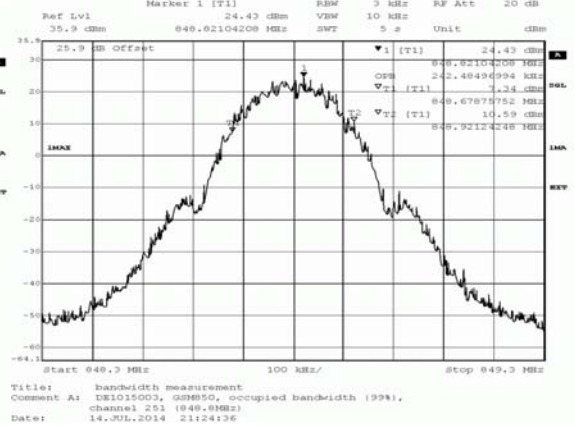

EGDE 850 Band

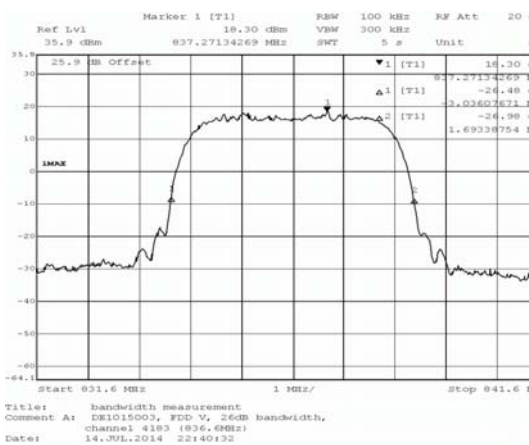
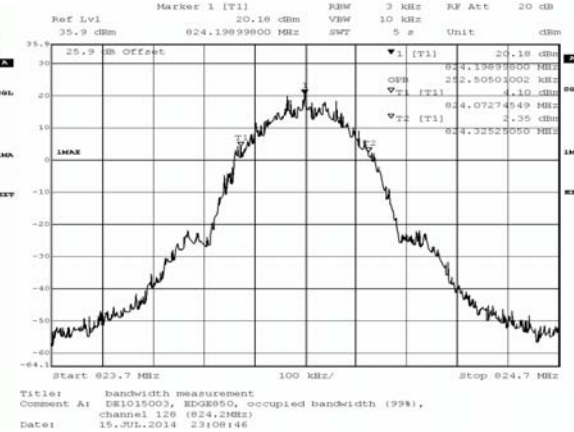

HSDPA FDD5 Band

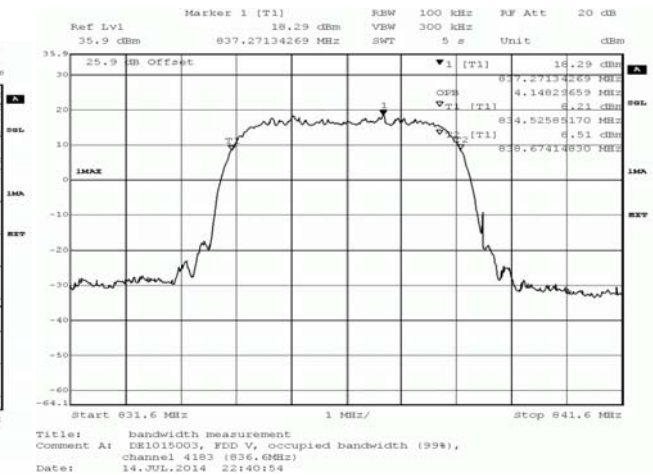

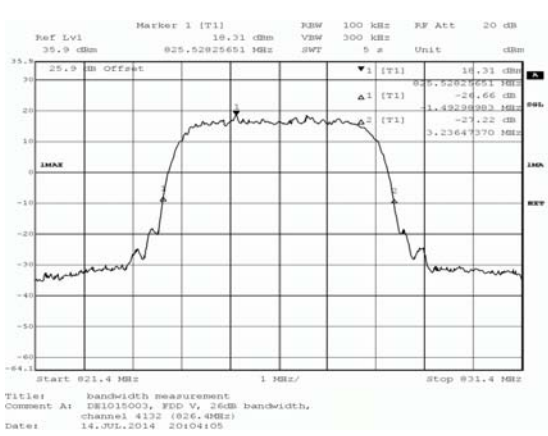

UMTS FDD5 Band

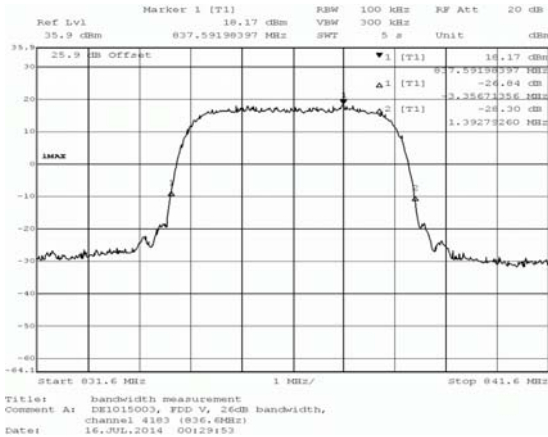
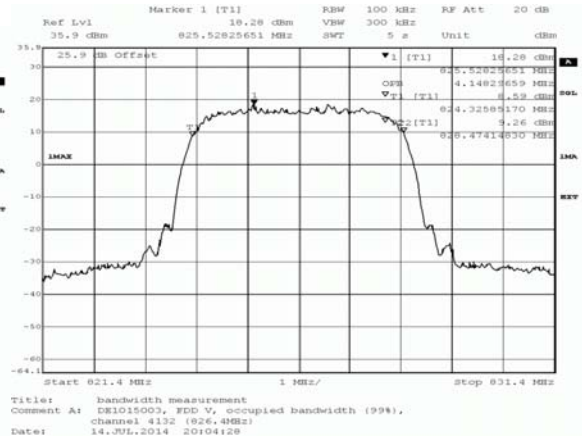

HSPA FDD5 Band

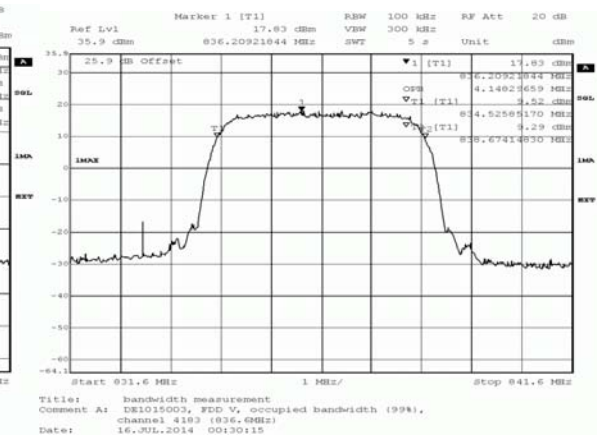

3.5.6 22.6 Band edge compliance §2.1053, §22.917

Test: 22.6; Band edge compliance Summary §2.1053, §22.917

<i>Result:</i>	Passed
<i>Setup No.:</i>	S01_AS06
<i>Date of Test:</i>	2014/07/14 13:26
<i>Body:</i>	FCC47CFRChIPART22PUBLIC MOBILE SERVICES
<i>Test Specification:</i>	FCC part 2 and 22

Detailed Results:

Band	Modulation	Mode	Detector	Frequency (MHZ)	peak value /dBm	margin to limit /dB	limit /dBm	Verdict
850	GFSK	GSM / GPRS	peak	823.985	-16.10	3.10	-13.0	passed
			average	823.985	-35.06	22.06	-13.0	passed
			rms	823.985	-26.41	13.41	-13.0	passed
			peak	849.026	-15.63	2.63	-13.0	passed
			average	849.015	-35.58	22.58	-13.0	passed
			rms	849.021	-27.84	14.84	-13.0	passed
850	8PSK	EDGE	peak	823.974	-24.24	11.24	-13.0	passed
			average	823.988	-42.76	29.76	-13.0	passed
			rms	823.971	-36.14	23.14	-13.0	passed
			peak	849.004	-23.88	10.88	-13.0	passed
			peak	849.035	-22.59	9.59	-13.0	passed
			peak	849.057	-27.80	14.80	-13.0	passed
			peak	849.069	-29.59	16.59	-13.0	passed
			average	849.004	-42.76	29.76	-13.0	passed
rms	849.004	-33.22	20.22	-13.0	passed			

Band	Modulation	Mode	Detector	Frequency (MHZ)	peak value /dBm	margin to limit /dB	limit /dBm	Verdict
FDD 5	QPSK	W-CDMA	peak	823.488	-28.44	15.44	-13.0	passed
			peak	823.837	-22.63	9.63	-13.0	passed
			peak	824.000	-18.01	5.01	-13.0	passed
			average	824.000	-27.62	14.62	-13.0	passed
			rms	823.814	-31.37	18.37	-13.0	passed
			rms	824.000	-26.80	13.80	-13.0	passed
			peak	849.000	-19.58	6.58	-13.0	passed
			peak	849.152	-23.92	10.92	-13.0	passed
			peak	849.465	-28.54	15.54	-13.0	passed
			average	849.000	-29.56	16.56	-13.0	passed
			rms	849.000	-28.78	15.78	-13.0	passed
			HSDPA	peak	823.477	-28.44	15.44	-13.0
		peak		823.779	-22.32	9.32	-13.0	Pass
		peak		824.000	-19.20	6.20	-13.0	Pass
		average		823.802	-32.43	19.43	-13.0	Pass
		average		824.000	-27.84	14.84	-13.0	Pass
		rms		823.814	-31.71	18.71	-13.0	Pass
		rms		824.000	-27.00	14.00	-13.0	Pass
		peak		849.000	-18.40	5.40	-13.0	Pass
		peak		849.489	-28.07	15.07	-13.0	Pass
		average		849.000	-29.04	16.04	-13.0	Pass
		rms		849.000	-28.30	15.30	-13.0	Pass
		HSUPA		peak	823.500	-27.21	14.21	-13.0
			peak	823.848	-23.91	10.91	-13.0	passed
			peak	824.000	-19.05	6.05	-13.0	passed
			average	824.000	-27.84	14.84	-13.0	passed
			rms	824.000	-27.20	14.20	-13.0	passed
			peak	849.000	-19.04	6.04	-13.0	passed
			average	849.000	-28.07	15.07	-13.0	passed
			rms	849.000	-27.62	14.62	-13.0	passed

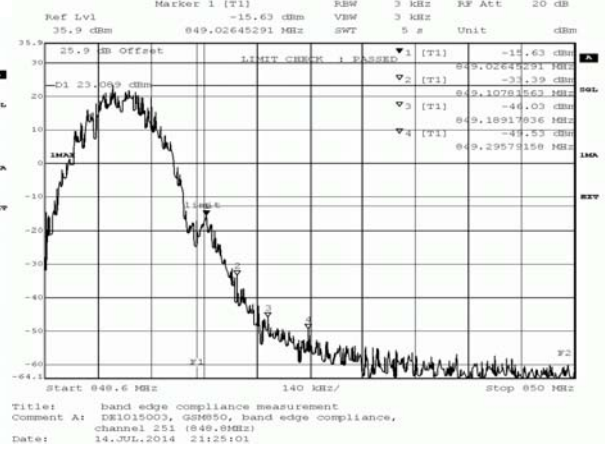
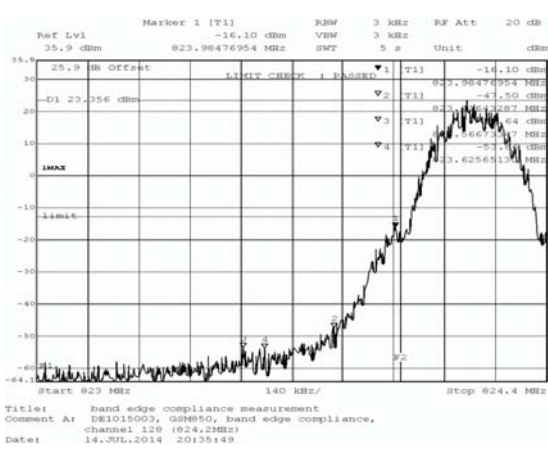

GSM 850 Band

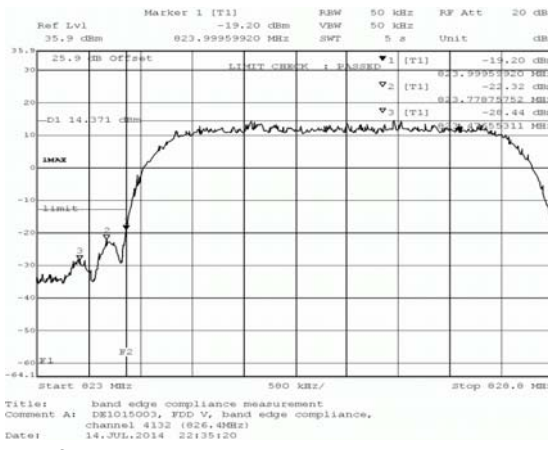

UMTS FDD5

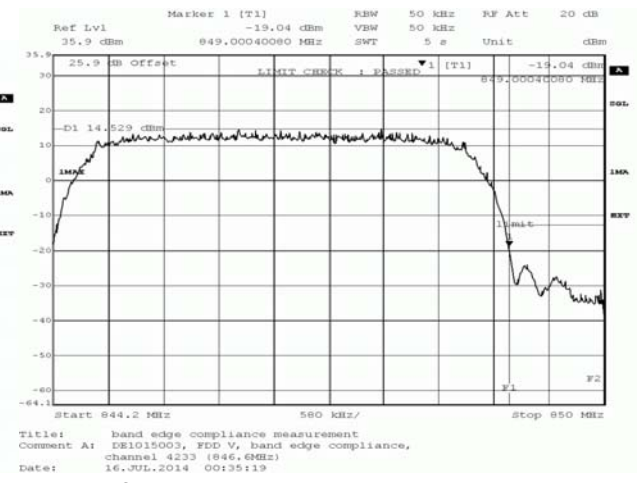

HSUPA FDD5

3.5.7 24.1 RF Power Output §2.1046, §24.232

Test: 24.1; RF Power Output Summary §2.1046, §24.232

<i>Result:</i>	Passed
<i>Setup No.:</i>	S01_AS06
<i>Date of Test:</i>	2014/08/20 11:44
<i>Body:</i>	FCC47CFRChIPART24PERSONAL COMMUNICATIONS SERVICES
<i>Test Specification:</i>	FCC part 2 and 24

Detailed Results:

Band	Mode	Modulation	Channel	Frequency (MHz)	Peak Conducted power	Average Conducted power	RMS Conducted power	FCC EIRP limit (W)	IC EIRP limit per SRSP-503 (W)	Maximum antenna gain (dBi)	Verdict
1900	GSM/GPRS	GFSK	Low	1850.2	29.43	29.43	29.43	2	2	3.57	Pass
			Mid	1880	29.42	29.42	29.42			3.58	Pass
			High	1909.8	29.73	29.73	29.73			3.27	Pass
1900	EDGE	8PSK	Low	1850.2	29.63	25.71	26.2	2	2	6.8	Pass
			Mid	1880	29.38	25.51	25.92			7.08	Pass
			High	1909.8	28.97	24.92	25.44			7.56	Pass
Band	Mode	Modulation	Channel	Frequency (MHz)	Peak Conducted power	Average Conducted power	RSM Conducted power	FCC EIRP limit (W)	IC EIRP limit per SRSP-503 (W)	Maximum antenna gain (dBi)	Verdict
FDD 2	W-CDMA	QPSK	Low	1852.4	27.01	21.58	21.78	2	2	11.22	Pass
			Mid	1880	26.75	21.34	21.55			11.45	Pass
			High	1907.6	26.88	21.32	21.53			11.47	Pass
FDD 2	HSDPA Subtest 1	QPSK	Low	1852.4	27.01	21.59	21.81	2	2	11.19	Pass
			Mid	1880	26.75	21.36	21.58			11.42	Pass
			High	1907.6	27.01	21.28	21.51			11.49	Pass
FDD 2	HSDPA Subtest 2	QPSK	Low	1852.4	28.59	20.07	20.76	2	2	12.24	Pass
			Mid	1880	27.97	19.78	20.41			12.59	Pass
			High	1907.6	27.81	19.74	20.38			12.62	Pass
FDD 2	HSDPA Subtest 3	QPSK	Low	1852.4	28.09	19.01	19.98	2	2	13.02	Pass
			Mid	1880	27.68	18.68	19.73			13.27	Pass
			High	1907.6	27.68	18.59	19.62			13.38	Pass
FDD 2	HSDPA Subtest 4	QPSK	Low	1852.4	27.81	18.77	19.92	2	2	13.08	Pass
			Mid	1880	28.22	18.68	19.74			13.26	Pass
			High	1907.6	27.97	18.23	19.54			13.46	Pass
FDD 2	HSUPA Subtest 1	QPSK	Low	1852.4	28.22	20.87	21.26	2	2	11.74	Pass
			Mid	1880	28.22	21.09	21.48			11.52	Pass
			High	1907.6	28.34	21.02	21.42			11.58	Pass
FDD 2	HSUPA Subtest 2	QPSK	Low	1852.4	28.34	18.74	19.73	2	2	13.27	Pass
			Mid	1880	27.97	18.51	19.54			13.46	Pass
			High	1907.6	28.22	18.39	19.38			13.62	Pass
FDD 2	HSUPA Subtest 3	QPSK	Low	1852.4	29.05	20.05	20.86	2	2	12.14	Pass
			Mid	1880	28.43	19.61	20.4			12.6	Pass
			High	1907.6	28.8	19.64	20.45			12.55	Pass
FDD 2	HSUPA Subtest 4	QPSK	Low	1852.4	28.93	19.4	20.65	2	2	12.35	Pass
			Mid	1880	28.43	19.16	20.4			12.6	Pass
			High	1907.6	28.68	18.97	20.21			12.79	Pass
FDD 2	HSUPA Subtest 5	QPSK	Low	1852.4	28.16	21.12	21.5	2	2	11.5	Pass
			Mid	1880	27.77	20.74	21.08			11.92	Pass
			High	1907.6	27.62	20.67	21.04			11.96	Pass

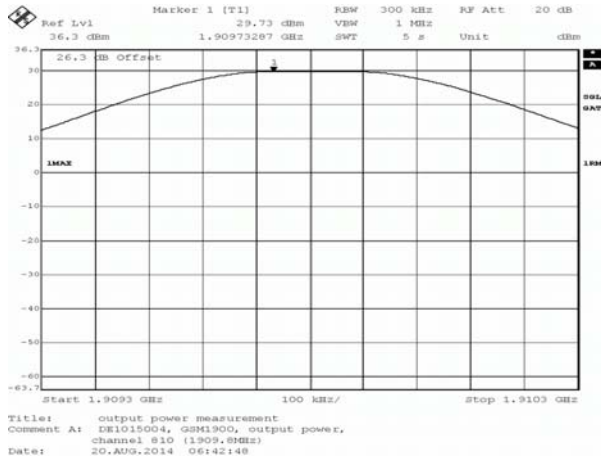

GSM 1900 Band

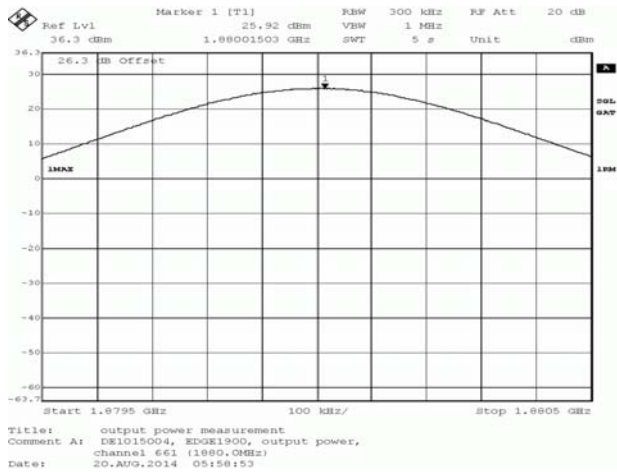

EGDE 1900 Band

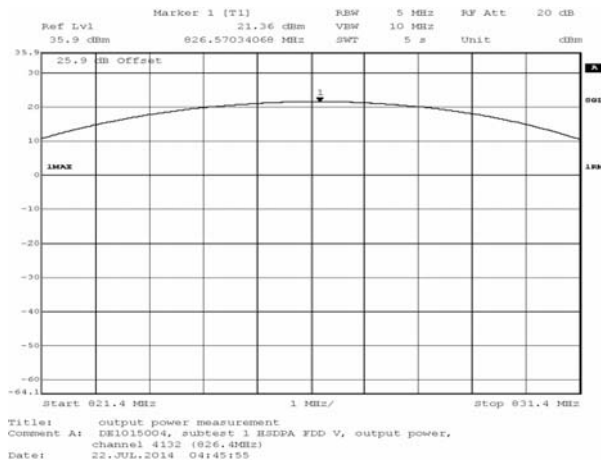

HSDPA FDD2

3.5.8 24.2 Frequency stability §2.1055, §24.235

Test: 24.2; Frequency stability Summary §2.1055, 24.235

<i>Result:</i>	Passed
<i>Setup No.:</i>	S01_AS06
<i>Date of Test:</i>	2014/08/18 11:51
<i>Body:</i>	FCC47CFRChIPART24PERSONAL COMMUNICATIONS SERVICES
<i>Test Specification:</i>	FCC part 2 and 24

Detailed Results:

24.2: Frequency stability §2.1055, §24.235, GSM 1900, Channel 661

Temp. °C	Duration min	Voltage	Limit Hz	Freq. error Average (Hz)	Freq. error Max. (Hz)	Verdict	Tested sample
-30	0	normal	4700	-23	-48	passed	ax06
-30	5			-6	-31	passed	ax06
-30	10			-14	-48	passed	ax06
-20	0	normal	4700	-14	-41	passed	ax06
-20	5			-7	-32	passed	ax06
-20	10			-12	-29	passed	ax06
-10	0	normal	4700	3	34	passed	ax06
-10	5			-11	-54	passed	ax06
-10	10			-14	-56	passed	ax06
0	0	normal	4700	-5	-54	passed	ax06
0	5			-22	-45	passed	ax06
0	10			-18	-60	passed	ax06
10	0	normal	4700	-18	-50	passed	ax06
10	5			-21	-49	passed	ax06
10	10			-20	-57	passed	ax06
20	0	low	4700	-8	-28	passed	an07
20	5			-24	-51	passed	an07
20	10			-18	-49	passed	an07
20	0	normal = high ¹⁾	4700	3	34	passed	ax05
20	5			5	29	passed	ax05
20	10			2	26	passed	ax05
20	0	high	4700	7	29	passed	an07
20	5			-2	-26	passed	an07
20	10			-16	-39	passed	an07
30	0	normal	4700	12	40	passed	ax05
30	5			4	27	passed	ax05
30	10			0	29	passed	ax05
40	0	normal	4700	16	42	passed	ax05
40	5			0	-32	passed	ax05
40	10			6	32	passed	ax05
50	0	normal	4700	-10	-39	passed	ax05
50	5			2	25	passed	ax05
50	10			9	40	passed	ax05

1) The manufacturer declared that normal voltage is equivalent with high voltage.

2) The manufacturer declared that low voltage value of 3.3v.

24.2: Frequency stability §2.1055, §24.235, UMTS FDD2, Channel 9400

Temp. °C	Duration min	Voltage	Limit Hz	Freq. error Average (Hz)	Freq. error Max. (Hz)	Verdict	Tested Sample
-30	0	normal	4700	-8	-16	passed	ax06
-30	5			-2	-9	passed	ax06
-30	10			-4	-11	passed	ax06
-20	0	normal	4700	5	14	passed	ax06
-20	5			1	-9	passed	ax06
-20	10			0	10	passed	ax06
-10	0	normal	4700	-2	153	passed	ax06
-10	5			-8	141	passed	ax06
-10	10			-4	114	passed	ax06
0	0	normal	4700	-4	140	passed	ax06
0	5			-4	148	passed	ax06
0	10			-7	142	passed	ax06
10	0	normal	4700	-5	-11	passed	ax06
10	5			-4	152	passed	ax06
10	10			-8	142	passed	ax06
20	0	low	4700	4	16	passed	an07
20	5			1	-7	passed	an07
20	10			-4	-10	passed	an07
20	0	normal = high ¹⁾	4700	-6	-14	passed	ax06
20	5			4	9	passed	ax06
20	10			-4	-11	passed	ax06
20	0	high	4700	3	11	passed	an07
20	5			-7	-14	passed	an07
20	10			0	-8	passed	an07
30	0	normal	4700	-4	-11	passed	ax06
30	5			-6	-12	passed	ax06
30	10			-6	-15	passed	ax06
40	0	normal	4700	-2	-11	passed	ax06
40	5			-4	-10	passed	ax06
40	10			-6	-15	passed	ax06
50	0	normal	4700	-5	-14	passed	ax06
50	5			-1	-12	passed	ax06
50	10			-2	-6	passed	ax06

- 1) The manufacturer declared that normal voltage is equivalent with high voltage.
- 2) The manufacturer declared that low voltage value of 3.3v.

3.5.9 24.3 Spurious emissions at antenna terminals §2.1051, §24.238

Test: 24.3; Spurious emissions at antenna terminals Summary §2.1051, §24.238

<i>Result:</i>	Passed
<i>Setup No.:</i>	S01_AS06
<i>Date of Test:</i>	2014/07/20 13:57
<i>Body:</i>	FCC47CFRChIPART24PERSONAL COMMUNICATIONS SERVICES
<i>Test Specification:</i>	FCC part 2 and 24

Detailed Results:

Spurious emissions at antenna terminals §2.1051, §24.238											
Mode / Band	Channel	detector	trace	resolution bandwidth /kHz	frequency /MHz	peak value /dBm	margin to limit /dB	limit /dBm	verdict		
GSM/1900	512	peak	maxhold	1	0.0104	-31.8	18.8	-13.0	passed		
		peak	maxhold	1000	1617.8	-30.7	17.7	-13.0	passed		
		peak	maxhold	100	1848.24	-29.6	16.6	-13.0	passed		
		peak	maxhold	1000	1919.7	-32.1	19.1	-13.0	passed		
		peak	maxhold	1000	4026.1	-30.7	17.7	-13.0	passed		
		peak	maxhold	1000	6984.0	-26.8	13.8	-13.0	passed		
		peak	maxhold	1000	10160.3	-28.1	15.1	-13.0	passed		
	661	peak	maxhold	1000	18927.9	-25.6	12.6	-13.0	passed		
		peak	maxhold	1	0.000	-30.9	17.9	-13	passed		
		peak	maxhold	1000	1.754	-31.3	18.3	-13	passed		
		peak	maxhold	1000	4.375	-31	18	-13	passed		
		peak	maxhold	1000	6.994	-27	14	-13	passed		
		peak	maxhold	1000	11.182	-28.6	15.6	-13	passed		
		peak	maxhold	1000	18.878	-25.6	12.6	-13	passed		
	810	peak	maxhold	1	0.000	-32.6	19.6	-13	passed		
		peak	maxhold	1	0.000	-29.2	16.2	-13	passed		
		peak	maxhold	1	0.000	-32.3	19.3	-13	passed		
		peak	maxhold	1000	1.757	-30.7	17.7	-13	passed		
		peak	maxhold	100	1.916	-30	17	-13	passed		
		peak	maxhold	1000	1.925	-33	20	-13	passed		
		peak	maxhold	1000	2.415	-30.3	17.3	-13	passed		
		peak	maxhold	1000	6.603	-26.2	13.2	-13	passed		
		peak	maxhold	1000	14.780	-27.9	14.9	-13	passed		
		peak	maxhold	1000	18.898	-25.9	12.9	-13	passed		
		EGPRS/1900	512	peak	maxhold	1	0.000	-31.4	18.4	-13	passed
				peak	maxhold	1	0.000	-31.7	18.7	-13	passed
				peak	maxhold	1	0.000	-31.7	18.7	-13	passed
				peak	maxhold	1000	1.630	-31.2	18.2	-13	passed
peak	maxhold			100	1.844	-29.8	16.8	-13	passed		
peak	maxhold			3	1.850	-31	18	-13	passed		
peak	maxhold			1000	1.946	-32.5	19.5	-13	passed		
peak	maxhold			1000	3.677	-30	17	-13	passed		
peak	maxhold			1000	6.994	-26.8	13.8	-13	passed		
peak	maxhold			1000	12384.8	-28.1	15.1	-13	passed		
661	peak		maxhold	1000	18927.9	-25	12	-13	passed		
	peak		maxhold	1	0.0101	-30.8	17.8	-13.0	passed		
	peak		maxhold	1	0.0105	-31.3	18.3	-13.0	passed		
	peak		maxhold	1	0.0111	-32.6	19.6	-13.0	passed		
	peak		maxhold	1	0.0143	-33.0	20.0	-13.0	passed		
	peak		maxhold	1	0.0248	-32.4	19.4	-13.0	passed		
	peak		maxhold	1000	1779.2	-31.3	18.3	-13.0	passed		
	peak		maxhold	1000	1930.3	-32.2	19.2	-13.0	passed		
	peak		maxhold	1000	3899.8	-30.2	17.2	-13.0	passed		
	peak		maxhold	1000	6994.0	-26.2	13.2	-13.0	passed		
810	peak	maxhold	1000	14799.6	-28.1	15.1	-13.0	passed			
	peak	maxhold	1000	18937.9	-24.5	11.5	-13.0	passed			
	peak	maxhold	1	0.0091	-32.4	19.4	-13.0	passed			
	peak	maxhold	1	0.0102	-32.1	19.1	-13.0	passed			
	peak	maxhold	1	0.0113	-32.8	19.8	-13.0	passed			
	peak	maxhold	1	0.0116	-33.0	20.0	-13.0	passed			
	peak	maxhold	1000	1604.0	-31.2	18.2	-13.0	passed			
	peak	maxhold	100	1918.79	-29.3	16.3	-13.0	passed			
	peak	maxhold	1000	1999.8	-32.4	19.4	-13.0	passed			
	peak	maxhold	1000	2426.9	-30.2	17.2	-13.0	passed			
peak	maxhold	1000	6984.0	-26.3	13.3	-13.0	passed				
peak	maxhold	1000	10581.2	-27.8	14.8	-13.0	passed				
peak	maxhold	1000	18907.8	-25.3	12.3	-13.0	passed				

Spurious emissions at antenna terminals §2.1051, §24.238									
Mode / Band	Channel	detector	trace	resolution bandwidth /kHz	frequency /MHz	peak value /dBm	margin to limit /dB	limit /dBm	verdict
UMTS / FDD2	9262	peak	maxhold	1	0.0104	-31.9	18.9	-13	passed
		peak	maxhold	1	0.0112	-32.4	19.4	-13	passed
		peak	maxhold	1	0.0117	-32.8	19.8	-13	passed
		peak	maxhold	1	0.0131	-33	20	-13	passed
		peak	maxhold	1000	1752.5	-31.9	18.9	-13	passed
		peak	maxhold	100	1848.51	-25.2	12.2	-13	passed
		peak	maxhold	50	1850	-26.8	13.8	-13	passed
		peak	maxhold	1000	4537.1	-31.1	18.1	-13	passed
		peak	maxhold	1000	6973.9	-27.1	14.1	-13	passed
		peak	maxhold	1000	12535.1	-29.1	16.1	-13	passed
	peak	maxhold	1000	18927.9	-26.2	13.2	-13	passed	
	9400	peak	maxhold	1	0.0101	-32.1	19.1	-13	passed
		peak	maxhold	1	0.0109	-32.3	19.3	-13	passed
		peak	maxhold	1000	1634.6	-31.5	18.5	-13	passed
		peak	maxhold	1000	1959.7	-32.8	19.8	-13	passed
		peak	maxhold	1000	3851.7	-30.9	17.9	-13	passed
		peak	maxhold	1000	6984	-27.6	14.6	-13	passed
		peak	maxhold	1000	11242.5	-28.6	15.6	-13	passed
		peak	maxhold	1000	18927.9	-26.3	13.3	-13	passed
	9538	peak	maxhold	1	0.01	-32.2	19.2	-13	passed
		peak	maxhold	1	0.0105	-31.1	18.1	-13	passed
		peak	maxhold	1000	1762.2	-31.6	18.6	-13	passed
		peak	maxhold	50	1910	-28.1	15.1	-13	passed
		peak	maxhold	100	1911.09	-21.3	8.3	-13	passed
		peak	maxhold	1000	1990.9	-32.7	19.7	-13	passed
		peak	maxhold	1000	4326.7	-30.7	17.7	-13	passed
		peak	maxhold	1000	6973.9	-26.5	13.5	-13	passed
	peak	maxhold	1000	12434.9	-29.2	16.2	-13	passed	
	peak	maxhold	1000	18917.8	-26	13	-13	passed	
	HSUPA / FDD2	9262	peak	maxhold	1	0.0116	-32.4	19.4	-13
peak			maxhold	1000	1619.5	-31.9	18.9	-13	passed
peak			maxhold	1000	1959	-31.9	18.9	-13	passed
peak			maxhold	1000	3659.3	-30.4	17.4	-13	passed
peak			maxhold	1000	6953.9	-27.1	14.1	-13	passed
peak			maxhold	1000	11092.2	-28.4	15.4	-13	passed
peak		maxhold	1000	18937.9	-26.3	13.3	-13	passed	
9400		peak	maxhold	1	0.0091	-32.9	19.9	-13	passed
		peak	maxhold	1	0.0108	-30.8	17.8	-13	passed
		peak	maxhold	1	0.0126	-32.5	19.5	-13	passed
		peak	maxhold	1	0.0296	-32.5	19.5	-13	passed
		peak	maxhold	1000	1748.6	-30.9	17.9	-13	passed
		peak	maxhold	1000	1959.2	-32.4	19.4	-13	passed
		peak	maxhold	1000	2913.8	-30.8	17.8	-13	passed
		peak	maxhold	1000	6984	-26.8	13.8	-13	passed
9538		peak	maxhold	1000	10180.4	-27.9	14.9	-13	passed
		peak	maxhold	1000	18917.8	-26.1	13.1	-13	passed
		peak	maxhold	1	0.0097	-32.9	19.9	-13	passed
		peak	maxhold	1	0.0108	-32.3	19.3	-13	passed
		peak	maxhold	3	0.0346	-33	20	-13	passed
		peak	maxhold	1000	1619.3	-31.2	18.2	-13	passed
		rms	maxhold	50	1910	-25.5	12.5	-13	passed
		rms	maxhold	100	1911	-20.3	7.3	-13	passed
		peak	maxhold	1000	1988.9	-31.7	18.7	-13	passed
	peak	maxhold	1000	3935.9	-30.9	17.9	-13	passed	
peak	maxhold	1000	6984	-27	14	-13	passed		
peak	maxhold	1000	10571.1	-27.9	14.9	-13	passed		
peak	maxhold	1000	18907.8	-25.8	12.8	-13	passed		

Spurious emissions at antenna terminals §2.1051, §24.238									
Mode / Band	Channel	detector	trace	resolution bandwidth /kHz	frequency /MHz	peak value /dBm	margin to limit /dB	limit /dBm	verdict
HSDPA / FDD2	9262	peak	maxhold	1	0.0092	-31.9	18.9	-13	passed
		peak	maxhold	1	0.0107	-32.2	19.2	-13	passed
		peak	maxhold	1	0.0108	-32.4	19.4	-13	passed
		peak	maxhold	3	0.0426	-32.7	19.7	-13	passed
		peak	maxhold	1000	1506.7	-31.8	18.8	-13	passed
		rms	maxhold	100	1848.69	-25.7	12.7	-13	passed
		rms	maxhold	50	1850	-26.6	13.6	-13	passed
		peak	maxhold	1000	1933.5	-16.2	3.2	-13	passed
		peak	maxhold	1000	4825.7	-30.9	17.9	-13	passed
		peak	maxhold	1000	6984	-27.3	14.3	-13	passed
	peak	maxhold	1000	11913.8	-29.3	16.3	-13	passed	
	9400	peak	maxhold	1000	18887.8	-26.2	13.2	-13	passed
		peak	maxhold	1	0.0113	-32.8	19.8	-13	passed
		peak	maxhold	1000	1774.1	-31.2	18.2	-13	passed
		peak	maxhold	1000	1961.3	-16.4	3.4	-13	passed
		peak	maxhold	1000	4609.2	-30.6	17.6	-13	passed
		peak	maxhold	1000	6623.2	-27.2	14.2	-13	passed
		peak	maxhold	1000	11122.2	-29.1	16.1	-13	passed
	9538	peak	maxhold	1000	18907.8	-26.4	13.4	-13	passed
		peak	maxhold	1	0.0103	-32.3	19.3	-13	passed
		peak	maxhold	1	0.0105	-32.1	19.1	-13	passed
		peak	maxhold	1	0.0108	-31.7	18.7	-13	passed
		peak	maxhold	1	0.0112	-32.7	19.7	-13	passed
		peak	maxhold	1000	1595.5	-32.1	19.1	-13	passed
		rms	maxhold	50	1910	-27.9	14.9	-13	passed
		rms	maxhold	100	1911.32	-22	9	-13	passed
		peak	maxhold	1000	1988.6	-15.9	2.9	-13	passed
		peak	maxhold	1000	4392.8	-30.6	17.6	-13	passed
		peak	maxhold	1000	6994	-26.9	13.9	-13	passed
		peak	maxhold	1000	10581.2	-28.8	15.8	-13	passed
	peak	maxhold	1000	18917.8	-26.2	13.2	-13	passed	

3.5.10 24.4 Field strength of spurious radiation §2.1053, §24.238

Test: 24.4; Frequency Band = 1900, Mode = EDGE, Channel = 512, Frequency = 1850.2MHz

Result: Passed
Setup No.: S01_AS06
Date of Test: 2014/08/08 23:00
Body: FCC47CFRChIPART24PERSONAL COMMUNICATIONS SERVICES
Test Specification: FCC part 2 and 24

Detailed Results:

detector	trace	resolution bandwidth /kHz	frequency /MHz	peak value /dBm	limit /dBm	margin to limit /dB	azimuth /°	antenna polarization	EUT orientation	verdict
peak	maxhold	3	1849.9619	-37.31	-13.00	24.31	-135.0	vertical	vertical	passed

no further values have been found with a margin of less than 20 dB

Test: 24.4; Frequency Band = 1900, Mode = EDGE, Channel = 661, Frequency = 1880.0MHz

Result: Passed
Setup No.: S01_AS06
Date of Test: 2014/08/08 23:01
Body: FCC47CFRChIPART24PERSONAL COMMUNICATIONS SERVICES
Test Specification: FCC part 2 and 24

Detailed Results:

detector	trace	resolution bandwidth /kHz	frequency /MHz	peak value /dBm	limit /dBm	margin to limit /dB	azimuth /°	antenna polarization	EUT orientation	verdict
peak	maxhold	1000	1542.7	-41.28	-13.00	28.28	-90.0	horizontal	vertical	passed

no further values have been found with a margin of less than 20 dB

Test: 24.4; Frequency Band = 1900, Mode = EDGE, Channel = 810, Frequency = 1909.8MHz

Result: Passed
Setup No.: S01_AS06
Date of Test: 2014/08/08 22:58
Body: FCC47CFRChIPART24PERSONAL COMMUNICATIONS SERVICES
Test Specification: FCC part 2 and 24

Detailed Results:

detector	trace	resolution bandwidth /kHz	frequency /MHz	peak value /dBm	limit /dBm	margin to limit /dB	azimuth /°	antenna polarization	EUT orientation	verdict
peak	maxhold	1000	1059.5	-32.36	-13.00	19.36	-180.0	vertical	vertical	passed
peak	maxhold	1000	1064.7	-32.35	-13.00	19.35	-180.0	vertical	vertical	passed
peak	maxhold	1000	1073.2	-32.16	-13.00	19.16	-180.0	vertical	vertical	passed
peak	maxhold	1000	1090.2	-30.94	-13.00	17.94	-180.0	vertical	vertical	passed
peak	maxhold	1000	1114.0	-26.74	-13.00	13.74	-180.0	vertical	vertical	passed
peak	maxhold	1000	1134.4	-31.79	-13.00	18.79	-180.0	vertical	vertical	passed
peak	maxhold	1000	1139.5	-32.79	-13.00	19.79	-180.0	vertical	vertical	passed
peak	maxhold	1000	1200.8	-29.16	-13.00	16.16	-180.0	vertical	vertical	passed
peak	maxhold	1000	1228.0	-27.70	-13.00	14.70	-180.0	vertical	vertical	passed

no further values have been found with a margin of less than 20 dB

Test: 24.4; Frequency Band = 1900, Mode = GSM, Channel = 512, Frequency = 1850.2MHz

Result: Passed

Setup No.: S01_AS06

Date of Test: 2014/08/06 1:57

Body: FCC47CFRChIPART24PERSONAL COMMUNICATIONS SERVICES

Test Specification: FCC part 2 and 24

Detailed Results:

detector	trace	resolution bandwidth /kHz	frequency /MHz	peak value /dBm	limit /dBm	margin to limit /dB	azimuth /°	antenna polarization	EUT orientation	verdict
peak	maxhold	1000	1013.5	-22.37	-13.00	9.37	-180.0	vertical	vertical	passed
peak	maxhold	1000	1117.8	-32.22	-13.00	19.22	-180.0	vertical	vertical	passed
peak	maxhold	1000	1127.9	-25.35	-13.00	12.35	-180.0	vertical	vertical	passed
peak	maxhold	1000	1141.4	-26.43	-13.00	13.43	-180.0	vertical	vertical	passed
peak	maxhold	1000	1165.0	-28.57	-13.00	15.57	-180.0	vertical	vertical	passed
peak	maxhold	1000	1180.1	-32.31	-13.00	19.31	-180.0	vertical	vertical	passed
peak	maxhold	1000	1223.9	-32.98	-13.00	19.98	-180.0	vertical	vertical	passed
peak	maxhold	1000	1230.6	-27.89	-13.00	14.89	-180.0	vertical	vertical	passed
peak	maxhold	1000	1240.7	-25.31	-13.00	12.31	-180.0	vertical	vertical	passed
peak	maxhold	1000	1250.8	-22.75	-13.00	9.75	-180.0	vertical	vertical	passed
peak	maxhold	1000	1262.6	-24.74	-13.00	11.74	-180.0	vertical	vertical	passed
peak	maxhold	1000	1289.5	-22.87	-13.00	9.87	-180.0	vertical	vertical	passed
peak	maxhold	1000	1329.9	-32.05	-13.00	19.05	-180.0	vertical	vertical	passed
peak	maxhold	1000	1338.4	-28.89	-13.00	15.89	-180.0	vertical	vertical	passed
peak	maxhold	1000	1345.1	-29.91	-13.00	16.91	-180.0	vertical	vertical	passed
peak	maxhold	1000	1685.1	-20.41	-13.00	7.41	-180.0	vertical	vertical	passed
peak	maxhold	1000	1771.0	-19.72	-13.00	6.72	-180.0	vertical	vertical	passed
peak	maxhold	1000	1774.3	-25.18	-13.00	12.18	-180.0	vertical	vertical	passed
peak	maxhold	3	1849.9419	-29.67	-13.00	16.67	-45.0	vertical	vertical	passed
peak	maxhold	3	1849.9499	-31.18	-13.00	18.18	45.0	vertical	vertical	passed
peak	maxhold	3	1849.9539	-32.21	-13.00	19.21	-135.0	vertical	vertical	passed
peak	maxhold	3	1849.9659	-25.06	-13.00	12.06	-45.0	vertical	vertical	passed
peak	maxhold	3	1849.9840	-21.72	-13.00	8.72	-45.0	vertical	vertical	passed
peak	maxhold	3	1849.9880	-29.12	-13.00	16.12	0.0	horizontal	horizontal	passed
peak	maxhold	3	1849.9920	-27.25	-13.00	14.25	0.0	vertical	vertical	passed
peak	maxhold	3	1849.9980	-24.93	-13.00	11.93	45.0	vertical	vertical	passed
peak	maxhold	1000	1982.2	-24.83	-13.00	11.83	-180.0	vertical	vertical	passed
peak	maxhold	1000	1991.6	-24.20	-13.00	11.20	-180.0	vertical	vertical	passed
peak	maxhold	1000	1994.8	-22.39	-13.00	9.39	-180.0	vertical	vertical	passed
peak	maxhold	1000	1999.5	-30.43	-13.00	17.43	-180.0	vertical	vertical	passed
peak	maxhold	1000	2004.3	-20.33	-13.00	7.33	-180.0	vertical	vertical	passed
peak	maxhold	1000	2021.7	-22.87	-13.00	9.87	-180.0	vertical	vertical	passed
peak	maxhold	1000	2024.8	-21.14	-13.00	8.14	-180.0	vertical	vertical	passed
peak	maxhold	1000	2037.5	-25.96	-13.00	12.96	-180.0	vertical	vertical	passed
peak	maxhold	1000	2072.3	-20.56	-13.00	7.56	-180.0	vertical	vertical	passed
peak	maxhold	1000	2129.2	-25.87	-13.00	12.87	-180.0	vertical	vertical	passed
peak	maxhold	1000	2345.8	-25.73	-13.00	12.73	-180.0	vertical	vertical	passed
peak	maxhold	1000	2382.2	-23.42	-13.00	10.42	-180.0	vertical	vertical	passed
peak	maxhold	1000	2388.5	-25.39	-13.00	12.39	-180.0	vertical	vertical	passed

no further values have been found with a margin of less than 20 dB

Test: 24.4; Frequency Band = 1900, Mode = GSM, Channel = 661, Frequency = 1880.0MHz

Result: Passed
Setup No.: S01_AS06
Date of Test: 2014/08/07 7:03
Body: FCC47CFRChIPART24PERSONAL COMMUNICATIONS SERVICES
Test Specification: FCC part 2 and 24

Detailed Results:

detector	trace	resolution bandwidth /kHz	frequency /MHz	peak value /dBm	limit /dBm	margin to limit /dB	azimuth /°	antenna polarization	EUT orientation	verdict
peak	maxhold	1000	1614.2	-29.39	-13.00	16.39	-120.0	vertical	horizontal	passed
peak	maxhold	1000	1617.6	-25.97	-13.00	12.97	-120.0	vertical	horizontal	passed
peak	maxhold	1000	1622.7	-26.24	-13.00	13.24	-120.0	vertical	horizontal	passed
peak	maxhold	1000	1627.8	-21.14	-13.00	8.14	-120.0	vertical	horizontal	passed

no further values have been found with a margin of less than 20 dB

Test: 24.4; Frequency Band = 1900, Mode = GSM, Channel = 810, Frequency = 1909.8MHz

Result: Passed
Setup No.: S01_AS06
Date of Test: 2014/08/07 9:04
Body: FCC47CFRChIPART24PERSONAL COMMUNICATIONS SERVICES
Test Specification: FCC part 2 and 24

Detailed Results:

detector	trace	resolution bandwidth /kHz	frequency /MHz	peak value /dBm	limit /dBm	margin to limit /dB	azimuth /°	antenna polarization	EUT orientation	verdict
peak	maxhold	3	1910.0020	-24.46	-13.00	11.46	-135.0	vertical	vertical	passed
peak	maxhold	3	1910.0100	-25.89	-13.00	12.89	-45.0	vertical	vertical	passed
peak	maxhold	3	1910.0140	-28.10	-13.00	15.10	-180.0	vertical	vertical	passed
peak	maxhold	3	1910.0200	-23.58	-13.00	10.58	-135.0	vertical	vertical	passed
peak	maxhold	3	1910.0341	-25.18	-13.00	12.18	-135.0	vertical	vertical	passed
peak	maxhold	3	1910.0501	-29.93	-13.00	16.93	-45.0	vertical	vertical	passed
peak	maxhold	3	1910.0581	-30.74	-13.00	17.74	-135.0	vertical	vertical	passed
peak	maxhold	3	1910.0681	-32.19	-13.00	19.19	-135.0	vertical	vertical	passed

no further values have been found with a margin of less than 20 dB

Test: 24.4; Frequency Band = FDD2, Mode = HSDPA, Channel = 9262, Frequency = 1852.4MHz

Result: Passed
Setup No.: S01_AS06
Date of Test: 2014/08/08 10:53
Body: FCC47CFRChIPART24PERSONAL COMMUNICATIONS SERVICES
Test Specification: FCC part 2 and 24

Detailed Results:

detector	trace	resolution bandwidth /kHz	frequency /MHz	peak value /dBm	limit /dBm	margin to limit /dB	azimuth /°	antenna polarization	EUT orientation	verdict
peak	maxhold	100	1845.83	-32.88	-13.00	19.88	-60.0	horizontal	horizontal	passed
peak	maxhold	100	1845.99	-29.31	-13.00	16.31	90.0	vertical	vertical	passed
peak	maxhold	100	1848.64	-23.93	-13.00	10.93	-180.0	vertical	vertical	passed
peak	maxhold	100	1848.89	-21.26	-13.00	8.26	90.0	vertical	vertical	passed
peak	maxhold	50	1849.50	-31.25	-13.00	18.25	-45.0	vertical	vertical	passed
peak	maxhold	50	1849.80	-27.45	-13.00	14.45	90.0	vertical	vertical	passed
peak	maxhold	50	1849.99	-24.03	-13.00	11.03	-45.0	vertical	vertical	passed
peak	maxhold	1000	1931.6	-32.81	-13.00	19.81	-90.0	vertical	vertical	passed

no further values have been found with a margin of less than 20 dB

Test: 24.4; Frequency Band = FDD2, Mode = HSDPA, Channel = 9400, Frequency = 1880MHz

Result: Passed
Setup No.: S01_AS06
Date of Test: 2014/08/08 11:55
Body: FCC47CFRChIPART24PERSONAL COMMUNICATIONS SERVICES
Test Specification: FCC part 2 and 24

Detailed Results:

detector	trace	resolution bandwidth /kHz	frequency /MHz	peak value /dBm	limit /dBm	margin to limit /dB	azimuth /°	antenna polarization	EUT orientation	verdict
peak	maxhold	1000	1960.0	-33.19	-13.00	20.19	90.0	vertical	vertical	passed

no further values have been found with a margin of less than 20 dB

Test: 24.4; Frequency Band = FDD2, Mode = HSDPA, Channel = 9538, Frequency = 1907.6MHz

Result: Passed
Setup No.: S01_AS06
Date of Test: 2014/08/08 10:03
Body: FCC47CFRChIPART24PERSONAL COMMUNICATIONS SERVICES
Test Specification: FCC part 2 and 24

Detailed Results:

detector	trace	resolution bandwidth /kHz	frequency /MHz	peak value /dBm	limit /dBm	margin to limit /dB	azimuth /°	antenna polarization	EUT orientation	verdict
peak	maxhold	50	1910.00	-25.01	-13.00	12.01	-180.0	vertical	vertical	passed
peak	maxhold	50	1910.15	-26.63	-13.00	13.63	-45.0	vertical	vertical	passed
peak	maxhold	50	1910.52	-30.73	-13.00	17.73	-180.0	vertical	vertical	passed
peak	maxhold	100	1911.27	-20.03	-13.00	7.03	-180.0	vertical	vertical	passed
peak	maxhold	100	1911.51	-25.47	-13.00	12.47	-45.0	horizontal	vertical	passed

no further values have been found with a margin of less than 20 dB

Test: 24.4; Frequency Band = FDD2, Mode = HSUPA, Channel = 9262, Frequency = 1852.4MHz

Result: Passed
Setup No.: S01_AS06
Date of Test: 2014/08/10 23:30
Body: FCC47CFRChIPART24PERSONAL COMMUNICATIONS SERVICES
Test Specification: FCC part 2 and 24

Detailed Results:

detector	trace	resolution bandwidth /kHz	frequency /MHz	peak value /dBm	limit /dBm	margin to limit /dB	azimuth /°	antenna polarization	EUT orientation	verdict
peak	maxhold	100	1846.08	-31.67	-13.00	18.67	-120.0	horizontal	horizontal	passed
peak	maxhold	100	1846.46	-32.44	-13.00	19.44	-120.0	horizontal	horizontal	passed
peak	maxhold	100	1847.07	-29.70	-13.00	16.70	-120.0	horizontal	horizontal	passed
peak	maxhold	100	1847.18	-29.29	-13.00	16.29	-120.0	horizontal	horizontal	passed
peak	maxhold	100	1847.45	-32.19	-13.00	19.19	-60.0	vertical	horizontal	passed
peak	maxhold	100	1847.65	-29.87	-13.00	16.87	-60.0	horizontal	horizontal	passed
peak	maxhold	100	1847.85	-30.27	-13.00	17.27	-120.0	horizontal	horizontal	passed
peak	maxhold	100	1848.04	-28.05	-13.00	15.05	-120.0	horizontal	horizontal	passed
peak	maxhold	100	1848.31	-27.88	-13.00	14.88	-120.0	horizontal	horizontal	passed
peak	maxhold	100	1848.46	-28.90	-13.00	15.90	-120.0	horizontal	horizontal	passed
peak	maxhold	100	1848.82	-26.57	-13.00	13.57	-120.0	horizontal	horizontal	passed
peak	maxhold	50	1850.00	-29.35	-13.00	16.35	-120.0	horizontal	horizontal	passed

no further values have been found with a margin of less than 20 dB

Test: 24.4; Frequency Band = FDD2, Mode = HSUPA, Channel = 9400, Frequency = 1880MHz

Result: Passed
Setup No.: S01_AS06
Date of Test: 2014/08/11 0:55
Body: FCC47CFRChIPART24PERSONAL COMMUNICATIONS SERVICES
Test Specification: FCC part 2 and 24

Detailed Results:

detector	trace	resolution bandwidth /kHz	frequency /MHz	peak value /dBm	limit /dBm	margin to limit /dB	azimuth /°	antenna polarization	EUT orientation	verdict
peak	maxhold	1000	1234.8	-38.39	-13.00	25.39	-60.0	vertical	horizontal	passed

no further values have been found with a margin of less than 20 dB

Test: 24.4; Frequency Band = FDD2, Mode = HSUPA, Channel = 9538, Frequency = 1907.6MHz

Result: Passed
Setup No.: S01_AS06
Date of Test: 2014/08/08 23:17
Body: FCC47CFRChIPART24PERSONAL COMMUNICATIONS SERVICES
Test Specification: FCC part 2 and 24

Detailed Results:

detector	trace	resolution bandwidth /kHz	frequency /MHz	peak value /dBm	limit /dBm	margin to limit /dB	azimuth /°	antenna polarization	EUT orientation	verdict
peak	maxhold	1000	1849.0	-13.66	-13.00	0.66	-180.0	vertical	vertical	passed
peak	maxhold	50	1849.80	-28.41	-13.00	15.41	-180.0	vertical	vertical	passed
peak	maxhold	50	1850.00	-26.82	-13.00	13.82	-180.0	vertical	vertical	passed
peak	maxhold	50	1910.01	-25.44	-13.00	12.44	-45.0	vertical	vertical	passed
peak	maxhold	50	1910.47	-29.35	-13.00	16.35	-45.0	vertical	vertical	passed
peak	maxhold	100	1911.18	-22.50	-13.00	9.50	45.0	vertical	vertical	passed
peak	maxhold	100	1911.74	-27.54	-13.00	14.54	-45.0	vertical	vertical	passed

no further values have been found with a margin of less than 20 dB

Test: 24.4; Frequency Band = FDD2, Mode = W-CDMA, Channel = 9262, Frequency = 1852.4MHz

Result: Passed
Setup No.: S01_AS06
Date of Test: 2014/08/08 4:43
Body: FCC47CFRChIPART24PERSONAL COMMUNICATIONS SERVICES
Test Specification: FCC part 2 and 24

Detailed Results:

detector	trace	resolution bandwidth /kHz	frequency /MHz	peak value /dBm	limit /dBm	margin to limit /dB	azimuth /°	antenna polarization	EUT orientation	verdict
peak	maxhold	100	1848.66	-31.06	-13.00	18.06	-45.0	vertical	vertical	passed
peak	maxhold	100	1849.00	-32.47	-13.00	19.47	90.0	vertical	vertical	passed

no further values have been found with a margin of less than 20 dB

Test: 24.4; Frequency Band = FDD2, Mode = W-CDMA, Channel = 9400, Frequency = 1880MHz

Result: Passed
Setup No.: S01_AS06
Date of Test: 2014/08/08 3:43
Body: FCC47CFRChIPART24PERSONAL COMMUNICATIONS SERVICES
Test Specification: FCC part 2 and 24

Detailed Results:

detector	trace	resolution bandwidth /kHz	frequency /MHz	peak value /dBm	limit /dBm	margin to limit /dB	azimuth /°	antenna polarization	EUT orientation	verdict
peak	maxhold	1000	49.4	-41.78	-13.00	28.78	90.0	vertical	vertical	passed

no further values have been found with a margin of less than 20 dB

Test: 24.4; Frequency Band = FDD2, Mode = W-CDMA, Channel = 9538, Frequency = 1907.6MHz

Result: Passed
Setup No.: S01_AS06
Date of Test: 2014/08/08 2:00
Body: FCC47CFRChIPART24PERSONAL COMMUNICATIONS SERVICES
Test Specification: FCC part 2 and 24

Detailed Results:

detector	trace	resolution bandwidth /kHz	frequency /MHz	peak value /dBm	limit /dBm	margin to limit /dB	azimuth /°	antenna polarization	EUT orientation	verdict
peak	maxhold	100	1911.58	-32.99	-13.00	19.99	120.0	horizontal	horizontal	passed

no further values have been found with a margin of less than 20 dB

3.5.11 24.5 Emission and Occupied Bandwidth §2.1049, §24.238

Test: 24.5; Emission and Occupied Bandwidth Summary §2.1049, §24.238

<i>Result:</i>	Passed
<i>Setup No.:</i>	S01_AS06
<i>Date of Test:</i>	2014/07/14 12:39
<i>Body:</i>	FCC47CFRChIPART24PERSONAL COMMUNICATIONS SERVICES
<i>Test Specification:</i>	FCC part 2 and 24

Detailed Results:

Band	Mode	Channel	-26dB BW KHz	99% BW /KHz	Verdict
1900	GSM	512	306.6	242.5	Passed
		661	312.6	244.5	Passed
		810	312.6	244.5	Passed
	EDGE	512	310.6	242.5	Passed
		661	308.6	244.5	Passed
		810	296.6	246.5	Passed
FDD 2	UMTS	9262	4729.5	4148.3	Passed
		9400	4729.5	4148.3	Passed
		9538	4729.5	4128.3	Passed
	HSUPA	9262	4769.6	4148.3	Passed
		9400	4749.5	4168.3	Passed
		9538	4749.5	4168.3	Passed
	HSDPA	9262	4749.5	4128.3	Passed
		9400	4729.5	4148.3	Passed
		9538	4749.5	4128.3	Passed

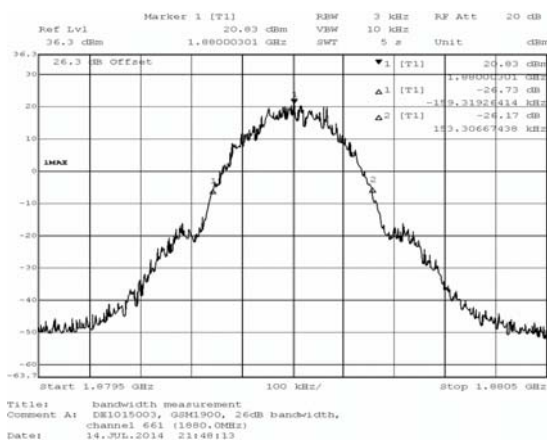

GSM 1900 Band

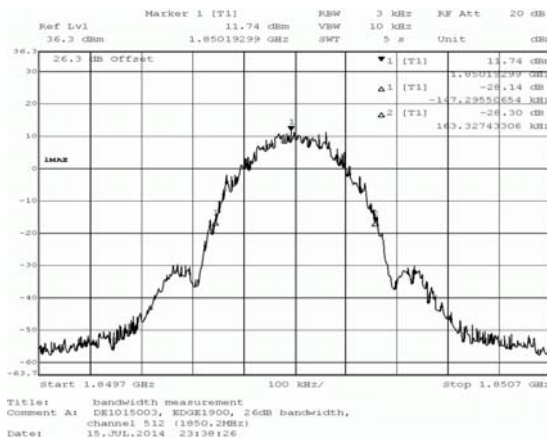
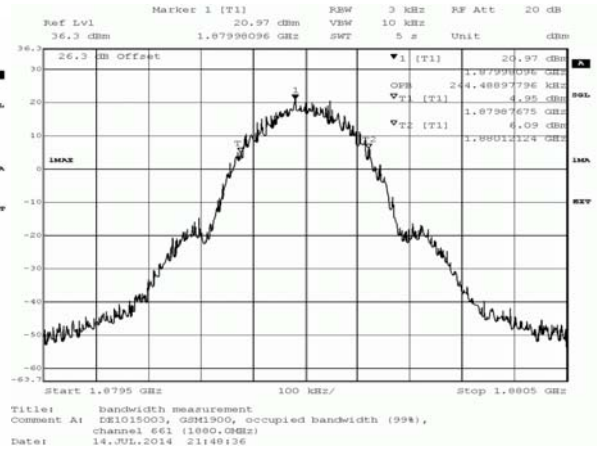

EGDE 1900 Band

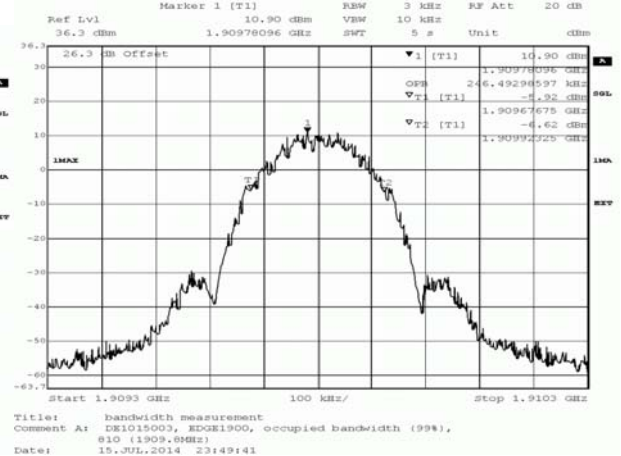



UMTS FDD2 Band

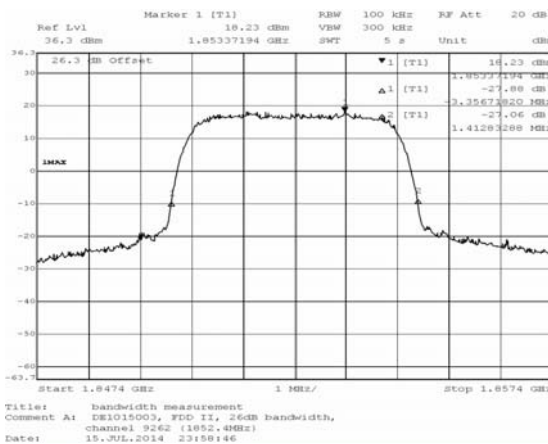
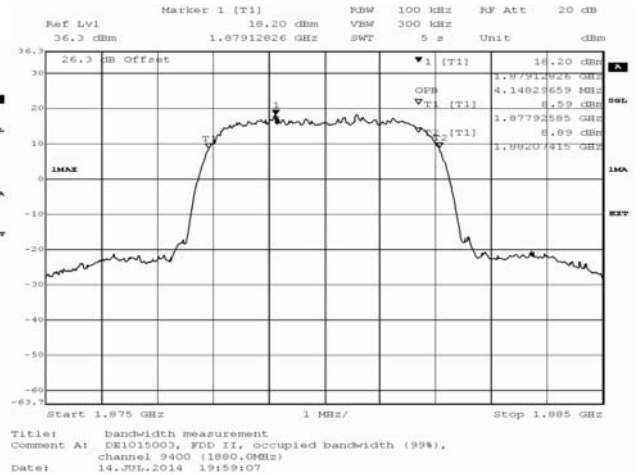

HSUPA FDD 2 Band

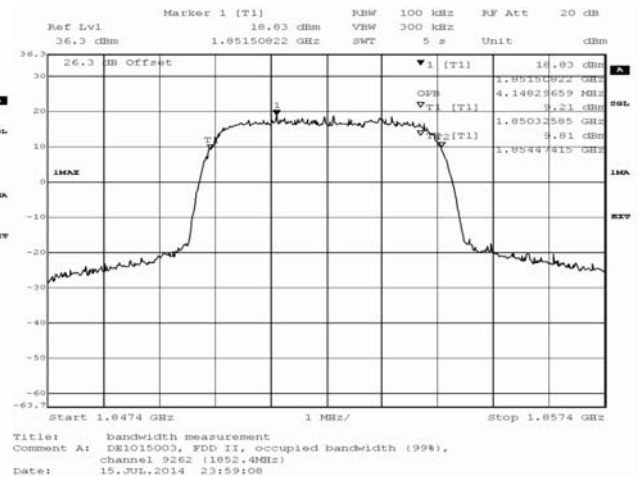

3.5.12 24.6 Band edge compliance §2.1053, §24.238

Test: 24.6; Frequency Band = 1900 / FDD2

<i>Result:</i>	Passed
<i>Setup No.:</i>	S01_AS06
<i>Date of Test:</i>	2014/07/14 13:41
<i>Body:</i>	FCC47CFRChIPART24PERSONAL COMMUNICATIONS SERVICES
<i>Test Specification:</i>	FCC part 2 and 24

Detailed Results:

Band	Modulation	Mode	Detector	Frequency (MHZ)	peak value /dBm	margin to limit /dB	limit /dBm	Verdict
1900	GFSK	GSM / GPRS	peak	1849.976	-18.05	5.05	-13.0	passed
			peak	1849.999	-20.86	7.86	-13.0	passed
			average	1849.982	-38.44	25.44	-13.0	passed
			rms	1849.982	-30.97	17.97	-13.0	passed
			peak	1910.001	-19.98	6.98	-13.0	passed
			peak	1910.015	-18.13	5.13	-13.0	passed
			peak	1910.026	-17.47	4.47	-13.0	passed
			peak	1910.077	-27.75	14.75	-13.0	passed
			average	1910.029	-39.27	26.27	-13.0	passed
			rms	1910.021	-31.66	18.66	-13.0	passed
	8-PSK	EDGE	peak	1849.965	-30.12	17.12	-13.0	passed
			average	1849.974	-53.24	40.24	-13.0	passed
			rms	1849.965	-45.29	32.29	-13.0	passed
			peak	1910.032	-32.78	19.78	-13.0	passed
average			1910.004	-59.27	46.27	-13.0	passed	
rms			1910.018	-45.29	32.29	-13.0	passed	
Band	Modulation	Mode	Detector	Frequency (MHZ)	peak value /dBm	margin to limit /dB	limit /dBm	Verdict
FDD 2	QPSK	W-CDMA	peak	1850.000	-17.65	4.65	-13.0	passed
			average	1850.000	-26.20	13.20	-13.0	passed
			rms	1850.000	-25.64	12.64	-13.0	passed
			peak	1910.000	-17.61	4.61	-13.0	passed
			average	1910.000	-28.14	15.14	-13.0	passed
			rms	1910.000	-27.22	14.22	-13.0	passed
		HSDPA	peak	1850.000	-18.78	5.78	-13.0	passed
			average	1850.000	-26.80	13.80	-13.0	passed
			rms	1850.000	-26.01	13.01	-13.0	passed
			peak	1910.000	-17.81	4.81	-13.0	passed
			average	1910.000	-27.90	14.90	-13.0	passed
			rms	1910.000	-26.80	13.80	-13.0	passed
		HSUPA	peak	1850.000	-17.57	4.57	-13.0	passed
			average	1850.000	-26.01	13.01	-13.0	passed
			rms	1850.000	-24.95	11.95	-13.0	passed
			peak	1910.000	-15.64	2.64	-13.0	passed
			average	1910.000	-26.20	13.20	-13.0	passed
			rms	1910.000	-25.11	12.11	-13.0	passed

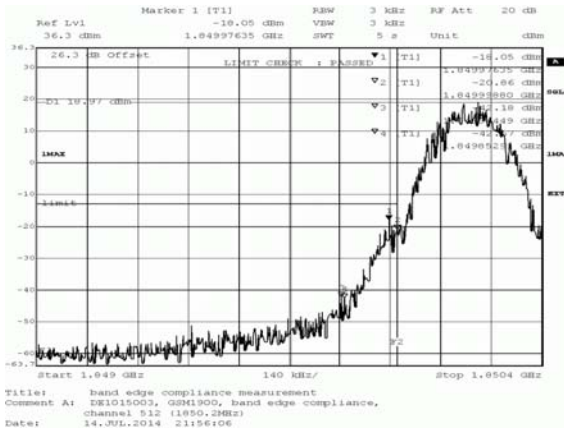

GSM 1900 Band

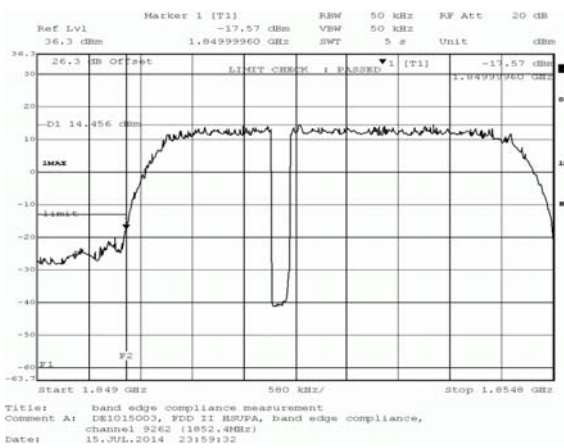
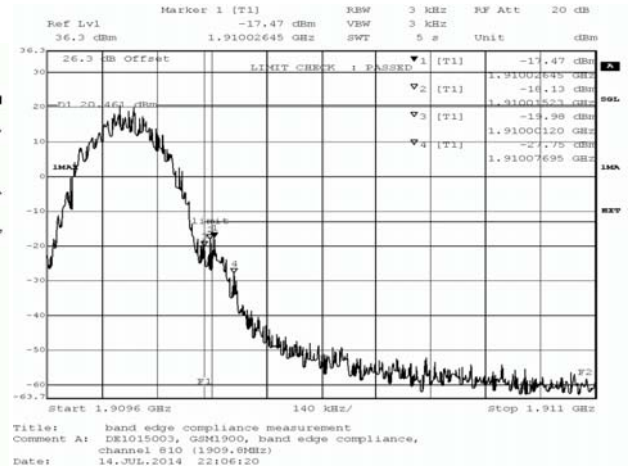

HSUPA FDD2



4 Test Equipment Details for TOBY-L210

4.1 List of Used Test Equipment

The calibration, hardware and software states are shown for the testing period.

Test Equipment Anechoic Chamber

Lab ID:	Lab 1		
Manufacturer:	Frankonia		
Description:	Anechoic Chamber for radiated testing		
Type:	10.58x6.38x6.00 m ³		
	<i>Calibration Details</i>		<i>Last Execution Next Exec.</i>
	NSA (FCC)		2014/01/09 2017/01/09

Single Devices for Anechoic Chamber

<i>Single Device Name</i>	<i>Type</i>	<i>Serial Number</i>	<i>Manufacturer</i>
Air compressor	none	-	Atlas Copco
Anechoic Chamber	10.58 x 6.38 x 6.00 m ³	none	Frankonia
	<i>Calibration Details</i>		<i>Last Execution Next Exec.</i>
	FCC listing 96716 3m Part15/18		2014/01/09 2017/01/08
Controller Maturo	MCU	961208	Maturo GmbH
EMC camera	CE-CAM/1	-	CE-SYS
EMC camera Nr.2	CCD-400E	0005033	Mitsubishi
Filter ISDN	B84312-C110-E1		Siemens&Matsushita
Filter Universal 1A	BB4312-C30-H3	-	Siemens&Matsushita

Test Equipment Auxiliary Equipment for Radiated emissions

Lab ID: Lab 1
Description: Equipment for emission measurements
Serial Number: see single devices

Single Devices for Auxiliary Equipment for Radiated emissions

Single Device Name	Type	Serial Number	Manufacturer
Antenna mast	AM 4.0	AM4.0/180/11920 513	Maturo GmbH
Biconical Broadband Antenna	SBA 9119	9119-005	Schwarzbeck
Biconical dipole	VUBA 9117 <i>Calibration Details</i>	9117-108	Schwarzbeck <i>Last Execution Next Exec.</i>
	Standard Calibration		2012/01/18 2015/01/17
Broadband Amplifier 18MHz-26GHz	JS4-18002600-32-5P	849785	Miteq
Broadband Amplifier 1GHz-4GHz	AFS4-01000400-1Q-10P-4	-	Miteq
Broadband Amplifier 30MHz-18GHz	JS4-00101800-35-5P	896037	Miteq
Cable "ESI to EMI Antenna"	EcoFlex10	W18.01- 2+W38.01-2	Kabel Kusch
Cable "ESI to Horn Antenna"	UFB311A+UFB293C	W18.02- 2+W38.02-2	Rosenberger Micro-Coax
Double-ridged horn	HF 906 <i>Calibration Details</i>	357357/001	Rohde & Schwarz GmbH & Co. KG <i>Last Execution Next Exec.</i>
	Standard Calibration		2012/05/18 2015/05/17
Double-ridged horn	HF 906 <i>Calibration Details</i>	357357/002	Rohde & Schwarz GmbH & Co. KG <i>Last Execution Next Exec.</i>
	Standard Calibration		2012/06/26 2015/06/25
High Pass Filter	4HC1600/12750-1.5-KK	9942011	Trilithic
High Pass Filter	5HC2700/12750-1.5-KK	9942012	Trilithic
High Pass Filter	5HC3500/12750-1.2-KK	200035008	Trilithic
High Pass Filter	WHKX 7.0/18G-8SS	09	Wainwright
Horn Antenna Schwarzbeck 15-26 GHz BBHA 9170	BBHA 9170		
Log.-per. Antenna	HL 562 Ultralog <i>Calibration Details</i>	100609	Rohde & Schwarz GmbH & Co. KG <i>Last Execution Next Exec.</i>
	Standard Calibration		2012/12/18 2015/12/17
Log.-per. Antenna	HL 562 Ultralog	830547/003	Rohde & Schwarz GmbH & Co. KG
Loop Antenna	HFH2-Z2 <i>Calibration Details</i>	829324/006	Rohde & Schwarz GmbH & Co. KG <i>Last Execution Next Exec.</i>
	Standard calibration		2011/10/27 2014/10/26
Pyramidal Horn Antenna 26,5 GHz	3160-09	00083069	EMCO Elektronik GmbH

Single Devices for Auxiliary Equipment for Radiated emissions (continued)

<i>Single Device Name</i>	<i>Type</i>	<i>Serial Number</i>	<i>Manufacturer</i>
Pyramidal Horn Antenna 40 GHz	3160-10	00086675	EMCO Elektronik GmbH
Tilt device Maturo (Rohacell)	Antrieb TD1.5-10kg	TD1.5-10kg/024/3790709	Maturo GmbH

Test Equipment Auxiliary Test Equipment

Lab ID:	Lab 1, Lab 2
Manufacturer:	see single devices
Description:	Single Devices for various Test Equipment
Type:	various
Serial Number:	none

Single Devices for Auxiliary Test Equipment

<i>Single Device Name</i>	<i>Type</i>	<i>Serial Number</i>	<i>Manufacturer</i>
Broadband Power Divider N (Aux)	1506A / 93459	LM390	Weinschel Associates
Broadband Power Divider SMA	WA1515	A855	Weinschel Associates
Digital Multimeter 03 (Multimeter)	Fluke 177	86670383	Fluke Europe B.V.
		<i>Calibration Details</i>	<i>Last Execution</i> <i>Next Exec.</i>
		Customized calibration	2013/12/04 2015/12/03
Fibre optic link Satellite (Aux)	FO RS232 Link	181-018	Pontis
Fibre optic link Transceiver (Aux)	FO RS232 Link	182-018	Pontis
Isolating Transformer	LTS 604	1888	Thalheimer Transformatorenwerke GmbH
Notch Filter Ultra Stable (Aux)	WRCA800/960-6EEK	24	Wainwright
Signal Analyzer	FSV30	103005	Rohde & Schwarz GmbH & Co. KG
		<i>Calibration Details</i>	<i>Last Execution</i> <i>Next Exec.</i>
		Standard	2014/02/10 2016/02/09
Spectrum Analyser	FSP3	836722/011	Rohde & Schwarz GmbH & Co. KG
		<i>Calibration Details</i>	<i>Last Execution</i> <i>Next Exec.</i>
		Standard	2012/06/13 2015/06/12
Spectrum Analyser	FSU26	200418	Rohde & Schwarz GmbH & Co.KG
		<i>Calibration Details</i>	<i>Last Execution</i> <i>Next Exec.</i>
		Standard calibration	2013/07/29 2014/07/28
		Standard calibration	2014/07/29 2015/07/28
Vector Signal Generator	SMIQ 03B	832492/061	Rohde & Schwarz GmbH & Co.KG

Test Equipment Digital Signalling Devices

Lab ID: Lab 1, Lab 2
Description: Signalling equipment for various wireless technologies.

Single Devices for Digital Signalling Devices

<i>Single Device Name</i>	<i>Type</i>	<i>Serial Number</i>	<i>Manufacturer</i>
Bluetooth Signalling Unit CBT	CBT	100589	Rohde & Schwarz GmbH & Co. KG
	<i>Calibration Details</i>		<i>Last Execution</i> <i>Next Exec.</i>
	Standard calibration		2011/11/24 2014/11/23
CMW500	CMW500	107500	Rohde & Schwarz GmbH & Co. KG
	<i>Calibration Details</i>		<i>Last Execution</i> <i>Next Exec.</i>
	Standard calibration		2014/01/27 2016/01/26
Digital Radio Communication Tester	CMD 55	831050/020	Rohde & Schwarz GmbH & Co. KG
	<i>Calibration Details</i>		<i>Last Execution</i> <i>Next Exec.</i>
	Standard calibration		2011/11/28 2014/11/27
Universal Radio Communication Tester	CMU 200	102366	Rohde & Schwarz GmbH & Co. KG
	<i>HW/SW Status</i>		<i>Date of Start</i> <i>Date of End</i>
	Hardware: B11, B21V14, B21-2, B41, B52V14, B52-2, B53-2, B56V14, B68 3v04, PCMCIA, U65V04 Software: K21 4v21, K22 4v21, K23 4v21, K24 4v21, K42 4v21, K43 4v21, K53 4v21, K56 4v22, K57 4v22, K58 4v22, K59 4v22, K61 4v22, K62 4v22, K63 4v22, K64 4v22, K65 4v22, K66 4v22, K67 4v22, K68 4v22, K69 4v22 Firmware: µP1 8v50 02.05.06 ---		2007/07/16
Universal Radio Communication Tester	CMU 200	837983/052	Rohde & Schwarz GmbH & Co. KG
	<i>Calibration Details</i>		<i>Last Execution</i> <i>Next Exec.</i>
	Standard calibration		2011/12/07 2014/12/06
	<i>HW/SW Status</i>		<i>Date of Start</i> <i>Date of End</i>
	HW options: B11, B21V14, B21-2, B41, B52V14, B52-2, B53-2, B54V14, B56V14, B68 3v04, B95, PCMCIA, U65V02 SW options: K21 4v11, K22 4v11, K23 4v11, K24 4v11, K27 4v10, K28 4v10, K42 4v11, K43 4v11, K53 4v10, K65 4v10, K66 4v10, K68 4v10, Firmware: µP1 8v40 01.12.05 ---		2007/01/02
	SW: K62, K69		2008/11/03
Vector Signal Generator	SMU200A	100912	Rohde & Schwarz GmbH & Co. KG

Test Equipment Emission measurement devices

Lab ID: Lab 1
Description: Equipment for emission measurements
Serial Number: see single devices

Single Devices for Emission measurement devices

<i>Single Device Name</i>	<i>Type</i>	<i>Serial Number</i>	<i>Manufacturer</i>
Personal Computer	Dell	30304832059	Dell
Power Meter	NRVD	828110/016	Rohde & Schwarz GmbH & Co.KG
<i>Calibration Details</i>			<i>Last Execution</i> <i>Next Exec.</i>
	Standard calibration		2014/05/13 2015/05/12
Sensor Head A	NRV-Z1	827753/005	Rohde & Schwarz GmbH & Co.KG
<i>Calibration Details</i>			<i>Last Execution</i> <i>Next Exec.</i>
	Standard calibration		2014/05/13 2015/05/12
Signal Generator	SMR 20	846834/008	Rohde & Schwarz GmbH & Co. KG
Spectrum Analyzer	ESIB 26	830482/004	Rohde & Schwarz GmbH & Co. KG
<i>Calibration Details</i>			<i>Last Execution</i> <i>Next Exec.</i>
	Standard Calibration		2014/01/07 2016/01/31
<i>HW/SW Status</i>			<i>Date of Start</i> <i>Date of End</i>
	Firmware-Update 4.34.4 from 3.45 during calibration		2009/12/03

Test Equipment Radio Lab Test Equipment

Lab ID: Lab 2
Description: Radio Lab Test Equipment

Single Devices for Radio Lab Test Equipment

<i>Single Device Name</i>	<i>Type</i>	<i>Serial Number</i>	<i>Manufacturer</i>
Broadband Power Divider SMA	WA1515	A856	Weinschel Associates
Coax Attenuator 10dB SMA 2W	4T-10	F9401	Weinschel Associates
Coax Attenuator 10dB SMA 2W	56-10	W3702	Weinschel Associates
Coax Attenuator 10dB SMA 2W	56-10	W3711	Weinschel Associates
Coax Cable Huber&Suhner	Sucotest 2,0m		Huber&Suhner
Coax Cable Rosenberger Micro Coax FA210A0010003030 SMA/SMA 1,0m	FA210A0010003030	54491-2	Rosenberger Micro-Coax
Power Meter	NRVD	828110/016	Rohde & Schwarz GmbH & Co.KG
	<i>Calibration Details</i>		<i>Last Execution Next Exec.</i>
	Standard calibration		2014/05/13 2015/05/12
RF Step Attenuator RSP	RSP	833695/001	Rohde & Schwarz GmbH & Co.KG
Rubidium Frequency Standard	Datum, Model: MFS	5489/001	Datum-Beverly
	<i>Calibration Details</i>		<i>Last Execution Next Exec.</i>
	Standard calibration		2014/07/03 2015/07/02
Sensor Head A	NRV-Z1	827753/005	Rohde & Schwarz GmbH & Co.KG
	<i>Calibration Details</i>		<i>Last Execution Next Exec.</i>
	Standard calibration		2014/05/13 2015/05/12
Signal Generator SME	SME03	827460/016	Rohde & Schwarz GmbH & Co.KG
	<i>Calibration Details</i>		<i>Last Execution Next Exec.</i>
	Standard calibration		2011/11/25 2014/11/24
Signal Generator SMP	SMP02	836402/008	Rohde & Schwarz GmbH & Co. KG
	<i>Calibration Details</i>		<i>Last Execution Next Exec.</i>
	Standard calibration		2013/05/06 2016/05/05
Spectrum Analyser	FSIQ26	840061/005	Rohde & Schwarz GmbH & Co. KG
	<i>Calibration Details</i>		<i>Last Execution Next Exec.</i>
	Standard Calibration		2013/02/12 2015/02/11

Test Equipment T/A Logger 13

Lab ID: Lab 1, Lab 2
Description: Lufft Opus10 TPR
Type: Opus10 TPR
Serial Number: 13936

Single Devices for T/A Logger 13

Single Device Name	Type	Serial Number	Manufacturer
ThermoAirpressure Datalogger 13 (Environ)	Opus10 TPR (8253.00)	13936	Lufft Mess- und Regeltechnik GmbH
<i>Calibration Details</i>			<i>Last Execution</i> <i>Next Exec.</i>
Customized calibration			2013/02/07 2015/02/06

Test Equipment T/H Logger 03

Lab ID: Lab 2
Description: Lufft Opus10
Serial Number: 7482

Single Devices for T/H Logger 03

Single Device Name	Type	Serial Number	Manufacturer
ThermoHygro Datalogger 03 (Environ)	Opus10 THI (8152.00)	7482	Lufft Mess- und Regeltechnik GmbH
<i>Calibration Details</i>			<i>Last Execution</i> <i>Next Exec.</i>
Customized calibration			2013/02/07 2015/02/06

Test Equipment T/H Logger 12

Lab ID: Lab 1
Description: Lufft Opus10
Serial Number: 12482

Single Devices for T/H Logger 12

Single Device Name	Type	Serial Number	Manufacturer
ThermoHygro Datalogger 12 (Environ)	Opus10 THI (8152.00)	12482	Lufft Mess- und Regeltechnik GmbH
<i>Calibration Details</i>			<i>Last Execution</i> <i>Next Exec.</i>
Customized calibration			2013/01/07 2015/01/06

Test Equipment Temperature Chamber 05

Lab ID: Lab 2
Manufacturer: see single devices
Description: Temperature Chamber VT4002
Type: Vötsch
Serial Number: see single devices

Single Devices for Temperature Chamber 05

Single Device Name	Type	Serial Number	Manufacturer
Temperature Chamber Vötsch 05	VT 4002	58566080550010	Vötsch
<i>Calibration Details</i>			<i>Last Execution</i> <i>Next Exec.</i>
Customized calibration			2014/03/11 2016/03/10

5 Test Object Data for TOBY-L280

5.1 General OUT Description

The following section lists all OUTs (Object's Under Test) involved during testing.

OUT: TOBY-L280

<i>Type / Model / Family:</i>	TOBY-L280 FCC ID: XPYTOBYL280 IC: 8595A - TOBYL280
	FCC Part 22, Subpart H FCC Part 24, Subpart E
<i>Product Category:</i>	Module

Parameter List:

<i>Parameter name</i>	<i>Value</i>
-----------------------	--------------

5.2 Detailed Description of OUT Samples

Sample : aa01

<i>OUT Identifier</i>	TOBY-L280		
<i>Sample Description</i>	Conducted Sample #1		
<i>Serial No.</i>	358503060011765		
<i>HW Status</i>	217001		
<i>SW Status</i>	09.90		
<i>Low Voltage</i>	3.3 V	<i>Low Temp.</i>	-20 °C
<i>High Voltage</i>	4.4 V	<i>High Temp.</i>	55 °C
<i>Nominal Voltage</i>	3.8 V	<i>Normal Temp.</i>	25 °C

Sample : ag01

<i>OUT Identifier</i>	TOBY-L280		
<i>Sample Description</i>	Conducted Sample / BC #3		
<i>Serial No.</i>	358503060012011		
<i>HW Status</i>	217001		
<i>SW Status</i>	09.90		
<i>Low Voltage</i>	3.3 V	<i>Low Temp.</i>	-20 °C
<i>High Voltage</i>	4.4 V	<i>High Temp.</i>	55 °C
<i>Nominal Voltage</i>	3.8 V	<i>Normal Temp.</i>	25 °C

5.3 OUT Features

Features for OUT: TOBY-L280

<i>Designation</i>	<i>Description</i>	<i>Allowed Values</i>	<i>Supported Value(s)</i>
Features for scope: FCC_v2			
AC	The OUT is powered by or connected to AC Mains		
Dant	removable antenna supplied and type tested with the radio equipment, designed as an example part of the equipment		
EDGE850	EUT supports EDGE in the band 824 MHz - 849 MHz		
EDGE1900	EUT supports EDGE in the band 1850 MHz - 1910 MHz		
FDD2	EUT supports UMTS FDD2 in the band 1850 MHz - 1910 MHz		
FDD5	EUT supports UMTS FDD5 in the band 824 MHz - 849 MHz		
GSM850	EUT supports GSM850 band 824MHz - 849MHz		
HSDPA-FDD2	EUT supports UMTS FDD2 HSDPA in the band 1850 MHz - 1910 MHz		
HSDPA-FDD5	EUT supports UMTS FDD5 HSDPA in the band 824 MHz - 849 MHz		
HSUPA-FDD2	EUT supports UMTS FDD2 HSUPA in the band 1850 MHz - 1910 MHz		
HSUPA-FDD5	EUT supports UMTS FDD5 HSUPA in the band 824 MHz - 849 MHz		
PantC	permanent fixed antenna connector, which may be built-in, designed as an indispensable part of the equipment		
PCS1900	EUT supports PCS1900 band 1850MHz - 1910MHz		

5.4 Setups used for Testing

For each setup a relation is given to determine if and which samples and auxiliary equipment is used. The left side list all OUT samples and the right side lists all auxiliary equipment for the given setup.

Setup No.	List of OUT samples	List of auxiliary equipment		
Sample No.	Sample Description	AE No.	AE Description	
S01_AA01 (Setup #1)				
Sample: aa01	Conducted Sample #1	AE AE01	Adapter Board	
		AE AE02	Interface Board	
		AE 02	Laptop RE	
		AE AE04	External Antenna Aux	
		AE AE03	External Antenna Main	
		AE 01	EMC TFT 1	
		AE 04	Mouse 1	
		AE 05	Keyboard	
		AE 03	AC Adapter 2 Laptop RE	
		AE AE05	AC/DC Adapter	

S01_AG01 (Setup #7)

Sample: ag01 Conducted Sample / BC
#3

6 Results for TOBY-L280

6.1 General

Documentation of tested devices:

Available at the test laboratory.

Interpretation of the test results:

The results of the inspection are described on the following pages, where 'Conformity' or 'Passed' means that the certification criteria were verified and that the tested device is conform to the applied standard.

In cases where 'Declaration' is printed, the required documents are available in the manufacturers product documentation.

In cases where 'not applicable' is printed, the test case requirements are not relevant to the specific equipment implementation.

Note:

1. All tests are performed under environmental conditions within the requirements of the specifications. Environmental conditions are available at the laboratory.
2. Conducted results are derived from the parent product TOBY-L200 (FCC ID: XPYTOBYL200). The 2G and 3G components and software are identical between the TOBY L200 and L210 variants. The primary difference between the two variants is related to the supported LTE bands. LTE is not covered in this test report.

6.2 List of the Applicable Body

(Bodies for Scope: FCC_v2)

<i>Designation</i>	<i>Description</i>
FCC47CFRChIPART22PUBLIC MOBILE SERVICES	Part 22, Subpart H - Cellular Radiotelephone Service
FCC47CFRChIPART24PERSONAL COMMUNICATIONS SERVICES	Part 24, Subpart E - Broadband PCS

6.3 List of Test Specification

<i>Test Specification:</i>	FCC part 2 and 22
<i>Version</i>	10-1-13 Edition
<i>Title:</i>	PART 2 - GENERAL RULES AND REGULATIONS PART 22 - PUBLIC MOBILE SERVICES
<i>Test Specification:</i>	FCC part 2 and 24
<i>Version</i>	10-1-13 Edition
<i>Title:</i>	PART 2 - GENERAL RULES AND REGULATIONS PART 24 - PERSONAL COMMUNICATIONS SERVICES

6.4 Summary

<i>Test Case Identifier / Name</i>	<i>Result</i>	<i>Date of Test</i>	<i>Lab</i>	<i>Setup</i>
<i>Test (condition)</i>			<i>Ref.</i>	
Test Specification: FCC part 2 and 22				
22.1 RF Power Output §2.1046, §22.913				
22.1; RF Power Output Summary §2.1046, §22.913	Passed	2015/05/11	Lab 2	S01_AA01
22.3 Spurious emissions at antenna terminals §2.1051, §22.917				
22.3; Spurious emissions at antenna terminals summary §2.1051, §22.917	Passed	2015/04/17	Lab 2	S01_AG01
22.4 Field strength of spurious radiation §2.1053, §22.917				
22.4; Field strength of spurious radiation Summary §2.1053, §22.917	Passed	2015/04/16	Lab 1	S01_AA01
22.5 Emission and Occupied Bandwidth §2.1049, §22.917				
22.5; Emission and Occupied Bandwidth Summary §2.1049, §22.917	Passed	2015/05/22	Lab 2	S01_AG01
22.6 Band edge compliance §2.1053, §22.917				
22.6; Band edge compliance Summary §2.1053, §22.917	Passed	2015/04/17	Lab 2	S01_AG01
Test Specification: FCC part 2 and 24				
24.1 RF Power Output §2.1046, §24.232				
24.1; RF Power Output Summary §2.1046, §24.232	Passed	2015/04/28	Lab 2	S01_AG01
24.3 Spurious emissions at antenna terminals §2.1051, §24.238				
24.3; Spurious emissions at antenna terminals Summary §2.1051, §24.238	Passed	2015/04/22	Lab 2	S01_AG01
24.4 Field strength of spurious radiation §2.1053, §24.238				
24.4; Field strength of spurious radiation Summary §2.1053, §24.238	Passed	2015/04/16	Lab 1	S01_AA01
24.5 Emission and Occupied Bandwidth §2.1049, §24.238				
24.5; Emission and Occupied Bandwidth Summary §2.1049, §24.238	Passed	2015/04/28	Lab 2	S01_AG01
24.6 Band edge compliance §2.1053, §24.238				
24.6; Frequency Band = 1900 / FDD2	Passed	2015/04/28	Lab 2	S01_AG01

6.5 Detailed Results

6.5.1 22.1 RF Output Power §2.1046, §22.913

Test Band	Mode	Channel	Modulation	RMS Conducted power (dBm)	Deviation to original results	Limit (ERP)	Verdict
850	GSM/GPRS	Low	GFSK	32.16	-0.1	38.45	Passed
		Mid		32.41	0.06	38.45	Passed
		High		32.42	0.06	38.45	Passed
	Edge	Low	8PSK	27.26	0.37	38.45	Passed
		Mid		27.19	-0.3	38.45	Passed
		High		27.13	-0.71	38.45	Passed
FDD5	WCDMA	Low	QPSK	22.29	0.92	38.45	Passed
		Mid		22.44	0.75	38.45	Passed
		High		22.47	0.74	38.45	Passed
	HSDPA Subtest 1	Low	QPSK	22.17	0.81	38.45	Passed
		Mid		22.54	0.9	38.45	Passed
		High		22.33	0.65	38.45	Passed
	HSUPA Subtest 1	Low	QPSK	22.29	0.34	38.45	Passed
		Mid		22.2	0.12	38.45	Passed
		High		22.08	-0.06	38.45	Passed

(Negative deviation => values of new module are lower than original result values)

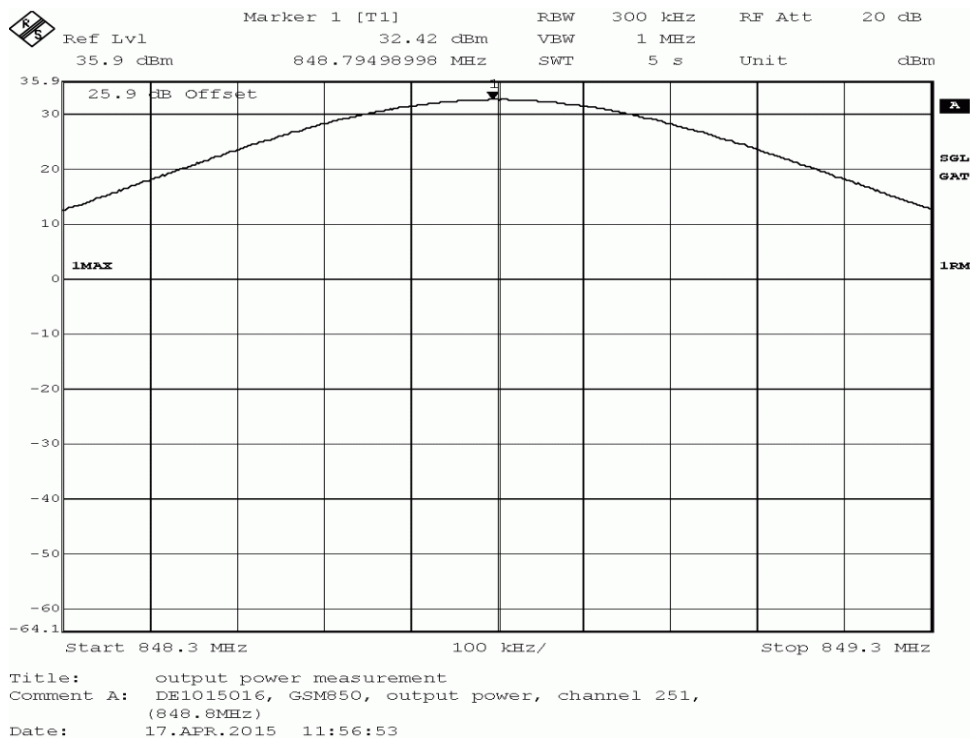

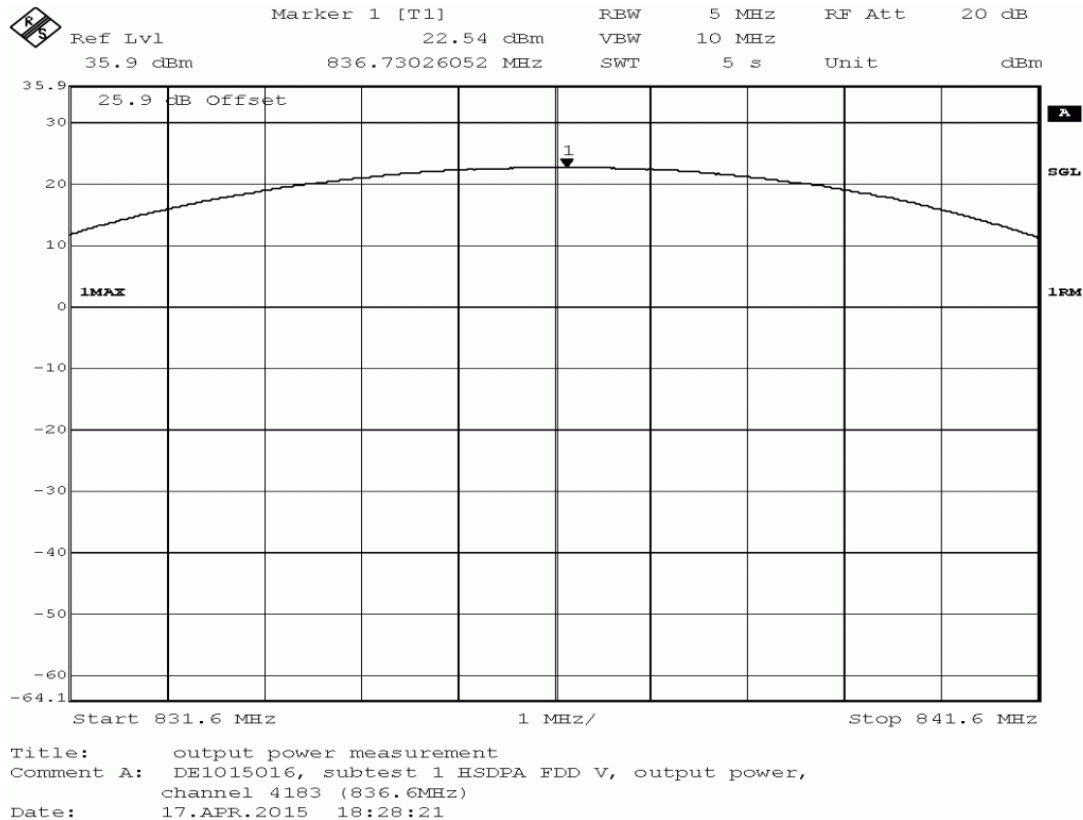

6.5.2 22.2 Frequency stability

Not tested.

6.5.3 22.3 Spurious emissions at antenna terminals §2.1051, §22.917

Band	Mode	Channel	detector	Resolution Bandwidth	Frequency (MHz)	Measured values closer 20 dB to limit (dBm)	Deviation to original results	Verdict
850	GSM	low	peak	3	824	-13.2	1.7	Passed
		low	peak	100	1649.3	-31.5	4.2	Passed
		low	peak	100	2472.95	-28.7	7.4	Passed
		mid	peak	100	1637.35	-27.7	5.7	Passed
		high	peak	3	849	-16.2	-1.6	Passed
		high	peak	100	1697.39	-27	5.9	Passed
		high	peak	100	2547.09	-31.7	4.2	Passed
FDD5	UMTS	low	rms	50	824	-26.3	1.5	Passed
		mid	-	-	-	-	-	-
		high	rms	50	849	-27.9	1.7	Passed
	HSDPA	low	rms	50	824	-27.1	0.8	Passed
		mid	-	-	-	-	-	-
		high	rms	50	849	-26.8	4	Passed
		high	rms	50	890.65	-30.8	4.7	Passed
	HSUPA	low	rms	50	824	-28.7	-0.8	Passed
		mid	-	-	-	-	-	-
high		rms	50	849	-27.3	0.2	Passed	

Negative deviation => values of new module are lower than original result values

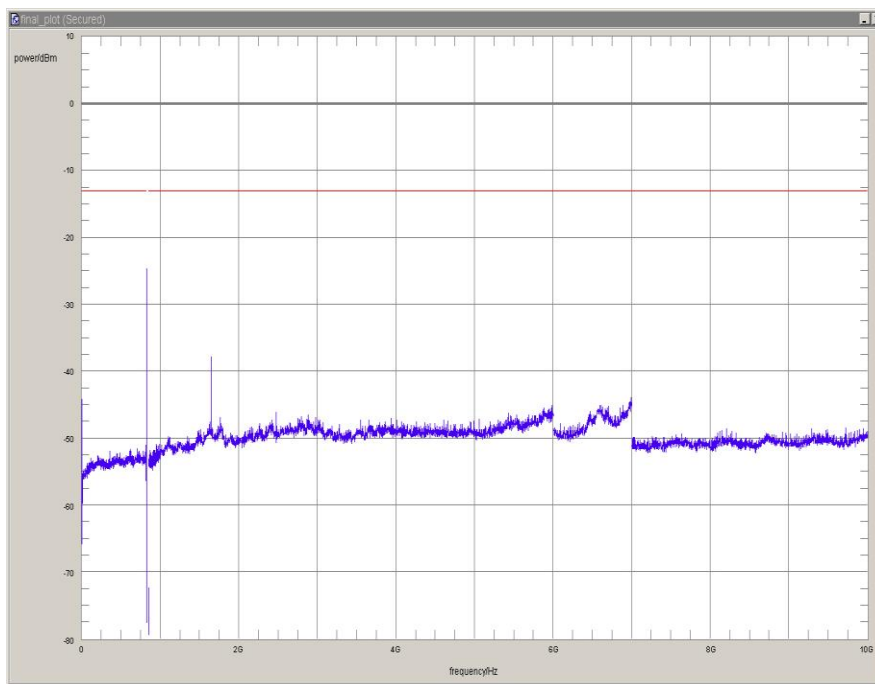

GSM850 low channel

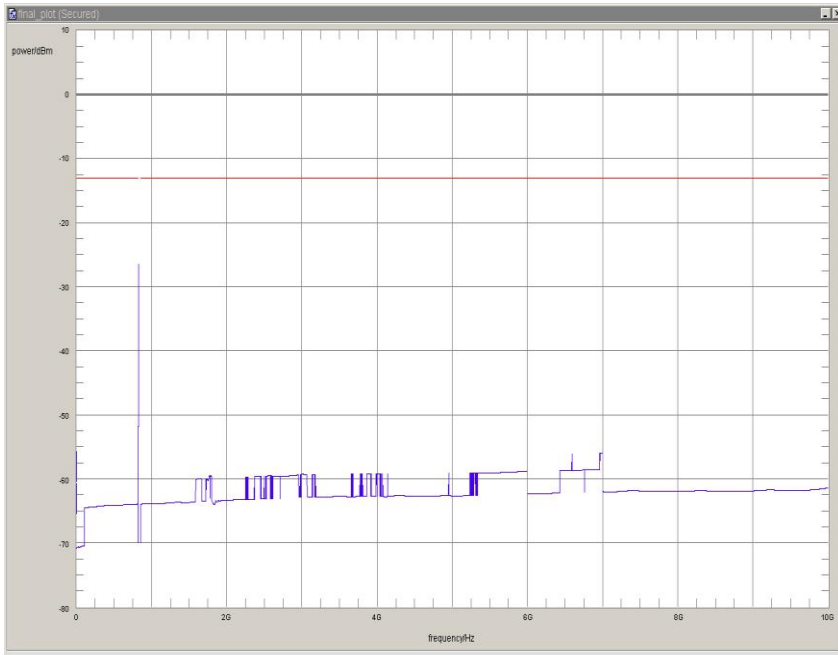

UMTS WCDMA low channel

6.5.4 22.4 Field strength of spurious radiation §2.1053, §22.917

Band	Mode	Channel	detector	Resolution Bandwidth	Frequency (MHz)	Measured values closer 20 dB to limit (dBm)	Deviation to original results	Verdict
850	GSM	low	peak	3	824	-17.93	-1.95	Passed
FDD5	UMTS	mid	-	-	-	-	-	-
	HSDPA	low	peak	100	823	-31.32	1	Passed
			peak	50	824	-25.44	-2.69	Passed
	HSUPA	high	peak	50	849	-23.17	1.33	Passed
	HSUPA	low	peak	50	824	-23.96	8.76	Passed

Negative deviation => values of new module are lower than original result values

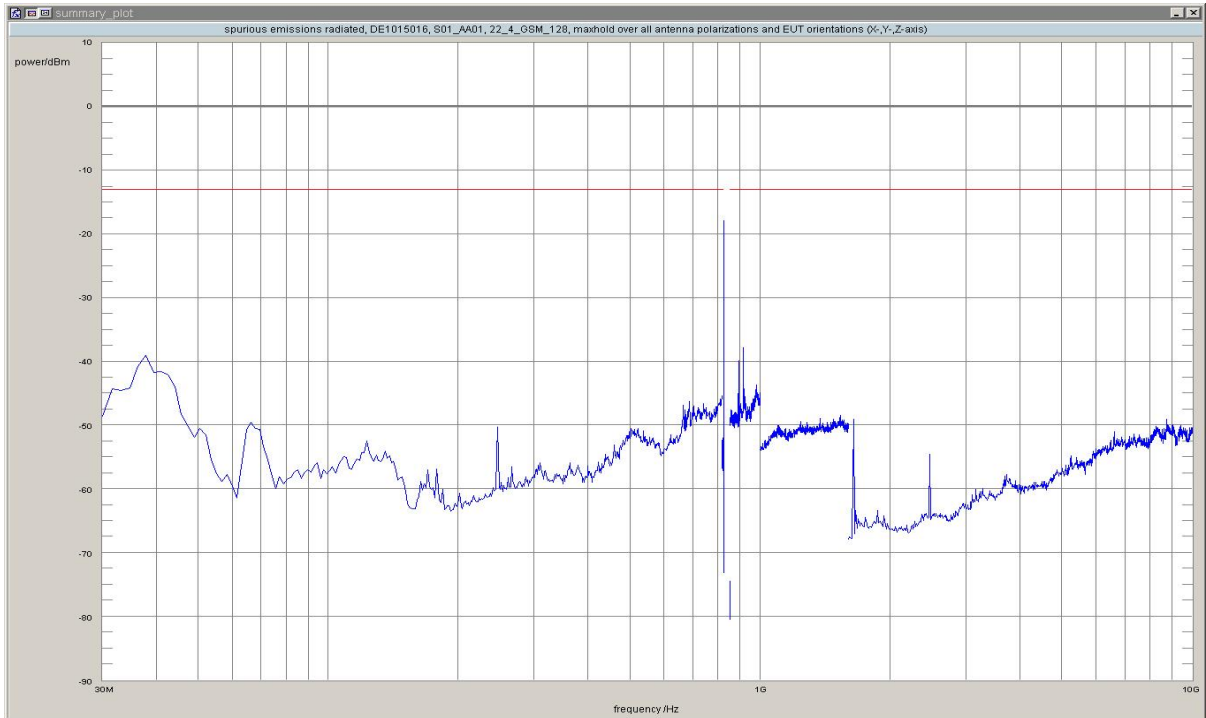

GSM 850 low channel

6.5.5 22.5 Emission and Occupied Bandwidth §2.1049, § 22.917

Band	Mode	Channel	-26 dB BW (kHz)	99 % BW (kHz)	Deviation to original values	
					-26 dB BW (kHz)	16QAM (kHz)
850	GSM	low	314.6	242.5	6.0	0.0
		mid	312.6	244.5	8.0	2.0
		High	300.6	248.5	-10.0	6.0
	EDGE	low	310.6	250.5	8.0	-2.0
		mid	308.6	248.5	0.0	2.0
		High	302.6	246.5	-6.0	2.0
FDD 5	WCDMA	low	4729.5	4108.2	0.0	-40.1
		mid	4729.5	4148.3	0.0	0.0
		High	4749.5	4128.3	40.1	0.0
	HSDPA	low	4729.5	4108.2	0.0	0.0
		mid	4749.5	4128.3	20.0	-20.0
		High	4749.5	4128.3	20.0	0.0
	HSUPA	low	4749.5	4148.3	20.0	0.0
		mid	4749.5	4148.3	0.0	0.0
		High	4769.5	4148.3	20.0	20.0

Negative deviation => values of new module are lower than original result values

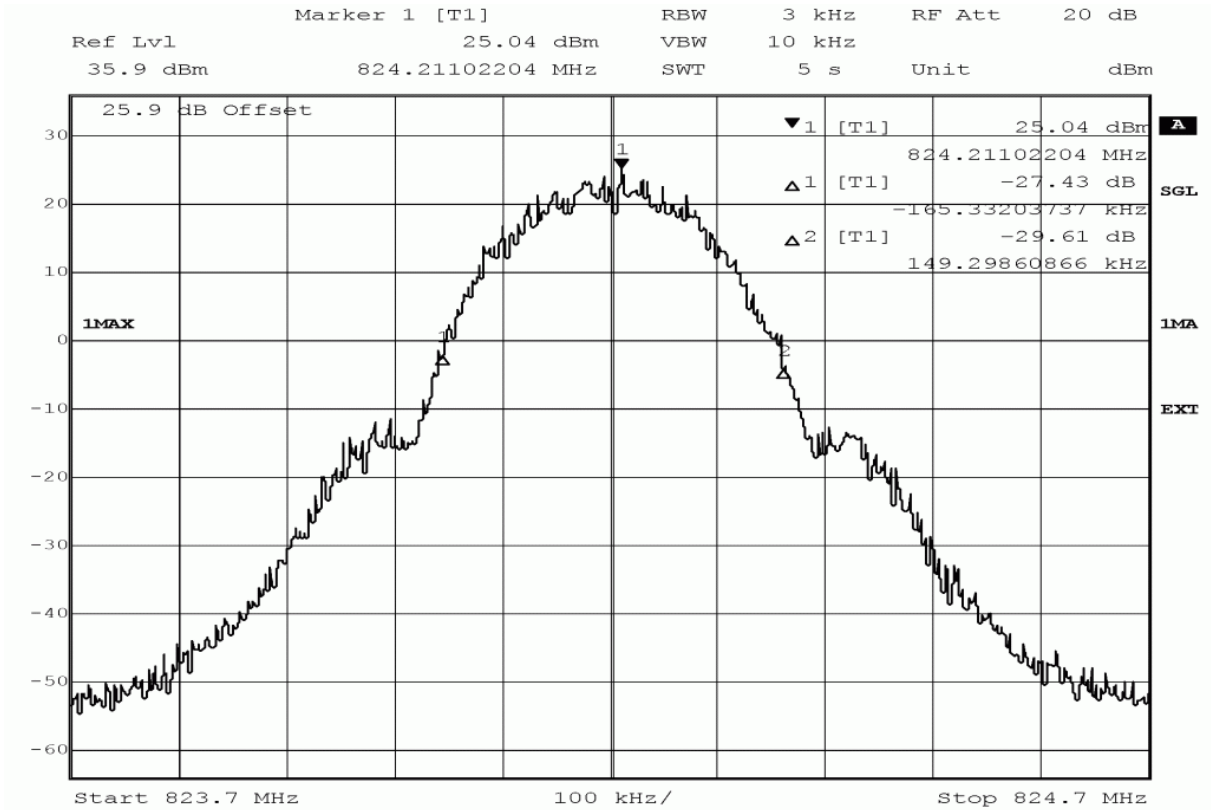

Title: bandwidth measurement
 Comment A: DE1015016, GSM850, 26dB bandwidth, channel 128 (824.2MHz)
 Date: 7.APR.2015 18:07:01

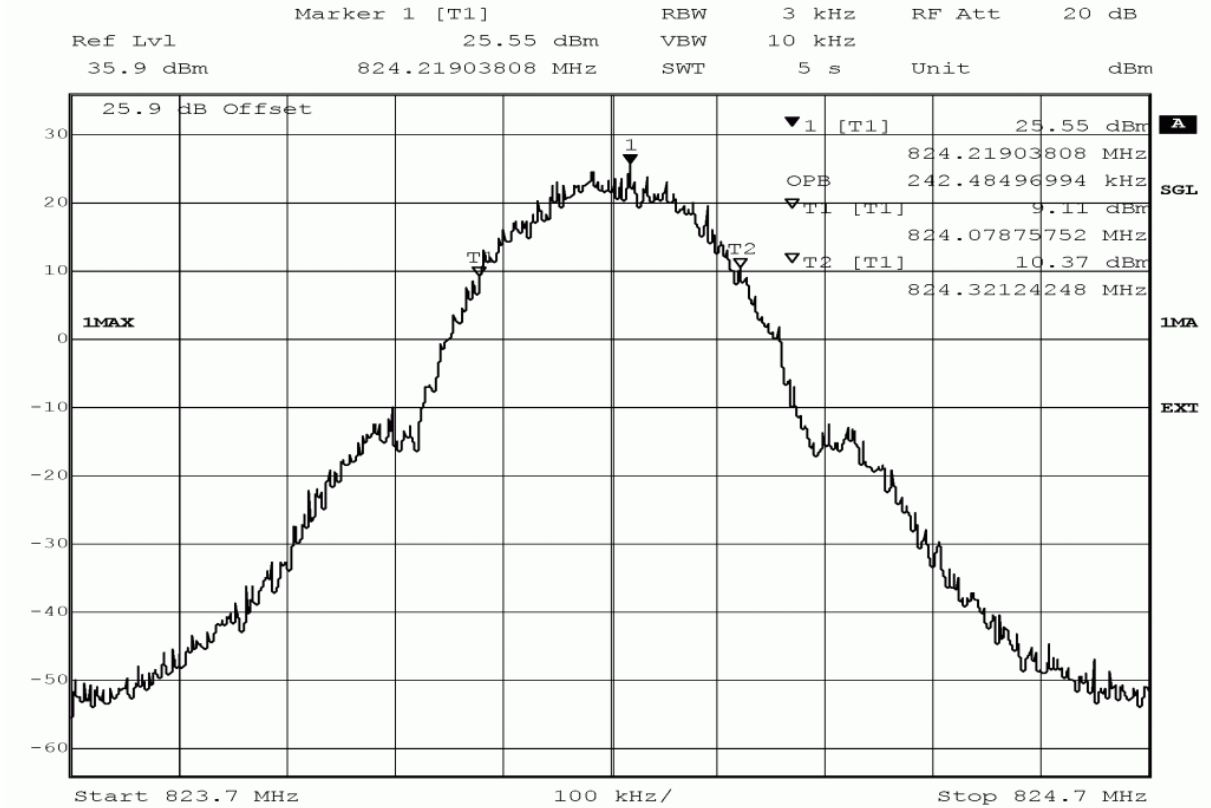

Title: bandwidth measurement
 Comment A: DE1015016, GSM850, occupied bandwidth (99%), channel 128 (824.2MHz)
 Date: 7.APR.2015 18:07:24

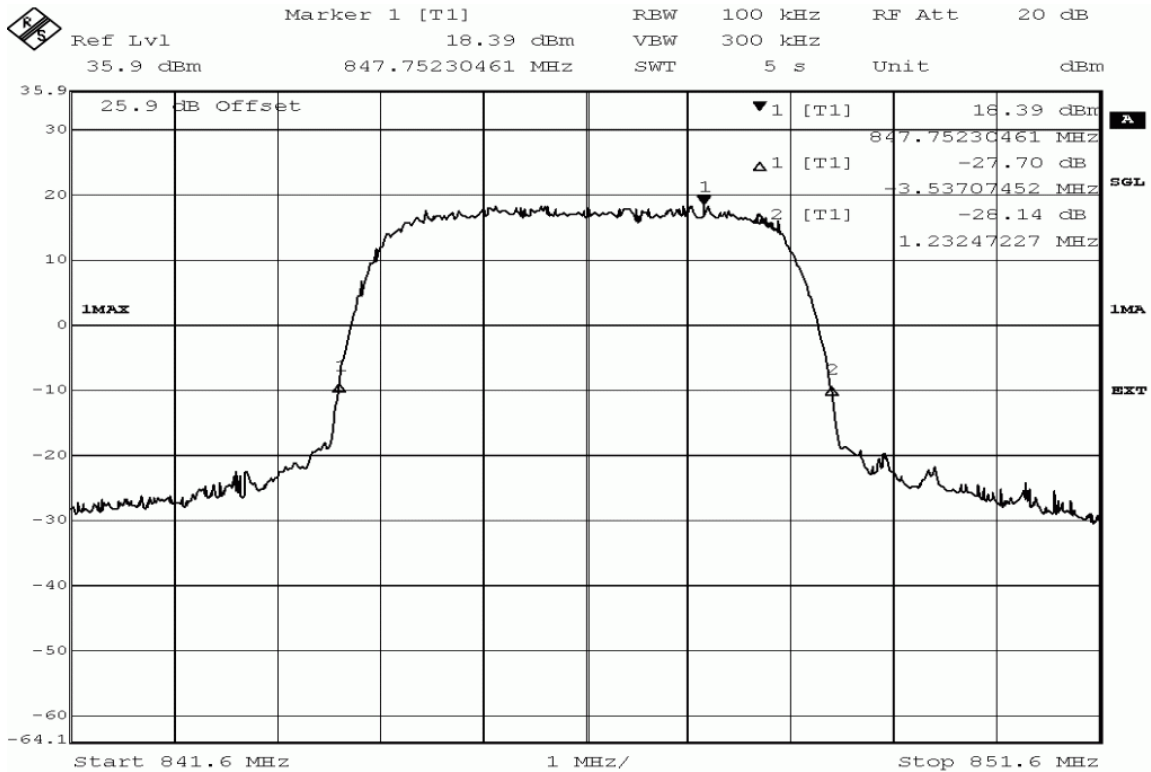

Title: bandwidth measurement
 Comment A: DE1015016, FDD V, 26dB bandwidth,
 channel 4233 (846.6MHz)
 Date: 17.APR.2015 17:49:45

HSUPA, high channel

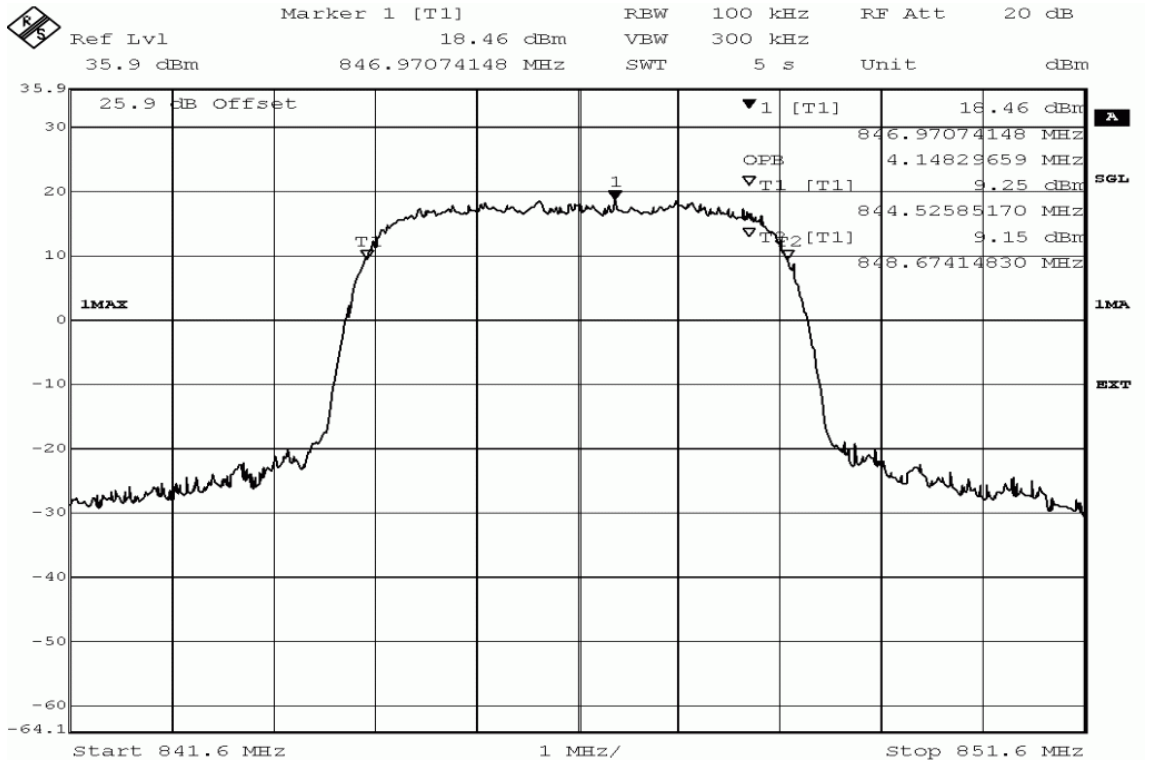

Title: bandwidth measurement
 Comment A: DE1015016, FDD V, occupied bandwidth (99%),
 channel 4233 (846.6MHz)
 Date: 17.APR.2015 17:50:07

HSUPA, high channel

6.5.6 22.6 Band edge compliance §2.1053, §22.917

Band	Mode	Modulation	Channel	Detector	Peak Value (dBm)	Deviation to original results (dB)	Limit (dBm)	Verdict
850	GSM	QPSK	low	Peak	-14.68	1.42	-13	Passed
				Average	-34.09	0.97	-13	Passed
				RMS	-27	-0.59	-13	Passed
			high	Peak	-13.81	1.82	-13	Passed
				Average	-33.64	1.94	-13	Passed
				RMS	-27.2	0.64	-13	Passed
	EDGE	8PSK	low	Peak	-23.65	0.59	-13	Passed
				Average	-44.1	-1.34	-13	Passed
				RMS	-36.74	-0.6	-13	Passed
			high	Peak	-23.55	-0.96	-13	Passed
				Average	-45.69	-2.93	-13	Passed
				RMS	-36.14	-2.92	-13	Passed
FDD5	WCDMA	QPSK	low	Peak	-28.57	-10.56	-13	Passed
				Average	-38.08	-10.46	-13	Passed
				RMS	-37.39	-10.59	-13	Passed
			high	Peak	-19.09	0.49	-13	Passed
				Average	-28.54	1.02	-13	Passed
				RMS	-27.62	1.16	-13	Passed
	HSDPA	QPSK	low	Peak	-18.4	0.8	-13	Passed
				Average	-26.6	1.24	-13	Passed
				RMS	-25.69	1.31	-13	Passed
			high	Peak	-16.88	1.52	-13	Passed
				Average	-26.41	2.63	-13	Passed
				RMS	-25.69	2.61	-13	Passed
	HSUPA	QPSK	low	Peak	-17.84	1.21	-13	Passed
				Average	-27	0.84	-13	Passed
				RMS	-25.86	1.34	-13	Passed
			high	Peak	-17.83	1.21	-13	Passed
				Average	-27.2	0.87	-13	Passed
				RMS	-26.6	1.02	-13	Passed

Negative deviation => values of new module are lower than original result values

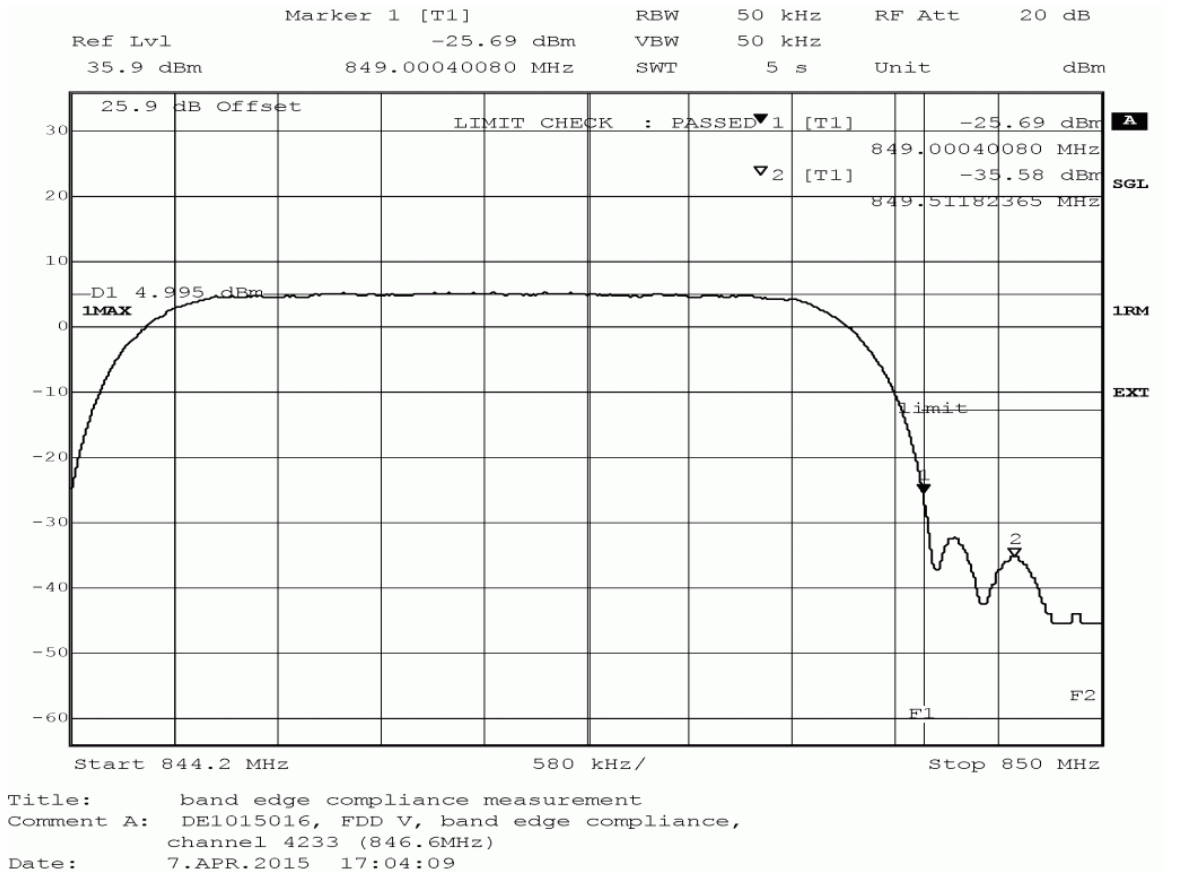
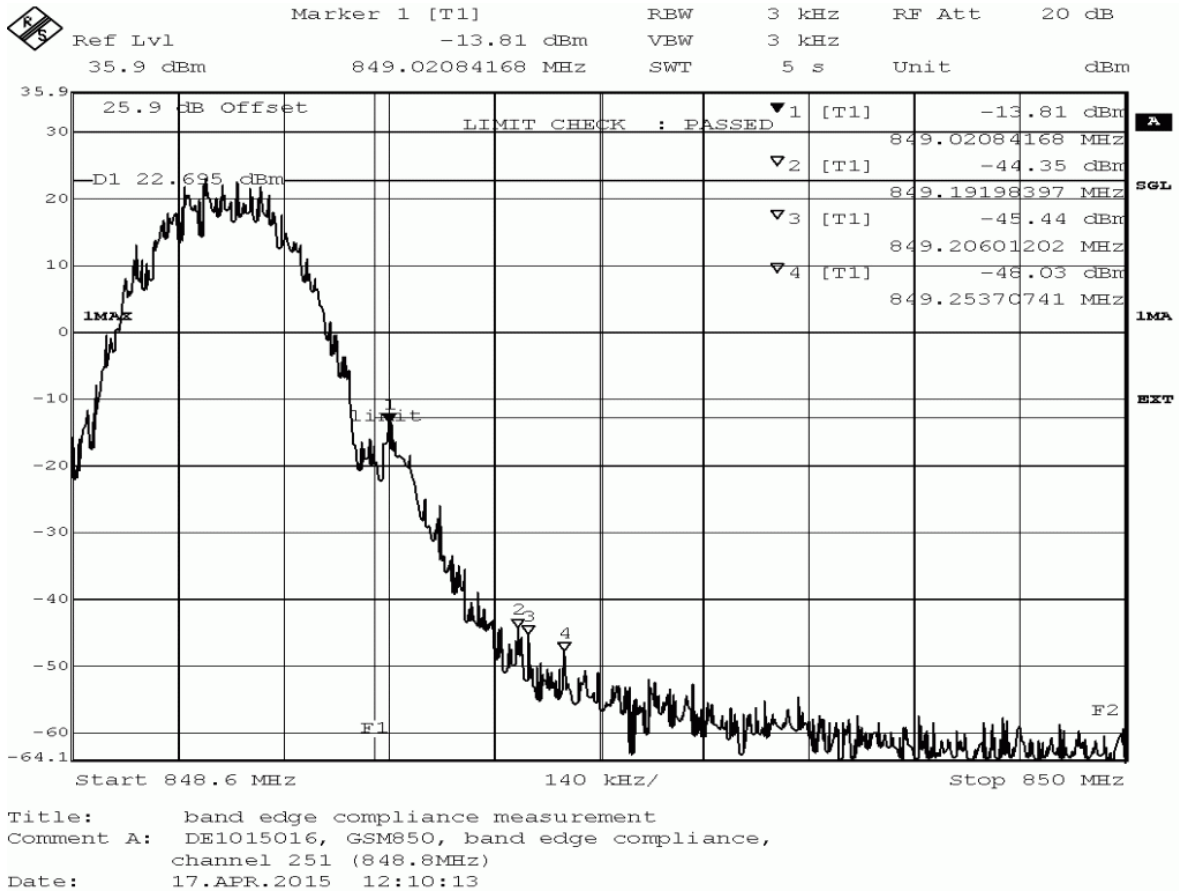

6.5.7 24.1 RF Output Power §2.1046, §24.232

Test Band	Mode	Channel	Modulation	RMS Conducted Power (dBm)	Deviation to original results (dB)	FCC / IC EIRP Limit (W)	Verdict
1900	GSM/GPRS	Low	GFSK	29.00	-0.43	2	Passed
		Mid		28.88	-0.54	2	Passed
		High		29.63	-0.1	2	Passed
	Edge	Low	8PSK	25.78	-0.42	2	Passed
		Mid		26.03	0.11	2	Passed
		High		26.13	0.69	2	Passed
FDD2	WCDMA	Low	QPSK	21.77	-0.01	2	Passed
		Mid		22.34	0.79	2	Passed
		High		22.09	0.56	2	Passed
	HSDPA Subtest 1	Low	QPSK	21.70	-0.11	2	Passed
		Mid		21.97	0.39	2	Passed
		High		22.09	0.58	2	Passed
	HSUPA Subtest 1	Low	QPSK	21.23	-0.03	2	Passed
		Mid		21.81	0.33	2	Passed
		High		21.85	0.43	2	Passed

Negative deviation => values of new module are lower than original result values

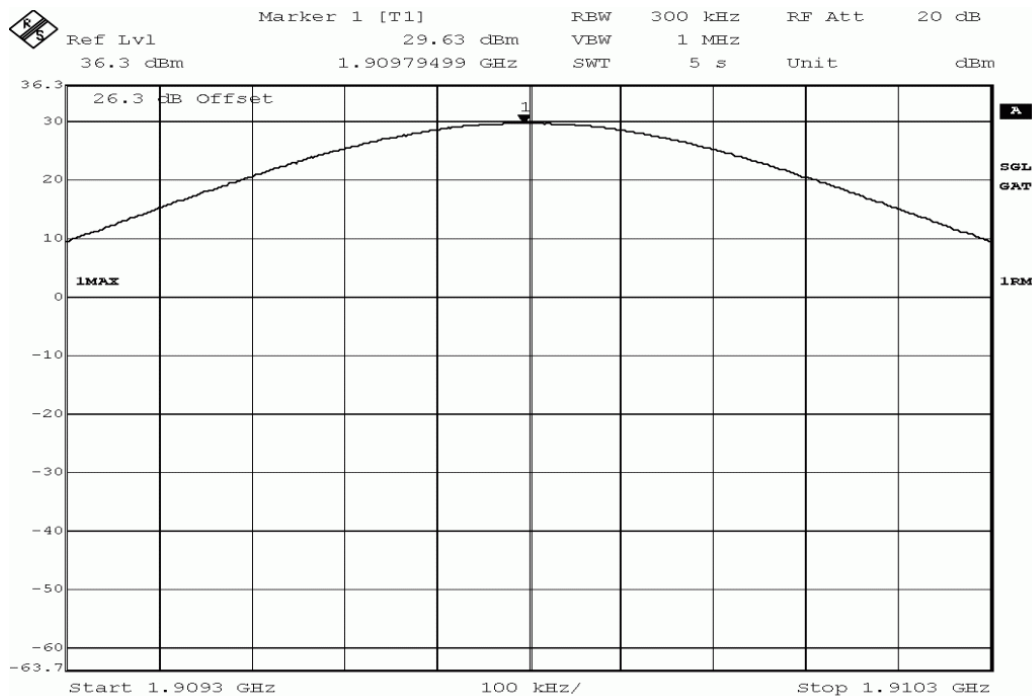

Title: output power measurement
 Comment A: DE1015016, GSM1900, output power,
 channel 810 (1909.8MHz)
 Date: 8.APR.2015 18:29:09

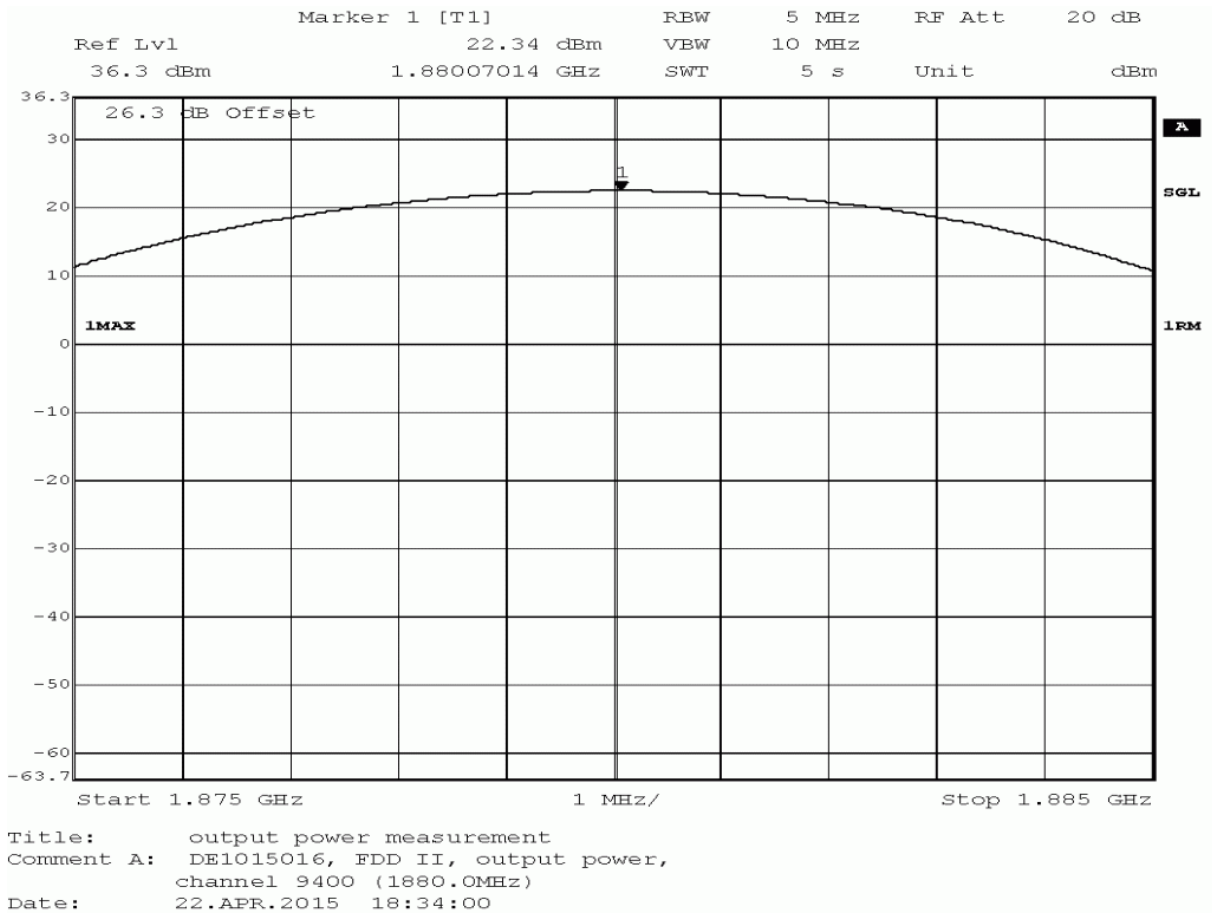

6.5.8 24.2 Frequency stability

Not tested.

6.5.9 24.3 Spurious emissions at antenna terminals §2.1051, §24.238

Band	Mode	Channel	detector	Resolution Bandwidth	Frequency (MHz)	Measured values closer 20 dB to limit (dBm)	Deviation to original results	Verdict
1900	GSM	low	peak	3	1850	-16.4	-0.2	Passed
		mid	-	-	-	-	-	-
		high	peak	3	1910	-17	-0.6	Passed
FDD2	UMTS	low	rms	100	1849	-22.2	3	Passed
		low	rms	50	1850	-24.9	1.9	Passed
		mid	-	-	-	-	-	-
		high	rms	50	1910	-25.8	2.3	Passed
		high	rms	100	1911	-19	2.3	Passed
	HSDPA	low	rms	50	1850	-33.11	-6.51	Passed
		mid	-	-	-	-	-	-
		high	rms	50	1910	-24.9	3	Passed
		high	rms	100	1911	-19.9	2.1	Passed
	HSUPA	low	rms	100	1849	-21.3	4.4	Passed
		low	rms	50	1850	-25.5	1.5	Passed
		mid	-	-	-	-	-	-
		high	rms	50	1910	-25.6	-0.1	Passed
		high	rms	100	1911	-19	1.3	Passed

Negative deviation => values of new module are lower than original result values

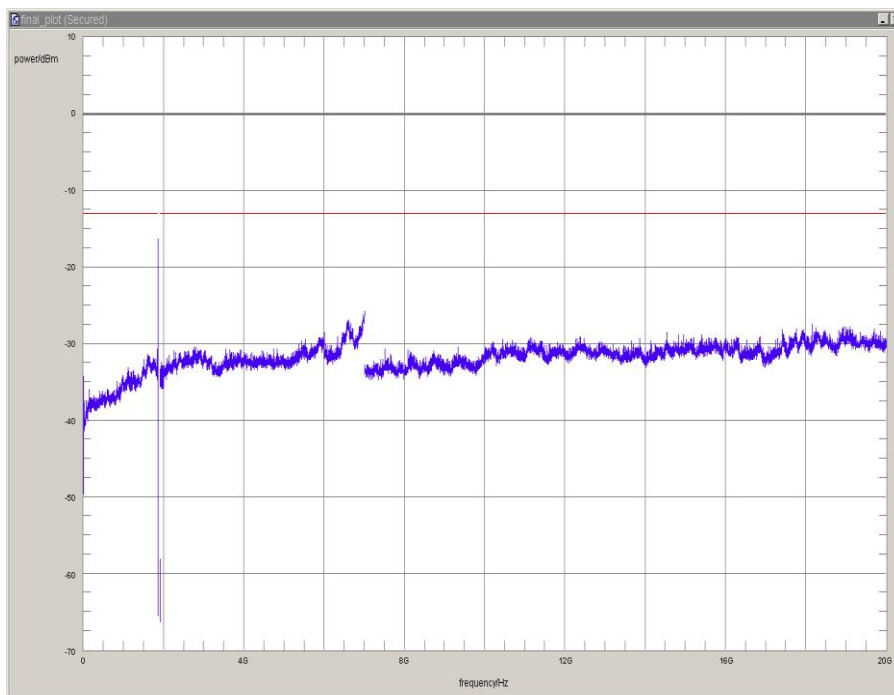

GSM1900, low channel

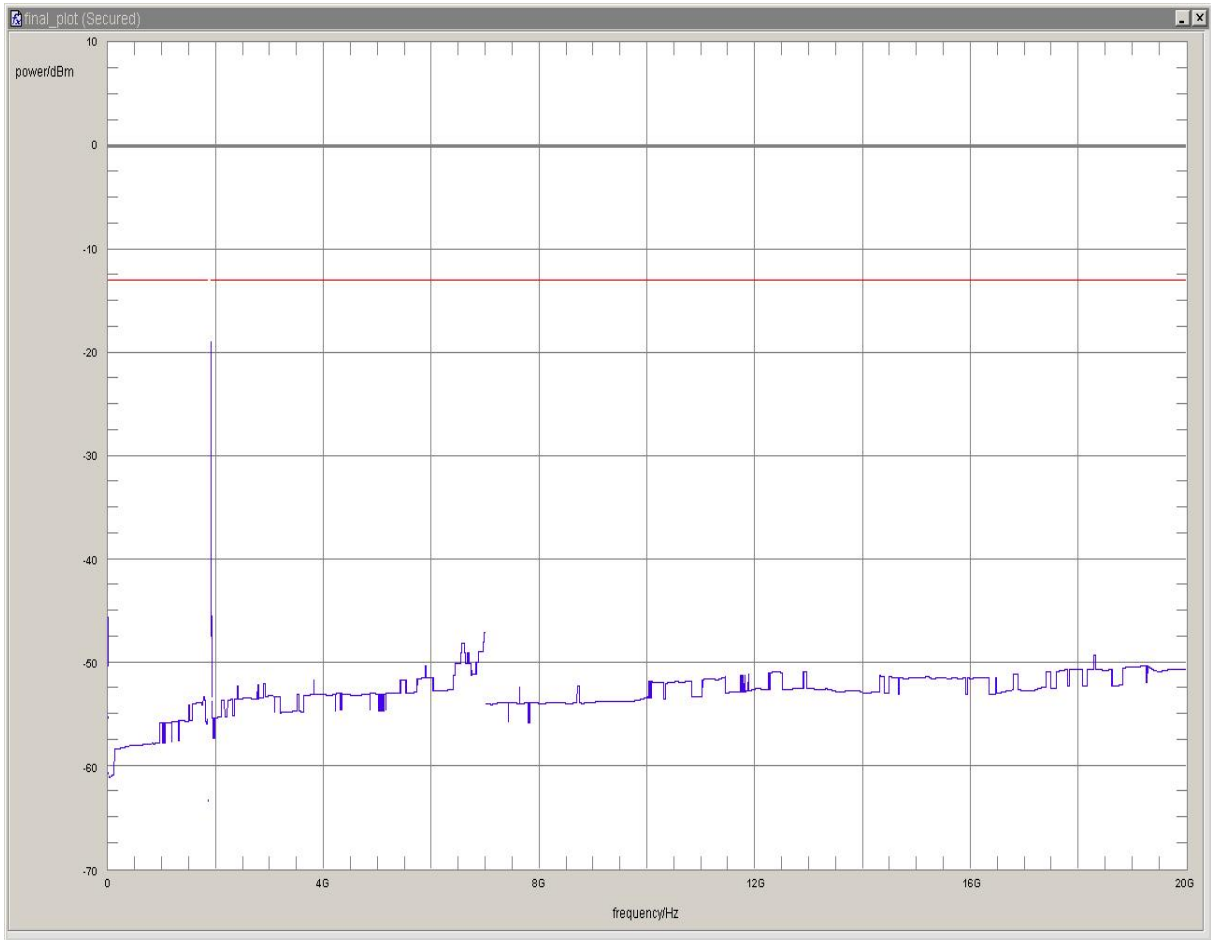

WCDMA, high channel

6.5.10 24.4 Field strength of spurious radiation §2.1053, §24.238

Band	Mode	Channel	detector	Resolution Bandwidth	Frequency (MHz)	Measured values closer 20 dB to limit (dBm)	Deviation to original results	Verdict
1900	GSM	low	peak	100	1849	-31.25	6.2	Passed
			peak	3	1850	-17.23	4.49	Passed
		high	peak	3	1910	-28.53	-4.95	Passed
FDD2	UMTS	mid	-	-	-	-	-	-
	HSUPA	low	peak	100	1849	-29.6	-3.03	Passed
			peak	50	1850	-31.26	-1.91	Passed
		high	peak	50	1910	-16.75	8.69	Passed
		high	peak	100	1911	-18.12	4.38	Passed

Negative deviation => values of new module are lower than original result values

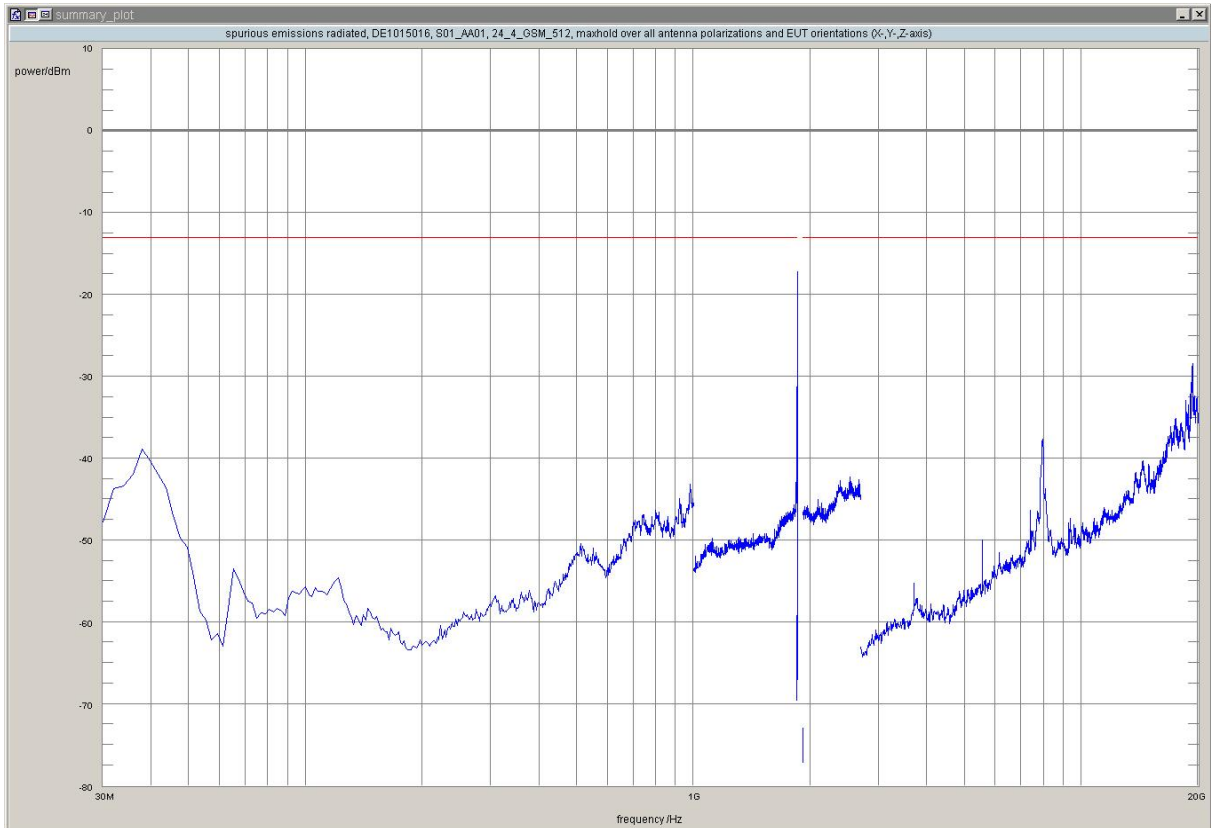

GSM 1900, low channel

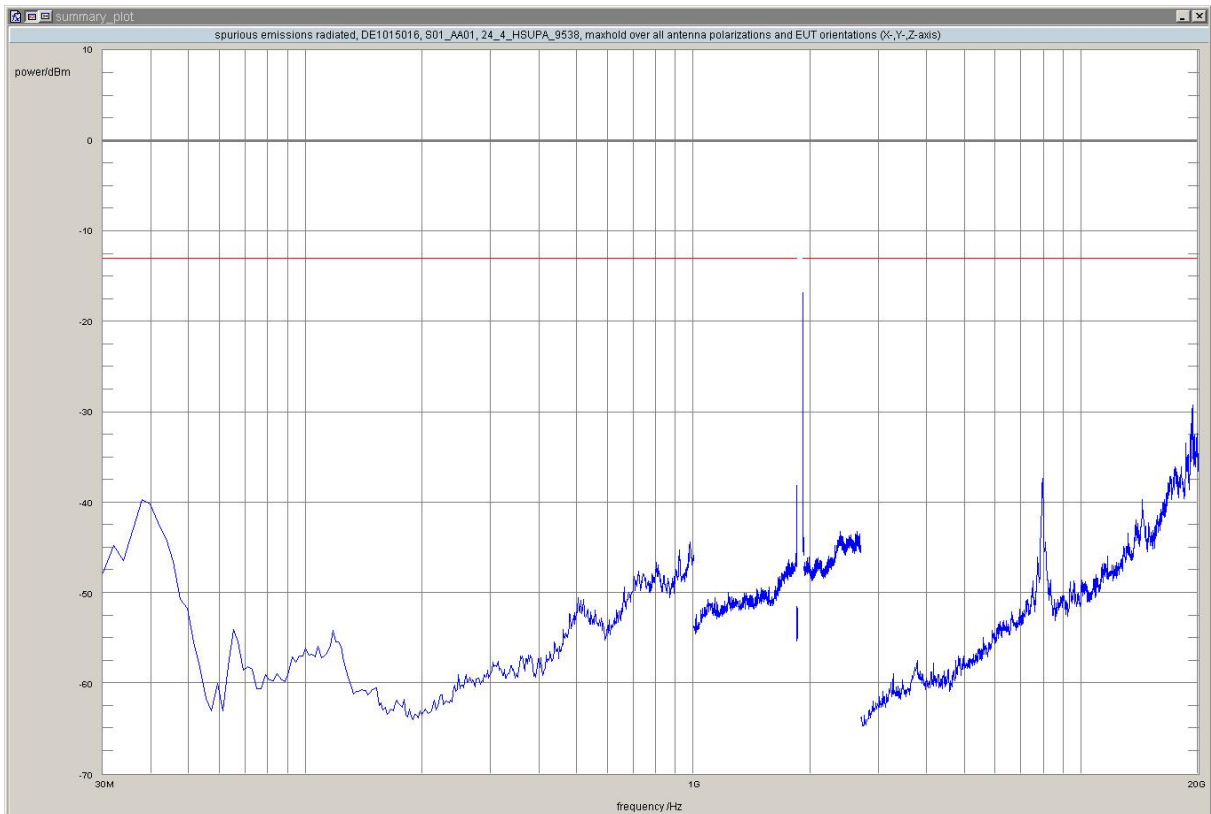

HSUPA, high channel

6.5.11 24.5 Emission and Occupied Bandwidth §2.1049, § 24.238

Band	Mode	Channel	-26 dB BW (kHz)	99 % BW (kHz)	Deviation to original values	
					-26 dB BW (kHz)	16QAM (kHz)
1900	GSM	low	316.6	244.5	10.6	2.0
		mid	314.6	242.5	2.0	-2.0
		High	310.6	244.5	-2.0	0.0
	EDGE	low	302.6	244.5	-8.0	2.0
		mid	300.6	246.5	-8.0	2.0
		High	298.6	244.5	2.0	-2.0
FDD2	WCDMA	low	4729.5	4128.5	0.0	-19.8
		mid	4749.5	4128.3	20.0	-20.0
		High	4729.5	4128.3	0.0	0.0
	HSDPA	low	4749.5	4148.3	-20.0	0.0
		mid	4749.5	4148.3	0.0	-20.0
		High	4749.5	4148.3	0.0	-20.0
	HSUPA	low	4749.5	4168.3	0.0	40.0
		mid	4769.5	4168.3	40.0	20.0
		High	4769.5	4188.4	20.0	60.1

Negative deviation => values of new hard- / software are lower than original result values

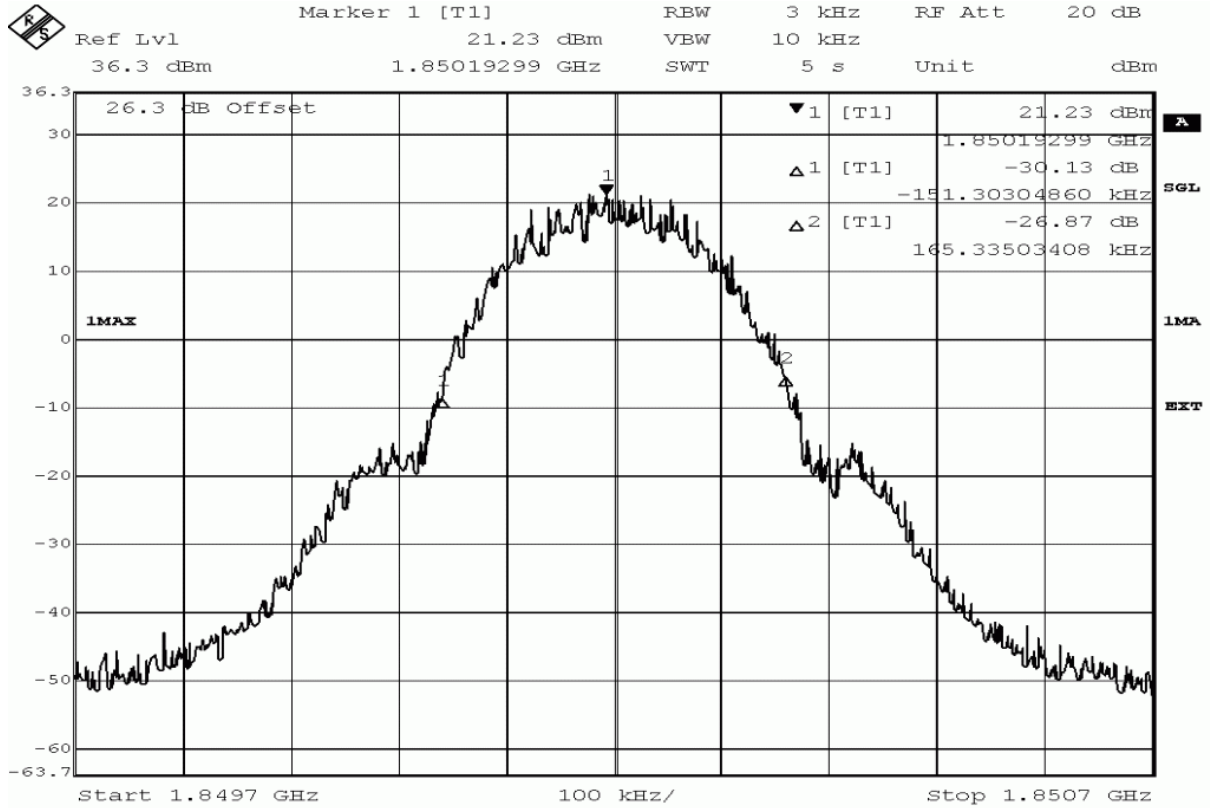

Title: bandwidth measurement
 Comment A: DE1015016, GSM1900, 26dB bandwidth,
 channel 512 (1850.2MHz)
 Date: 17.APR.2015 12:35:15

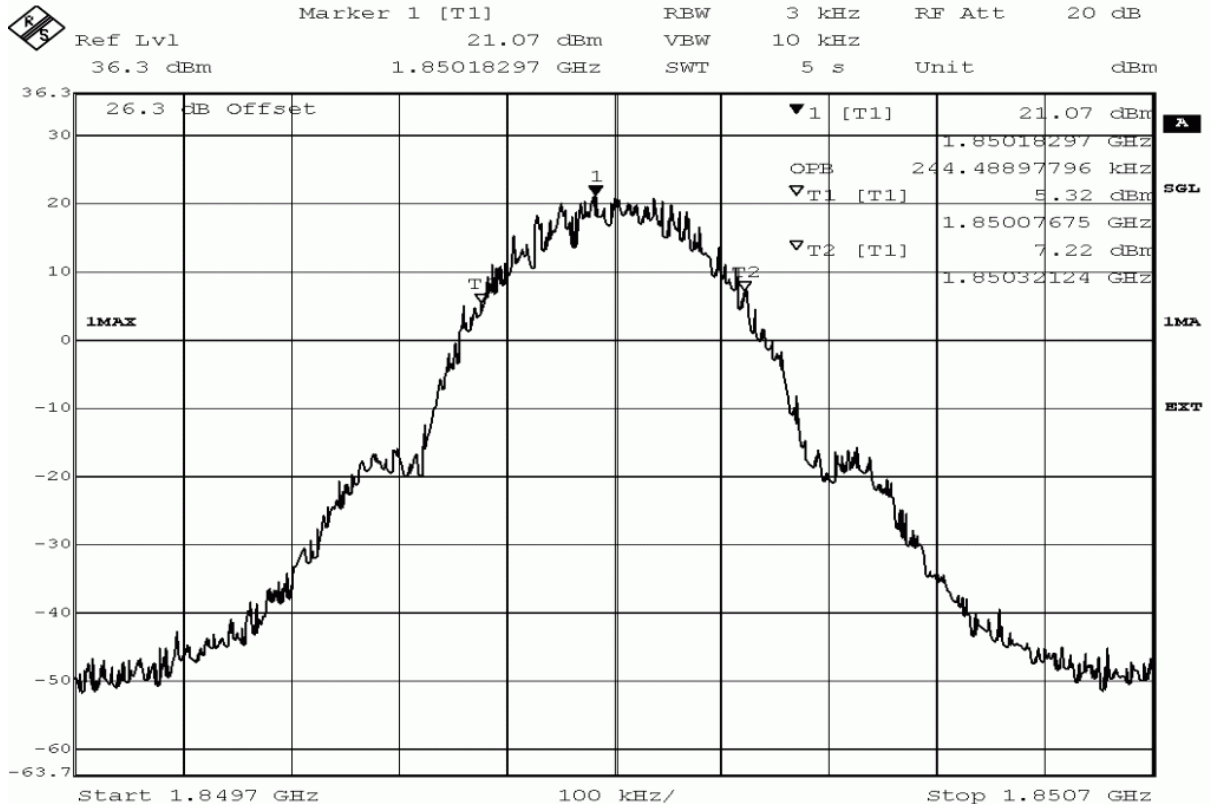

Title: bandwidth measurement
 Comment A: DE1015016, GSM1900, occupied bandwidth (99%),
 channel 512 (1850.2MHz)
 Date: 17.APR.2015 12:35:38

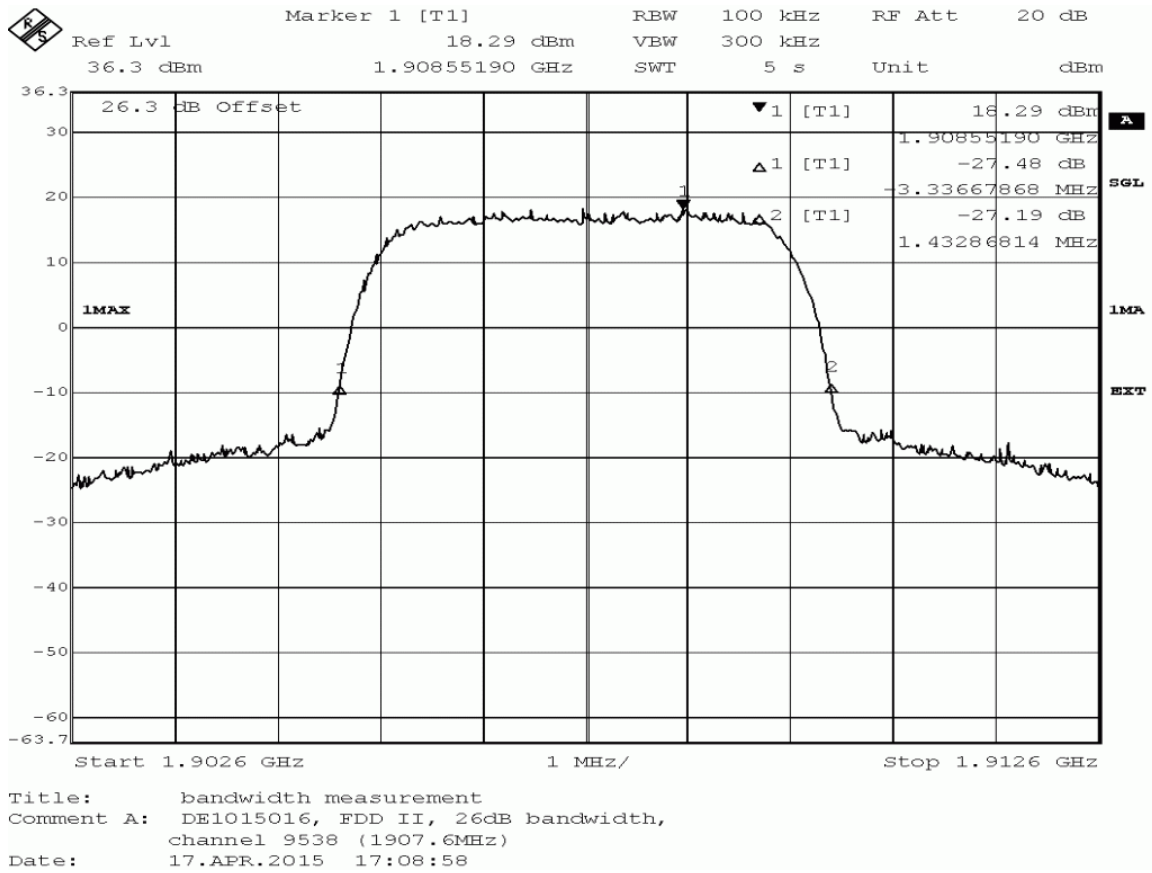

HSUPA, high channel

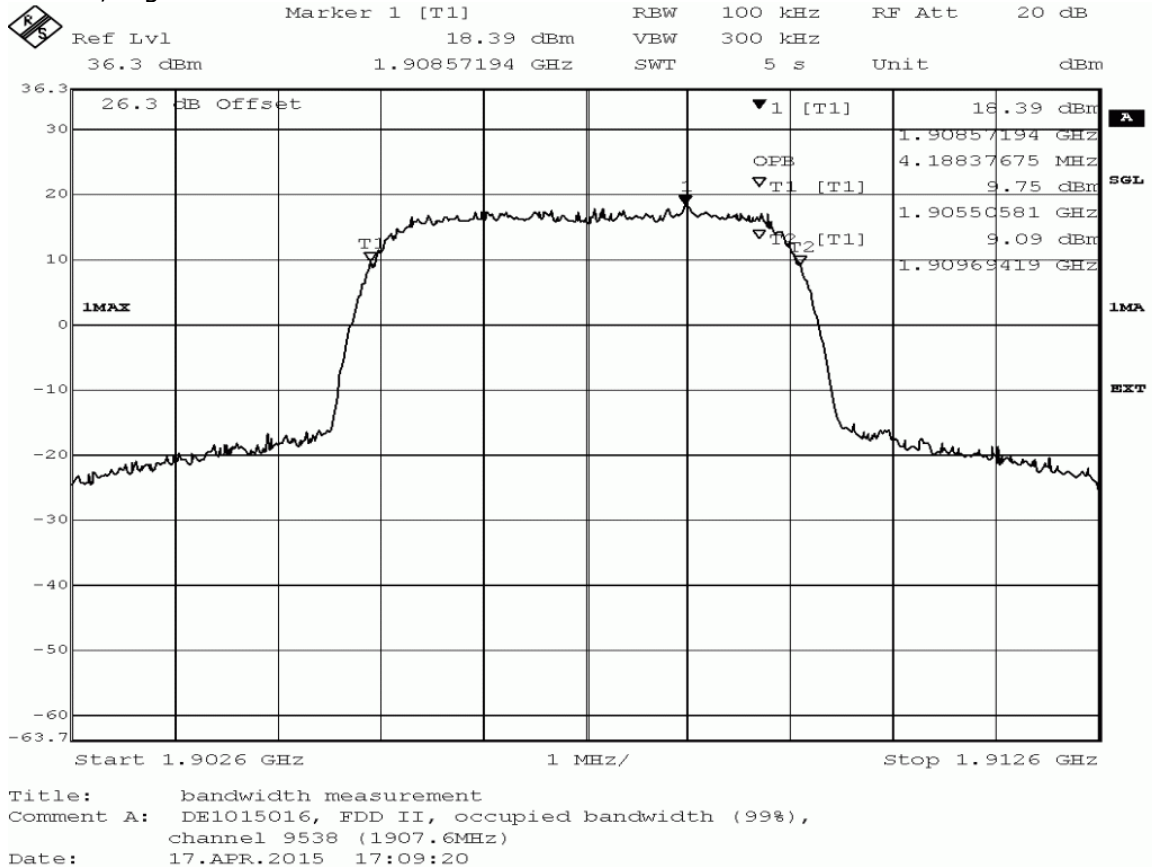

HSUPA, high channel

6.5.12 24.6 Band edge compliance §2.1053, §24.238

Band	Mode	Modulation	Channel	Detector	Peak Value (dBm)	Deviation to original results (dB)	Limit (dBm)	Verdict
1900	GSM	QPSK	low	Peak	-16.11	1.94	-13	Passed
				Average	-37.68	0.76	-13	Passed
				RMS	-30.32	0.65	-13	Passed
			high	Peak	-18.06	-0.59	-13	Passed
				Average	-36.99	2.28	-13	Passed
				RMS	-28.64	3.02	-13	Passed
	EDGE	8PSK	low	Peak	-26.27	3.85	-13	Passed
				Average	-45.29	7.95	-13	Passed
				RMS	-37.68	7.61	-13	Passed
			high	Peak	-25.04	7.74	-13	Passed
				Average	-47.22	12.05	-13	Passed
				RMS	-38.44	6.85	-13	Passed
FDD2	WCDMA	QPSK	low	Peak	-16.6	1.05	-13	Passed
				Average	-25.11	1.09	-13	Passed
				RMS	-24.3	1.34	-13	Passed
			high	Peak	-15.86	1.75	-13	Passed
				Average	-25.11	3.03	-13	Passed
				RMS	-24.3	2.92	-13	Passed
	HSDPA	QPSK	low	Peak	-17.06	1.72	-13	Passed
				Average	-25.46	1.34	-13	Passed
				RMS	-24.46	1.55	-13	Passed
			high	Peak	-15.24	2.57	-13	Passed
				Average	-24.78	3.12	-13	Passed
				RMS	-24	2.8	-13	Passed
	HSUPA	QPSK	low	Peak	-17.14	0.43	-13	Passed
				Average	-25.29	0.72	-13	Passed
				RMS	-24.3	0.65	-13	Passed
			high	Peak	-15.74	-0.1	-13	Passed
				Average	-25.82	0.38	-13	Passed
				RMS	-24.78	0.33	-13	Passed

Negative deviation => values of new module are lower than original result values

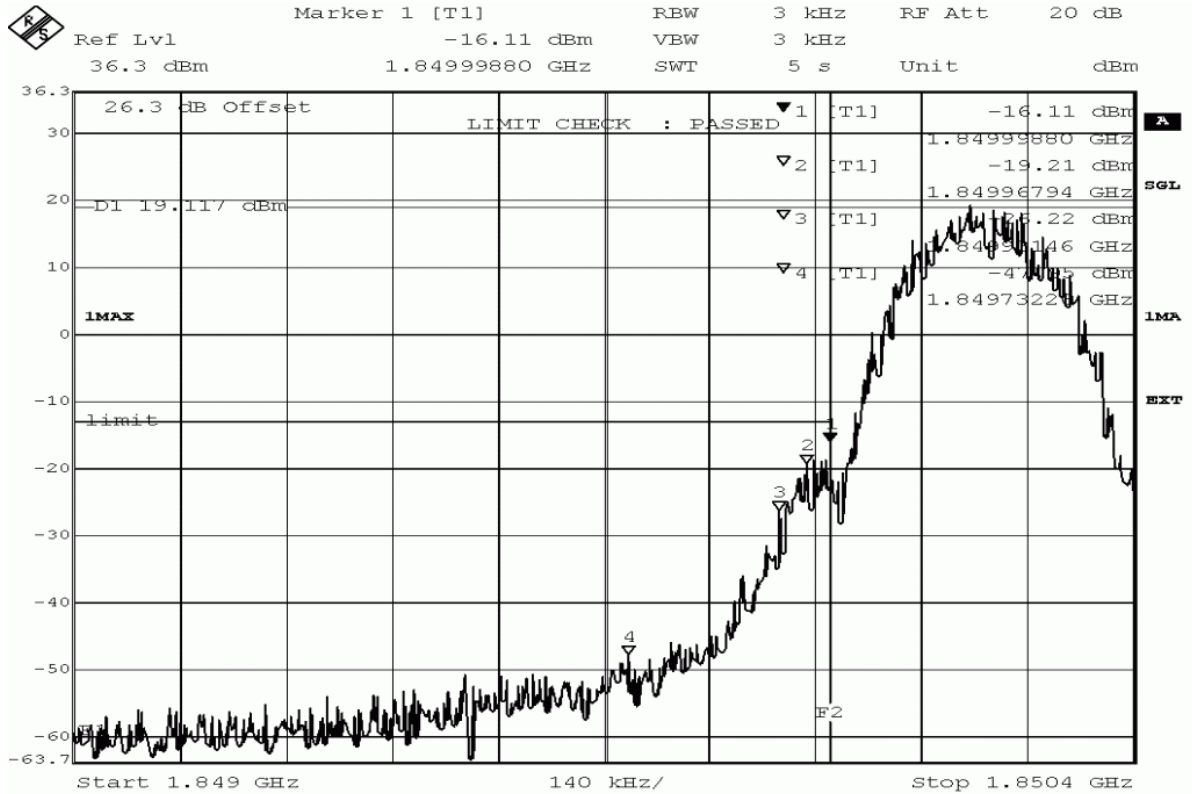

Title: band edge compliance measurement
Comment A: DE1015016, GSM1900, band edge compliance, channel 512 (1850.2MHz)
Date: 17.APR.2015 12:36:03

	Marker 1 [T1]	RBW	50 kHz	RF Att	20 dB
Ref Lvl	-24.00 dBm	VBW	50 kHz		
36.3 dBm	1.91000040 GHz	SWT	5 s	Unit	dBm

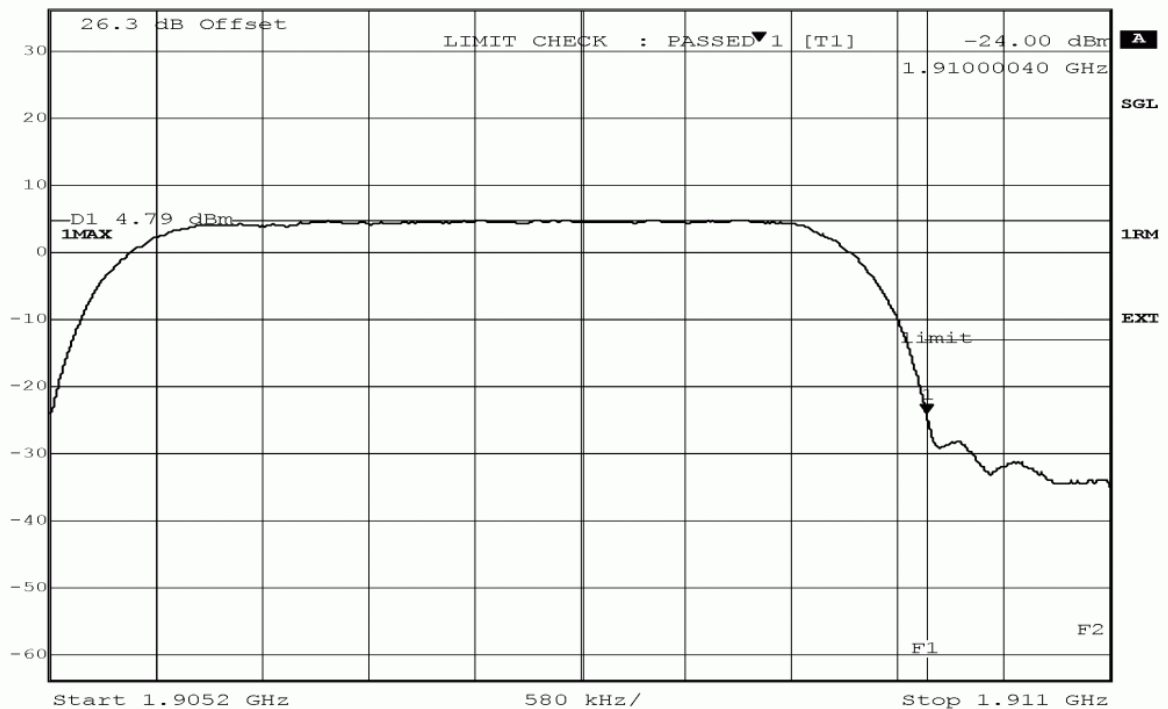

Title: band edge compliance measurement
Comment A: DE1015016, FDD II HSUPA, band edge compliance, channel 9262 (1852.4MHz)
Date: 7.APR.2015 17:15:00

HSDPA, high channel (wrong plot comment)

7 Test Equipment Details for TOBY-L280

7.1 List of Used Test Equipment

The calibration, hardware and software states are shown for the testing period.

Test Equipment Anechoic Chamber

Lab ID:	Lab 1		
<i>Manufacturer:</i>	Frankonia		
<i>Description:</i>	Anechoic Chamber for radiated testing		
<i>Type:</i>	10.58x6.38x6.00 m ³		
	<i>Calibration Details</i>	<i>Last Execution</i>	<i>Next Execution</i>
	NSA (FCC)	2014/01/09	2017/01/09

Single Devices for Anechoic Chamber

<i>Single Device Name</i>	<i>Type</i>	<i>Serial Number</i>	<i>Manufacturer</i>	
Air compressor	none	-	Atlas Copco	
Anechoic Chamber	10.58 x 6.38 x 6.00 m ³	none	Frankonia	
	<i>Calibration Details</i>		<i>Last Execution</i>	<i>Next Execution</i>
	FCC listing 96716 3m Part15/18		2014/01/09	2017/01/08
Controller Maturo	MCU	961208	Maturo GmbH	
EMC camera	CE-CAM/1	-	CE-SYS	
EMC camera Nr.2	CCD-400E	0005033	Mitsubishi	
Filter ISDN	B84312-C110-E1		Siemens&Matsushita	
Filter Universal 1A	BB4312-C30-H3	-	Siemens&Matsushita	

Test Equipment Auxiliary Equipment for Radiated emissions

Lab ID:	Lab 1
<i>Description:</i>	Equipment for emission measurements
<i>Serial Number:</i>	see single devices

Single Devices for Auxiliary Equipment for Radiated emissions

<i>Single Device Name</i>	<i>Type</i>	<i>Serial Number</i>	<i>Manufacturer</i>		
Antenna mast	AM 4.0	AM4.0/180/11920 513	Maturo GmbH		
Biconical Broadband Antenna	SBA 9119	9119-005	Schwarzbeck		
Biconical dipole	VUBA 9117	9117-108	Schwarzbeck		
Broadband Amplifier 18MHz-26GHz	JS4-18002600-32-5P	849785	Miteq		
Broadband Amplifier 1GHz-4GHz	AFS4-01000400-1Q-10P-4	-	Miteq		
Broadband Amplifier 30MHz-18GHz	JS4-00101800-35-5P	896037	Miteq		
Cable "ESI to EMI Antenna"	EcoFlex10	W18.01- 2+W38.01-2	Kabel Kusch		
Cable "ESI to Horn Antenna"	UFB311A+UFB293C	W18.02- 2+W38.02-2	Rosenberger Micro-Coax		
Double-ridged horn	HF 906	357357/001	Rohde & Schwarz GmbH & Co. KG	<i>Last Execution</i>	<i>Next Execution</i>
	<i>Calibration Details</i>			2012/05/18	2015/05/17
	Standard Calibration				
Double-ridged horn	HF 906	357357/002	Rohde & Schwarz GmbH & Co. KG	<i>Last Execution</i>	<i>Next Execution</i>
	<i>Calibration Details</i>			2012/06/26	2015/06/25
	Standard Calibration				
High Pass Filter	4HC1600/12750-1.5-KK	9942011	Trilithic		
High Pass Filter	5HC2700/12750-1.5-KK	9942012	Trilithic		
High Pass Filter	5HC3500/12750-1.2-KK	200035008	Trilithic		
High Pass Filter	WHKX 7.0/18G-8SS	09	Wainwright		
Horn Antenna Schwarzbeck 15-26 GHz BBHA 9170	BBHA 9170	BBHA9170262			
Log.-per. Antenna	HL 562 Ultralog	100609	Rohde & Schwarz GmbH & Co. KG	<i>Last Execution</i>	<i>Next Execution</i>
	<i>Calibration Details</i>			2012/12/18	2015/12/17
	Standard Calibration				
Log.-per. Antenna	HL 562 Ultralog	830547/003	Rohde & Schwarz GmbH & Co. KG		
Loop Antenna	HFH2-Z2	829324/006	Rohde & Schwarz GmbH & Co. KG	<i>Last Execution</i>	<i>Next Execution</i>
	<i>Calibration Details</i>			2014/11/27	2017/11/27
	DKD Calibration				
Standard Gain / Pyramidal Horn Antenna 26,5 GHz	3160-09	00083069	EMCO Elektronik GmbH		

Single Devices for Auxiliary Equipment for Radiated emissions (continued)

<i>Single Device Name</i>	<i>Type</i>	<i>Serial Number</i>	<i>Manufacturer</i>
Standard Gain / Pyramidal Horn Antenna 40 GHz	3160-10	00086675	EMCO Elektronik GmbH
Tilt device Maturo (Rohacell)	Antrieb TD1.5-10kg	TD1.5- 10kg/024/379070 9	Maturo GmbH

Test Equipment Auxiliary Test Equipment

Lab ID:	Lab 1, Lab 2
<i>Manufacturer:</i>	see single devices
<i>Description:</i>	Single Devices for various Test Equipment
<i>Type:</i>	various
<i>Serial Number:</i>	none

Single Devices for Auxiliary Test Equipment

<i>Single Device Name</i>	<i>Type</i>	<i>Serial Number</i>	<i>Manufacturer</i>		
Broadband Power Divider N (Aux)	1506A / 93459	LM390	Weinschel Associates		
Broadband Power Divider SMA	WA1515	A855	Weinschel Associates		
Digital Multimeter 03 (Multimeter)	Fluke 177	86670383	Fluke Europe B.V.		
	<i>Calibration Details</i>			<i>Last Execution</i>	<i>Next Execution</i>
	Customized calibration			2013/12/04	2015/12/03
Fibre optic link Satellite (Aux)	FO RS232 Link	181-018	Pontis		
Fibre optic link Transceiver (Aux)	FO RS232 Link	182-018	Pontis		
Isolating Transformer	LTS 604	1888	Thalheimer Transformatorenwerke GmbH		
Notch Filter Ultra Stable (Aux)	WRCA800/960-6EEK	24	Wainwright		
Signal Analyzer	FSV30	103005	Rohde & Schwarz GmbH & Co. KG		
	<i>Calibration Details</i>			<i>Last Execution</i>	<i>Next Execution</i>
	Standard			2014/02/10	2016/02/09
Spectrum Analyser	FSP3	836722/011	Rohde & Schwarz GmbH & Co. KG		
	<i>Calibration Details</i>			<i>Last Execution</i>	<i>Next Execution</i>
	Standard			2012/06/13	2015/06/12
Spectrum Analyser	FSU26	200418	Rohde & Schwarz GmbH & Co.KG		
	<i>Calibration Details</i>			<i>Last Execution</i>	<i>Next Execution</i>
	Standard calibration			2014/07/29	2015/07/28
Vector Signal Generator	SMIQ 03B	832492/061	Rohde & Schwarz GmbH & Co.KG		

Test Equipment Digital Signalling Devices

Lab ID: Lab 1, Lab 2
Description: Signalling equipment for various wireless technologies.

Single Devices for Digital Signalling Devices

Single Device Name	Type	Serial Number	Manufacturer	
CMW500	CMW500	107500	Rohde & Schwarz GmbH & Co.KG	
	<i>Calibration Details</i>		<i>Last Execution</i>	<i>Next Execution</i>
	Standard calibration		2014/01/27	2016/01/26
Digital Radio Communication Tester	CMD 55	831050/020	Rohde & Schwarz GmbH & Co. KG	
	<i>Calibration Details</i>		<i>Last Execution</i>	<i>Next Execution</i>
	DKD calibration		2014/12/02	2017/12/01
Universal Radio Communication Tester	CMU 200	102366	Rohde & Schwarz GmbH & Co. KG	
	<i>HW/SW Status</i>		<i>Date of Start</i>	<i>Date of End</i>
	Hardware: B11, B21V14, B21-2, B41, B52V14, B52-2, B53-2, B56V14, B68 3v04, PCMCIA, U65V04 Software: K21 4v21, K22 4v21, K23 4v21, K24 4v21, K42 4v21, K43 4v21, K53 4v21, K56 4v22, K57 4v22, K58 4v22, K59 4v22, K61 4v22, K62 4v22, K63 4v22, K64 4v22, K65 4v22, K66 4v22, K67 4v22, K68 4v22, K69 4v22 Firmware: µP1 8v50 02.05.06 ---		2007/07/16	
Universal Radio Communication Tester	CMU 200	837983/052	Rohde & Schwarz GmbH & Co. KG	
	<i>Calibration Details</i>		<i>Last Execution</i>	<i>Next Execution</i>
	DKD calibration		2014/12/03	2017/12/02
	<i>HW/SW Status</i>		<i>Date of Start</i>	<i>Date of End</i>
	HW options: B11, B21V14, B21-2, B41, B52V14, B52-2, B53-2, B54V14, B56V14, B68 3v04, B95, PCMCIA, U65V02 SW options: K21 4v11, K22 4v11, K23 4v11, K24 4v11, K27 4v10, K28 4v10, K42 4v11, K43 4v11, K53 4v10, K65 4v10, K66 4v10, K68 4v10, Firmware: µP1 8v40 01.12.05 --- SW: K62, K69	2007/01/02	2008/11/03	
Vector Signal Generator	SMU200A	100912	Rohde & Schwarz GmbH & Co. KG	

Test Equipment Emission measurement devices

Lab ID: **Lab 1**
Description: Equipment for emission measurements
Serial Number: see single devices

Single Devices for Emission measurement devices

<i>Single Device Name</i>	<i>Type</i>	<i>Serial Number</i>	<i>Manufacturer</i>	
EMI Receiver / Spectrum Analyser	ESR 7	101424	Rohde & Schwarz	
	<i>Calibration Details</i>		<i>Last Execution</i>	<i>Next Execution</i>
	Initial Factory Calibration		2014/11/13	2016/11/12
Personal Computer	Dell	30304832059	Dell	
Power Meter	NRVD	828110/016	Rohde & Schwarz GmbH & Co.KG	
	<i>Calibration Details</i>		<i>Last Execution</i>	<i>Next Execution</i>
	Standard calibration		2014/05/13	2015/05/10
	Standard calibration		2015/05/11	2016/05/10
Sensor Head A	NRV-Z1	827753/005	Rohde & Schwarz GmbH & Co.KG	
	<i>Calibration Details</i>		<i>Last Execution</i>	<i>Next Execution</i>
	Standard calibration		2014/05/13	2015/05/10
	Standard calibration		2015/05/11	2016/05/10
Signal Generator	SMR 20	846834/008	Rohde & Schwarz GmbH & Co. KG	
	<i>Calibration Details</i>		<i>Last Execution</i>	<i>Next Execution</i>
	Standard Calibration		2014/06/24	2017/06/23
Spectrum Analyser	FSW 43	103779	Rohde & Schwarz	
	<i>Calibration Details</i>		<i>Last Execution</i>	<i>Next Execution</i>
	Initial Factory Calibration		2014/11/17	2016/11/16
Spectrum Analyzer	ESIB 26	830482/004	Rohde & Schwarz GmbH & Co. KG	
	<i>Calibration Details</i>		<i>Last Execution</i>	<i>Next Execution</i>
	Standard Calibration		2014/01/07	2016/01/31
	<i>HW/SW Status</i>		<i>Date of Start</i>	<i>Date of End</i>
	Firmware-Update 4.34.4 from 3.45 during calibration		2009/12/03	

Test Equipment Radio Lab Test Equipment

Lab ID: Lab 2
Description: Radio Lab Test Equipment

Single Devices for Radio Lab Test Equipment

Single Device Name	Type	Serial Number	Manufacturer	
Broadband Power Divider SMA	WA1515	A856	Weinschel Associates	
Coax Attenuator 10dB SMA 2W	4T-10	F9401	Weinschel Associates	
Coax Attenuator 10dB SMA 2W	56-10	W3702	Weinschel Associates	
Coax Attenuator 10dB SMA 2W	56-10	W3711	Weinschel Associates	
Coax Cable Huber&Suhner	Sucotest 2,0m		Huber&Suhner	
Coax Cable Rosenberger Micro Coax FA210A0010003030 SMA/SMA 1,0m	FA210A0010003030	54491-2	Rosenberger Micro-Coax	
Power Meter	NRVD	828110/016	Rohde & Schwarz GmbH & Co.KG	
	<i>Calibration Details</i>		<i>Last Execution</i>	<i>Next Execution</i>
	Standard calibration		2014/05/13	2015/05/10
	Standard calibration		2015/05/11	2016/05/10
RF Step Attenuator RSP	RSP	833695/001	Rohde & Schwarz GmbH & Co.KG	
Rubidium Frequency Standard	Datum, Model: MFS	5489/001	Datum-Beverly	
	<i>Calibration Details</i>		<i>Last Execution</i>	<i>Next Execution</i>
	Standard calibration		2014/07/03	2015/07/02
Sensor Head A	NRV-Z1	827753/005	Rohde & Schwarz GmbH & Co.KG	
	<i>Calibration Details</i>		<i>Last Execution</i>	<i>Next Execution</i>
	Standard calibration		2014/05/13	2015/05/10
	Standard calibration		2015/05/11	2016/05/10
Signal Generator SME	SME03	827460/016	Rohde & Schwarz GmbH & Co.KG	
	<i>Calibration Details</i>		<i>Last Execution</i>	<i>Next Execution</i>
	Standard calibration		2014/12/02	2017/12/01
Signal Generator SMP	SMP02	836402/008	Rohde & Schwarz GmbH & Co. KG	
	<i>Calibration Details</i>		<i>Last Execution</i>	<i>Next Execution</i>
	Standard calibration		2013/05/06	2016/05/05

Test Equipment T/A Logger 13

Lab ID: Lab 1, Lab 2
Description: Lufft Opus10 TPR
Type: Opus10 TPR
Serial Number: 13936

Single Devices for T/A Logger 13

Single Device Name	Type	Serial Number	Manufacturer
ThermoAirpressure Datalogger 13 (Environ)	Opus10 TPR (8253.00)	13936	Lufft Mess- und Regeltechnik GmbH
<i>Calibration Details</i>			<i>Last Execution</i> <i>Next Execution</i>
Customized calibration			2015/02/27 2017/02/26

Test Equipment T/H Logger 03

Lab ID: Lab 2
Description: Lufft Opus10
Serial Number: 7482

Single Devices for T/H Logger 03

Single Device Name	Type	Serial Number	Manufacturer
ThermoHygro Datalogger 03 (Environ)	Opus10 THI (8152.00)	7482	Lufft Mess- und Regeltechnik GmbH
<i>Calibration Details</i>			<i>Last Execution</i> <i>Next Execution</i>
Customized calibration			2015/02/27 2017/02/26

Test Equipment T/H Logger 12

Lab ID: Lab 1
Description: Lufft Opus10
Serial Number: 12482

Single Devices for T/H Logger 12

Single Device Name	Type	Serial Number	Manufacturer
ThermoHygro Datalogger 12 (Environ)	Opus10 THI (8152.00)	12482	Lufft Mess- und Regeltechnik GmbH
<i>Calibration Details</i>			<i>Last Execution</i> <i>Next Execution</i>
Customized calibration			2015/03/10 2017/03/09

Test Equipment Temperature Chamber 05

Lab ID: Lab 2
Manufacturer: see single devices
Description: Temperature Chamber VT4002
Type: Vötsch
Serial Number: see single devices

Single Devices for Temperature Chamber 05

Single Device Name	Type	Serial Number	Manufacturer
Temperature Chamber Vötsch 05	VT 4002	58566080550010	Vötsch
<i>Calibration Details</i>			<i>Last Execution</i> <i>Next Execution</i>
Customized calibration			2014/03/11 2016/03/10

8 Annex

8.1 Additional Information for Report

This facility has been fully described in a report submitted to the IC and accepted under the registration number: Site# 3699A-1

Correlation of measurement requirements for Cellular Equipment from FCC and IC

FCC Rule / IC Standard	Part 22 / RSS-132		Part 24 / RSS-133 (NA)		Part 27 / RSS-130 / RSS-139 / RSS-199			
	Effective (isotropic) Radiated Power	§2.1046 §22.913	RSS-GEN, §4.8 RSS-132, §5.4	§2.1046 §24.232	RSS-GEN, §4.8 RSS-133, §6.4	§2.1046 §27.50 (d)	RSS-GEN, §4.8 RSS-130; §4.4	RSS-GEN, §4.8 RSS-139; §6.4
Occupied Bandwidth	§2.1049	RSS-GEN §4.6	§2.1049	RSS-GEN §4.6	§2.1049	RSS-GEN §4.6	RSS-GEN §4.6	RSS-GEN §4.6
"Spuri" at Antenna Terminal	§2.1051 §22.917	RSS-GEN, §4.9 RSS-132, §5.5	§2.1051 §24.238	RSS-GEN, §4.9 RSS-132, §6.5	§2.1051 §27.5 (h)	RSS-GEN, §4.9 RSS-130, §4.6	RSS-GEN, §4.9 RSS-139, §6.5	RSS-GEN, §4.9 RSS-199, §4.6
Band Edge compliance	§2.1051 §22.917	RSS-GEN, §4.6	§2.1051 §24.238	RSS-GEN, §4.6	§2.1051 §27.5 (h)	RSS-GEN, §4.6	RSS-GEN, §4.6	RSS-GEN, §4.6
Frequency Stability	§2.1055 §22.355	RSS-GEN, §4.7	§2.1055 §24.235	RSS-GEN, §4.7 RSS-132, §6.3	§2.1055 §27.51	RSS-GEN, §4.7 RSS-130, §4.3	RSS-GEN, §4.7 RSS-139, §6.3	RSS-GEN, §4.7 RSS-199, §4.3
Peak to Average Ratio	N/A	RSS-132, §5.3	§2.1046 §24.232	RSS-133, §6.4	§2.1046 §27.50 (d)	RSS-130; §4.4	RSS-139, §6.4	NA
Modulation Characteristics	§2.1047	RSS-132, §5.4	§2.1047	RSS-133, §6.2	§2.1047	RSS-130, §4.1	RSS-139, §6.2	RSS-199, §4.1
Field Strength of Spurious Radiation	§2.1053 §22.917	RSS-132, §5.2	§2.1053 §24.235	RSS-GEN, §4.9 RSS-133, §6.5	§2.1053 §27.51	RSS-GEN, §4.9 RSS-130, §4.6	RSS-GEN, §4.9 RSS-139, §6.5	RSS-GEN, §4.9 RSS-199, §4.6

*) Receivers which are part of Transceivers are exempted with respect to Notice 2012-DRS0126.

Summary of Test Results

The EUT complied with all performed tests as listed in the summary section of this report.

Technical Report Summary

Type of Authorization :

Certification for a GSM/WCDMA/CDMA2000 cellular radiotelephone device

Applicable FCC Rules

Prepared in accordance with the requirements of FCC Rules and Regulations as listed in 47 CFR Ch.1 Parts 0 to 69. The following subparts are applicable to the results in this test report.

Part 2, Subpart J - Equipment Authorization Procedures, Certification

- § 2.1046 Measurement required: RF power output
- § 2.1049 Measurement required: Occupied bandwidth
- § 2.1051 Measurement required: Spurious emissions at antenna terminals
- § 2.1053 Measurement required: Field strength of spurious radiation
- § 2.1055 Measurement required: Frequency stability
- § 2.1057 Frequency spectrum to be investigated

Part 22, Subpart C – Operational and Technical Requirements

- § 22.355 Frequency tolerance

Part 22, Subpart H – Cellular Radiotelephone Service

- § 22.913 Effective radiated power limits
- § 22.917 Emission limitations for cellular equipment

additional documents

ANSI TIA-603-C-2004

Description of Methods of Measurements

RF Power Output

Standard FCC Part 22, Subpart H

The test was performed according to: FCC §2.1046

Test Description (conducted measurement procedure)

- 1) The EUT was coupled to a Spectrum Analyser and a Digital Communication Tester through a Power Divider. Refer to chapter "Setup Drawings".
- 2) The total insertion losses for signal path 1 and signal path 2 were measured. The values were used to correct the readings from the Spectrum Analyser and the Digital Communication Tester.
- 3) A call was established on a Traffic Channel between the EUT and the Digital Communication Tester.
Important Settings:
 - Channel (Frequency): please refer to the detailed results
- 4) The transmitted power of the EUT was recorded by using a spectrum analyser.

Test Description (radiated measurement procedure)

- 1) The EUT was placed inside an anechoic chamber. Refer to chapter "Setup Drawings". The EUT was coupled to a Digital Communication Tester which was located outside the chamber via a small signalling antenna.
- 2) A call was established on a Traffic Channel between the EUT and the Digital Communication Tester.
Important Settings:
 - Output Power: Maximum
 - Channel: please refer to the detailed results
- 3) A substitution procedure is used so that the readings from the spectrum analyser are corrected and represent directly the equivalent radiated power (related to a $\lambda/2$ dipole).
- 4) The output power was measured in both vertical and horizontal antenna polarisation during the call is established on the lowest channel, mid channel and on the highest channel. To find the worst case power all orientations (X, Y, Z) of the EUT have been measured.
- 5) The test procedure according to TIA-603-C-2004 has been considered.

Test Requirements / Limits

§2.1046 Measurements Required: RF Power Output

(a) For transmitters other than single sideband, independent sideband and controlled carrier radiotelephone, power output shall be measured at the RF output terminals when the transmitter is adjusted in accordance with the tune-up procedure to give the values of current and voltage on the circuit elements specified in § 2.1033(c)(8). The electrical characteristics of the output terminals when this test is made shall be stated.

§22.913 Effective radiated power limits

(a)(2) Maximum ERP. ... The ERP of mobile transmitters and auxiliary test transmitters must not exceed 7 Watts.

Emission and Occupied Bandwidth

Standard FCC Part 22, Subpart H

The test was performed according to: FCC §2.1049

Test Description

- 1) The EUT was coupled to a Spectrum Analyser and a Digital Communication Tester through a Power Divider. Refer to chapter "Setup Drawings".
- 2) The total insertion losses for signal path 1 and signal path 2 were measured. The values were used to correct the readings from the Spectrum Analyser and the Digital Communication Tester.
- 3) A call was established on a Traffic Channel between the EUT and the Digital Communication Tester.
Important Settings:
 - Output Power: Maximum
 - Channel: please refer to the detailed results
- 4) Important Analyser Settings:
 - Resolution Bandwidth: >1% of the manufacturer's stated occupied bandwidth
- 5) The maximum spectral level of the modulated signal was recorded as the reference.
- 6) The emission bandwidth is measured as follows:
the two furthest frequencies above and below the frequency of the maximum reference level where the spectrum is -26 dB down have to be found.
- 7) The occupied bandwidth (99% Bandwidth) is measured as follows:
the occupied bandwidth, that is the frequency bandwidth such that, below its lower and above its upper

frequency limits, the mean powers are each equal to 0.5 percent of the total mean power.

Test Requirements / Limits

§ 2.1049 Measurements required: Occupied bandwidth

The occupied bandwidth, that is the frequency bandwidth such that, below its lower and above its upper frequency limits, the mean powers radiated are each equal to 0.5 percent of the total mean power radiated by a given emission shall be measured under the following conditions (as applicable):

(h) Transmitters employing digital modulation techniques - when modulated by an input signal such that its amplitude and symbol rate represent the maximum rated conditions under which the equipment will be operated. The signal shall be applied through any filter networks, pseudo-random generators or other devices required in normal service. Additionally, the occupied bandwidth shall be shown for operation with any devices used for modifying the spectrum when such devices are optional at the discretion of the user.

Spurious emissions at antenna terminals

Standard FCC Part 22, Subpart H

The test was performed according to FCC §2.1051

Test Description

- 1) The EUT was coupled to a Spectrum Analyser and a Digital Communication Tester through a Power Divider. Refer to chapter "Setup Drawings".
- 2) The total insertion losses for signal path 1 and signal path 2 were measured. The values were used to correct the readings from the Spectrum Analyser and the Digital Communication Tester.
- 3) A call was established on a Traffic Channel between the EUT and the Digital Communication Tester.
Important Settings:
 - Output Power: Maximum
 - Channel: please refer to the detailed results
- 4) Important Analyser Settings
 - [Resolution Bandwidth]:
 - a) [$\geq 1\%$ of wanted signal bandwidth] in the Span of 1 MHz directly below and above the PCS-Band,
 - b) otherwise [100 kHz] (or [1 MHz] for accelerated sweep times)
 - c) [reduced resolution bandwidth] in case the curve of the analyser IF-Filter or the wanted EUT signal leads to an exceeding of the limit, in this case a correction factor was used
 - Sweep Time: depending on the transmitting signal, the span and the resolution bandwidth
- 5) The spurious emissions peaks were measured in the frequency range from 9 kHz to 10 GHz (up to the 10th harmonic) during the call was established

Test Requirements / Limits

§ 2.1051 Spurious emissions at antenna terminals

The radio frequency voltage or power generated within the equipment and appearing on a spurious frequency shall be checked at the equipment output terminals when properly loaded with a suitable artificial antenna. Curves or equivalent data shall show the magnitude of each harmonic and other spurious emission that can be detected when the equipment is operated under the conditions specified in Sec. 2.1049 as appropriate. The magnitude of spurious emissions which are attenuated more than 20 dB below the permissible value need not be specified.

§ 2.1057 Frequency spectrum to be investigated.

- (a) In all of the measurements set forth in Secs. 2.1051 and 2.1053, the spectrum shall be investigated from the lowest radio frequency signal generated in the equipment, without going below 9 kHz, up to at least the frequency shown below:
- (1) If the equipment operates below 10 GHz: to the tenth harmonic of the highest fundamental frequency or to 40 GHz, whichever is lower.
 - (b) Particular attention should be paid to harmonics and subharmonics of the carrier frequency as well as to those frequencies removed from the carrier by multiples of the oscillator frequency. Radiation at the

frequencies of multiplier stages should also be checked.

(c) The amplitude of spurious emissions which are attenuated more than 20 dB below the permissible value need not be reported.

(d) Unless otherwise specified, measurements above 40 GHz shall be performed using a minimum resolution bandwidth of 1 MHz.

§ 22.917 Emission limitations for cellular equipment

(a) The power of any emission outside of the authorized operating frequency ranges must be attenuated below the transmitting power (P) by a factor of at least $43 + 10 \log(P)$ dB.

Remark of the test laboratory: This is calculated to be -13 dBm.

(b) Compliance with these rules is based on the use of measurement instrumentation employing a resolution bandwidth of 100 kHz or greater. In the 1 MHz bands immediately outside and adjacent to the frequency block a resolution bandwidth of at least one percent of the emission bandwidth of the fundamental emission of the transmitter may be employed. A narrower resolution bandwidth is permitted in all cases to improve measurement accuracy provided the measured power is integrated over the full required measurement bandwidth (i.e. 100 kHz or 1 percent of emission bandwidth, as specified). The emission bandwidth is defined as the width of the signal between two points, one below the carrier center frequency and one above the carrier center frequency, outside of which all emissions are attenuated at least 26 dB below the transmitter power.

(c) Licensees in this service may establish an alternative out of band emission limit to be used at specified band edge(s) in specified geographical areas [...].

(d) If any emission from a transmitter operating in this service results in interference to users of another radio service, the FCC may require a greater attenuation of that emission than specified in this section.

For reporting only spurious emission levels reaching to the 20dB margin to limit were noted.

Field strength of spurious radiation

Standard FCC Part 22, Subpart H

The test was performed according to: FCC §2.1053

Test Description

1) The EUT was placed inside an anechoic chamber. Refer to chapter "Setup Drawings". The EUT was coupled to a Digital Communication Tester which was located outside the chamber via a small signalling antenna.

2) A call was established on a Traffic Channel between the EUT and the Digital Communication Tester.

Important Settings:

- Output Power: Maximum

- Channel: please refer to the detailed results

3) A pre-calibration procedure is used so that the readings from the spectrum analyser are corrected and represent directly the equivalent radiated power (related to a $\lambda/2$ dipole).

4) All spurious radiation measurements were made with spectrum analyser and the appropriate calibrated antennas for the frequency range of 30 MHz to 10 GHz (up to the 10th harmonic of the transmit frequency). The frequency range from 9 kHz to 30 MHz has been examined during the conducted spurious emission measurements.

5) Important Analyser Settings

- [Resolution Bandwidth / Video Bandwidth]:

a) [3 kHz / 10 kHz] in the Span of 1 MHz directly below and above the Band,

b) [10 kHz / 30 kHz] in case the curve of the analyser IF-Filter leads to an exceeding of the limit, in this case a worst case correction factor of 20 dB (1 MHz -> 10 kHz) was used

c) [1 MHz / 3 MHz] otherwise

- Sweep Time: depending on the transmitting signal, the span and the resolution bandwidth

6) The spurious emissions peaks were measured in both vertical and horizontal antenna polarization during the call is established on the lowest channel, mid channel and on the highest channel. To find the worst case peaks all orientations (X, Y, Z) of the EUT have been measured.

Test Requirements / Limits

§ 2.1053 Measurements required: Field strength of spurious radiation.

Measurements shall be made to detect spurious emissions that may be radiated directly from the cabinet,

control circuits, power leads, or intermediate circuit elements under normal conditions of installation and operation. Curves or equivalent data shall be supplied showing the magnitude of each harmonic and other spurious emission. For this test, single sideband, independent sideband, and controlled carrier transmitters shall be modulated under the conditions specified in paragraph (c) of Sec. 2.1049, as appropriate. For equipment operating on frequencies below 890 MHz, an open field test is normally required, with the measuring instrument antenna located in the far-field at all test frequencies. In the event it is either impractical or impossible to make open field measurements (e.g. a broadcast transmitter installed in a building) measurements will be accepted of the equipment as installed. Such measurements must be accompanied by a description of the site where the measurements were made showing the location of any possible source of reflections which might distort the field strength measurements. Information submitted shall include the relative radiated power of each spurious emission with reference to the rated power output of the transmitter, assuming all emissions are radiated from halfwave dipole antennas.

(b) The measurements specified in paragraph (a) of this section shall be made for the following equipment:
(2) All equipment operating on frequencies higher than 25 MHz.

§ 2.1057 Frequency spectrum to be investigated.

(a) In all of the measurements set forth in Secs. 2.1051 and 2.1053, the spectrum shall be investigated from the lowest radio frequency signal generated in the equipment, without going below 9 kHz, up to at least the frequency shown below:

(1) If the equipment operates below 10 GHz: to the tenth harmonic of the highest fundamental frequency or to 40 GHz, whichever is lower.

(b) Particular attention should be paid to harmonics and subharmonics of the carrier frequency as well as to those frequencies removed from the carrier by multiples of the oscillator frequency. Radiation at the frequencies of multiplier stages should also be checked.

(c) The amplitude of spurious emissions which are attenuated more than 20 dB below the permissible value need not be reported.

(d) Unless otherwise specified, measurements above 40 GHz shall be performed using a minimum resolution bandwidth of 1 MHz.

§ 22.917 Emission limitations for cellular equipment

(a) The power of any emission outside of the authorized operating frequency ranges must be attenuated below the transmitting power (P) by a factor of at least $43 + 10 \log(P)$ dB.

This is calculated to be -13 dBm (effective radiated power) which corresponds to 84.6 dBµV/m (field strength) in a distance of 3 m.

(b) Compliance with these rules is based on the use of measurement instrumentation employing a resolution bandwidth of 100 kHz or greater. In the 1 MHz bands immediately outside and adjacent to the frequency block a resolution bandwidth of at least one percent of the emission bandwidth of the fundamental emission of the transmitter may be employed. A narrower resolution bandwidth is permitted in all cases to improve measurement accuracy provided the measured power is integrated over the full required measurement bandwidth (i.e. 100 kHz or 1 percent of emission bandwidth, as specified). The emission bandwidth is defined as the width of the signal between two points, one below the carrier center frequency and one above the carrier center frequency, outside of which all emissions are attenuated at least 26 dB below the transmitter power.

(c) Licensees in this service may establish an alternative out of band emission limit to be used at specified band edge(s) in specified geographical areas [...].

(d) If any emission from a transmitter operating in this service results in interference to users of another radio service, the FCC may require a greater attenuation of that emission than specified in this section.

For reporting only spurious emission levels reaching to the 20dB margin to limit were noted.

Frequency stability

Standard FCC Part 22, Subpart H

The test was performed according to FCC §2.1055

Test Description

- 1) The EUT was placed inside a temperature chamber.
- 2) The EUT was coupled to a Digital Communication Tester. Refer to chapter "Setup Drawings".
- 3) The climatic chamber was cycled down/up to a certain temperature, starting with the EUT minimum

temperature.

4) After the temperature was stabilized the EUT was switched on and a call was established on a Traffic Channel between the EUT and the Digital Communication Tester.

Important Settings:

- Output Power: Maximum
- Mid Channel

5) The frequency error of the EUT was recorded by using an internal measurement function of the Digital Communication Tester immediately after the call was established, five minutes after the call was established and ten minutes after the call was established.

6) This measurement procedure was performed for temperature variation from -30°C to +50°C in increments of 10°C, if not otherwise stated in the detailed results.

When the EUT did not operate at certain temperature levels, these measurements were left out.

Test Requirements / Limits

§2.1055 Measurements required: Frequency stability

(a) The frequency stability shall be measured with variation of ambient temperature as follows:

(1) From -30° to +50° centigrade for all equipment except that specified in paragraphs (a) (2) and (3) of this section.

(b) Frequency measurements shall be made at the extremes of the specified temperature range and at intervals of not more than 10° centigrade through the range. A period of time sufficient to stabilize all of the components of the oscillator circuit at each temperature level shall be allowed prior to frequency measurement. The short term transient effects on the frequency of the transmitter due to keying (except for broadcast transmitters) and any heating element cycling normally occurring at each ambient temperature level also shall be shown. Only the portion or portions of the transmitter containing the frequency determining and stabilizing circuitry need be subjected to the temperature variation test.

(d) The frequency stability shall be measured with variation of primary supply voltage as follows:

(1) Vary primary supply voltage from 85 to 115 percent of the nominal value for other than hand carried battery equipment.

(2) For hand carried, battery powered equipment, reduce primary supply voltage to the battery operating end point which shall be specified by the manufacturer.

(3) The supply voltage shall be measured at the input to the cable normally provided with the equipment, or at the power supply terminals if cables are not normally provided. Effects on frequency of transmitter keying (except for broadcast transmitters) and any heating element cycling at the nominal supply voltage and at each extreme also shall be shown.

§22.355 Frequency tolerance

...the carrier frequency of each transmitter in the Public Mobile Service must be maintained within the tolerances given in table C-1 of this section.

Table C-1.- Frequency Tolerance for Transmitters in the Public Mobile Services

Frequency range (MHz)	Base, fixed (ppm)	Mobile up to 3 watts (ppm)	Mobile above 3 watts (ppm)
25 to 50	20.0	20.0	50.0
50 to 450	5.0	5.0	50.0
450 to 512	2.5	5.0	5.0
821 to 896	1.5	2.5	2.5
928 to 929	5.0	n/a	n/a
929 to 960	1.5	n/a	n/a
2110 to 2220	10.0	n/a	n/a

For the mid channel (836.6 MHz) the frequency tolerance is 2.5 ppm (2091.5 Hz).

Band edge compliance

Standard FCC Part 22, Subpart H

The test was performed according to: FCC §22.913

Test Description

- 1) The EUT was coupled to a Spectrum Analyser and a Digital Communication Tester through a Power Divider. Refer to chapter "Setup Drawings".
- 2) The total insertion losses for signal path 1 and signal path 2 were measured. The values were used to correct the readings from the Spectrum Analyser and the Digital Communication Tester.
- 3) A call was established on a Traffic Channel between the EUT and the Digital Communication Tester.
Important Settings:
 - Output Power: Maximum
 - Channel: please refer to the detailed results
- 4) Important Analyser Settings:
 - Resolution Bandwidth = Video Bandwidth: >1% of the manufacturer's stated occupied bandwidth

Test Requirements / Limits

§ 22.917 Emission limitations for cellular equipment

Refer to chapter "Field strength of spurious radiation".

Summary of Test Results

The EUT complied with all performed tests as listed in the summary section of this report.

Technical Report Summary

Type of Authorization :

Certification for a GSM/WCDMA/CDMA2000 cellular radiotelephone device

Applicable FCC Rules

Prepared in accordance with the requirements of FCC Rules and Regulations as listed in 47 CFR Ch.1 Parts 0 to 69. The following subparts are applicable to the results in this test report.

Part 2, Subpart J - Equipment Authorization Procedures, Certification

- § 2.1046 Measurement required: RF power output
- § 2.1049 Measurement required: Occupied bandwidth
- § 2.1051 Measurement required: Spurious emissions at antenna terminals
- § 2.1053 Measurement required: Field strength of spurious radiation
- § 2.1055 Measurement required: Frequency stability
- § 2.1057 Frequency spectrum to be investigated

Part 24, Subpart E - Broadband PCS

- § 24.232 Power and antenna height limits
- § 24.235 Frequency stability
- § 24.236 Field strength limits
- § 24.238 Emission limitations for Broadband PCS equipment

additional documents

ANSI TIA-603-C-2004

Description of Methods of Measurements

RF Power Output

Standard: FCC Part 24, Subpart E

The test was performed according to: FCC §2.1046

Test Description (conducted measurement procedure)

- 1) The EUT was coupled to a Spectrum Analyser and a Digital Communication Tester through a Power Divider. Refer to chapter "Setup Drawings".
- 2) The total insertion losses for signal path 1 and signal path 2 were measured. The values were used to correct the readings from the Spectrum Analyser and the Digital Communication Tester.
- 3) A call was established on a Traffic Channel between the EUT and the Digital Communication Tester.
Important Settings:
 - Channel (Frequency): please refer to the detailed results
- 4) The transmitted power of the EUT was recorded by using a spectrum analyser.

Test Description (radiated measurement procedure)

- 1) The EUT was placed inside an anechoic chamber. Refer to chapter "Setup Drawings". The EUT was coupled to a Digital Communication Tester which was located outside the chamber via a small signalling antenna.
- 2) A call was established on a Traffic Channel between the EUT and the Digital Communication Tester.
Important Settings:
 - Output Power: Maximum
 - Channel: please refer to the detailed results
- 3) A substitution procedure is used so that the readings from the spectrum analyser are corrected and represent directly the equivalent radiated power (related to a $\lambda/2$ dipole).
- 4) The output power was measured in both vertical and horizontal antenna polarisation during the call is established on the lowest channel, mid channel and on the highest channel. To find the worst case power all orientations (X, Y, Z) of the EUT have been measured.
- 5) The test procedure according to TIA-603-C-2004 has been considered.

Test Requirements / Limits

§2.1046 Measurements Required: RF Power Output

(a) For transmitters other than single sideband, independent sideband and controlled carrier radiotelephone, power output shall be measured at the RF output terminals when the transmitter is adjusted in accordance with the tune-up procedure to give the values of current and voltage on the circuit elements specified in § 2.1033(c)(8). The electrical characteristics of the output terminals when this test is made shall be stated.

§24.232 Power and antenna height limits

(c) Mobile/portable stations are limited to 2 watts EIRP peak power and the equipment must employ means to limit the power to the minimum necessary for successful communications.

(e) Peak transmit power must be measured over any interval of continuous transmission using instrumentation calibrated in terms of an rms-equivalent voltage. The measurement results shall be properly adjusted for any instrument limitations, such as detector response times, limited resolution bandwidth capability when compared to the emission bandwidth, sensitivity, etc., so as to obtain a true peak measurement for the emission in question over the full bandwidth of the channel.

Emission and Occupied Bandwidth

Standard: FCC Part 24, Subpart E

The test was performed according to: FCC §2.1049

Test Description

- 1) The EUT was coupled to a Spectrum Analyser and a Digital Communication Tester through a Power Divider. Refer to chapter "Setup Drawings".
- 2) The total insertion losses for signal path 1 and signal path 2 were measured. The values were used to correct the readings from the Spectrum Analyser and the Digital Communication Tester.
- 3) A call was established on a Traffic Channel between the EUT and the Digital Communication Tester.
Important Settings:
 - Output Power: Maximum
 - Channel: please refer to the detailed results
- 4) Important Analyser Settings:
 - Resolution Bandwidth: >1% of the manufacturer's stated occupied bandwidth
- 5) The maximum spectral level of the modulated signal was recorded as the reference.
- 6) The emission bandwidth is measured as follows:
the two furthest frequencies above and below the frequency of the maximum reference level where the

spectrum is -26 dB down have to be found.

7) The occupied bandwidth (99% Bandwidth) is measured as follows:

the occupied bandwidth, that is the frequency bandwidth such that, below its lower and above its upper frequency limits, the mean powers are each equal to 0.5 percent of the total mean power.

Test Requirements / Limits

§ 2.1049 Measurements required: Occupied bandwidth

The occupied bandwidth, that is the frequency bandwidth such that, below its lower and above its upper frequency limits, the mean powers radiated are each equal to 0.5 percent of the total mean power radiated by a given emission shall be measured under the following conditions (as applicable):

(h) Transmitters employing digital modulation techniques - when modulated by an input signal such that its amplitude and symbol rate represent the maximum rated conditions under which the equipment will be operated. The signal shall be applied through any filter networks, pseudo-random generators or other devices required in normal service. Additionally, the occupied bandwidth shall be shown for operation with any devices used for modifying the spectrum when such devices are optional at the discretion of the user.

Spurious emissions at antenna terminals

Standard: FCC Part 24, Subpart E

The test was performed according to FCC §2.1051

Test Description

1) The EUT was coupled to a Spectrum Analyser and a Digital Communication Tester through a Power Divider. Refer to chapter "Setup Drawings".

2) The total insertion losses for signal path 1 and signal path 2 were measured. The values were used to correct the readings from the Spectrum Analyser and the Digital Communication Tester.

3) A call was established on a Traffic Channel between the EUT and the Digital Communication Tester.

Important Settings:

- Output Power: Maximum
- Channel: please refer to the detailed results

4) Important Analyser Settings

- [Resolution Bandwidth]:

- a) [$\geq 1\%$ of wanted signal bandwidth] in the Span of 1 MHz directly below and above the Band,
- b) otherwise [1 MHz]

c) [reduced resolution bandwidth] in case the curve of the analyser IF-Filter or the wanted EUT signal leads to an exceeding of the limit, in this case a correction factor was used

- Sweep Time: depending on the transmitting signal, the span and the resolution bandwidth

5) The spurious emissions peaks were measured in the frequency range from 9 kHz to 20 GHz (up to the 10th harmonic) during the call was established

Test Requirements / Limits

§ 2.1051 Spurious emissions at antenna terminals

The radio frequency voltage or power generated within the equipment and appearing on a spurious frequency shall be checked at the equipment output terminals when properly loaded with a suitable artificial antenna. Curves or equivalent data shall show the magnitude of each harmonic and other spurious emission that can be detected when the equipment is operated under the conditions specified in Sec. 2.1049 as appropriate. The magnitude of spurious emissions which are attenuated more than 20 dB below the permissible value need not be specified.

§ 2.1057 Frequency spectrum to be investigated.

(a) In all of the measurements set forth in Secs. 2.1051 and 2.1053, the spectrum shall be investigated from the lowest radio frequency signal generated in the equipment, without going below 9 kHz, up to at least the frequency shown below:

(1) If the equipment operates below 10 GHz: to the tenth harmonic of the highest fundamental frequency or

to 40 GHz, whichever is lower.

(b) Particular attention should be paid to harmonics and subharmonics of the carrier frequency as well as to those frequencies removed from the carrier by multiples of the oscillator frequency. Radiation at the frequencies of multiplier stages should also be checked.

(c) The amplitude of spurious emissions which are attenuated more than 20 dB below the permissible value need not be reported.

(d) Unless otherwise specified, measurements above 40 GHz shall be performed using a minimum resolution bandwidth of 1 MHz.

§ 24.238 Emission limitations for Broadband PCS equipment

(a) The power of any emission outside of the authorized operating frequency ranges must be attenuated below the transmitting power (P) by a factor of at least $43 + 10 \log(P)$ dB.

Remark of the test laboratory: This is calculated to be -13 dBm.

(b) Compliance with these rules is based on the use of measurement instrumentation employing a resolution bandwidth of 1 MHz or greater. However, in the 1 MHz bands immediately outside and adjacent to the frequency block a resolution bandwidth of at least one percent of the emission bandwidth of the fundamental emission of the transmitter may be employed. A narrower resolution bandwidth is permitted in all cases to improve measurement accuracy provided the measured power is integrated over the full required measurement bandwidth (i.e. 1 MHz or 1 percent of emission bandwidth, as specified). The emission bandwidth is defined as the width of the signal between two points, one below the carrier center frequency and one above the carrier center frequency, outside of which all emissions are attenuated at least 26 dB below the transmitter power.

(c) Licensees in this service may establish an alternative out of band emission limit to be used at specified band edge(s) in specified geographical areas [...].

(d) If any emission from a transmitter operating in this service results in interference to users of another radio service, the FCC may require a greater attenuation of that emission than specified in this section.

For reporting only spurious emission levels reaching to the 20dB margin to limit were noted.

Field strength of spurious radiation

Standard: FCC Part 24, Subpart E

The test was performed according to: FCC §2.1053

Test Description

1) The EUT was placed inside an anechoic chamber. Refer to chapter "Setup Drawings". The EUT was coupled to a Digital Communication Tester which was located outside the chamber via a small signalling antenna.

2) A call was established on a Traffic Channel between the EUT and the Digital Communication Tester.

Important Settings:

- Output Power: Maximum

- Channel: please refer to the detailed results

3) A pre-calibration procedure is used so that the readings from the spectrum analyser are corrected and represent directly the equivalent radiated power (related to a $\lambda/2$ dipole).

4) All spurious radiation measurements were made with spectrum analyser and the appropriate calibrated antennas for the frequency range of 30 MHz to 20 GHz (up to the 10th harmonic of the transmit frequency). The frequency range from 9 kHz to 30 MHz has been examined during the conducted spurious emission measurements.

5) Important Analyser Settings

- [Resolution Bandwidth / Video Bandwidth]:

a) [3 kHz / 10 kHz] in the Span of 1 MHz directly below and above the Band,

b) [10 kHz / 30 kHz] in case the curve of the analyser IF-Filter leads to an exceeding of the limit, in this case a worst case correction factor of 20 dB (1 MHz \rightarrow 10 kHz) was used

c) [1 MHz / 3 MHz] otherwise

- Sweep Time: depending on the transmitting signal, the span and the resolution bandwidth

6) The spurious emissions peaks were measured in both vertical and horizontal antenna polarisation during the call is established on the lowest channel, mid channel and on the highest channel. To find the worst case peaks all orientations (X, Y, Z) of the EUT have been measured.

7) After this initial test, a final test according to TIA-603-C 2.2.12 Unwanted Emissions is performed on signals which are identified as being close to the limit. For any emissions found to be within 10 dB of the limit, a specific signal substitution measurement is performed at the frequency of the emission to determine the exact e.i.r.p. value.

Test Requirements / Limits

§ 2.1053 Measurements required: Field strength of spurious radiation.

Measurements shall be made to detect spurious emissions that may be radiated directly from the cabinet, control circuits, power leads, or intermediate circuit elements under normal conditions of installation and operation. Curves or equivalent data shall be supplied showing the magnitude of each harmonic and other spurious emission. For this test, single sideband, independent sideband, and controlled carrier transmitters shall be modulated under the conditions specified in paragraph (c) of Sec. 2.1049, as appropriate. For equipment operating on frequencies below 890 MHz, an open field test is normally required, with the measuring instrument antenna located in the far-field at all test frequencies. In the event it is either impractical or impossible to make open field measurements (e.g. a broadcast transmitter installed in a building) measurements will be accepted of the equipment as installed. Such measurements must be accompanied by a description of the site where the measurements were made showing the location of any possible source of reflections which might distort the field strength measurements. Information submitted shall include the relative radiated power of each spurious emission with reference to the rated power output of the transmitter, assuming all emissions are radiated from halfwave dipole antennas.

(b) The measurements specified in paragraph (a) of this section shall be made for the following equipment:

(2) All equipment operating on frequencies higher than 25 MHz.

§ 2.1057 Frequency spectrum to be investigated.

(a) In all of the measurements set forth in Secs. 2.1051 and 2.1053, the spectrum shall be investigated from the lowest radio frequency signal generated in the equipment, without going below 9 kHz, up to at least the frequency shown below:

(1) If the equipment operates below 10 GHz: to the tenth harmonic of the highest fundamental frequency or to 40 GHz, whichever is lower.

(b) Particular attention should be paid to harmonics and subharmonics of the carrier frequency as well as to those frequencies removed from the carrier by multiples of the oscillator frequency. Radiation at the frequencies of multiplier stages should also be checked.

(c) The amplitude of spurious emissions which are attenuated more than 20 dB below the permissible value need not be reported.

(d) Unless otherwise specified, measurements above 40 GHz shall be performed using a minimum resolution bandwidth of 1 MHz.

§ 24.238 Emission limitations for Broadband PCS equipment

(a) The power of any emission outside of the authorized operating frequency ranges must be attenuated below the transmitting power (P) by a factor of at least $43 + 10 \log(P)$ dB.

This is calculated to be -13 dBm (effective radiated power) which corresponds to 84.6 dB μ V/m (field strength) in a distance of 3 m.

(b) Compliance with these rules is based on the use of measurement instrumentation employing a resolution bandwidth of 1 MHz or greater. However, in the 1 MHz bands immediately outside and adjacent to the frequency block a resolution bandwidth of at least one percent of the emission bandwidth of the fundamental emission of the transmitter may be employed. A narrower resolution bandwidth is permitted in all cases to improve measurement accuracy provided the measured power is integrated over the full required measurement bandwidth (i.e. 1 MHz or 1 percent of emission bandwidth, as specified). The emission bandwidth is defined as the width of the signal between two points, one below the carrier center frequency and one above the carrier center frequency, outside of which all emissions are attenuated at least 26 dB below the transmitter power.

(c) Licensees in this service may establish an alternative out of band emission limit to be used at specified band edge(s) in specified geographical areas [...].

(d) If any emission from a transmitter operating in this service results in interference to users of another radio service, the FCC may require a greater attenuation of that emission than specified in this section.

For reporting only spurious emission levels reaching to the 20dB margin to limit were noted.

Frequency stability

Standard: FCC Part 24, Subpart E

The test was performed according to FCC §2.1055

Test Description

- 1) The EUT was placed inside a temperature chamber.
- 2) The EUT was coupled to a Digital Communication Tester. Refer to chapter "Setup Drawings".
- 3) The climatic chamber was cycled down/up to a certain temperature, starting with the EUT minimum temperature.
- 4) After the temperature was stabilized the EUT was switched on and a call was established on a Traffic Channel between the EUT and the Digital Communication Tester.
Important Settings:
 - Output Power: Maximum
 - Mid Channel
- 5) The frequency error of the EUT was recorded by using an internal measurement function of the Digital Communication Tester immediately after the call was established, five minutes after the call was established and ten minutes after the call was established.
- 6) This measurement procedure was performed for temperature variation from -30°C to $+50^{\circ}\text{C}$ in increments of 10°C , if not otherwise stated in the detailed results.
When the EUT did not operate at certain temperature levels, these measurements were left out.

Test Requirements / Limits

§2.1055 Measurements required: Frequency stability

- (a) The frequency stability shall be measured with variation of ambient temperature as follows:
 - (1) From -30° to $+50^{\circ}$ centigrade for all equipment except that specified in paragraphs (a) (2) and (3) of this section.
 - (b) Frequency measurements shall be made at the extremes of the specified temperature range and at intervals of not more than 10° centigrade through the range. A period of time sufficient to stabilize all of the components of the oscillator circuit at each temperature level shall be allowed prior to frequency measurement. The short term transient effects on the frequency of the transmitter due to keying (except for broadcast transmitters) and any heating element cycling normally occurring at each ambient temperature level also shall be shown. Only the portion or portions of the transmitter containing the frequency determining and stabilizing circuitry need be subjected to the temperature variation test.
 - (d) The frequency stability shall be measured with variation of primary supply voltage as follows:
 - (1) Vary primary supply voltage from 85 to 115 percent of the nominal value for other than hand carried battery equipment.
 - (2) For hand carried, battery powered equipment, reduce primary supply voltage to the battery operating end point which shall be specified by the manufacturer.
 - (3) The supply voltage shall be measured at the input to the cable normally provided with the equipment, or at the power supply terminals if cables are not normally provided. Effects on frequency of transmitter keying (except for broadcast transmitters) and any heating element cycling at the nominal supply voltage and at each extreme also shall be shown.

§24.235 Frequency stability

The frequency stability shall be sufficient to ensure that the fundamental emission stays within the authorized frequency block.

7Layers interpretation of limit:

To ensure that the frequency stability shall be sufficient to ensure that the fundamental emission stays within the authorized frequency block following limit was used:

± 2.5 ppm = 4700 Hz for a frequency of 1880.0 MHz

in accordance with FCC Part 22, Subpart H, §22.355, table C-1: Frequency tolerance for the carrier frequency of mobile transmitters in the Public Mobile Service in the frequency range 821 to 896 MHz.

Band edge compliance

Standard: FCC Part 24, Subpart E

The test was performed according to: FCC §24.238

Test Description

- 1) The EUT was coupled to a Spectrum Analyser and a Digital Communication Tester through a Power Divider. Refer to chapter "Setup Drawings".
- 2) The total insertion losses for signal path 1 and signal path 2 were measured. The values were used to correct the readings from the Spectrum Analyser and the Digital Communication Tester.
- 3) A call was established on a Traffic Channel between the EUT and the Digital Communication Tester.
Important Settings:
 - Output Power: Maximum
 - Channel: please refer to the detailed results
- 4) Important Analyser Settings:
 - Resolution Bandwidth = Video Bandwidth: >1% of the manufacturer's stated occupied bandwidth

Test Requirements / Limits

§ 24.238 Effective radiated power limits

Refer to chapter "Field strength of spurious radiation".

Subtests HSDPA

Sub-test	β_c	β_d	β_d (SF)	β_c/β_d	β_{HS} (Note1, Note 2)	CM (dB) (Note 3)	MPR (dB) (Note 3)
1	2/15	15/15	64	2/15	4/15	0.0	0.0
2	12/15 (Note 4)	15/15 (Note 4)	64	12/15 (Note 4)	24/15	1.0	0.0
3	15/15	8/15	64	15/8	30/15	1.5	0.5
4	15/15	4/15	64	15/4	30/15	1.5	0.5

Note 1: $?_{ACK}, ?_{NACK}$ and $?_{CQI} = 30/15$ with $\beta_{hs} = 30/15 * \beta_c$.

Note 2: For the HS-DPCCH power mask requirement test in clause 5.2C, 5.7A, and the Error Vector Magnitude (EVM) with HS-DPCCH test in clause 5.13.1A, and HSDPA EVM with phase discontinuity in clause 5.13.1AA, $?_{ACK}$ and $?_{NACK} = 30/15$ with $\beta_{hs} = 30/15 * \beta_c$, and $?_{CQI} = 24/15$ with $\beta_{hs} = 24/15 * \beta_c$.

Note 3: CM = 1 for $\beta_c/\beta_d=12/15, \beta_{hs}/\beta_c=24/15$. For all other combinations of DPDCH, DPCCH and HS-DPCCH the MPR is based on the relative CM difference. This is applicable for only UEs that support HSDPA in release 6 and later releases.

Note 4: For subtest 2 the β_c/β_d ratio of 12/15 for the TFC during the measurement period (TF1, TF0) is achieved by setting the signalled gain factors for the reference TFC (TF1, TF1) to $\beta_c = 11/15$ and $\beta_d = 15/15$.

Subtests HSUPA

Subtest	Mode	Loopback Mode	Rel99 RMC	HSDPA FRC	HSUPA Test	Number of E-DPDCH Channels
1	Rel6 HSUPA	Test Mode 1	12.2kbps RMC	H-Set1	HSUPA Loopback	1
2	Rel6 HSUPA	Test Mode 1	12.2kbps RMC	H-Set1	HSUPA Loopback	1
3	Rel6 HSUPA	Test Mode 1	12.2kbps RMC	H-Set1	HSUPA Loopback	2
4	Rel6 HSUPA	Test Mode 1	12.2kbps RMC	H-Set1	HSUPA Loopback	1
5	Rel6 HSUPA	Test Mode 1	12.2kbps RMC	H-Set1	HSUPA Loopback	1

Subtest	Max UL Data Rate (kb/s)	β_c/β_d	β_{hs}	β_{ed}	CM
1	242.1	11/15	22/15	1309/225	1
2	161.3	6/15	12/15	94/75	3
3	524.7	15/9	30/15	47/15	2
4	197.6	2/15	4/15	56/75	3
5	299.6	15/15	30/15	134/15	1

Setup Drawings

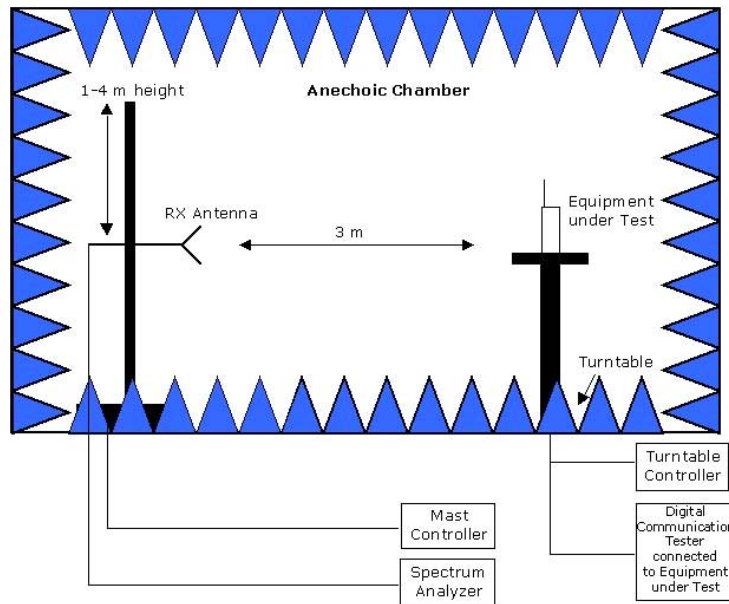

Remark: Depending on the frequency range suitable antenna types, attenuators or preamplifiers are used.

Principle set-up for radiated measurements

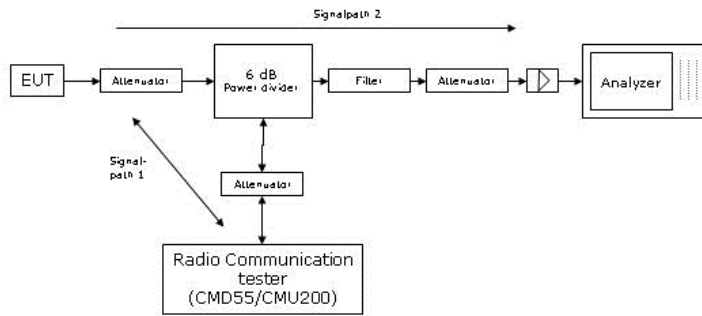

Remark: Depending on the frequency range suitable attenuators and/or filters and/or amplifiers are used.

Principle set-up for conducted measurements under nominal conditions

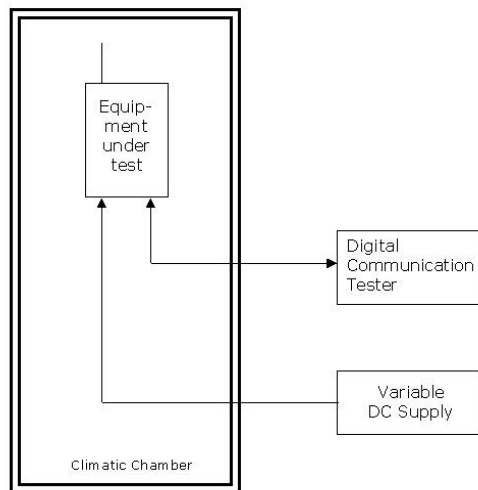

Principle set-up for tests under extreme test conditions

9. INDEX

1	Administrative Data	2
1.1	Project Data	2
1.2	Applicant Data	2
1.3	Test Laboratory Data	2
1.4	Signature of the Testing Responsible	2
1.5	Signature of the Accreditation Responsible	3
2	Test Object Data for TOBY-L210	3
2.1	General OUT Description	3
2.2	Detailed Description of OUT Samples	4
2.3	OUT Features	4
2.4	Setups used for Testing	4
3	Results for TOBY-L210	5
3.1	General	5
3.2	List of the Applicable Body	5
3.3	List of Test Specification	5
3.4	Summary	6
3.5	Detailed Results	8
3.5.1	22.1 RF Power Output §2.1046, §22.913	8
3.5.2	22.2 Frequency stability §2.1055	11
3.5.3	22.3 Spurious emissions at antenna terminals §2.1051, §22.917	14
3.5.4	22.4 Field strength of spurious radiation §2.1053, §22.917	15
3.5.5	22.5 Emission and Occupied Bandwidth §2.1049, §22.917	21
3.5.6	22.6 Band edge compliance §2.1053, §22.917	25
3.5.7	24.1 RF Power Output §2.1046, §24.232	28
3.5.8	24.2 Frequency stability §2.1055, §24.235	31
3.5.9	24.3 Spurious emissions at antenna terminals §2.1051, §24.238	34
3.5.10	24.4 Field strength of spurious radiation §2.1053, §24.238	38
3.5.11	24.5 Emission and Occupied Bandwidth §2.1049, §24.238	44

3.5.12	24.6 Band edge compliance §2.1053, §24.238	48
4	Test Equipment Details for TOBY-L210	51
4.1	List of Used Test Equipment	51
5	Test Object Data for TOBY-L280	58
5.1	General OUT Description	58
5.2	Detailed Description of OUT Samples	58
5.3	OUT Features	59
5.4	Setups used for Testing	60
6	Results for TOBY-L280	60
6.1	General	60
6.2	List of the Applicable Body	61
6.3	List of Test Specification	61
6.4	Summary	62
6.5	Detailed Results	63
6.5.1	22.1 RF Power Output §2.1046, §22.913	63
6.5.2	22.2 Frequency stability §2.1055	64
6.5.3	22.3 Spurious emissions at antenna terminals §2.1051, §22.917	65
6.5.4	22.4 Field strength of spurious radiation §2.1053, §22.917	66
6.5.5	22.5 Emission and Occupied Bandwidth §2.1049, §22.917	67
6.5.6	22.6 Band edge compliance §2.1053, §22.917	70
6.5.7	24.1 RF Power Output §2.1046, §24.232	72
6.5.8	24.2 Frequency stability §2.1055, §24.235	73
6.5.9	24.3 Spurious emissions at antenna terminals §2.1051, §24.238	74
6.5.10	24.4 Field strength of spurious radiation §2.1053, §24.238	75
6.5.11	24.5 Emission and Occupied Bandwidth §2.1049, §24.238	77
6.5.12	24.6 Band edge compliance §2.1053, §24.238	80
7	Test Equipment Details for TOBY-L280	82

7.1 List of Used Test Equipment	82
8 Annex	89
8.1 Additional Information for Report	89
9 Index	107
