

InterLab[®]

FCC Measurement/Technical Report on

**TOBY-L210 GSM/UMTS/HSPA/LTE Data
Module**

FCC ID: XPYTOBYL210

IC: 8595A-TOBYL210

Report Reference: MDE_UBLOX_1409_FCCd Rev 02

according to FCC Part 27, Subpart C

Test Laboratory:

7Layers AG
Borsigstr. 11
40880 Ratingen
Germany

Note:

The following test results relate only to the devices specified in this document. This report shall not be reproduced in parts without the written approval of the test laboratory.

7Layers AG
Borsigstrasse 11
40880 Ratingen, Germany
Phone: +49 (0) 2102 749 0
Fax: +49 (0) 2102 749 350
www.7Layers.com

Aufsichtsratsvorsitzender •
Chairman of the Supervisory Board:
Peter Mertel
Vorstand • Board:
Dr. H.-J. Meckelburg
Dr. H. Ansorge



Registergericht • registered in:
Düsseldorf, HRB 44096
USt-IdNr • VAT No.:
DE 203159652
TAX No. 147/5869/0385

Table of Contents

0.1	Summary	3
0.2	Technical Report Summary	3
0.3	Measurement Summary	5
1	Administrative Data	6
1.1	Testing Laboratory	6
1.2	Project Data	6
1.3	Applicant Data	6
1.4	Manufacturer Data	6
2	Test object Data	7
2.1	General EUT Description	7
2.2	EUT Main components	8
2.3	Ancillary Equipment	8
2.4	Auxiliary Equipment	8
2.5	EUT Setups	9
2.6	Operating Modes	9
2.7	Special software used for testing	10
2.8	Product labeling	10
3	Test Results	12
3.1	RF Power Output	12
3.2	Frequency stability	15
3.3	Spurious emissions at antenna terminals	17
3.4	Emission and Occupied Bandwidth	20
3.5	Band edge compliance	22
3.6	Power to Average Ratio	24
4	Test Equipment	25
5	Photo Report	29
6	Setup Drawings	29
7	Annex measurement plots (worst case)	31
7.1	RF Power Output	31
7.2	Peak to Average Ratio	33
7.3	Spurious emissions at antenna terminals	35
7.4	Emission and Occupied Bandwidth FDD 7 CH 20775, CBW 5 MHz, QPSK	36
7.5	Band edge compliance	40

0.1 Summary

0.2 Technical Report Summary

Type of Authorization

Certification for a GSM/WCDMA/LTE cellular radiotelephone device. This report covers only the LTE portion of this device.

Applicable FCC Rules

Prepared in accordance with the requirements of FCC Rules and Regulations as listed in 47 CFR Ch.1 Parts 0 to 69. The following subparts are applicable to the results in this test report.

Part 2, Subpart J - Equipment Authorization Procedures, Certification

- § 2.1046 Measurement required: RF power output
- § 2.1049 Measurement required: Occupied bandwidth
- § 2.1051 Measurement required: Spurious emissions at antenna terminals
- § 2.1053 Measurement required: Field strength of spurious radiation
- § 2.1055 Measurement required: Frequency stability
- § 2.1057 Frequency spectrum to be investigated

Part 27, Subpart C—Technical Standards

- § 27.50 Power and antenna height limits
- § 27.53 Emissions limits
- § 27.54 Frequency stability

Additional documents

ANSI TIA-603-C-2004

Correlation of measurement requirements for Cellular Equipment from FCC and IC

FCC Rule / IC Standard	Part 22 / RSS-132		Part 24 / RSS-133 (NA)		Part 27 / RSS-139 / RSS-199		
	Effective (isotropic) Radiated Power	§2.1046 §22.913	RSS-GEN, §4.8 RSS-132, §5.4	§2.1046 §24.232	RSS-GEN, §4.8 RSS-133, §6.4	§2.1046 §27.50 (d)	RSS-GEN, §4.8 RSS-139; §6.4
Occupied Bandwidth	§2.1049	RSS-GEN §4.6	§2.1049	RSS-GEN §4.6	§2.1049	RSS-GEN §4.6	RSS-GEN §4.6
"Spuri" at Antenna Terminal	§2.1051 §22.917	RSS-GEN, §4.9 RSS-132, §5.5	§2.1051 §24.238	RSS-GEN, §4.9 RSS-132, §6.5	§2.1051 §27.5 (h)	RSS-GEN, §4.9 RSS-139, §6.5	RSS-GEN, §4.9 RSS-199, §4.6
Band Edge compliance	§2.1051 §22.917	RSS-GEN, §4.6	§2.1051 §24.238	RSS-GEN, §4.6	§2.1051 §27.5 (h)	RSS-GEN, §4.6	RSS-GEN, §4.6
Frequency Stability	§2.1055 §22.355	RSS-GEN, §4.7	§2.1055 §24.235	RSS-GEN, §4.7 RSS-132, §6.3	§2.1055 §27.51	RSS-GEN, §4.7 RSS-139, §6.3	RSS-GEN, §4.7 RSS-199, §4.3
Peak to Average Ration	N/A	RSS-132, §5.3	§2.1046 §24.232	RSS-133, §6.4	§2.1046 §27.50 (d)	RSS-139, §6.4	NA
Modulation Characteristics	§2.1047	RSS-132, §5.4	§2.1047	RSS-133, §6.2	§2.1047	RSS-139, §6.2	RSS-199, §4.1
Field Strength of Spurious Radiation	§2.1053 §22.917	RSS-132, §5.2	§2.1053 §24.235	RSS-GEN, §4.9 RSS-133, §6.5	§2.1053 §27.51	RSS-GEN, §4.9 RSS-139, §6.5	RSS-GEN, §4.9 RSS-199, §4.6

*) Receivers which are part of Transceivers are exempted with respect to Notice 2012-DRS0126.

Summary Test Results:

The EUT complied with all performed tests as listed in chapter 0.2 Measurement Summary.

0.3 Measurement Summary

FCC Part 27, Subpart C		§2.1046, §27.50(d)	
RF Power Output			
Setup	Port	Final Result	
Setup_01	AC Port (power line)	passed 09-18-2014	
FCC Part 27, Subpart C		§2.1055, §27.51	
Frequency stability			
Setup	Port	Final Result	
Setup_02	Temp.ant.connector	passed 09-18-2014	
FCC Part 27, Subpart C		§2.1051, §27.53(h)	
Spurious emissions at antenna terminals			
Setup	Port	Final Result	
Setup_01	Temp.ant.connector	passed 09-18-2014	
FCC Part 27, Subpart C		§2.1049	
Emission and Occupied Bandwidth			
Setup	Port	Final Result	
Setup_01	Temp.ant.connector	passed 09-18-2014	
FCC Part 27, Subpart C		§2.1051, §27.53 (h)	
Band edge compliance			
Setup	Port	Final Result	
Setup_01	Temp.ant.connector	passed 09-18-2014	
FCC Part 27, Subpart C		§2.1046, §27.50(d)	
Peak-Average Ratio			
Setup	Port	Final Result	
Setup_01	Temp.ant.connector	passed 09-18-2014	
FCC Part 27, Subpart C		§2.1046, §27.50(d)	
Field strength of spurious radiation			
Setup	Port	Final Result	
na	na	Not performed see external report	

Responsible for Accreditation Scope:

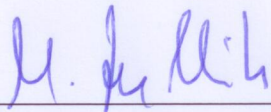

Responsible for Test Report:

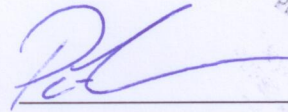
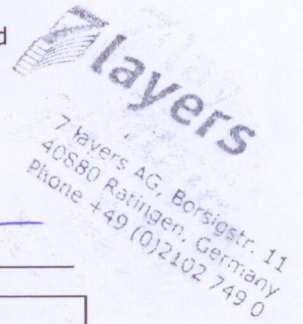
7 layers AG, Borsigstr. 11
40580 Ratingen, Germany
Phone +49 (0)2102 749 0

Version	Release date	Changes	Version validity
01	08.10.2014	Initial version	not valid
02	20.10.2014	Updated FCC/IC correlation table	valid

1 Administrative Data

1.1 Testing Laboratory

Company Name: 7Layers AG
Address Borsigstr. 11
40880 Ratingen
Germany

This facility has been fully described in a report submitted to the FCC and accepted under the registration number 96716 .

The test facility is also accredited by the following accreditation organisation:
Laboratory accreditation no.: DAkKS D-PL-12140-01-01

Responsible for Accreditation Scope: Dipl.-Ing. Bernhard Retka
Dipl.-Ing. Robert Machulec
Dipl.-Ing. Thomas Hoell
Dipl.-Ing. Marco Kullik
Dipl.-Ing. Andreas Petz

Report Template Version: 2014-09-18

1.2 Project Data

Responsible for testing and report: Patrick Lomax
Date of Test(s): 2014-07-14 to 2014-09-18
Date of Report: 2014-10-20

1.3 Applicant Data

Company Name: u-blox AG
Address: Zürcherstrasse 68,
CH-8800 Thalwil
Switzerland
Contact Person: Mr. Giulio Comar
Phone: +41 44 722 7462
Email Address: giulio.comar@u-blox.com

1.4 Manufacturer Data

Company Name: please see applicant data
Address:

Contact Person:

2 Test object Data

2.1 General EUT Description

Equipment under Test:	GSM/UMTS/HSPA/LTE Data Module
Type Designation:	TOBY-L210
Kind of Device:	Module
(optional)	
Voltage Type:	DC
Voltage Level:	3.8 V
Tested Modulation Type:	QPSK;16QAM

General product description:

The Module is able to operating in the following bands:

GSM 850/1900 900/1800

UMTS/HSDPA/HSUPA FDD1,2,5,8

LTE eFDD 1,3,5,7,8,20

*This report only covers the LTE portion.

The EUT provides the following ports:

Ports

Temporary antenna connector

Enclosure

2.2 EUT Main components

Type, S/N, Short Descriptions etc. used in this Test Report

Short Description	Equipment under Test	Type Designation	Serial No.	HW Status	SW Status
EUT A (Code: DE1015004AX12)	GSM/UMTS/LTE Module	TOBY-L210	352255060018185	192BA04	09.41
EUT B (Code: DE1015004BC13)	GSM/UMTS/LTE Module	TOBY-L210	352255060017906	192BA00	09.39

Remark: EUT A,B is equipped with a temporary antenna connector. The Module is not sold with a predefined antenna.

NOTE: The code mentioned in short description is used to simplify the identification of the EUT in this test report.

2.3 Ancillary Equipment

For the purposes of this test report, ancillary equipment is defined as equipment which is used in conjunction with the EUT to provide operational and control features to the EUT. It is necessary to configure the system in a typical fashion, as a customer would normally use it. But nevertheless Ancillary Equipment can influence the test results.

Short Description	Equipment under Test	Type Designation	HW Status	SW Status	Serial no.	FCC ID
AE 1	AC/DC converter	UUX324-1215	-	-	E04-0392137	-
AE 2	Evaluation test board	EVB-WL1	HP02_HW_C	S_136000	BS 081110	

2.4 Auxiliary Equipment

For the purposes of this test report, auxiliary equipment is defined as equipment which is used temporarily to enable operational and control features especially used for the tests of the EUT which is not used during normal operation or equipment that is used during the tests in combination with the EUT but is not subject of this test report. It is necessary to configure the system in a typical fashion, as a customer would normally use it. But nevertheless Auxiliary Equipment can influence the test results.

Short Description	Equipment under Test	Type Designation	Serial no.	HW Status	SW Status	FCC ID
*						

* No auxiliary equipment was required to operate the module

2.5 EUT Setups

This chapter describes the combination of EUTs and equipment used for testing. The rationale for selecting the EUTs, ancillary and auxiliary equipment and interconnecting cables, is to test a representative configuration meeting the requirements of the referenced standards.

Setup No.	Combination of EUTs	Description and Rationale
Setup_01	EUT A + AE 1 + AE 2	setup for conducted measurements
Setup_02	EUT B + AE 1 + AE 2	setup for conducted measurements

2.6 Operating Modes

The below table shows the test frequencies and channels bandwidths used for testing.

TEST MODE	TX / RX	RF Channel		
		Low	Mid	High
LTE eFDD 7	TX (5M)	CH 20775	CH 21100	CH 21425
		2502.50 MHz	2535.00 MHz	2567.50 MHz
	TX (10)	CH 20800	CH 21100	CH 21400
		2505.00 MHz	2535.00 MHz	2565.00 MHz
	TX (15M)	CH 20825	CH 21100	CH 21375
		2507.50 MHz	2535.00 MHz	2562.50 MHz
	TX (20M)	CH 20850	CH 21100	CH 21350
		2510.00 MHz	2535.00 MHz	2560.00 MHz
	RX (5M)	CH 2775	CH 3100	CH 3425
		2622.50 MHz	2655.00 MHz	2687.50 MHz
	RX (10M)	CH 2800	CH 3100	CH 3400
		2625.00 MHz	2655.00 MHz	2685.00 MHz
	RX (15M)	CH 2825	CH 3100	CH 3375
		2675.50 MHz	2655.00 MHz	2682.50 MHz
RX (20M)	CH 2850	CH 3100	CH 3350	
	2630.00 MHz	2655.00 MHz	2680.00 MHz	

eFDD 7 Test configuration					
Setup Number	Test ITEM	Channel Band width	Channels tested	Modulation	RB Allocation
01	RF OUTPUT POWER	5 MHz	20775, 21110, 21425	QPSK, 16QAM	1RB , 12RB , 25RB
		10 MHz	20800, 2110, 21400	QPSK, 16QAM	1RB, 50RB
		15 MHz	20825, 21110, 21375	QPSK, 16QAM	1RB, 36RB, 75RB
		20 MHz	20850, 21100, 21350	QPSK, 16QAM	1RB, 100RB
02	FREQUENCY STABILITY	5	21100	QPSK	1RB
01	OCCUPIED BANDWIDTH	5 MHz	20775, 21110, 21425	QPSK, 16QAM	25RB
		10 MHz	20800, 2110, 21400	QPSK, 16QAM	50RB
		15 MHz	20825, 21110, 21375	QPSK, 16QAM	75RB
		20 MHz	20850, 21100, 21350	QPSK, 16QAM	100RB
01	PEAK TO AVERAGE RATIO	5 MHz	19975, 20175, 20375	QPSK, 16QAM	25RB
01	BAND EDGE Compliance	5 MHz	20775, 21110, 21425	QPSK, 16QAM	25RB/ Max offset
		10 MHz	20800, 2110, 21400	QPSK, 16QAM	50RB/ Max offset
		15 MHz	20825, 21110, 21375	QPSK, 16QAM	75RB/ Max offset
		20 MHz	20850, 21100, 21350	QPSK, 16QAM	100RB/ Max offset
01	CONDCUDED EMISSION	5 MHz	20775, 21110, 21425	QPSK, 16QAM	1RB
NA	RADIATED EMISSION	NA	See external report	NA	NA

2.7 Special software used for testing

- NA

2.7.1 Software to control the EUT directly

- NA

2.7.2 Software to enable control the EUT by a signaling unit

- NA

2.8 Product labeling

-



2.8.1 FCC ID label

Please refer to the documentation of the applicant.

2.8.2 Location of the label on the EUT

Please refer to the documentation of the applicant.

3 Test Results

3.1 RF Power Output

FCC Part 27, Subpart C

The test was performed according to: FCC §2.1046

3.1.1 Test Description (conducted procedure)

1) The EUT was coupled to a Spectrum Analyser and a Digital Communication Tester through a Power Divider. Refer to chapter "Setup Drawings".

a) The EUT was set up for the maximum power with LTE link data modulation and link up with simulator.

b) Set the EUT to transmit under low, middle and high channel and record the power level shown on simulator.

2) The total insertion losses for signal path 1 and signal path 2 were measured. The values were used to correct the readings from the Spectrum Analyser and the Digital Communication Tester.

3) A call was established on a Traffic Channel between the EUT and the Digital Communication Tester.

Important Settings:

- Channel (Frequency): please refer to the detailed results

4) The transmitted power of the EUT was recorded by using a spectrum analyser.

a. The EUT was set up for the maximum power with LTE link data modulation and link up with simulator.

b. Set the EUT to transmit under low, middle and high channel and record the power level shown on simulator.

Test Description (radiated measurement procedure)

1) The EUT was placed inside an anechoic chamber. Refer to chapter "Setup Drawings". The EUT was coupled to a Digital Communication Tester which was located outside the chamber via a small signalling antenna.

2) A call was established on a Traffic Channel between the EUT and the Digital Communication Tester.

Important Settings:

- Output Power: Maximum

- Channel: please refer to the detailed results

3) A substitution procedure is used so that the readings from the spectrum analyser are corrected and represent directly the equivalent radiated power (related to a $\lambda/2$ dipole).

4) The output power was measured in both vertical and horizontal antenna polarisation during the call is established on the lowest channel, mid channel and on the highest channel. To find the worst case power all orientations (X, Y, Z) of the EUT have been measured.

5) The test procedure according to TIA-603-C-2004 has been considered.

3.1.2 Test Requirements / Limits

§2.1046 Measurements Required: RF Power Output

(a) For transmitters other than single sideband, independent sideband and controlled carrier radiotelephone, power output shall be measured at the RF output terminals when the transmitter is adjusted in accordance with the tune-up procedure to give the values of current and voltage on the circuit elements specified in § 2.1033(c)(8). The electrical characteristics of the output terminals when this test is made shall be stated.

§27.50 Power and antenna height limits.

(d) The following power and antenna height requirements apply to stations transmitting in the 1710–1755 MHz and 2110–2155 MHz bands:

(2) Fixed, mobile, and portable (hand-held) stations operating in the 1710–1755 MHz band are limited to a peak EIRP of 1 watt.

Fixed stations operating in this band are limited to a maximum antenna height of 10 meters above ground, and mobile and portable stations must employ a means for limiting power to the minimum necessary for successful communications.

Portable stations (hand-held devices) operating in the 704-716 MHz band are limited to 3 watts ERP

3.1.3 Test Protocol

eFDD 7

Test Band	Band width	Channel	Modulation	RB	RMS Conducted power	FCC EIRP limit (W)	IC EIRP limit per SRSP-503 (W)	Maximum antenna gain (dBi)	Verdict
BAND 7	5	Low	QPSK	RB 1	21.94	1	1	8.06	Passed
	5	Low	QPSK	RB 12	20.85	1	1	9.15	Passed
	5	Low	QPSK	RB 25	21.05	1	1	8.95	Passed
	5	Low	16QAM	RB 1	21.11	1	1	8.89	Passed
	5	Low	16QAM	RB 25	20.15	1	1	9.85	Passed
	5	MID	QPSK	RB 1	22.45	1	1	7.55	Passed
	5	MID	QPSK	RB 12	21.51	1	1	8.49	Passed
	5	MID	QPSK	RB 25	21.52	1	1	8.48	Passed
	5	MID	16QAM	RB 1	21.45	1	1	8.55	Passed
	5	MID	16QAM	RB 25	22.39	1	1	7.61	Passed
5	High	QPSK	RB 1	22.27	1	1	7.73	Passed	

5	High	QPSK	RB 12	21.75	1	1	8.25	Passed
5	High	QPSK	RB 25	21.67	1	1	8.33	Passed
5	High	16QAM	RB 1	21.67	1	1	8.33	Passed
5	High	16QAM	RB 25	20.64	1	1	9.36	Passed
10	Low	QPSK	RB 1	21.78	1	1	8.22	Passed
10	Low	QPSK	RB 50	21.12	1	1	8.88	Passed
10	Low	16QAM	RB 1	21	1	1	9	Passed
10	Low	16QAM	RB 50	20.19	1	1	9.81	Passed
10	MID	QPSK	RB 1	22.34	1	1	7.66	Passed
10	MID	QPSK	RB 50	21.51	1	1	8.49	Passed
10	MID	16QAM	RB 1	21.58	1	1	8.42	Passed
10	MID	16QAM	RB 50	20.62	1	1	9.38	Passed
10	High	QPSK	RB 1	22.42	1	1	7.58	Passed
10	High	QPSK	RB 50	21.6	1	1	8.4	Passed
10	High	16QAM	RB 1	21.61	1	1	8.39	Passed
10	High	16QAM	RB 50	20.72	1	1	9.28	Passed
15	Low	QPSK	RB 1	22.08	1	1	7.92	Passed
15	Low	QPSK	RB 36	21.11	1	1	8.89	Passed
15	Low	QPSK	RB 75	21.22	1	1	8.78	Passed
15	Low	16QAM	RB 1	21.24	1	1	8.76	Passed
15	Low	16QAM	RB 75	20.39	1	1	9.61	Passed
15	MID	QPSK	RB 1	22.36	1	1	7.64	Passed
15	MID	QPSK	RB 36	21.44	1	1	8.56	Passed
15	MID	QPSK	RB 75	21.52	1	1	8.48	Passed
15	MID	16QAM	RB 1	21.37	1	1	8.63	Passed
15	MID	16QAM	RB 75	20.67	1	1	9.33	Passed
15	High	QPSK	RB 1	22.46	1	1	7.54	Passed
15	High	QPSK	RB 36	21.67	1	1	8.33	Passed
15	High	QPSK	RB 75	21.63	1	1	8.37	Passed
15	High	16QAM	RB 1	21.53	1	1	8.47	Passed
15	High	16QAM	RB 75	20.79	1	1	9.21	Passed
20	MID	QPSK	RB 1	22.39	1	1	7.61	Passed
20	MID	QPSK	RB 100	21.64	1	1	8.36	Passed
20	MID	16QAM	RB 1	21.6	1	1	8.4	Passed
20	MID	16QAM	RB 100	20.8	1	1	9.2	Passed
20	Low	QPSK	RB 1	22.18	1	1	7.82	Passed
20	Low	QPSK	RB 100	21.3	1	1	8.7	Passed
20	Low	16QAM	RB 1	21.41	1	1	8.59	Passed
20	Low	16QAM	RB 100	20.46	1	1	9.54	Passed
20	High	QPSK	RB 1	22.41	1	1	7.59	Passed
20	High	QPSK	RB 100	21.75	1	1	8.25	Passed
20	High	16QAM	RB 100	20.79	1	1	9.21	Passed
20	High	16QAM	RB 1	21.61	1	1	8.39	Passed

3.2 Frequency stability

Standard FCC Part 27, Subpart C

The test was performed according to: FCC §2.1055

3.2.1 Test Description

- 1) The EUT was placed inside a temperature chamber.
 - 2) The EUT was coupled to a Digital Communication Tester. Refer to chapter "Setup Drawings".
 - 3) The climatic chamber was cycled down/up to a certain temperature, starting with the EUT minimum temperature.
 - 4) After the temperature was stabilized the EUT was switched on and a call was established on a Traffic Channel between the EUT and the Digital Communication Tester.
Important Settings:
 - Output Power: Maximum
 - Mid Channel
 - 5) The frequency error of the EUT was recorded by using an internal measurement function of the Digital Communication Tester immediately after the call was established, five minutes after the call was established and ten minutes after the call was established.
 - 6) This measurement procedure was performed for temperature variation from -30°C to $+50^{\circ}\text{C}$ in increments of 10°C , if not otherwise stated in the detailed results.
- When the EUT did not operate at certain temperature levels, these measurements were left out.

3.2.2 Test Requirements / Limits

§2.1055 Measurements required: Frequency stability

- (a) The frequency stability shall be measured with variation of ambient temperature as follows:
 - (1) From -30° to $+50^{\circ}$ centigrade for all equipment except that specified in paragraphs (a) (2) and (3) of this section.
 - (b) Frequency measurements shall be made at the extremes of the specified temperature range and at intervals of not more than 10° centigrade through the range. A period of time sufficient to stabilize all of the components of the oscillator circuit at each temperature level shall be allowed prior to frequency measurement. The short term transient effects on the frequency of the transmitter due to keying (except for broadcast transmitters) and any heating element cycling normally occurring at each ambient temperature level also shall be shown. Only the portion or portions of the transmitter containing the frequency determining and stabilizing circuitry need be subjected to the temperature variation test.
- (d) The frequency stability shall be measured with variation of primary supply voltage as follows:
 - (1) Vary primary supply voltage from 85 to 115 percent of the nominal value for other than hand carried battery equipment.
 - (2) For hand carried, battery powered equipment, reduce primary supply voltage to the battery operating end point which shall be specified by the manufacturer.
 - (3) The supply voltage shall be measured at the input to the cable normally provided with the equipment, or at the power supply terminals if cables are not normally provided. Effects on frequency of transmitter keying (except for broadcast transmitters) and any heating element cycling at the nominal supply voltage and at each extreme also shall be shown.

§27.54 Frequency stability

The frequency stability shall be sufficient to ensure that the fundamental emissions stay within the authorized bands of operation.

7Layers interpretation of limit:

To ensure that the frequency stability shall be sufficient to ensure that the fundamental emission stays within the authorized frequency block following limit was used:

+/- 2.5 ppm = 4350 Hz for channel 1450, frequency 1740.0 MHz

+/- 2.5 ppm = 4331 Hz for channel 1412, frequency 1732.4 MHz

in accordance with FCC Part 22, Subpart H, §22.355, table C-1: Frequency tolerance for the carrier frequency of mobile transmitters in the Public Mobile Service in the frequency range 821 to 896 MHz.

3.2.3 Test Protocol

Temp. °C	Duration min	Voltage	Limit Hz	Freq. error Average (Hz)	Freq. error Max. (Hz)	Verdict
-30	0	normal	6337.5	4	16	passed
-30	5			1	9	passed
-30	10			-5	-14	passed
-20	0	normal	6337.5	-2	-13	passed
-20	5			2	17	passed
-20	10			-1	7	passed
-10	0	normal	6337.5	0	-15	passed
-10	5			7	21	passed
-10	10			4	12	passed
0	0	normal	6337.5	-1	7	passed
0	5			-1	15	passed
0	10			-2	-11	passed
10	0	normal	6337.5	5	11	passed
10	5			8	21	passed
10	10			-3	-7	passed
20	0	low	6337.5	8	21	passed
20	5			7	18	passed
20	10			-5	-21	passed
20	0	normal = high ¹⁾	6337.5	9	17	passed
20	5			7	19	passed
20	10			-6	-13	passed
20	0	high	6337.5	4	19	passed
20	5			11	21	passed
20	10			1	-10	passed
30	0	normal	6337.5	1	-13	passed
30	5			-7	-14	passed
30	10			-7	-14	passed
40	0	normal	6337.5	2	-4	passed
40	5			5	15	passed
40	10			-6	-11	passed
50	0	normal	6337.5	-3	-10	passed
50	5			4	12	passed
50	10			-1	-6	passed

3.3 Spurious emissions at antenna terminals

Standard FCC Part 27, Subpart C

The test was performed according to FCC §2.1051

3.3.1 Test Description

1) The EUT was coupled to a Spectrum Analyser and a Digital Communication Tester through a Power Divider. Refer to chapter "Setup Drawings".

2) The total insertion losses for signal path 1 and signal path 2 were measured. The values were used to correct the readings from the Spectrum Analyser and the Digital Communication Tester.

3) A call was established on a Traffic Channel between the EUT and the Digital Communication Tester.

Important Settings:

- Output Power: Maximum

- Channel: please refer to the detailed results

4) Important Analyser Settings

- [Resolution Bandwidth]:

a) [$\geq 1\%$ of wanted signal bandwidth] in the Span of 1 MHz directly below and above the PCS-Band,

b) otherwise [100 kHz] (or [1 MHz] for accelerated sweep times)

c) [reduced resolution bandwidth] in case the curve of the analyser IF-Filter or the wanted EUT signal leads to an exceeding of the limit, in this case a correction factor was used

- Sweep Time: depending on the transmitting signal, the span and the resolution bandwidth

5) The spurious emissions peaks were measured in the frequency range from 9 kHz to 10 GHz (up to the 10th harmonic) during the call was established

3.3.2 Test Requirements / Limits

§ 2.1051 Spurious emissions at antenna terminals

The radio frequency voltage or power generated within the equipment and appearing on a spurious frequency shall be checked at the equipment output terminals when properly loaded with a suitable artificial antenna. Curves or equivalent data shall show the magnitude of each harmonic and other spurious emission that can be detected when the equipment is operated under the conditions specified in Sec. 2.1049 as appropriate. The magnitude of spurious emissions which are attenuated more than 20 dB below the permissible value need not be specified.

§ 2.1057 Frequency spectrum to be investigated.

(a) In all of the measurements set forth in Secs. 2.1051 and 2.1053, the spectrum shall be investigated from the lowest radio frequency signal generated in the equipment, without going below 9 kHz, up to at least the frequency shown below:

(1) If the equipment operates below 10 GHz: to the tenth harmonic of the highest fundamental frequency or to 40 GHz, whichever is lower.

(b) Particular attention should be paid to harmonics and subharmonics of the carrier frequency as well as to those frequencies removed from the carrier by multiples of the oscillator frequency. Radiation at the frequencies of multiplier stages should also be checked.

- (c) The amplitude of spurious emissions which are attenuated more than 20 dB below the permissible value need not be reported.
- (d) Unless otherwise specified, measurements above 40 GHz shall be performed using a minimum resolution bandwidth of 1 MHz.

§ 27.53 Emission limits

(h) For operations in the 1710–1755 MHz and 2110–2155 MHz bands, the power of any emission outside a licensee's frequency block shall be attenuated below the transmitter power (P) by at least $43 + 10 \log_{10}(P)$ dB.

Remark of the test laboratory: This is calculated to be -13 dBm.

(1) Compliance with this provision is based on the use of measurement instrumentation employing a resolution bandwidth of 1 megahertz or greater. However, in the 1 megahertz bands immediately outside and adjacent to the licensee's frequency block, a resolution bandwidth of at least one percent of the emission bandwidth of the fundamental emission of the transmitter may be employed. The emission bandwidth is defined as the width of the signal between two points, one below the carrier center frequency and one above the carrier center frequency, outside of which all emissions are attenuated at least 26 dB below the transmitter power.

(2) When measuring the emission limits, the nominal carrier frequency shall be adjusted as close to the licensee's frequency block edges, both upper and lower, as the design permits.

(3) The measurements of emission power can be expressed in peak or average values, provided they are expressed in the same parameters as the transmitter power.

For reporting only spurious emission levels reaching to the 20dB margin to limit were noted.

3.3.3 Test Protocol

Band	Band width	Modulation	Channel	detector	trace	resolution bandwidth /kHz	frequency /MHz	peak value /dBm	margin to limit /dB	limit /dBm	verdict
eFDD7	5	16QAM	20775	rms	maxhold	100	2498.95	-16.7	3.7	-13.0	passed
				rms	maxhold	50	2499.99	-25.0	12.0	-13.0	passed
			21100	rms	maxhold	1000	2653.533	-42.62	29.62	-13	passed
				rms	maxhold	50	2570.00	-24.9	11.9	-13.0	passed
			21425	rms	maxhold	100	2571.00	-17.1	4.1	-13.0	passed
				rms	maxhold	100	2498.98	-15.5	2.5	-13.0	passed
		QPSK	20775	rms	maxhold	50	2499.99	-23.9	10.9	-13.0	passed
				rms	maxhold	1000	2653.533	-42.62	29.62	-13	passed
			21100	rms	maxhold	50	2570.00	-23.9	10.9	-13.0	passed
				rms	maxhold	100	2571.00	-15.8	2.8	-13.0	passed

3.4 Emission and Occupied Bandwidth

Standard FCC Part 27, Subpart C

The test was performed according to: FCC §2.1049

3.4.1 Test Description

1) The EUT was coupled to a Spectrum Analyser and a Digital Communication Tester through a Power Divider. Refer to chapter "Setup Drawings".

2) The total insertion losses for signal path 1 and signal path 2 were measured. The values were used to correct the readings from the Spectrum Analyser and the Digital Communication Tester.

3) A call was established on a Traffic Channel between the EUT and the Digital Communication Tester.

Important Settings:

- Output Power: Maximum
- Channel: please refer to the detailed results

4) Important Analyser Settings:

- Resolution Bandwidth: >1% of the manufacturer's stated occupied bandwidth

5) The maximum spectral level of the modulated signal was recorded as the reference.

6) The emission bandwidth is measured as follows:

the two furthest frequencies above and below the frequency of the maximum reference level where the spectrum is -26 dB down have to be found.

7) The occupied bandwidth (99% Bandwidth) is measured as follows:

the occupied bandwidth, that is the frequency bandwidth such that, below its lower and above its upper frequency limits, the mean powers are each equal to 0.5 percent of the total mean power.

The maximum number of resource blocks are used for each channel bandwidth.

3.4.2 Test Requirements / Limits

§ 2.1049 Measurements required: Occupied bandwidth

The occupied bandwidth, that is the frequency bandwidth such that, below its lower and above its upper frequency limits, the mean powers radiated are each equal to 0.5 percent of the total mean power radiated by a given emission shall be measured under the following conditions (as applicable):

(h) Transmitters employing digital modulation techniques - when modulated by an input signal such that its amplitude and symbol rate represent the maximum rated conditions under which the equipment will be operated. The signal shall be applied through any filter networks, pseudo-random generators or other devices required in normal service. Additionally, the occupied bandwidth shall be shown for operation with any devices used for modifying the spectrum when such devices are optional at the discretion of the user.

3.4.3 Test Protocol

The maximum number of resource blocks are used for each channel bandwidth.

LTE Band 7							
Channel BW: 5MHz				Channel BW: 10 MHz			
Channel	Frequency (MHz)	99% BW (MHz)		Channel	Frequency (MHz)	99% BW (MHz)	
		QPSK	16QAM			QPSK	16QAM
low	2502.50 MHz	4.558611	4.544139	low	2505.00 MHz	8.972504	8.972504
mid	2535.00 MHz	4.529667	4.544139	mid	2535.00 MHz	8.972504	8.972504
High	2567.50 MHz	4.544139	4.529667	High	2565.00 MHz	9.001447	8.972504
LTE Band 7							
Channel BW: 15MHz				Channel BW: 20 MHz			
Channel	Frequency (MHz)	99% BW (MHz)		Channel	Frequency (MHz)	99% BW (MHz)	
		QPSK	16QAM			QPSK	16QAM
low	2507.50 MHz	13.50217	13.54559	low	2510.00 MHz	17.88712	17.94501
mid	2535.00 MHz	13.54559	13.54559	mid	2535.00 MHz	17.88712	17.94501
High	2562.50 MHz	13.50217	13.54559	High	2560.00 MHz	17.88712	17.88712

3.5 Band edge compliance

Standard FCC Part 24, Subpart C

The test was performed according to: FCC §27.53

3.5.1 Test Description

1) The EUT was coupled to a Spectrum Analyser and a Digital Communication Tester through a Power Divider. Refer to chapter "Setup Drawings".

2) The total insertion losses for signal path 1 and signal path 2 were measured. The values were used to correct the readings from the Spectrum Analyser and the Digital Communication Tester.

3) A call was established on a Traffic Channel between the EUT and the Digital Communication Tester.

Important Settings:

- Output Power: Maximum

- Channel: please refer to the detailed results

4) Important Analyser Settings:

- Resolution Bandwidth = Video Bandwidth: >1% of the manufacturer's stated occupied bandwidth

3.5.2 Test Requirements / Limits

§ 27.53 Emission limitations for cellular equipment

(h) For operations in the 1710–1755 MHz and 2110–2155 MHz bands, the power of any emission outside a licensee's frequency block shall be attenuated below the transmitter power (P) by at least $43 + 10 \log_{10}(P)$ dB.

Remark of the test laboratory: This is calculated to be -13 dBm.

(1) Compliance with this provision is based on the use of measurement instrumentation employing a resolution bandwidth of 1 megahertz or greater. However, in the 1 megahertz bands immediately outside and adjacent to the licensee's frequency block, a resolution bandwidth of at least one percent of the emission bandwidth of the fundamental emission of the transmitter may be employed. The emission bandwidth is defined as the width of the signal between two points, one below the carrier center frequency and one above the carrier center frequency, outside of which all emissions are attenuated at least 26 dB below the transmitter power.

(2) When measuring the emission limits, the nominal carrier frequency shall be adjusted as close to the licensee's frequency block edges, both upper and lower, as the design permits.

(3) The measurements of emission power can be expressed in peak or average values, provided they are expressed in the same parameters as the transmitter power.

For reporting only spurious emission levels reaching to the 20dB margin to limit were noted.

3.5.3 Test Protocol

Band	Bandwidth (MHz)	Modulation	Resource Blocks / Offset	Channel	Detector	Frequency (MHz)	Peak Value (dBm)	Limit (dBm)	Verdict
eFDD7	5	QPSK	25 / 0	20775	Average	2500	-28.18	-13	Passed
		QPSK	25 / 0	20775	RMS	2500	-25.62	-13	Passed
		QPSK	25 /Max	21425	Average	2570	-27.7	-13	Passed
		QPSK	25 /Max	21425	RMS	2570	-25.26	-13	Passed
		16QAM	25 / 0	20775	Average	2500	-28.44	-13	Passed
		16QAM	25 / 0	20775	RMS	2500	-26.2	-13	Passed
		16QAM	25 /Max	21425	Average	2570	-28.44	-13	Passed
		16QAM	25 /Max	21425	RMS	2570	-26	-13	Passed
	10	QPSK	50 / 0	20800	Average	2500	-31.11	-13	Passed
		QPSK	50 / 0	20800	RMS	2500	-29.52	-13	Passed
		QPSK	50 /Max	21400	Average	2570	-31.83	-13	Passed
		QPSK	50 /Max	21400	RMS	2570	-30.12	-13	Passed
		16QAM	50 / 0	20800	Average	2500	-31.11	-13	Passed
		16QAM	50 / 0	20800	RMS	2500	-29.82	-13	Passed
		16QAM	50 /Max	21400	Average	2570	-32.62	-13	Passed
		16QAM	50 /Max	21400	RMS	2570	-31.11	-13	Passed
	15	QPSK	75 / 0	20825	Average	2500	-30.77	-13	Passed
		QPSK	75 / 0	20825	RMS	2500	-29.52	-13	Passed
		QPSK	75 /Max	21375	Average	2570	-31.83	-13	Passed
		QPSK	75 /Max	21375	RMS	2570	-30.44	-13	Passed
		16QAM	75 / 0	20825	Average	2500	-30.77	-13	Passed
		16QAM	75 / 0	20825	RMS	2500	-29.52	-13	Passed
		16QAM	75 /Max	21375	Average	2570	-32.2	-13	Passed
		16QAM	75 /Max	21375	RMS	2570	-31.11	-13	Passed
	20	QPSK	100 / 0	20850	Average	2500	-32.22	-13	Passed
		QPSK	100 / 0	20850	RMS	2500	-31.11	-13	Passed
		QPSK	100 /Max	21350	Average	2570	-32.62	-13	Passed
		QPSK	100 /Max	21350	RMS	2570	-31.46	-13	Passed
		16QAM	100 / 0	20850	Average	2500	-31.83	-13	Passed
		16QAM	100 / 0	20850	RMS	2500	-31.11	-13	Passed
		16QAM	100 /Max	21350	Average	2570	-33.49	-13	Passed
		16QAM	100 /Max	21350	RMS	2570	-32.22	-13	Passed

3.6 Power to Average Ratio

Standard FCC §2.1046, §27.50 (d)

The test was performed according to: §2.1046, §27.50 (d)

A peak to average ratio measurement is performed at the conducted port of the EUT. The spectrum analyzers Complementary Cumulative Distribution Function (CCDF) measurement profile is used to determine the largest deviation between the average and the peak power of the EUT in a given bandwidth.

The CCDF curve shows how much time the peak waveform spends at or above a given average power level. The percent of time the signal spends at or above the level defines the probability for that particular power level.

KDB 971168 v02r01 – Section 5.7.1 was applied.

Test Settings

1. The signal analyzer's CCDF measurement profile is enabled
2. Frequency = carrier center frequency
3. Measurement BW > Emission bandwidth of signal
4. The signal analyser was set to collect one million samples to generate the CCDF curve
5. The measurement interval was set depending on the type of signal analysed. For continuous signals (>98% duty cycle), the measurement interval was set to 1ms.

3.6.1 Test Protocol

Band	Bandwidth	Channel	Modulation	Measured Vaule (dB)	Limit	Verdict
eFDD7	5	Low	QPSK	5.57	13 dB	Passed
		mid		5.71	13 dB	Passed
		High		5.59	13 dB	Passed
		Low	16QAM	6.32	13 dB	Passed
		mid		6.38	13 dB	Passed
		High		6.32	13 dB	Passed

4 Test Equipment

The calibration, hardware and software states are shown for the testing period.

Test Equipment Anechoic Chamber

Lab ID:	Lab 1		
Manufacturer:	Frankonia		
Description:	Anechoic Chamber for radiated testing		
Type:	10.58x6.38x6.00 m ³		
	<i>Calibration Details</i>	<i>Last Execution</i>	<i>Next Exec.</i>
	NSA (FCC)	2014/01/09	2017/01/09

Single Devices for Anechoic Chamber

<i>Single Device Name</i>	<i>Type</i>	<i>Serial Number</i>	<i>Manufacturer</i>	
Air compressor	none	-	Atlas Copco	
Anechoic Chamber	10.58 x 6.38 x 6.00 m ³	none	Frankonia	
	<i>Calibration Details</i>		<i>Last Execution</i>	<i>Next Exec.</i>
	FCC listing 96716 3m Part15/18		2014/01/09	2017/01/08
Controller Maturo	MCU	961208	Maturo GmbH	
EMC camera	CE-CAM/1	-	CE-SYS	
EMC camera Nr.2	CCD-400E	0005033	Mitsubishi	
Filter ISDN	B84312-C110-E1		Siemens&Matsushita	
Filter Universal 1A	BB4312-C30-H3	-	Siemens&Matsushita	

Test Equipment Radio Lab Test Equipment

Lab ID: Lab 2
Description: Radio Lab Test Equipment

Single Devices for Radio Lab Test Equipment

<i>Single Device Name</i>	<i>Type</i>	<i>Serial Number</i>	<i>Manufacturer</i>	
Broadband Power Divider SMA	WA1515	A856	Weinschel Associates	
Coax Attenuator 10dB SMA 2W	4T-10	F9401	Weinschel Associates	
Coax Attenuator 10dB SMA 2W	56-10	W3702	Weinschel Associates	
Coax Attenuator 10dB SMA 2W	56-10	W3711	Weinschel Associates	
Coax Cable Huber&Suhner	Sucotest 2,0m		Huber&Suhner	
Coax Cable Rosenberger Micro Coax FA210A0010003030 SMA/SMA 1,0m	FA210A0010003030	54491-2	Rosenberger Micro-Coax	
Power Meter	NRVD	828110/016	Rohde & Schwarz GmbH & Co.KG	
	<i>Calibration Details</i>		<i>Last Execution</i>	<i>Next Exec.</i>
	Standard calibration		2014/05/13	2015/05/12
RF Step Attenuator RSP	RSP	833695/001	Rohde & Schwarz GmbH & Co.KG	
Rubidium Frequency Standard	Datum, Model: MFS	5489/001	Datum-Beverly	
	Standard calibration		2014/07/03	2015/07/02
Sensor Head A	NRV-Z1	827753/005	Rohde & Schwarz GmbH & Co.KG	
	<i>Calibration Details</i>		<i>Last Execution</i>	<i>Next Exec.</i>
	Standard calibration		2014/05/13	2015/05/12
Signal Generator SME	SME03	827460/016	Rohde & Schwarz GmbH & Co.KG	
	<i>Calibration Details</i>		<i>Last Execution</i>	<i>Next Exec.</i>
	Standard calibration		2011/11/25	2014/11/24
Signal Generator SMP	SMP02	836402/008	Rohde & Schwarz GmbH & Co. KG	
	<i>Calibration Details</i>		<i>Last Execution</i>	<i>Next Exec.</i>
	Standard calibration		2013/05/06	2016/05/05
Spectrum Analyser	FSIQ26	840061/005	Rohde & Schwarz GmbH & Co. KG	
	<i>Calibration Details</i>		<i>Last Execution</i>	<i>Next Exec.</i>
	Standard Calibration		2013/02/12	2015/02/11

Test Equipment Temperature Chamber 05

Lab ID: Lab 2
Manufacturer: see single devices
Description: Temperature Chamber VT4002
Type: Vötsch
Serial Number: see single devices

Single Devices for Temperature Chamber 05

Single Device Name	Type	Serial Number	Manufacturer
Temperature Chamber Vötsch 05	VT 4002	58566080550010	Vötsch
	<i>Calibration Details</i>		<i>Last Execution</i> <i>Next Exec.</i>
	Customized calibration		2014/03/11 2016/03/10

Test Equipment Auxiliary Test Equipment

Lab ID: Lab 1, Lab 2
Manufacturer: see single devices
Description: Single Devices for various Test Equipment
Type: various
Serial Number: none

Single Devices for Auxiliary Test Equipment

Single Device Name	Type	Serial Number	Manufacturer
Broadband Power Divider N (Aux)	1506A / 93459	LM390	Weinschel Associates
Broadband Power Divider SMA	WA1515	A855	Weinschel Associates
Digital Multimeter 03 (Multimeter)	Fluke 177	86670383	Fluke Europe B.V.
	<i>Calibration Details</i>		<i>Last Execution</i> <i>Next Exec.</i>
	Customized calibration		2013/12/04 2015/12/03
Fibre optic link Satellite (Aux)	FO RS232 Link	181-018	Pontis
Fibre optic link Transceiver (Aux)	FO RS232 Link	182-018	Pontis
Isolating Transformer	LTS 604	1888	Thalheimer Transformatorenwerke GmbH
Notch Filter Ultra Stable (Aux)	WRCA800/960-6EEK	24	Wainwright
Signal Analyzer	FSV30	103005	Rohde & Schwarz GmbH & Co. KG
	<i>Calibration Details</i>		<i>Last Execution</i> <i>Next Exec.</i>
	Standard		2014/02/10 2016/02/09
Spectrum Analyser	FSP3	836722/011	Rohde & Schwarz GmbH & Co. KG
	<i>Calibration Details</i>		<i>Last Execution</i> <i>Next Exec.</i>
	Standard		2012/06/13 2015/06/12
Spectrum Analyser	FSU26	200418	Rohde & Schwarz GmbH & Co.KG
	<i>Calibration Details</i>		<i>Last Execution</i> <i>Next Exec.</i>
	Standard calibration		2013/07/29 2014/07/28
	Standard calibration		2014/07/29 2015/07/28
Vector Signal Generator	SMIQ 03B	832492/061	Rohde & Schwarz GmbH & Co.KG

Test Equipment Digital Signalling Devices

Lab ID: Lab 1, Lab 2
Description: Signalling equipment for various wireless technologies.

Single Devices for Digital Signalling Devices

Single Device Name	Type	Serial Number	Manufacturer	
Bluetooth Signalling Unit CBT	CBT	100589	Rohde & Schwarz GmbH & Co. KG	
	<i>Calibration Details</i>		<i>Last Execution</i>	<i>Next Exec.</i>
	Standard calibration		2011/11/24	2014/11/23
CMW500	CMW500	107500	Rohde & Schwarz GmbH & Co.KG	
	<i>Calibration Details</i>		<i>Last Execution</i>	<i>Next Exec.</i>
	Standard calibration		2014/01/27	2016/01/26
Digital Radio Communication Tester	CMD 55	831050/020	Rohde & Schwarz GmbH & Co. KG	
	<i>Calibration Details</i>		<i>Last Execution</i>	<i>Next Exec.</i>
	Standard calibration		2011/11/28	2014/11/27
Universal Radio Communication Tester	CMU 200	102366	Rohde & Schwarz GmbH & Co. KG	
	<i>HW/SW Status</i>		<i>Date of Start</i>	<i>Date of End</i>
	Hardware: B11, B21V14, B21-2, B41, B52V14, B52-2, B53-2, B56V14, B68 3v04, PCMCIA, U65V04 Software: K21 4v21, K22 4v21, K23 4v21, K24 4v21, K42 4v21, K43 4v21, K53 4v21, K56 4v22, K57 4v22, K58 4v22, K59 4v22, K61 4v22, K62 4v22, K63 4v22, K64 4v22, K65 4v22, K66 4v22, K67 4v22, K68 4v22, K69 4v22 Firmware: µP1 8v50 02.05.06 ---		2007/07/16	
Universal Radio Communication Tester	CMU 200	837983/052	Rohde & Schwarz GmbH & Co. KG	
	<i>Calibration Details</i>		<i>Last Execution</i>	<i>Next Exec.</i>
	Standard calibration		2011/12/07	2014/12/06
	<i>HW/SW Status</i>		<i>Date of Start</i>	<i>Date of End</i>
	HW options: B11, B21V14, B21-2, B41, B52V14, B52-2, B53-2, B54V14, B56V14, B68 3v04, B95, PCMCIA, U65V02 SW options: K21 4v11, K22 4v11, K23 4v11, K24 4v11, K27 4v10, K28 4v10, K42 4v11, K43 4v11, K53 4v10, K65 4v10, K66 4v10, K68 4v10, Firmware: µP1 8v40 01.12.05 --- SW: K62, K69		2007/01/02	
Vector Signal Generator	SMU200A	100912	Rohde & Schwarz GmbH & Co. KG	

5 Photo Report

Photos are included in an external report.

6 Setup Drawings

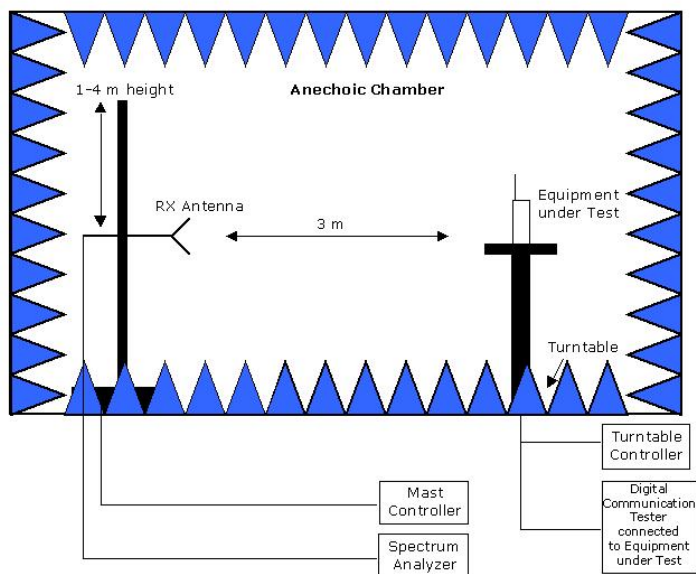

Remark: Depending on the frequency range suitable antenna types, attenuators or preamplifiers are used.

Drawing 1: Setup in the anechoic chamber. For measurements below 1 GHz the ground was replaced by a conducting ground plane.

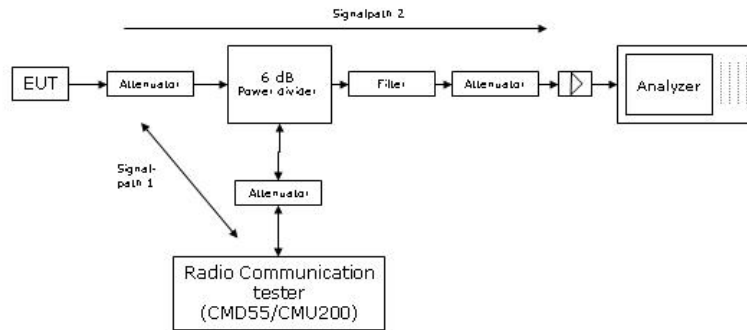

Remark: Depending on the frequency range suitable attenuators and/or filters and/or amplifiers are used.

Principle set-up for conducted measurements under nominal conditions

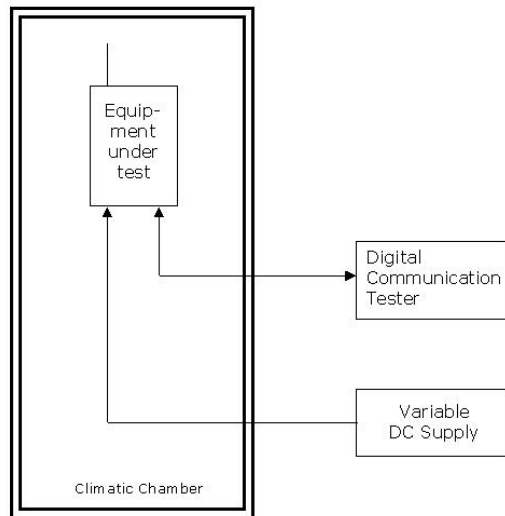

Principle set-up for tests under extreme test conditions

7 Annex measurement plots (worst case)

7.1 RF Power Output

FDD 7, Channel 21100, QPSK

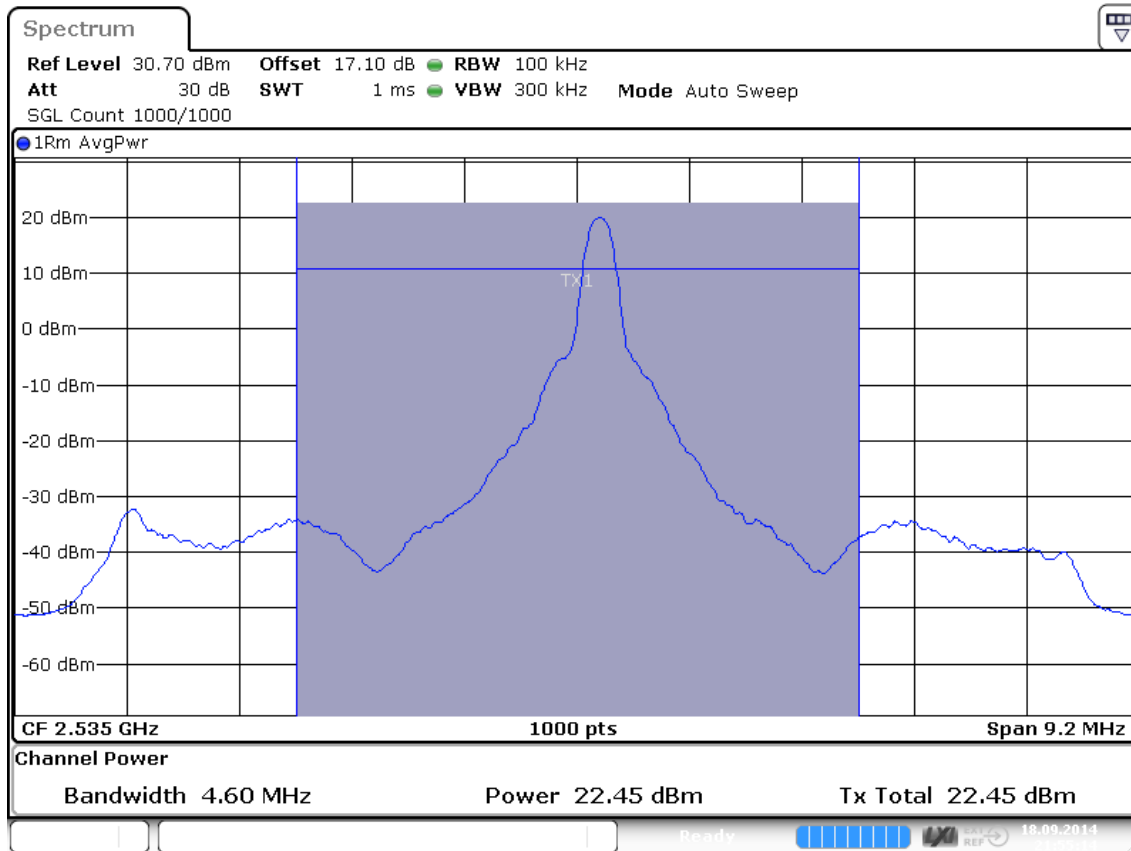

Date: 18 SEP 2014 21:55:14

FDD 7, Channel 21100, 16QAM

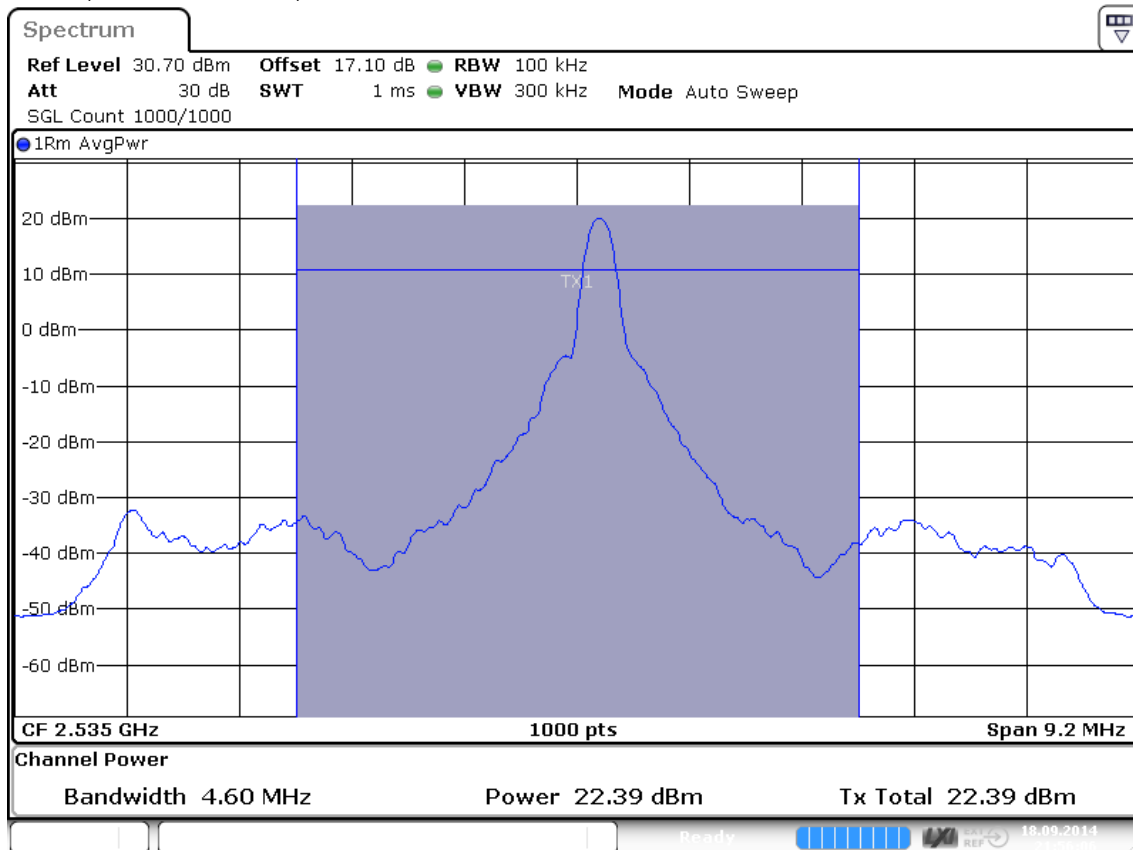

Date: 18_SEP_2014 21:56:06

7.2 Peak to Average Ratio

FDD 7, Ch 21100, QPSK

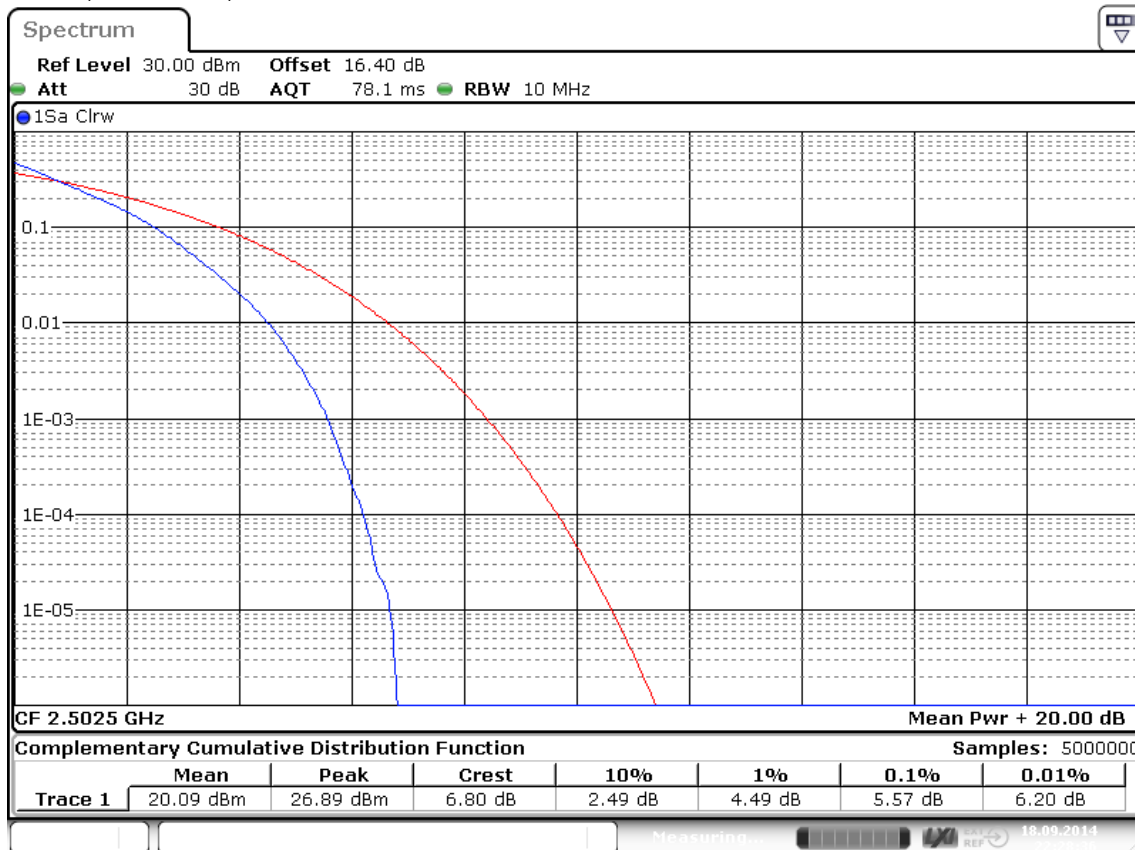

Date: 18 SEP 2014 22:28:36

FDD 7, Ch 21100, 16QAM

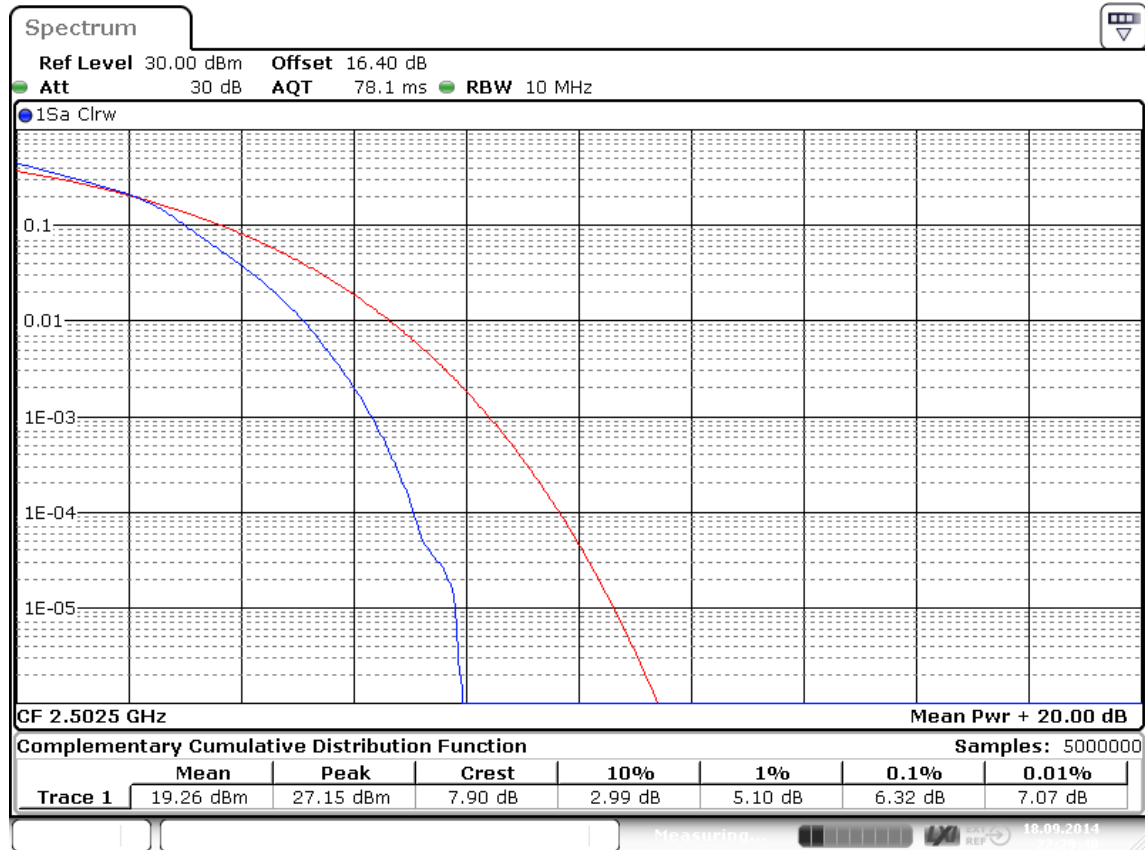

Date: 18 SEP 2014 22:29:40

7.3 Spurious emissions at antenna terminals

eFDD 7 Channel 20775, 16QAM

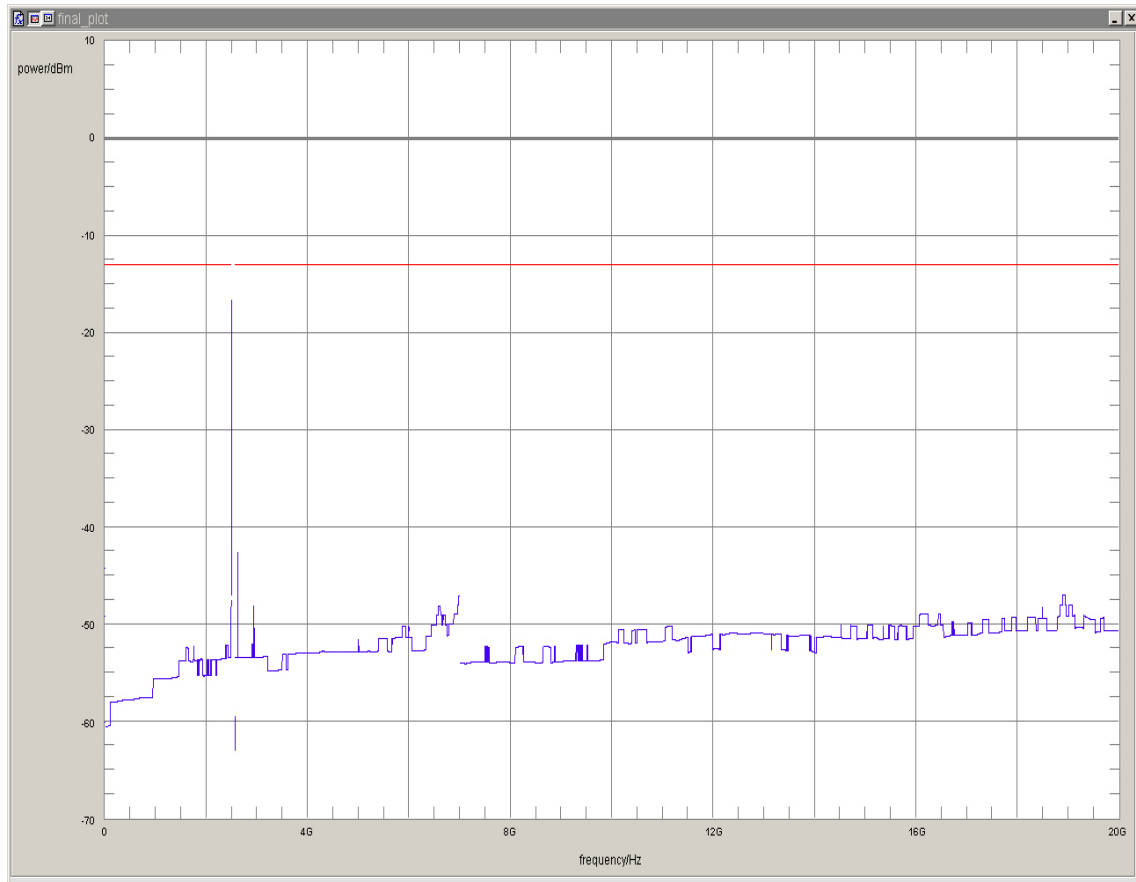

7.4 Emission and Occupied Bandwidth FDD 7 CH 20775, CBW 5 MHz, QPSK

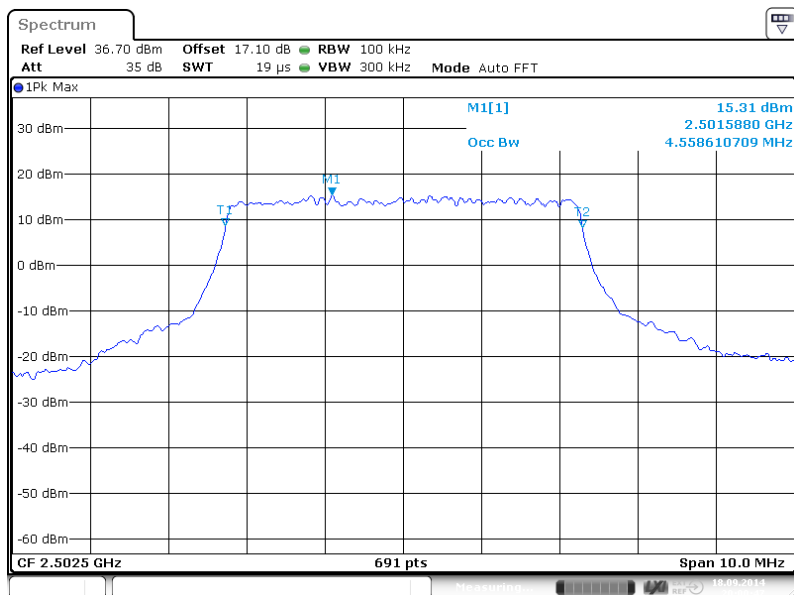

FDD 7 CH 20775, CBW 5 MHz, 16QAM

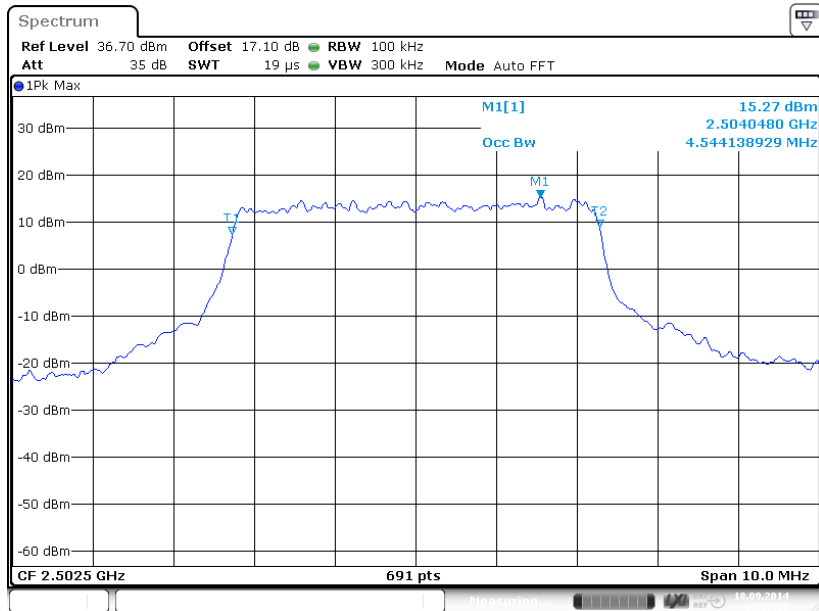

FDD 7 CH 21400, CBW 10 MHz, QPSK

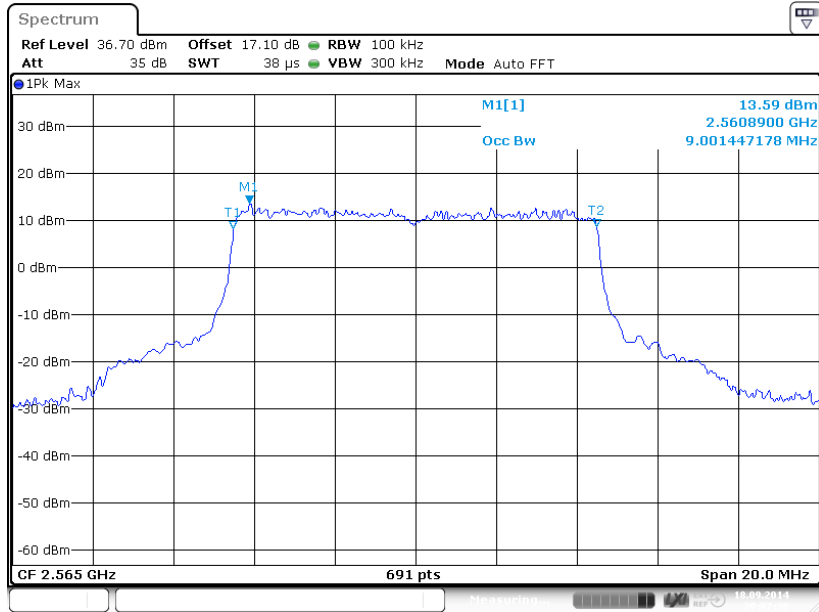

Date: 18 SEP 2014 20:07:38

FDD 7 CH 21400, CBW 10 MHz, 16QAM

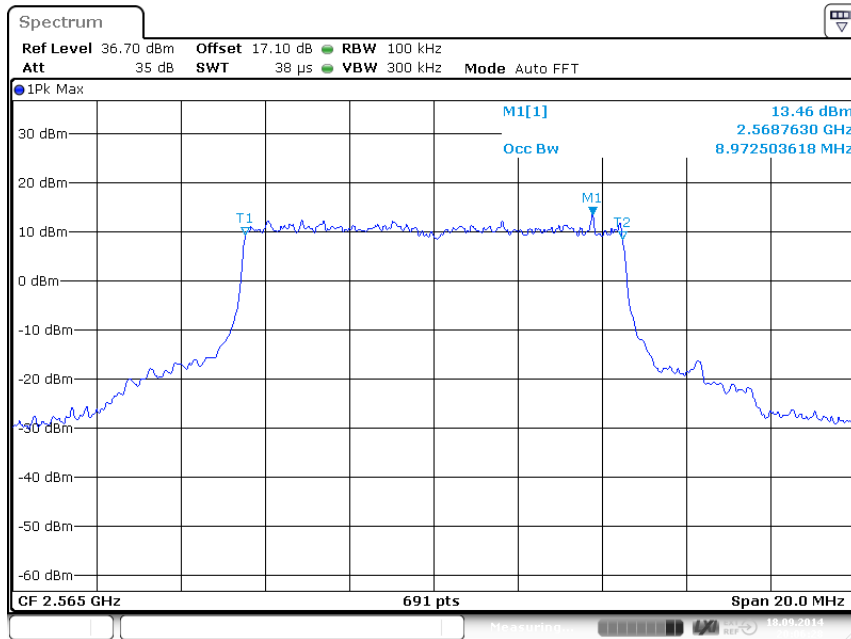

Date: 18 SEP 2014 20:06:29

FDD 7 CH 21100, CBW 15 MHz, QPSK

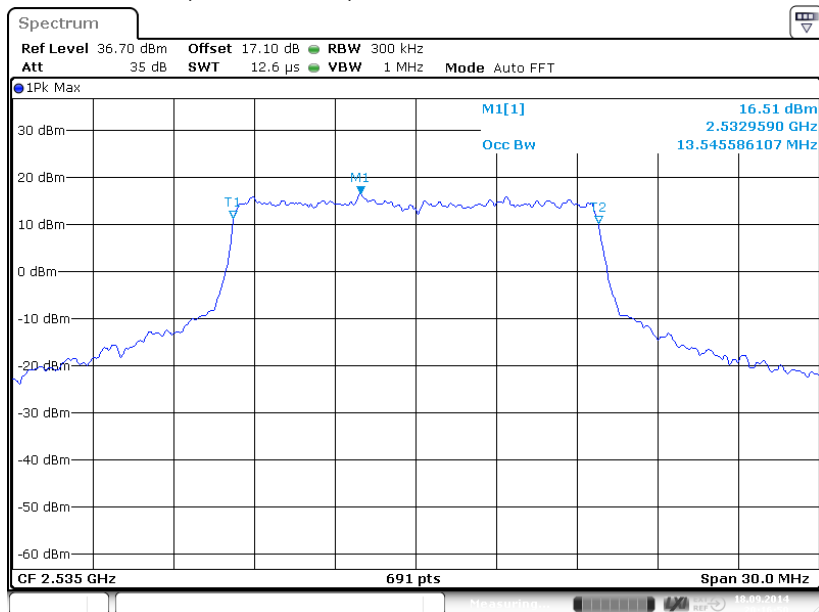

Date: 18 SEP 2014 20:16:49

FDD 7 CH 21100, CBW 15 MHz, 16QAM

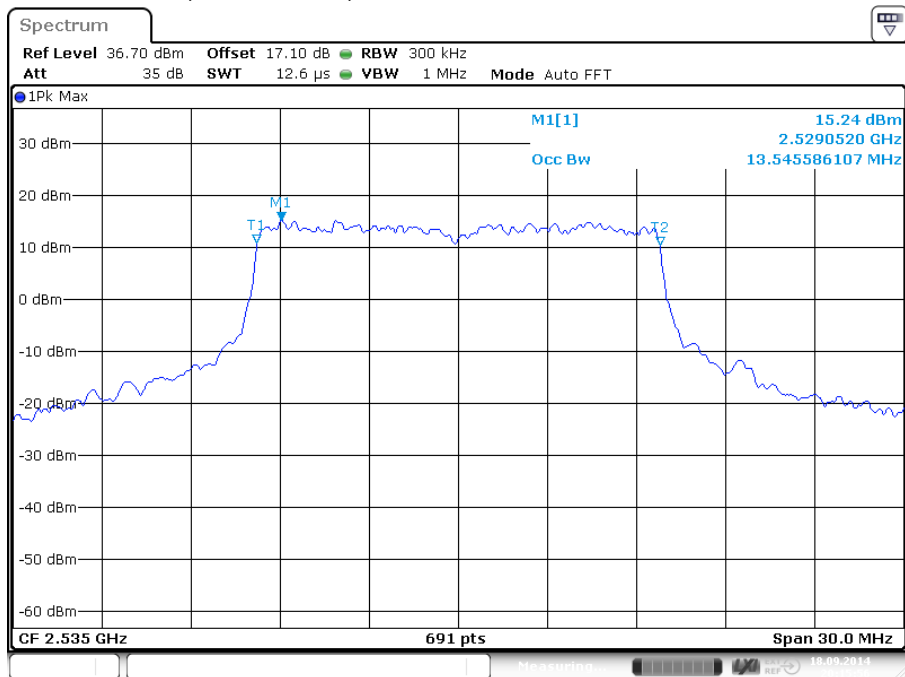

Date: 18 SEP 2014 20:15:56

FDD 7 CH 21100, CBW 20 MHz, QPSK

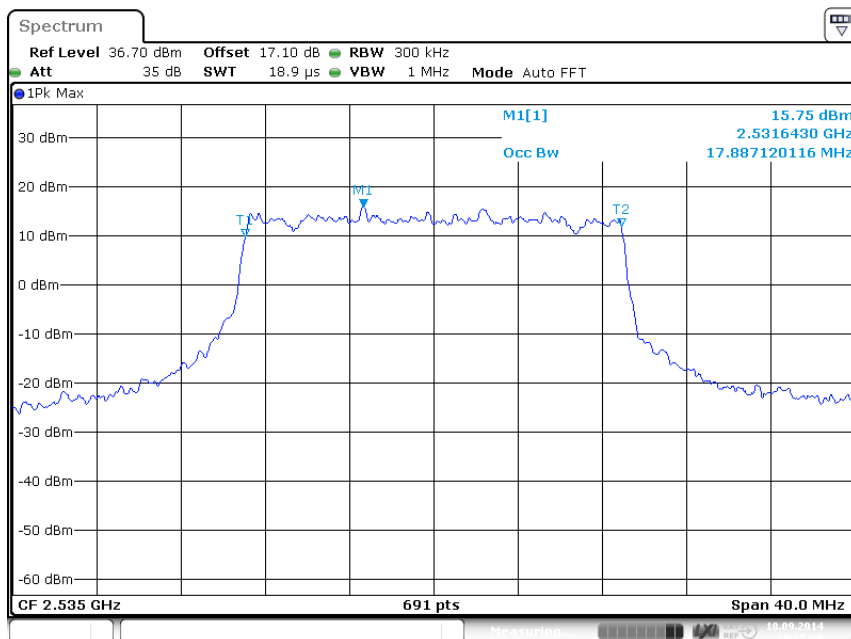

FDD 7 CH 21100, CBW 20 MHz, 16QAM

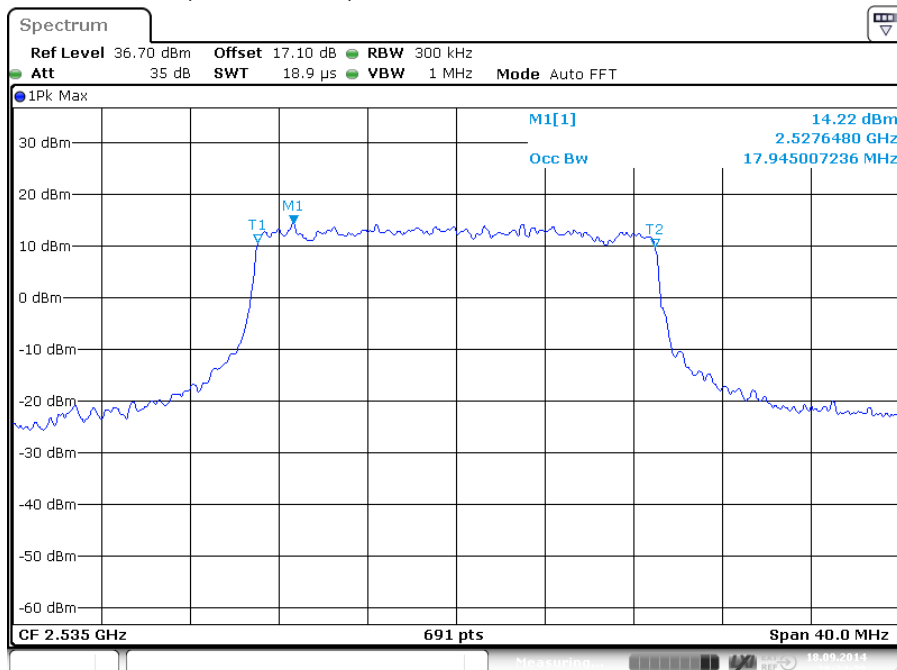

7.5 Band edge compliance

FDD7 Channel 20775, CBW 5MHz

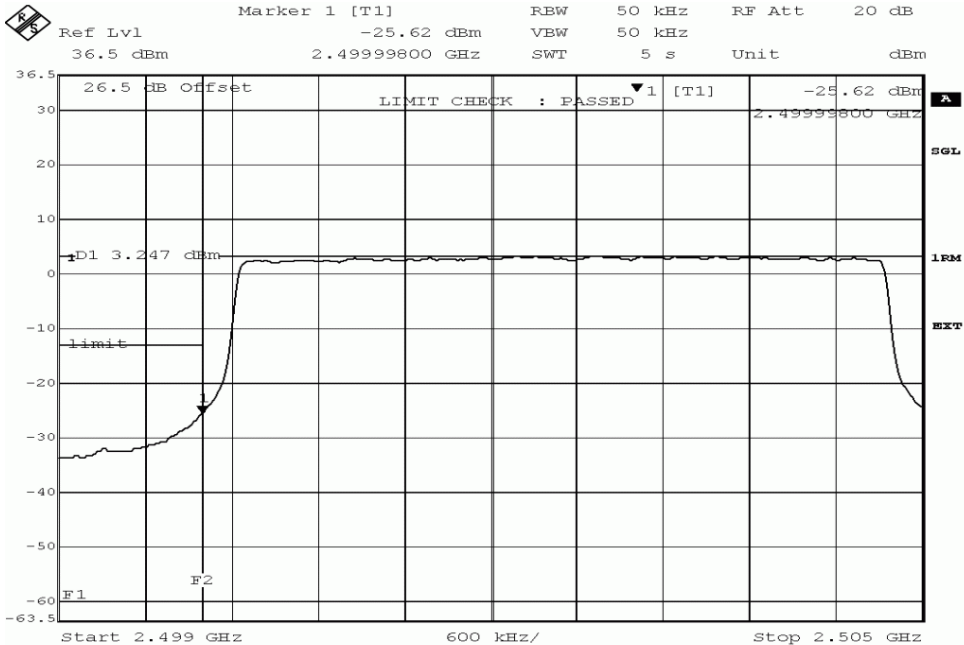

Title: band edge compliance measurement
 Comment A: DE1015004, eFDD7 5MHz BW, band edge compliance, channel 20775 (2502.5MHz)
 Date: 19.SEP.2014 11:03:25

FDD7 Channel 21425, CBW 5MHz

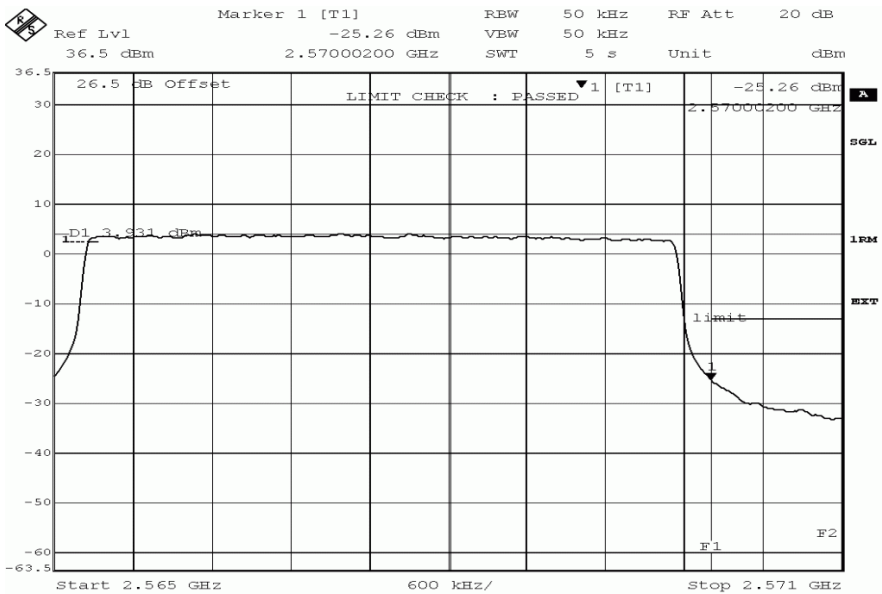

Title: band edge compliance measurement
 Comment A: DE1015004, eFDD7 5MHz BW, band edge compliance, channel 21425 (2567.5MHz)
 Date: 19.SEP.2014 11:00:55