



PHOENIX
TESTLAB

Königswinkel 10
32825 Blomberg, Germany
Phone: +49 (0) 52 35 / 95 00-0
Fax: +49 (0) 52 35 / 95 00-10
office@phoenix-testlab.de
www.phoenix-testlab.de

Test Report

Report Number:

F181014E8

Equipment under Test (EUT):

NINA-B3 series

Applicant:

u-blox AG

Manufacturer:

u-blox AG



Deutsche
Akkreditierungsstelle
D-PL-17186-01-01
D-PL-17186-01-02
D-PL-17186-01-03

References

- [1] **ANSI C63.10-2013**, American National Standard of Procedures for Compliance Testing of Unlicensed Wireless Devices
- [2] **FCC CFR 47 Part 15**, Radio Frequency Devices
- [3] **RSS-247 Issue 2 (February 2017)**, Digital Transmission Systems (DTSs), Frequency Hopping Systems (FHSs) and Licence-Exempt Local Area Network (LE-LAN) Devices
- [4] **RSS-Gen Issue 5 (April 2018)**, General Requirements for Compliance of Radio Apparatus
- [5] **508074 D01 DTS Meas Guidance v04 (April 2017)**, Guidance for performing compliance measurements on transmission systems (DTS) operating under section 15.247

Test Result

The requirements of the tests performed as shown in the overview (clause 4) were fulfilled by the equipment under test. The complete test results are presented in the following.

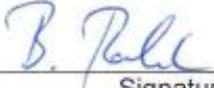
Tested and written by:	Bernward ROHDE Name	 Signature	16.08.2018 Date
Reviewed and approved by:	Thomas KÜHN Name	 Signature	16.08.2018 Date

This test report is only valid in its original form.

Any reproduction of its contents in extracts without written permission of the accredited test laboratory PHOENIX TESTLAB GmbH is prohibited.

The test results herein refer only to the tested sample. PHOENIX TESTLAB GmbH is not responsible for any generalizations or conclusions drawn from these test results concerning further samples. Any modification of the tested samples is prohibited and leads to the invalidity of this test report. Each page necessarily contains the PHOENIX TESTLAB Logo and the TEST REPORT NUMBER.

Contents:	Page
1 Identification.....	6
1.1 Applicant.....	6
1.2 Manufacturer.....	6
1.3 Test Laboratory.....	6
1.4 EUT (Equipment under Test).....	7
1.5 Technical Data of Equipment.....	9
1.5.1 Antenna List.....	11
1.6 Dates.....	11
2 Operational States.....	12
2.1 Description of function of the EUT.....	12
2.2 The following states were defined as the operating conditions.....	12
2.2.1 Operation Modes.....	13
2.2.2 Radio tests.....	13
2.3 Sample selection matrix.....	14
2.3.1 Power settings.....	14
3 Additional Information.....	15
3.1 Module variants.....	15
4 Overview.....	16
5 Results.....	17
5.1 Duty cycle.....	17
5.1.1 Method of measurement.....	17
6.1.1 Test results.....	18
6.2 Maximum peak output power.....	19
6.2.1 Method of measurement (conducted).....	19
6.2.1.1 Test results (conducted).....	20
6.2.2 Method of measurement (radiated).....	21
6.2.2.1 Test results (radiated).....	22
6.3 DTS Bandwidth / 99% Bandwidth.....	23
6.3.1 Method of measurement (conducted).....	23
6.3.1.1 Test results (conducted).....	24
6.3.2 Method of measurement (radiated).....	26
6.4 Peak Power Spectral Density.....	29
6.4.1 Method of measurement (conducted).....	29
6.4.1.1 Test results (conducted).....	30

6.4.2	Method of measurement (radiated)	31
6.4.2.1	Test results (radiated).....	32
6.5	Band-edge compliance.....	33
6.5.1	Method of measurement (band edges next to unrestricted bands (conducted)).....	33
6.5.1.1	Test results (conducted)	34
6.5.2	Method of measurement (band edges next to unrestricted bands (radiated))	35
6.5.2.1	Test results (radiated).....	36
6.5.3	Method of measurement (band edges next to restricted bands (conducted))	37
6.5.3.1	Test results (conducted)	38
6.5.4	Method of measurement (band edges next to restricted bands (radiated)).....	39
6.5.4.1	Test results (radiated).....	40
6.6	Maximum unwanted emissions.....	42
6.6.1	Method of measurement (conducted emissions in the restricted bands)	42
6.6.1.1	Limit calculations	43
6.6.2	Method of measurement (conducted emissions in the unrestricted bands).....	44
6.6.2.1	Reference level measurement	44
6.6.2.2	Emission level measurement	44
6.6.3	Test results (conducted emissions)	45
6.6.3.1	Tested sample PT4-B301#3 (conducted).....	45
6.6.4	Method of measurement (radiated emissions)	50
6.6.4.1	Test results (radiated emissions)	57
6.7	Conducted emissions on power supply lines (150 kHz to 30 MHz).....	76
7	Test Equipment used for Tests	78
8	Report History.....	80
9	List of Annexes	80

1 Identification

1.1 Applicant

Name:	u-blox AG
Address:	Zürcherstr. 68, 8800 Thalwil
Country:	Switzerland
Name for contact purposes:	Mr. Filip KRUZELA
Phone:	+46 40 630 71 70
Fax:	N/A
eMail address:	Filip.Kruzela@u-blox.com
Applicant represented during the test by the following person:	-

1.2 Manufacturer

Name:	u-blox AG
Address:	Zürcherstr. 68, 8800 Thalwil
Country:	Switzerland
Name for contact purposes:	Mr. Filip KRUZELA
Phone:	+46 40 630 71 70
Fax:	N/A
eMail address:	Filip.Kruzela@u-blox.com
Manufacturer represented during the test by the following person:	-

1.3 Test Laboratory

The tests were carried out by: **PHOENIX TESTLAB GmbH**
Königswinkel 10
32825 Blomberg
Germany

accredited by Deutsche Akkreditierungsstelle GmbH (DAkkS) in compliance with DIN EN ISO/IEC 17025 under Reg. No. D-PL-17186-01-02, FCC Test Firm Accreditation with the registration number 469623, designation number DE0004 and Industry Canada Test site registration SITE# IC3469A-1.

1.4 EUT (Equipment under Test)

EUT	
Test object: *	Stand-alone radio module
Model series	NINA-B3
PMN / Model name: *	NINA-B301 (ufl antenna connector) NINA-B302 (u-blox LILY Antenna) NINA-B311 (ufl antenna connector) NINA-B312 (u-blox LILY Antenna)
FCC ID: *	XPYNINAB30 (NINA-B301, NINA-B302) XPYNINAB31 (NINA-B311, NINA-B312)
ISED Certification number: * IC: *	8595A-NINAB30 (NINA-B301, NINA-B302) 8595A-NINAB31 (NINA-B311, NINA-B312)
HVIN: *	NINA-B301, NINA-B302 NINA-B311, NINA-B312
HMN: *	N/A
FVIN: *	N/A
Serial number: *	B33D4CA6EB795AF0401 NINA-B312 (labelled PT2-B312#8) C55D4CA6EB899920500 NINA-B301 (labelled PT4-B301#3)
PCB identifier: *	N/A
Hardware version: *	04 / 05
Software version: *	Radio test modes nRF5_SDK_15.0.0_a53641a (radio_test_14may.hex)

* Declared by the applicant

IEEE 802.15.4 frequencies				
Channel 11	RX	2405 MHz	TX	2405 MHz
Channel 19	RX	2440 MHz	TX	2440 MHz
Channel 25	RX	2475 MHz	TX	2475 MHz

Ancillary Equipment	
Cables (connected to the EUT):	USB 2.0 type A <-> USB 2.0 type B micro, ~0.2 m ^{*1} +2 m USB extension ^{*2}
Fibre optic converter:	Opto USB2.0, MK Messtechnik (PM. No. 482617) ^{*2}
Laptop PC:	Fujitsu Lifebook S751 (PM No. 201036) ^{*2}

*1 Provided by the applicant

*2 Provided by the laboratory

1.5 Technical Data of Equipment

IEEE 802.15.4 radio mode						
Fulfils radio specification: *	IEEE 802.15.4					
Radio chip	Nordic Semiconductor nRF52840					
Antenna type: *	NINA-B301		(ufl antenna connector)		see antenna list	
	NINA-B302		(u-blox LILY Antenna)		see antenna list	
	NINA-B311		(ufl antenna connector)		see antenna list	
	NINA-B312		(u-blox LILY Antenna)		see antenna list	
Antenna name: *	See antenna list					
Antenna gain: *	Max +3 dBi					
Antenna connector: *	NINA-B301		(ufl antenna connector)			
	NINA-B302		(none)			
	NINA-B311		(ufl antenna connector)			
	NINA-B312		(none)			
Evaluation board: *	EVB-NINA-B3					
Power supply EUT: *	DC					
Supply voltage eval board: *	$U_{nom} =$	9 V	$U_{min} =$	5 V	$U_{max} =$	12 V
Supply voltage radio module: *	$U_{nom} =$	3.3	$U_{min} =$	1.7 V	$U_{max} =$	3.6 V
Type of modulation: *	O-QPSK (250 kbit/s)					
Operating frequency range: *	2405 – 2475 MHz					
Number of channels: *	15 (5 MHz channel spacing)					
Temperature range: *	-40 °C to +85 °C					
Lowest / highest internal clock frequency: *	32.768 kHz to 2480 MHz					

* Declared by the applicant

Radio Module	
Radio chip*	Nordic Semiconductor nRF52840
Power supply EUT: *	DC
Supply voltage radio module: *	U _{nom} = 3.3 U _{min} = 1.7 V U _{max} = 3.6 V
Fulfils specification: *	Bluetooth Low Energy; IEEE 802.15.4; Proprietary mode; NFC
Bluetooth Low Energy Conducted output power: *	Typical 8 dBm
Bluetooth Low Energy Type of modulation: *	GFSK (1 Mbit/s; 2 Mbit/s; 500 kbit/s; 125 kbit/s)
Bluetooth Low Energy Operating frequency range: *	2402 – 2480 MHz
Bluetooth Low Energy Number of channels: *	40 (2 MHz channel spacing)
IEEE 802.15.4 Conducted output power: *	Typical 8 dBm
IEEE 802.15.4 Type of modulation: *	O-QPSK (250 kbit/s)
IEEE 802.15.4 Operating frequency range: *	2405 - 2475 MHz
IEEE 802.15.4 Number of channels: *	15 (5 MHz channel spacing)
Proprietary mode Conducted output power: *	Typical 8 dBm
Proprietary mode Type of modulation: *	GFSK (1 Mbit/s; 2 Mbit/s)
Proprietary mode Operating frequency range: *	2402 – 2480 MHz
Proprietary mode Number of channels: *	79 (1 MHz spacing)
NFC Conducted output power: *	No transmitter, receiver only
NFC Type of modulation: *	receiver uses load modulation to “transmit” data (106 kbit/s)
NFC Operating frequency range: *	13.56 MHz
NFC Number of channels: *	1

* Declared by the applicant

1.5.1 Antenna List

Antenna name	Manufacturer	Type	Comment	Gain [dBi]
u-blox LILY Antenna	ProAnt	SMD PIFA	antenna on NINA-B302 and NINA-B312	3
FlatWhip-2400	ProAnt	Monopole	RP-SMA	3
InSide-2400	ProAnt	Patch	10cm cable/U.FL	3
Ex-IT 2400 -RP-SMA 28-001 -MHF 28-001	ProAnt	Monopole	RP-SMA 10 cm cable/U.FL	3
Ex-IT 2400 -RP-SMA 70-002	ProAnt	Monopole	RP-SMA	3

1.6 Dates

Date of receipt of test sample:	24.05.2018
Start of test:	25.05.2018
End of test:	17.07.2018

2.2.1 Operation Modes

Operation Mode	Channel	Frequency [MHz]	Data rate	Power setting [dBm]
1	11	2405	250 kbit/s	8
2	19	2440	250 kbit/s	8
3	25	2475	250 kbit/s	8

2.2.2 Radio tests

For the radio tests the following settings were used:

A connection to the EUT was established via USB cable.
 The USB connection was converted to a serial connection on the EUT.
 The following COM port settings were used with "tera term".
 Baud rate: 115200
 Data: 8 bit
 Parity: None
 Stop: 1 bit
 Flow control: None

The below shown interface was used to set the EUT in the applicable test-mode.

```

COM214 - Tera Term VT
File Edit Setup Control Window Help
RF Test
Usage:
a: Configure start frequency for sweep/frequency for constant carrier
b: Configure end frequency for sweep
c: Start TX carrier
d: Configure time on each frequency for sweep mode(1ms-99ms)
e: Stop TX/RX
n: Enter data rate
o: Start modulated TX carrier
p: Configure output power
s: Print configuration details
r: Start RX sweep
t: Start TX sweep
x: Start RX carrier
  
```

2.3 Sample selection matrix

Test case	Tested sample PT4 version (conducted)	Tested sample PT2 version (radiated)	Tested sample PT4 version (radiated)
Maximum peak output power	PT4-B301#3	PT2-B312#8	-
DTS Bandwidth	PT4-B301#3	PT2-B312#8	-
Peak Power Spectral Density	PT4-B301#3	PT2-B312#8	-
Occupied Channel Bandwidth	PT4-B301#3	PT2-B312#8	-
Band-edge compliance	PT4-B301#3	PT2-B312#8	-
Maximum unwanted emissions	PT4-B301#3	PT2-B312#8	PT4-B301#3 ^{*1}
Conducted emissions on power supply lines (150 kHz to 30 MHz)	PT4-B301#3	-	-

^{*1} Antenna port terminated, housing emission only

2.3.1 Power settings

Test sample	Power setting [dBm]	Hardware Version	Serial	Comment
PT4-B301#3	8 ^{*1}	05	C55D4CA6EB899920500	For all data rates and channels
PT2-B311#6	8 ^{*1}	04	B32D4CA6EB792B60301	For all data rates and channels

^{*1} Power setting 8 is the maximum

3 Additional Information

3.1 Module variants

The modules are offered in two HW versions; a smaller version with an RF pin, and a larger version with an internal PIFA antenna. Both versions are based on the Nordic Semiconductor nRF52840 chip which has an integrated RF core and an application processor.

The modules are also available with or without pre-flashed SW. The NINA-B30 series are sold as 'Open CPU', meaning that the customers create their own SW and the full radio capabilities of the module is available.

The NINA-B31 series are sold with pre-flashed SW developed by u-blox, called 'u-blox connectivity software (uCS)'. This SW limits the radio capabilities of the NINA-B3 to pass world-wide type approvals, and precautions have been taken so that the SW is tamper proof. An end-user will not be able to modify any radio settings that will change the channel plan or maximum output power etc.

Module variant	Filter variant	Hardware revision	Antenna	Software
NINA-B301	PT4	05	RF pin (ufl)	Open CPU for OEM use
NINA-B302	PT2	04	u-blox LILY Antenna	Open CPU for OEM use
NINA-B311	PT4	05	RF pin (ufl)	u-blox connectivity software
NINA-B312	PT2	04	u-blox LILY Antenna	u-blox connectivity software

4 Overview

Application	Frequency range [MHz]	FCC 47 CFR Part 15 section [2]	RSS-247 [3] or RSS-Gen, Issue 5 [4]	Status	Refer page
Maximum Peak Output Power	2400.0 - 2483.5	15.247 (b) (3), (4)	5.4 (d) [3]	Passed	18 et seq.
DTS Bandwidth	2400.0 - 2483.5	15.247 (a) (2)	5.2 (a) [3]	Passed	23 et seq.
Peak Power Spectral Density	2400.0 - 2483.5	15.247 (e)	5.2 (b) [3]	Passed	29 et seq.
Band edge compliance	2400.0 - 2483.5	15.247 (d) 15.205 (a) 15.209 (a)	5.5 [3] 8.9 [4], 8.10 [4]	Passed	33 et seq.
Radiated emissions (transmitter)	0.009 – 26,500	15.247 (d) 15.205 (a) 15.209 (a)	5.5 [3] 8.9 [4], 8.10 [4]	Passed	42 et seq.
Conducted emissions on supply line	0.15 - 30	15.207 (a)	8.8 [4]	Passed	76 et seq.

5 Results

5.1 Duty cycle

5.1.1 Method of measurement

The measurement was performed as an antenna port conducted measurement, as shown below.

Test Setup:

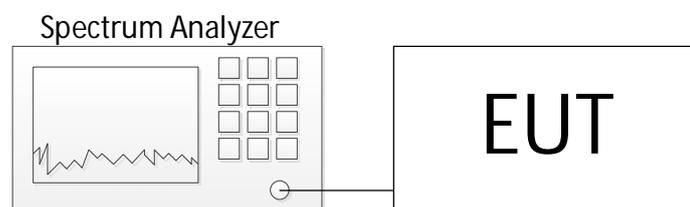

The method described in chapter 11. b) of document [1] or 6 b) of document [5] was used to perform the following test.

Only the worst case plot for each mode was submitted below.

The following measurement technique was used:

The zero-span mode on a spectrum analyzer or EMI receiver if the response time and spacing between two bins on the sweep are sufficient to permit accurate measurements of the on and off times of the transmitted signal.

- Set the center frequency of the instrument to the center frequency of the transmission.
- Set $RBW \geq OBW$ if possible; otherwise, set RBW to the largest available value.
- Set $VBW \geq RBW$.
- Set detector = peak or average.
- The zero-span measurement method shall not be used unless both RBW and VBW are $> 50/T$ and the number of sweep points across duration T exceeds 100. (For example, if VBW and/or RBW are limited to 3 MHz, then the zero-span method of measuring duty cycle shall not be used if $T \leq 16.7$ microseconds.)

6.1.1 Test results

Ambient temperature	22 °C
Relative humidity	52 %

Date	10.07.2018
Tested by	B. ROHDE

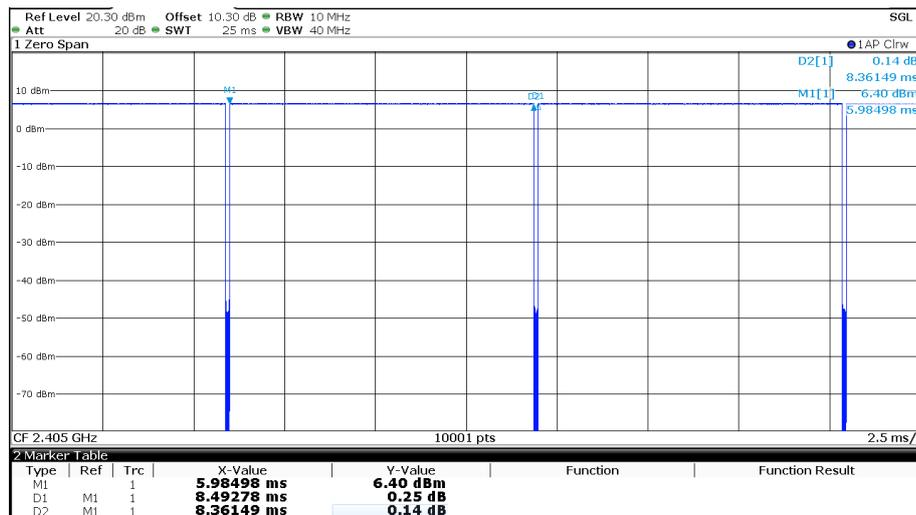

Operation mode	TX_on [µs]	TX_ges [µs]	RBW [MHz]	50/T [kHz]	50/T < RBW?
1	8361	8493	10	6	Yes

Operation mode	Sweep points	Sweep time [µs]	Meas points	Meas points >100?	Duty cycle %	DCCF [dB]
1	10001	25000	3398	Yes	98.4	0.07

The DCCF (duty cycle correction factor) is calculated by:

$$DCCF = 10 * \log_{10} \left(\frac{1}{Duty\ cycle} \right)$$

The duty cycle is greater than 98%, therefore, for average measurements no correction factor is used.

Test equipment (please refer to chapter 6 for details)
1

6.2 Maximum peak output power

6.2.1 Method of measurement (conducted)

The EUT was measured conducted at the antenna ports with the aid of a spectrum analyzer.



Acceptable measurement configurations

Procedure 11.9.1.1 in [1] was used for the following test.

The following procedure shall be used when an instrument with a resolution bandwidth that is greater than the DTS bandwidth is available to perform the measurement:

- Set the $RBW \geq DTS$ bandwidth.
- Set $VBW \geq [3 \times RBW]$.
- Set $span \geq [3 \times RBW]$.
- Sweep time = auto couple.
- Detector = peak.
- Trace mode = max hold.
- Allow trace to fully stabilize.
- Use peak marker function to determine the peak amplitude level.

The measurement was performed at the upper and lower end and the middle of the assigned frequency band.

6.2.1.1 Test results (conducted)

6.2.1.1.1 Tested sample PT4-B301#3 (conducted)

Ambient temperature	22 °C
Relative humidity	56 %

Date	25.05.2018
Tested by	B. ROHDE

Maximum peak output power (Operation mode 1):

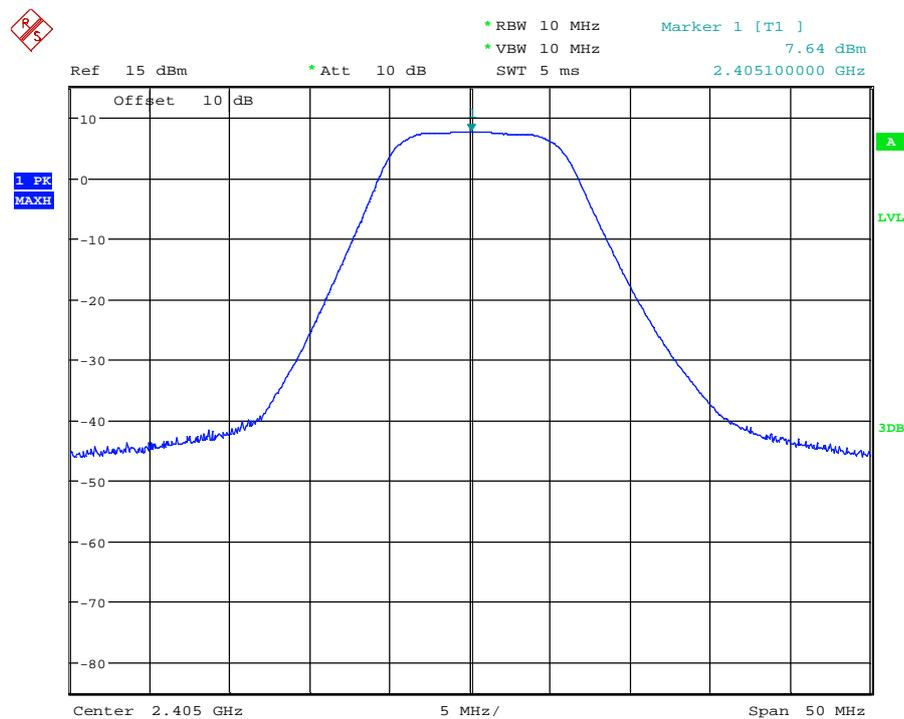

Operation mode	Data rate	Frequency [MHz]	Result [dBm]	Limit [dBm]
1	250 kbit/s	2405	7.64	30
2	250 kbit/s	2440	7.41	30
3	250 kbit/s	2475	7.14	30

Test equipment (please refer to chapter 6 for details)

2

6.2.2 Method of measurement (radiated)

Procedure 11.9.1.1 in [1] was used for the following test.

The following procedure shall be used when an instrument with a resolution bandwidth that is greater than the DTS bandwidth is available to perform the measurement:

- a) Set the RBW \geq DTS bandwidth.
- b) Set VBW \geq [3 \times RBW].
- c) Set span \geq [3 \times RBW].
- d) Sweep time = auto couple.
- e) Detector = peak.
- f) Trace mode = max hold.
- g) Allow trace to fully stabilize.
- h) Use peak marker function to determine the peak amplitude level.

The measurement was performed at the upper and lower end and the middle of the assigned frequency band.

The measured Electric field strength was corrected with the following correction factor:

Antenna Factor [dB/m] + Cable Attenuation [dB] - Amplifier Gain [dB] = correction factor [dB/m]

The formula in 11.12.2.2 e) in [1] was used to calculate the EIRP power:

$$E = EIRP - 20\log(d) + 104.8$$

$$EIRP = E - 95.3$$

$$MPOP = EIRP - G$$

E is the electric field strength in dB μ V/m

EIRP is the equivalent isotropically radiated power in dBm

d is the specified measurement distance in m

G is the antenna gain in dBi

MPOP is the maximum peak output power – measured antenna port conducted – in dBm

6.2.2.1 Test results (radiated)

6.2.2.1.1 Tested sample PT2-B312#8 (radiated)

Ambient temperature	22° C
Relative humidity	40 %

Date	30.06.2018
Tested by	B. ROHDE

Maximum peak output power (operation mode 1)



Antenna gain of used antenna according to the data sheet: 3 dBi

Operation mode	Data rate	Frequency [MHz]	Reading [dBmV]	Corr. Fact. [dB/m]	Field strength @3m [dBmV/m]	EIRP [dBm]	Result (conducted) [dBm]	Limit [dBm]
1	250 kbit/s	2405	72.4	34.1	106.5	11.4	8.4	30.00
2	250 kbit/s	2440	71.0	34.2	105.2	10.0	7.0	30.00
3	250 kbit/s	2475	70.5	34.2	104.7	9.5	6.5	30.00

Test equipment (please refer to chapter 6 for details)
3-11

6.3 DTS Bandwidth / 99% Bandwidth

6.3.1 Method of measurement (conducted)

The EUT was tested with a spectrum analyzer connected directly to the EUT.

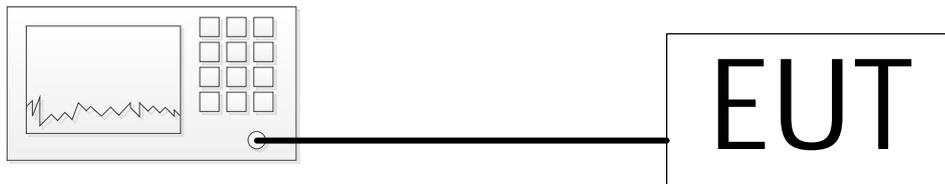

DTS bandwidth:

The measurement procedure refers to part 11.8.1 of document [1].

- Set RBW = 100 kHz.
- Set the video bandwidth (VBW) $\geq 3 \times$ RBW.
- Detector = Peak.
- Trace mode = max hold.
- Sweep = auto couple.
- Allow the trace to stabilize.
- Measure the maximum width of the emission that is constrained by the frequencies associated with the two outermost amplitude points (upper and lower frequencies) that are attenuated by 6 dB relative to the maximum level measured in the fundamental emission.

The following procedure was used for measuring the 99 % bandwidth:

The occupied bandwidth is the frequency bandwidth such that, below its lower and above its upper frequency limits, the mean powers are each equal to 0.5% of the total mean power of the given emission. The following procedure shall be used for measuring 99% power bandwidth:

- The instrument center frequency is set to the nominal EUT channel center frequency. The frequency span for the spectrum analyzer shall be between 1.5 times and 5.0 times the OBW.
- The nominal IF filter bandwidth (3 dB RBW) shall be in the range of 1% to 5% of the OBW, and VBW shall be approximately three times the RBW, unless otherwise specified by the applicable requirement.
- Set the reference level of the instrument as required, keeping the signal from exceeding the maximum input mixer level for linear operation. In general, the peak of the spectral envelope shall be more than $[10 \log(\text{OBW}/\text{RBW})]$ below the reference level. Specific guidance is given in 4.1.5.2.
- Step a) through step c) might require iteration to adjust within the specified range.
- e) Video averaging is not permitted. Where practical, a sample detection and single sweep mode shall be used. Otherwise, peak detection and max hold mode (until the trace stabilizes) shall be used.
- f) Use the 99% power bandwidth function of the instrument (if available) and report the measured bandwidth.
- g) If the instrument does not have a 99% power bandwidth function, then the trace data points are recovered and directly summed in linear power terms. The recovered amplitude data points, beginning at the lowest frequency, are placed in a running sum until 0.5% of the total is reached; that frequency is recorded as the lower frequency. The process is repeated until 99.5% of the total is reached; that frequency is recorded as the upper frequency. The 99% power bandwidth is the difference between these two frequencies.
- The occupied bandwidth shall be reported by providing plot(s) of the measuring instrument display; the plot axes and the scale units per division shall be clearly labeled. Tabular data maybe reported in addition to the plot(s).

6.3.1.1 Test results (conducted)
6.3.1.1.1 Tested sample PT4-B301#3 (conducted)

Ambient temperature	22 °C
Relative humidity	45 %

Date	25.05.2018
Tested by	B. ROHDE

DTS bandwidth (Operation mode 2):

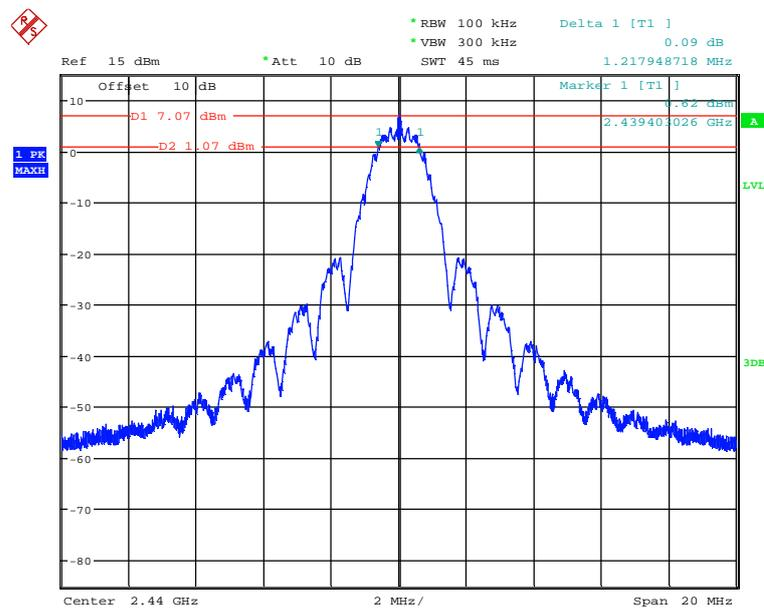

99% bandwidth (Operation mode 3):

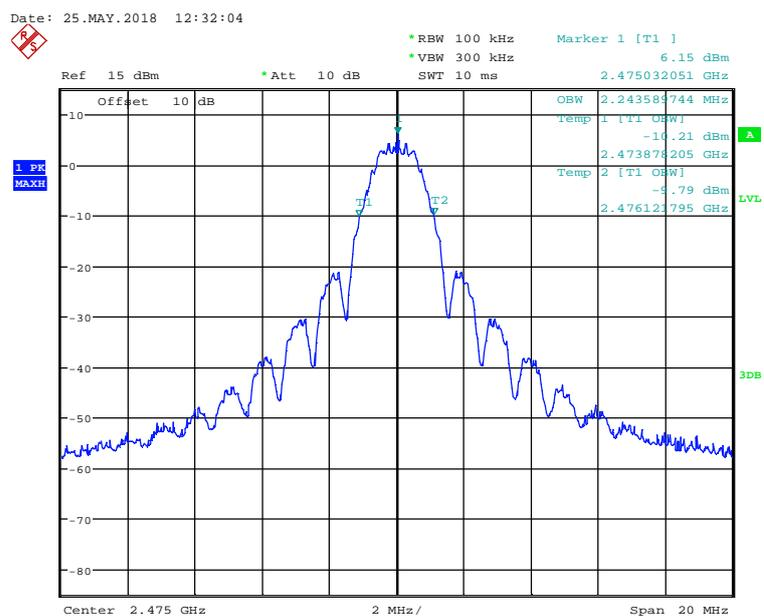

Date: 25.MAY.2018 13:57:41

OP mode	Data rate	Center Frequency [MHz]	Minimum 6-dB Bandwidth Limit [MHz]	6 dB Bandwidth [MHz]	99 % Bandwidth [MHz]	Result
1	250 kbit/s	2405	0.5	1.25	2.212	Passed
2	250 kbit/s	2440	0.5	1.22	2.212	Passed
3	250 kbit/s	2475	0.5	1.25	2.244	Passed

Test equipment (please refer to chapter 6 for details)

2

6.3.2 Method of measurement (radiated)

For the DTS bandwidth measurement, the EUT was measured radiated in the anechoic chamber using the procedures described in 6.6.4.

DTS bandwidth:

The measurement for the DTS bandwidth procedure refers to part 11.8.2 of document [1].

The automatic bandwidth measurement capability of an instrument may be employed using the X dB bandwidth mode with X set to 6 dB, if the functionality described in 11.8.1 (i.e., $RBW = 100 \text{ kHz}$, $VBW \geq 3 \times RBW$, and peak detector with maximum hold) is implemented by the instrumentation function. When using this capability, care shall be taken so that the bandwidth measurement is not influenced by any intermediate power nulls in the fundamental emission that might be $\geq 6 \text{ dB}$.

The following procedure was used for measuring the 99 % bandwidth:

The occupied bandwidth is the frequency bandwidth such that, below its lower and above its upper frequency limits, the mean powers are each equal to 0.5% of the total mean power of the given emission. The following procedure shall be used for measuring 99% power bandwidth:

- The instrument center frequency is set to the nominal EUT channel center frequency. The frequency span for the spectrum analyzer shall be between 1.5 times and 5.0 times the OBW.
- The nominal IF filter bandwidth (3 dB RBW) shall be in the range of 1% to 5% of the OBW, and VBW shall be approximately three times the RBW, unless otherwise specified by the applicable requirement.
- Set the reference level of the instrument as required, keeping the signal from exceeding the maximum input mixer level for linear operation. In general, the peak of the spectral envelope shall be more than $[10 \log (OBW/RBW)]$ below the reference level. Specific guidance is given in 4.1.5.2.
- Step a) through step c) might require iteration to adjust within the specified range.
- e) Video averaging is not permitted. Where practical, a sample detection and single sweep mode shall be used. Otherwise, peak detection and max hold mode (until the trace stabilizes) shall be used.
- f) Use the 99% power bandwidth function of the instrument (if available) and report the measured bandwidth.
- g) If the instrument does not have a 99% power bandwidth function, then the trace data points are recovered and directly summed in linear power terms. The recovered amplitude data points, beginning at the lowest frequency, are placed in a running sum until 0.5% of the total is reached; that frequency is recorded as the lower frequency. The process is repeated until 99.5% of the total is reached; that frequency is recorded as the upper frequency. The 99% power bandwidth is the difference between these two frequencies.
- The occupied bandwidth shall be reported by providing plot(s) of the measuring instrument display; the plot axes and the scale units per division shall be clearly labelled. Tabular data maybe reported in addition to the plot(s).

Since this is only a relative measurement, no measurement level correction was performed.

6.3.2.1.1 Test results (radiated)

6.3.2.1.2 Tested sample PT2-B312#8 (radiated)

Ambient temperature	22 °C
Relative humidity	40 %

Date	30.06.2018
Tested by	B. ROHDE

DTS bandwidth (Operation mode 1):



99% bandwidth (Operation mode 2):



OP mode	Data rate	Center Frequency [MHz]	Minimum 6-dB Bandwidth Limit [MHz]	6 dB Bandwidth [MHz]	99 % Bandwidth [MHz]	Result
1	250 kbit/s	2405	0.5	1.14	2.275	Passed
2	250 kbit/s	2440	0.5	1.16	2.279	Passed
3	250 kbit/s	2475	0.5	1.16	2.268	Passed

Test equipment (please refer to chapter 6 for details)

3 - 11

6.4 Peak Power Spectral Density

6.4.1 Method of measurement (conducted)

The EUT was tested with a spectrum analyzer connected directly to the EUT.



The measurement procedure refers to part 11.10.2 of document [1].

- Set analyzer center frequency to DTS channel center frequency.
- Set the span to 1.5 times the DTS bandwidth.
- Set the RBW to $3 \text{ kHz} \leq \text{RBW} \leq 100 \text{ kHz}$.
- Set the VBW $\geq [3 \times \text{RBW}]$.
- Detector = peak.
- Sweep time = auto couple.
- Trace mode = max hold.
- Allow trace to fully stabilize.
- Use the peak marker function to determine the maximum amplitude level within the RBW.
- If measured value exceeds requirement, then reduce RBW (but no less than 3 kHz) and repeat.

6.4.1.1 Test results (conducted)

6.4.1.1.1 Tested sample PT4-B301#3 (conducted)

Ambient temperature	22 °C
Relative humidity	54 %

Date	25.05.2018
Tested by	B. ROHDE

PSD (Operation mode 1):

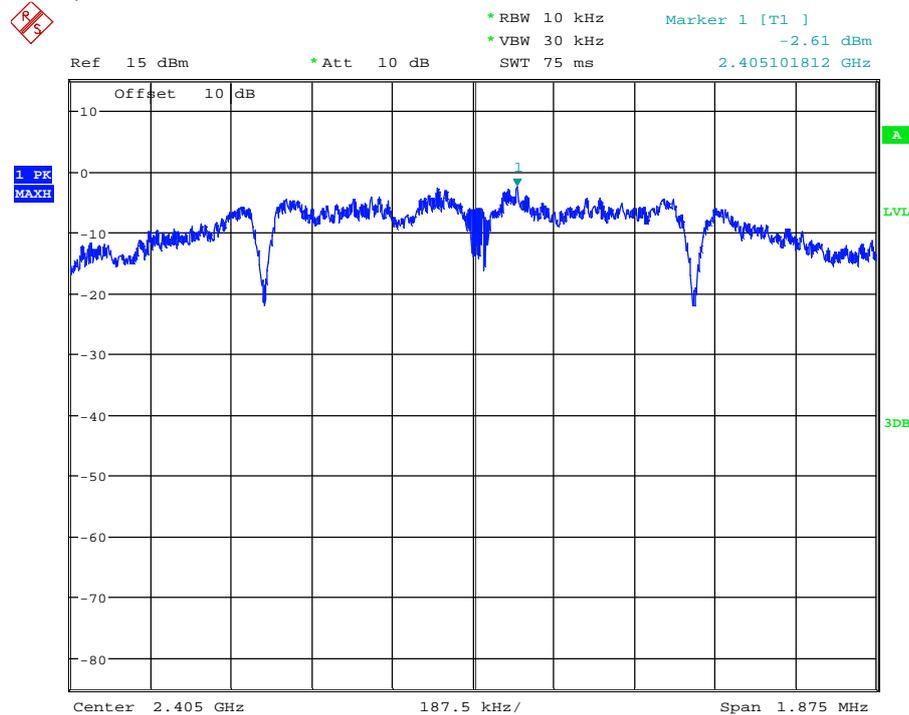

OP mode	Data rate	Peak Frequency [MHz]	Result [dBm / 10 kHz]	PSD Limit [dBm / 3 kHz]	Result
1	250 kbit/s	2405.102	-2.61	8	Passed
2	250 kbit/s	2439.953	-3.50	8	Passed
3	250 kbit/s	2475.098	-3.30	8	Passed

Test equipment (please refer to chapter 6 for details)

2

6.4.2 Method of measurement (radiated)

For the PSD measurement, the EUT was measured radiated in the anechoic chamber using the procedures described in 6.6.4.

The measurement procedure refers to part 11.10.2 of document [1].

- Set analyzer center frequency to DTS channel center frequency.
- Set the span to 1.5 times the DTS bandwidth.
- Set the RBW to $3 \text{ kHz} \leq \text{RBW} \leq 100 \text{ kHz}$.
- Set the VBW $\geq [3 \times \text{RBW}]$.
- Detector = peak.
- Sweep time = auto couple.
- Trace mode = max hold.
- Allow trace to fully stabilize.
- Use the peak marker function to determine the maximum amplitude level within the RBW.
- If measured value exceeds requirement, then reduce RBW (but no less than 3 kHz) and repeat.

6.4.2.1 Test results (radiated)

6.4.2.1.1 Tested sample PT2-B312#8 (radiated)

Ambient temperature	22 °C
Relative humidity	45 %

Date	30.06.2018
Tested by	B. ROHDE

PSD (operation mode 1)

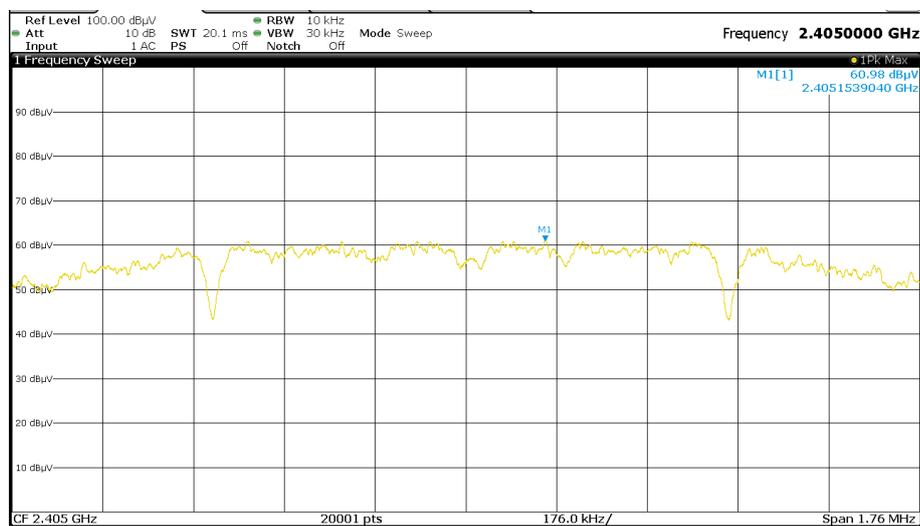

OP mode	Data rate	Peak Frequency [MHz]	Reading [dBmV]	Corr. Fact. [dB/m]	Field strength @3m [dBmV/m]	EIRP [dBm / 10 kHz]	Result [dBm / 10 kHz]	PSD Limit [dBm / 3 kHz]	Result
1	250 kbit/s	2405.154	61.0	34.1	95.1	-0.1	-3.1	8	Passed
2	250 kbit/s	2439.909	60.5	34.2	94.7	-0.5	-3.5	8	Passed
3	250 kbit/s	2475.082	59.6	34.2	93.8	-1.4	-4.4	8	Passed

Test equipment (please refer to chapter 6 for details)

3 - 11

6.5 Band-edge compliance

6.5.1 Method of measurement (band edges next to unrestricted bands (conducted))

The EUT was tested with a spectrum analyzer connected directly to the EUT.

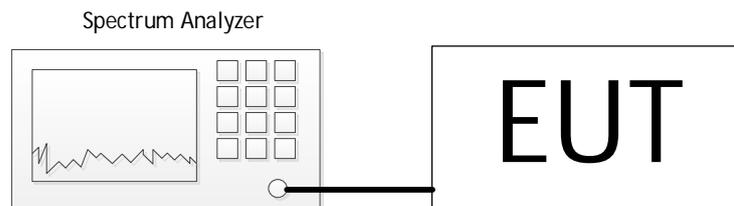

The relating measurements were carried out in a conducting manner. Therefore, the antenna connector was directly connected to a spectrum analyzer. The measurement procedure refers to part 11.11.2 and 11.11.3 of document [1].

Measurement Procedure Reference – Reference Level:

- Set the span to ≥ 1.5 times the DTS Bandwidth.
- RBW = 100 kHz.
- VBW ≥ 300 kHz.
- Detector = Peak.
- Sweep time = auto couple.
- Trace mode = max hold.
- Allow trace to fully stabilize.
- Use the peak marker function to determine the maximum amplitude level.

Measurement Procedure – Unwanted Emissions

- Set the center frequency and span to encompass the frequency range to be measured.
- RBW = 100 kHz.
- VBW ≥ 300 kHz.
- Detector = Peak.
- Ensure that the number of measurement points $\geq \text{span}/\text{RBW}$.
- Sweep time = auto couple.
- Trace Mode = max hold.
- Allow the trace to stabilize.
- Use the peak marker function to determine the maximum amplitude level.

The measurement procedure at the band edges was simplified by performing the measurement in just one plot. Both, the in-band-emission and the unwanted emission were be encompassed by the span. After trace stabilization, the maximum peak was be determined by a peak detector and the value was marked by an appropriate limit line. The second limit line, which is 20 dB below the first, marks the limit for the emissions in the unrestricted band. A maximum-peak-detector marks the highest emission in the unrestricted band next to the band edge.

6.5.1.1 Test results (conducted)
6.5.1.1.1 Tested sample PT4-B301#3 (conducted)

Ambient temperature	22 °C
Relative humidity	45 %

Date	25.05.2018
Tested by	B. ROHDE

Unrestricted band edge (Operation mode 1):

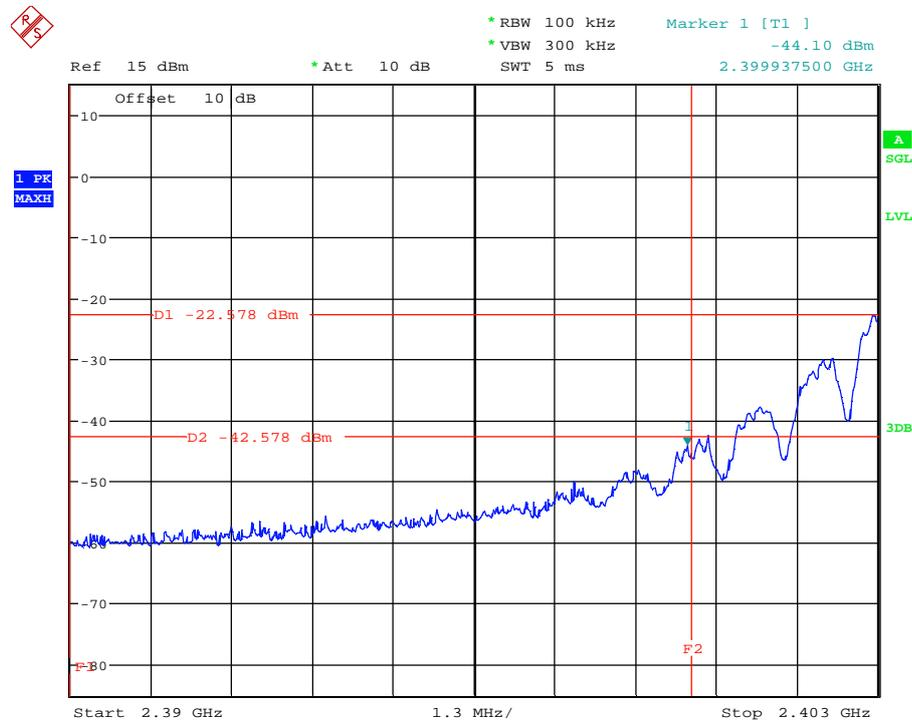

Date: 25.MAY.2018 13:05:55

Operation mode	Data rate	Frequency [MHz]	Reference Level [dBm]	Limit [dBm]	Emission Level [dBm]	Margin [dB]	Result
1	250 kbit/s	2399.937	-22.6	-42.6	-43.8	1.2	Passed

Test equipment (please refer to chapter 6 for details)
2

6.5.2 Method of measurement (band edges next to unrestricted bands (radiated))

For the measurement, the EUT was measured radiated in the anechoic chamber using the procedures described in 6.6.4.

The relating measurements were carried out in a conducting manner. Therefore, the antenna connector was directly connected to a spectrum analyzer. The measurement procedure refers to part 11.11.2 and 11.11.3 of document [1].

Measurement Procedure Reference – Reference Level:

- RBW = 100 kHz.
- VBW \geq 300 kHz.
- Set the span to \geq 1.5 times the DTS Bandwidth.
- Detector = Peak.
- Sweep time = auto couple.
- Trace mode = max hold.
- Allow trace to fully stabilize.
- Use the peak marker function to determine the maximum amplitude level.

Measurement Procedure – Unwanted Emissions

- Set the center frequency and span to encompass the frequency range to be measured.
- RBW = 100 kHz.
- VBW \geq 300 kHz.
- Detector = Peak.
- Ensure that the number of measurement points \geq span/RBW.
- Sweep time = auto couple.
- Trace Mode = max hold.
- Allow the trace to stabilize.
- Use the peak marker function to determine the maximum amplitude level.

The measurement procedure at the band edges was simplified by performing the measurement in just one plot. Both, the in-band-emission and the unwanted emission were be encompassed by the span. After trace stabilization, the maximum peak was be determined by a peak detector and the value was marked by a marker. A second maximum-peak-detector marker marks the highest emission in the unrestricted band next to the band edge. The measurements were performed at the lower end of the 2.4 GHz band.

6.5.2.1 Test results (radiated)

6.5.2.1.1 Tested sample PT2-B312#8 (radiated)

Ambient temperature	22 °C
Relative humidity	52 %

Date	30.06.2018
Tested by	B. ROHDE

Unrestricted band edge (Operation mode 1):

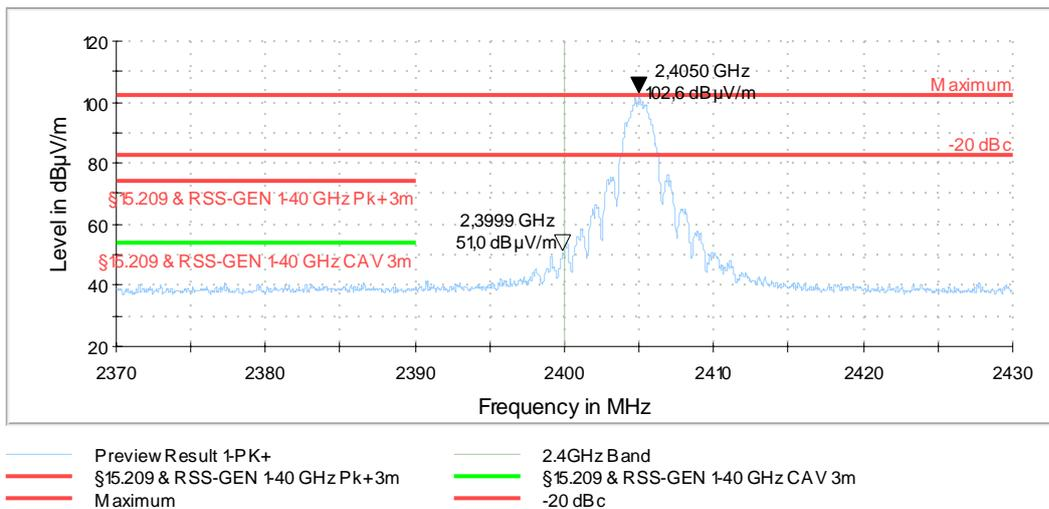

Operation Mode	Tx Frequency [MHz]	Emission Frequency [MHz]	Reference Level [dBµV]	Limit [dBm]	Emission Level [dBµV]	Margin [dB]	Result
1	2405	2399.00	102.6	82.6	51.0	31.6	Passed

Test equipment (please refer to chapter 6 for details)
3 - 11

6.5.3 Method of measurement (band edges next to restricted bands (conducted))

The EUT was tested with a spectrum analyzer connected directly to the EUT.

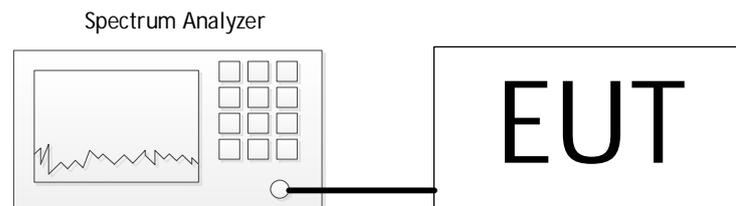

The same test set-up as used for the final conducted emission measurement shall be used (refer also sub-clause 6.6.1 of this test report).

After trace stabilization the marker shall be set on the signal peak. The frequency line shall be set on the edge of the assigned frequency band. Now set the second marker on the emission at the band-edge, or on the highest modulation product outside of the band, if this level is higher than that at the band-edge. The level of the measured field strength shall be compared to the general limits specified in § 15.205.

The measurement was performed at the lower and the upper end of the 2.4 GHz band.

The calculation was performed with the following formula as described in chapter 11.12.2.2 e) in [1]:

$$E [\text{dBmV/m}] = EIRP [\text{dBm}] - 20\log(d) + 104.8 + G_{\text{Ant}} [\text{dBi}] + G_{\text{Array}} [\text{dB}] + Att_{\text{MeasCable}} [\text{dB}] + Att_{\text{RF-Switch}} [\text{dB}]$$

$E [\text{dBmV/m}]$ = Field Strength [dBuV/m]

$EIRP [\text{dBm}]$ = Reading [dBm]

d = measurement distance in m

$G_{\text{Ant}} [\text{dBi}]$ = Gain of the EUT antenna

$G_{\text{Array}} [\text{dB}]$ = Array Gain [in case of multiple transmitting antenna port]

$Att_{\text{MeasCable}} [\text{dB}]$ = Attenuation of the measurement cables

$Att_{\text{RF-Switch}} [\text{dB}]$ = Attenuation of the RF Switch

6.5.3.1 Test results (conducted)

6.5.3.1.1 Tested sample PT4-B301#3 (conducted)

Ambient temperature	22 °C
Relative humidity	45 %

Date	25.05.2018
Tested by	B. ROHDE

Restricted band edge (Operation mode 3):

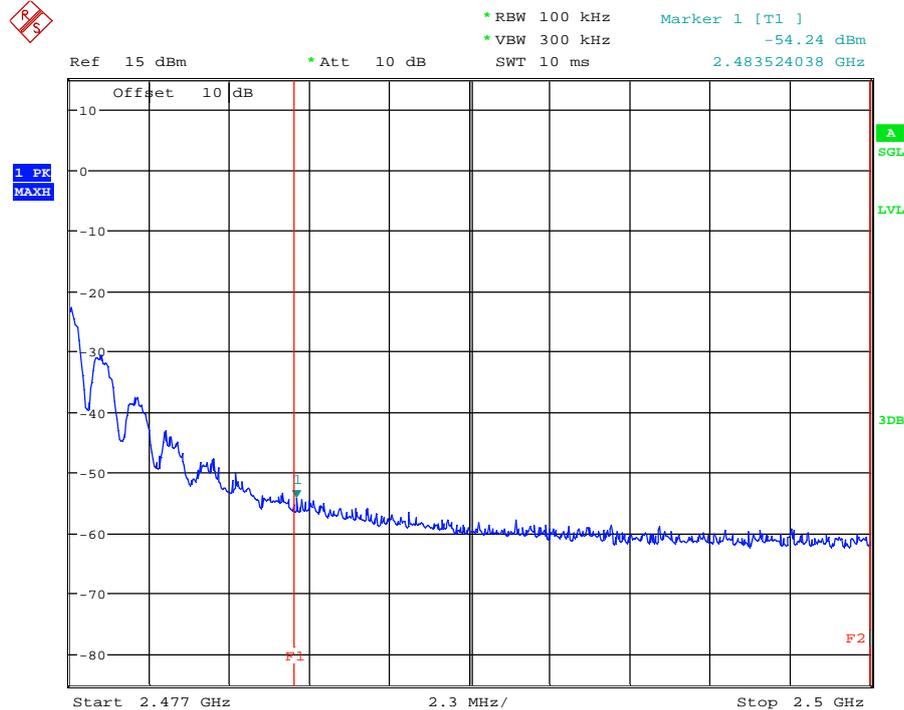

Upper band edge							
Operation Mode	Frequency [MHz]	Field Strength [dBuV/m]	Peak Limit [dBuV/m]	Margin [dB]	Reading [dBm]	Antenna Gain + Array Gain [dBi]	Result
3	2484.325	54.5	74	19.5	-43.8	3	Passed
Operation Mode	Frequency [MHz]	Field Strength [dBuV/m]	Average Limit [dBuV/m]	Margin [dB]	Reading [dBm]	Antenna Gain + Array Gain [dBi]	Result
3	2483.5	43.2	54	10.8	-55.1	3	Passed
Measurement uncertainty					+0.66 dB / -0.72 dB		

Test equipment (please refer to chapter 6 for details)
2

6.5.4 Method of measurement (band edges next to restricted bands (radiated))

For the measurement, the EUT was measured radiated in the anechoic chamber using the procedures described in 6.6.4.

The relating measurements were carried radiated. The measurement procedure refers to part 6.10.5.2 of document [1].

6.5.4.1 Test results (radiated)

Ambient temperature	22 °C
Relative humidity	52 %

Date	30.06.2018
Tested by	B. ROHDE

Restricted band edge (Operation mode 1):

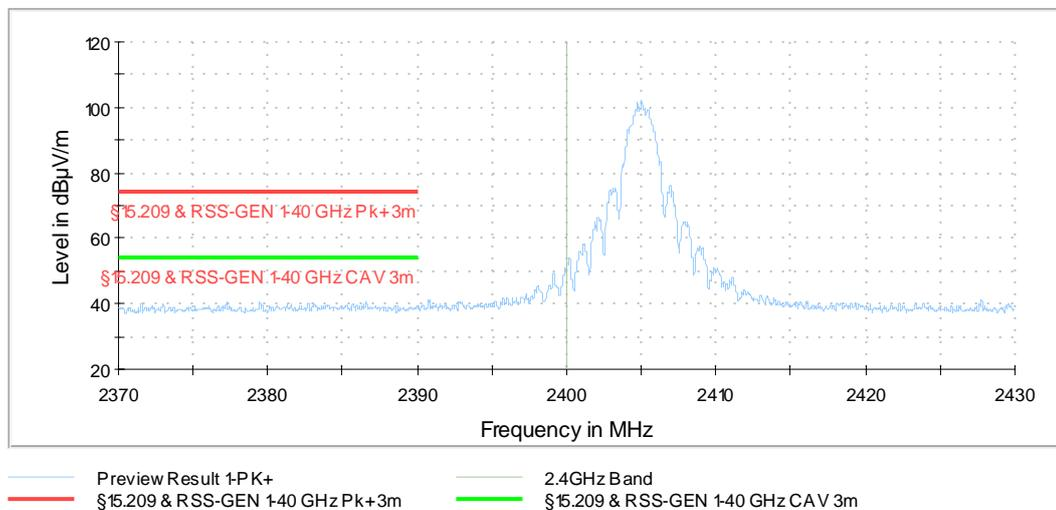

Lower band edge									
Operation mode 1			Duty cycle correction factor of 0.48 dB was applied for the Average reading						
Frequency	Max Peak	Average	Limit	Margin	Pol	Azimuth	Elevation	Correction	Result
[MHz]	[dBµV/m]	[dBµV/m]	[dBµV/m]	dB		[°]	[°]	[dB]	
2386.560000	---	31.3	54	22.7	H	55	30	33.3	Passed
2386.560000	43.5	---	74	30.5	H	55	30	33.3	Passed
Measurement uncertainty				+2.2 dB / -3.6 dB					

Restricted band edge (Operation mode 3):

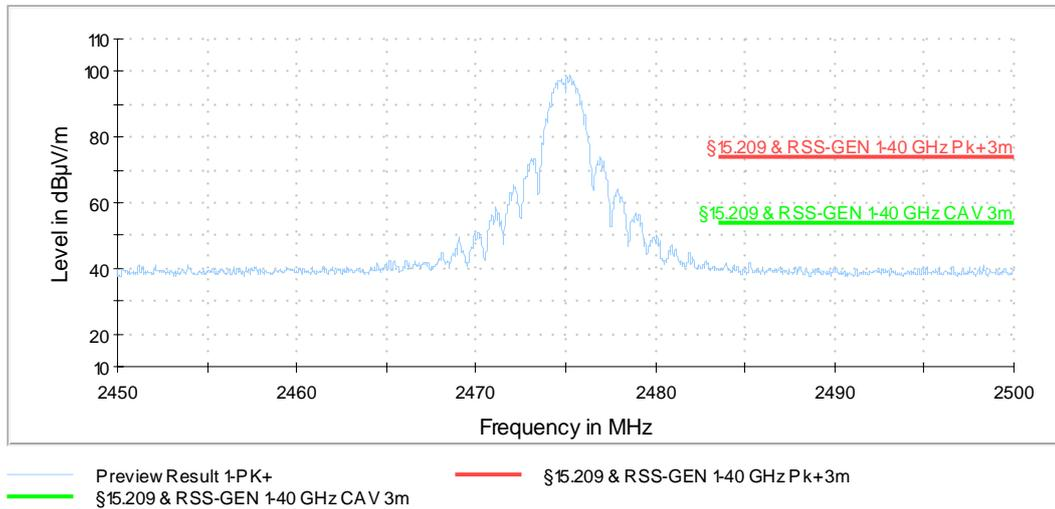

Upper band edge									
Operation mode 3			Duty cycle correction factor of 0.48 dB was applied for the Average reading						
Frequency	Max Peak	Average	Limit	Margin	Pol	Azimuth	Elevation	Correction	Result
[MHz]	[dBµV/m]	[dBµV/m]	[dBµV/m]	dB		[°]	[°]	[dB]	
2485.250000	---	36.5	54	17.5	V	149	120	33.6	Passed
2485.250000	48.7	---	74	25.3	V	149	120	33.6	Passed
Measurement uncertainty				+2.2 dB / -3.6 dB					

Test equipment (please refer to chapter 6 for details)

3 - 11

6.6 Maximum unwanted emissions

6.6.1 Method of measurement (conducted emissions in the restricted bands)

The relating measurements were carried out in a conducting manner. Therefore, the antenna connector was directly mounted to a spectrum analyzer.

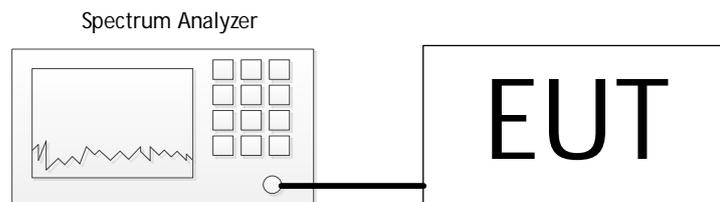

The measurement procedure refers to part 11.12.2.2 in document [1].

If emissions were detected during the preliminary measurements, they were measured using the following measurement procedures:

Procedure for average measurement: 11.12.2.5.2 – Trace averaging across ON and OFF times of the EUT transmissions followed by duty cycle correction:

If continuous transmission of the EUT ($D \geq 98\%$) cannot be achieved and the duty cycle is constant (duty cycle variations are less than $\pm 2\%$), then the following procedure shall be used:

- The EUT shall be configured to operate at the maximum achievable duty cycle.
- Measure the duty cycle D of the transmitter output signal as described in 11.6 in [1].
- Set the RBW = 1 MHz (unless otherwise specified).
- Set the VBW $\geq 3 \times$ RBW.
- Detector = power average (RMS).
- Ensure that the number of measurement points in the sweep to $\geq 2 \times$ (span/RBW).
- Averaging type = power
- Sweep time = auto
- Perform a trace average of at least 100 traces
- Correct the resulting measurement value by adding the duty cycle correction value if applicable.

Peak measurement procedure: 11.12.2.4 in [1]

- Set the analyzer span to encompass the entire unwanted emission bandwidth.
- Set the RBW = specified in Table 1.
- Set the VBW \geq RBW.
- Set sweep time = auto.
- Detector = peak.
- Trace mode = max hold.
- Allow the trace to stabilize.
- Use the peak marker function to determine the peak power over the emission bandwidth.

Table 1 RBW as a function of frequency

Frequency	RBW
9-150 kHz	200-300 Hz
0.15-30 MHz	9-10 kHz
30-1000 MHz	100-120 kHz
> 1000 MHz	1 MHz

6.6.1.1 Limit calculations

The following general procedure is described in chapter 11.12.2.2 in [1].

- Measure the conducted output power (in dBm) using the detector specified by the appropriate regulatory agency (see 11.12.2.3 through 11.12.2.5 for guidance regarding measurement procedures for determining quasi-peak, peak, and average conducted output power, respectively).
- Add the maximum transmit antenna gain (in dBi) to the measured output power level to determine the EIRP (see 11.12.2.6 for guidance on determining the applicable antenna gain).
- Add the appropriate maximum ground reflection factor to the EIRP (6 dB for frequencies ≤ 30 MHz; 4.7 dB for frequencies between 30 MHz and 1000 MHz, inclusive; and 0 dB for frequencies > 1000 MHz).
- For MIMO devices, measure the power of each chain and sum the EIRP of all chains in linear terms (i.e., watts and mW).
- Convert the resultant EIRP to an equivalent electric field strength using the following relationship:

$$E. = EIRP - 20\log(d) + 104.8 \quad (1)$$

where

E is the electric field strength in dB μ V/m

EIRP is the equivalent isotropically radiated power in dBm

d is the specified measurement distance in m

- Compare the resultant electric field strength level with the applicable regulatory limit.
- Perform the radiated spurious emission test.

Chapter 14 in [1] states that for transmitters with multiple outputs in the same band, summing of emissions and accounting for array gain have to be considered.

For the case that both antenna ports transmit continuously, both results were summed as linear values as described in 14.3.2.2 in document [1].

To account for directional gain which might occur in case of N transmit antennas in the test mode spatial multiplexing, which is the mode the EUT uses, the directional has to be calculated as:

$$10\log \left[\sum_{j=1}^{N_{SS}} \left\{ \sum_{k=1}^{N_{Ant}} g_{j,k} \right\}^2 / N_{Ant} \right]$$

Whereby

N_{SS} is the number of independent spatial streams of data.

N_{Ant} is the total number of antennas

$g_{j,k}$ is $10^{G_k/20}$ if the k th antenna is being fed by spatial stream j , or zero if it is not

G_k is the gain in dBi of the k th antenna

Since the EUT has only 1 antenna, no array gain is applicable here.

6.6.2 Method of measurement (conducted emissions in the unrestricted bands)

In any 100 kHz outside the authorized frequency band, the power shall be attenuated by 20 dB, compared to the highest in band power in any 100 kHz. This shall be demonstrated by using the peak power procedure. The reference level shall be measured using the procedure described in 6.6.2.1 and the emission level according to procedure 6.6.2.2. The procedures are based on chapter 11.11.2 and 11.11.3 in [1].

For the operation modes in which both antenna ports transmit simultaneously, the level of the both ports were summed in linear value for each frequency step. The applicable plots show the result of that sum.

6.6.2.1 Reference level measurement

- a) Set instrument center frequency to DTS channel center frequency.
- b) Set the span to ≥ 1.5 times the DTS bandwidth.
- c) Set the RBW = 100 kHz.
- d) Set the VBW $\geq 3 \times$ RBW.
- e) Detector = peak.
- f) Sweep time = auto couple.
- g) Trace mode = max hold.
- h) Allow trace to fully stabilize.
- i) Use the peak marker function to determine the maximum PSD level.

6.6.2.2 Emission level measurement

- a) Set the center frequency and span to encompass frequency range to be measured.
- b) Set the RBW = 100 kHz.
- c) Set the VBW $\geq 3 \times$ RBW.
- d) Detector = peak.
- e) Ensure that the number of measurement points \geq span/RBW
- f) Sweep time = auto couple.
- g) Trace mode = max hold.
- h) Allow trace to fully stabilize.
- i) Use the peak marker function to determine the maximum amplitude level.

6.6.3 Test results (conducted emissions)

6.6.3.1 Tested sample PT4-B301#3 (conducted)

6.6.3.1.1 Emissions below 1 GHz

Ambient temperature	22 °C
Relative humidity	52 %

Date	25.05.2018
Tested by	B. ROHDE

Unwanted emission (All Operation modes):

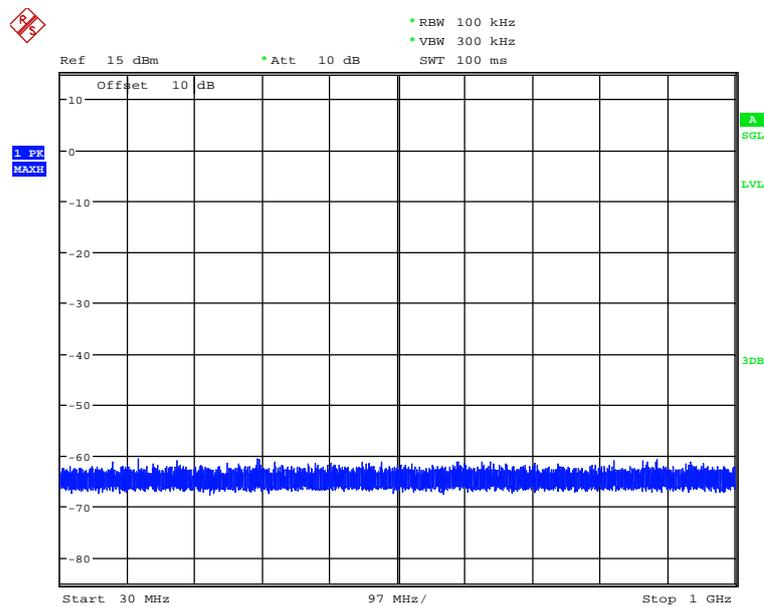

No significant emissions were found below 1 GHz, therefore no result tables for this frequency range are submitted below.

6.6.3.1.2 Emissions above 1 GHz

Ambient temperature	22 °C
Relative humidity	52 %

Date	25.05.2018
Tested by	B. ROHDE

The following results were measured at antenna port of the EUT. Only the plots for the worst case emissions are submitted below.

Conducted spurious from 1 – 4 GHz (Operation mode 1):

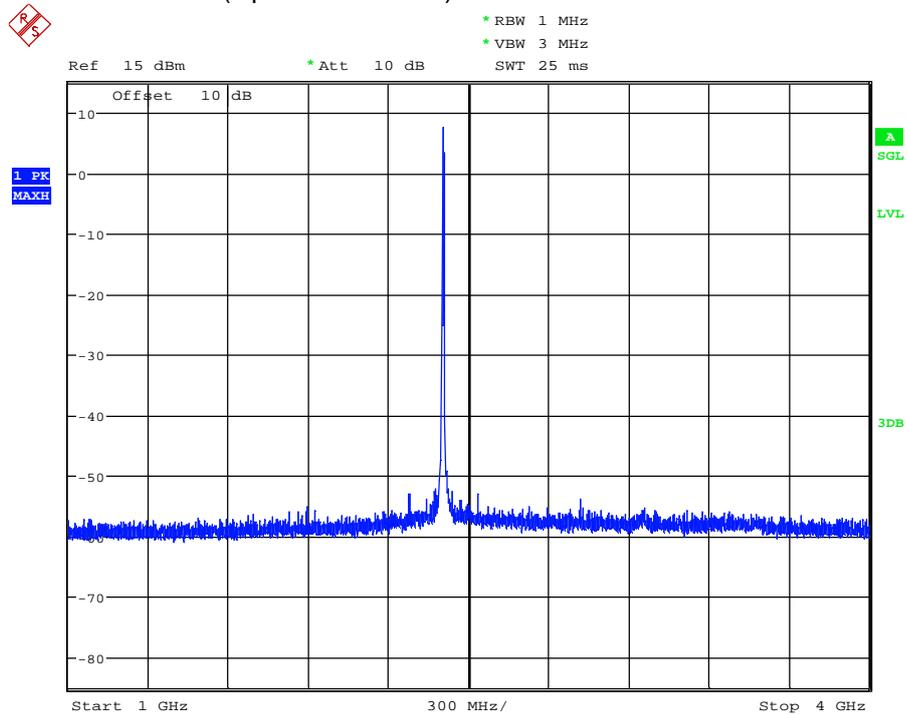

Date: 25.MAY.2018 13:06:29

Spurious Emissions (Operation mode 1)							
Peak Emission – Restricted Band							
Operation Mode	Frequency [MHz]	Field Strength [dBuV/m]	Peak Limit [dBuV/m]	Margin [dB]	Reading [dBm]	Antenna Gain + Array Gain [dBi]	Result
1	4808.86	47.7	74	26.3	-50.5	3	Passed
1	12027.61	49.1	74	24.9	-49.1	3	Passed
Average Emission – Restricted Band							
Operation Mode	Frequency [MHz]	Field Strength [dBuV/m]	Average Limit [dBuV/m]	Margin [dB]	Reading [dBm]	Antenna Gain + Array Gain [dBi]	Result
1	4809.07	39.8	54	14.2	-58.5	3	Passed
1	12022.68	41.2	54	12.8	-57.2	3	Passed
Emissions in the non-restricted Bands							
Operation Mode	Frequency [MHz]	Reading [dBm]	Limit [dBm]	Margin [dB]	Result		
1	2404.73	4.7	-	-	-		
1	7213.58	-58.5	-15.3	43.2	Passed		
1	9620.05	-50.8	-15.3	35.6	Passed		
1	14427.46	-59.6	-15.3	44.3	Passed		
Measurement uncertainty				+0.66 dB / -0.72 dB			

Spurious Emissions (Operation mode 2)							
Peak Emission – Restricted Band							
Operation Mode	Frequency [MHz]	Field Strength [dBuV/m]	Peak Limit [dBuV/m]	Margin [dB]	Reading [dBm]	Antenna Gain + Array Gain [dBi]	Result
2	4878.83	46.4	74	27.6	-51.9	3	Passed
2	7318.66	47.1	74	26.9	-51.1	3	Passed
2	12197.5	46.4	74	27.6	-51.9	3	Passed
Average Emission – Restricted Band							
Operation Mode	Frequency [MHz]	Field Strength [dBuV/m]	Average Limit [dBuV/m]	Margin [dB]	Reading [dBm]	Antenna Gain + Array Gain [dBi]	Result
2	4879.03	37.2	54	16.8	-61.1	3	Passed
2	7321.31	38.2	54	15.8	-60.1	3	Passed
2	12197.66	36.9	54	17.1	-61.4	3	Passed
Emissions in the non-restricted Bands							
Operation Mode	Frequency [MHz]	Reading [dBm]	Limit [dBm]	Margin [dB]	Result		
2	2440.02	7.4	-	-	-		
2	9760.03	-48.1	-12.6	35.5	Passed		
3	14642.75	-60.1	-12.6	47.5	Passed		
Measurement uncertainty				+0.66 dB / -0.72 dB			

Spurious Emissions (Operation mode 3)							
Peak Emission – Restricted Band							
Operation Mode	Frequency [MHz]	Field Strength [dBuV/m]	Peak Limit [dBuV/m]	Margin [dB]	Reading [dBm]	Antenna Gain + Array Gain [dBi]	Result
3	4950.77	44.8	74	29.2	-53.5	3	Passed
3	7423.63	49	74	25	-49.3	3	Passed
3	12377.78	45.4	74	28.6	-52.9	3	Passed
Average Emission – Restricted Band							
Operation Mode	Frequency [MHz]	Field Strength [dBuV/m]	Average Limit [dBuV/m]	Margin [dB]	Reading [dBm]	Antenna Gain + Array Gain [dBi]	Result
3	4949.09	34.8	54	19.2	-63.5	3	Passed
3	7426.36	41.2	54	12.8	-57.1	3	Passed
3	12372.59	34.8	54	19.2	-63.5	3	Passed
Emissions in the non-restricted Bands							
Operation Mode	Frequency [MHz]	Reading [dBm]	Limit [dBm]	Margin [dB]	Result		
3	2475.01	7.2	-	-	-		
3	9900.01	-47.6	-12.8	34.8	Passed		
3	14845.99	-58.9	-12.8	46.1	Passed		
Measurement uncertainty				+0.66 dB / -0.72 dB			

Test equipment (please refer to chapter 6 for details)
2

6.6.4 Method of measurement (radiated emissions)

The radiated emission measurement is subdivided into five stages.

- A preliminary measurement carried out in a fully anechoic chamber with a fixed antenna height in the frequency range 9 kHz to 1 GHz.
- A final measurement carried out on an outdoor test side without reflecting ground plane and a fixed antenna height in the frequency range 9 kHz to 30 MHz.
- A final measurement carried out on an open area test side with reflecting ground plane and various antenna height in the frequency range 30 MHz to 1 GHz.
- A preliminary measurement carried out in a fully anechoic chamber with a variable antenna distance and height in the frequency range above 1 GHz.
- A final measurement carried out in a fully anechoic chamber with a fixed antenna height in the frequency range above 1 GHz.

Preliminary measurement (9 kHz to 30 MHz):

In the first stage a preliminary measurement will be performed in a shielded room with a measuring distance of 3 meters. Table top devices will set up on a non-conducting turn device on the height of 1.5m. Floor-standing devices will be placed directly on the turntable/ground plane. The set-up of the Equipment under test will be in accordance to [1].

The frequency range 9 kHz to 30 MHz will be monitored with a spectrum analyzer while the system and its cables will be manipulated to find out the configuration with the maximum emission levels if applicable. The EMI Receiver will be set to MAX Hold mode. The EUT and the measuring antenna will be rotated around their vertical axis to found the maximum emissions.

The resolution bandwidth of the spectrum analyzer will be set to the following values:

Frequency range	Resolution bandwidth
9 kHz to 150 kHz	200 Hz
150 kHz to 30 MHz	10 kHz

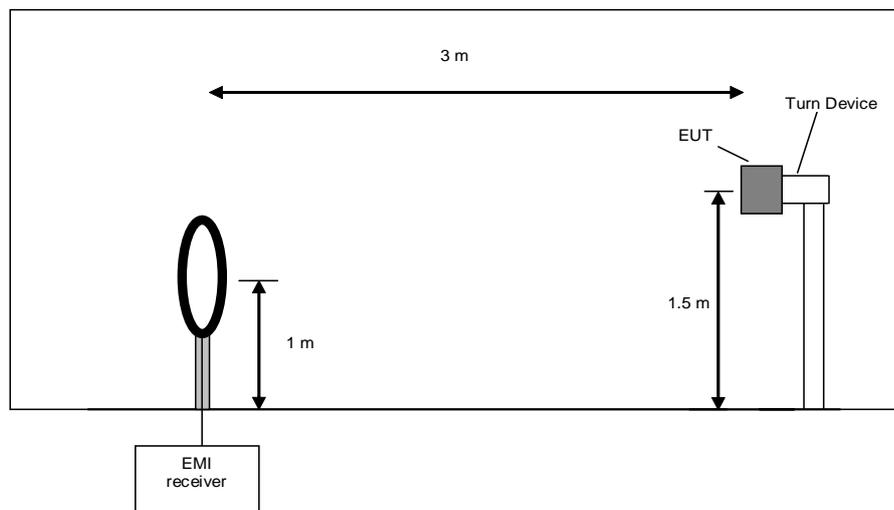

Preliminary measurement procedure:

Pre-scans were performed in the frequency range 9 kHz to 150 kHz and 150 kHz to 30 MHz.

Pre-scans were performed in the frequency range 30 MHz to 230 MHz and 230 MHz to 1 GHz.

The following procedure will be used:

1. Monitor the frequency range at horizontal polarization and a EUT azimuth of 0 °.
2. Manipulate the system cables within the range to produce the maximum level of emission.
3. Rotate the EUT by 360 ° to maximize the detected signals.
4. Repeat 1) to 3) with the vertical polarization of the measuring antenna.
5. Make a hardcopy of the spectrum.
6. Repeat 1) to 5) with the EUT raised by an angle of 0° (45°, 90°) according to 6.6.5.4 in [1].
7. Measure the frequency of the detected emissions with a lower span and resolution bandwidth to increase the accuracy and note the frequency value.

Final measurement (9 kHz to 30 MHz):

In the second stage a final measurement will be performed on an open area test site with no conducting ground plane in measuring distances of 3 m, 10 m and 30 m. In the case where larger measuring distances is required the results will be extrapolated based on the values measured on the closer distances according to Section 15.31 (f) (2) [2]. The final measurement will be performed with a EMI Receiver set to Quasi Peak detector except for the frequency bands 9 kHz to 90 kHz and 110 kHz to 490 kHz where an average detector will be used according Section 15.209 (d) [2].

On the frequencies, which were detected during the preliminary measurements, the final measurement will be performed while rotating the EUT and the measuring antenna in the range of 0 ° to 360 ° around their vertical axis until the maximum value is found.

The resolution bandwidth of the EMI Receiver will be set to the following values:

Frequency range	Resolution bandwidth
9 kHz to 150 kHz	200 Hz
150 kHz to 30 MHz	9 kHz

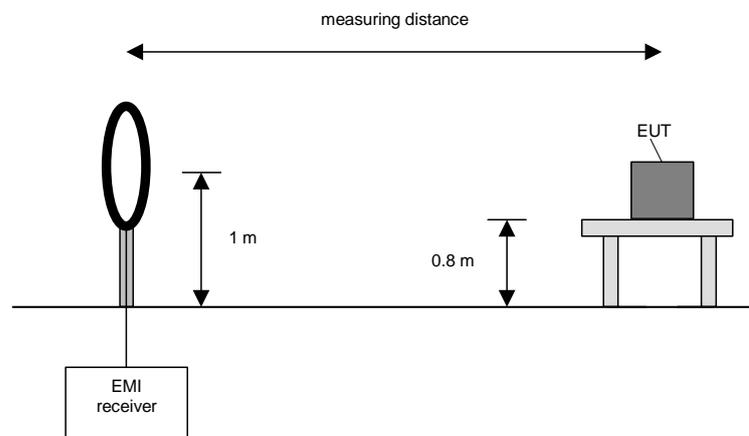

Final measurement procedure:

The following procedure will be used:

- 1) Monitor the frequency range with the measuring antenna at vertical orientation parallel to the EUT at an azimuth of 0 °.
- 2) Rotate the EUT by 360 ° to maximize the detected signals and note the azimuth and orientation.
- 3) Rotate the measuring antenna to find the maximum and note the value.
- 4) Rotate the measuring antenna and repeat steps 1) to 3) until the maximum value is found.
- 5) Repeat steps 1) to 4) with the other orthogonal axes of the EUT (if the EUT is a module and might be used in a handheld equipment application).

Preliminary measurement (30 MHz to 1 GHz)

In the first stage a preliminary measurement will be performed in a fully anechoic chamber with a measuring distance of 3 meter. Table top devices will set up on a non-conducting turn device on the height of 1.5m. Floor-standing devices will be placed directly on the turntable/ground plane. The setup of the Equipment under test will be in accordance to [1].

The frequency range 30 MHz to 1 GHz will be measured with an EMI Receiver set to MAX Hold mode and a resolution bandwidth of 100 kHz. The measurement will be performed in horizontal and vertical polarization of the measuring antenna and while rotating the EUT in its vertical axis in the range of 0 ° to 360 °. This measurement is repeated after raising the EUT in 30° steps according 6.6.5.4 in [1].

The resolution bandwidth of the EMI Receiver will be set to the following values:

Frequency range	Resolution bandwidth
30 MHz to 230 MHz	100 kHz
230 MHz to 1 GHz	100 kHz

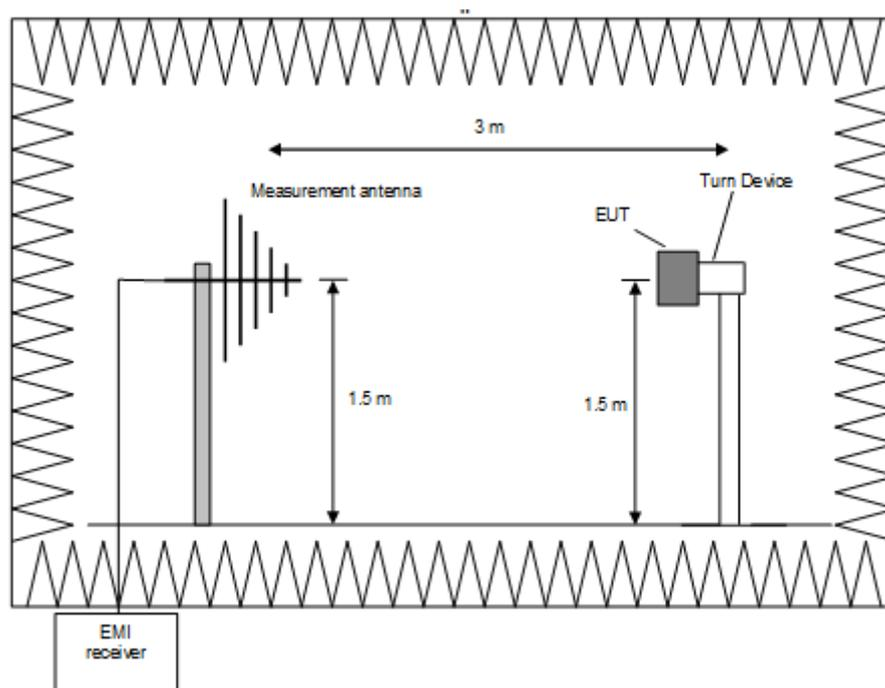

Procedure preliminary measurement:

Pre-scans were performed in the frequency range 30 MHz to 230 MHz and 230 MHz to 1 GHz.
The following procedure will be used:

8. Monitor the frequency range at horizontal polarization and a EUT azimuth of 0°.
9. Manipulate the system cables within the range to produce the maximum level of emission.
10. Rotate the EUT by 360° to maximize the detected signals.
11. Repeat 1) to 3) with the vertical polarization of the measuring antenna.
12. Make a hardcopy of the spectrum.
13. Repeat 1) to 5) with the EUT raised by an angle of 0° (45°, 90°) according to 6.6.5.4 in [1].
14. Measure the frequency of the detected emissions with a lower span and resolution bandwidth to increase the accuracy and note the frequency value.

Final measurement (30 MHz to 1 GHz)

A final measurement on an open area test site will be performed on selected frequencies found in the preliminary measurement. During this test the EUT will be rotated in the range of 0° to 360°, the measuring antenna will be set to horizontal and vertical polarization and raised and lowered in the range from 1 m to 4 m to find the maximum level of emissions.

The resolution bandwidth of the EMI Receiver will be set to the following values:

Frequency range	Resolution bandwidth
30 MHz to 1 GHz	120 kHz

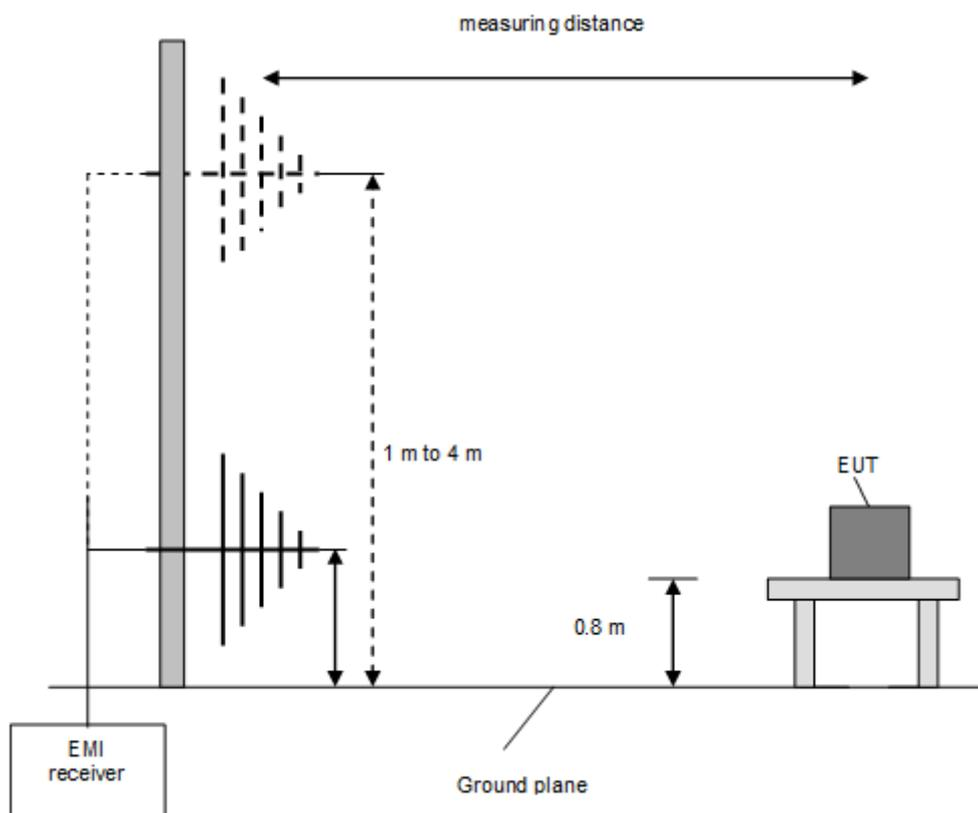

Procedure final measurement:

The following procedure will be used:

- 1) Measure on the selected frequencies at an antenna height of 1 m and a EUT azimuth of 23 °.
- 2) Move the antenna from 1 m to 4 m and note the maximum value at each frequency.
- 3) Rotate the EUT by 45 ° and repeat 2) until an azimuth of 337 ° is reached.
- 4) Repeat 1) to 3) for the other orthogonal antenna polarization.
- 5) Move the antenna and the turntable to the position where the maximum value is detected.
- 6) Measure while moving the antenna slowly +/- 1 m.
- 7) Set the antenna to the position where the maximum value is found.
- 8) Measure while moving the turntable +/- 45 °.
- 9) Set the turntable to the azimuth where the maximum value is found.
- 10) Measure with Final detector (QP and AV) and note the value.
- 11) Repeat 5) to 10) for each frequency.
- 12) Repeat 1) to 11) for each orthogonal axes of the EUT (because of EUT is a module and might be used in a handheld equipment application).

Preliminary and final measurement (1 GHz to 40 GHz)

This measurement will be performed in a fully anechoic chamber. Table top devices will set up on a non-conducting turn device on the height of 1.5m. The set-up of the Equipment under test will be in accordance to [1].

Preliminary measurement (1 GHz to 40 GHz)

The frequency range will be divided into different sub ranges depending of the frequency range of the used horn antenna. The spectrum analyzer set to MAX Hold mode and a resolution bandwidth of 100 kHz. The measurement will be performed in horizontal and vertical polarization of the measuring antenna and while rotating the EUT in its vertical axis in the range of 0 ° to 360 °. This measurement is repeated after raising the EUT in 30° steps according 6.6.5.4 in [1].

The resolution bandwidth of the EMI Receiver will be set to the following values:

Frequency range	Resolution bandwidth
1 GHz to 4 GHz	100 kHz
4 GHz to 12 GHz	100 kHz
12 GHz to 18 GHz	100 kHz
18 GHz to 25 / 26.5 GHz	100 kHz
26.5 GHz to 40 GHz	100 kHz

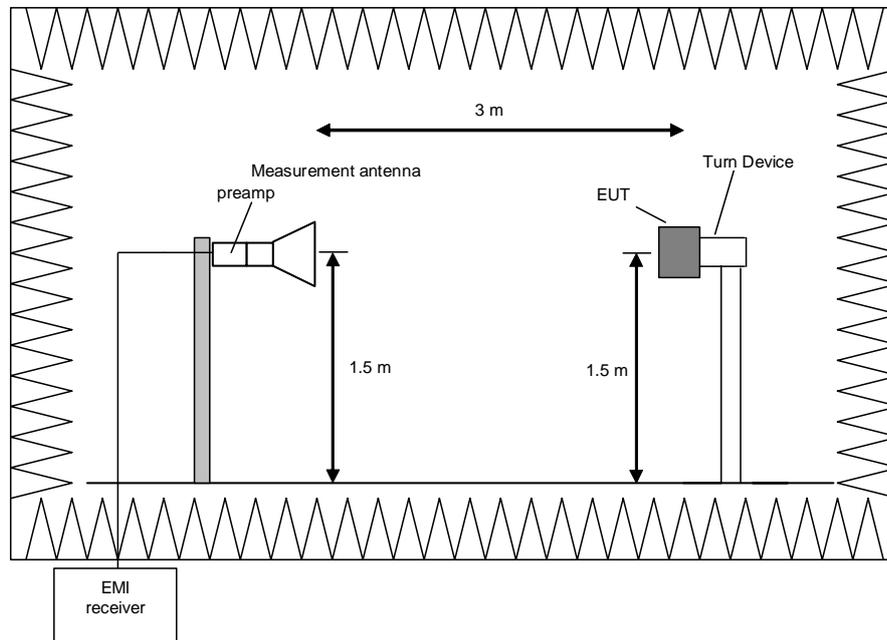

Procedure preliminary measurement:

Pre-scans were performed in the frequency range 1 to 40 GHz.

The following procedure will be used:

1. Monitor the frequency range at horizontal polarization and a EUT azimuth of 0 °.
2. Rotate the EUT by 360° to maximize the detected signals.
3. Repeat 1) to 2) with the vertical polarization of the measuring antenna.
4. Make a hardcopy of the spectrum.
5. Repeat 1) to 4) with the EUT raised by an angle of 30° (60°, 90°, 120° and 150°) according to 6.6.5.4 in [1].
6. Measure the frequency of the detected emissions with a lower span and resolution bandwidth to increase the accuracy and note the frequency value.
7. The measurement antenna polarization, with the according EUT position (Turntable and Turn device) which produces the highest emission for each frequency will be used for the final measurement. The six closest values to the applicable limit will be used for the final measurement.

Final measurement (1 GHz to 40 GHz)

The frequency range will be divided into different sub ranges depending of the frequency range of the used horn antenna. The EMI Receiver set to peak and average mode and a resolution bandwidth of 1 MHz. The measurement will be performed by rotating the turntable through 0 to 360° in the worst-case EUT orientation which was obtained during the preliminary measurements.

The resolution bandwidth of the EMI Receiver will be set to the following values:

Frequency range	Resolution bandwidth
1 GHz to 4 GHz	1 MHz
4 GHz to 12 GHz	1 MHz
12 GHz to 18 GHz	1 MHz
18 GHz to 25 / 26.5 GHz	1 MHz
26.5 GHz to 40 GHz	1 MHz

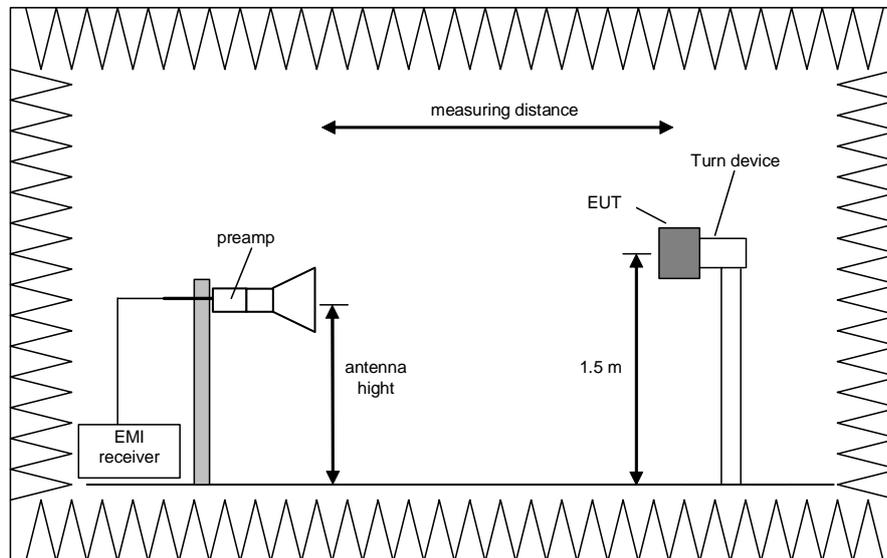

Procedure of measurement:

The measurements were performed in the frequency ranges 1 GHz to 4 GHz, 4 GHz to 12 GHz, 12 GHz to 18 GHz, 18 GHz to 25 /26.5 GHz and 26.5 GHz to 40 GHz.

The following procedure will be used:

- 1) Set the turntable and the turn device to obtain the worst-case emission for the first frequency identified in the preliminary measurements.
- 2) Set the measurement antenna polarization to the orientation with the highest emission for the first frequency identified in the preliminary measurements.
- 3) Set the spectrum analyzer to EMI mode with peak and average detector activated.
- 4) Rotate the turntable from 0° to 360° to find the TT Pos. that produces the highest emissions.
- 5) Note the highest displayed peak and average values
- 6) Repeat the steps 1) to 5) for each frequency detected during the preliminary measurements.

6.6.4.1 Test results (radiated emissions)
6.6.4.1.1 Tested sample PT4-B301#3 (radiated)
6.6.4.1.1.1 Preliminary radiated emission measurement
6.6.4.1.1.1.1 Emissions below 1 GHz

Ambient temperature	22 °C
Relative humidity	45 %

Date	30.06.2018
Tested by	R. BRAUN

Position of EUT: The EUT was set-up on an EUT turn device of a height of 1.5 m. The distance between EUT and antenna was 3 m.

Cable guide: For detail information of test set-up and the cable guide refer to the pictures in Test setup Photo annex.

Test record: All results are shown in the following.

Supply voltage: During all measurements the host of the EUT was powered with 5 V DC via an USB cable.

Remark: Document [1] states in 11.12.2.1, that in case of conducted measurements, additional radiated cabinet emission measurements must be performed. The measurements were performed on the middle channel of the frequency band with the worst case modulation with terminated antenna port.

No emission measurement below 30 MHz – no emission found neither with antenna connected nor conducted.

Spurious emissions from 30 MHz – 1 GHz (All operation modes; preliminary plot):

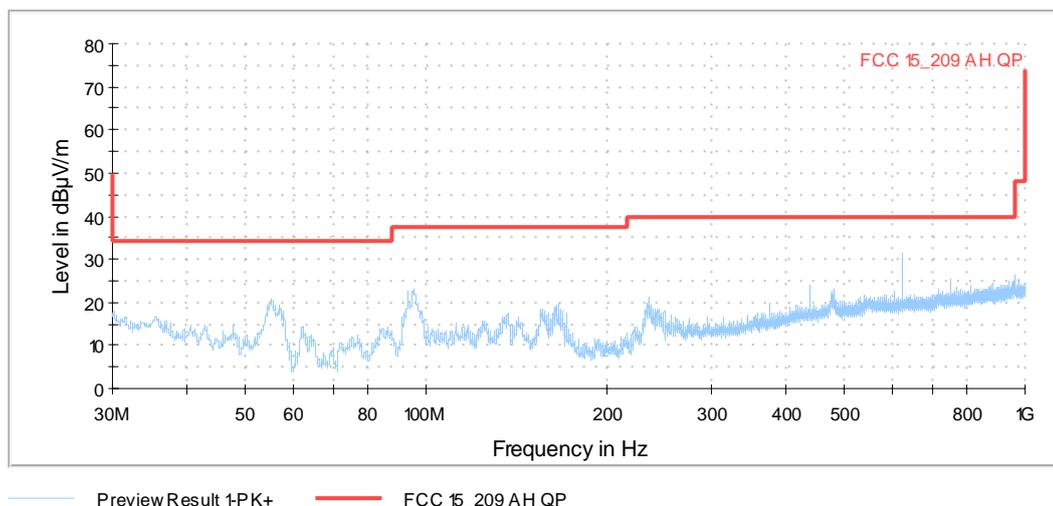

Test equipment (please refer to chapter 6 for details)	
Preliminary measurements below 1 GHz	3 – 5, 7, 11 - 17

6.6.4.1.1.2 Emissions above 1 GHz

Ambient temperature	22 °C
Relative humidity	45 %

Date	30.06.2018
Tested by	R. BRAUN

- Position of EUT:** The EUT was set-up on an EUT turn device of a height of 1.5 m. The distance between EUT and antenna was 3 m.
- Cable guide:** For detail information of test set-up and the cable guide refer to the pictures in Test setup Photo annex.
- Test record:** All results are shown in the following.
- Supply voltage:** During all measurements the host of the EUT was powered with 5 V DC via an USB cable.
- Remark:** Document [1] states in 11.12.2.1, that in case of conducted measurements, additional radiated cabinet emission measurements must be performed. The measurements were performed on the middle channel of the frequency band with the worst case modulation with terminated antenna port.

Spurious emissions from 1 – 4 GHz (Operation mode 2; Preliminary and final plot):

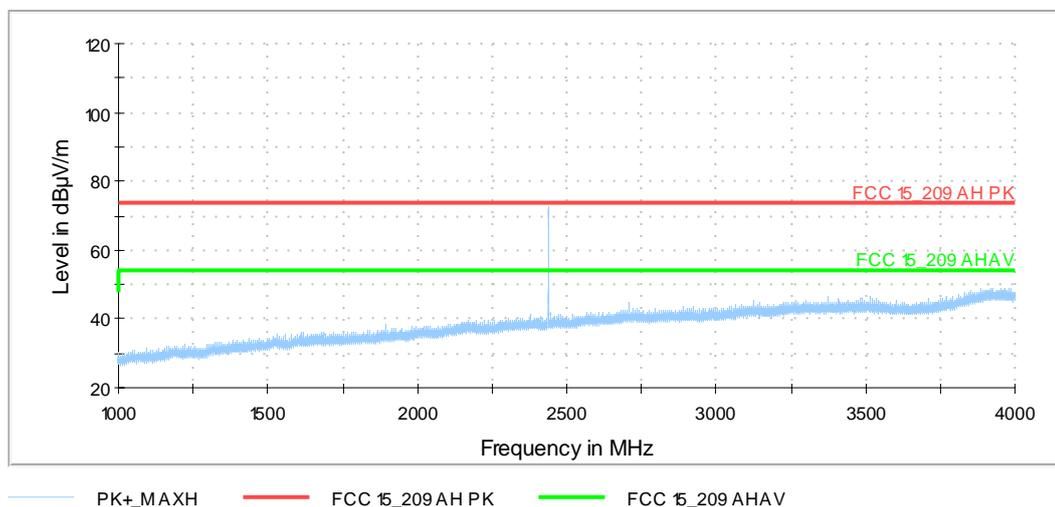

Spurious emissions from 4 - 12 GHz (Operation mode 2; Preliminary and final plot):

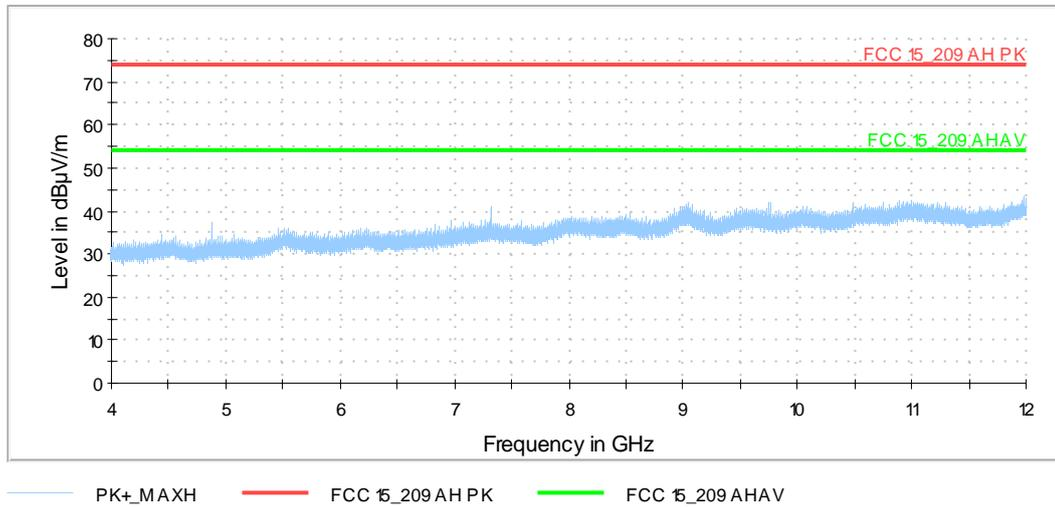

Spurious emissions from 12 - 18 GHz (Operation mode 2; Preliminary and final plot):

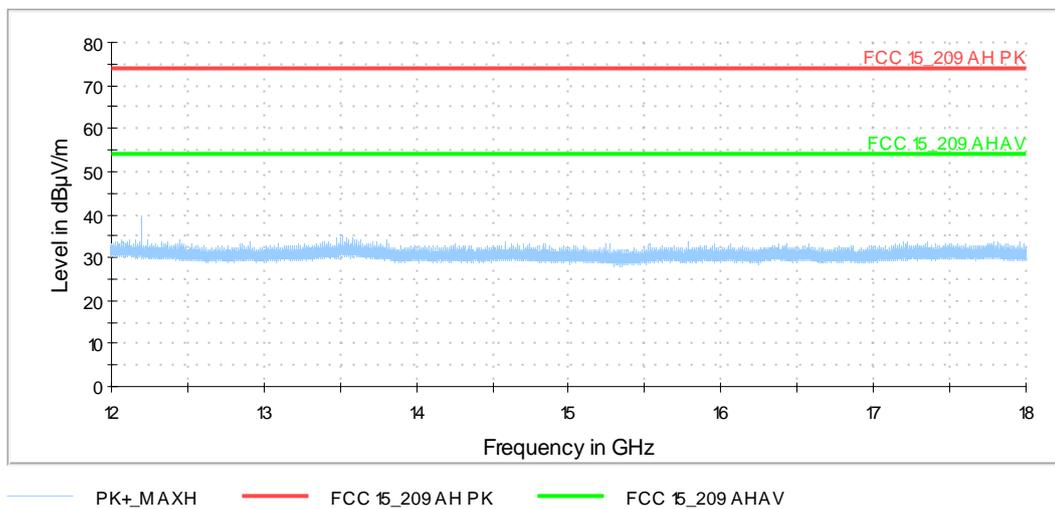

Spurious emissions from 18 – 26.5 GHz (Operation mode 2; Preliminary plot):
no significant emission, no final measurement

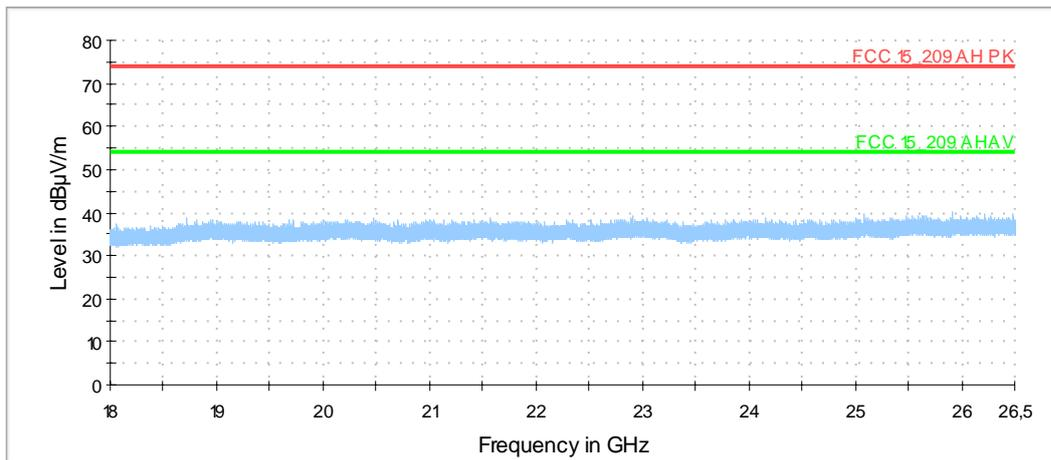

— PK+_MAXH — FCC 15_209 AHPK — FCC 15_209 AHAV

Test equipment (please refer to chapter 6 for details)	
Preliminary measurements above 1 GHz	3 - 9, 11, 13, 16, 25 - 31

6.6.4.1.1.2 Final radiated emission measurement (9 kHz to 1 GHz)

Ambient temperature	22 °C
Relative humidity	45 %

Date	17.07.2018
Tested by	R. BRAUN

- Position of EUT:** The EUT was set-up on a non-conducting table of a height of 0.8 m. The distance between EUT and antenna was 3 m.
- Cable guide:** For detail information of test set-up and the cable guide refer to the pictures in test setup photos.
- Test record:** All results are shown in the following.
- Supply voltage:** During all measurements the host of the EUT was powered with 5 V DC via an USB cable.
- The correction factor is calculated as Antenna Factor [dB] + Cable Attenuation [dB] - Amplifier Gain [dB]
- The result Peak/Average is the result of Reading [dB μ V/m] – Correction factor [dB]
- Remark:** Document [1] states in 11.12.2.1, that in case of conducted measurements, additional radiated cabinet emission measurements must be performed. The measurements were performed on the middle channel of the frequency band with the worst case modulation with terminated antenna port.
- The Emissions below 1 GHz were equal for all antenna ports, transmit frequencies, modulation schemes and data rates. Therefore only the results of an exemplary test case are submitted below.

Spurious emissions from 30 MHz – 1 GHz (All operation modes; final plot):

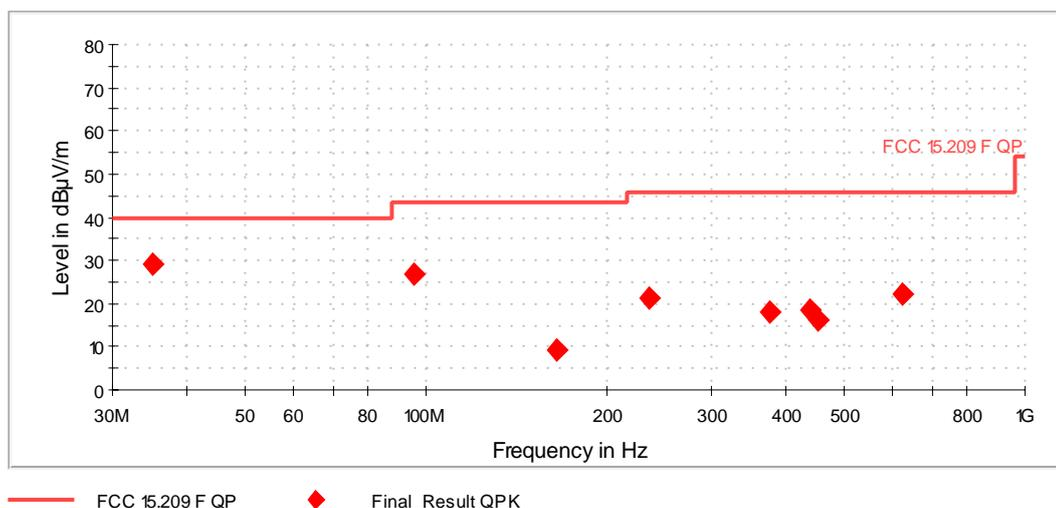

Spurious Emissions (All Operation modes) 9kHz - 30 MHz								
Frequency [MHz]	Reading [dB μ V]	Result* [dB μ V/m]	Limit acc. 15.209 [dB μ V/m]	Margin [dB]	Detector (acc. to §15.209 (d)	Antenna factor [dB/m]	Measuring Distance [m]	Distance correction factor** [dB]
No emission found, so no final measurement was carried out								

Spurious Emissions (All Operation modes) 30 MHz - 1 GHz								
Frequency [MHz]	QuasiPeak [dB μ V/m]	Limit [dB μ V/m]	Margin dB	Pol	Azimuth [°]	Height [cm]	Correction [dB]	Result
35.141000	29.0	40	11.0	V	322	104	24.9	Passed
95.378000	26.9	43.5	16.6	V	319	102	16.9	Passed
165.606000	9.4	43.5	34.1	V	36	400	18.0	Passed
235.397500	21.3	46	24.7	H	91	144	18.8	Passed
374.980500	18.1	46	27.9	H	223	103	23.6	Passed
437.497000	18.3	46	27.7	H	118	231	25.8	Passed
452.047000	16.1	46	29.9	H	136	233	26.0	Passed
624.949500	22.2	46	23.8	V	256	190	30.2	Passed
Measurement uncertainty				+2.2 dB / -3.6 dB				

Test equipment (please refer to chapter 6 for details)
18 - 24

6.6.4.1.1.3 Final radiated emission measurement (1 GHz to 25 GHz)

Ambient temperature	22 °C
Relative humidity	45 %

Date	21.06.2018
Tested by	R. BRAUN

- Position of EUT:** The EUT was set-up on a EUT turn device of a height of 1.5 m. The distance between EUT and antenna was 3 m.
- Cable guide:** For detail information of test set-up and the cable guide refer to the pictures in test setup photos.
- Test record:** All results are shown in the following.
- Supply voltage:** During all measurements the host of the EUT was powered with 5 V DC via an USB cable.
- Resolution bandwidth:** For all measurements a resolution bandwidth of 1 MHz was used.
- Additional information:** For simplification all values were compared to the restricted band limits.
- Remark:** Document [1] states in 11.12.2.1, that in case of conducted measurements, additional radiated cabinet emission measurements must be performed. The measurements were performed on the middle channel of the frequency band with the worst case modulation with terminated antenna port.

Spurious Emissions 1 – 25 GHz (Operation mode 1)									
Operation mode 1			Duty cycle correction factor of 0 dB was applied for the Average reading						
Frequency	Max Peak	Average	Limit	Margin	Pol	Azimuth	Elevation	Correction	Result
[MHz]	[dB μ V/m]	[dB μ V/m]	[dB μ V/m]	dB		[°]	[°]	[dB]	
4878.977778	---	35.2	54	18.8	V	262	150	-1.7	Passed
4878.977778	45.8	---	74	28.2	V	262	150	-1.7	Passed
7318.888889	---	39.0	54	15.0	V	27	0	4.8	Passed
7318.888889	48.9	---	74	25.1	V	27	0	4.8	Passed
9762.044444	---	39.8	54	14.2	H	329	120	6.8	Passed
9762.044444	51.4	---	74	22.6	H	329	120	6.8	Passed
12197.580000	---	38.6	54	15.4	V	258	120	11.9	Passed
12197.580000	48.4	---	74	25.6	V	258	120	11.9	Passed
12202.140000	---	37.7	54	16.3	V	239	150	11.9	Passed
12202.140000	47.0	---	74	27.0	V	239	150	11.9	Passed
14639.340000	---	29.2	54	24.8	V	228	60	11.4	Passed
14639.340000	41.2	---	74	32.8	V	228	60	11.4	Passed
17079.780000	---	29.0	54	25.0	V	158	150	10.7	Passed
17079.780000	41.6	---	74	32.4	V	158	150	10.7	Passed
Measurement uncertainty				+2.2 dB / -3.6 dB					

Test equipment (please refer to chapter 6 for details)

3 - 9, 11, 13, 16, 25 - 31

6.6.4.1.2 Tested sample PT2-B312#8 (radiated)
6.6.4.1.2.1 Preliminary radiated emission measurement
6.6.4.1.2.1.1 Emissions below 1 GHz

Ambient temperature	22 °C
Relative humidity	45 %

Date	30.06.2018
Tested by	R. BRAUN

- Position of EUT:** The EUT was set-up on an EUT turn device of a height of 1.5 m. The distance between EUT and antenna was 3 m.
- Cable guide:** For detail information of test set-up and the cable guide refer to the pictures in Test setup Photo annex.
- Test record:** All results are shown in the following.
- Supply voltage:** During all measurements the host of the EUT was powered with 5 V DC via an USB cable.
- Remark:** The EUT PT2-B312#8 with integral antenna was tested completely radiated.
- The Emissions below 1 GHz were equal for all antenna ports, transmit frequencies, modulation schemes and data rates. Therefore only the results of an exemplary test case are submitted below.

Spurious emissions from 9 kHz - 30 MHz (all operation modes):

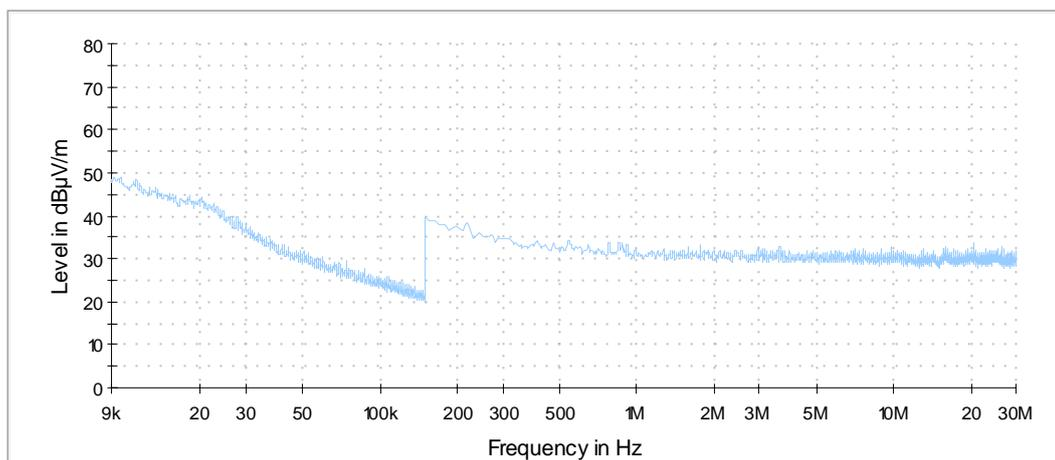

Preview Result 1-PK+

Spurious emissions from 30 MHz – 1 GHz (all operation modes; preliminary plot):

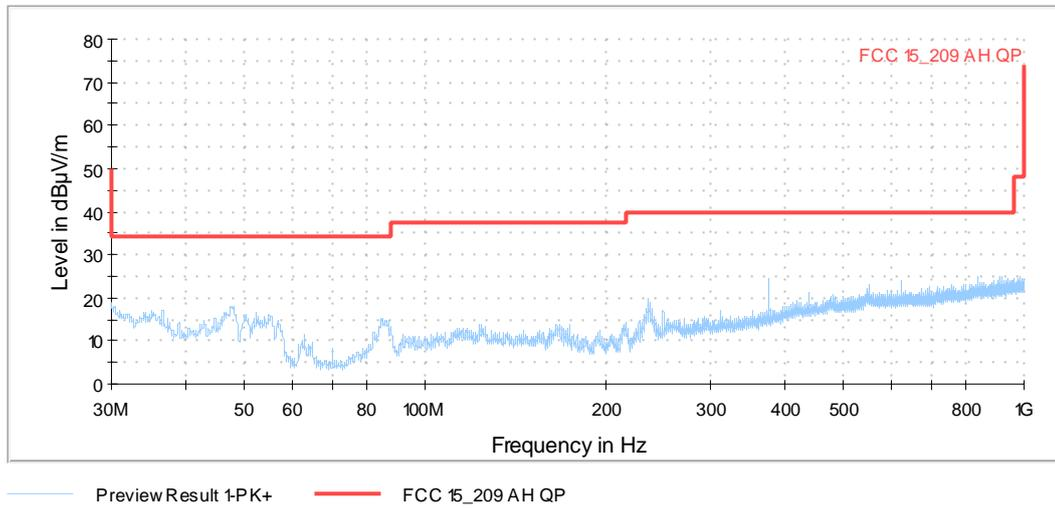

6.6.4.1.2.1.2 Emissions above 1 GHz

Ambient temperature	22 °C
Relative humidity	45 %

Date	30.06.2018
Tested by	R. BRAUN

- Position of EUT:** The EUT was set-up on an EUT turn device of a height of 1.5 m. The distance between EUT and antenna was 3 m.
- Cable guide:** For detail information of test set-up and the cable guide refer to the pictures in Test setup Photo annex.
- Test record:** All results are shown in the following.
- Supply voltage:** During all measurements the host of the EUT was powered with 5 V DC via an USB cable.
- Remark:** Document [1] states in 11.12.2.1, that in case of conducted measurements, additional radiated cabinet emission measurements must be performed. The measurements were performed on the middle channel of the frequency band with the worst case modulation with terminated antenna port.

Spurious emissions from 1 – 4 GHz (Operation mode 2; Preliminary and final plot):

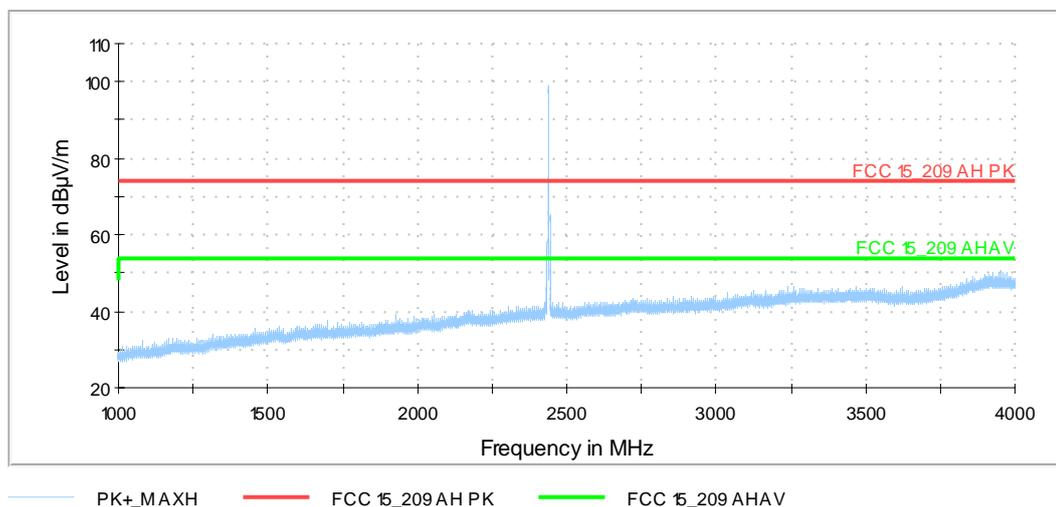

Spurious emissions from 4 – 12 GHz (Operation mode 2; Preliminary and final plot):

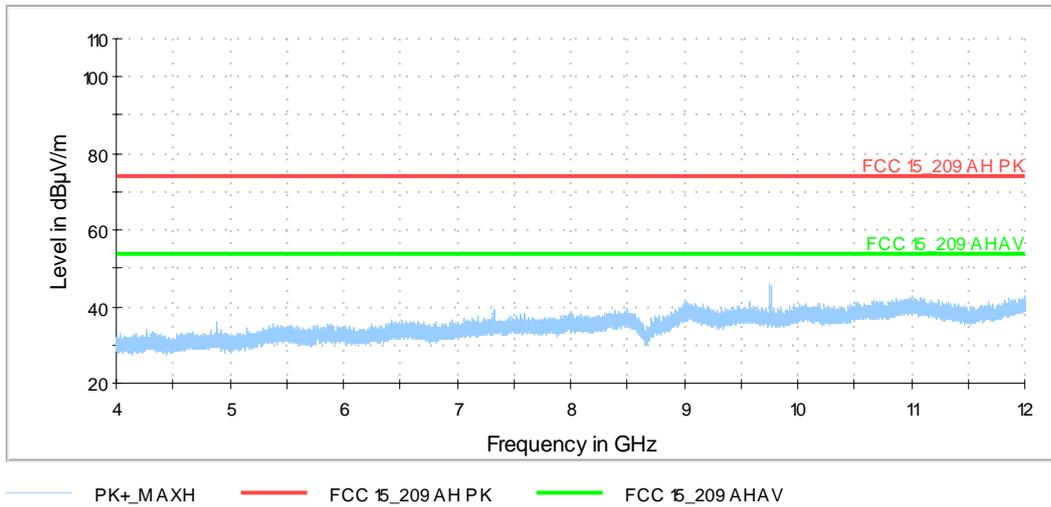

Spurious emissions from 12 - 18 GHz (Operation mode 2; Preliminary and final plot):

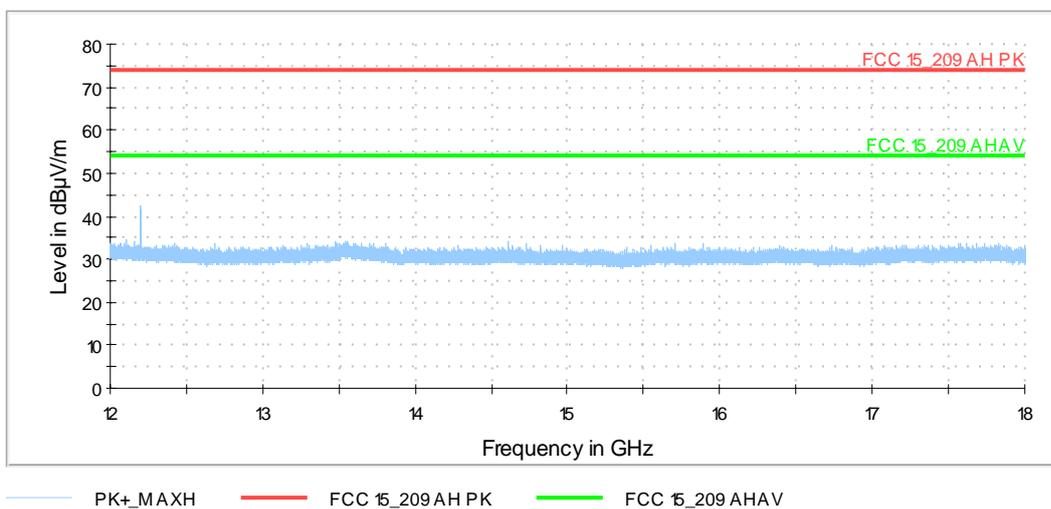

Spurious emissions from 18 -26.5 GHz (Operation mode 2; Preliminary plot):
No final measurement done, no significant emission above the noise floor found.

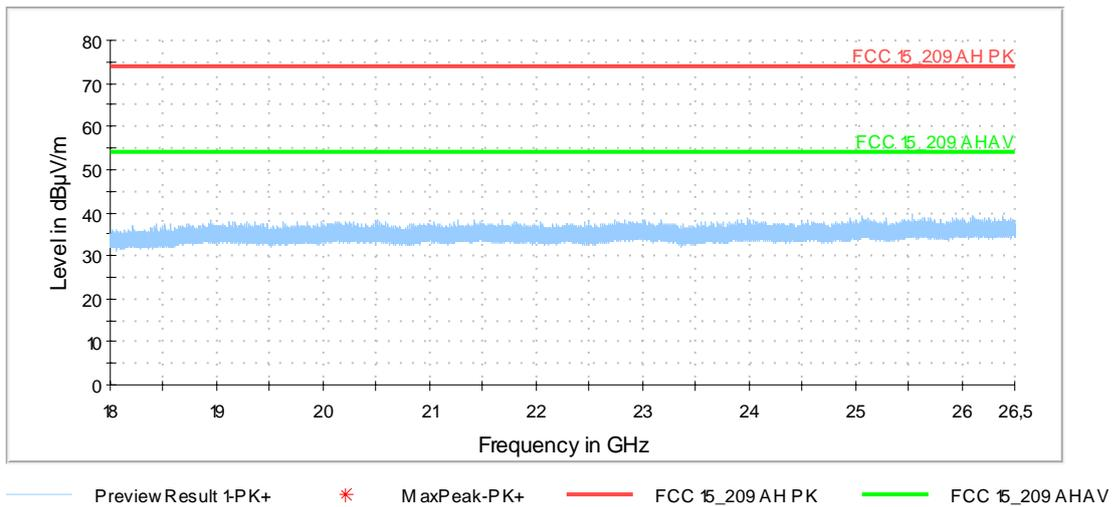

Test equipment (please refer to chapter 6 for details)
3 - 5, 7, 11 - 17

6.6.4.1.2.2 Final radiated emission measurement (9 kHz to 1 GHz)

Ambient temperature	22 °C
Relative humidity	45 %

Date	30.06.2018
Tested by	R. BRAUN

- Position of EUT:** The EUT was set-up on a non-conducting table of a height of 0.8 m or an EUT turn device of a height of 1.5 m. The distance between EUT and antenna was 3 m.
- Cable guide:** For detail information of test set-up and the cable guide refer to the pictures in test setup photos.
- Test record:** All results are shown in the following.
- Supply voltage:** During all measurements the host of the EUT was powered with 5 V DC via an USB cable from the ancillary laptop.
- Remark**
- No significant emissions above the noise floor found below 30 MHz, no final measurement done.
- The correction factor is calculated as Antenna Factor [dB] + Cable Attenuation [dB] - Amplifier Gain [dB]
- The result Peak/Average is the result of Reading [dB μ V/m] – Correction factor [dB]

Spurious Emissions (All operation modes) 9kHz - 30 MHz								
Frequency [MHz]	Reading [dB μ V]	Result* [dB μ V/m]	Limit acc. 15.209 [dB μ V/m]	Margin [dB]	Detector (acc. to §15.209 (d)	Antenna factor [dB/m]	Measuring Distance [m]	Distance correction factor** [dB]
No emission found, so no final measurement was carried out								

Spurious Emissions (All operation modes) 30 MHz - 1 GHz								
Frequency [MHz]	QuasiPeak [dB μ V/m]	Limit [dB μ V/m]	Margin dB	Pol	Azimuth [°]	Height [cm]	Correction [dB]	Result
47.460000	29.3	40	10.7	V	1	100	18.0	Passed
84.950500	25.4	40	14.6	V	16	134	16.8	Passed
167.982500	12.8	43.5	30.7	V	44	100	18.9	Passed
235.203500	19.4	46	26.6	H	113	137	20.1	Passed
374.980500	18.6	46	27.4	H	127	102	24.3	Passed
437.448500	17.3	46	28.7	H	117	231	25.8	Passed
498.849500	17.7	46	28.3	V	11	323	27.5	Passed
624.998000	24.3	46	21.7	H	66	163	30.2	Passed
837.622000	22.8	46	23.2	H	181	368	33.5	Passed
Measurement uncertainty				+2.2 dB / -3.6 dB				

Test equipment (please refer to chapter 6 for details)
18 - 24

6.6.4.1.2.3 Final radiated emission measurement (1 GHz to 25 GHz)

Ambient temperature	22 °C
Relative humidity	45 %

Date	30.06.2018
Tested by	R. BRAUN

- Position of EUT: The EUT was set-up on an EUT turn device of a height of 1.5 m. The distance between EUT and antenna was 3 m.
- Cable guide: For detail information of test set-up and the cable guide refer to the pictures in test setup photos.
- Test record: All results are shown in the following.
- Supply voltage: During all measurements the host of the EUT was powered with 5 V DC via an USB cable.
- Resolution bandwidth: For all measurements a resolution bandwidth of 1 MHz was used.
- Additional information: For simplification all values were compared to the restricted band limits.

Spurious Emissions 1 – 25 GHz (Operation mode 1)									
Duty cycle correction factor of 0 dB was applied for the Average reading									
Frequency	Max Peak	Average	Limit	Margin	Pol	Azimuth	Elevation	Correction	Result
[MHz]	[dB μ V/m]	[dB μ V/m]	[dB μ V/m]	dB		[°]	[°]	[dB]	
3890.500000	52.0	---	74	22.0	H	53	0	40.0	Passed
3890.500000	---	39.7	54	14.3	H	53	0	40.0	Passed
3903.600000	52.0	---	74	22.0	V	248	30	40.1	Passed
3903.600000	---	40.0	54	14.0	V	248	30	40.1	Passed
3910.050000	52.1	---	74	21.9	V	248	60	40.1	Passed
3910.050000	---	40.0	54	14.0	V	248	60	40.1	Passed
3946.000000	51.8	---	74	22.2	V	308	0	40.1	Passed
3946.000000	---	40.1	54	13.9	V	308	0	40.1	Passed
3984.400000	---	39.9	54	14.1	V	3	150	39.6	Passed
3984.400000	51.9	---	74	22.1	V	3	150	39.6	Passed
4810.000000	---	31.5	54	22.5	V	71	0	-1.9	Passed
4810.000000	43.7	---	74	30.3	V	71	0	-1.9	Passed
7213.733333	---	39.7	54	14.3	H	7	59	4.2	Passed
7213.733333	50.1	---	74	23.9	H	7	59	4.2	Passed
10986.800000	---	38.8	54	15.2	V	170	120	8.8	Passed
10986.800000	50.8	---	74	23.2	V	170	120	8.8	Passed
12022.560000	---	47.8	54	6.2	V	234	150	12.1	Passed
12022.560000	56.1	---	74	17.9	V	234	150	12.1	Passed
12025.080000	---	33.1	54	20.9	V	314	120	12.1	Passed
12025.080000	50.9	---	74	23.1	V	314	120	12.1	Passed
12027.360000	---	47.9	54	6.1	V	234	150	12.1	Passed
12027.360000	55.7	---	74	18.3	V	234	150	12.1	Passed
14433.000000	---	31.7	54	22.3	V	269	90	11.5	Passed
14433.000000	43.9	---	74	30.1	V	269	90	11.5	Passed
16831.260000	---	28.9	54	25.1	V	351	59	10.6	Passed
16831.260000	41.1	---	74	32.9	V	351	59	10.6	Passed
Measurement uncertainty				+2.2 dB / -3.6 dB					

Spurious Emissions 1 – 25 GHz (Operation mode 2)									
Duty cycle correction factor of 0 dB was applied for the Average reading									
Frequency	Max Peak	Average	Limit	Margin	Pol	Azimuth	Elevation	Correction	Result
[MHz]	[dB μ V/m]	[dB μ V/m]	[dB μ V/m]	dB		[°]	[°]	[dB]	
3952.200000	---	40.2	54	13.8	V	87	120	40.0	Passed
3952.200000	52.2	---	74	21.8	V	87	120	40.0	Passed
4880.977778	---	33.7	54	20.3	V	88	0	-1.7	Passed
4880.977778	44.3	---	74	29.7	V	88	0	-1.7	Passed
7321.377778	---	35.8	54	18.2	V	306	60	4.8	Passed
7321.377778	47.4	---	74	26.6	V	306	60	4.8	Passed
9758.044444	---	43.9	54	10.1	H	333	90	6.7	Passed
9758.044444	53.8	---	74	20.2	H	333	90	6.7	Passed
11003.244444	---	38.5	54	15.5	H	183	59	9.0	Passed
11003.244444	50.4	---	74	23.6	H	183	59	9.0	Passed
12197.400000	---	41.3	54	12.7	V	215	150	11.9	Passed
12197.400000	50.8	---	74	23.2	V	215	150	11.9	Passed
12202.080000	---	40.7	54	13.3	V	215	150	11.9	Passed
12202.080000	49.5	---	74	24.5	V	215	150	11.9	Passed
14616.120000	41.9	---	74	32.1	V	354	30	11.5	Passed
14616.120000	---	29.1	54	24.9	V	354	30	11.5	Passed
17075.220000	41.2	---	74	32.8	H	230	90	10.7	Passed
17075.220000	---	29.0	54	25.0	H	230	90	10.7	Passed
Measurement uncertainty				+2.2 dB / -3.6 dB					

Spurious Emissions 1 – 25 GHz (Operation mode 3)									
Duty cycle correction factor of 0 dB was applied for the Average reading									
Frequency	Max Peak	Average	Limit	Margin	Pol	Azimuth	Elevation	Correction	Result
[MHz]	[dB μ V/m]	[dB μ V/m]	[dB μ V/m]	dB		[°]	[°]	[dB]	
3916.000000	---	40.1	54	13.9	H	311	30	40.1	Passed
3916.000000	52.3	---	74	21.7	H	311	30	40.1	Passed
4950.977778	---	37.5	54	16.5	V	38	0	-1.8	Passed
4950.977778	47.4	---	74	26.6	V	38	0	-1.8	Passed
7426.266667	---	38.1	54	15.9	V	311	150	4.9	Passed
7426.266667	48.4	---	74	25.6	V	311	150	4.9	Passed
9898.044444	---	45.6	54	8.4	H	326	90	7.1	Passed
9898.044444	55.3	---	74	18.7	H	326	90	7.1	Passed
10931.511111	---	37.8	54	16.2	V	25	29	8.5	Passed
10931.511111	49.9	---	74	24.1	V	25	29	8.5	Passed
12372.600000	---	36.7	54	17.3	V	271	60	12.1	Passed
12372.600000	47.1	---	74	26.9	V	271	60	12.1	Passed
14849.460000	---	28.6	54	25.4	V	183	150	11.2	Passed
14849.460000	40.4	---	74	33.6	V	183	150	11.2	Passed
17322.000000	---	29.4	54	24.6	V	323	90	10.7	Passed
17322.000000	42.5	---	74	31.5	V	323	90	10.7	Passed
Measurement uncertainty				+2.2 dB / -3.6 dB					

Test equipment (please refer to chapter 6 for details)

3 - 9, 11, 13, 16, 25 - 31

6.7 Conducted emissions on power supply lines (150 kHz to 30 MHz)

Ambient temperature	22 °C
Relative humidity	45 %

Date	08.06.2018
Tested by	M. BASTERT

- Position of EUT: Tabletop equipment, see photos in annex A of this test report
- Cable guide: For detail information of test set-up and the cable guide refer to the photos in annex A of this test report.
- Test record: All results are shown in the following.
- Supply voltage: For the test the evaluation board of the EUT was connected to an ancillary laptop "P/N CA01007-0920" by "FUJITSU LIMITED" via USB, the power supply of the laptop was itself powered with 120V/60Hz. The AC mains emissions were tested at the power supply of the laptop.

The curves in the diagram only represent for each frequency point the maximum measured value of all preliminary measurements which were made for each power supply line. The top measured curve represents the peak measurement and the bottom measured curve the average measurement. The quasi-peak measured points are marked by "◆" and the average measured points by "▼"

Conducted emissions on power supply (all operation modes):

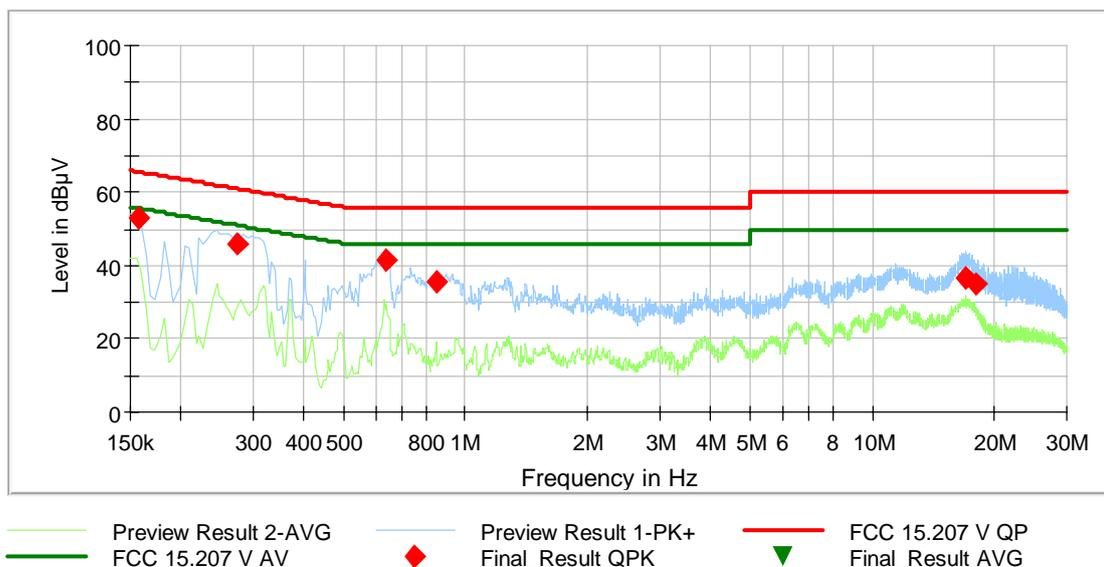

Frequency [MHz]	QuasiPeak [dB μ V]	Average [dB μ V]	Limit [dB μ V]	Margin [dB]	Meas. Time [ms]	Bandwidth (kHz)	Line	PE	Corr. (dB)
0.1563	53.0	---	65.7	12.7	5000	9	N	GND	9.8
0.2751	46.1	---	61.0	14.8	5000	9	L1	GND	9.9
0.6369	41.7	---	56.0	14.3	5000	9	L1	GND	9.9
0.8457	35.7	---	56.0	20.3	5000	9	L1	FLO	9.9
16.9584	36.7	---	60.0	23.4	5000	9	L1	FLO	10.8
17.8701	34.9	---	60.0	25.1	5000	9	N	FLO	10.9

Test: Passed

Test equipment (please refer to chapter 6 for details)
22, 32 - 35

7 Test Equipment used for Tests

No.	Test equipment	Type	Manufacturer	Serial No.	PM. No.	Cal. Date	Cal Due
1	Signal & Spectrum Analyzer	FSW43	Rohde & Schwarz	100586 & 100926	481720	15.03.2018	03.2020
2	Spectrum Analyzer	FSU46	Rohde & Schwarz	200125	480956	01.03.2018	03.2019
3	Antenna mast	AS615P	Deisel	615/310	480187	Calibration not necessary	
4	Fully anechoic chamber M20	B83117-E2439-T232	Albatross Projects	103	480303	Calibration not necessary	
5	Turntable	DS420 HE	Deisel	420/620/00	480315	Calibration not necessary	
6	RF-cable No.3	Sucoflex 106B	Suhner	0563/6B / Kabel 3	480670	Calibration not necessary	
7	Multiple Control Unit	MCU	Maturo GmbH	MCU/043/97110 7	480832	Calibration not necessary	
8	Antenna (Log.Per.)	HL050	Rohde & Schwarz	100438	481170	09.10.2017	10.2020
9	RF-Cable No. 40	Sucoflex 106B	Suhner	0708/6B / Kabel 40	481330	Calibration not necessary	
10	HF-Cable	Sucoflex 104	Huber+Suhner	517406	482391	Calibration not necessary	
11	EMI Receiver / Spectrum Analyzer	ESW44	Rohde & Schwarz	101635	482467	22.06.2017	06.2019
12	Antenna (Bilog)	CBL6112B	Schaffner EMV GmbH (-Chase)	2688	480328	19.06.2017	06.2020
13	Software	WMS32	Rohde & Schwarz		481800	Calibration not necessary	
14	RF-cable No.36	Sucoflex 106B	Suhner	0587/6B / Kabel 36	480865	Calibration not necessary	
15	HF-Cable	Sucoflex 104	Huber+Suhner	517402	482392	Calibration not necessary	
16	Positioners	TDF 1.5- 10Kg	Maturo	15920215	482034	Calibration not necessary	
17	loop antenna	HFH2-Z2	Rohde & Schwarz	100417	481912	19.12.2017	12.2018
18	Open area test site M6	Freifeld M6	Phoenix Contact	-	480085	Calibration not necessary	
19	Antenna mast	MA240-0	Inn-Co GmbH	MA240-0/030/6600603	480086	Calibration not necessary	
20	Turntable	DS412	Deisel	412/316	480087	Calibration not necessary	
21	Controller	HD100	Deisel	100/349	480139	Calibration not necessary	
22	Software	EMC32	Rohde & Schwarz	100061	481022	Calibration not necessary	
23	Antenna (Bilog)	CBL6111D	Schaffner Elektrottest GmbH / Teseq GmbH	25761	480894	19.10.2017	10.2020
24	EMI Measuring receiver	ESR7	Rohde & Schwarz	101939	482558	19.09.2017	09.2019
25	standard gain horn antenna	18240-20	Flann Microwave	483	480294	Calibration not necessary	
26	standard gain horn antenna	20240-20	Flann Microwave	411	480297	Calibration not necessary	
27	Microwave cable 2m	Insulated Wire Inc.	Insulated Wire	KPS-1533-800-KPS	480302	Calibration not necessary	
28	Preamplifier 100 MHz - 13 GHz	JS3-00101200-23-5A	MITEQ Hauppauge N.Y.	681851	480337	14.03.2018	03.2020

No.	Test equipment	Type	Manufacturer	Serial No.	PM. No.	Cal. Date	Cal Due
29	Preamplifier 18 GHz - 26 GHz	JS4-18002600-20-5A	MITEQ Hauppauge N.Y.	658697	480342	14.03.2018	03.2020
30	Preamplifier 12 GHz - 18 GHz	JS3-12001800-16-5A	MITEQ Hauppauge N.Y.	571667	480343	14.03.2018	03.2020
31	High pass filter	WHKX4.0/18G-8SS	Wainwright Instruments GmbH	1	480587	Calibration not necessary	
32	LISN	NSLK8128	Schwarzbeck	8128161	480138	13.03.2018	03.2020
33	Shielded chamber M4	B83117-S1-X158	Siemens	190075	480088	Calibration not necessary	
34	EMI Receiver / Spectrum Analyzer	ESIB 26	Rohde & Schwarz	100292	481182	28.02.2018	02.2020
35	Transient Filter Limiter	CFL 9206A	Teseq GmbH	38268	481982	14.03.2018	03.2020

