

FCC Test Report (BT-LE)

Report No.: RF181120C09D-2

FCC ID: XPYNINAB30

Test Model: NINA-B3

Received Date: Mar. 29, 2019

Test Date: Aug. 30 to Sep. 02, 2019

Issued Date: Sep. 20, 2019

Applicant: u-blox-AG

Address: Zuercherstrasse 68 8800 Thalwil, Switzerland

Issued By: Bureau Veritas Consumer Products Services (H.K.) Ltd., Taoyuan Branch
Hsin Chu Laboratory

Lab Address: E-2, No.1, Li Hsin 1st Road, Hsinchu Science Park, Hsinchu City 300,
Taiwan R.O.C.

Test Location: E-2, No.1, Li Hsin 1st Road, Hsinchu Science Park, Hsinchu City 300,
Taiwan R.O.C.

**FCC Registration /
Designation Number:** 723255 / TW2022



This report is for your exclusive use. Any copying or replication of this report to or for any other person or entity, or use of our name or trademark, is permitted only with our prior written permission. This report sets forth our findings solely with respect to the test samples identified herein. The results set forth in this report are not indicative or representative of the quality or characteristics of the lot from which a test sample was taken or any similar or identical product unless specifically and expressly noted. Our report includes all of the tests requested by you and the results thereof based upon the information that you provided to us. You have 60 days from date of issuance of this report to notify us of any material error or omission caused by our negligence, provided, however, that such notice shall be in writing and shall specifically address the issue you wish to raise. A failure to raise such issue within the prescribed time shall constitute your unqualified acceptance of the completeness of this report, the tests conducted and the correctness of the report contents. Unless specific mention, the uncertainty of measurement has been explicitly taken into account to declare the compliance or non-compliance to the specification. The report must not be used by the client to claim product certification, approval, or endorsement by TAF or any government agencies.

Table of Contents

Release Control Record	3
1 Certificate of Conformity	4
2 Summary of Test Results	5
2.1 Measurement Uncertainty	5
2.2 Modification Record	5
3 General Information	6
3.1 General Description of EUT (BT-LE)	6
3.2 Description of Test Modes	7
3.2.1 Test Mode Applicability and Tested Channel Detail	8
3.3 Duty Cycle of Test Signal	10
3.4 Description of Support Units	11
3.4.1 Configuration of System under Test	12
3.5 General Description of Applied Standards	13
4 Test Types and Results	14
4.1 Radiated Emission and Bandedge Measurement	14
4.1.1 Limits of Radiated Emission and Bandedge Measurement	14
4.1.2 Test Instruments	15
4.1.3 Test Procedures	16
4.1.4 Deviation from Test Standard	17
4.1.5 Test Setup	17
4.1.6 EUT Operating Conditions	18
4.1.7 Test Results	19
4.2 Conducted Emission Measurement	27
4.2.1 Limits of Conducted Emission Measurement	27
4.2.2 Test Instruments	27
4.2.3 Test Procedures	28
4.2.4 Deviation from Test Standard	28
4.2.5 Test Setup	28
4.2.6 EUT Operating Conditions	28
4.2.7 Test Results	29
4.3 Conducted Output Power Measurement	31
4.3.1 Limits of Conducted Output Power Measurement	31
4.3.2 Test Setup	31
4.3.3 Test Instruments	31
4.3.4 Test Procedures	31
4.3.5 Deviation from Test Standard	31
4.3.6 EUT Operating Conditions	31
4.3.7 Test Results	32
5 Pictures of Test Arrangements	33
Appendix – Information of the Testing Laboratories	34

Release Control Record

Issue No.	Description	Date Issued
RF181120C09D-2	Original release.	Sep. 20, 2019

1 Certificate of Conformity

Product: Stand-alone radio module

Brand: u-blox-AG

Test Model: NINA-B3

Sample Status: ENGINEERING SAMPLE

Applicant: u-blox-AG

Test Date: Aug. 30 to Sep. 02, 2019

Standards: 47 CFR FCC Part 15, Subpart C (Section 15.247)
ANSI C63.10: 2013

The above equipment has been tested by **Bureau Veritas Consumer Products Services (H.K.) Ltd., Taoyuan Branch**, and found compliance with the requirement of the above standards. The test record, data evaluation & Equipment Under Test (EUT) configurations represented herein are true and accurate accounts of the measurements of the sample's EMC characteristics under the conditions specified in this report.

Prepared by :  , **Date:** Sep. 20, 2019
Claire Kuan / Specialist

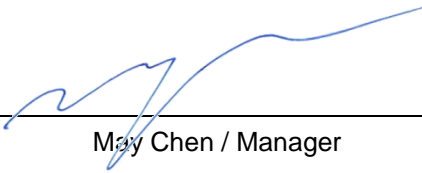
Approved by :  , **Date:** Sep. 20, 2019
May Chen / Manager

2 Summary of Test Results

47 CFR FCC Part 15, Subpart C (Section 15.247)			
FCC Clause	Test Item	Result	Remarks
15.207	AC Power Conducted Emission	PASS	Meet the requirement of limit. Minimum passing margin is -16.45dB at 0.44297MHz.
15.205 / 15.209 / 15.247(d)	Radiated Emissions Measurement	PASS	Meet the requirement of limit. Minimum passing margin is -9.4dB at 2483.50MHz.
15.247(b)	Conducted power	PASS	Meet the requirement of limit.

Note:

1. Determining compliance based on the results of the compliance measurement, not taking into account measurement instrumentation uncertainty.
2. This report is prepared for FCC Class II permissive change.

2.1 Measurement Uncertainty

Where relevant, the following measurement uncertainty levels have been estimated for tests performed on the EUT as specified in CISPR 16-4-2:

Measurement	Frequency	Expanded Uncertainty (k=2) (\pm)
Conducted Emissions at mains ports	150kHz ~ 30MHz	1.8 dB
Radiated Emissions up to 1 GHz	9kHz ~ 1GHz	3.0 dB
	30MHz ~ 1GHz	5.1 dB
Radiated Emissions above 1 GHz	1GHz ~ 6GHz	5.1 dB
	6GHz ~ 18GHz	5.0 dB
	18GHz ~ 40GHz	5.2 dB

2.2 Modification Record

There were no modifications required for compliance.

3 General Information

3.1 General Description of EUT (BT-LE)

Product	Stand-alone radio module
Brand	u-blox-AG
Test Model	NINA-B3
Status of EUT	ENGINEERING SAMPLE
Power Supply Rating	DC 3.3V from host equipment
Modulation Type	GFSK
Modulation Technology	DTS
Transfer Rate	Up to 2Mbps
Operating Frequency	2.402GHz ~ 2.480GHz
Number of Channel	40
Output Power	BT-LE 1M: 2.223mW BT-LE 2M: 2.218mW
Antenna Type	Refer to Note
Antenna Connector	Refer to Note
Accessory Device	NA
Data Cable Supplied	NA

Note:

- This report is prepared for FCC Class II permissive change. The difference compared with the original design is as the following information:
 - ◆ BLE Module Antenna trace layout design changed and antenna changed.
- According to above conditions, only AC Power Conducted Emission, Radiated Emissions and Conducted power test items need to be performed. And all data were verified to meet the requirements.
- The antennas provided to the EUT, please refer to the following table:

Antenna No.	Brand	Model	Antenna Net Gain (dBi)	Frequency range	Antenna Type	Connector Type	Cable Length
BLE Antenna	u-blox-AG	95XKAB15.G40	3.2	2.4~2.4835GHz	Dipole	i-pex(MHF)	97mm

- Simultaneously transmission condition.

Condition	Technology	
1	BT-LE	WWAN (LTE)

Note: The emission of the simultaneous operation has been evaluated and no non-compliance was found.

- The above EUT information is declared by manufacturer and for more detailed features description, please refer to the manufacturer's specifications or user's manual.

3.2 Description of Test Modes

40 channels are provided to this EUT:

CHANNEL	FREQ. (MHz)	CHANNEL	FREQ. (MHz)	CHANNEL	FREQ. (MHz)	CHANNEL	FREQ. (MHz)
0	2402	10	2422	20	2442	30	2462
1	2404	11	2424	21	2444	31	2464
2	2406	12	2426	22	2446	32	2466
3	2408	13	2428	23	2448	33	2468
4	2410	14	2430	24	2450	34	2470
5	2412	15	2432	25	2452	35	2472
6	2414	16	2434	26	2454	36	2474
7	2416	17	2436	27	2456	37	2476
8	2418	18	2438	28	2458	38	2478
9	2420	19	2440	29	2460	39	2480

3.2.1 Test Mode Applicability and Tested Channel Detail

EUT CONFIGURE MODE	APPLICABLE TO				DESCRIPTION
	RE \geq 1G	RE $<$ 1G	PLC	APCM	
-	√	√	√	√	-

Where **RE \geq 1G**: Radiated Emission above 1GHz & Bandedge Measurement
RE $<$ 1G: Radiated Emission below 1GHz
PLC: Power Line Conducted Emission
APCM: Antenna Port Conducted Measurement

NOTE:

1. The EUT's antenna had been pre-tested on the positioned of each 3 axis. The worst case was found when positioned on **X-plane**.

Radiated Emission Test (Above 1GHz):

- Pre-Scan has been conducted to determine the worst-case mode from all possible combinations between available modulations, data rates and antenna ports (if EUT with antenna diversity architecture).
- Following channel(s) was (were) selected for the final test as listed below.

AVAILABLE CHANNEL	TESTED CHANNEL	MODULATION TYPE	DATA RATE (Mbps)
0 to 39	0, 19, 39	GFSK	1
0 to 39	0, 19, 39	GFSK	2

Radiated Emission Test (Below 1GHz):

- Pre-Scan has been conducted to determine the worst-case mode from all possible combinations between available modulations, data rates and antenna ports (if EUT with antenna diversity architecture).
- Following channel(s) was (were) selected for the final test as listed below.

AVAILABLE CHANNEL	TESTED CHANNEL	MODULATION TYPE	DATA RATE (Mbps)
0 to 39	0	GFSK	1

Power Line Conducted Emission Test:

- Pre-Scan has been conducted to determine the worst-case mode from all possible combinations between available modulations, data rates and antenna ports (if EUT with antenna diversity architecture).
- Following channel(s) was (were) selected for the final test as listed below.

AVAILABLE CHANNEL	TESTED CHANNEL	MODULATION TYPE	DATA RATE (Mbps)
0 to 39	0	GFSK	1

Antenna Port Conducted Measurement:

- Pre-Scan has been conducted to determine the worst-case mode from all possible combinations between available modulations, data rates and antenna ports (if EUT with antenna diversity architecture).
- Following channel(s) was (were) selected for the final test as listed below.

AVAILABLE CHANNEL	TESTED CHANNEL	MODULATION TYPE	DATA RATE (Mbps)
0 to 39	0, 19, 39	GFSK	1
0 to 39	0, 19, 39	GFSK	2

Test Condition:

APPLICABLE TO	ENVIRONMENTAL CONDITIONS	INPUT POWER (SYSTEM)	TESTED BY
RE \geq 1G	23deg. C, 68%RH	120Vac, 60Hz	Tom Yang
RE<1G	23deg. C, 67%RH	120Vac, 60Hz	Tom Yang
PLC	25deg. C, 75%RH	120Vac, 60Hz	Andy Ho
APCM	22deg. C, 63%RH	120Vac, 60Hz	Jyunchun Lin

3.3 Duty Cycle of Test Signal

BT-LE 1M

Duty cycle = $0.387 \text{ ms} / 0.625 \text{ ms} = 0.619$

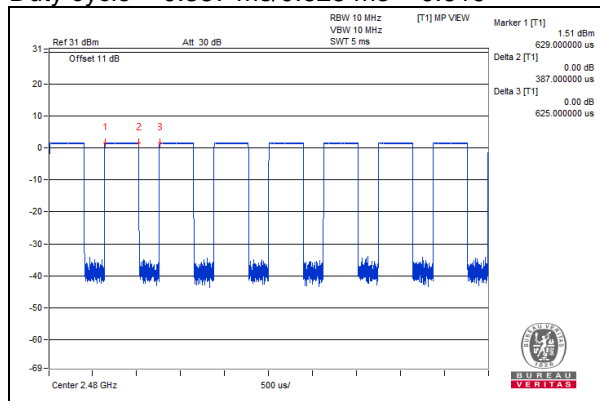

BT-LE 2M

Duty cycle = $0.201 \text{ ms} / 0.629 \text{ ms} = 0.32$

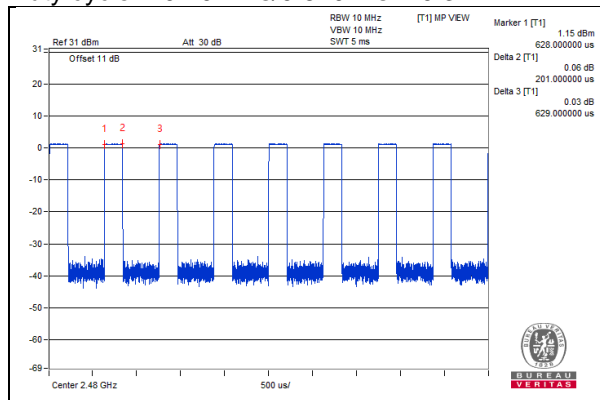

3.4 Description of Support Units

The EUT has been tested as an independent unit together with other necessary accessories or support units. The following support units or accessories were used to form a representative test configuration during the tests.

ID	Product	Brand	Model No.	Serial No.	FCC ID	Remarks
A.	Test Tool	NA	NA	NA	NA	Supplied by client
B.	Laptop	Lenovo	80WG	YD025N5Q	NA	Provided by Lab
C.	DC POWER SUPPLY	Topward	6603D	795551	NA	Provided by Lab

Note:

1. All power cords of the above support units are non-shielded (1.8m).

ID	Descriptions	Qty.	Length (m)	Shielding (Yes/No)	Cores (Qty.)	Remarks
1.	DC Cable	1	1.8	No	0	Provided by Lab
2.	Console Cable	1	0.235	Yes	0	Supplied by client

3.4.1 Configuration of System under Test

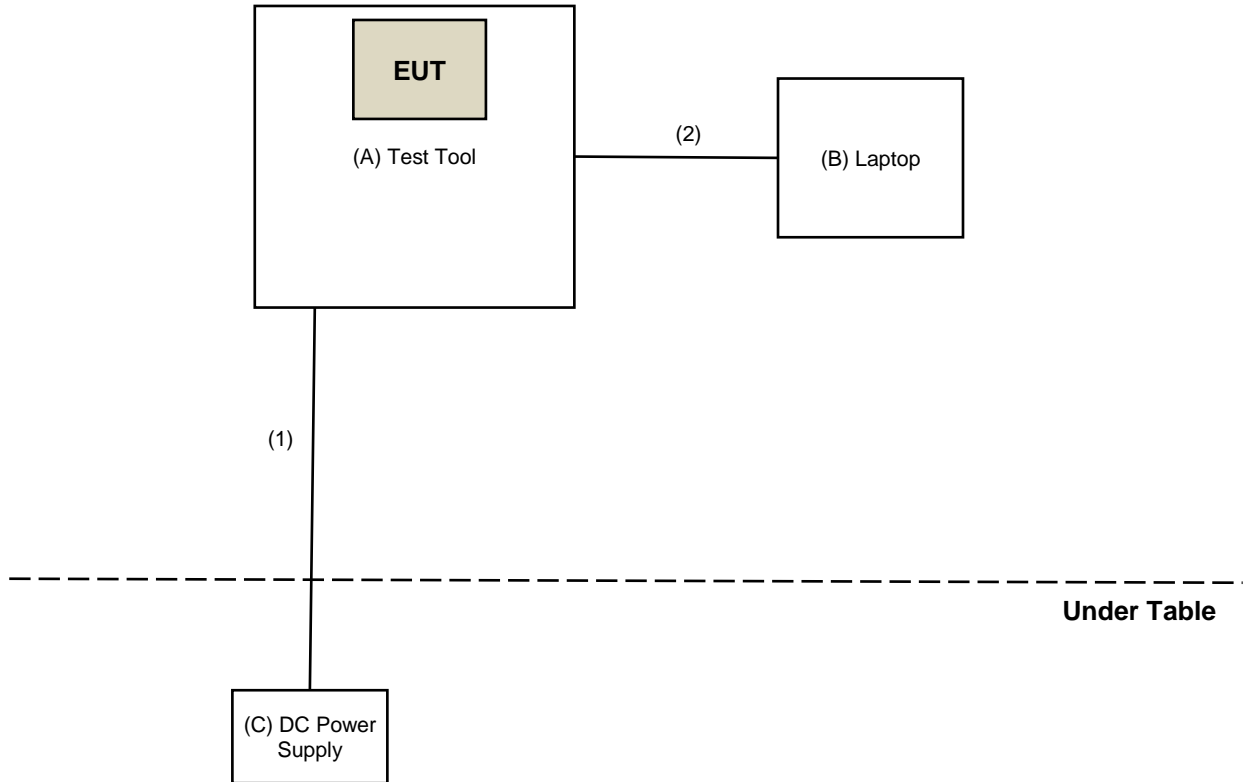

3.5 General Description of Applied Standards

The EUT is a RF Product. According to the specifications of the manufacturer, it must comply with the requirements of the following standards:

FCC Part 15, Subpart C (15.247)

KDB 558074 D01 15.247 Meas Guidance v05r02

ANSI C63.10-2013

All test items have been performed and recorded as per the above standards.

4 Test Types and Results

4.1 Radiated Emission and Bandedge Measurement

4.1.1 Limits of Radiated Emission and Bandedge Measurement

Radiated emissions which fall in the restricted bands must comply with the radiated emission limits specified as below table. Other emissions shall be at least 20dB below the highest level of the desired power:

Frequencies (MHz)	Field Strength (microvolts/meter)	Measurement Distance (meters)
0.009 ~ 0.490	2400/F(kHz)	300
0.490 ~ 1.705	24000/F(kHz)	30
1.705 ~ 30.0	30	30
30 ~ 88	100	3
88 ~ 216	150	3
216 ~ 960	200	3
Above 960	500	3

Note:

1. The lower limit shall apply at the transition frequencies.
2. Emission level (dBuV/m) = 20 log Emission level (uV/m).
3. For frequencies above 1000MHz, the field strength limits are based on average detector, however, the peak field strength of any emission shall not exceed the maximum permitted average limits, specified above by more than 20dB under any condition of modulation.

4.1.2 Test Instruments

DESCRIPTION & MANUFACTURER	MODEL NO.	SERIAL NO.	CALIBRATED DATE	CALIBRATED UNTIL
Test Receiver Agilent	N9038A	MY50010156	July 17, 2019	July 16, 2020
Pre-Amplifier EMCI	EMC001340	980142	May 30, 2019	May 29, 2020
Loop Antenna Electro-Metrics	EM-6879	264	Jan. 22, 2019	Jan. 21, 2020
RF Cable	NA	LOOPCAB-001	Jan. 14, 2019	Jan. 13, 2020
RF Cable	NA	LOOPCAB-002	Jan. 14, 2019	Jan. 13, 2020
Pre-Amplifier Mini-Circuits	ZFL-1000VH2B	AMP-ZFL-05	Apr. 30, 2019	Apr. 29, 2020
Trilog Broadband Antenna SCHWARZBECK	VULB 9168	9168-361	Nov. 22, 2018	Nov. 21, 2019
RF Cable	8D	966-3-1	Mar. 18, 2019	Mar. 17, 2020
RF Cable	8D	966-3-2	Mar. 18, 2019	Mar. 17, 2020
RF Cable	8D	966-3-3	Mar. 18, 2019	Mar. 17, 2020
Fixed attenuator Mini-Circuits	UNAT-5+	PAD-3m-3-01	Sep. 27, 2018	Sep. 26, 2019
Horn_Antenna SCHWARZBECK	BBHA9120-D	9120D-406	Nov. 25, 2018	Nov. 24, 2019
Pre-Amplifier EMCI	EMC12630SE	980384	Jan. 28, 2019	Jan. 27, 2020
RF Cable	EMC104-SM-SM-1200	160922	Jan. 28, 2019	Jan. 27, 2020
RF Cable	EMC104-SM-SM-2000	180601	June 10, 2019	June 09, 2020
RF Cable	EMC104-SM-SM-6000	180602	June 10, 2019	June 09, 2020
Spectrum Analyzer Keysight	N9030A	MY54490679	July 17, 2019	July 16, 2020
Pre-Amplifier EMCI	EMC184045SE	980387	Jan. 28, 2019	Jan. 27, 2020
Horn_Antenna SCHWARZBECK	BBHA 9170	BBHA9170519	Nov. 25, 2018	Nov. 24, 2019
RF Cable	EMC102-KM-KM-1200	160924	Jan. 28, 2019	Jan. 27, 2020
RF Cable	EMC102-KM-KM-1200	160925	Jan. 28, 2019	Jan. 27, 2020
Software	ADT_Radiated_V8.7.08	NA	NA	NA
Antenna Tower & Turn Table Max-Full	MF-7802	MF780208406	NA	NA
Boresight Antenna Fixture	FBA-01	FBA-SIP01	NA	NA
Spectrum Analyzer R&S	FSV40	100964	June 04, 2019	June 03, 2020
Power meter Anritsu	ML2495A	1014008	May 13, 2019	May 12, 2020
Power sensor Anritsu	MA2411B	0917122	May 13, 2019	May 12, 2020

Note:

1. The calibration interval of the above test instruments is 12 months and the calibrations are traceable to NML/ROC and NIST/USA.
2. The test was performed in 966 Chamber No. 3.
3. Loop antenna was used for all emissions below 30 MHz.
4. Tested Date: Aug. 30 to Sep. 02, 2019

4.1.3 Test Procedures

For Radiated emission below 30MHz

- a. The EUT was placed on the top of a rotating table 0.8 meters above the ground at a 3 meter chamber room. The table was rotated 360 degrees to determine the position of the highest radiation.
- b. The EUT was set 3 meters away from the interference-receiving antenna, which was mounted on the top of a variable-height antenna tower.
- c. Parallel, perpendicular, and ground-parallel orientations of the antenna are set to make the measurement.
- d. For each suspected emission, the EUT was arranged to its worst case and the rotatable table was turned from 0 degrees to 360 degrees to find the maximum reading.
- e. The test-receiver system was set to Quasi-Peak Detect Function and Specified Bandwidth with Maximum Hold Mode.

Note:

1. The resolution bandwidth and video bandwidth of test receiver/spectrum analyzer is 9kHz at frequency below 30MHz.

For Radiated emission above 30MHz

- a. The EUT was placed on the top of a rotating table 0.8 meters (for 30MHz ~ 1GHz) / 1.5 meters (for above 1GHz) above the ground at 3 meter chamber room for test. The table was rotated 360 degrees to determine the position of the highest radiation.
- b. The EUT was set 3 meters away from the interference-receiving antenna, which was mounted on the top of a variable-height antenna tower.
- c. The height of antenna is varied from one meter to four meters above the ground to determine the maximum value of the field strength. Both horizontal and vertical polarizations of the antenna are set to make the measurement.
- d. For each suspected emission, the EUT was arranged to its worst case and then the antenna was tuned to heights from 1 meter to 4 meters and the rotatable table was turned from 0 degrees to 360 degrees to find the maximum reading.
- e. The test-receiver system was set to quasi-peak detect function and specified bandwidth with maximum hold mode when the test frequency is below 1 GHz.
- f. The test-receiver system was set to peak and average detects function and specified bandwidth with maximum hold mode when the test frequency is above 1 GHz. If the peak reading value also meets average limit, measurement with the average detector is unnecessary.

Note:

1. The resolution bandwidth and video bandwidth of test receiver/spectrum analyzer is 120kHz for Quasi-peak detection (QP) at frequency below 1GHz.
2. The resolution bandwidth of test receiver/spectrum analyzer is 1 MHz and the video bandwidth is 3 MHz for Peak detection (PK) at frequency above 1GHz.
3. The resolution bandwidth of test receiver/spectrum analyzer is 1MHz and the video bandwidth is $\geq 1/T$ (Duty cycle < 98%) or 10Hz (Duty cycle $\geq 98\%$) for Average detection (AV) at frequency above 1GHz.
4. All modes of operation were investigated and the worst-case emissions are reported.

4.1.4 Deviation from Test Standard

No deviation.

4.1.5 Test Setup

For Radiated emission below 30MHz

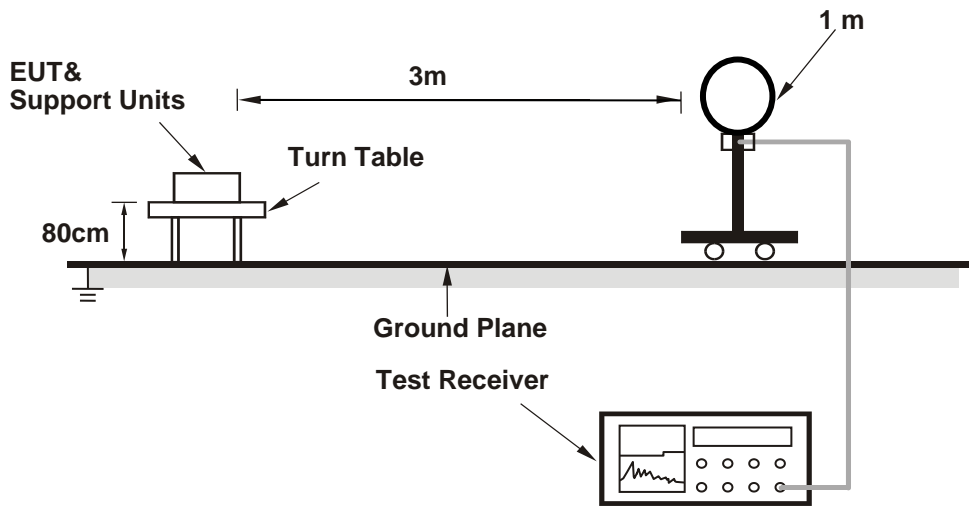

For Radiated emission 30MHz to 1GHz

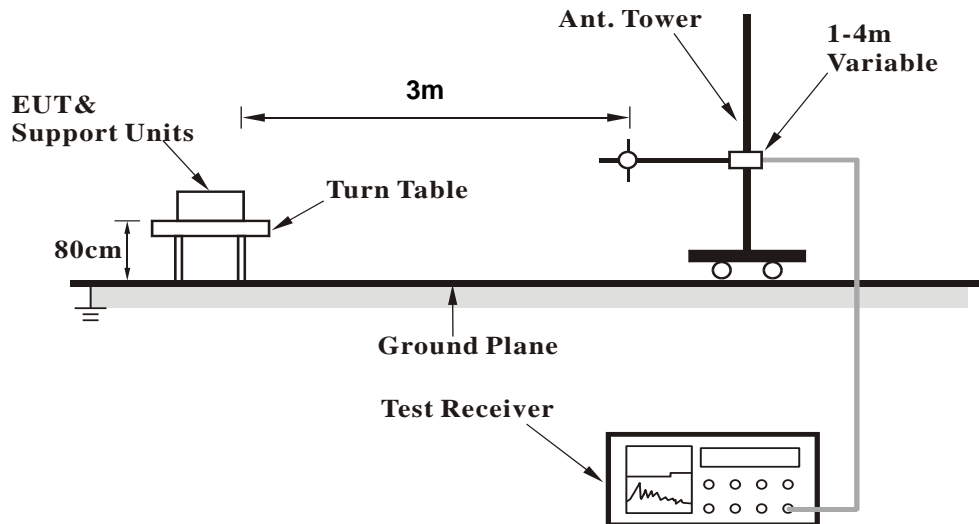

For Radiated emission above 1GHz

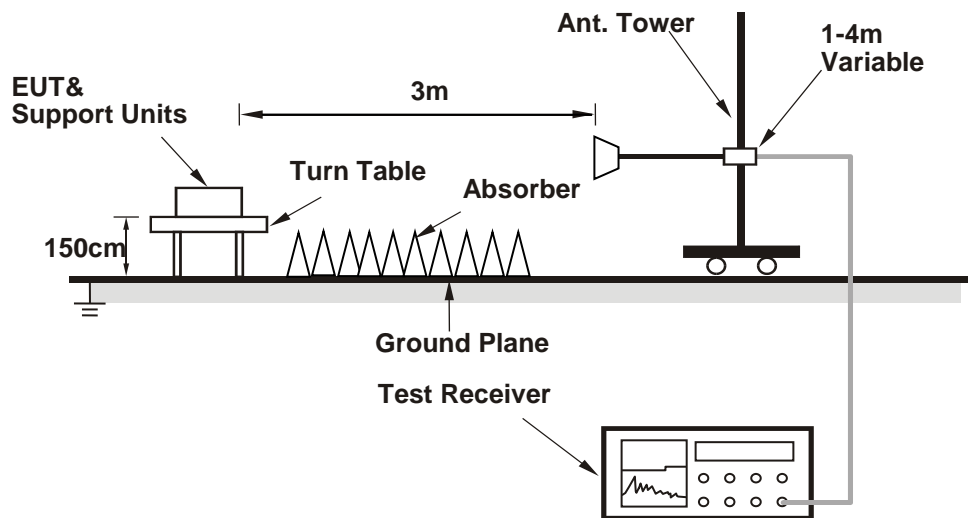

For the actual test configuration, please refer to the attached file (Test Setup Photo).

4.1.6 EUT Operating Conditions

- a. Placed the EUT on the testing table.
- b. Controlling software (HyperTerminal paste BB8 BLE SOP.doc command) has been activated to set the EUT on specific status.

4.1.7 Test Results

BT-LE 1M

Above 1GHz Data:

CHANNEL	TX Channel 0	DETECTOR FUNCTION	Peak (PK)
FREQUENCY RANGE	1GHz ~ 25GHz		Average (AV)

ANTENNA POLARITY & TEST DISTANCE: HORIZONTAL AT 3 M

NO.	FREQ. (MHz)	EMISSION LEVEL (dBuV/m)	LIMIT (dBuV/m)	MARGIN (dB)	ANTENNA HEIGHT (m)	TABLE ANGLE (Degree)	RAW VALUE (dBuV)	CORRECTION FACTOR (dB/m)
1	2390.00	55.4 PK	74.0	-18.6	2.18 H	128	57.4	-2.0
2	2390.00	43.6 AV	54.0	-10.4	2.18 H	128	45.6	-2.0
3	*2402.00	94.4 PK			2.18 H	128	96.4	-2.0
4	*2402.00	92.7 AV			2.18 H	128	94.7	-2.0
5	4804.00	41.4 PK	74.0	-32.6	2.04 H	123	39.1	2.3
6	4804.00	31.5 AV	54.0	-22.5	2.04 H	123	29.2	2.3

ANTENNA POLARITY & TEST DISTANCE: VERTICAL AT 3 M

NO.	FREQ. (MHz)	EMISSION LEVEL (dBuV/m)	LIMIT (dBuV/m)	MARGIN (dB)	ANTENNA HEIGHT (m)	TABLE ANGLE (Degree)	RAW VALUE (dBuV)	CORRECTION FACTOR (dB/m)
1	2390.00	55.2 PK	74.0	-18.8	1.73 V	148	57.2	-2.0
2	2390.00	43.4 AV	54.0	-10.6	1.73 V	148	45.4	-2.0
3	*2402.00	99.3 PK			1.73 V	148	101.3	-2.0
4	*2402.00	97.8 AV			1.73 V	148	99.8	-2.0
5	4804.00	43.0 PK	74.0	-31.0	1.05 V	203	40.7	2.3
6	4804.00	34.4 AV	54.0	-19.6	1.05 V	203	32.1	2.3

REMARKS:

1. Emission Level(dBuV/m) = Raw Value(dBuV) + Correction Factor(dB/m)
2. Correction Factor(dB/m) = Antenna Factor(dB/m) + Cable Factor(dB) – Pre-Amplifier Factor(dB)
3. Margin value = Emission Level – Limit value
4. The other emission levels were very low against the limit.
5. " * ": Fundamental frequency.

CHANNEL	TX Channel 19	DETECTOR FUNCTION	Peak (PK)
FREQUENCY RANGE	1GHz ~ 25GHz		Average (AV)

ANTENNA POLARITY & TEST DISTANCE: HORIZONTAL AT 3 M

NO.	FREQ. (MHz)	EMISSION LEVEL (dBuV/m)	LIMIT (dBuV/m)	MARGIN (dB)	ANTENNA HEIGHT (m)	TABLE ANGLE (Degree)	RAW VALUE (dBuV)	CORRECTION FACTOR (dB/m)
1	2390.00	54.7 PK	74.0	-19.3	2.04 H	134	56.7	-2.0
2	2390.00	43.5 AV	54.0	-10.5	2.04 H	134	45.5	-2.0
3	*2440.00	92.4 PK			2.04 H	134	94.5	-2.1
4	*2440.00	90.1 AV			2.04 H	134	92.2	-2.1
5	2483.50	54.3 PK	74.0	-19.7	2.04 H	134	56.5	-2.2
6	2483.50	42.6 AV	54.0	-11.4	2.04 H	134	44.8	-2.2
7	4880.00	40.9 PK	74.0	-33.1	1.98 H	153	38.6	2.3
8	4880.00	31.0 AV	54.0	-23.0	1.98 H	153	28.7	2.3
9	7320.00	44.5 PK	74.0	-29.5	1.48 H	154	36.3	8.2
10	7320.00	33.6 AV	54.0	-20.4	1.48 H	154	25.4	8.2

ANTENNA POLARITY & TEST DISTANCE: VERTICAL AT 3 M

NO.	FREQ. (MHz)	EMISSION LEVEL (dBuV/m)	LIMIT (dBuV/m)	MARGIN (dB)	ANTENNA HEIGHT (m)	TABLE ANGLE (Degree)	RAW VALUE (dBuV)	CORRECTION FACTOR (dB/m)
1	2390.00	55.1 PK	74.0	-18.9	1.48 V	149	57.1	-2.0
2	2390.00	43.3 AV	54.0	-10.7	1.48 V	149	45.3	-2.0
3	*2440.00	97.9 PK			1.48 V	149	100.0	-2.1
4	*2440.00	96.4 AV			1.48 V	149	98.5	-2.1
5	2483.50	54.2 PK	74.0	-19.8	1.48 V	149	56.4	-2.2
6	2483.50	43.0 AV	54.0	-11.0	1.48 V	149	45.2	-2.2
7	4880.00	41.3 PK	74.0	-32.7	1.53 V	212	39.0	2.3
8	4880.00	33.0 AV	54.0	-21.0	1.53 V	212	30.7	2.3
9	7320.00	44.4 PK	74.0	-29.6	1.87 V	192	36.2	8.2
10	7320.00	35.3 AV	54.0	-18.7	1.87 V	192	27.1	8.2

REMARKS:

1. Emission Level(dBuV/m) = Raw Value(dBuV) + Correction Factor(dB/m)
2. Correction Factor(dB/m) = Antenna Factor(dB/m) + Cable Factor(dB) – Pre-Amplifier Factor(dB)
3. Margin value = Emission Level – Limit value
4. The other emission levels were very low against the limit.
5. " * ": Fundamental frequency.

CHANNEL	TX Channel 39	DETECTOR FUNCTION	Peak (PK)
FREQUENCY RANGE	1GHz ~ 25GHz		Average (AV)

ANTENNA POLARITY & TEST DISTANCE: HORIZONTAL AT 3 M

NO.	FREQ. (MHz)	EMISSION LEVEL (dBuV/m)	LIMIT (dBuV/m)	MARGIN (dB)	ANTENNA HEIGHT (m)	TABLE ANGLE (Degree)	RAW VALUE (dBuV)	CORRECTION FACTOR (dB/m)
1	*2480.00	91.3 PK			2.15 H	134	93.5	-2.2
2	*2480.00	89.4 AV			2.15 H	134	91.6	-2.2
3	2483.50	54.8 PK	74.0	-19.2	2.15 H	134	57.0	-2.2
4	2483.50	42.3 AV	54.0	-11.7	2.15 H	134	44.5	-2.2
5	4960.00	41.2 PK	74.0	-32.8	2.20 H	135	38.7	2.5
6	4960.00	32.9 AV	54.0	-21.1	2.20 H	135	30.4	2.5
7	7440.00	44.8 PK	74.0	-29.2	1.53 H	142	36.4	8.4
8	7440.00	33.4 AV	54.0	-20.6	1.53 H	142	25.0	8.4

ANTENNA POLARITY & TEST DISTANCE: VERTICAL AT 3 M

NO.	FREQ. (MHz)	EMISSION LEVEL (dBuV/m)	LIMIT (dBuV/m)	MARGIN (dB)	ANTENNA HEIGHT (m)	TABLE ANGLE (Degree)	RAW VALUE (dBuV)	CORRECTION FACTOR (dB/m)
1	*2480.00	97.8 PK			2.31 V	140	100.0	-2.2
2	*2480.00	96.3 AV			2.31 V	140	98.5	-2.2
3	2483.50	54.1 PK	74.0	-19.9	2.31 V	140	56.3	-2.2
4	2483.50	43.1 AV	54.0	-10.9	2.31 V	140	45.3	-2.2
5	4960.00	42.7 PK	74.0	-31.3	1.19 V	199	40.2	2.5
6	4960.00	34.6 AV	54.0	-19.4	1.19 V	199	32.1	2.5
7	7440.00	44.3 PK	74.0	-29.7	1.33 V	186	35.9	8.4
8	7440.00	34.2 AV	54.0	-19.8	1.33 V	186	25.8	8.4

REMARKS:

1. Emission Level(dBuV/m) = Raw Value(dBuV) + Correction Factor(dB/m)
2. Correction Factor(dB/m) = Antenna Factor(dB/m) + Cable Factor(dB) – Pre-Amplifier Factor(dB)
3. The other emission levels were very low against the limit.
4. Margin value = Emission Level – Limit value
5. " * ": Fundamental frequency.

Below 1GHz Data:

CHANNEL	TX Channel 0	DETECTOR FUNCTION	Quasi-Peak (QP)
FREQUENCY RANGE	9kHz ~ 1GHz		

ANTENNA POLARITY & TEST DISTANCE: HORIZONTAL AT 3 M								
NO.	FREQ. (MHz)	EMISSION LEVEL (dBuV/m)	LIMIT (dBuV/m)	MARGIN (dB)	ANTENNA HEIGHT (m)	TABLE ANGLE (Degree)	RAW VALUE (dBuV)	CORRECTION FACTOR (dB/m)
1	49.96	30.0 QP	40.0	-10.0	1.00 H	46	38.6	-8.6
2	128.65	25.4 QP	43.5	-18.1	3.00 H	210	34.8	-9.4
3	193.69	24.7 QP	43.5	-18.8	1.00 H	360	34.7	-10.0
4	326.43	26.7 QP	46.0	-19.3	1.00 H	43	32.3	-5.6
5	466.89	29.2 QP	46.0	-16.8	2.00 H	360	31.6	-2.4
6	616.27	31.7 QP	46.0	-14.3	1.00 H	360	30.5	1.2

REMARKS:

1. Emission Level(dBuV/m) = Raw Value(dBuV) + Correction Factor(dB/m)
2. Correction Factor(dB/m) = Antenna Factor(dB/m) + Cable Factor(dB) – Pre-Amplifier Factor(dB)
3. Margin value = Emission Level – Limit value
4. The other emission levels were very low against the limit of frequency range 30MHz~1000MHz.
5. The emission levels were very low against the limit of frequency range 9kHz~30MHz: the amplitude of spurious emissions attenuated more than 20 dB below the permissible value to be report.

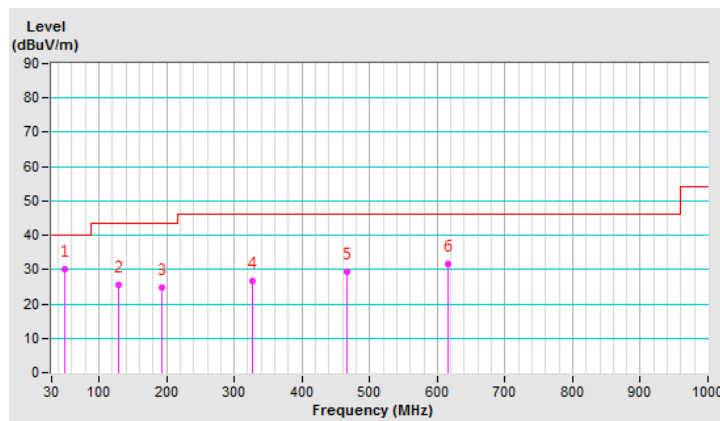

CHANNEL	TX Channel 0	DETECTOR FUNCTION	Quasi-Peak (QP)
FREQUENCY RANGE	9kHz ~ 1GHz		

ANTENNA POLARITY & TEST DISTANCE: VERTICAL AT 3 M

NO.	FREQ. (MHz)	EMISSION LEVEL (dBuV/m)	LIMIT (dBuV/m)	MARGIN (dB)	ANTENNA HEIGHT (m)	TABLE ANGLE (Degree)	RAW VALUE (dBuV)	CORRECTION FACTOR (dB/m)
1	39.82	30.1 QP	40.0	-9.9	1.00 V	360	39.4	-9.3
2	62.98	27.4 QP	40.0	-12.6	1.50 V	360	36.3	-8.9
3	139.22	26.4 QP	43.5	-17.1	1.00 V	160	34.7	-8.3
4	267.67	25.0 QP	46.0	-21.0	1.00 V	133	32.6	-7.6
5	471.03	29.7 QP	46.0	-16.3	1.50 V	86	32.0	-2.3
6	621.12	32.8 QP	46.0	-13.2	1.50 V	101	31.5	1.3

REMARKS:

1. Emission Level(dBuV/m) = Raw Value(dBuV) + Correction Factor(dB/m)
2. Correction Factor(dB/m) = Antenna Factor(dB/m) + Cable Factor(dB) – Pre-Amplifier Factor(dB)
3. Margin value = Emission Level – Limit value
4. The other emission levels were very low against the limit of frequency range 30MHz~1000MHz.
5. The emission levels were very low against the limit of frequency range 9kHz~30MHz: the amplitude of spurious emissions attenuated more than 20 dB below the permissible value to be report.

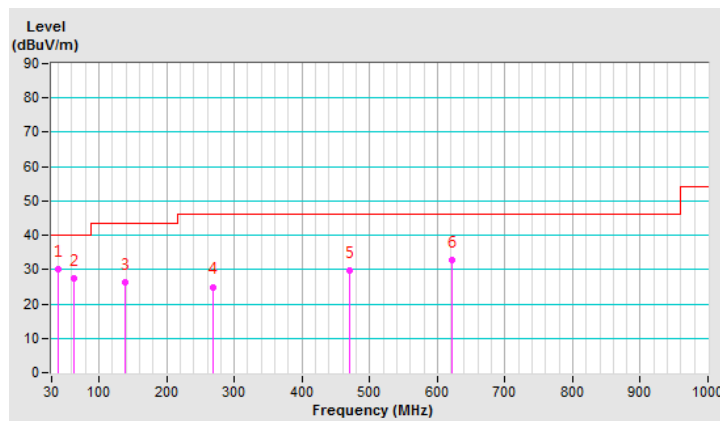

BT-LE 2M
Above 1GHz Data:

CHANNEL	TX Channel 0	DETECTOR FUNCTION	Peak (PK)
FREQUENCY RANGE	1GHz ~ 25GHz		Average (AV)

ANTENNA POLARITY & TEST DISTANCE: HORIZONTAL AT 3 M

NO.	FREQ. (MHz)	EMISSION LEVEL (dBuV/m)	LIMIT (dBuV/m)	MARGIN (dB)	ANTENNA HEIGHT (m)	TABLE ANGLE (Degree)	RAW VALUE (dBuV)	CORRECTION FACTOR (dB/m)
1	2390.00	53.8 PK	74.0	-20.2	2.77 H	103	55.8	-2.0
2	2390.00	44.1 AV	54.0	-9.9	2.77 H	103	46.1	-2.0
3	*2402.00	92.2 PK			2.77 H	103	94.2	-2.0
4	*2402.00	88.4 AV			2.77 H	103	90.4	-2.0
5	4804.00	43.4 PK	74.0	-30.6	2.05 H	220	41.1	2.3
6	4804.00	34.4 AV	54.0	-19.6	2.05 H	220	32.1	2.3

ANTENNA POLARITY & TEST DISTANCE: VERTICAL AT 3 M

NO.	FREQ. (MHz)	EMISSION LEVEL (dBuV/m)	LIMIT (dBuV/m)	MARGIN (dB)	ANTENNA HEIGHT (m)	TABLE ANGLE (Degree)	RAW VALUE (dBuV)	CORRECTION FACTOR (dB/m)
1	2390.00	54.4 PK	74.0	-19.6	1.94 V	158	56.4	-2.0
2	2390.00	44.3 AV	54.0	-9.7	1.94 V	158	46.3	-2.0
3	*2402.00	99.7 PK			1.94 V	158	101.7	-2.0
4	*2402.00	96.9 AV			1.94 V	158	98.9	-2.0
5	4804.00	43.6 PK	74.0	-30.4	1.85 V	212	41.3	2.3
6	4804.00	35.3 AV	54.0	-18.7	1.85 V	212	33.0	2.3

REMARKS:

1. Emission Level(dBuV/m) = Raw Value(dBuV) + Correction Factor(dB/m)
2. Correction Factor(dB/m) = Antenna Factor(dB/m) + Cable Factor(dB) – Pre-Amplifier Factor(dB)
3. Margin value = Emission Level – Limit value
4. The other emission levels were very low against the limit.
5. " * ": Fundamental frequency.

CHANNEL	TX Channel 19	DETECTOR FUNCTION	Peak (PK)
FREQUENCY RANGE	1GHz ~ 25GHz		Average (AV)

ANTENNA POLARITY & TEST DISTANCE: HORIZONTAL AT 3 M

NO.	FREQ. (MHz)	EMISSION LEVEL (dBuV/m)	LIMIT (dBuV/m)	MARGIN (dB)	ANTENNA HEIGHT (m)	TABLE ANGLE (Degree)	RAW VALUE (dBuV)	CORRECTION FACTOR (dB/m)
1	2390.00	55.4 PK	74.0	-18.6	2.86 H	95	57.4	-2.0
2	2390.00	44.1 AV	54.0	-9.9	2.86 H	95	46.1	-2.0
3	*2440.00	91.7 PK			2.86 H	95	93.8	-2.1
4	*2440.00	87.8 AV			2.86 H	95	89.9	-2.1
5	2483.50	54.3 PK	74.0	-19.7	2.86 H	95	56.5	-2.2
6	2483.50	43.6 AV	54.0	-10.4	2.86 H	95	45.8	-2.2
7	4880.00	43.0 PK	74.0	-31.0	2.16 H	197	40.7	2.3
8	4880.00	34.1 AV	54.0	-19.9	2.16 H	197	31.8	2.3
9	7320.00	43.3 PK	74.0	-30.7	1.80 H	166	35.1	8.2
10	7320.00	33.3 AV	54.0	-20.7	1.80 H	166	25.1	8.2

ANTENNA POLARITY & TEST DISTANCE: VERTICAL AT 3 M

NO.	FREQ. (MHz)	EMISSION LEVEL (dBuV/m)	LIMIT (dBuV/m)	MARGIN (dB)	ANTENNA HEIGHT (m)	TABLE ANGLE (Degree)	RAW VALUE (dBuV)	CORRECTION FACTOR (dB/m)
1	2390.00	56.3 PK	74.0	-17.7	2.47 V	148	58.3	-2.0
2	2390.00	44.2 AV	54.0	-9.8	2.47 V	148	46.2	-2.0
3	*2440.00	99.3 PK			2.47 V	148	101.4	-2.1
4	*2440.00	96.4 AV			2.47 V	148	98.5	-2.1
5	2483.50	54.9 PK	74.0	-19.1	2.47 V	148	57.1	-2.2
6	2483.50	43.6 AV	54.0	-10.4	2.47 V	148	45.8	-2.2
7	4880.00	43.4 PK	74.0	-30.6	1.62 V	188	41.1	2.3
8	4880.00	35.1 AV	54.0	-18.9	1.62 V	188	32.8	2.3
9	7320.00	44.0 PK	74.0	-30.0	1.50 V	173	35.8	8.2
10	7320.00	34.1 AV	54.0	-19.9	1.50 V	173	25.9	8.2

REMARKS:

1. Emission Level(dBuV/m) = Raw Value(dBuV) + Correction Factor(dB/m)
2. Correction Factor(dB/m) = Antenna Factor(dB/m) + Cable Factor(dB) – Pre-Amplifier Factor(dB)
3. Margin value = Emission Level – Limit value
4. The other emission levels were very low against the limit.
5. " * ": Fundamental frequency.

CHANNEL	TX Channel 39	DETECTOR FUNCTION	Peak (PK)
FREQUENCY RANGE	1GHz ~ 25GHz		Average (AV)

ANTENNA POLARITY & TEST DISTANCE: HORIZONTAL AT 3 M

NO.	FREQ. (MHz)	EMISSION LEVEL (dBuV/m)	LIMIT (dBuV/m)	MARGIN (dB)	ANTENNA HEIGHT (m)	TABLE ANGLE (Degree)	RAW VALUE (dBuV)	CORRECTION FACTOR (dB/m)
1	*2480.00	89.4 PK			2.89 H	88	91.6	-2.2
2	*2480.00	85.1 AV			2.89 H	88	87.3	-2.2
3	2483.50	54.9 PK	74.0	-19.1	2.89 H	88	57.1	-2.2
4	2483.50	44.3 AV	54.0	-9.7	2.89 H	88	46.5	-2.2
5	4960.00	43.2 PK	74.0	-30.8	1.42 H	222	40.7	2.5
6	4960.00	33.3 AV	54.0	-20.7	1.42 H	222	30.8	2.5
7	7440.00	43.1 PK	74.0	-30.9	1.73 H	178	34.7	8.4
8	7440.00	32.8 AV	54.0	-21.2	1.73 H	178	24.4	8.4

ANTENNA POLARITY & TEST DISTANCE: VERTICAL AT 3 M

NO.	FREQ. (MHz)	EMISSION LEVEL (dBuV/m)	LIMIT (dBuV/m)	MARGIN (dB)	ANTENNA HEIGHT (m)	TABLE ANGLE (Degree)	RAW VALUE (dBuV)	CORRECTION FACTOR (dB/m)
1	*2480.00	97.5 PK			2.29 V	153	99.7	-2.2
2	*2480.00	94.1 AV			2.29 V	153	96.3	-2.2
3	2483.50	54.5 PK	74.0	-19.5	2.29 V	153	56.7	-2.2
4	2483.50	44.6 AV	54.0	-9.4	2.29 V	153	46.8	-2.2
5	4960.00	43.5 PK	74.0	-30.5	1.50 V	202	41.0	2.5
6	4960.00	34.7 AV	54.0	-19.3	1.50 V	202	32.2	2.5
7	7440.00	44.3 PK	74.0	-29.7	1.68 V	186	35.9	8.4
8	7440.00	34.2 AV	54.0	-19.8	1.68 V	186	25.8	8.4

REMARKS:

1. Emission Level(dBuV/m) = Raw Value(dBuV) + Correction Factor(dB/m)
2. Correction Factor(dB/m) = Antenna Factor(dB/m) + Cable Factor(dB) – Pre-Amplifier Factor(dB)
3. The other emission levels were very low against the limit.
4. Margin value = Emission Level – Limit value
5. " * ": Fundamental frequency.

4.2 Conducted Emission Measurement

4.2.1 Limits of Conducted Emission Measurement

Frequency (MHz)	Conducted Limit (dBuV)	
	Quasi-peak	Average
0.15 - 0.5	66 - 56	56 - 46
0.50 - 5.0	56	46
5.0 - 30.0	60	50

Note: 1. The lower limit shall apply at the transition frequencies.

2. The limit decreases in line with the logarithm of the frequency in the range of 0.15 to 0.50MHz.

4.2.2 Test Instruments

DESCRIPTION & MANUFACTURER	MODEL NO.	SERIAL NO.	CALIBRATED DATE	CALIBRATED UNTIL
Test Receiver R&S	ESCS 30	847124/029	Oct. 24, 2018	Oct. 23, 2019
Line-Impedance Stabilization Network (for EUT) R&S	ESH3-Z5	848773/004	Oct. 22, 2018	Oct. 21, 2019
Line-Impedance Stabilization Network (for Peripheral) R&S	ESH3-Z5	835239/001	Mar. 17, 2019	Mar. 16, 2020
50 ohms Terminator	N/A	3	Oct. 22, 2018	Oct. 21, 2019
RF Cable	5D-FB	COCCAB-001	Sep. 28, 2018	Sep. 27, 2019
Fixed attenuator EMCI	STI02-2200-10	003	Mar. 14, 2019	Mar. 13, 2020
Software BVADT	BVADT_Cond_ V7.3.7.4	NA	NA	NA

Note:

1. The calibration interval of the above test instruments are 12 months and the calibrations are traceable to NML/ROC and NIST/USA.
2. The test was performed in Conduction 1.
3. Tested Date: Sep. 02, 2019

4.2.3 Test Procedures

- The EUT was placed 0.4 meters from the conducting wall of the shielded room with EUT being connected to the power mains through a line impedance stabilization network (LISN). Other support units were connected to the power mains through another LISN. The two LISNs provide 50 ohm/ 50uH of coupling impedance for the measuring instrument.
- Both lines of the power mains connected to the EUT were checked for maximum conducted interference.
- The frequency range from 150kHz to 30MHz was searched. Emission levels under (Limit - 20dB) was not recorded.

Note: The resolution bandwidth and video bandwidth of test receiver is 9kHz for quasi-peak detection (QP) and average detection (AV) at frequency 0.15MHz-30MHz.

4.2.4 Deviation from Test Standard

No deviation.

4.2.5 Test Setup

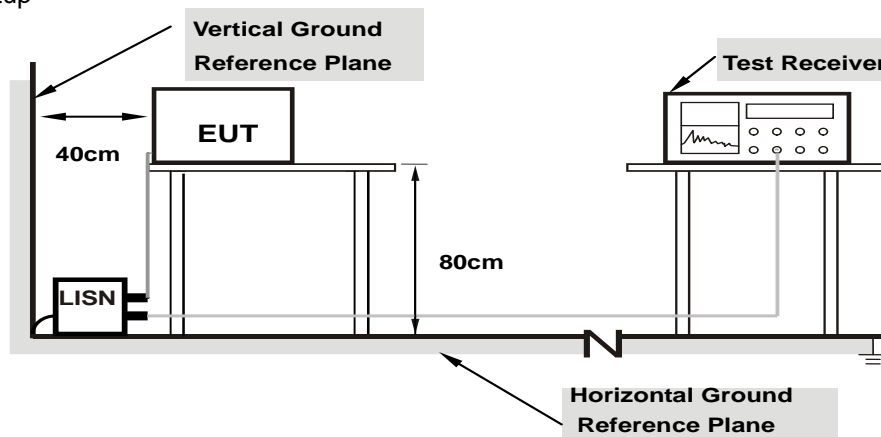

Note: 1.Support units were connected to second LISN.

For the actual test configuration, please refer to the attached file (Test Setup Photo).

4.2.6 EUT Operating Conditions

Same as 4.1.6.

4.2.7 Test Results

Phase	Line (L)	Detector Function	Quasi-Peak (QP) / Average (AV)
-------	----------	-------------------	--------------------------------

No	Freq. [MHz]	Corr.	Reading Value		Emission Level		Limit		Margin	
		Factor (dB)	[dB (uV)]		[dB (uV)]		[dB (uV)]		(dB)	
		Q.P.	AV.	Q.P.	AV.	Q.P.	AV.	Q.P.	AV.	Q.P.
1	0.44297	9.97	26.25	20.59	36.22	30.56	57.01	47.01	-20.79	-16.45
2	1.69922	10.05	12.40	5.56	22.45	15.61	56.00	46.00	-33.55	-30.39
3	8.48047	10.40	13.56	5.70	23.96	16.10	60.00	50.00	-36.04	-33.90
4	9.28125	10.44	18.99	10.54	29.43	20.98	60.00	50.00	-30.57	-29.02
5	10.14453	10.49	20.39	9.06	30.88	19.55	60.00	50.00	-29.12	-30.45
6	14.43359	10.73	20.91	5.55	31.64	16.28	60.00	50.00	-28.36	-33.72

Remarks:

1. Q.P. and AV. are abbreviations of quasi-peak and average individually.
2. The emission levels of other frequencies were very low against the limit.
3. Margin value = Emission level – Limit value
4. Correction factor = Insertion loss + Cable loss
5. Emission Level = Correction Factor + Reading Value

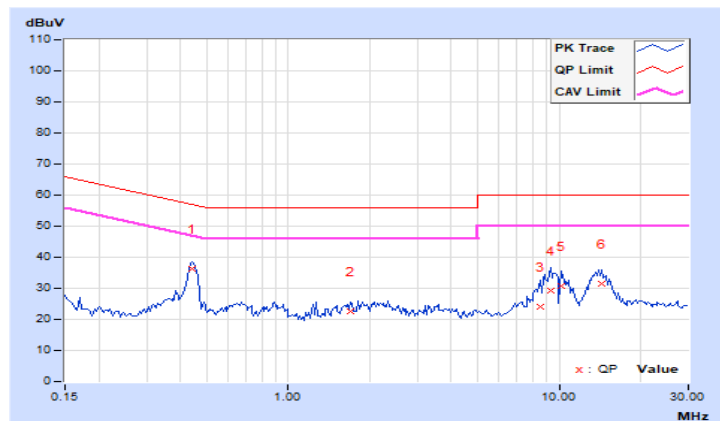

Phase	Neutral (N)	Detector Function	Quasi-Peak (QP) / Average (AV)
-------	-------------	-------------------	-----------------------------------

No	Freq. [MHz]	Corr.	Reading Value		Emission Level		Limit		Margin	
		Factor (dB)	[dB (uV)]		[dB (uV)]		[dB (uV)]		(dB)	
	Q.P.	AV.	Q.P.	AV.	Q.P.	AV.	Q.P.	AV.	Q.P.	AV.
1	0.44688	9.95	26.44	19.19	36.39	29.14	56.93	46.93	-20.54	-17.79
2	4.59375	10.14	1.74	-4.79	11.88	5.35	56.00	46.00	-44.12	-40.65
3	7.65234	10.27	7.77	1.75	18.04	12.02	60.00	50.00	-41.96	-37.98
4	9.81250	10.36	20.35	10.78	30.71	21.14	60.00	50.00	-29.29	-28.86
5	14.36719	10.55	21.24	5.98	31.79	16.53	60.00	50.00	-28.21	-33.47
6	21.23828	10.81	4.79	0.62	15.60	11.43	60.00	50.00	-44.40	-38.57

Remarks:

1. Q.P. and AV. are abbreviations of quasi-peak and average individually.
2. The emission levels of other frequencies were very low against the limit.
3. Margin value = Emission level – Limit value
4. Correction factor = Insertion loss + Cable loss
5. Emission Level = Correction Factor + Reading Value

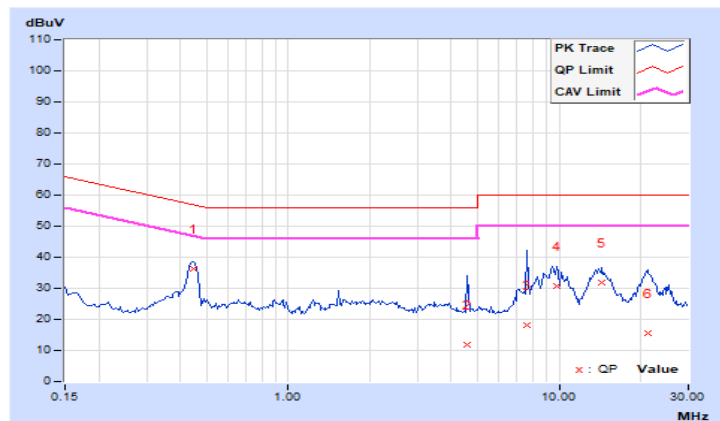

4.3 Conducted Output Power Measurement

4.3.1 Limits of Conducted Output Power Measurement

For systems using digital modulation in the 2400–2483.5 MHz bands: 1 Watt (30dBm)

4.3.2 Test Setup

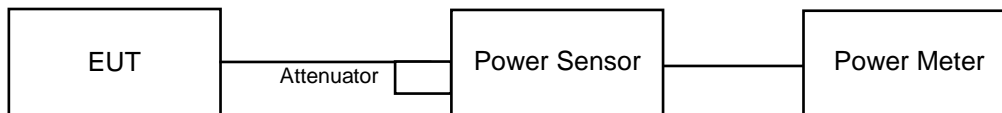

4.3.3 Test Instruments

Refer to section 4.1.2 to get information of above instrument.

4.3.4 Test Procedures

A peak power sensor was used on the output port of the EUT. A power meter was used to read the response of the peak power sensor. Record the power level.

Average power sensor was used to perform output power measurement, trigger and gating function of wide band power meter is enabled to measure max output power of TX on burst. Duty factor is not added to measured value.

4.3.5 Deviation from Test Standard

No deviation.

4.3.6 EUT Operating Conditions

The software provided by client to enable the EUT under transmission condition continuously at lowest, middle and highest channel frequencies individually.

4.3.7 Test Results

BT-LE 1M

FOR PEAK POWER

Channel	Frequency (MHz)	Peak Power (mW)	Peak Power (dBm)	Limit (dBm)	Pass/Fail
0	2402	2.223	3.47	30	Pass
19	2440	2.042	3.10	30	Pass
39	2480	1.854	2.68	30	Pass

FOR AVERAGE POWER

Channel	Frequency (MHz)	Average Power (mW)	Average Power (dBm)
0	2402	2.208	3.44
19	2440	2.028	3.07
39	2480	1.837	2.64

BT-LE 2M

FOR PEAK POWER

Channel	Frequency (MHz)	Peak Power (mW)	Peak Power (dBm)	Limit (dBm)	Pass/Fail
0	2402	2.218	3.46	30	Pass
19	2440	2.037	3.09	30	Pass
39	2480	1.849	2.67	30	Pass

FOR AVERAGE POWER

Channel	Frequency (MHz)	Average Power (mW)	Average Power (dBm)
0	2402	2.198	3.42
19	2440	2.023	3.06
39	2480	1.832	2.63

5 Pictures of Test Arrangements

Please refer to the attached file (Test Setup Photo).

Appendix – Information of the Testing Laboratories

We, Bureau Veritas Consumer Products Services (H.K.) Ltd., Taoyuan Branch, were founded in 1988 to provide our best service in EMC, Radio, Telecom and Safety consultation. Our laboratories are FCC recognized accredited test firms and accredited according to ISO/IEC 17025.

If you have any comments, please feel free to contact us at the following:

Lin Kou EMC/RF Lab

Tel: 886-2-26052180

Fax: 886-2-26051924

Hsin Chu EMC/RF/Telecom Lab

Tel: 886-3-6668565

Fax: 886-3-6668323

Hwa Ya EMC/RF/Safety Lab

Tel: 886-3-3183232

Fax: 886-3-3270892

Email: service.adt@tw.bureauveritas.com

Web Site: www.bureauveritas-adt.com

The address and road map of all our labs can be found in our web site also.

--- END ---