

RF Test Report

Applicant : u-blox AG

Product Name : Host-based multiradio module

Trade Name : u-blox

Model Number : MAYA-W276-00B

Applicable Standard : FCC 47 CFR PART 15 SUBPART E
ANSI C63.10:2013

Received Date : Nov. 09, 2023

Test Period : Nov. 27 ~ Dec. 01, 2023

Issued Date : Dec. 22, 2023

Issued by

Eurofins E&E Wireless Taiwan Co., Ltd.
No. 140-1, Changan Street, Bade District,
Taoyuan City 334025, Taiwan (R.O.C.)
Tel : +886-3-2710188 / Fax : +886-3-2710190



Taiwan Accreditation Foundation accreditation number: 1330
Frequency Range : 9 kHz to 40 GHz
Test Firm Registration Number: 226252 (Bade test site)
Test Firm Registration Number: 191812 (Wugu test site)

Note:

1. The test results are valid only for samples provided by customers and under the test conditions described in this report.
2. This report shall not be reproduced except in full, without the written approval of Eurofins E&E Wireless Taiwan Co., Ltd.
3. The relevant information is provided by customers in this test report. According to the correctness, appropriateness or completeness of the information provided by the customer, if there is any doubt or error in the information which affects the validity of the test results, the laboratory does not take the responsibility.

Revision History

Rev.	Issued Date	Description	Revised By
00	Dec. 22, 2023	Initial Issue	Abby Huang

Verification of Compliance

Applicant : u-blox AG

Product Name : Host-based multiradio module

Trade Name : u-blox

Model Number : MAYA-W276-00B

FCC ID : XPYMAYAW2B

Applicable Standard : FCC 47 CFR PART 15 SUBPART E
ANSI C63.10:2013

Test Result : Complied

Performing Lab. : Eurofins E&E Wireless Taiwan Co., Ltd.
No. 140-1, Changan Street, Bade District,
Taoyuan City 334025, Taiwan (R.O.C.)
Tel : +886-3-2710188 / Fax : +886-3-2710190
Taiwan Accreditation Foundation accreditation number: 1330



Eurofins E&E Wireless Taiwan Co., Ltd. tested the above equipment in accordance with the requirements set forth in the above standards. All indications of Pass/Fail in this report are opinions expressed by Eurofins E&E Wireless Taiwan Co., Ltd. based on interpretations and/or observations of test results. The test results show that the equipment tested is capable of demonstrating compliance with the requirements as documented in this report.

Approved By : _____

TABLE OF CONTENTS

1	General Information.....	5
1.1.	Summary of Test Result	5
1.2.	Testing Location	6
1.3.	Measurement Uncertainty	6
1.4.	Test Site Environment	6
2	EUT Description.....	7
3	Test Methodology	12
3.1.	Mode of Operation.....	12
3.2.	EUT Test Step	12
3.3.	Configuration of Test System Details.....	13
3.4.	Test Instruments	14
4	Measurement Procedure	15
4.1.	AC Power Conducted Emission Measurement	15
4.2.	Transmitter Radiated Emissions Measurement.....	17
5	Test Results	22
5.1.	Conducted Emission	22
5.2.	Radiated Emission Measurement	26

Appendix A. Test Setup Photographs

1 General Information

1.1. Summary of Test Result

Standard	Item	Result	Remark
15.407(b)(9) 15.207	AC Power Conducted Emission	PASS	---
15.407(b) 15.205 / 15.209	Transmitter Radiated Emissions	PASS	Note 2
15.407(a)	Maximum Conducted Output Power	N/A	Note 1
15.407(a)	26 dB RF Bandwidth	N/A	Note 1
15.407(e)	6 dB RF Bandwidth	N/A	Note 1
15.407(a)	Maximum Power Spectral Density	N/A	Note 1
15.407(c)	Automatically discontinue transmission	N/A	Note 1
15.407(a) 15.203	Antenna Requirement	N/A	Note 1

Note 1: Class II permissive change. No need for verification.

Note 2: Only verify the Transmitter Radiated Emissions (Band Edge).

Decision Rule

- Uncertainty is not included.
- Uncertainty is included.

Standard	Description
CFR47, Part 15, Subpart C	Intentional Radiators
CFR47, Part 15, Subpart E	Unlicensed National Information Infrastructure Devices
ANSI C63. 10: 2013	American National Standard of Procedures for Compliance Testing of Unlicensed Wireless Devices
KDB789033: D02	Guidelines for Compliance Testing of Unlicensed National Information Infrastructure (U-NII) Devices Part 15, Subpart E
KDB 662911 D01 v02r01	Emissions Testing of Transmitters with Multiple Outputs in the Same Band (e.g., MIMO, Smart Antenna, etc)

1.2. Testing Location

Lab Name: Eurofins E&E Wireless Taiwan Co., Ltd.

Site Address: No. 140-1, Changan Street, Bade District, Taoyuan City 334025, Taiwan (R.O.C.)

Site Address: No. 2, Wuquan 5th Rd. Wugu Dist., New Taipei City, Taiwan (R.O.C.)

1.3. Measurement Uncertainty

Test Item	Frequency	Uncertainty			
		BD		WG	
Conducted Emission	150 kHz ~ 30 MHz	2.7 dB		2.6 dB	
Conducted Output Power		1.1 dB		1.1 dB	
RF Bandwidth		4.5 %		4.5 %	
Power Spectral Density		1.1 dB		1.1 dB	
Duty Cycle		1.1 %		1.0 %	
Time Occupancy		1.5 %		1.2 %	
Test Item	Frequency	Uncertainty			
		96601-BD	96603-BD	96602-WG	96603-WG
Radiated Emission	9 kHz ~ 30 MHz	1.9 dB	1.9 dB	1.6 dB	1.6 dB
	30 MHz ~ 1000 MHz	4.9 dB	4.9 dB	4.8 dB	4.8 dB
	1000 MHz ~ 18000 MHz	4.9 dB	5.0 dB	5.0 dB	5.2 dB
	18000 MHz ~ 26500 MHz	4.3 dB	4.4 dB	4.4 dB	4.5 dB
	26500 MHz ~ 40000 MHz	4.5 dB	4.5 dB	4.6 dB	4.5 dB

1.4. Test Site Environment

Items	Required (IEC 60068-1)	Interval(*)
Temperature (°C)	15-35	20-30
Humidity (%RH)	25-75	45-75

(*)The measurement ambient temperature is within this range.

2 EUT Description

The product specifications of the EUT presented in the report are declared by the manufacturer who shall take full responsibility for the authenticity(except Max. RF Output Power).

Applicant	u-blox AG Zürcherstrasse 68, 8800 Thalwil, Switzerland		
Product Name	Host-based multiradio module		
Trade Name	u-blox		
Model Number	MAYA-W276-00B		
FCC ID	XPYMAW2B		
Operate Frequency	Frequency Band		Frequency Range (MHz)
	802.11a	U-NII Band 1	5180 – 5240
		U-NII Band 2-A	5260 – 5320
		U-NII Band 2-C	5500 – 5700
		Straddle band	5720
		U-NII Band 3	5745 – 5825
	802.11n HT20 / 802.11ac VHT20/ 802.11ax HE20	U-NII Band 1	5180 – 5240
		U-NII Band 2-A	5260 – 5320
		U-NII Band 2-C	5500 – 5700
		Straddle band	5720
		U-NII Band 3	5745 – 5825
	802.11n HT40 / 802.11ac VHT40/ 802.11ax HE40	U-NII Band 1	5190 – 5230
		U-NII Band 2-A	5270 – 5310
		U-NII Band 2-C	5510 – 5670
		Straddle band	5710
		U-NII Band 3	5755 – 5795
	802.11ac VHT80/ 802.11ax HE80	U-NII Band 1	5210
		U-NII Band 2-A	5290
		U-NII Band 2-C	5530
		Straddle band	5690
U-NII Band 3		5775	
Modulation Type	OFDM/OFDMA		

Antenna information	Model	Type	Max. Gain (dBi)	
	ANT-DB1-RAF-SAM	Dipole Antenna	5.1	
custom	Integrated Antenna	U-NII Band 1	-2.7	
		U-NII Band 2-A	-2.0	
		U-NII Band 2-C	-1.2	
		U-NII Band 3	-3.8	
Operate Temp. Range	-40 ~ +85 °C			
EUT Power Rating	3.14 – 3.46 V			

EUT Modify Description :

Modify Description :

1. C44 and C47 shifted down by hundreds of micrometers. Buffer capacitors only. No impact expected on RF Performance / Characteristics.
2. New Module Shield added. Larger cutout on bottom side. No impact expected on RF Performance / Characteristics. No/Low impact on radiated measurements expected.
3. BGA pads on HW Rev C are solder mask defined with exposed copper pads area diameter area of 170um compared to the BGAs pads on HW Rev B which are not solder mask defined with exposed landing pads area diameter of 180um → No impact expected on RF Performance / Characteristics

After the verification of worst cast of AC Power Conducted Emission and Transmitter Radiated Emissions (Band Edge), all test data can be referred to the original report.

Original Report : USRC238221001, G0M-2302-1881-TFC407WF-W276-V01

Frequency Band		Max. RF Output Power (W)
802.11a	U-NII Band 1	0.0891
	U-NII Band 2-A	0.0776
	U-NII Band 2-C	0.0603
	U-NII Band 3	0.0741
802.11n HT20	U-NII Band 1	0.089
	U-NII Band 2-A	0.078
	U-NII Band 2-C	0.059
	U-NII Band 3	0.072
802.11n HT40	U-NII Band 1	0.085
	U-NII Band 2-A	0.076
	U-NII Band 2-C	0.060
	U-NII Band 3	0.066
802.11ac VHT20	U-NII Band 1	0.089
	U-NII Band 2-A	0.074
	U-NII Band 2-C	0.063
	U-NII Band 3	0.074
802.11ac VHT40	U-NII Band 1	0.085
	U-NII Band 2-A	0.071
	U-NII Band 2-C	0.060
	U-NII Band 3	0.068
802.11ac VHT80	U-NII Band 1	0.021
	U-NII Band 2-A	0.020
	U-NII Band 2-C	0.032
	U-NII Band 3	0.035
802.11ax HE20	U-NII Band 1	0.077
	U-NII Band 2-A	0.068
	U-NII Band 2-C	0.052
	U-NII Band 3	0.071
802.11ax HE40	U-NII Band 1	0.079
	U-NII Band 2-A	0.068

	U-NII Band 2-C	0.053
	U-NII Band 3	0.057
802.11ax HE80	U-NII Band 1	0.010
	U-NII Band 2-A	0.012
	U-NII Band 2-C	0.027
	U-NII Band 3	0.030

Equipment Type		
Outdoor access point	point-to-point	---
	point-to-multipoint	---
Indoor access point		---
Fixed point-to-point access points		---
Client devices		V

3 Test Methodology

3.1. Mode of Operation

Decision of Test Eurofins has verified the construction and function in typical operation. All the test modes were carried out with the EUT in normal operation, which was shown in this test report and defined as:

Pre-Test Mode	Final-Test Mode
Transmit Mode	V
802.11ac VHT80	V
802.11ax HE40	V

Software used to control the EUT for staying in continuous transmitting mode was programmed.

After verification, all tests were carried out with the worst case test modes.

By preliminary testing and verifying three axis (X, Y and Z) position of EUT transmitted status, it was found that "Z axis" position was the worst, then the final test was executed the worst condition and test data were recorded in this report.

3.2. EUT Test Step

The EUT is operated in the engineering mode to fix the TX frequency for the purposes of measurement.

According to its specifications, the EUT must comply with the requirements of Section 15.407 under the FCC Rules Part 15 Subpart E.

1.	Setup the EUT shown on "Configuration of Test System Details".
2.	Turn on the power of all equipment.
3.	Turn on TX function.
4.	EUT run test program.

3.3. Configuration of Test System Details

Conducted Emissions & Radiated Emission (Above 1GHz)

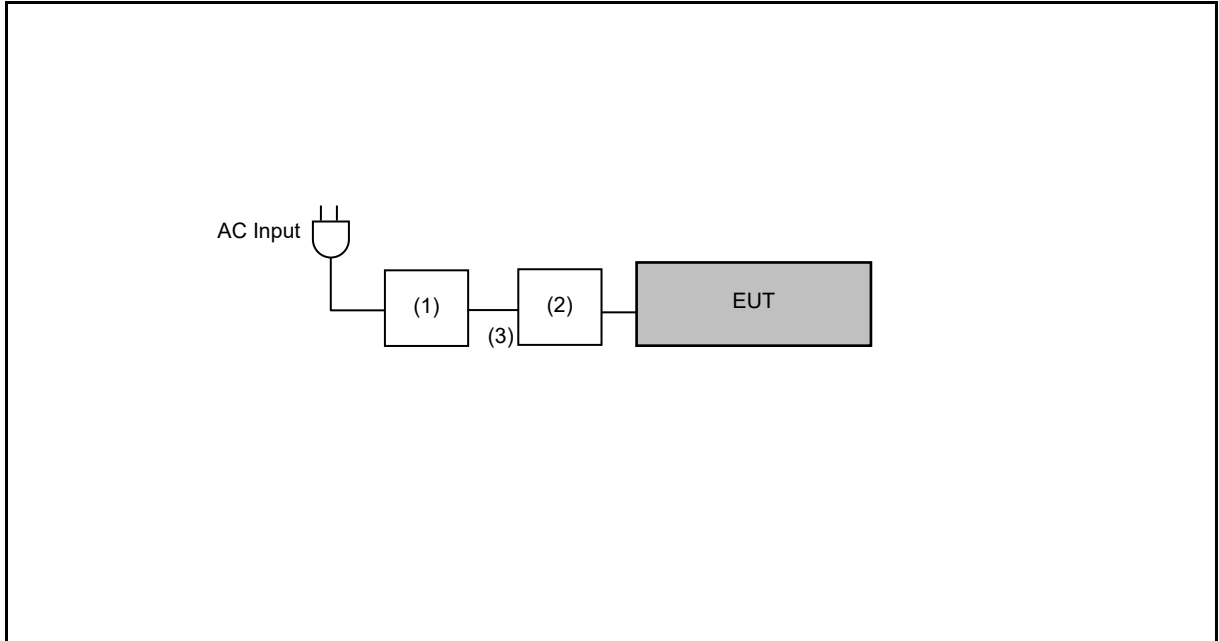

	Product	Manufacturer	Model Number	Serial Number	Power Cord
(1)	Notebook	DELL	P137G	---	---
(2)	Evaluation Kit for the i.MX 8M Mini Applications Processor	NXP	8MMINILPD4-EVKB	---	---
(3)	USB 5Gbps (USB 3.0, USB 3.x Gen 1. Superspeed) cable USB-A plug to USB-C plug 3,28' (1,00m) shielded.	CUI Devices	CBL-UA-UC-1	---	---

3.4. Test Instruments

For Radiated Emissions

Test Period: Nov. 27 ~ Nov. 30, 2023

Testing Engineer: Marin Lee

Radiation test sites		Semi Anechoic Room 96602-WG				
Use	Equipment	Manufacturer	Model Number	Serial Number	Cal. Date	Cal. Period
<input checked="" type="checkbox"/>	Broadband Horn Antenna (1 GHz~18 GHz)	RF SPIN	DRH18-E	210305A18ES	Feb. 21, 2023	1 year
<input checked="" type="checkbox"/>	Spectrum Analyzer (10 Hz~44 GHz)	KEYSIGHT	N9020B	MY60112362	Feb. 16, 2023	1 year
<input checked="" type="checkbox"/>	Pre-Amplifier	SGH	SGH118-EMC	20230715-3	Sep. 07, 2023	1 year
<input checked="" type="checkbox"/>	Coaxial Cable (1 GHz~18 GHz)	EMCI	EMC104-SM-SM-1000	211026	Nov. 13, 2023	1 year
<input checked="" type="checkbox"/>	Coaxial Cable (1 GHz~18 GHz)	EMCI	EMC104-SM-SM-2000	211035	Nov. 13, 2023	1 year
<input checked="" type="checkbox"/>	Coaxial Cable (1 GHz~18 GHz)	EMCI	EMC104-SM-SM-8000	211036	Nov. 13, 2023	1 year
<input checked="" type="checkbox"/>	Software	R_RAM	V1.3	N/A	N.C.R.	---

For Conduction Emissions

Test Period: Dec. 01, 2023

Testing Engineer: Marin Lee

Radiation test sites		Conducted Emission Measurement Conduction01-WG				
Use	Equipment	Manufacturer	Model Number	Serial Number	Cal. Date	Cal. Period
<input checked="" type="checkbox"/>	Test Receiver	R&S	ESR3	102919	Nov 30, 2023	1 year
<input checked="" type="checkbox"/>	LISN	R&S	ENV216	101041	Apr 12, 2023	1 year
<input checked="" type="checkbox"/>	Current Probe	R&S	EZ-17	101687	Jun 15, 2023	1 year
<input checked="" type="checkbox"/>	Cable	EMCI	EMCCFD300-BM-NM-4000	220402	Jun 08, 2023	1 year
<input checked="" type="checkbox"/>	Software	ELEKTRA	94.50.4	N.A.	N.C.R.	N.C.R.

Note: N.C.R. = No Calibration Request.

4 Measurement Procedure

4.1. AC Power Conducted Emission Measurement

■ Limit

Frequency (MHz)	Quasi-peak	Average
0.15 - 0.5	66 to 56	56 to 46
0.50 - 5.0	56	46
5.0 - 30.0	60	50

■ Test Setup

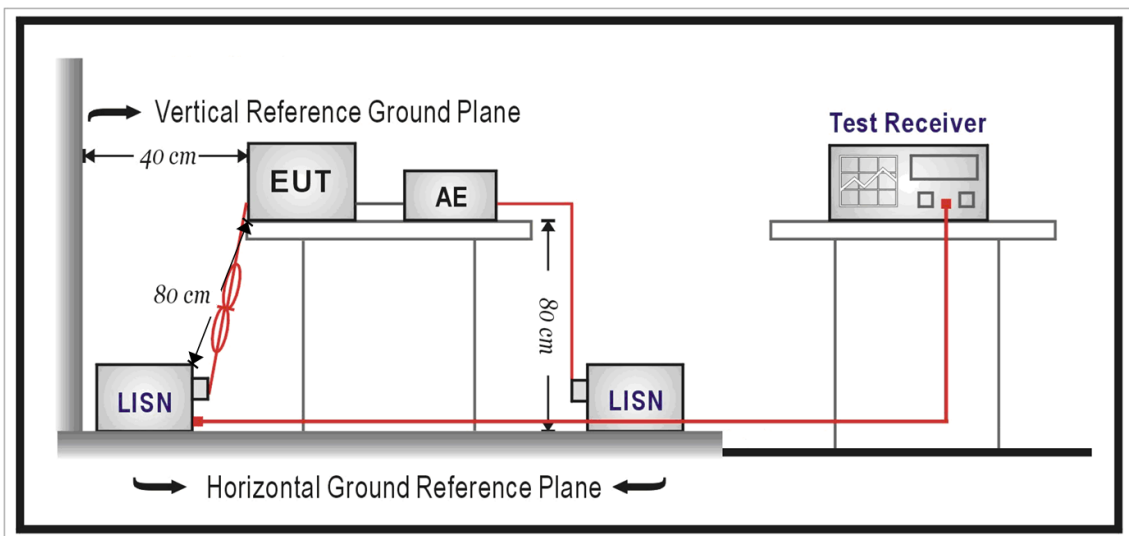

■ Test Procedure

The EUT and simulators are connected to the main power through a line impedance stabilization network (L.I.S.N.). This provides a $50 \Omega // 50 \mu\text{H}$ coupling impedance for the measuring equipment. The peripheral devices are also connected to the main power through a LISN that provides a $50 \Omega // 50 \mu\text{H}$ coupling impedance with 50 ohm termination.

Tabletop device shall be placed on a non-conducting platform, of nominal size 1 m by 1.5 m, raised 80 cm above the reference ground plane. The wall of screened room shall be located 40 cm to the rear of the EUT. Other surfaces of tabletop or floor standing EUT shall be at least 80 cm from any other ground conducting surface including one or more LISNs. For floor-standing device shall be placed under the EUT with a 12 mm insulating material.

Conducted emissions were investigated over the frequency range from 0.15 MHz to 30 MHz using a resolution bandwidth of 9 kHz. The equipment under test (EUT) shall be meet the limits in section 4.1, as applicable, including the average limit and the quasi-peak limit when using respectively, an average detector and quasi-peak detector measured in accordance with the methods described of related standard. When all of peak value were complied with quasi-peak and average limit from 150 kHz to 30 MHz then quasi-peak and average measurement was unnecessary.

The AMN shall be placed 0.8 m from the boundary of the unit under test and bonded to a ground reference plane for AMNs mounted on top of the ground reference plane. This distance is between the closest points of the AMN and the EUT. All other units of the EUT and associated equipment shall be at least 0.8 m from the AMN. If the mains power cable is longer than 1 m then the cable shall be folded back and forth at the centre of the lead to form a bundle no longer than 0.4 m. All of interconnecting cables that hang closer than 40 cm to the ground plane shall be folded back and forth in the center forming a bundle 30 cm to 40 cm long. All of EUT and AE shall be separate place more than 0.1 m. All 50Ω ports of the LISN shall be resistively terminated into 50Ω loads when not connected to the measuring instrument.

If the reading of the measuring receiver shows fluctuations close to the limit, the reading shall be observed for at least 15 s at each measurement frequency; the higher reading shall be recorded with the exception of any brief isolated high reading which shall be ignored

4.2. Transmitter Radiated Emissions Measurement

■ Limit

(1)Undesirable emission limits. Except as shown in paragraph (b)(9) of this section, the maximum emissions outside of the frequency bands of operation shall be attenuated in accordance with the following limits:

- (a)For transmitters operating in the 5.15-5.25 GHz band: All emissions outside of the 5.15-5.35 GHz band shall not exceed an e.i.r.p. of -27 dBm/MHz.
- (b)For transmitters operating in the 5.25-5.35 GHz band: All emissions outside of the 5.15-5.35 GHz band shall not exceed an e.i.r.p. of -27 dBm/MHz.
- (c)For transmitters operating in the 5.47-5.725 GHz band: All emissions outside of the 5.47-5.725 GHz band shall not exceed an e.i.r.p. of -27 dBm/MHz.
- (d)For transmitters operating in the 5.725-5.85 GHz band:
 - (i)All emissions shall be limited to a level of -27 dBm/MHz at 75 MHz or more above or below the band edge increasing linearly to 10 dBm/MHz at 25 MHz above or below the band edge, and from 25 MHz above or below the band edge increasing linearly to a level of 15.6 dBm/MHz at 5 MHz above or below the band edge, and from 5 MHz above or below the band edge increasing linearly to a level of 27 dBm/MHz at the band edge.

EIRP (dBm)	Field Strength at 3 m(dBuV/m)
-27	68.3

(2)Limits of Radiated Emission Measurement

Emissions radiated outside of the specified bands, shall be according to the general radiated limits in 15.209 as following:

Frequency Range (MHz)	Field Strength (microvolts/meter)	Measurement Distance (meters)
0.009 ~ 0.490	2400/F(kHz)	300
0.490 ~ 1.705	24000/F(kHz)	30
1.705 ~ 30.0	30	30
30 ~ 88	10	3
88 ~ 216	150	3
216 ~ 960	200	3
Above 960	500	3

- Note:
1. The lower limit shall apply at the transition frequencies.
 2. Emission level (dBuV/m) = 20 log Emission level (uV/m).
 3. As shown in 15.35(b), for frequencies above 1000 MHz, the field strength limits are based on average detector, however, the peak field strength of any emission shall not exceed the maximum permitted average limits, specified above by more than 20 dB under any condition of modulation.

■ Setup

9 kHz ~ 30 MHz

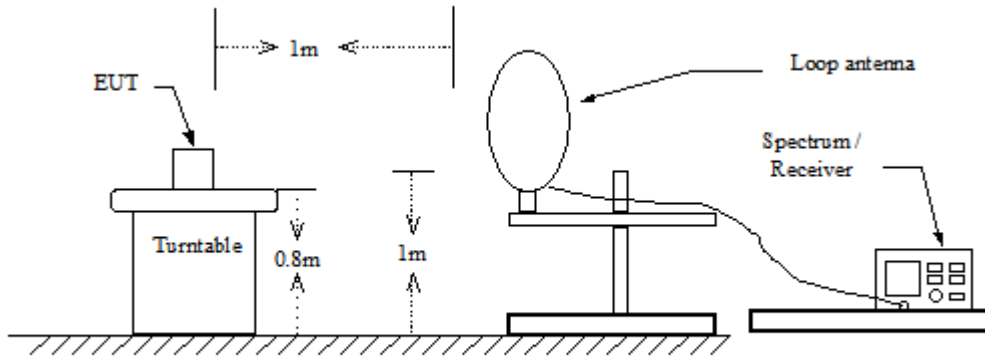

30 MHz ~ 1 GHz

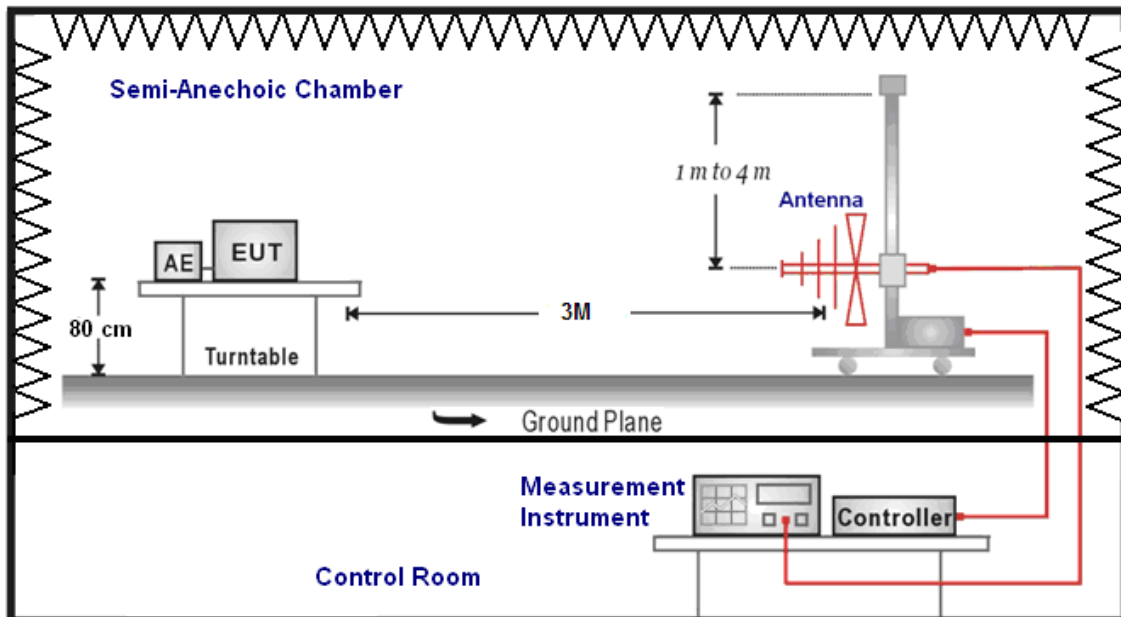

Above 1 GHz

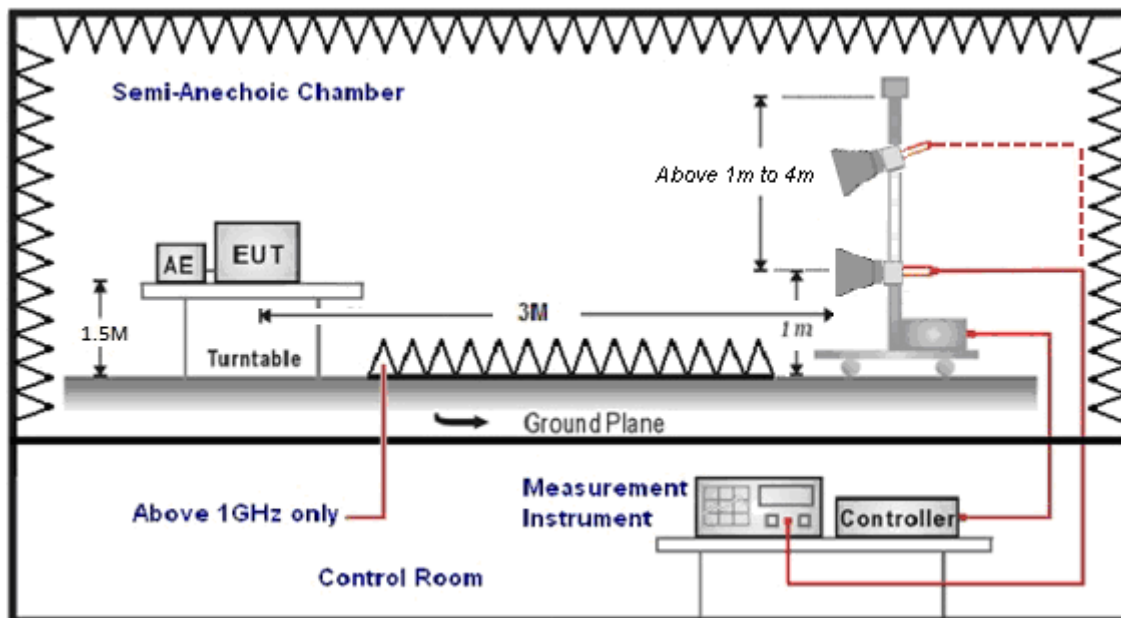

■ Test Procedure

Final radiation measurements were made on a three-meter, Semi Anechoic Chamber. The EUT system was placed on a nonconductive turntable which is 0.8 or 1.5 meters height (below 1 GHz use 0.8 m turntable / above 1 GHz use 1.5 m turntable), top surface 1.0 x 1.5 meter. The spectrum was examined from 250 MHz to 2.5 GHz in order to cover the whole spectrum below 10th harmonic which could generate from the EUT. During the test, EUT was set to transmit continuously & Measurements spectrum range from 9 kHz to 40 GHz is investigated.

For measurements below 30 MHz the resolution bandwidth is set to 10 kHz for peak detection measurements or 9 kHz for quasi-peak detection measurements. The video bandwidth is 3 times of the resolution bandwidth.

For measurements below 1 GHz the resolution bandwidth is set to 100 kHz for peak detection measurements or 120 kHz for quasi-peak detection measurements. Peak detection is used unless otherwise noted as quasi-peak.

For restricted measurements above 1 GHz the resolution bandwidth is set to 1 MHz, and then the video bandwidth is set to 3 MHz for peak measurements and 10 Hz for average measurements when Duty cycle > 0.98 / 1/T for average measurements when Duty cycle < 0.98.

For out of band measurements above 1 GHz the resolution bandwidth is set to 1 MHz, and then the video bandwidth is set to 3 MHz for peak measurements.

A nonconductive material surrounded the EUT to supporting the EUT for standing on three orthogonal planes. At each condition, the EUT was rotated 360 degrees, and the antenna was raised and lowered from one to four meters to find the maximum emission levels. Measurements were taken using both horizontal and vertical antenna polarization.

SCHWARZBECK MESS-ELEKTRONIK Trilog-Broadband Antenna at 3 Meter and the ETS-Lindgren Double-Ridged Waveguide Horn antenna Schwarzbeck Mess-Elektronik Broadband Horn Antenna was used in frequencies 1 – 40 GHz at a distance of 3 meter. The antenna at an angle toward the source of the emission. All test results were extrapolated to equivalent signal at 3 meters utilizing an inverse linear distance extrapolation Factor (20 dB/decade).

For testing above 1 GHz, the emission level of the EUT in peak mode was 20 dB lower than average limit (that means the emission level in peak mode also complies with the limit in average mode), then testing will be stopped and peak values of EUT will be reported, otherwise, the emissions will be measured in average mode again and reported.

Appropriate preamplifiers were used for improving sensitivity and precautions were taken to avoid overloading or desensitizing the spectrum analyzer. No post – detector video filters were used in the test.

The spectrum analyzer's 6 dB bandwidth was set to 1 MHz, and the analyzer was operated in the peak detection mode, for frequencies both below and up 1 GHz. The average levels were obtained by subtracting the duty cycle correction factor from the peak readings.

The following procedures were used to convert the emission levels measured in decibels referenced to 1 microvolt (dBuV) into field intensity in micro volts per meter (uV/m).

The actual field intensity in decibels referenced to 1 microvolt in to field intensity in micro volts per meter (dBuV/m).

Data of measurement within this frequency range without mark in the table above means the reading of emissions are attenuated more than 20 dB below the permissible limits or the field strength is too small to be measured.

The actual field intensity in referenced to 1 microvolt per meter (dBuV/m) is determined by algebraically adding the measured reading in dBuV, the antenna factor (dB), and cable loss (dB) and Subtracting the gain of preamplifier (dB) is auto calculate in spectrum analyzer.

(1) $\text{Amplitude (dBuV/m)} = \text{FI (dBuV)} + \text{AF (dBuV)} + \text{CL (dBuV)} - \text{Gain (dB)}$

FI= Reading of the field intensity.

AF= Antenna factor.

CL= Cable loss.

P.S Amplitude is auto calculate in spectrum analyzer.

(2) $\text{Actual Amplitude (dBuV/m)} = \text{Amplitude (dBuV)} - \text{Dis(dB)}$

The FCC specified emission limits were calculated according the EUT operating frequency and by following linear interpolation equations:

(a) For fundamental frequency : Transmitter Output < +30 dBm

(b) For spurious frequency : Spurious emission limits = fundamental emission limit /10

Measuring Instruments and setting

The following table is the setting of spectrum analyzer and receiver.

Spectrum Parameter	Setting
Attenuation	Auto
Start Frequency	1000 MHz
Stop Frequency	40 GHz
RBW/VBW(Emission in restricted band)	1 MHz / 3 MHz for Peak 1 MHz / (1/T) for Average
RBW/VBW(Emission in non-restricted band)	1 MHz / 3 MHz for Peak

5 Test Results

5.1. Conducted Emission

Antenna model number: ANT-DB1-RAF-SAM

Standard:	FCC Part 15.407	Line:	L1
Test item:	Conducted Emission	Power:	AC 120 V/60 Hz
Test Mode:	Transmit mode		
Description:			

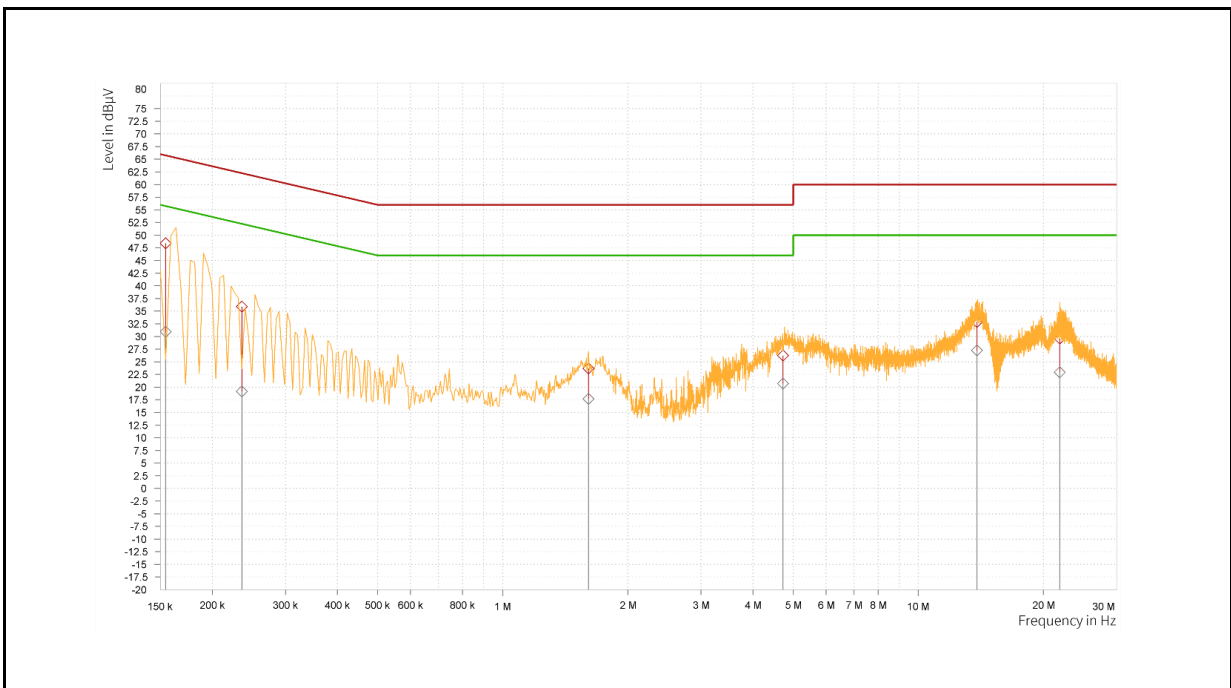

Rg	Frequency [MHz]	QP Result [dBμV]	QP Limit [dBμV]	QP Margin [dB]	AV Result [dBμV]	AV Limit [dBμV]	AV Margin [dB]	Correction factor [dB]	Line
1	0.155	48.39	65.75	17.37	30.94	55.75	24.81	9.65	L1
1	0.236	35.91	62.25	26.35	19.16	52.25	33.09	9.64	L1
1	1.608	23.68	56.00	32.32	17.69	46.00	28.31	9.71	L1
1	4.727	26.22	56.00	29.78	20.71	46.00	25.29	9.80	L1
1	13.844	32.86	60.00	27.14	27.26	50.00	22.74	10.00	L1
1	21.899	29.62	60.00	30.38	22.94	50.00	27.06	10.11	L1

Note: 1. Result (dBμV) = Correction factor (dB) + Reading(dBμV).

2. Correction factor (dB) = Cable loss (dB) + L.I.S.N. factor (dB).

Standard:	FCC Part 15.407	Line:	N
Test item:	Conducted Emission	Power:	AC 120 V/60 Hz
Test Mode:	Transmit mode		
Description:			

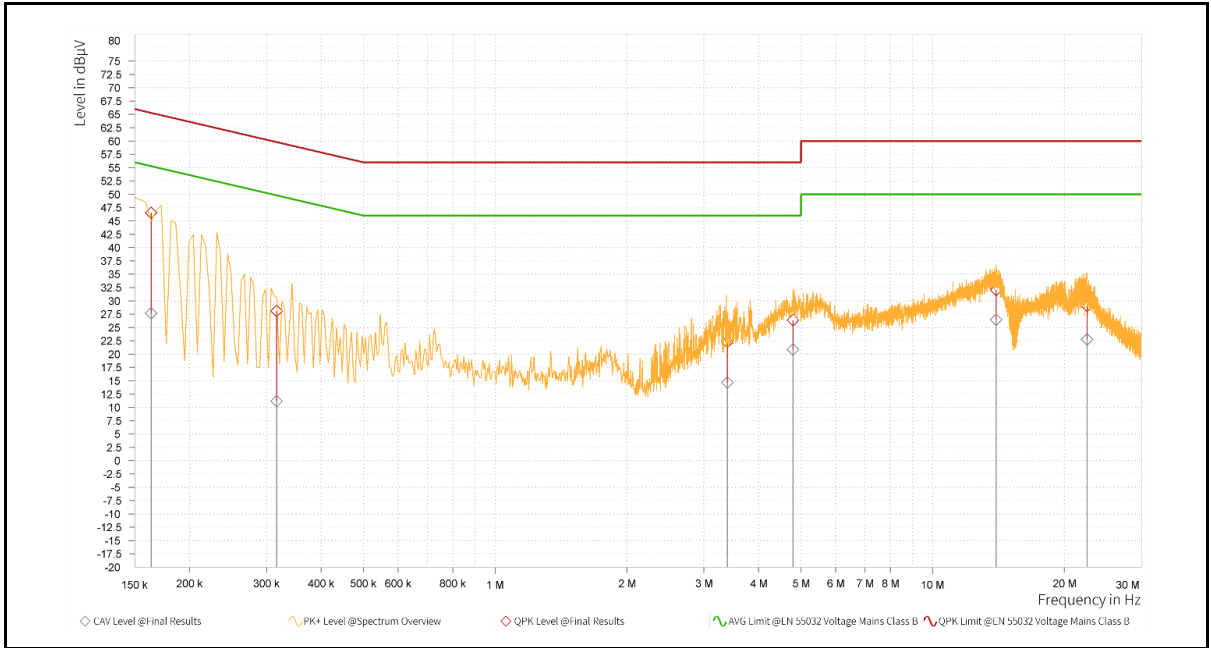

Rg	Frequency [MHz]	QP Result [dBµV]	QP Limit [dBµV]	QP Margin [dB]	AV Result [dBµV]	AV Limit [dBµV]	AV Margin [dB]	Correction factor [dB]	Line
1	0.164	46.49	65.28	18.79	27.69	55.28	27.59	9.64	N
1	0.317	28.07	59.80	31.72	11.16	49.80	38.64	9.65	N
1	3.395	22.27	56.00	33.73	14.67	46.00	31.33	9.77	N
1	4.794	26.38	56.00	29.62	20.88	46.00	25.12	9.82	N
1	13.965	32.05	60.00	27.95	26.47	50.00	23.53	10.08	N
1	22.542	29.05	60.00	30.95	22.77	50.00	27.23	10.25	N

Note: 1. Result (dBuV) = Correction factor (dB) + Reading(dBuV).

2. Correction factor (dB) = Cable loss (dB) + L.I.S.N. factor (dB).

Antenna model number: custom

Standard:	FCC Part 15.407	Line:	L1
Test item:	Conducted Emission	Power:	AC 120 V/60 Hz
Test Mode:	Transmit mode		
Description:			

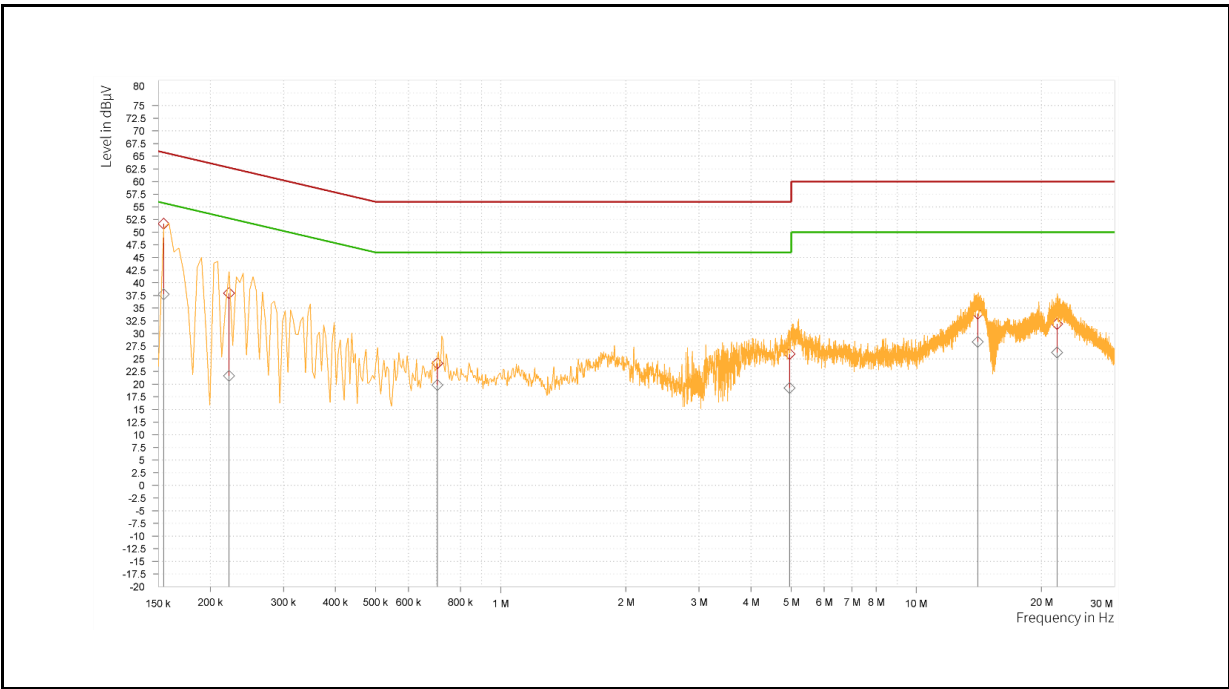

Rg	Frequency [MHz]	QP Result [dBμV]	QP Limit [dBμV]	QP Margin [dB]	AV Result [dBμV]	AV Limit [dBμV]	AV Margin [dB]	Correction factor [dB]	Line
1	0.155	51.68	65.75	14.07	37.73	55.75	18.03	9.65	L1
1	0.222	37.95	62.74	24.80	21.63	52.74	31.12	9.64	L1
1	0.704	24.10	56.00	31.90	19.82	46.00	26.18	9.67	L1
1	4.952	25.94	56.00	30.06	19.22	46.00	26.78	9.81	L1
1	14.055	33.92	60.00	26.08	28.32	50.00	21.68	10.00	L1
1	21.813	31.88	60.00	28.12	26.24	50.00	23.76	10.11	L1

Note: 1. Result (dBuV) = Correction factor (dB) + Reading(dBuV).

2. Correction factor (dB) = Cable loss (dB) + L.I.S.N. factor (dB).

Standard:	FCC Part 15.407	Line:	N
Test item:	Conducted Emission	Power:	AC 120 V/60 Hz
Test Mode:	Transmit mode		
Description:			

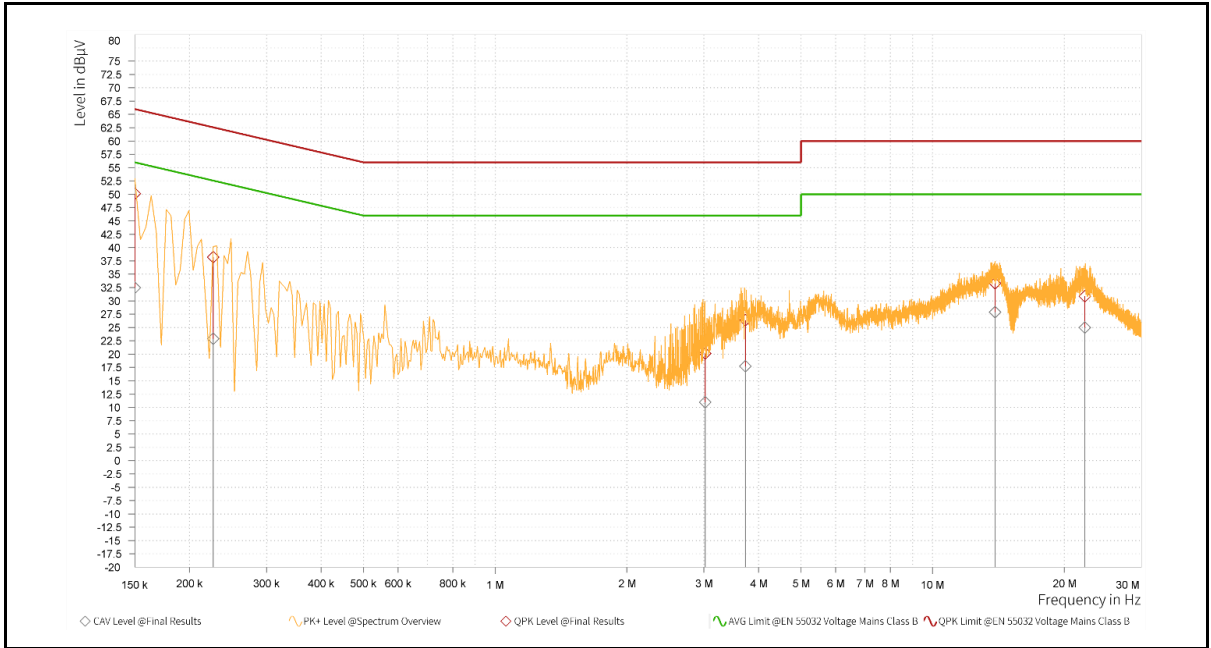

Rg	Frequency [MHz]	QP Result [dBµV]	QP Limit [dBµV]	QP Margin [dB]	AV Result [dBµV]	AV Limit [dBµV]	AV Margin [dB]	Correction factor [dB]	Line
1	0.150	50.12	66.00	15.88	32.45	56.00	23.55	9.64	N
1	0.227	38.22	62.58	24.35	22.91	52.58	29.67	9.64	N
1	3.021	20.12	56.00	35.88	10.98	46.00	35.02	9.76	N
1	3.732	26.36	56.00	29.64	17.74	46.00	28.26	9.78	N
1	13.884	33.30	60.00	26.70	27.87	50.00	22.13	10.07	N
1	22.295	30.85	60.00	29.15	24.99	50.00	25.01	10.24	N

Note: 1. Result (dBuV) = Correction factor (dB) + Reading(dBuV).

2. Correction factor (dB) = Cable loss (dB) + L.I.S.N. factor (dB).

5.2. Radiated Emission Measurement

Antenna model number: ANT-DB1-RAF-SAM

Band Edge

Peak

Test Site:	96602 - WG	Standard:	Part 15.407
Test Mode:	802.11ax HE40 5310 MHz		
Polarization:	Horizontal		
ReMark:			

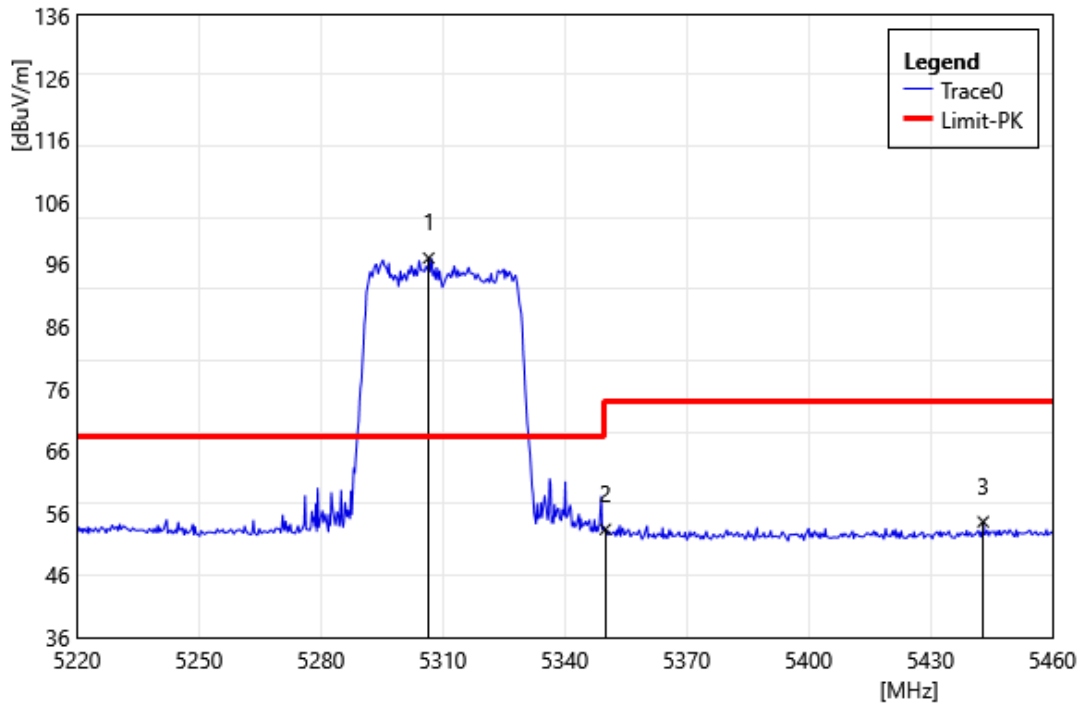

ID	Frequency MHz	Reading dBuV	Correct Factor dB/m	Result dBuV/m	Limit dBuV/m	Margin dB	ReMark
1	5306.55	101.92	-4.91	97.01	68.20	28.81	PEAK
2	5350.00	58.33	-4.96	53.37	74.00	-20.63	PEAK
3	5442.98	59.38	-4.79	54.59	74.00	-19.41	PEAK

Test Site:	96602 - WG	Standard:	Part 15.407
Test Mode:	802.11ax HE40 5310 MHz		
Polarization:	Vertical		
ReMark:			

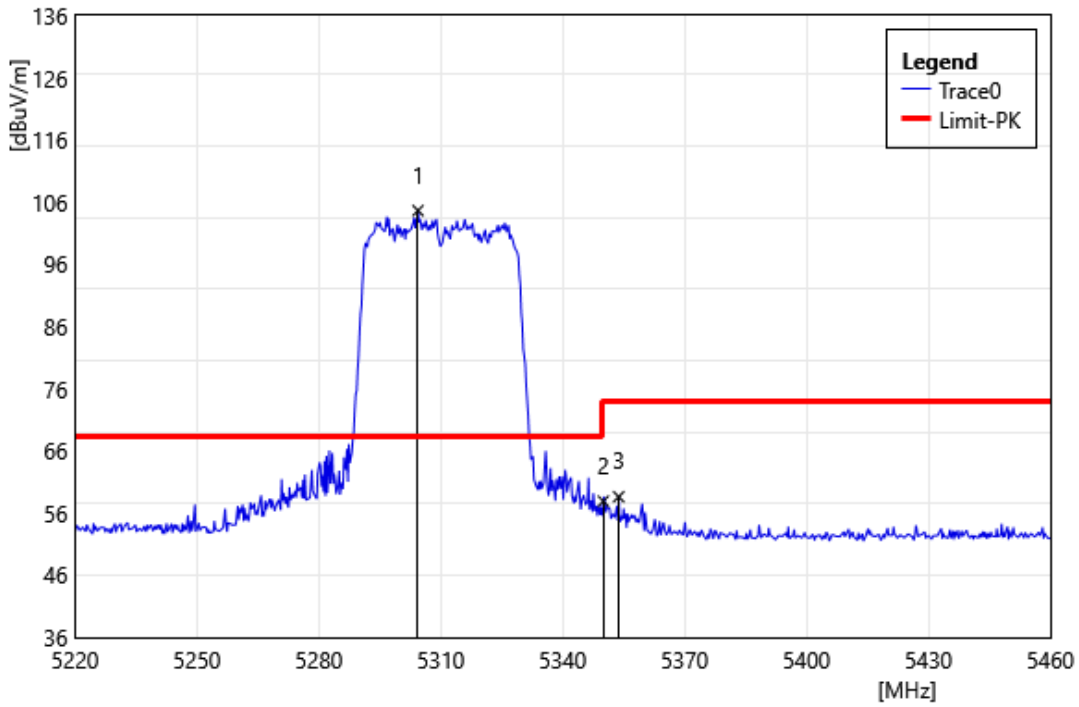

ID	Frequency MHz	Reading dBuV	Correct Factor dB/m	Result dBuV/m	Limit dBuV/m	Margin dB	ReMark
1	5304.40	109.56	-4.91	104.65	68.20	36.45	PEAK
2	5350.00	62.87	-4.96	57.91	74.00	-16.09	PEAK
3	5353.79	63.57	-4.95	58.62	74.00	-15.38	PEAK

Average

Test Site:	96602 - WG	Standard:	Part 15.407
Test Mode:	802.11ax HE40 5310 MHz		
Polarization:	Horizontal		
ReMark:			

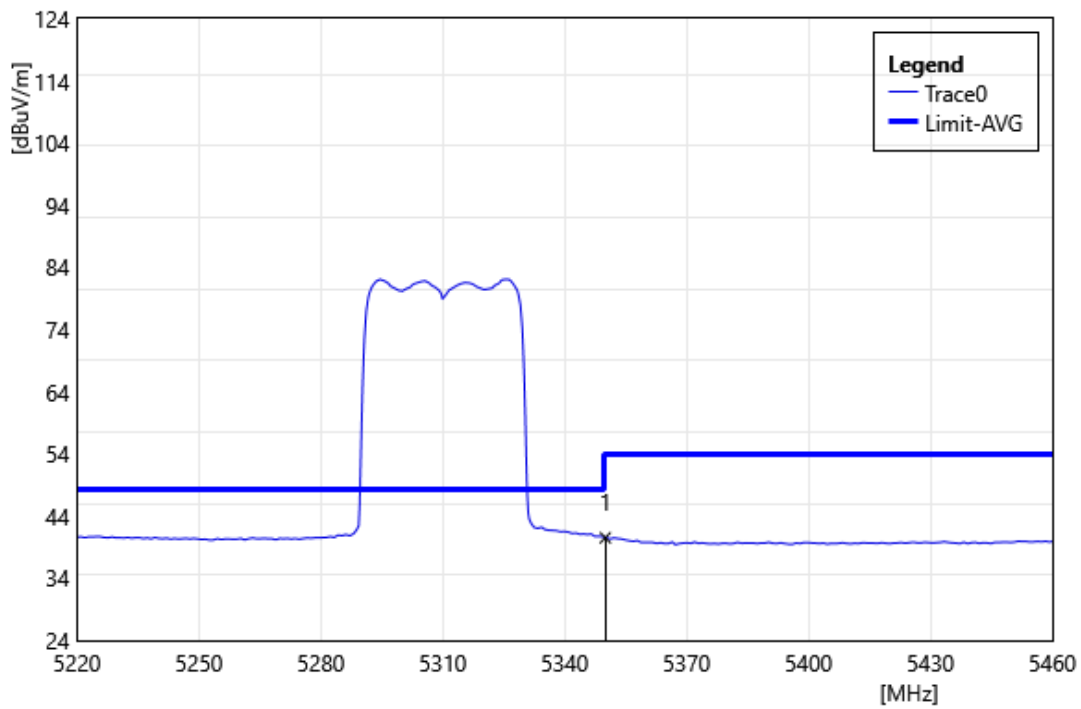

ID	Frequency MHz	Reading dBuV	Correct Factor dB/m	Result dBuV/m	Limit dBuV/m	Margin dB	ReMark
1	5350.00	45.47	-4.96	40.51	54.00	-13.49	AVG

Test Site:	96602 - WG	Standard:	Part 15.407
Test Mode:	802.11ax HE40 5310 MHz		
Polarization:	Vertical		
ReMark:			

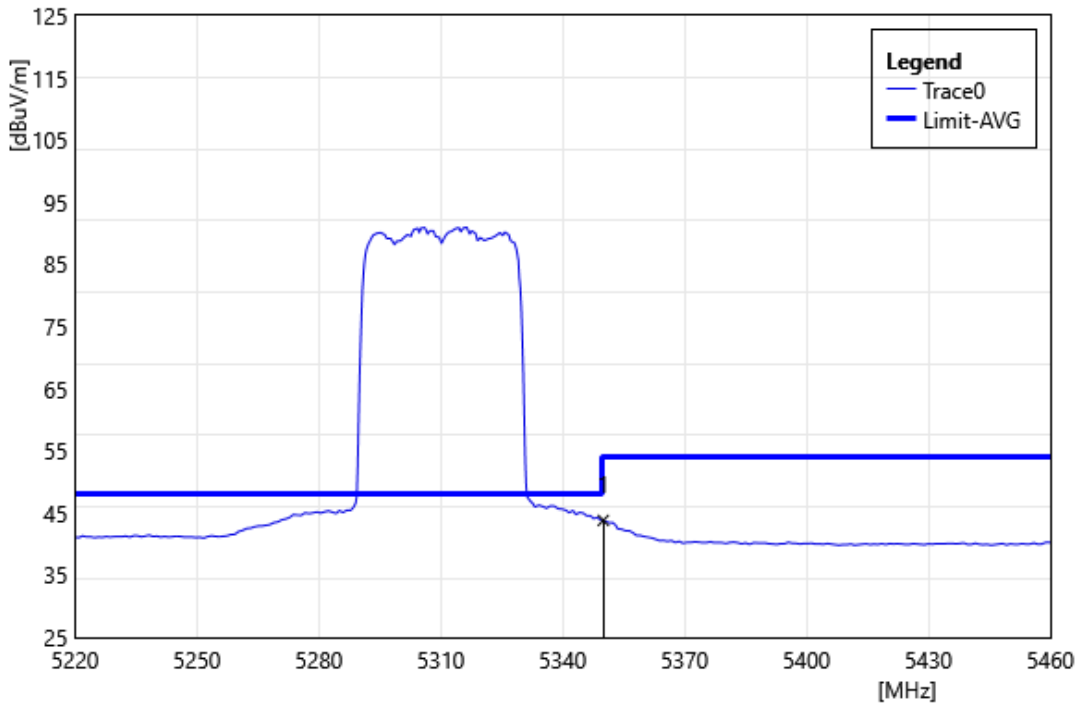

ID	Frequency MHz	Reading dBuV	Correct Factor dB/m	Result dBuV/m	Limit dBuV/m	Margin dB	ReMark
1	5350.00	48.78	-4.96	43.82	54.00	-10.18	AVG

Antenna model number: custom

Band Edge

Peak

Test Site:	96602 - WG	Standard:	Part 15.407
Test Mode:	802.11ac VHT80 5290 MHz		
Polarization:	Horizontal		
ReMark:			

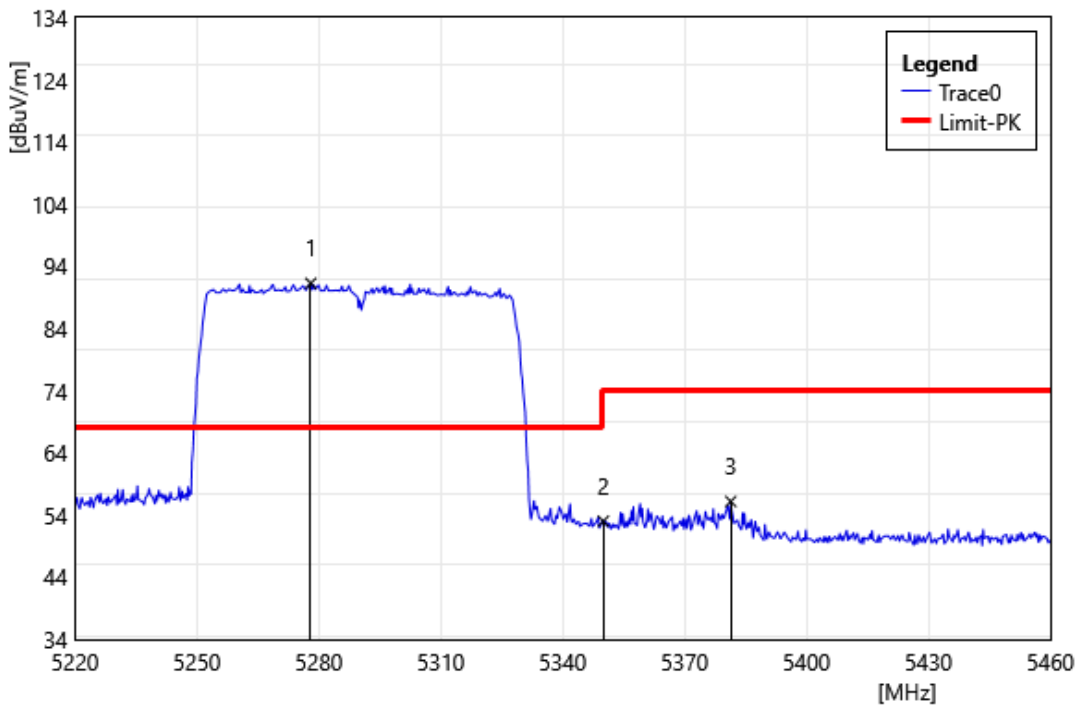

ID	Frequency MHz	Reading dBuV	Correct Factor dB/m	Result dBuV/m	Limit dBuV/m	Margin dB	ReMark
1	5278.02	96.08	-4.81	91.27	68.20	23.07	PEAK
2	5350.00	57.97	-4.96	53.02	74.00	-20.99	PEAK
3	5381.36	61.07	-4.89	56.18	74.00	-17.82	PEAK

Test Site:	96602 - WG	Standard:	Part 15.407
Test Mode:	802.11ac VHT80 5290 MHz		
Polarization:	Vertical		
ReMark:			

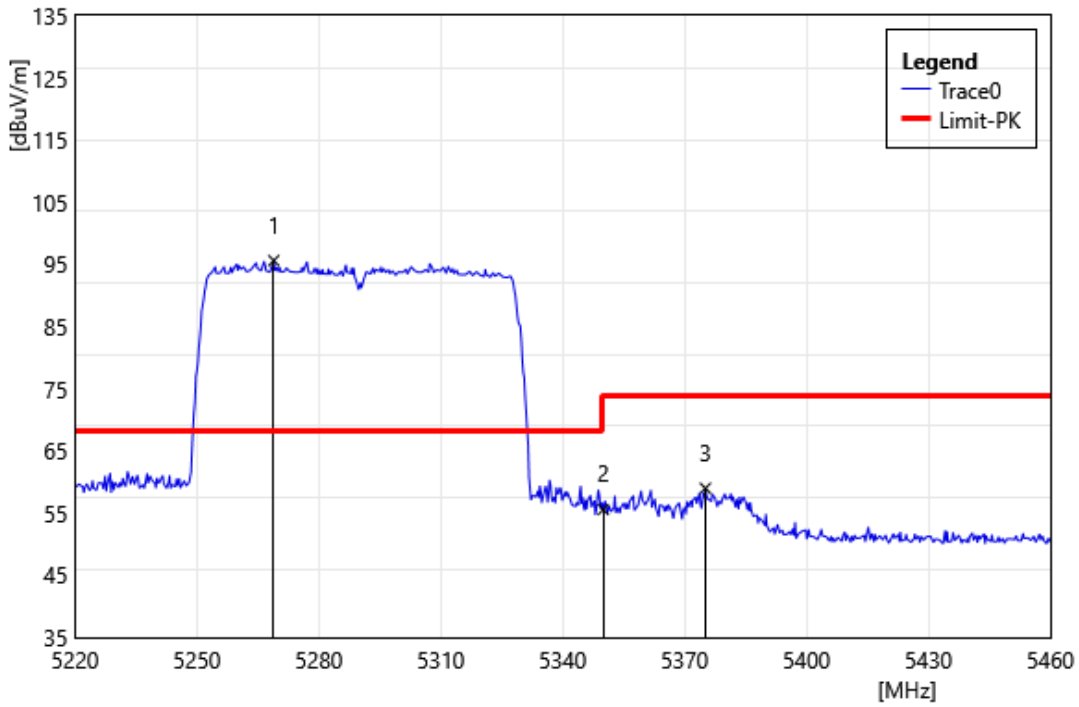

ID	Frequency MHz	Reading dBuV	Correct Factor dB/m	Result dBuV/m	Limit dBuV/m	Margin dB	ReMark
1	5268.91	100.37	-4.77	95.60	68.20	27.40	PEAK
2	5350.00	60.54	-4.96	55.58	74.00	-18.42	PEAK
3	5375.12	63.88	-4.90	58.98	74.00	-15.02	PEAK

Average

Test Site:	96602 - WG	Standard:	Part 15.407
Test Mode:	802.11ac VHT80 5290 MHz		
Polarization:	Horizontal		
ReMark:			

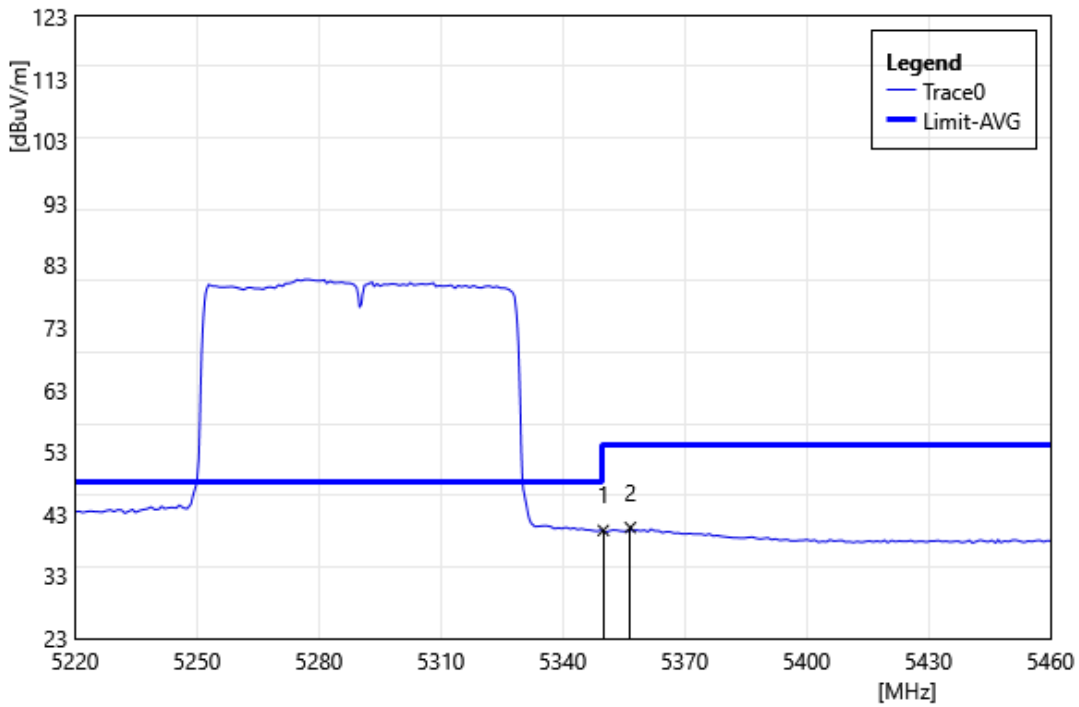

ID	Frequency MHz	Reading dBuV	Correct Factor dB/m	Result dBuV/m	Limit dBuV/m	Margin dB	ReMark
1	5350.00	45.33	-4.96	40.37	54.00	-13.63	AVG
2	5356.66	45.77	-4.95	40.82	54.00	-13.18	AVG

Test Site:	96602 - WG	Standard:	Part 15.407
Test Mode:	802.11ac VHT80 5290 MHz		
Polarization:	Vertical		
ReMark:			

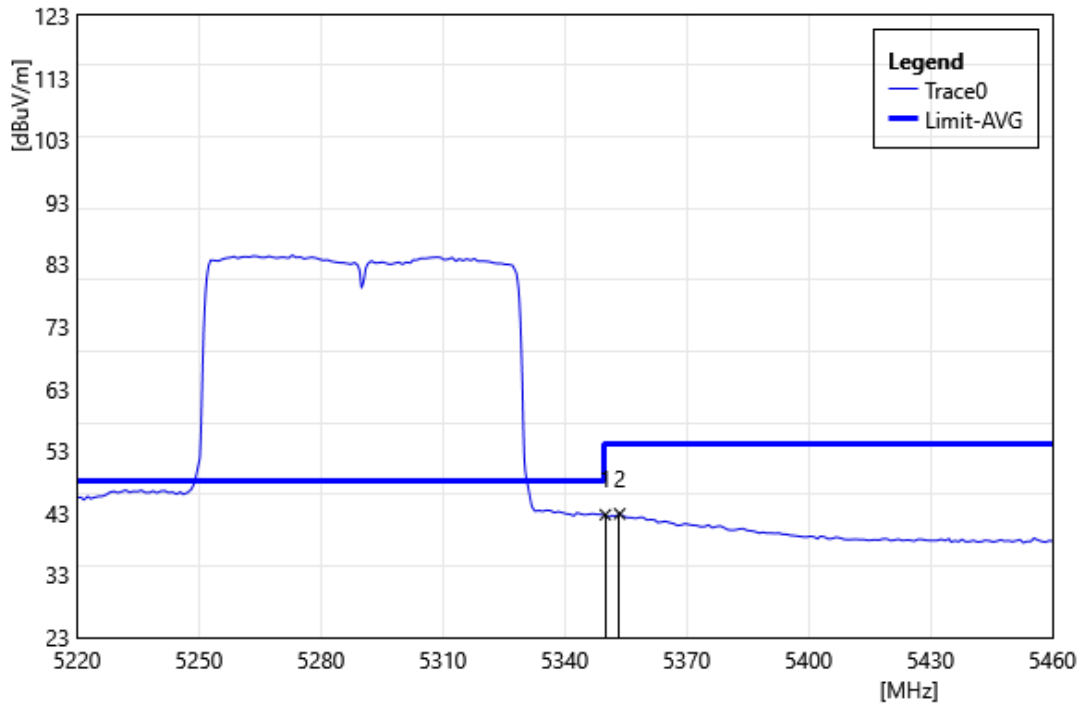

ID	Frequency MHz	Reading dBuV	Correct Factor dB/m	Result dBuV/m	Limit dBuV/m	Margin dB	ReMark
1	5350.00	47.69	-4.96	42.73	54.00	-11.27	AVG
2	5353.55	47.82	-4.95	42.87	54.00	-11.13	AVG

---END---