

## RF Test Report

Applicant : u-blox AG

Product Name : Host-based multiradio module

Trade Name : u-blox

Model Number : MAYA-W276-00B

Applicable Standard : FCC 47 CFR PART 15 SUBPART C  
ANSI C63.10:2013

Received Date : Nov. 09, 2023

Test Period : Nov. 27 ~ Dec. 01, 2023

Issued Date : Dec. 22, 2023

### Issued by

Eurofins E&E Wireless Taiwan Co., Ltd.  
No. 140-1, Changan Street, Bade District,  
Taoyuan City 334025, Taiwan (R.O.C.)  
Tel : +886-3-2710188 / Fax : +886-3-2710190  
Taiwan Accreditation Foundation accreditation number: 1330  
Frequency Range: 9 kHz to 325 GHz  
Test Firm Registration Number: 226252 (Bade test site)  
Test Firm Registration Number: 191812 (Wugu test site)



### Note:

- 1.The test results are valid only for samples provided by customers and under the test conditions described in this report.
- 2.This report shall not be reproduced except in full, without the written approval of Eurofins E&E Wireless Taiwan Co., Ltd.
- 3.The relevant information is provided by customers in this test report. According to the correctness, appropriateness or completeness of the information provided by the customer, if there is any doubt or error in the information which affects the validity of the test results, the laboratory does not take the responsibility.

### Revision History

Rev.	Issued Date	Description	Revised by
00	Dec. 22, 2023	Initial Issue	Abby Huang

## Verification of Compliance

Applicant : u-blox AG  
 Product Name : Host-based multiradio module  
 Trade Name : u-blox  
 Model Number : MAYA-W276-00B  
 FCC ID : XPYMAYAW2B  
 Applicable Standard : FCC 47 CFR PART 15 SUBPART C  
 ANSI C63.10:2013  
 Test Result : Complied

Performing Lab. : Eurofins E&E Wireless Taiwan Co., Ltd.  
 No. 140-1, Changan Street, Bade District,  
 Taoyuan City 334025, Taiwan (R.O.C.)  
 Tel : +886-3-2710188 / Fax : +886-3-2710190  
Taiwan Accreditation Foundation accreditation number: 1330



Eurofins E&E Wireless Taiwan Co., Ltd. tested the above equipment in accordance with the requirements set forth in the above standards. All indications of Pass/Fail in this report are opinions expressed by Eurofins E&E Wireless Taiwan Co., Ltd. based on interpretations and/or observations of test results. The test results show that the equipment tested is capable of demonstrating compliance with the requirements as documented in this report.

Approved By : \_\_\_\_\_

## TABLE OF CONTENTS

<b>1</b>	<b>General Information .....</b>	<b>5</b>
1.1.	Summary of Test Result .....	5
1.2.	Testing Location .....	6
1.3.	Measurement Uncertainty .....	6
1.4.	Test Site Environment.....	6
<b>2</b>	<b>EUT Description.....</b>	<b>7</b>
<b>3</b>	<b>Test Methodology.....</b>	<b>8</b>
3.1.	Mode of Operation.....	8
3.2.	EUT Test Step .....	8
3.3.	Configuration of Test System Details.....	9
3.4.	Test Instruments .....	10
<b>4</b>	<b>Measurement Procedure.....</b>	<b>11</b>
4.1.	AC Power Line Conducted Emission Measurement.....	11
4.2.	Radiated Emission Measurement.....	13
<b>5</b>	<b>Test Results .....</b>	<b>16</b>
5.1.	Conducted Emission .....	16
5.2.	Radiated Emission Measurement.....	20

### Appendix A. Test Setup Photographs

# 1 General Information

## 1.1. Summary of Test Result

Standard	Item	Result	Remark
15.207	AC Power Conducted Emission	PASS	-----
15.247(d)	Transmitter Radiated Emissions	PASS	Note 2
15.247(b)(3)	Max. Output Power	N/A	Note 1
15.247(a)(2)	6 dB RF Bandwidth	N/A	Note 1
15.247(e)	Maximum Power Spectral Density	N/A	Note 1
15.247(d)	Out of Band Conducted Spurious Emission	N/A	Note 1
15.203	Antenna Requirement	N/A	Note 1

Note 1: Class II permissive change. No need for verification.

Note 2: Only verify the Transmitter Radiated Emissions (Band Edge).

### Decision Rule

- Uncertainty is not included.
- Uncertainty is included.

Standard	Description
CFR47, Part 15, Subpart C	Intentional Radiators
ANSI C63. 10: 2013	American National Standard of Procedures for Compliance Testing of Unlicensed Wireless Devices
KDB 558074 D01 15.247 Meas Guidance v05r02	GUIDANCE FOR COMPLIANCE MEASUREMENTS ON DIGITAL TRANSMISSION SYSTEM, FREQUENCY HOPPING SPREAD SPECTRUM SYSTEM, AND HYBRID SYSTEM DEVICES OPERATING UNDER SECTION 15.247 OF THE FCC RULES
KDB 662911 D01 v02r01	Emissions Testing of Transmitters with Multiple Outputs in the Same Band (e.g., MIMO, Smart Antenna, etc)

## 1.2. Testing Location

Lab Name: Eurofins E&E Wireless Taiwan Co., Ltd.  
 Site Address:  No. 140-1, Changan Street, Bade District, Taoyuan City 334025, Taiwan (R.O.C.)  
 Site Address:  No. 2, Wuquan 5th Rd. Wugu Dist., New Taipei City, Taiwan (R.O.C.)

## 1.3. Measurement Uncertainty

Test Item	Frequency	Uncertainty			
		BD	WG		
Conducted Emission	150 kHz ~ 30 MHz	2.7 dB	2.6 dB		
Conducted Output Power		1.1 dB	1.1 dB		
RF Bandwidth		4.5 %	4.5 %		
Power Spectral Density		1.1 dB	1.1 dB		
Duty Cycle		1.1 %	1.0 %		
Test Item	Frequency	Uncertainty			
		96601-BD	96603-BD	96602-WG	96603-WG
Radiated Emission	9 kHz ~ 30 MHz	1.9 dB	1.9 dB	1.6 dB	1.6 dB
	30 MHz ~ 1000 MHz	4.9 dB	4.9 dB	4.8 dB	4.8 dB
	1000 MHz ~ 18000 MHz	4.9 dB	5.0 dB	5.0 dB	5.2 dB
	18000 MHz ~ 26500 MHz	4.3 dB	4.4 dB	4.4 dB	4.5 dB
	26500 MHz ~ 40000 MHz	4.5 dB	4.5 dB	4.6 dB	4.5 dB

## 1.4. Test Site Environment

Items	Required (IEC 60068-1)	Interval(*)
Temperature (°C)	15-35	20-30
Humidity (%RH)	25-75	45-75

(\*)The measurement ambient temperature is within this range.

## 2 EUT Description

The product specifications of the EUT presented in the report are declared by the manufacturer who shall take full responsibility for the authenticity(except Max. RF Output Power).

Applicant	u-blox AG Zürcherstrasse 68, 8800 Thalwil, Switzerland			
Product Name	Host-based multiradio module			
Trade Name	u-blox			
Model Number	MAYA-W276-00B			
FCC ID	XPYMAW2B			
Operate Freq. Band	Frequency Range (MHz)	Modulation	Channel Bandwidth	Data Rate (ns)
802.11b	2412 ~ 2462	DSSS	20 MHz	Up to 11 Mbps
802.11g	2412 ~ 2462	OFDM	20 MHz	Up to 54 Mbps
802.11n HT20	2412 ~ 2462	OFDM	20 MHz	Up to MCS7
802.11n HT40	2422 ~ 2452	OFDM	40 MHz	Up to MCS7
802.11ax HE20	2412 ~ 2462	OFDMA	20 MHz	Up to MCS11
802.11ax HE40	2422 ~ 2452	OFDMA	40 MHz	Up to MCS11
Antenna information	Model Number	Type	Max. Gain (dBi)	
	ANT-DB1-RAF-SAM	External(dipole)	4.1	
	custom	Integrated	-4.1	
Operate Temp. Range	-40 ~ +85 °C			
EUT Power Rating	3.3 V			

Frequency Band	Max. RF Output Power (W)
802.11b	0.224
802.11g	0.135
802.11n HT20	0.135
802.11n HT40	0.129
802.11ax HE20	0.054
802.11ax HE40	0.033

### EUT Modify Description :

Modify Description :

1. C44 and C47 shifted down by hundreds of micrometers. Buffer capacitors only. No impact expected on RF Performance / Characteristics.
2. New Module Shield added. Larger cutout on bottom side. No impact expected on RF Performance / Characteristics. No/Low impact on radiated measurements expected.
3. BGA pads on HW Rev C are solder mask defined with exposed copper pads area diameter area of 170um compared to the BGAs pads on HW Rev B which are not solder mask defined with exposed landing pads area diameter of 180um → No impact expected on RF Performance / Characteristics

After the verification of worst cast of AC Power Conducted Emission and Transmitter Radiated Emissions (Band Edge), all test data can be referred to the original report.

Original Report : USRC238221003, G0M-2302-1881-TFC247WF-W276-V01

### 3 Test Methodology

#### 3.1. Mode of Operation

Decision of Test Eurofins has verified the construction and function in typical operation. All the test modes were carried out with the EUT in normal operation, which was shown in this test report and defined as:

Pre-Test Mode	Final-Test Mode
Transmit Mode	V
802.11ax HE20	V
802.11ax HE40	V

Software used to control the EUT for staying in continuous transmitting mode was programmed.

After verification, all tests were carried out with the worst case test modes.

By preliminary testing and verifying three axis (X, Y and Z) position of EUT transmitted status, it was found that "Z axis" position was the worst, then the final test was executed the worst condition and test data were recorded in this report.

#### 3.2. EUT Test Step

1.	Setup the EUT shown on "Configuration of Test System Details".
2.	Turn on the power of all equipment.
3.	Turn on TX function.
4.	EUT run test program.



### 3.3. Configuration of Test System Details

Conducted Emissions & Radiated Emission ( Above 1GHz )

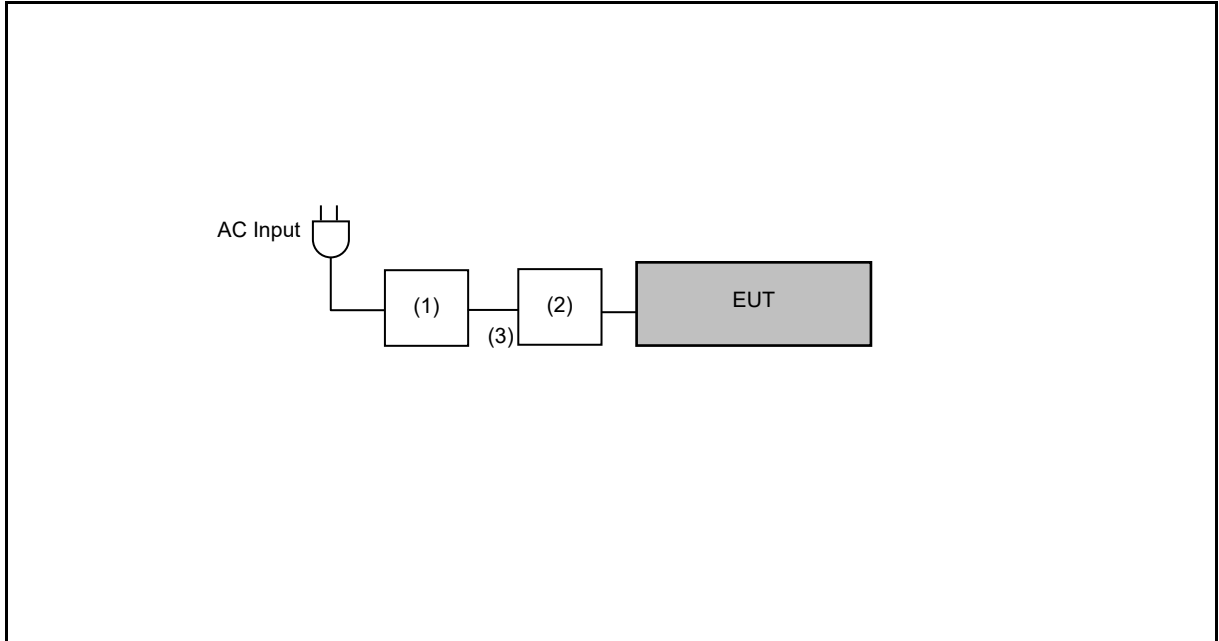

	Product	Manufacturer	Model Number	Serial Number	Power Cord
(1)	Notebook	DELL	P137G	---	---
(2)	Evaluation Kit for the i.MX 8M Mini Applications Processor	NXP	8MMINILPD4-EVKB	---	---
(3)	USB 5Gbps (USB 3.0, USB 3.x Gen 1. Superspeed) cable USB-A plug to USB-C plug 3,28' (1,00m) shielded.	CUI Devices	CBL-UA-UC-1	---	---

### 3.4. Test Instruments

For Radiated Emissions

Test Period: Nov. 27 ~ Nov. 30, 2023

Testing Engineer: Marin Lee

Radiation test sites		Semi Anechoic Room 96602-WG				
Use	Equipment	Manufacturer	Model Number	Serial Number	Cal. Date	Cal. Period
<input checked="" type="checkbox"/>	Broadband Horn Antenna (1 GHz~18 GHz)	RF SPIN	DRH18-E	210305A18ES	Feb. 21, 2023	1 year
<input checked="" type="checkbox"/>	Spectrum Analyzer (10 Hz~44 GHz)	KEYSIGHT	N9020B	MY60112362	Feb. 16, 2023	1 year
<input checked="" type="checkbox"/>	Pre-Amplifier	SGH	SGH118-EMC	20230715-3	Sep. 07, 2023	1 year
<input checked="" type="checkbox"/>	Coaxial Cable (1 GHz~18 GHz)	EMCI	EMC104-SM-SM-1000	211026	Nov. 13, 2023	1 year
<input checked="" type="checkbox"/>	Coaxial Cable (1 GHz~18 GHz)	EMCI	EMC104-SM-SM-2000	211035	Nov. 13, 2023	1 year
<input checked="" type="checkbox"/>	Coaxial Cable (1 GHz~18 GHz)	EMCI	EMC104-SM-SM-8000	211036	Nov. 13, 2023	1 year
<input checked="" type="checkbox"/>	Software	R_RAM	V1.3	N/A	N.C.R.	---

For Conduction Emissions

Test Period: Dec, 01, 2023

Testing Engineer: Marin Lee

Radiation test sites		Conducted Emission Measurement Conduction01-WG				
Use	Equipment	Manufacturer	Model Number	Serial Number	Cal. Date	Cal. Period
<input checked="" type="checkbox"/>	Test Receiver	R&S	ESR3	102919	Nov 30, 2023	1 year
<input checked="" type="checkbox"/>	LISN	R&S	ENV216	101041	Apr 12, 2023	1 year
<input checked="" type="checkbox"/>	Current Probe	R&S	EZ-17	101687	Jun 15, 2023	1 year
<input checked="" type="checkbox"/>	Cable	EMCI	EMCCFD300-BM-NM-4000	220402	Jun 08, 2023	1 year
<input checked="" type="checkbox"/>	Software	ELEKTRA	94.50.4	N.A.	N.C.R.	N.C.R.

Note: N.C.R. = No Calibration Request.

## 4 Measurement Procedure

### 4.1. AC Power Line Conducted Emission Measurement

■ **Limit**

Frequency (MHz)	Quasi-peak	Average
0.15 - 0.5	66 to 56	56 to 46
0.50 - 5.0	56	46
5.0 - 30.0	60	50

■ **Test Setup**

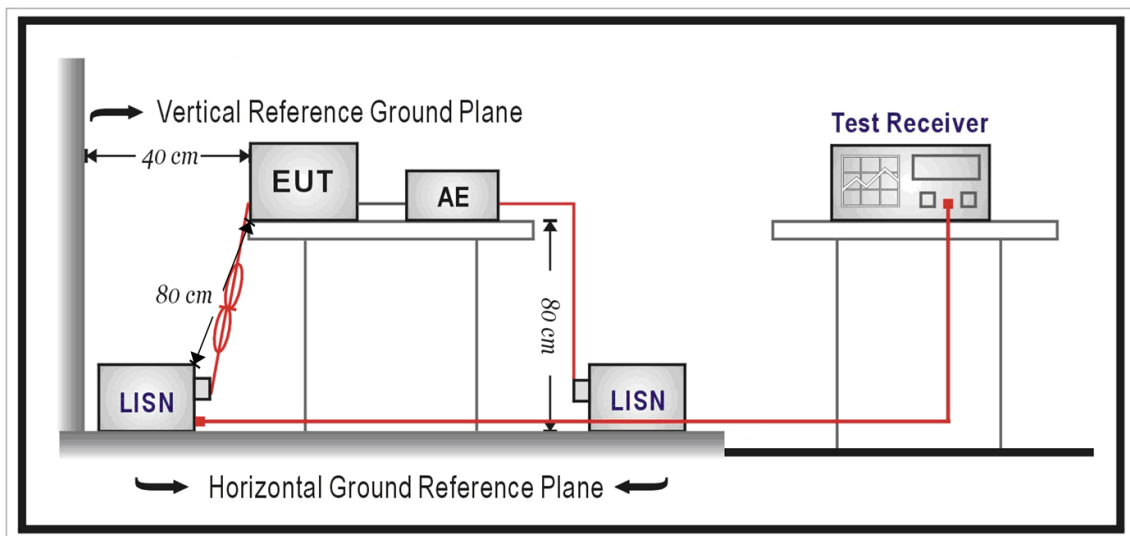

## ■ Test Procedure

The EUT and simulators are connected to the main power through a line impedance stabilization network (L.I.S.N.). This provides a  $50 \Omega // 50 \mu\text{H}$  coupling impedance for the measuring equipment. The peripheral devices are also connected to the main power through a LISN that provides a  $50 \Omega // 50 \mu\text{H}$  coupling impedance with  $50 \Omega$  termination.

Tabletop device shall be placed on a non-conducting platform, of nominal size 1 m by 1.5 m, raised 80 cm above the reference ground plane. The wall of screened room shall be located 40 cm to the rear of the EUT. Other surfaces of tabletop or floor standing EUT shall be at least 80 cm from any other ground conducting surface including one or more LISNs. For floor-standing device shall be placed under the EUT with a 12 mm insulating material.

Conducted emissions were investigated over the frequency range from 0.15 MHz to 30 MHz using a resolution bandwidth of 9 kHz. The equipment under test (EUT) shall be meet the limits in section 4.1, as applicable, including the average limit and the quasi-peak limit when using respectively, an average detector and quasi-peak detector measured in accordance with the methods described of related standard. When all of peak value were complied with quasi-peak and average limit from 150 kHz to 30 MHz then quasi-peak and average measurement was unnecessary.

The AMN shall be placed 0.8 m from the boundary of the unit under test and bonded to a ground reference plane for AMNs mounted on top of the ground reference plane. This distance is between the closest points of the AMN and the EUT. All other units of the EUT and associated equipment shall be at least 0.8 m from the AMN. If the mains power cable is longer than 1 m then the cable shall be folded back and forth at the centre of the lead to form a bundle no longer than 0.4 m. All of interconnecting cables that hang closer than 40 cm to the ground plane shall be folded back and forth in the center forming a bundle 30 cm to 40 cm long. All of EUT and AE shall be separate place more than 0.1 m. All  $50 \Omega$  ports of the LISN shall be resistively terminated into  $50 \Omega$  loads when not connected to the measuring instrument.

If the reading of the measuring receiver shows fluctuations close to the limit, the reading shall be observed for at least 15 s at each measurement frequency; the higher reading shall be recorded with the exception of any brief isolated high reading which shall be ignored.

## 4.2. Radiated Emission Measurement

### ■ Limit

According to §15.209(a), except as provided elsewhere in this subpart, the emissions from an intentional radiator shall not exceed the field strength levels specified in the following table:

Frequency (MHz)	Field Strength ( $\mu\text{V}/\text{m}$ at meter)	Measurement Distance (meters)
0.009 – 0.490	2400 / F (kHz)	300
0.490 – 1.705	24000 / F (kHz)	30
1.705 – 30.0	30	30
30 - 88	100**	3
88-216	150**	3
216-960	200**	3
Above 960	500	3

\*\* Except as provided in paragraph (g), fundamental emissions from intentional radiators operating under this Section shall not be located in the frequency bands 54-72 MHz, 76-88 MHz, 174-216 MHz or 470-806 MHz. However, operation within these frequency bands is permitted under other sections of this Part, e.g., Sections 15.231 and 15.241.

### ■ Setup

9 kHz ~ 30 MHz

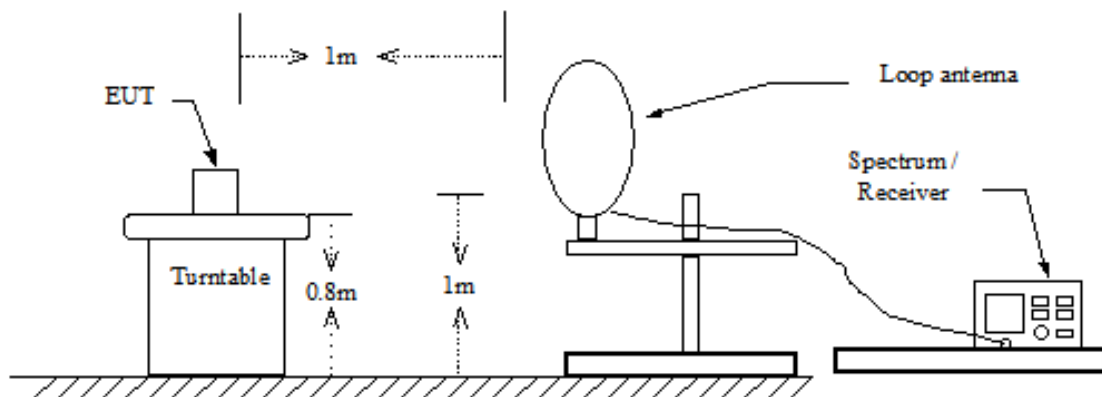

Below 1 GHz

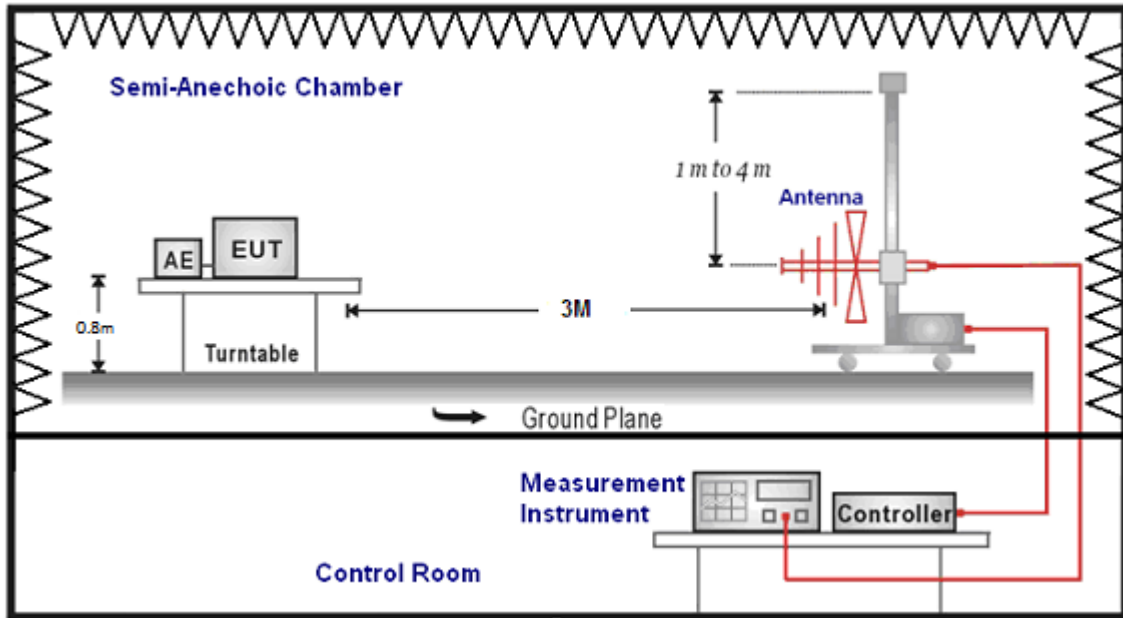

Above 1 GHz

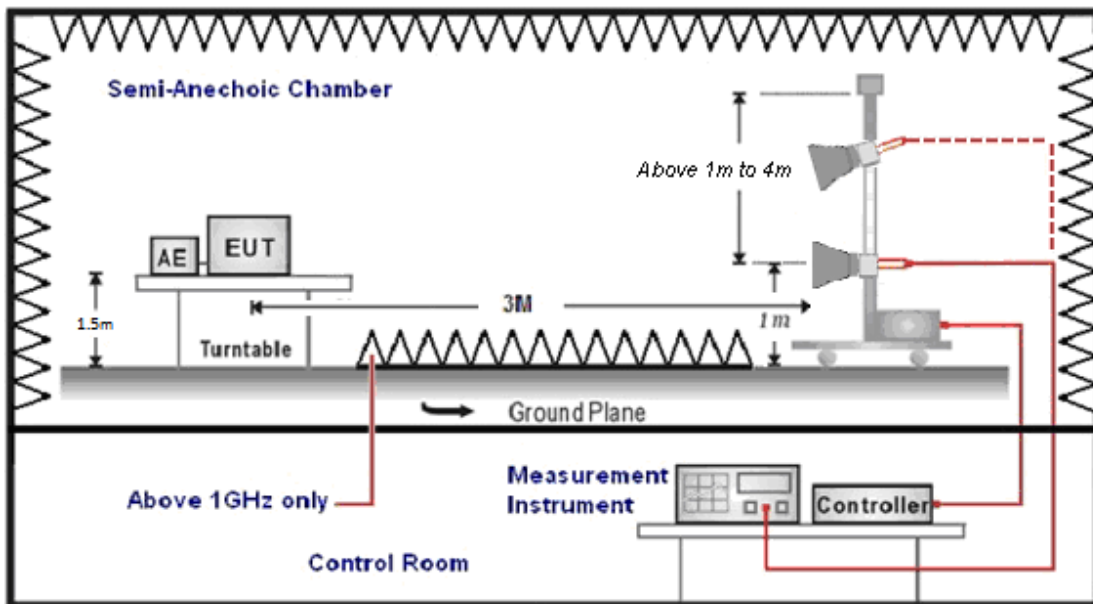

## ■ Test Procedure

Final radiation measurements were made on a three-meter, Semi Anechoic Chamber. The EUT system was placed on a nonconductive turntable which is 0.8 or 1.5 meters height, top surface 1.0 x 1.5 meter. The spectrum was examined from 250 MHz to 2.5 GHz in order to cover the whole spectrum below 10th harmonic which could generate from the EUT. During the test, EUT was set to transmit continuously & Measurements spectrum range from 9 kHz to 26.5 GHz is investigated.

For measurements below 30 MHz the resolution bandwidth is set to 10 kHz for peak detection measurements or 9 kHz for quasi-peak detection measurements. The video bandwidth is 3 times of the resolution bandwidth.

For measurements below 1 GHz the resolution bandwidth is set to 100 kHz for peak detection measurements or 120 kHz for quasi-peak detection measurements. Peak detection is used unless otherwise noted as quasi-peak.

For measurements above 1 GHz the resolution bandwidth is set to 1 MHz, and then the video bandwidth is set to 3 MHz for peak measurements and 10 Hz for average measurements when Duty cycle >0.98 / 1/T for average measurements when Duty cycle <0.98. A nonconductive material surrounded the EUT to supporting the EUT for standing on three orthogonal planes. At each condition, the EUT was rotated 360 degrees, and the antenna was raised and lowered from one to four meters to find the maximum emission levels. Measurements were taken using both horizontal and vertical antenna polarization.

SCHWARZBECK MESS-ELEKTRONIK Biconilog Antenna at 3 Meter and the SCHWARZBECK Double Ridged Guide Antenna was used in frequencies 1 –26.5 GHz at a distance of 3 meter. The antenna at an angle toward the source of the emission. All test results were extrapolated to equivalent signal at 3 meters utilizing an inverse linear distance extrapolation Factor (20 dB/decade).

For testing above 1 GHz, the emission level of the EUT in peak mode was 20 dB lower than average limit (that means the emission level in peak mode also complies with the limit in average mode), then testing will be stopped and peak values of EUT will be reported, otherwise, the emissions will be measured in average mode again and reported.

Appropriate preamplifiers were used for improving sensitivity and precautions were taken to avoid overloading or desensitizing the spectrum analyzer. No post – detector video filters were used in the test.

The spectrum analyzer's 6 dB bandwidth was set to 1 MHz, and the analyzer was operated in the peak detection mode, for frequencies both below and up 1 GHz. The average levels were obtained by subtracting the duty cycle correction factor from the peak readings.

The following procedures were used to convert the emission levels measured in decibels referenced to 1 microvolt (dBuV) into field intensity in micro volts per meter (uV/m).

The actual field intensity in decibels referenced to 1 microvolt in to field intensity in micro volts per meter (dBuV/m).

The actual field intensity in referenced to 1 microvolt per meter (dBuV/m) is determined by algebraically adding the measured reading in dBuV, the antenna factor (dB), and cable loss (dB) and Subtracting the gain of preamplifier (dB) is auto calculate in spectrum analyzer.

$$(1) \text{ Amplitude (dBuV/m) = FI (dBuV) +AF (dBuV) +CL (dBuV)-Gain (dB)}$$

FI= Reading of the field intensity.

AF= Antenna factor.

CL= Cable loss.

P.S Amplitude is auto calculate in spectrum analyzer.

$$(2) \text{ Actual Amplitude (dBuV/m) = Amplitude (dBuV)-Dis(dB)}$$

The FCC specified emission limits were calculated according the EUT operating frequency and by following linear interpolation equations:

(a) For fundamental frequency : Transmitter Output < +30 dBm

(b) For spurious frequency : Spurious emission limits = fundamental emission limit /10

Data of measurement within this frequency range without mark in the table above means the reading of emissions are attenuated more than 20 dB below the permissible limits or the field strength is too small to be measured.

## 5 Test Results

### 5.1. Conducted Emission

Antenna model number: ANT-DB1-RAF-SAM

Standard:	FCC Part 15.247	Line:	L1
Test item:	Conducted Emission	Power:	AC 120 V/60 Hz
Mode:	Transmit Mode		
Description:			

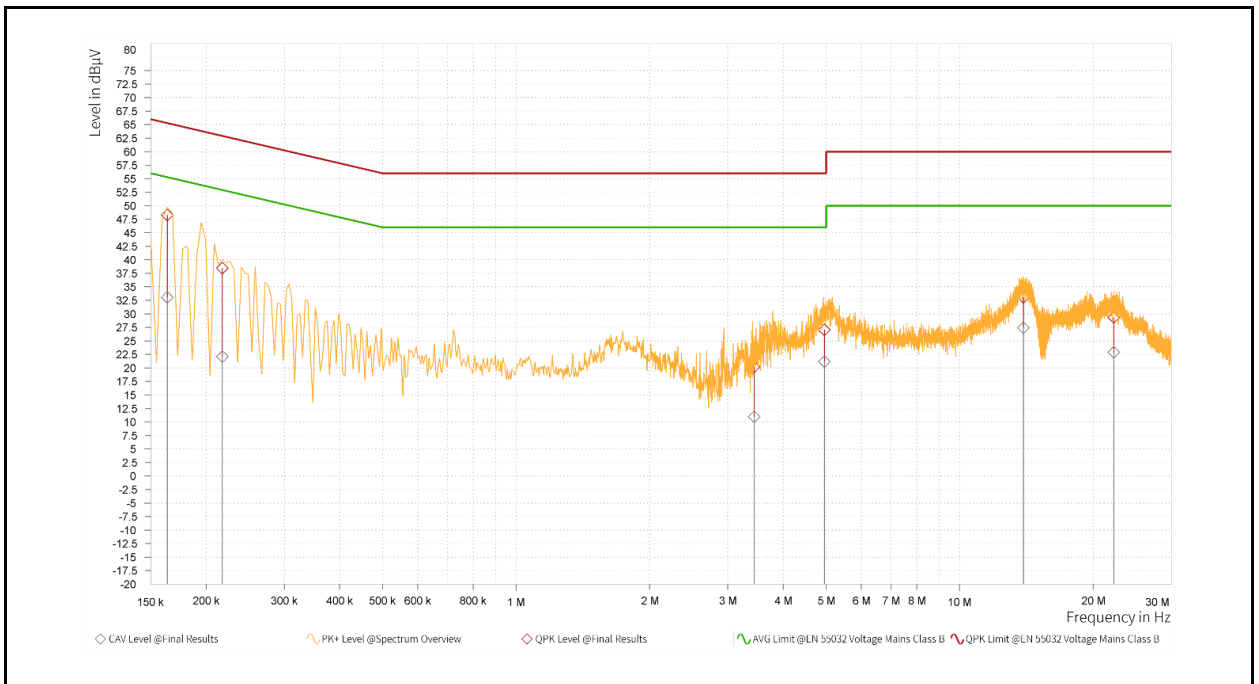

Rg	Frequency [MHz]	QP Result [dBµV]	QP Limit [dBµV]	QP Margin [dB]	AV Result [dBµV]	AV Limit [dBµV]	AV Margin [dB]	correction factor [dB]	Line
1	0.164	48.26	65.28	17.03	33.03	55.28	22.26	9.64	L1
1	0.218	38.46	62.91	24.45	22.10	52.91	30.82	9.64	L1
1	3.440	20.20	56.00	35.80	10.95	46.00	35.05	9.77	L1
1	4.952	27.03	56.00	28.97	21.15	46.00	24.85	9.81	L1
1	13.920	33.04	60.00	26.96	27.44	50.00	22.56	10.00	L1
1	22.259	29.33	60.00	30.67	22.89	50.00	27.11	10.12	L1

- Note: 1. Result (dBuV) = Correction factor (dB) + Reading(dBuV).  
 2. Correction factor (dB) = Cable loss (dB) + L.I.S.N. factor (dB).



Standard:	FCC Part 15.247	Line:	N
Test item:	Conducted Emission	Power:	AC 120 V/60 Hz
Mode:	Transmit Mode		
Description:			

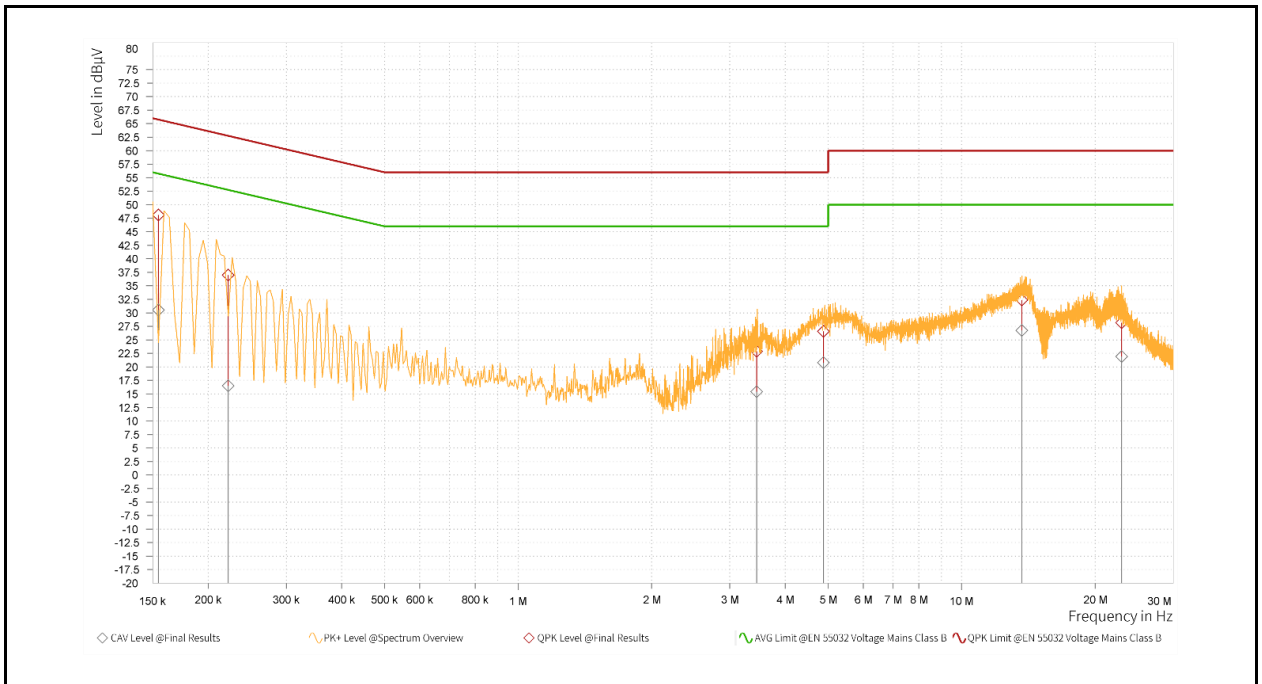

Rg	Frequency [MHz]	QP Result [dBµV]	QP Limit [dBµV]	QP Margin [dB]	AV Result [dBµV]	AV Limit [dBµV]	AV Margin [dB]	correction factor [dB]	Line
1	0.155	48.09	65.75	17.66	30.51	55.75	25.25	9.64	N
1	0.222	36.97	62.74	25.77	16.52	52.74	36.23	9.64	N
1	3.449	22.90	56.00	33.10	15.43	46.00	30.57	9.77	N
1	4.880	26.59	56.00	29.41	20.77	46.00	25.23	9.82	N
1	13.659	32.36	60.00	27.64	26.73	50.00	23.27	10.07	N
1	22.934	28.19	60.00	31.81	21.92	50.00	28.08	10.25	N

Note: 1. Result (dBuV) = Correction factor (dB) + Reading(dBuV).  
 2. Correction factor (dB) = Cable loss (dB) + L.I.S.N. factor (dB).

Antenna model number: custom

Standard:	FCC Part 15.247	Line:	L1
Test item:	Conducted Emission	Power:	AC 120 V/60 Hz
Mode:	Transmit Mode		
Description:			

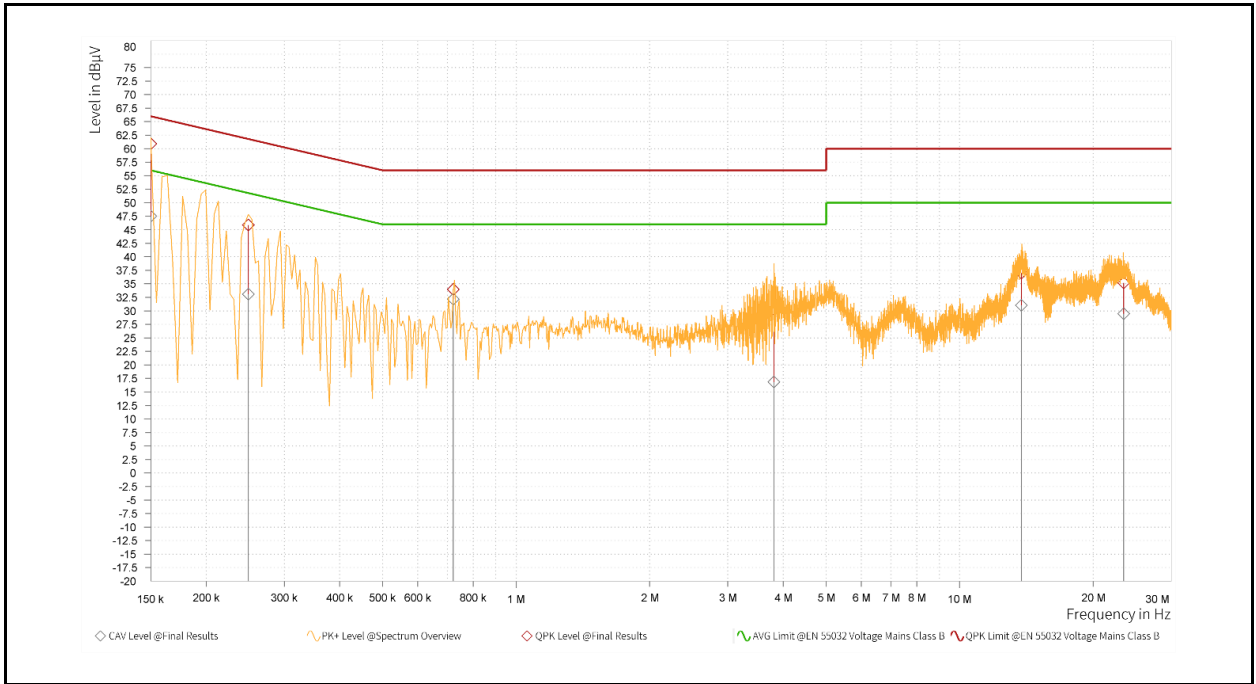

Rg	Frequency [MHz]	QP Result [dBµV]	QP Limit [dBµV]	QP Margin [dB]	AV Result [dBµV]	AV Limit [dBµV]	AV Margin [dB]	correction factor [dB]	Line
1	0.150	60.89	66.00	5.11	47.53	56.00	8.47	9.65	L1
1	0.249	45.90	61.79	15.89	33.09	51.79	18.70	9.64	L1
1	0.722	33.95	56.00	22.05	32.16	46.00	13.84	9.67	L1
1	3.813	30.29	56.00	25.71	16.86	46.00	29.14	9.77	L1
1	13.772	36.98	60.00	23.02	31.05	50.00	18.95	10.00	L1
1	23.433	35.20	60.00	24.80	29.48	50.00	20.52	10.13	L1

Note: 1. Result (dBuV) = Correction factor (dB) + Reading(dBuV).  
 2. Correction factor (dB) = Cable loss (dB) + L.I.S.N. factor (dB).

Standard:	FCC Part 15.247	Line:	N
Test item:	Conducted Emission	Power:	AC 120 V/60 Hz
Mode:	Transmit Mode		
Description:			

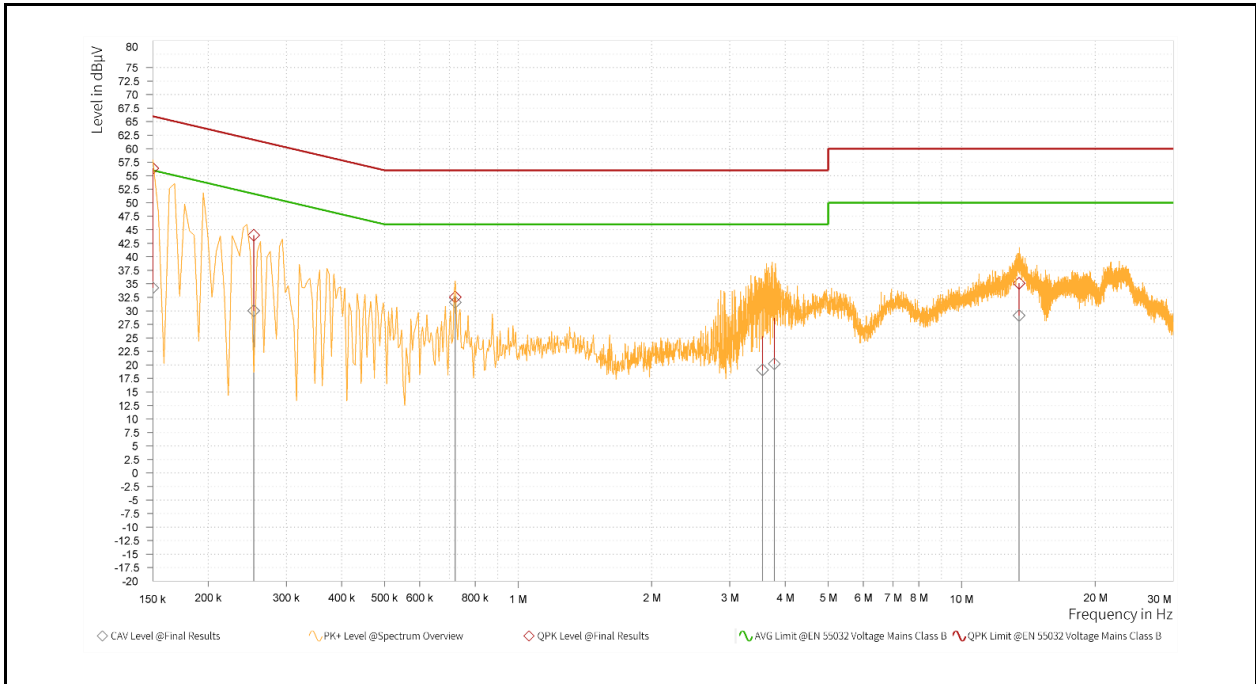

Rg	Frequency [MHz]	QP Result [dBµV]	QP Limit [dBµV]	QP Margin [dB]	AV Result [dBµV]	AV Limit [dBµV]	AV Margin [dB]	correction factor [dB]	Line
1	0.150	56.37	66.00	9.63	34.28	56.00	21.72	9.64	N
1	0.254	43.98	61.64	17.66	30.01	51.64	21.63	9.64	N
1	0.722	32.56	56.00	23.44	31.58	46.00	14.42	9.67	N
1	3.557	31.28	56.00	24.72	19.07	46.00	26.93	9.78	N
1	3.782	31.40	56.00	24.60	20.19	46.00	25.81	9.78	N
1	13.466	35.08	60.00	24.92	29.13	50.00	20.87	10.06	N

Note: 1. Result (dBuV) = Correction factor (dB) + Reading(dBuV).  
 2. Correction factor (dB) = Cable loss (dB) + L.I.S.N. factor (dB).

## 5.2. Radiated Emission Measurement

Antenna model number: ANT-DB1-RAF-SAM

### Band Edge

Peak

Test Site:	96602 - WG	Standard:	Part 15.247
Test Mode:	802.11ax HE40 2452 MHz		
Polarization:	Horizontal		
ReMark:			

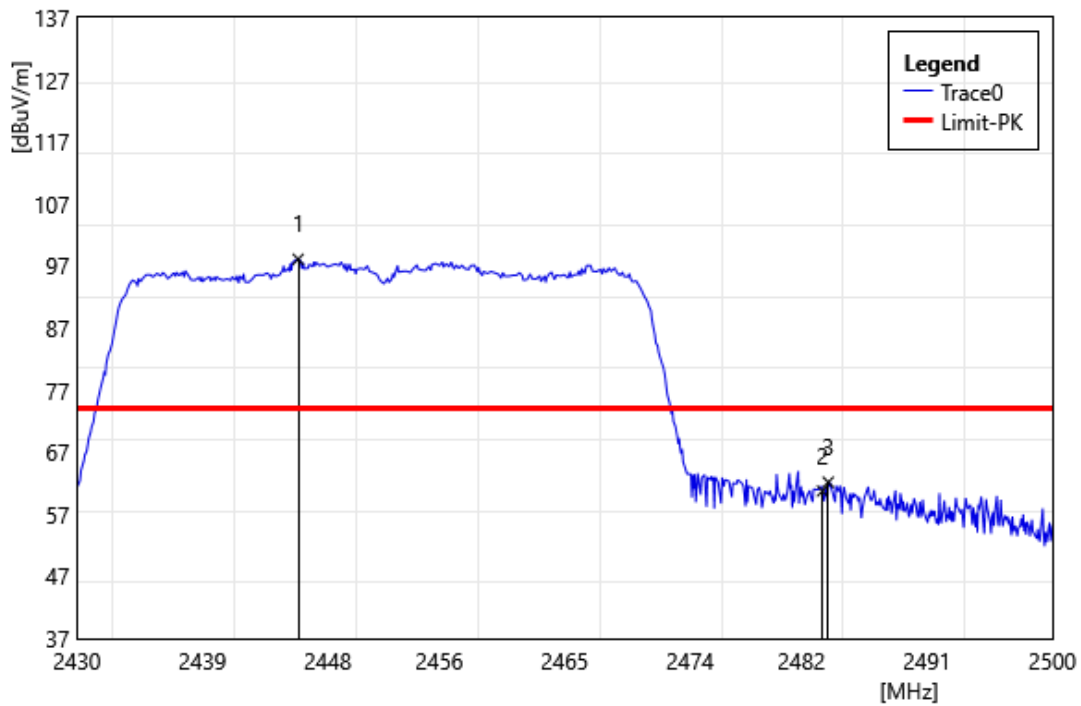

ID	Frequency MHz	Reading dBuV	Correct Factor dB/m	Result dBuV/m	Limit dBuV/m	Margin dB	ReMark
1	2445.87	106.84	-8.75	98.09	74.00	24.09	PEAK
2	2483.50	69.49	-8.74	60.75	74.00	-13.25	PEAK
3	2483.92	70.91	-8.74	62.17	74.00	-11.83	PEAK

Test Site:	96602 - WG	Standard:	Part 15.247
Test Mode:	802.11ax HE40 2452 MHz		
Polarization:	Vertical		
ReMark:			

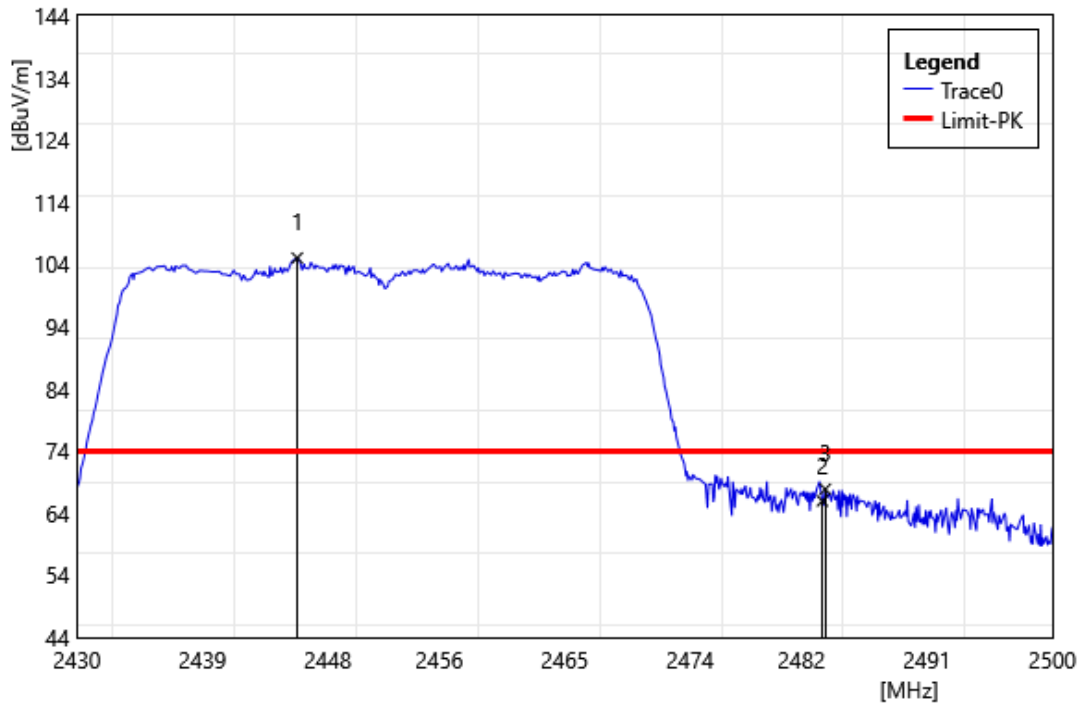

ID	Frequency MHz	Reading dBuV	Correct Factor dB/m	Result dBuV/m	Limit dBuV/m	Margin dB	ReMark
1	2445.80	113.77	-8.75	105.02	74.00	31.02	PEAK
2	2483.50	74.69	-8.74	65.95	74.00	-8.05	PEAK
3	2483.71	76.59	-8.74	67.85	74.00	-6.15	PEAK

Average

Test Site:	96602 - WG	Standard:	Part 15.247
Test Mode:	802.11ax HE40 2452 MHz		
Polarization:	Horizontal		
ReMark:			

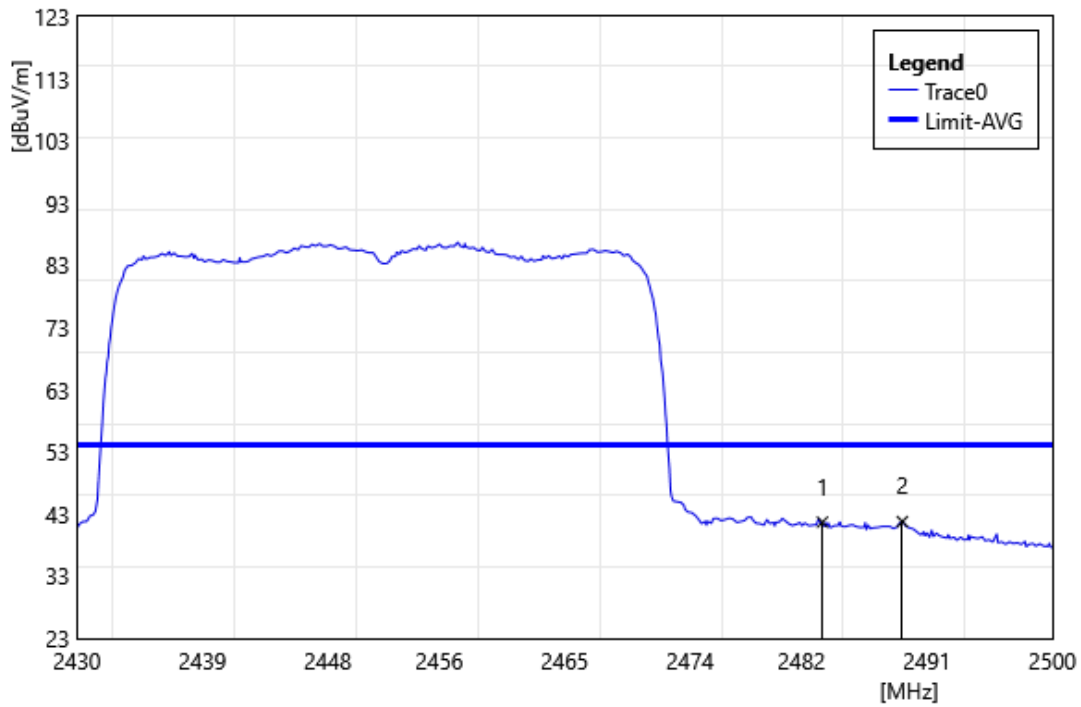

ID	Frequency MHz	Reading dBuV	Correct Factor dB/m	Result dBuV/m	Limit dBuV/m	Margin dB	ReMark
1	2483.50	50.45	-8.74	41.71	54.00	-12.29	AVG
2	2489.23	50.52	-8.73	41.79	54.00	-12.21	AVG

Test Site:	96602 - WG	Standard:	Part 15.247
Test Mode:	802.11ax HE40 2452 MHz		
Polarization:	Vertical		
ReMark:			

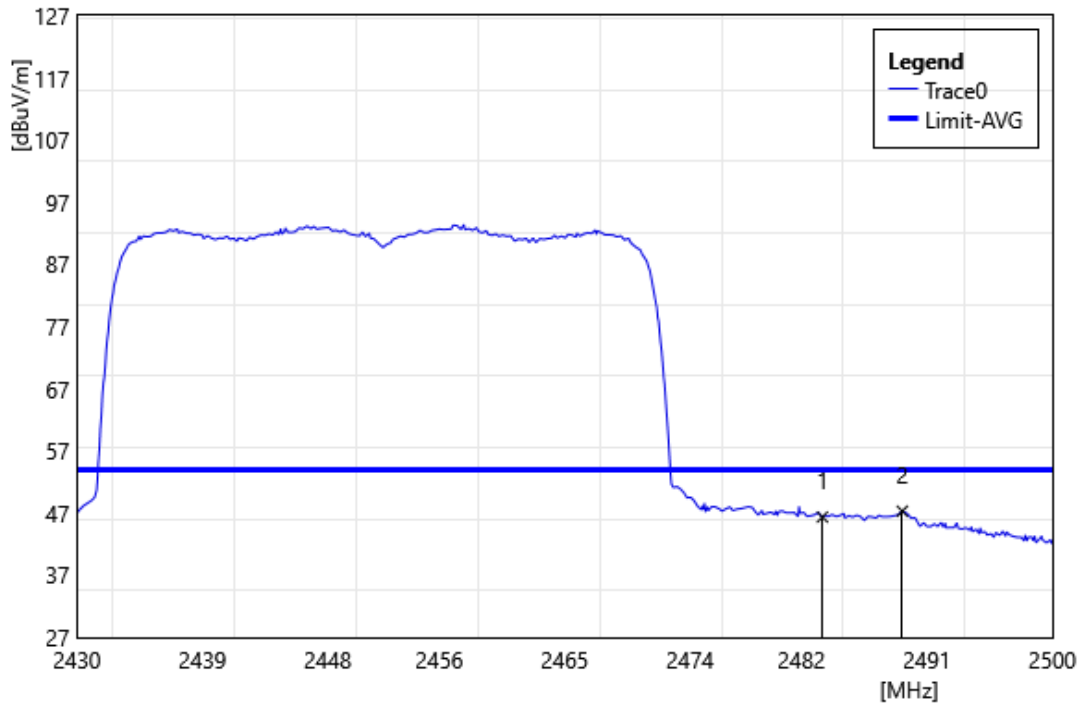

ID	Frequency MHz	Reading dBuV	Correct Factor dB/m	Result dBuV/m	Limit dBuV/m	Margin dB	ReMark
1	2483.50	55.09	-8.74	46.35	54.00	-7.65	AVG
2	2489.23	56.03	-8.73	47.30	54.00	-6.70	AVG

Antenna model number: custom

**Band Edge**

Peak

Test Site:	96602 - WG	Standard:	Part 15.247
Test Mode:	802.11ax HE20 2462 MHz		
Polarization:	Horizontal		
ReMark:			

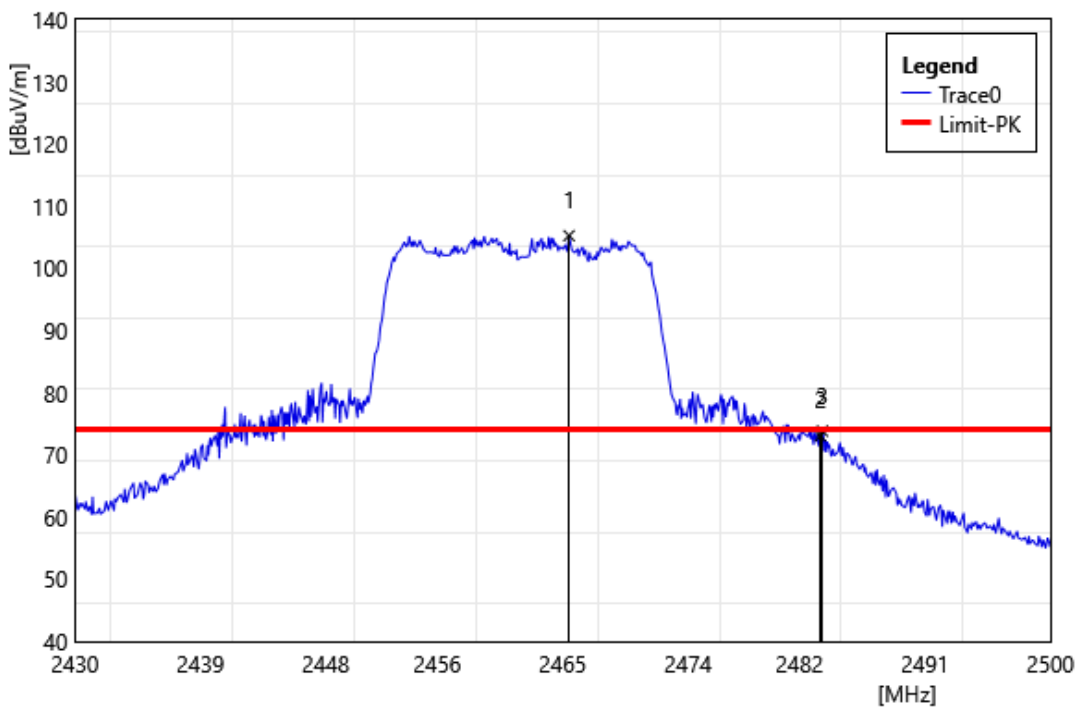

ID	Frequency MHz	Reading dBuV	Correct Factor dB/m	Result dBuV/m	Limit dBuV/m	Margin dB	ReMark
1	2465.45	114.00	-8.75	105.25	74.00	31.25	PEAK
2	2483.50	81.80	-8.74	73.06	74.00	-0.94	PEAK
3	2483.64	82.58	-8.74	73.84	74.00	-0.16	PEAK



Test Site:	96602 - WG	Standard:	Part 15.247
Test Mode:	802.11ax HE20 2462 MHz		
Polarization:	Vertical		
ReMark:			

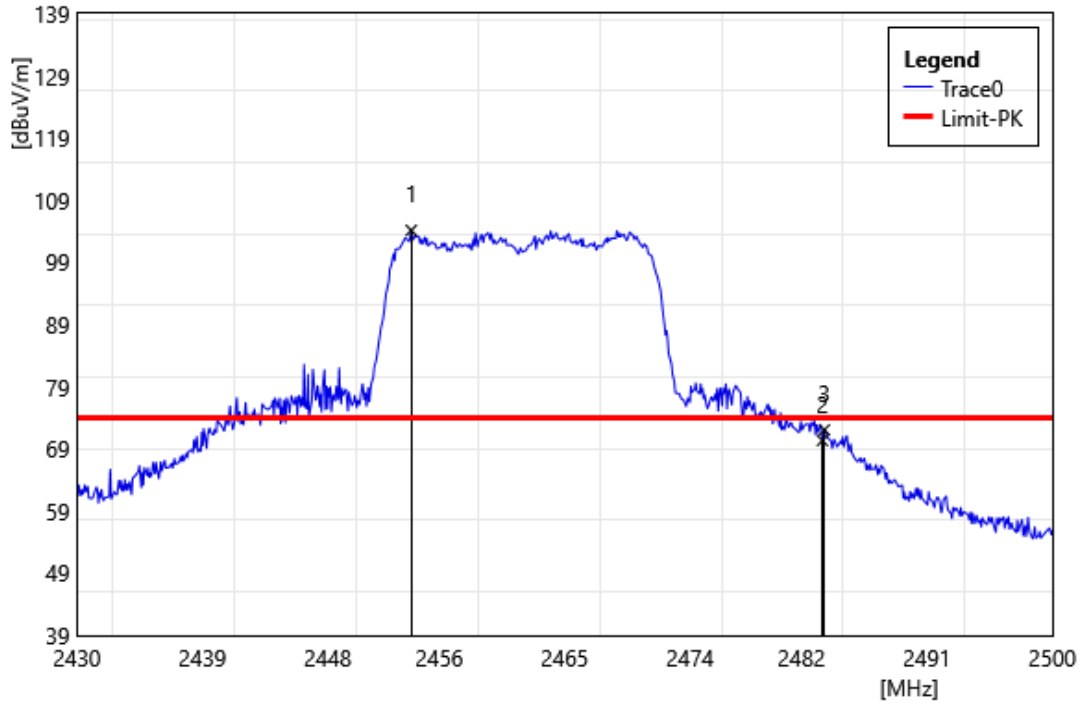

ID	Frequency MHz	Reading dBuV	Correct Factor dB/m	Result dBuV/m	Limit dBuV/m	Margin dB	ReMark
1	2453.99	112.92	-8.77	104.15	74.00	30.15	PEAK
2	2483.50	79.09	-8.74	70.35	74.00	-3.65	PEAK
3	2483.64	80.80	-8.74	72.06	74.00	-1.94	PEAK

Average

Test Site:	96602 - WG	Standard:	Part 15.247
Test Mode:	802.11ax HE20 2462 MHz		
Polarization:	Horizontal		
ReMark:			

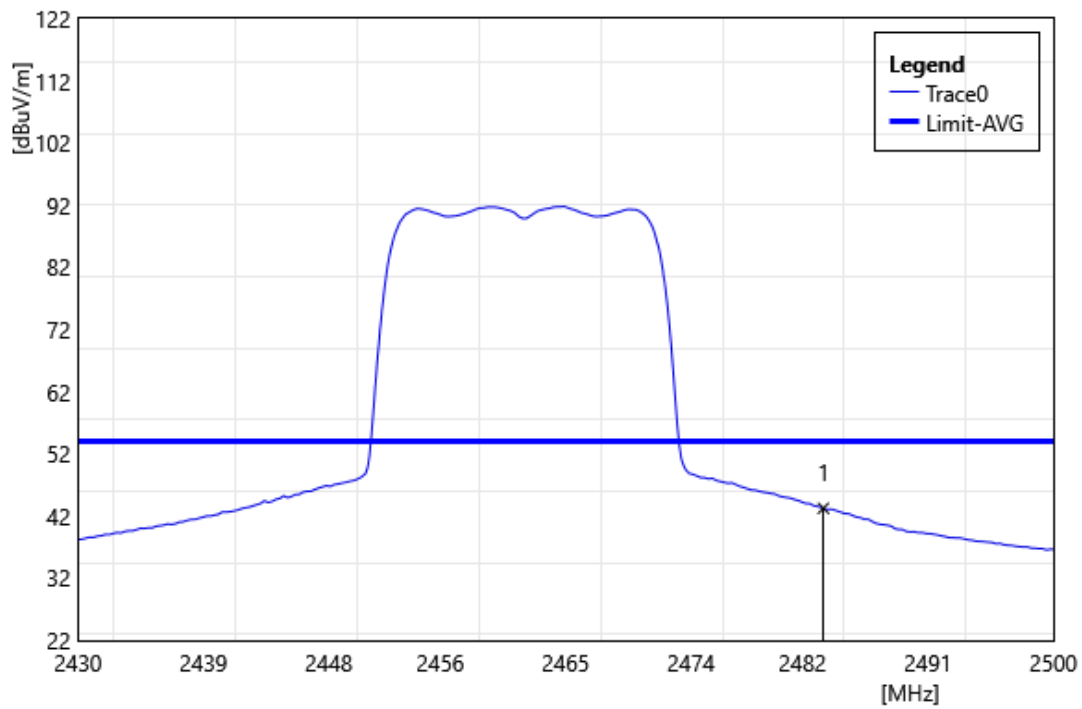

ID	Frequency MHz	Reading dBuV	Correct Factor dB/m	Result dBuV/m	Limit dBuV/m	Margin dB	ReMark
1	2483.50	51.99	-8.74	43.25	54.00	-10.75	AVG

Test Site:	96602 - WG	Standard:	Part 15.247
Test Mode:	802.11ax HE20 2462 MHz		
Polarization:	Vertical		
ReMark:			

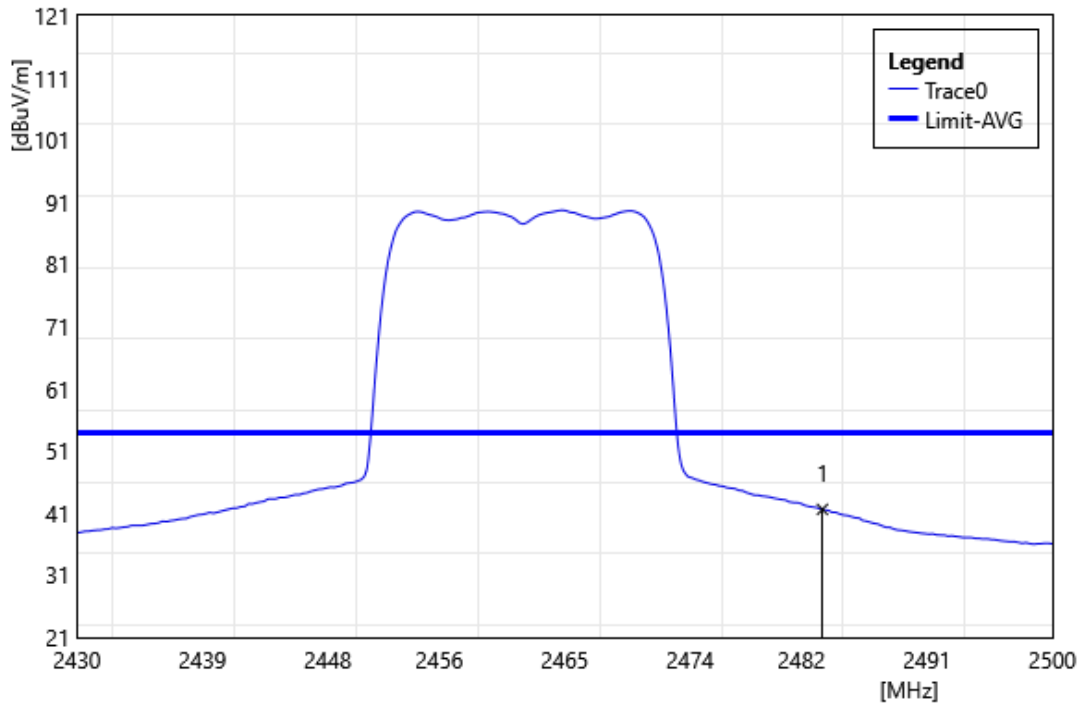

ID	Frequency MHz	Reading dBuV	Correct Factor dB/m	Result dBuV/m	Limit dBuV/m	Margin dB	ReMark
1	2483.50	50.33	-8.74	41.59	54.00	-12.41	AVG

---END---