

Radio Technology = WLAN a, Operating Frequency = mid, Measurement range = 1GHz - 26GHz, Subband = U-NII-1 (S02_166_AE01)

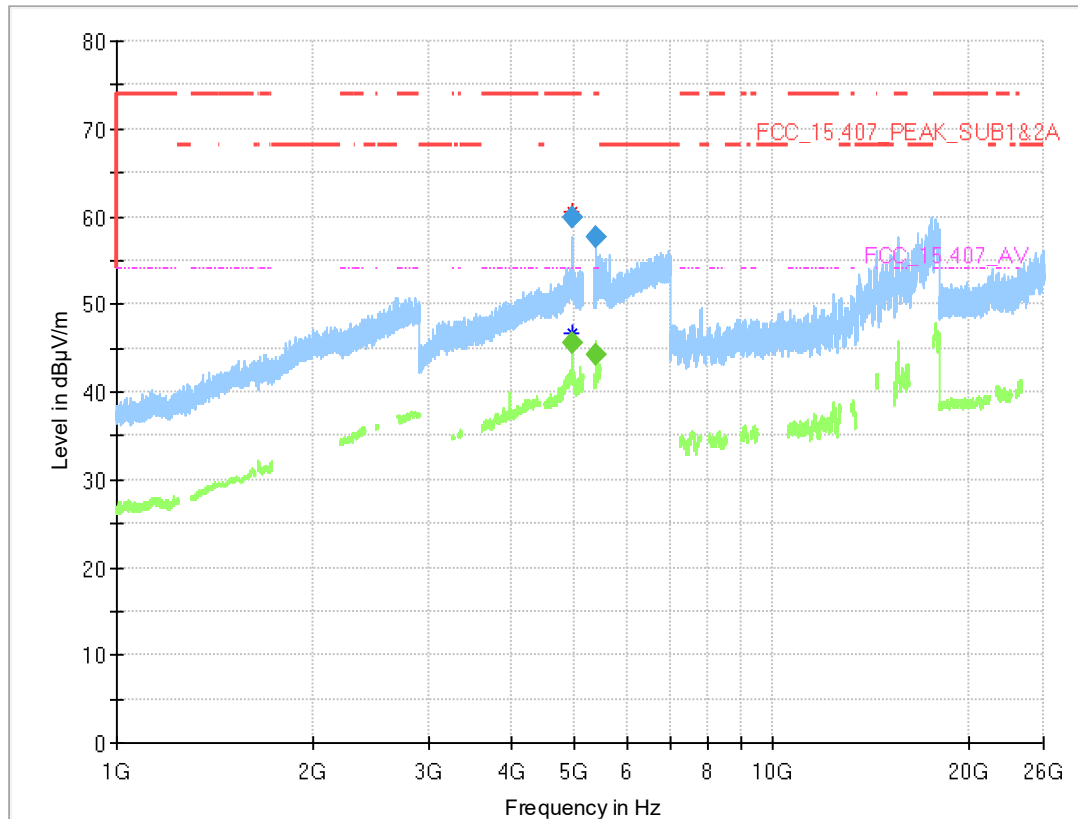

Final Result

Frequency (MHz)	MaxPeak (dBµV/m)	CAverage (dBµV/m)	Limit (dBµV/m)	Margin (dB)	Meas. Time (ms)	Bandwidth (kHz)	Height (cm)	Pol	Azimuth (deg)	Elevation (deg)	Corr. (dB/m)
4954.350	---	45.6	54.00	8.39	1000.0	1000.000	150.0	H	-144.0	-4.0	14.1
4954.350	59.9	---	74.00	14.09	1000.0	1000.000	150.0	H	-144.0	-4.0	14.1
5380.360	---	44.3	54.00	9.74	1000.0	1000.000	150.0	H	-179.0	5.0	14.3
5380.360	57.7	---	74.00	16.25	1000.0	1000.000	150.0	H	-179.0	5.0	14.3

Radio Technology = WLAN a, Operating Frequency = mid, Measurement range = 1GHz - 26GHz, Subband = U-NII-3 (S02_166_AE01)

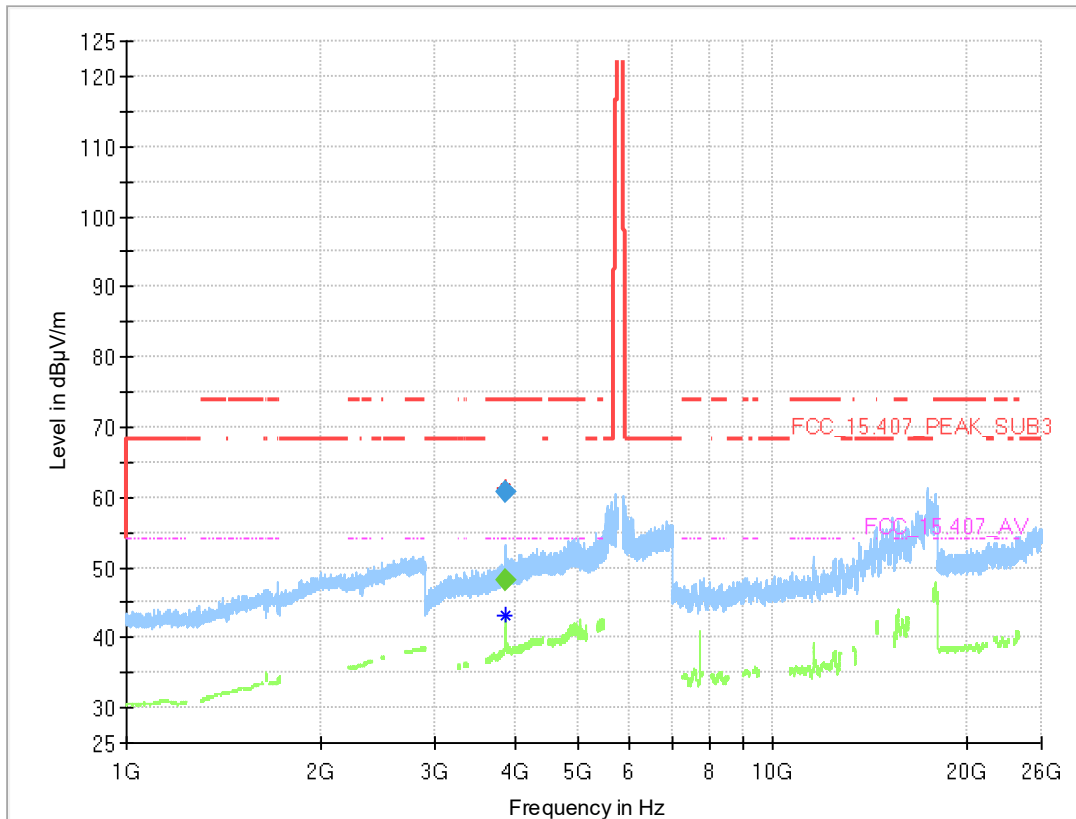

Final Result

Frequency (MHz)	MaxPeak (dBµV/m)	CAverage (dBµV/m)	Limit (dBµV/m)	Margin (dB)	Meas. Time (ms)	Bandwidth (kHz)	Height (cm)	Pol	Azimuth (deg)	Elevation (deg)	Corr. (dB)
3856.741	---	48.1	54.00	5.86	1000.0	1000.000	150.0	H	-139.0	0.0	11.4
3856.741	60.8	---	74.00	13.19	1000.0	1000.000	150.0	H	-139.0	0.0	11.4

Radio Technology = WLAN a, Operating Frequency = high, Measurement range = 1GHz - 26GHz, Subband = U-NII-3 (S02_166_AE01)

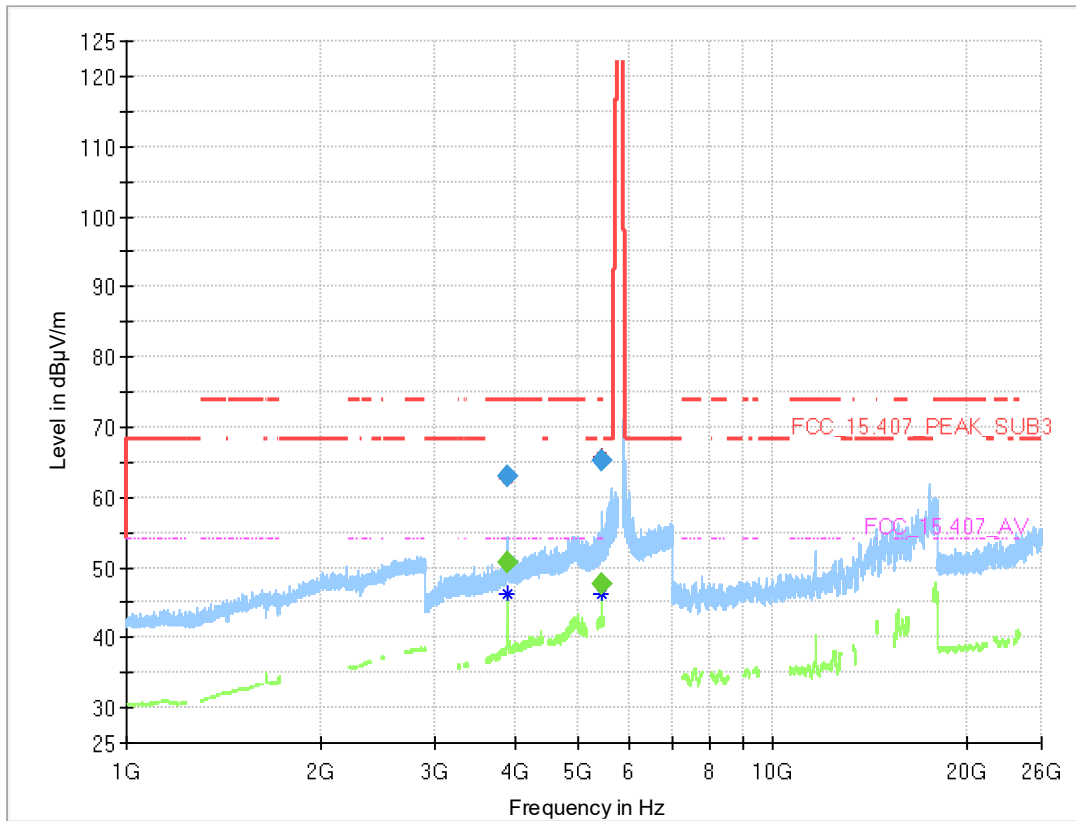

Final Result

Frequency (MHz)	MaxPeak (dBµV/m)	CAverage (dBµV/m)	Limit (dBµV/m)	Margin (dB)	Meas. Time (ms)	Bandwidth (kHz)	Height (cm)	Pol	Azimuth (deg)	Elevation (deg)	Corr. (dB)
3883.407	---	50.6	54.00	3.36	1000.0	1000.000	150.0	H	-138.0	8.0	11.7
3883.407	63.0	---	74.00	11.01	1000.0	1000.000	150.0	H	-138.0	8.0	11.7
5412.838	---	47.6	54.00	6.44	1000.0	1000.000	150.0	H	-144.0	2.0	14.5
5412.838	65.1	---	74.00	8.89	1000.0	1000.000	150.0	H	-144.0	2.0	14.5

Radio Technology = WLAN a, Operating Frequency = mid, Measurement range = 30MHz - 1GHz, Subband = U-NII-1 (S01_166_AB01)

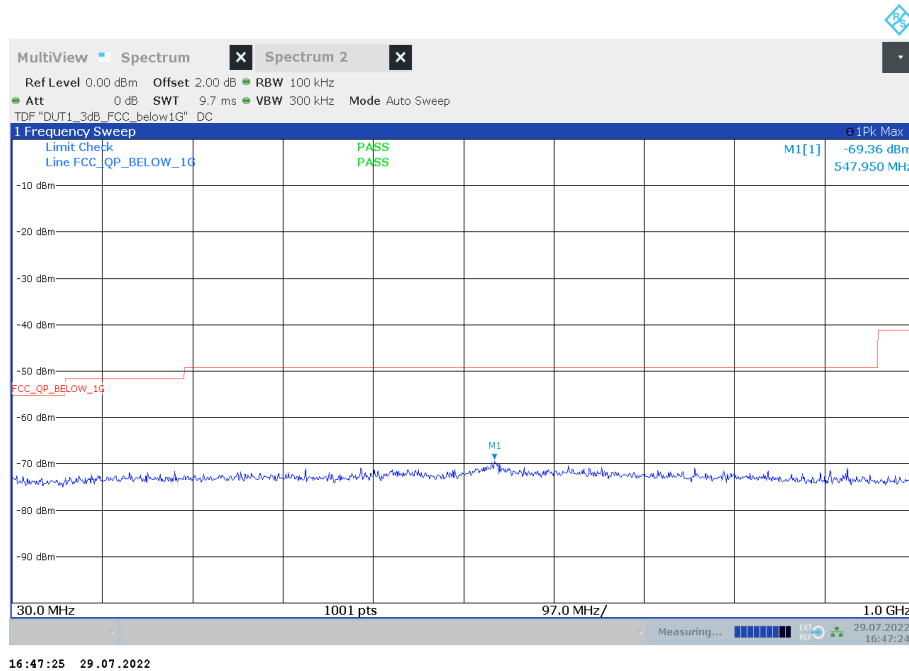

Radio Technology = WLAN a, Operating Frequency = high, Measurement range = 1GHz - 26GHz, Subband = U-NII-3 (S01_166_AB01)

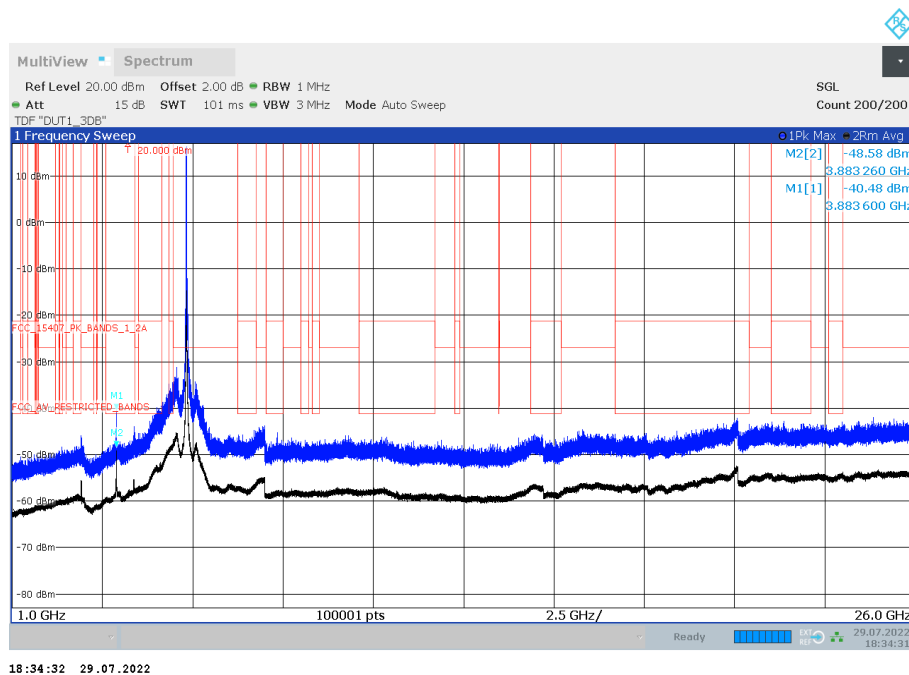

Radio Technology = WLAN n 20 MHz, Operating Frequency = high, Measurement range = 1GHz - 18GHz, Subband = U-NII-2A (S02_166_AE01)

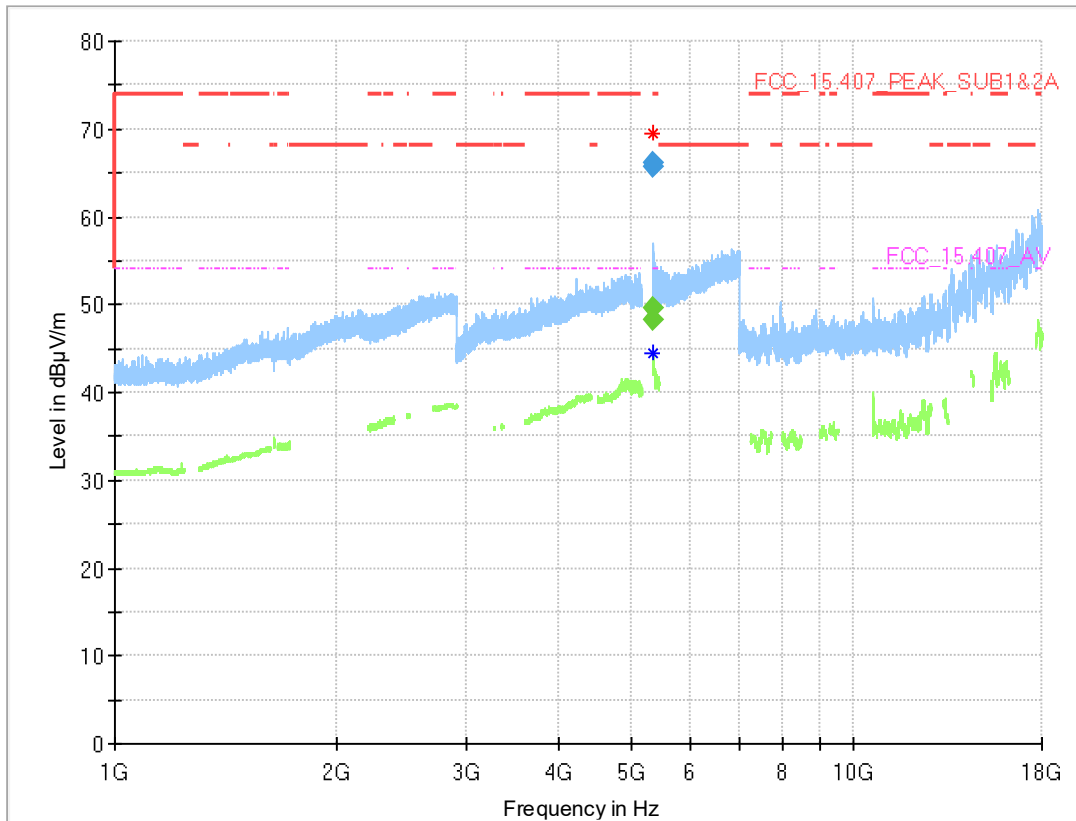

Final Result

Frequency (MHz)	MaxPeak (dBµV/m)	CAverage (dBµV/m)	Limit (dBµV/m)	Margin (dB)	Meas. Time (ms)	Bandwidth (kHz)	Height (cm)	Pol	Azimuth (deg)	Elevation (deg)	Corr. (dB/m)
5350.110	---	48.3	54.00	5.65	1000.0	1000.000	150.0	H	-131.0	8.0	14.1
5350.110	65.6	---	74.00	8.36	1000.0	1000.000	150.0	H	-131.0	8.0	14.1
5353.740	---	49.7	54.00	4.33	1000.0	1000.000	150.0	H	-144.0	2.0	14.1
5353.740	66.2	---	74.00	7.82	1000.0	1000.000	150.0	H	-144.0	2.0	14.1

Radio Technology = WLAN n 20 MHz, Operating Frequency = low, Measurement range = 1GHz - 18GHz, Subband = U-NII-2C (S02_166_AE01)

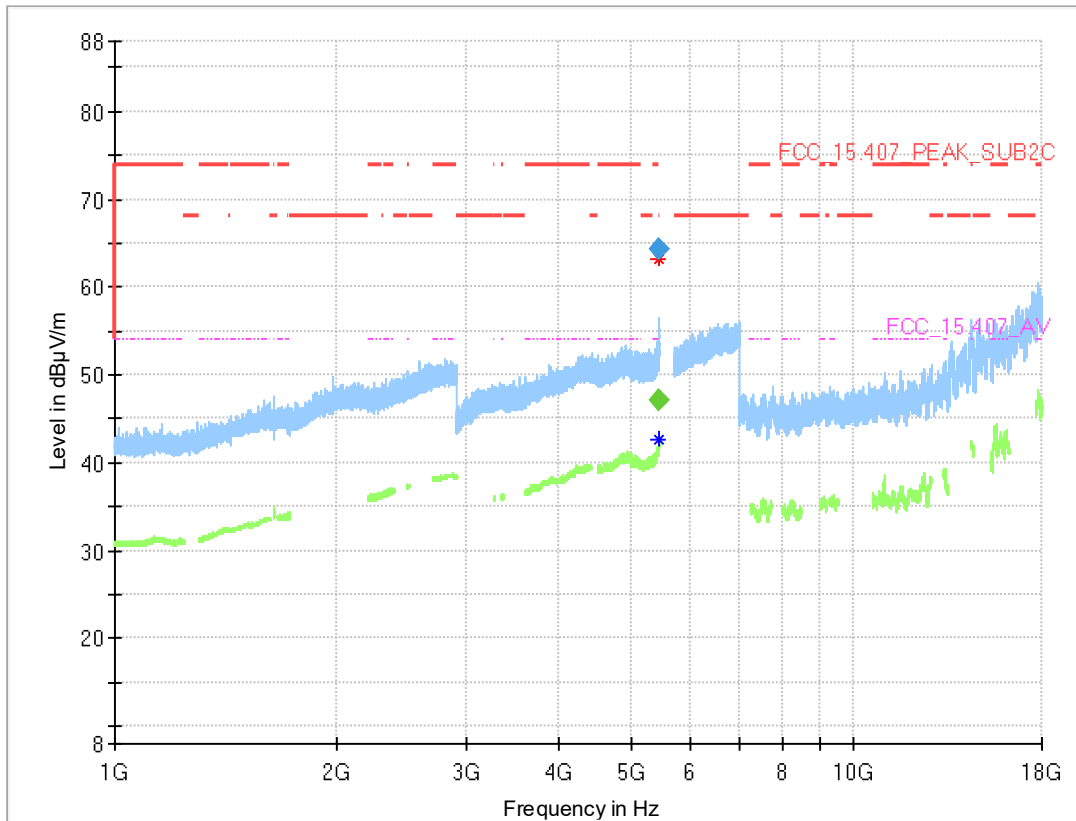

Final Result

Frequency (MHz)	MaxPeak (dBµV/m)	CAverage (dBµV/m)	Limit (dBµV/m)	Margin (dB)	Meas. Time (ms)	Bandwidth (kHz)	Height (cm)	Pol	Azimuth (deg)	Elevation (deg)	Corr. (dB/m)
5458.460	---	47.0	54.00	6.98	1000.0	1000.000	150.0	H	-141.0	10.0	14.5
5458.790	64.3	---	74.00	9.69	1000.0	1000.000	150.0	H	-143.0	2.0	14.5

Radio Technology = WLAN n 20 MHz, Operating Frequency = high, Measurement range = 1GHz - 18GHz, Subband = U-NII-3 (S02_166_AE01)

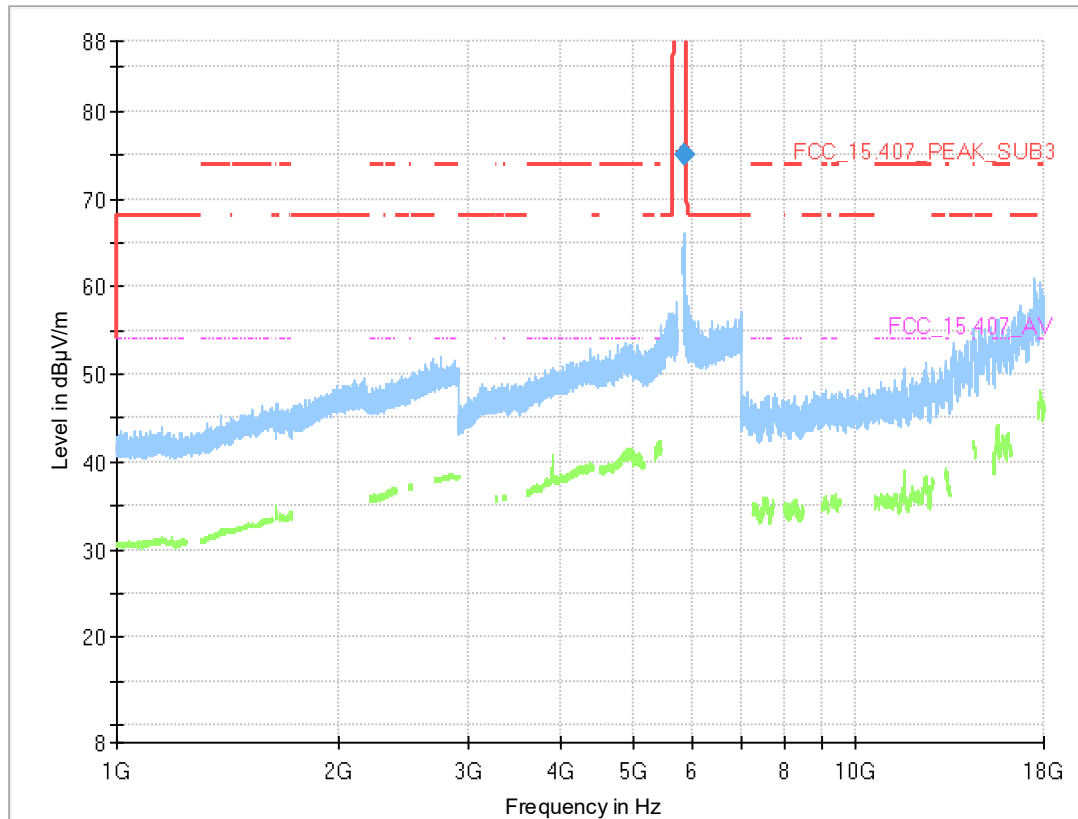

Final Result

Frequency (MHz)	MaxPeak (dBµV/m)	CAverage (dBµV/m)	Limit (dBµV/m)	Margin (dB)	Meas. Time (ms)	Bandwidth (kHz)	Height (cm)	Pol	Azimuth (deg)	Elevation (deg)	Corr. (dB/m)
5851.600	75.1	---	118.5	43.45	1000.0	1000.000	150.0	H	-144.0	4.0	14.9

5.3.5 TEST EQUIPMENT USED

- Radiated Emissions SAC H-Field
- Radiated Emissions FAR 5 GHz FCC
- Radiated Emissions SAC up to 1 GHz
- R&S TS8997

5.4 BAND EDGE

Standard **FCC Part 15 Subpart E**

The test was performed according to:
ANSI C63.10

5.4.1 TEST DESCRIPTION

Radiated Measurement with integral antenna or 50 Ohm termination at antenna port

The test set-up was made in accordance to the general provisions of ANSI C63.10 in a typical installation configuration. The measurements were performed according the following sub-chapter of ANSI C63.10:

- Chapter 6.10.5

The Equipment Under Test (EUT) was set up on a non-conductive support (tilt device) at 1.5 m height in the fully-anechoic chamber.

All steps were performed with one height (1.5 m) of the receiving antenna only (procedure according ANSI C63.10, chapter 6.6.5).

3. Measurement above 1 GHz

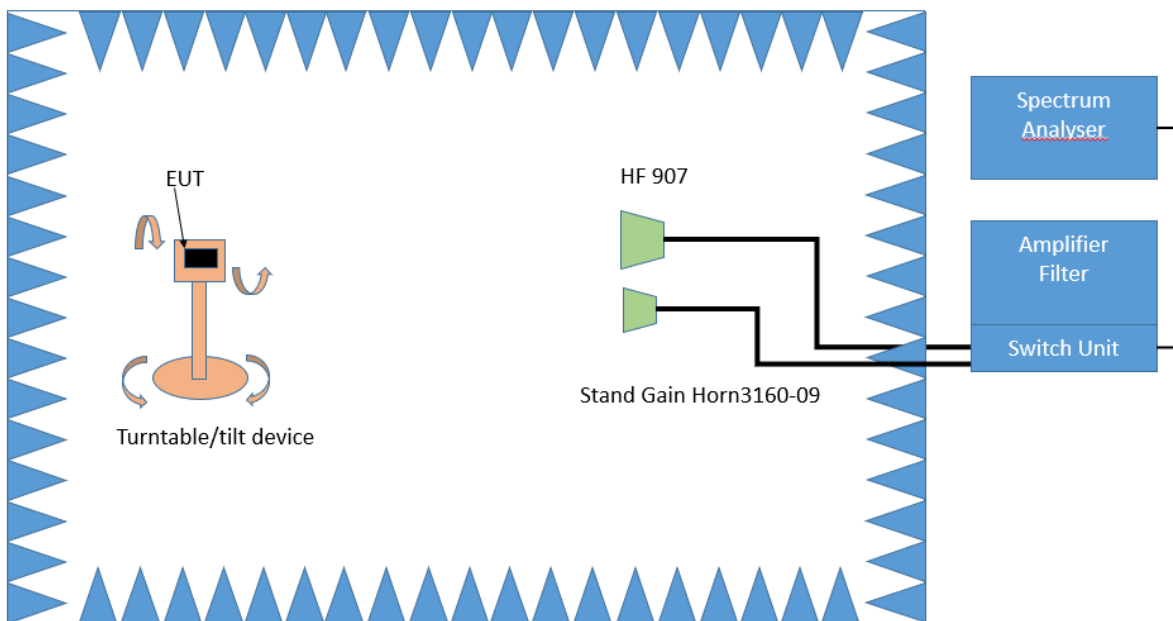

Test Setup; Spurious Emission Radiated (FAC), 1 GHz-26.5 GHz

Step 1:

The EUT is turned during the preliminary measurement across the elevation axis, with a step size of 90 °.

The turn table step size (azimuth angle) for the preliminary measurement is 45 °.

Spectrum analyser settings:

- Detector: Peak, Average
- RBW = 1 MHz
- VBW = 3 MHz

Step 2:

The turn table azimuth will slowly vary by $\pm 22.5^\circ$.

The elevation angle will slowly vary by $\pm 45^\circ$

Spectrum analyser settings:

- Detector: Peak

Step 3:

Spectrum analyser settings for step 3:

- Detector: Peak / CISPR Average
- Measured frequencies: in step 1 determined frequencies
- RBW = 1 MHz
- VBW = 3 MHz
- Measuring time: 1 s

Conducted Measurements at antenna ports

The Equipment Under Test (EUT) was set up to perform the spurious emissions measurements.

The EUT was connected to the test system as described in the block diagram below. The complete attenuation of the measurement path is known and considered.

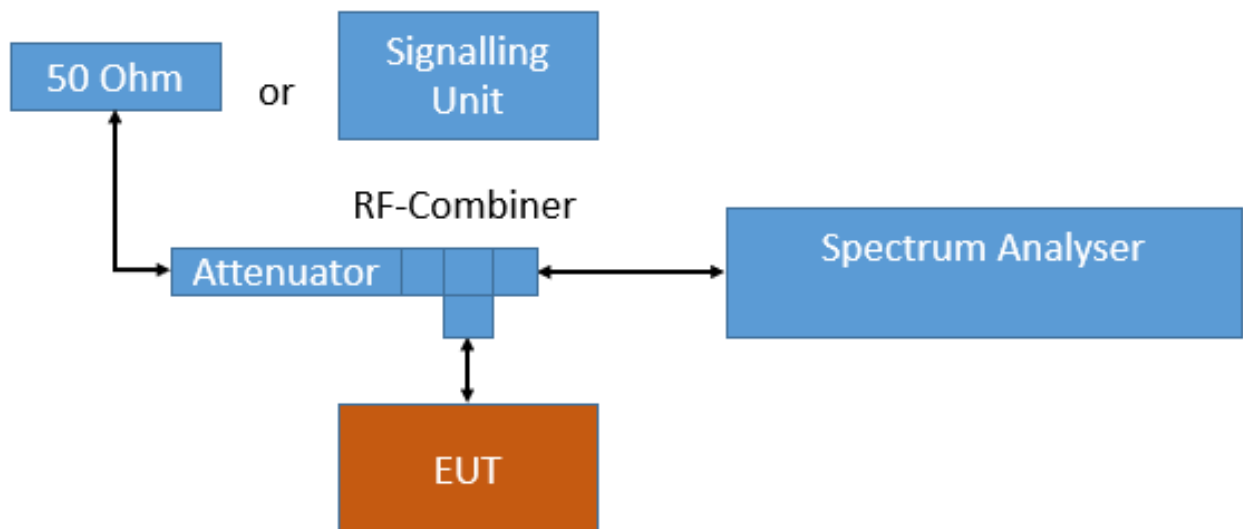

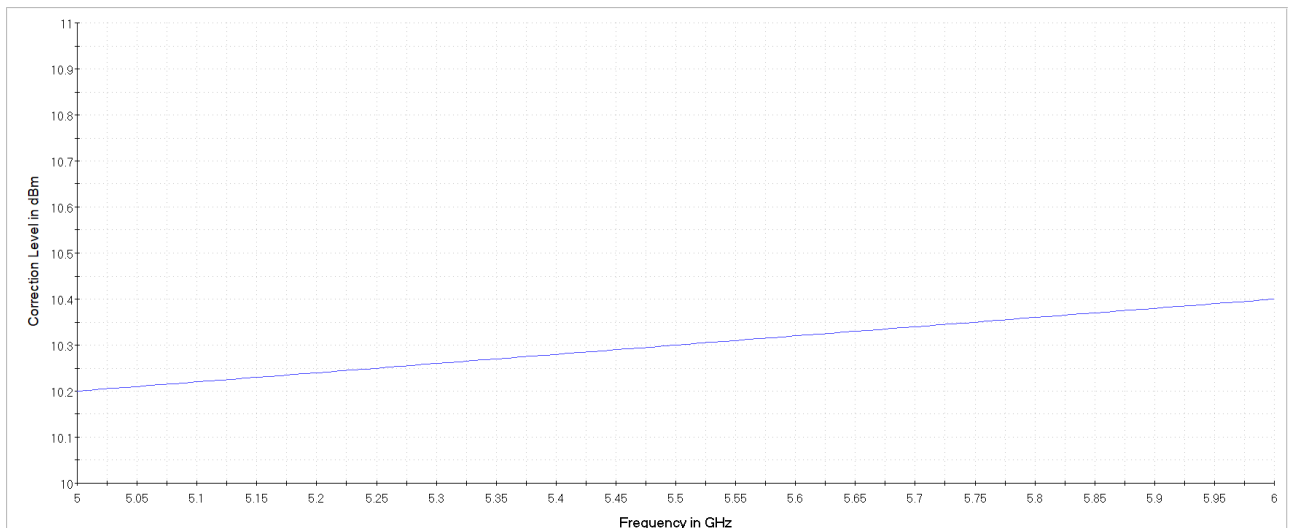

Analyser settings:

- Frequency range: 5100 – 5400 MHz (U-NII band 1/2A)
5430 – 5530 MHz (U-NII band 2C low BE)
5655 – 5755 MHz (U-NII band 2C high BE)
5611 – 5811 MHz (U-NII band 3 low BE)
5765 – 5965 MHz (U-NII band 3 high BE)
- Resolution Bandwidth (RBW): 1000 kHz
- Video Bandwidth (VBW): 3000 kHz
- Trace: Maxhold, Average Power
- Sweeps: 10000
- Sweep Time: coupled
- Detector: Peak, RMS

For the conducted emissions in restricted bands the Value is measured in dBm and then converted to dB μ V/m as given in KDB 558074:

1. Measure the conducted output power in dBm.
2. Add the maximum antenna gain in dBi. (Included in measurement result by offset)
3. Add the appropriate ground reflection factor (0 for measured range)
 - 6 dB for frequencies \leq 30 MHz;
 - 4.7 dB for frequencies between 30 MHz and 1000 MHz, inclusive; and
 - 0 dB for frequencies $>$ 1000 MHz).
4. Convert the resultant EIRP level to an equivalent electric field strength level using the following relationship:
 - $E = \text{EIRP} - 20 \log D + 104.8$
 - Where E is the electric field strength in dB μ V/m,
 - EIRP is the equivalent isotropically radiated power in dBm
 - D is the specified measurement distance in m

Value [dB μ V/m] = Measured value [dBm] (including gain and ground reflection factor) – 20 log D + 104.8

5.4.2 TEST REQUIREMENTS / LIMITS

A) FCC

FCC Part 15 Subpart E, §15.407 (b)(1)

For transmitters operating in the 5150–5250 MHz band:

Limit: –27 dBm/MHz EIRP outside of the band 5150–5350 MHz.

FCC Part 15 Subpart E, §15.407 (b)(2)

For transmitters operating in the 5250–5350 MHz band:

Limit: –27 dBm/MHz EIRP outside of the band 5150–5350 MHz.

FCC Part 15 Subpart E, §15.407 (b)(3)

For transmitters operating in the 5470–5725 MHz band:

Limit: –27 dBm/MHz EIRP outside of the band 5470–5725 MHz.

FCC Part 15 Subpart E, §15.407 (b)(4)

For transmitters operating in the 5725–5850 MHz band:

Limit: –27 dBm/MHz at 75 MHz or more above or below the band edge
increasing linearly to 10 dBm/MHz at 25 MHz above or below the band edge
increasing linearly to 15.6 dBm/MHz at 5 MHz above or below the band edge
increasing linearly to 27 dBm/MHz at the band edge.

FCC Part 15 Subpart E, §15.407 (b) (5)

For transmitters operating within the 5.925-7.125 GHz band:

Limit: –27 dBm/MHz EIRP outside of the band 5.925-7.125 GHz.

FCC Part 15 Subpart E, §15.407 (b) (6)

For transmitters operating within the 5.925-7.125 GHz bands:

Power spectral density must be suppressed by 20 dB at 1 MHz outside of channel edge, by 28 dB at one channel bandwidth from the channel center, and by 40 dB at one- and one-half times the channel bandwidth away from channel center. At frequencies between one megahertz outside an unlicensed device's channel edge and one channel bandwidth from the center of the channel, the limits must be linearly interpolated between 20 dB and 28 dB suppression, and at frequencies between one and one- and one-half times an unlicensed device's channel bandwidth, the limits must be linearly interpolated between 28 dB and 40 dB suppression. Emissions removed from the channel center by more than one- and one-half times the channel bandwidth must be suppressed by at least 40 dB.

B) IC

Different frequency bands and limits apply, as compared to the FCC requirements.

RSS-247, 6.2.1.2, Emissions outside the band 5150-5250 MHz, indoor operation only:

Limit: –27 dBm/MHz EIRP outside of the band 5150–5250 MHz.

RSS-247, 6.2.2.2, Emissions outside the band 5250-5350 MHz:

Limit: –27 dBm/MHz EIRP outside of the band 5250–5350 MHz.

RSS-247, 6.2.3.2, Emissions outside the bands 5470-5600 MHz and 5650-5725 MHz:

Limit: –27 dBm/MHz EIRP outside of the band 5470–5725 MHz.

However, devices with bandwidth overlapping the band edge of 5725 MHz can meet the emission limit of -27 dBm/MHz e.i.r.p.at 5850 MHz instead of 5725 MHz.

Note: No operation is permitted for the frequency range 5600–5650 MHz.

RSS-247, 6.2.4.2, Emissions outside the band 5725-5850 MHz:

- a. 27 dBm/MHz at frequencies from the band edges decreasing linearly to 15.6 dBm/MHz at 5 MHz above or below the band edges;
- b. 15.6 dBm/MHz at 5 MHz above or below the band edges decreasing linearly to 10 dBm/MHz at 25 MHz above or below the band edges;
- c. 10 dBm/MHz at 25 MHz above or below the band edges decreasing linearly to -27 dBm/MHz at 75 MHz above or below the band edges; and
- d. -27 dBm/MHz at frequencies more than 75 MHz above or below the band edges.

C) FCC & IC

For band edges connected to a restricted band, the limits are specified in Section 15.209(a)

FCC Part 15, Subpart C, §15.209, Radiated Emission Limits

Frequency in MHz	Limit ($\mu\text{V}/\text{m}$)	Measurement distance (m)	Limits ($\text{dB}\mu\text{V}/\text{m}$)
0.009 – 0.49	2400/F(kHz)@300m	3	(48.5 – 13.8)@300m
0.49 – 1.705	24000/F(kHz)@30m	3	(33.8 – 23.0)@30m
1.705 – 30	30@30m	3	29.5@30m

The measured values are corrected with an inverse linear distance extrapolation factor (40 dB/decade) according FCC 15.31 (2).

Frequency in MHz	Limit ($\mu\text{V}/\text{m}$)	Measurement distance (m)	Limits ($\text{dB}\mu\text{V}/\text{m}$)
30 – 88	100@3m	3	40.0@3m
88 – 216	150@3m	3	43.5@3m
216 – 960	200@3m	3	46.0@3m
960 – 26000	500@3m	3	54.0@3m
26000 – 40000	500@3m	1	54.0@3m

The measured values above 26 GHz are corrected with an inverse linear distance extrapolation factor (20 dB/decade).

§15.35(b) ..., there is also a limit on the radio frequency emissions, as measured using instrumentation with a peak detector function, corresponding to 20 dB above the maximum permitted average limit....

Used conversion factor: $\text{Limit (dB}\mu\text{V}/\text{m)} = 20 \log (\text{Limit } (\mu\text{V}/\text{m})/1\mu\text{V}/\text{m})$

5.4.3 TEST PROTOCOL

Ambient temperature: 26–30 °C
 Air Pressure: 1000–1016 hPa
 Humidity: 30–40 %
 WLAN a-Mode; 20 MHz; 6 Mbit/s
 Applied duty cycle correction (AV): 0 dB

U-NII-Sub-band	Measurement Method	Ch. Center Freq. [MHz]	Band Edge Freq. [MHz]	Spurious Level [dBµV/m]	Detector	RBW [kHz]	Limit [dBµV/m]	Margin [dB]	Limit Type
1	Radiated Integral Antenna	5180	5150.0	65.7	PEAK	1000	74.0	8.3	BE-RB
	Radiated Integral Antenna	5180	5150.0	49.0	AV	1000	54.0	5.0	BE-RB
	Conducted	5180	5150.0	68.0	PEAK	1000	74.0	6.0	BE-RB
	Conducted	5180	5150.0	53.0	AV	1000	54.0	1.0	BE-RB
2A	Radiated Integral Antenna	5320	5350.0	69.1	PEAK	1000	74.0	4.9	BE-RB
	Radiated Integral Antenna	5320	5350.0	51.3	AV	1000	54.0	2.7	BE-RB
	Conducted	5320	5350.0	69.2	PEAK	1000	74.0	4.8	BE-RB
	Conducted	5320	5350.0	51.4	AV	1000	54.0	2.6	BE-RB
2C	Radiated Integral Antenna	5500	5460.0	67.2	PEAK	1000	74.0	6.8	BE-RB
	Radiated Integral Antenna	5500	5460.0	45.8	AV	1000	54.0	8.2	BE-RB
	Radiated Integral Antenna	5500	5470.0	67.6	PEAK	1000	68.2	0.6	BE-UE
	Conducted	5500	5460.0	61.2	PEAK	1000	74.0	12.8	BE-RB
	Conducted	5500	5460.0	48.0	AV	1000	54.0	6.0	BE-RB
	Conducted	5500	5470.0	66.9	PEAK	1000	68.2	1.3	BE-UE
	Radiated Integral Antenna	5700	5725.0	65.6	PEAK	1000	68.2	2.6	BE-UE
	Conducted	5700	5725.0	66.9	PEAK	1000	68.2	1.3	BE-UE
3	Radiated Integral Antenna	5745	5725.0	80.6	PEAK	1000	121.5	40.9	BE-UE
	Conducted	5745	5725.0	75.8	PEAK	1000	121.5	45.7	BE-UE
	Radiated Integral Antenna	5825	5850.0	77.3	PEAK	1000	117.8	40.5	BE-UE
	Conducted	5825	5850.0	78.7	PEAK	1000	117.8	39.1	BE-UE

WLAN n-Mode; 20 MHz; MCS0; SISO
 Applied duty cycle correction (AV): 0 dB

U-NII-Sub-band	Measurement Method	Ch. Center Freq. [MHz]	Band Edge Freq. [MHz]	Spurious Level [dBµV/m]	Detector	RBW [kHz]	Limit [dBµV/m]	Margin [dB]	Limit Type
1	Radiated Integral Antenna	5180	5150.0	54.8	PEAK	1000	74.0	19.2	BE-RB
	Radiated Integral Antenna	5180	5150.0	42.0	AV	1000	54.0	12.0	BE-RB
2A	Radiated Integral Antenna	5320	5350.0	65.6	PEAK	1000	74.0	8.4	BE-RB
	Radiated Integral Antenna	5320	5350.0	48.3	AV	1000	54.0	5.7	BE-RB
2C	Radiated Integral Antenna	5500	5460.0	61.9	PEAK	1000	74.0	12.1	BE-RB
	Radiated Integral Antenna	5500	5460.0	48.2	AV	1000	54.0	5.8	BE-RB
	Radiated Integral Antenna	5500	5470.0	66.3	PEAK	1000	68.2	1.9	BE-UE
	Radiated Integral Antenna	5700	5725.0	66.2	PEAK	1000	68.2	2.0	BE-UE
3	Radiated Integral Antenna	5745	5725.0	78.8	PEAK	1000	121.2	42.4	BE-UE

	Radiated Integral Antenna	5825	5850.0	76.0	PEAK	1000	117.1	41.1	BE-UE
--	------------------------------	------	--------	------	------	------	-------	------	-------

WLAN n-Mode; 40 MHz; MCS0; SISO
Applied duty cycle correction (AV): 0 dB

U-NII-Sub-band	Measurement Method	Ch. Center Freq. [MHz]	Band Edge Freq. [MHz]	Spurious Level [dB μ V/m]	Detector	RBW [kHz]	Limit [dB μ V/m]	Margin [dB]	Limit Type
1	Radiated Integral Antenna	5190	5150.0	64.7	PEAK	1000	74.0	9.3	BE-RB
	Radiated Integral Antenna	5190	5150.0	49.1	AV	1000	54.0	4.9	BE-RB
2A	Radiated Integral Antenna	5310	5350.0	71.0	PEAK	1000	74.0	3.0	BE-RB
	Radiated Integral Antenna	5310	5350.0	53.1	AV	1000	54.0	0.9	BE-RB
2C	Radiated Integral Antenna	5510	5460.0	63.4	PEAK	1000	74.0	10.6	BE-RB
	Radiated Integral Antenna	5510	5460.0	46.0	AV	1000	54.0	8.0	BE-RB
	Radiated Integral Antenna	5510	5470.0	68.0	PEAK	1000	68.2	0.2	BE-UE
	Radiated Integral Antenna	5670	5725.0	62.9	PEAK	1000	68.2	5.3	BE-UE
3	Radiated Integral Antenna	5755	5725.0	82.2	PEAK	1000	118.3	36.1	BE-UE
	Radiated Integral Antenna	5795	5850.0	67.3	PEAK	1000	119.9	52.6	BE-UE

Remark: Please see next sub-clause for the measurement plot.

5.4.4 MEASUREMENT PLOT (EXAMPLE PLOT, SHOWING WORST CASE, IF APPLICABLE)

Radio Technology = WLAN a, Operating Frequency = low, Subband = U-NII-1 (S02_166_AD01)

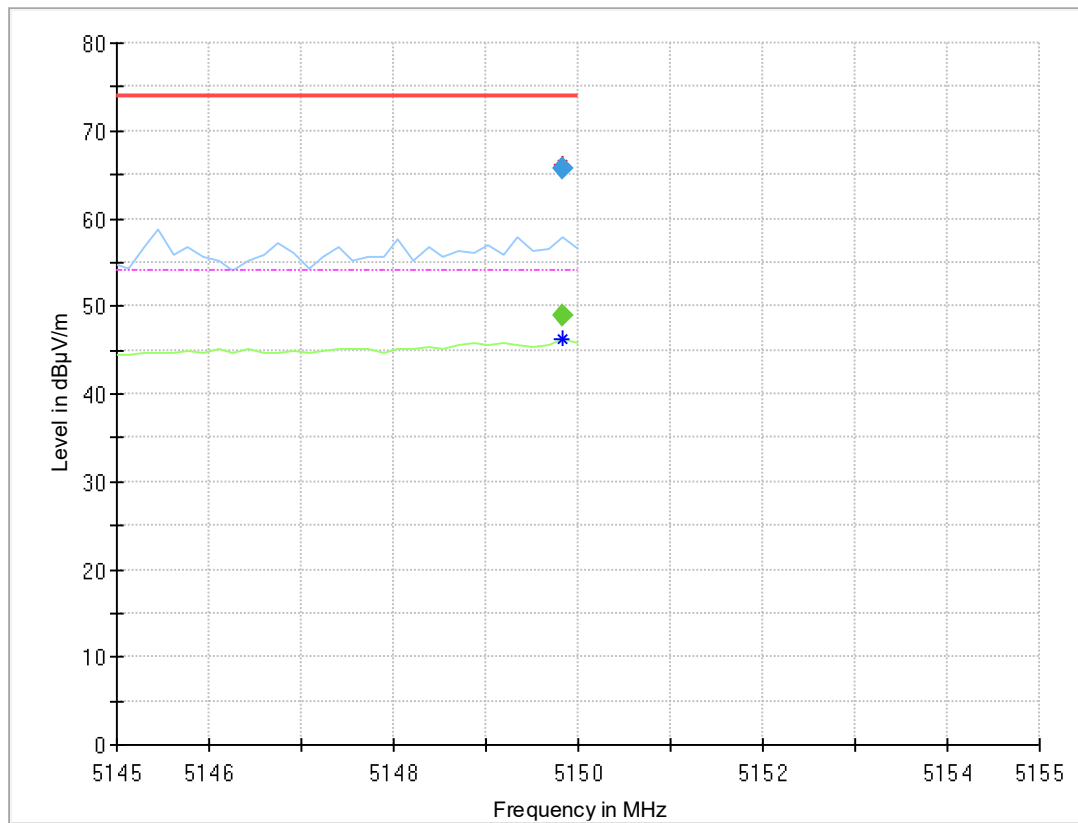

Final Result

Frequency (MHz)	MaxPeak (dBµV/m)	CAverage (dBµV/m)	Limit (dBµV/m)	Margin (dB)	Meas. Time (ms)	Bandwidth (kHz)	Height (cm)	Pol	Azimuth (deg)	Elevation (deg)	Corr. (dB/m)
5149.838	---	49.0	54.00	4.96	1000.0	1000.000	150.0	H	-134.0	15.0	13.5
5149.838	65.7	---	74.00	8.29	1000.0	1000.000	150.0	H	-134.0	15.0	13.5

Radio Technology = WLAN a, Operating Frequency = low, Subband = U-NII-1
(S01_166_AB01)

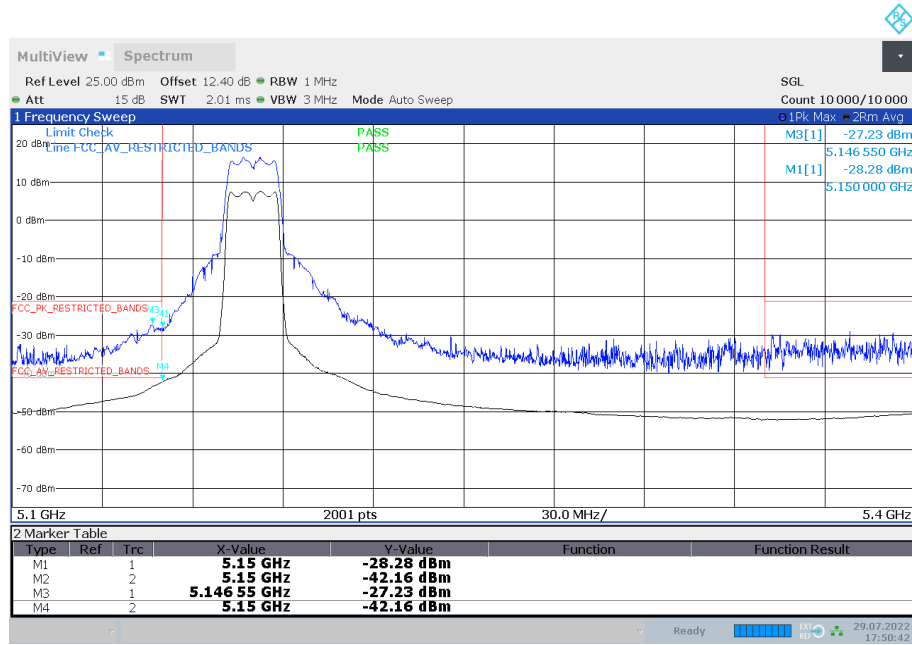

17:50:43 29.07.2022

Radio Technology = WLAN a, Operating Frequency = high, Subband = U-NII-2A
(S02_166_AE01)

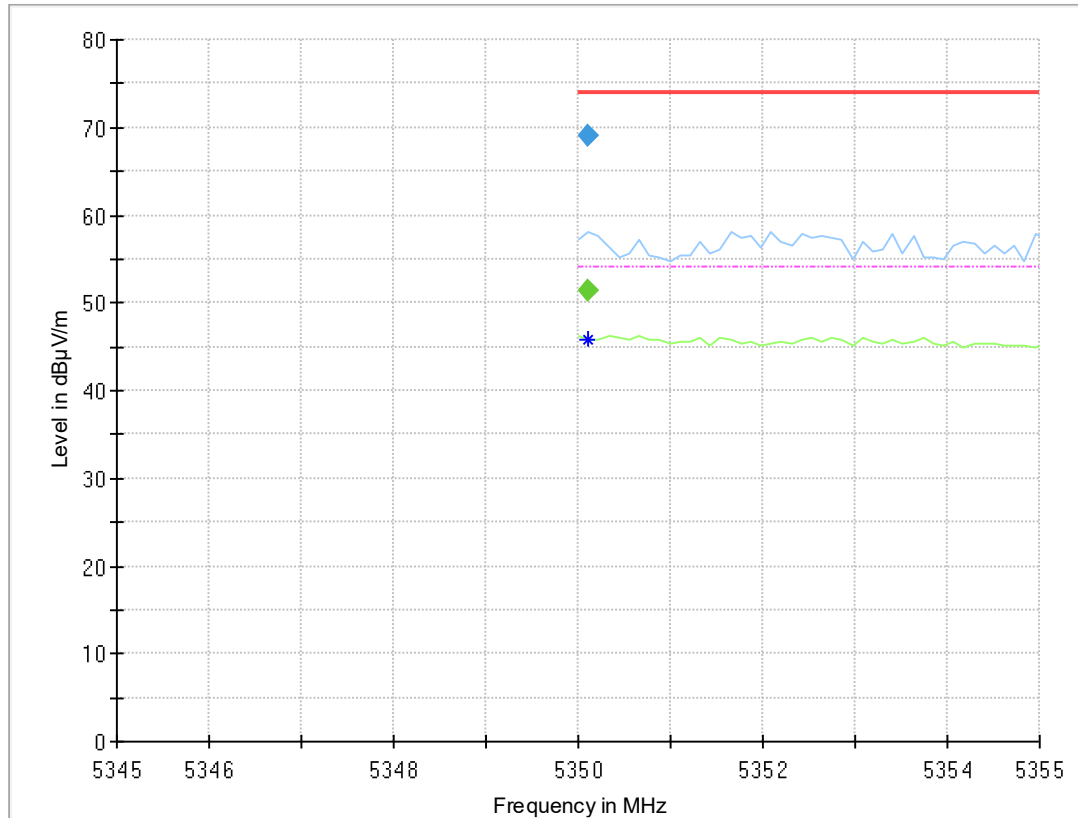

Final Result

Frequency (MHz)	MaxPeak (dBµV/m)	CAverage (dBµV/m)	Limit (dBµV/m)	Margin (dB)	Meas. Time (ms)	Bandwidth (kHz)	Height (cm)	Pol	Azimuth (deg)	Elevation (deg)	Corr. (dB/m)
5350.110	---	51.3	54.00	2.70	1000.0	1000.000	150.0	H	-139.0	4.0	14.1
5350.110	69.1	---	74.00	4.88	1000.0	1000.000	150.0	H	-139.0	4.0	14.1

Radio Technology = WLAN a, Operating Frequency = high, Subband = U-NII-2A
(S01_166_AB01)

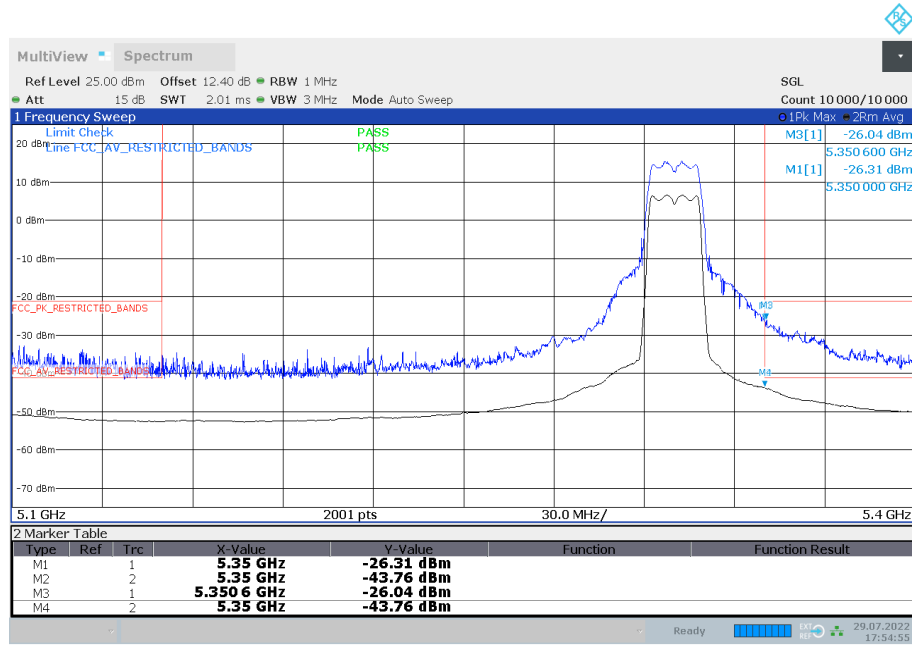

17:54:56 29.07.2022

Radio Technology = WLAN a, Operating Frequency = low, Subband = U-NII-2C
(S02_166_AE01)

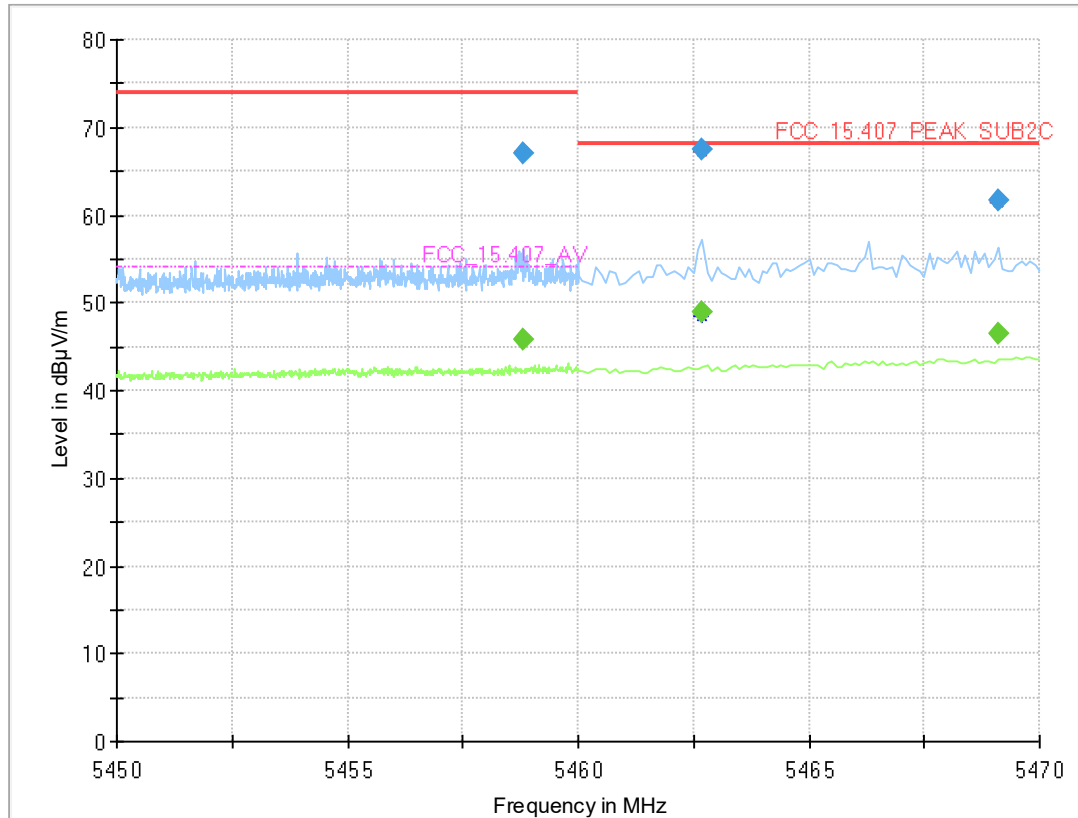

Final Result

Frequency (MHz)	MaxPeak (dBµV/m)	CAverage (dBµV/m)	Limit (dBµV/m)	Margin (dB)	Meas. Time (ms)	Bandwidth (kHz)	Height (cm)	Pol	Azimuth (deg)	Elevation (deg)	Corr. (dB/m)
5458.800	---	45.8	54.00	8.16	1000.0	1000.000	150.0	H	-7.0	-8.0	14.5
5458.800	67.2	---	74.00	6.85	1000.0	1000.000	150.0	H	-142.0	100.0	14.5
5462.700	---	48.8	---	---	1000.0	1000.000	150.0	H	-146.0	8.0	14.5
5462.700	67.6	---	68.20	0.61	1000.0	1000.000	150.0	H	-146.0	15.0	14.5
5469.100	---	46.5	---	---	1000.0	1000.000	150.0	H	0.0	-7.0	14.4
5469.100	61.7	---	68.20	6.45	1000.0	1000.000	150.0	H	-10.0	-8.0	14.4

Radio Technology = WLAN a, Operating Frequency = low, Subband = U-NII-2C
(S01_166_AB01)

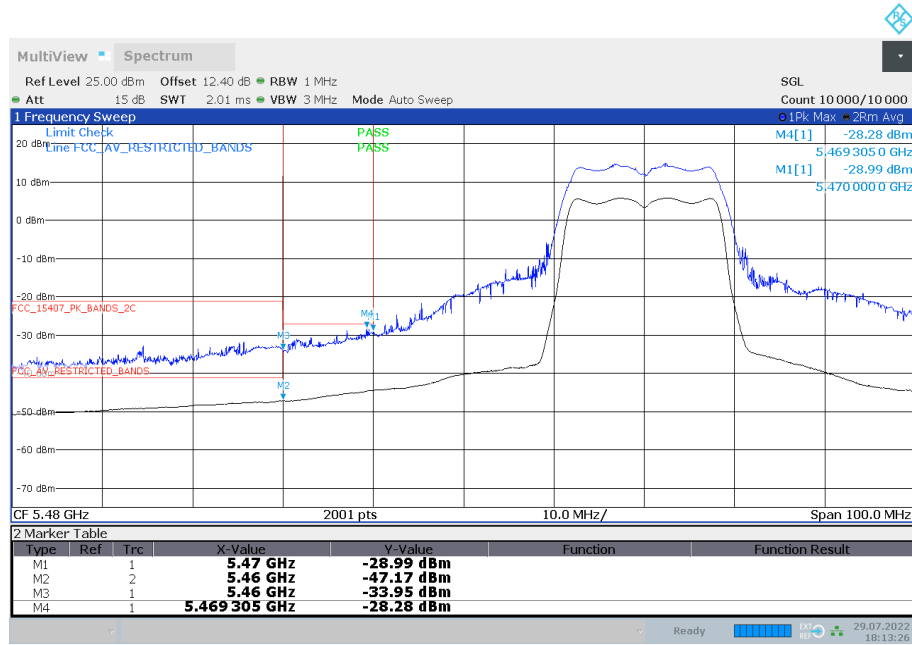

18:13:26 29.07.2022

Radio Technology = WLAN a, Operating Frequency = high, Subband = U-NII-2C
(S02_166_AE01)

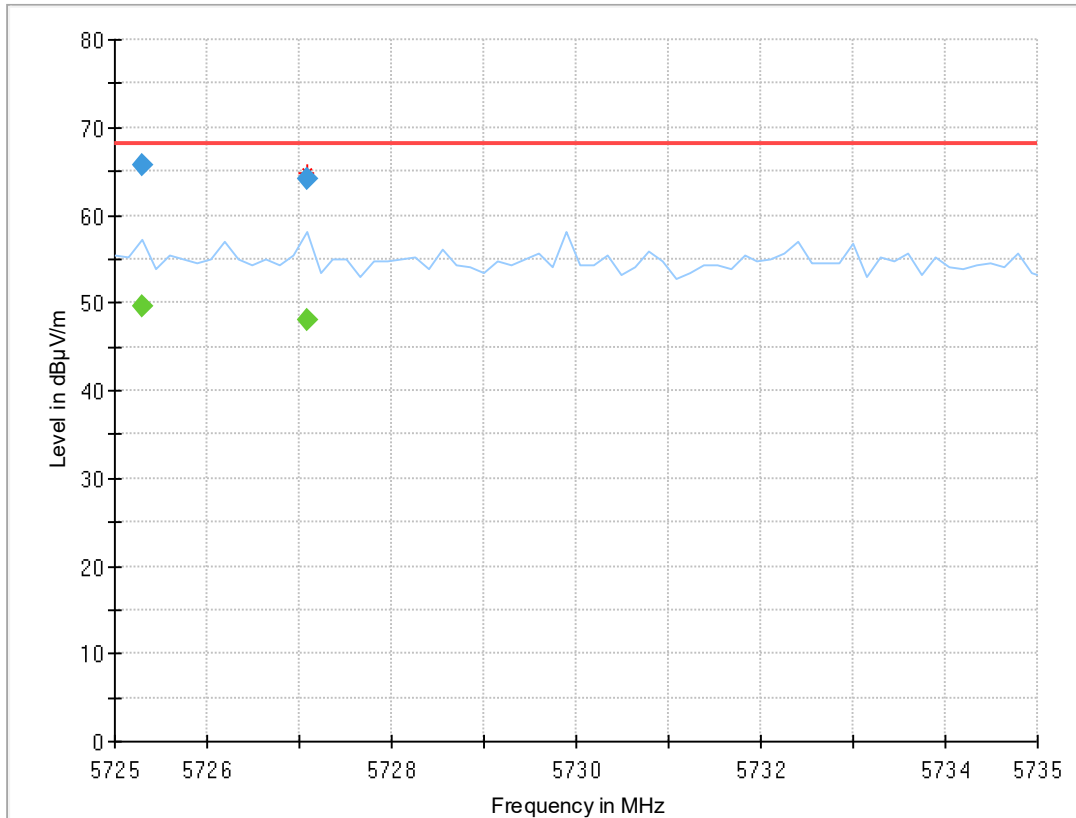

Final Result

Frequency (MHz)	MaxPeak (dBµV/m)	CAverage (dBµV/m)	Limit (dBµV/m)	Marg in (dB)	Meas. Time (ms)	Bandwidth (kHz)	Height (cm)	Pol	Azimuth (deg)	Elevation (deg)	Corr. (dB)
5725.297	---	49.6	---	---	1000.0	1000.00	150.	H	-137.0	9.0	14.2
5725.297	65.6	---	68.2	2.61	1000.0	1000.00	150.	H	-137.0	9.0	14.2
5727.076	64.1	---	68.2	4.12	1000.0	1000.00	150.	H	-137.0	-1.0	14.2
5727.076	---	48.0	---	---	1000.0	1000.00	150.	H	-137.0	-1.0	14.2

Radio Technology = WLAN a, Operating Frequency = high, Subband = U-NII-2C
(S01_166_AB01)

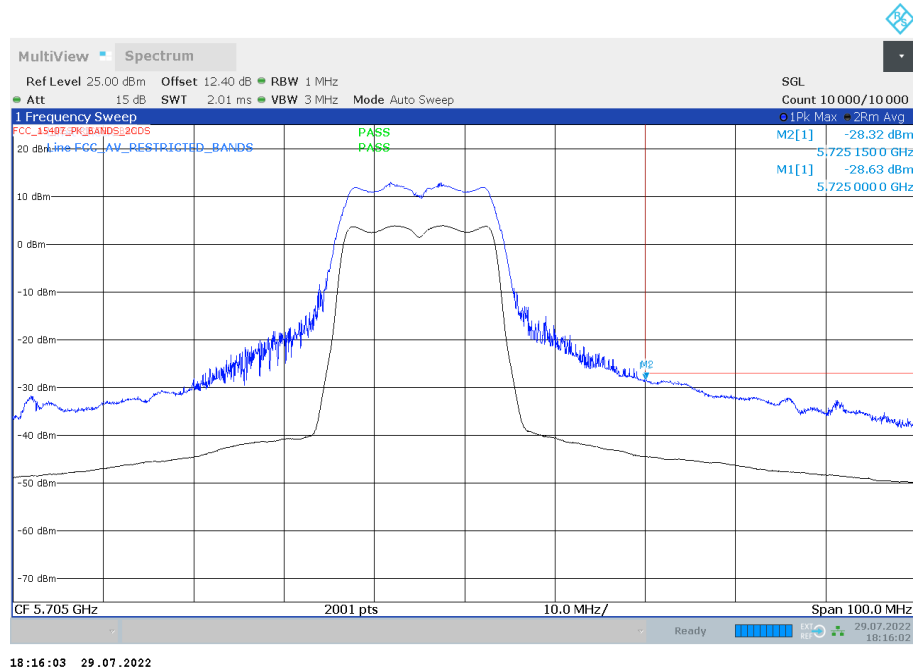

Radio Technology = WLAN a, Operating Frequency = low, Subband = U-NII-3
(S02_166_AE01)

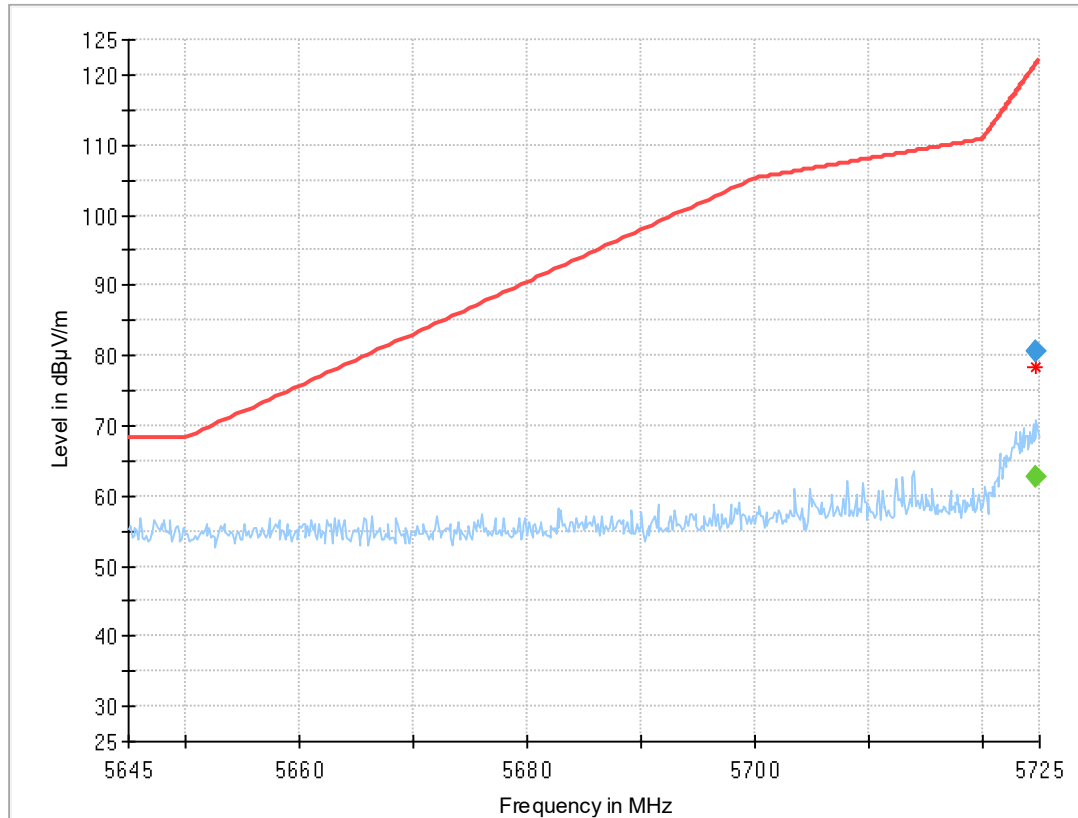

Final Result

Frequency (MHz)	MaxPeak (dBµV/m)	CAverage (dBµV/m)	Limit (dBµV/m)	Margin (dB)	Meas. Time (ms)	Bandwidth (kHz)	Height (cm)	Pol	Azimuth (deg)	Elevation (deg)	Corr. (dB)
5724.700	---	62.8	---	---	1000.0	1000.000	150.0	H	-136.0	7.0	14.2
5724.700	80.6	---	121.5	40.93	1000.0	1000.000	150.0	H	-136.0	7.0	14.2

Radio Technology = WLAN a, Operating Frequency = low, Subband = U-NII-3
(S01_166_AB01)

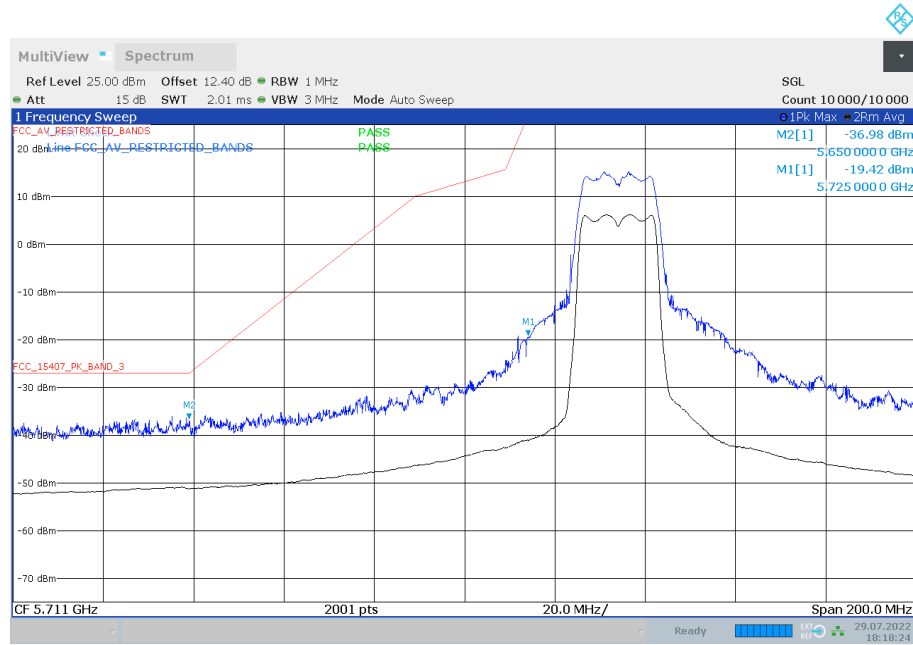

18:18:25 29.07.2022

Radio Technology = WLAN a, Operating Frequency = high, Subband = U-NII-3
(S02_166_AE01)

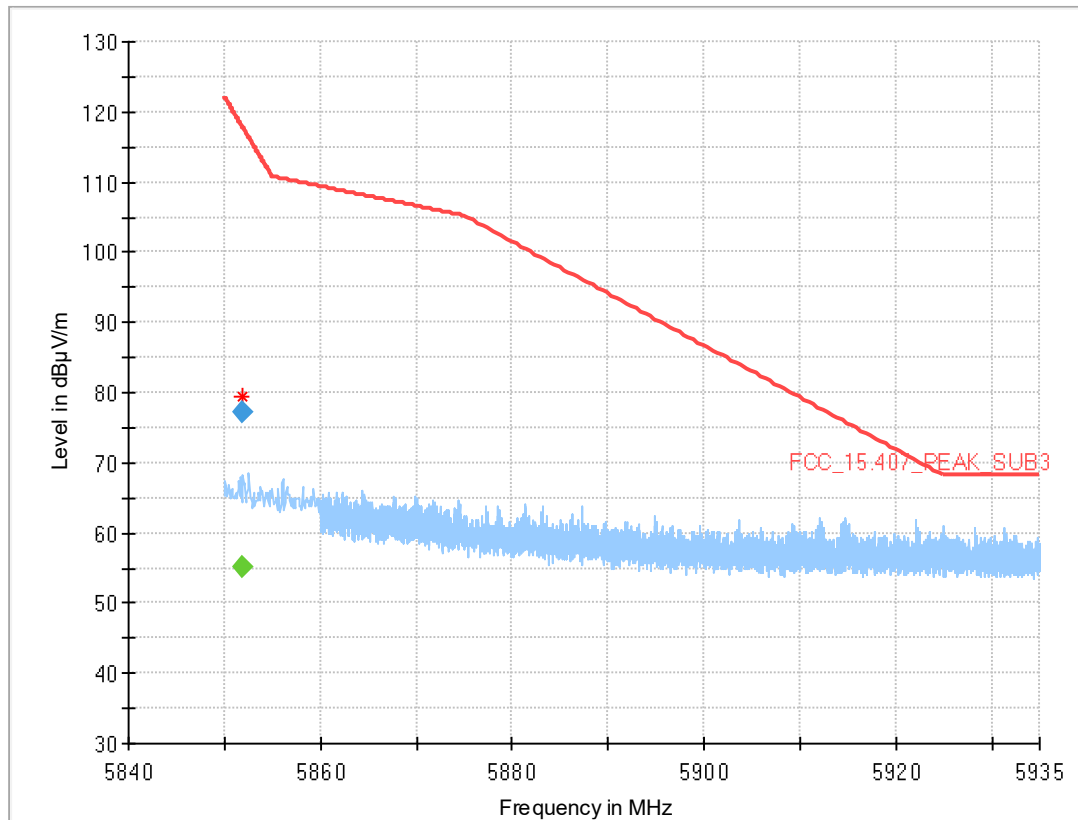

Final Result

Frequency (MHz)	MaxPeak (dBµV/m)	CAverage (dBµV/m)	Limit (dBµV/m)	Margin (dB)	Meas. Time (ms)	Bandwidth (kHz)	Height (cm)	Pol	Azimuth (deg)	Elevation (deg)	Corr. (dB/m)
5851.900	---	55.1	---	---	1000.0	1000.000	150.0	H	-133.0	-3.0	14.9
5851.900	77.3	---	117.8	40.55	1000.0	1000.000	150.0	H	-133.0	-3.0	14.9

Radio Technology = WLAN a, Operating Frequency = high, Subband = U-NII-3
(S01_166_AB01)

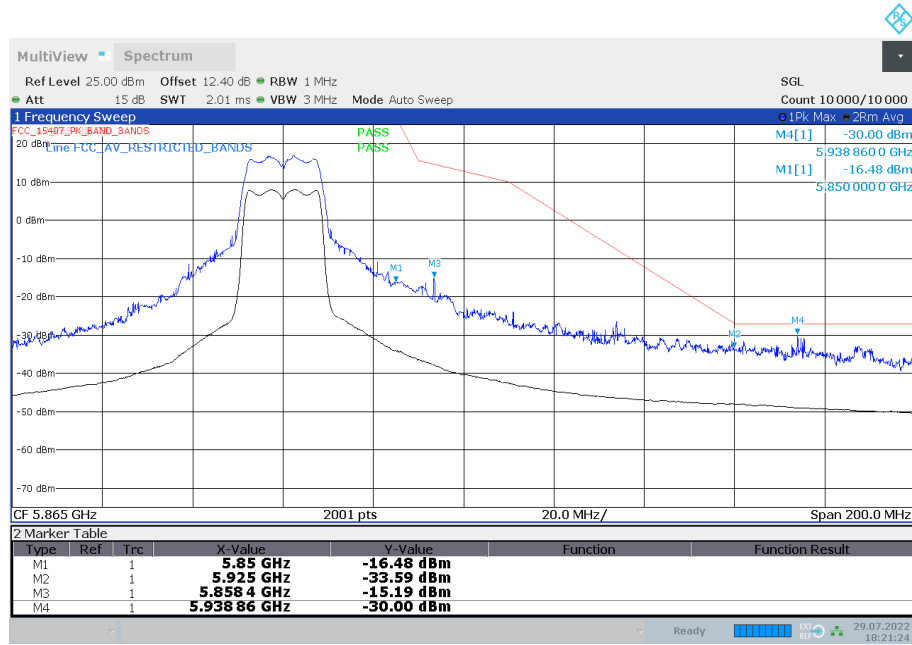

18:21:25 29.07.2022

Radio Technology = WLAN n 20 MHz, Operating Frequency = low, Subband = U-NII-1
(S02_166_AE01)

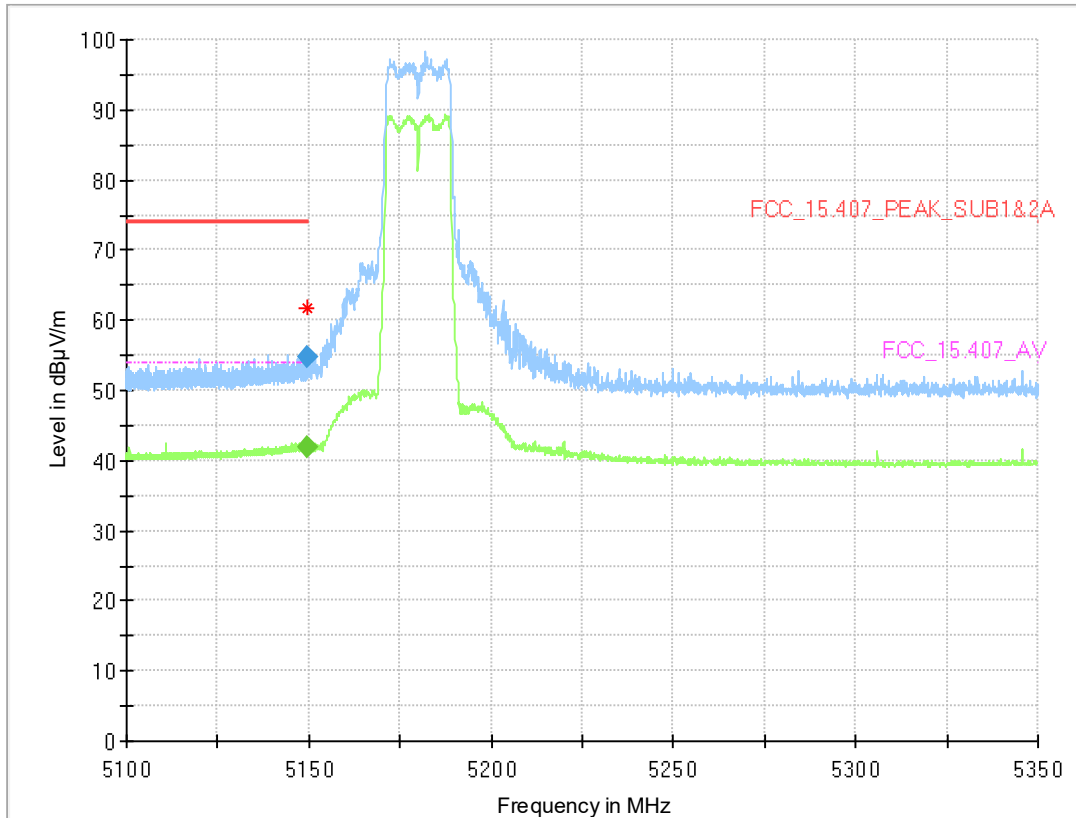

Final Result

Frequency (MHz)	MaxPeak (dBµV/m)	CAverage (dBµV/m)	Limit (dBµV/m)	Margin (dB)	Meas. Time (ms)	Bandwidth (kHz)	Height (cm)	Pol	Azimuth (deg)	Elevation (deg)	Corr. (dB/m)
5149.725	---	42.0	54.00	12.04	1000.0	1000.000	150.0	H	6.0	102.0	13.5
5149.725	54.8	---	74.00	19.18	1000.0	1000.000	150.0	H	6.0	102.0	13.5

Radio Technology = WLAN n 20 MHz, Operating Frequency = high, Subband = U-NII-2A (S02_166_AE01)

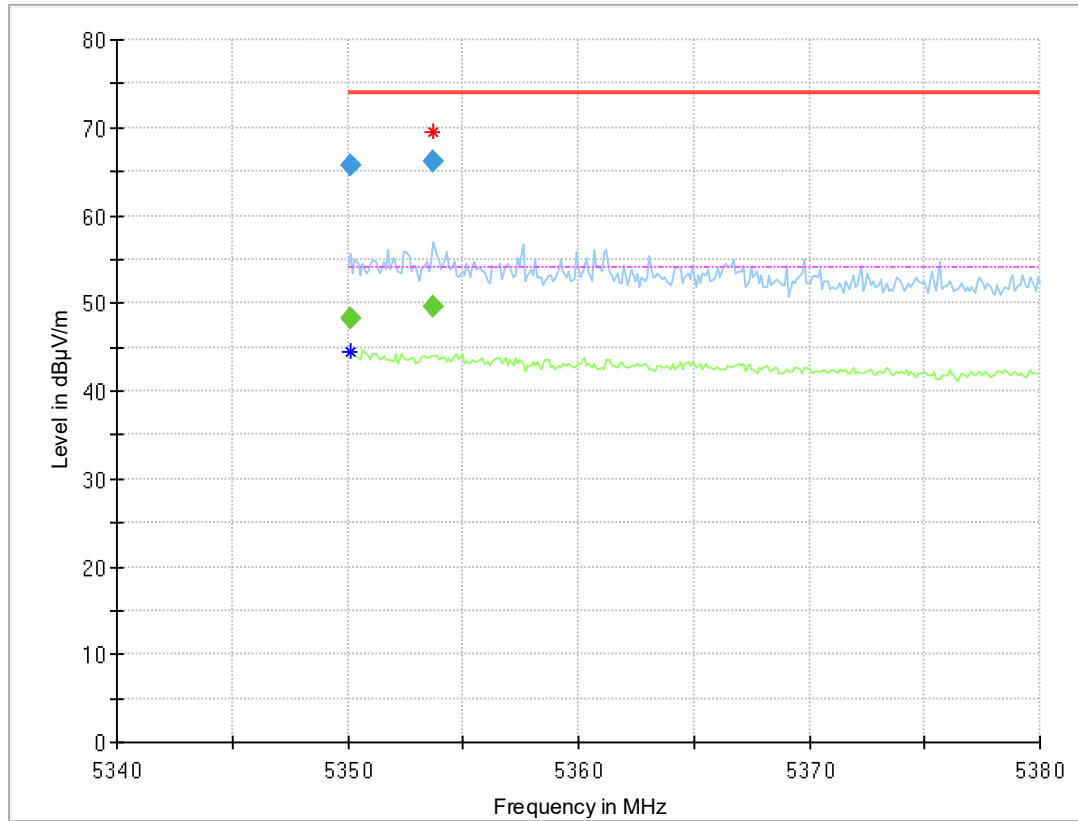

Final Result

Frequency (MHz)	MaxPeak (dBµV/m)	CAverage (dBµV/m)	Limit (dBµV/m)	Margin (dB)	Meas. Time (ms)	Bandwidth (kHz)	Height (cm)	Pol	Azimuth (deg)	Elevation (deg)	Corr. (dB/m)
5350.110	---	48.3	54.00	5.65	1000.0	1000.000	150.0	H	-131.0	8.0	14.1
5350.110	65.6	---	74.00	8.36	1000.0	1000.000	150.0	H	-131.0	8.0	14.1
5353.740	---	49.7	54.00	4.33	1000.0	1000.000	150.0	H	-144.0	2.0	14.1
5353.740	66.2	---	74.00	7.82	1000.0	1000.000	150.0	H	-144.0	2.0	14.1

Radio Technology = WLAN n 20 MHz, Operating Frequency = low, Subband = U-NII-2C (S02_166_AF01)

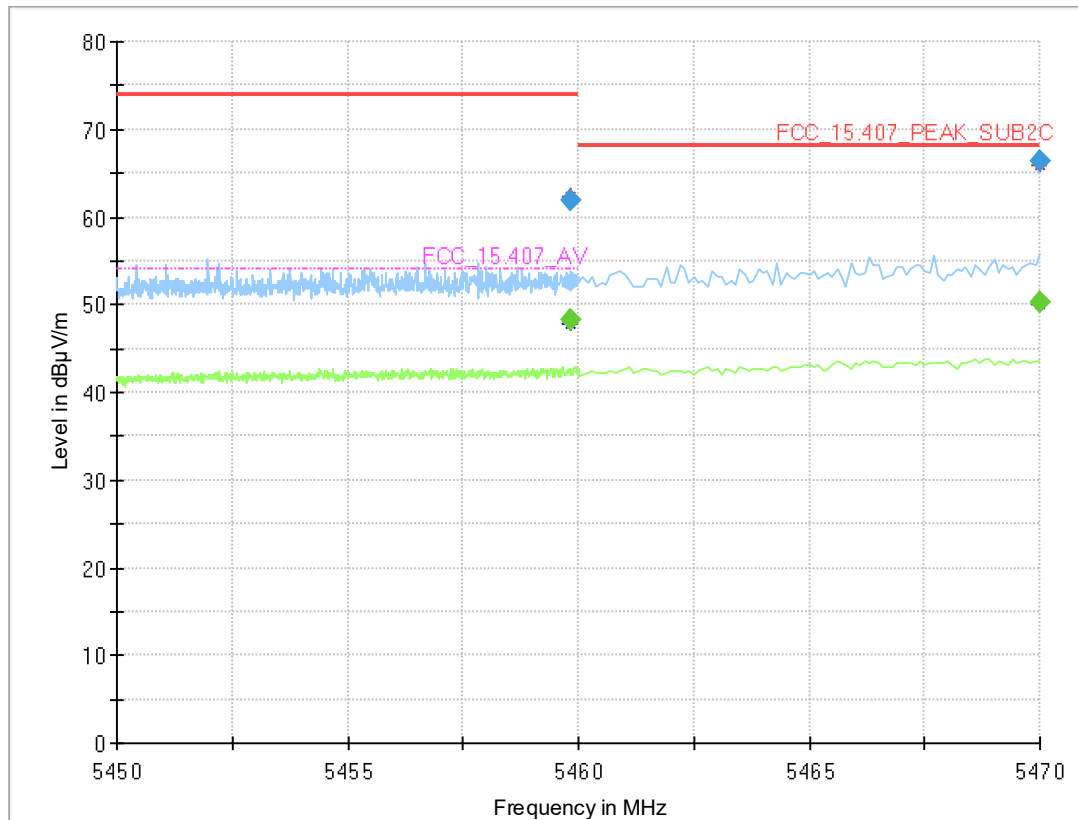

Final Result

Frequency (MHz)	MaxPeak (dBµV/m)	CAverage (dBµV/m)	Limit (dBµV/m)	Margin (dB)	Meas. Time (ms)	Bandwidth (kHz)	Height (cm)	Pol	Azimuth (deg)	Elevation (deg)	Corr. (dB/m)
5459.850	---	48.2	54.00	5.82	1000.0	1000.000	150.0	H	-146.0	7.0	14.5
5459.850	61.9	---	74.00	12.08	1000.0	1000.000	150.0	H	-140.0	6.0	14.5
5470.000	---	50.2	---	---	1000.0	1000.000	150.0	H	-146.0	7.0	14.4
5470.000	66.3	---	68.20	1.86	1000.0	1000.000	150.0	H	-146.0	13.0	14.4

Radio Technology = WLAN n 20 MHz, Operating Frequency = high, Subband = U-NII-2C (S02_166_AE01)

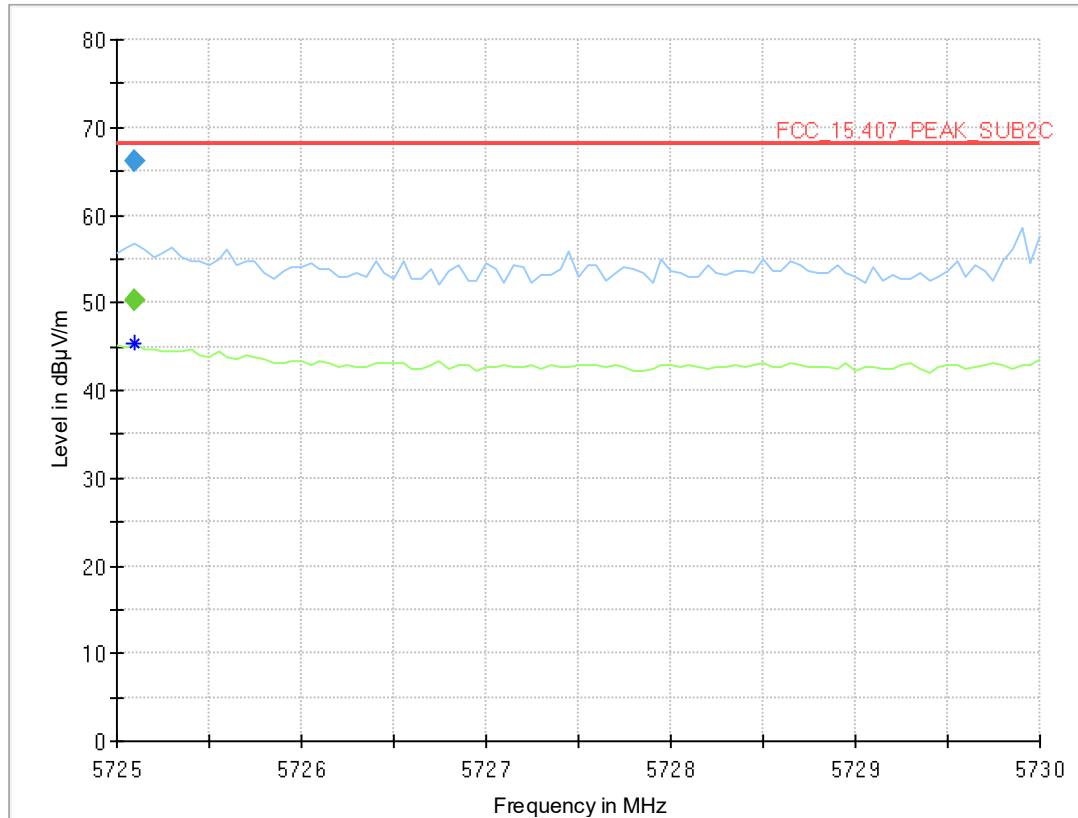

Final Result

Frequency (MHz)	MaxPeak (dBµV/m)	CAverage (dBµV/m)	Limit (dBµV/m)	Margin (dB)	Meas. Time (ms)	Bandwidth (kHz)	Height (cm)	Pol	Azimuth (deg)	Elevation (deg)	Corr. (dB/m)
5725.100	---	50.3	---	---	1000.0	1000.000	150.0	H	-145.0	2.0	14.2
5725.100	66.2	---	68.20	1.99	1000.0	1000.000	150.0	H	-145.0	2.0	14.2

Radio Technology = WLAN n 20 MHz, Operating Frequency = low, Subband = U-NII-3 (S02_166_AE01)

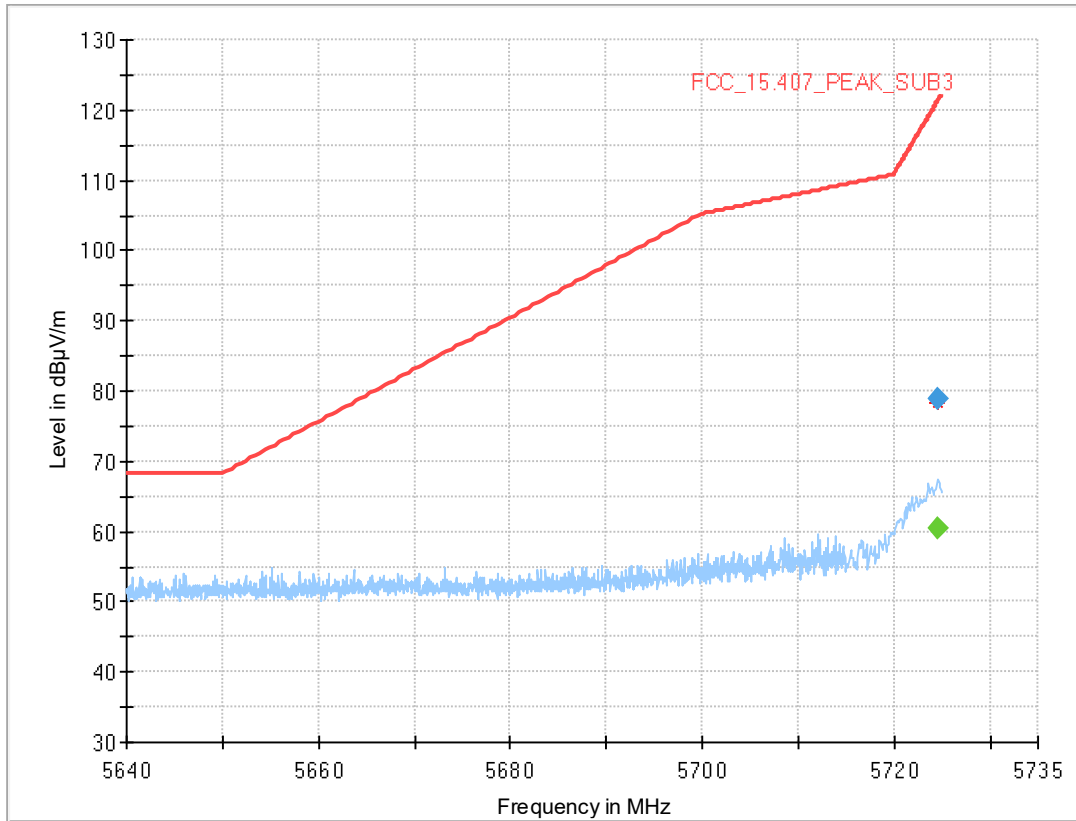

Final Result

Frequency (MHz)	MaxPeak (dBµV/m)	CAverage (dBµV/m)	Limit (dBµV/m)	Margin (dB)	Meas. Time (ms)	Bandwidth (kHz)	Height (cm)	Pol	Azimuth (deg)	Elevation (deg)	Corr. (dB/m)
5724.600	---	60.3	---	---	1000.0	1000.000	150.0	V	140.0	81.0	14.2
5724.600	78.8	---	121.2	42.47	1000.0	1000.000	150.0	V	140.0	81.0	14.2

Radio Technology = WLAN n 20 MHz, Operating Frequency = high, Subband = U-NII-3 (S02_166_AE01)

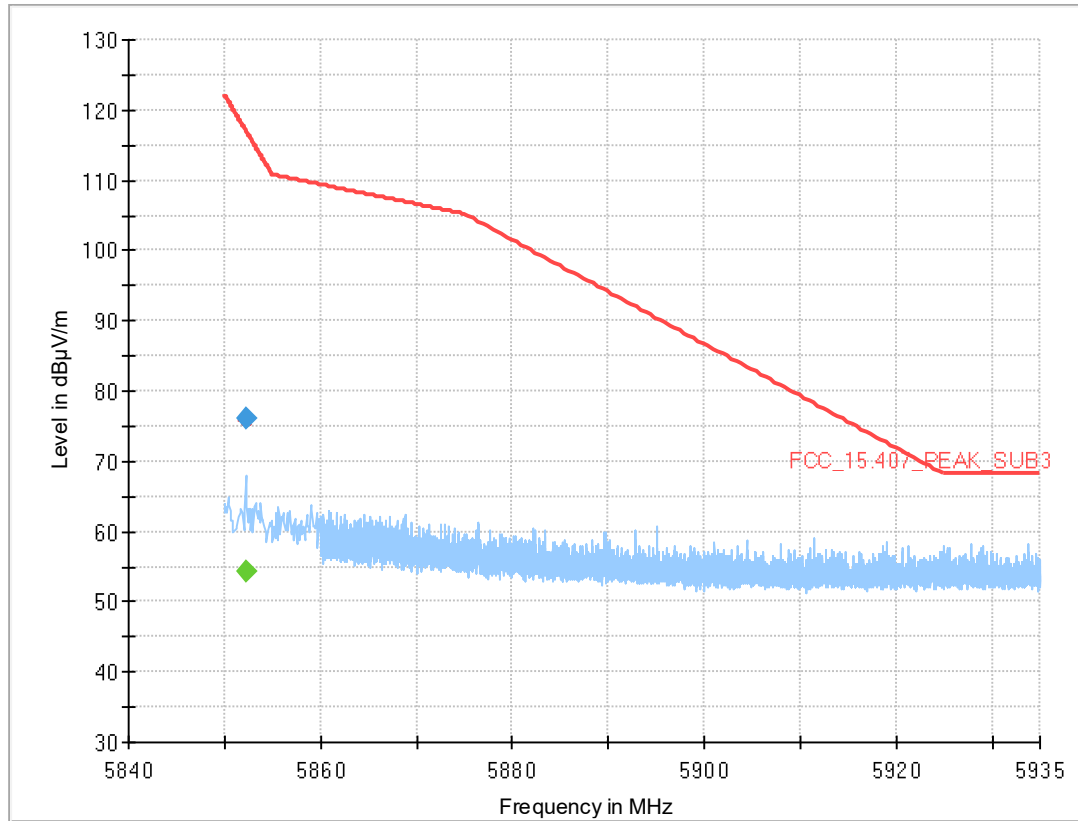

Final Result

Frequency (MHz)	MaxPeak (dBµV/m)	CAverage (dBµV/m)	Limit (dBµV/m)	Margin (dB)	Meas. Time (ms)	Bandwidth (kHz)	Height (cm)	Pol	Azimuth (deg)	Elevation (deg)	Corr. (dB/m)
5852.200	---	54.3	---	---	1000.0	1000.000	150.0	H	-143.0	6.0	14.9
5852.200	76.0	---	117.1	41.19	1000.0	1000.000	150.0	H	-143.0	6.0	14.9

Radio Technology = WLAN n 40 MHz, Operating Frequency = low, Subband = U-NII-1 (S02_166_AE01)

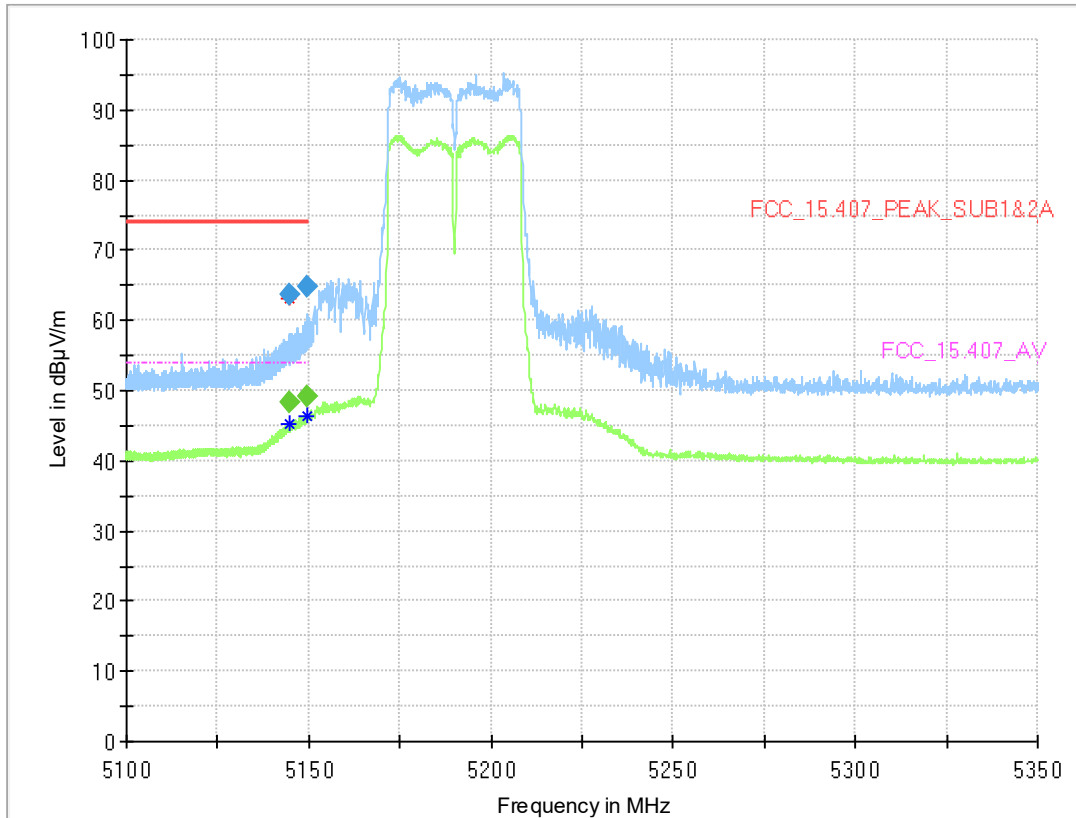

Final Result

Frequency (MHz)	MaxPeak (dBµV/m)	CAverage (dBµV/m)	Limit (dBµV/m)	Margin (dB)	Meas. Time (ms)	Bandwidth (kHz)	Height (cm)	Pol	Azimuth (deg)	Elevation (deg)	Corr. (dB/m)
5144.975	---	48.2	54.00	5.76	1000.0	1000.000	150.0	H	1.0	-7.0	13.7
5144.975	63.8	---	74.00	10.21	1000.0	1000.000	150.0	H	1.0	-7.0	13.7
5149.438	---	49.1	54.00	4.88	1000.0	1000.000	150.0	H	0.0	-8.0	13.5
5149.438	64.7	---	74.00	9.29	1000.0	1000.000	150.0	H	0.0	-8.0	13.5

Radio Technology = WLAN n 40 MHz, Operating Frequency = high, Subband = U-NII-2A
(S02_166_AE01)

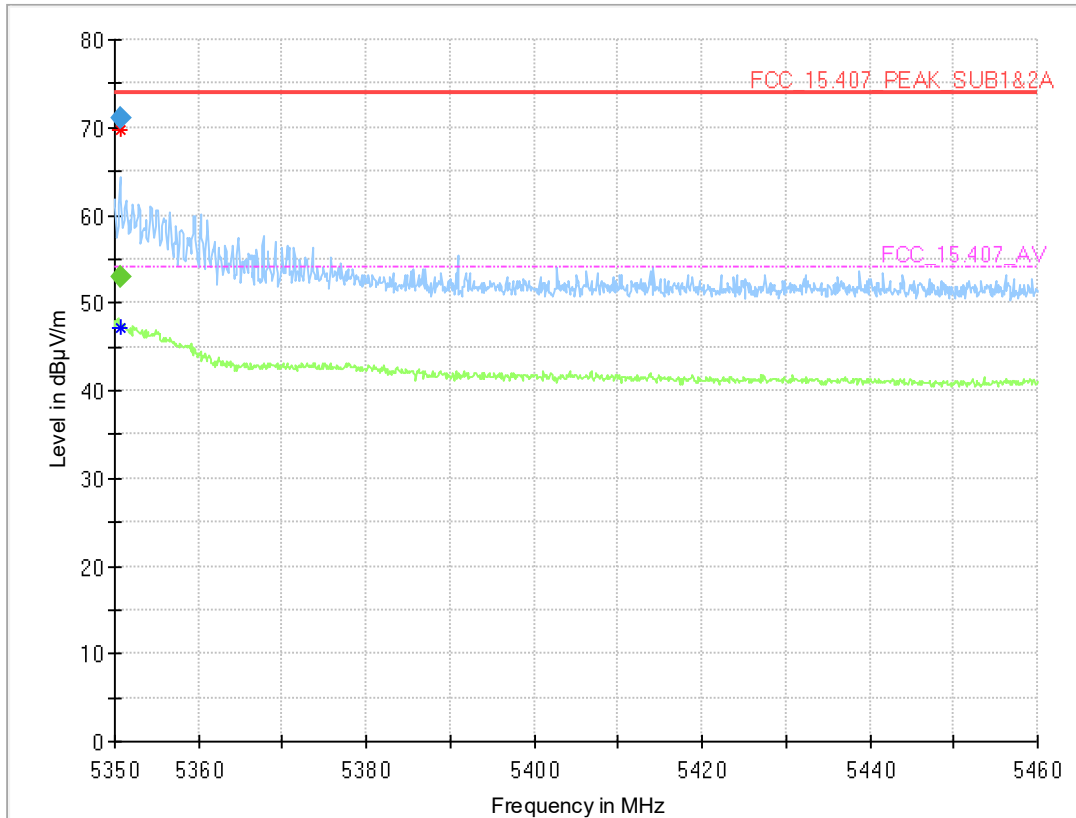

Final Result

Frequency (MHz)	MaxPeak (dBµV/m)	CAverage (dBµV/m)	Limit (dBµV/m)	Margin (dB)	Meas. Time (ms)	Bandwidth (kHz)	Height (cm)	Pol	Azimuth (deg)	Elevation (deg)	Corr. (dB/m)
5350.660	---	53.1	54.00	0.94	1000.0	1000.000	150.0	H	-136.0	15.0	14.1
5350.660	71.0	---	74.00	3.02	1000.0	1000.000	150.0	H	-136.0	15.0	14.1

Radio Technology = WLAN n 40 MHz, Operating Frequency = low, Subband = U-NII-2C
(S02_166_AE01)

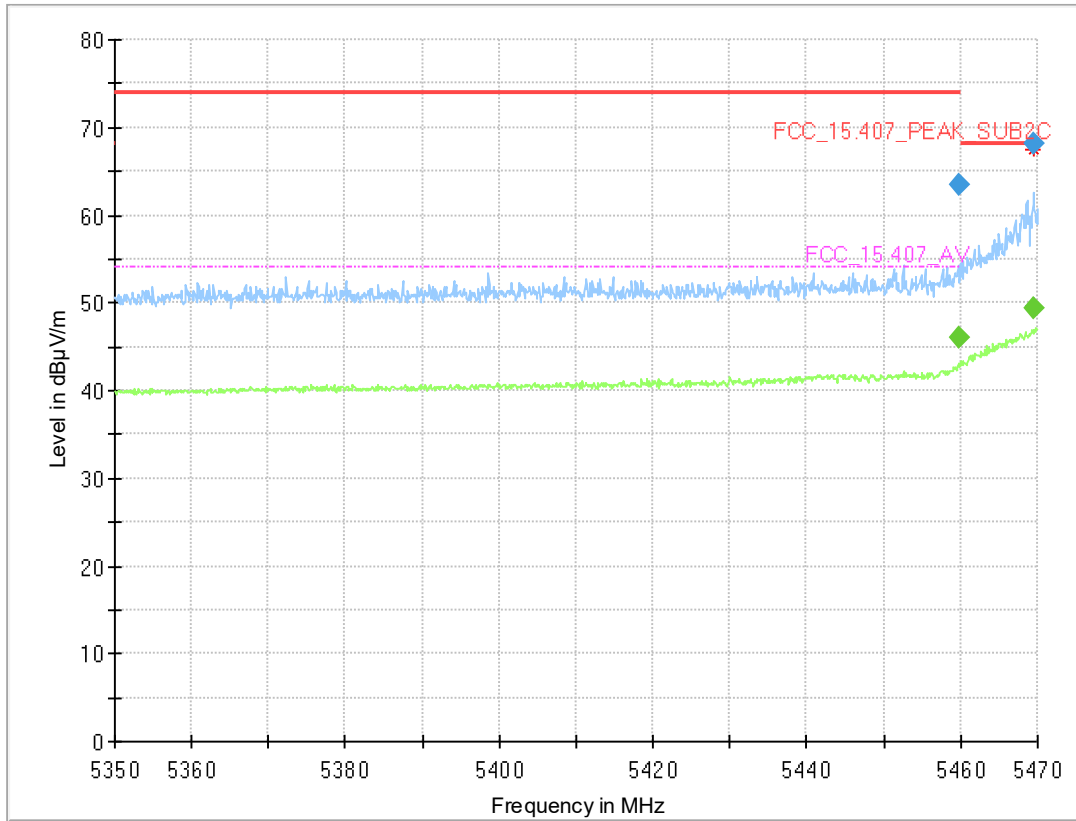

Final Result

Frequency (MHz)	MaxPeak (dBµV/m)	CAverage (dBµV/m)	Limit (dBµV/m)	Margin (dB)	Meas. Time (ms)	Bandwidth (kHz)	Height (cm)	Pol	Azimuth (deg)	Elevation (deg)	Corr. (dB/m)
5459.670	---	46.0	54.00	7.97	1000.0	1000.000	150.0	H	2.0	-7.0	14.5
5459.670	63.4	---	74.00	10.57	1000.0	1000.000	150.0	H	-140.0	7.0	14.5
5469.500	---	49.5	---	---	1000.0	1000.000	150.0	H	1.0	-7.0	14.4
5469.500	68.0	---	68.20	0.15	1000.0	1000.000	150.0	H	3.0	-4.0	14.4

Radio Technology = WLAN n 40 MHz, Operating Frequency = high, Subband = U-NII-2C (S02_166_AE01)

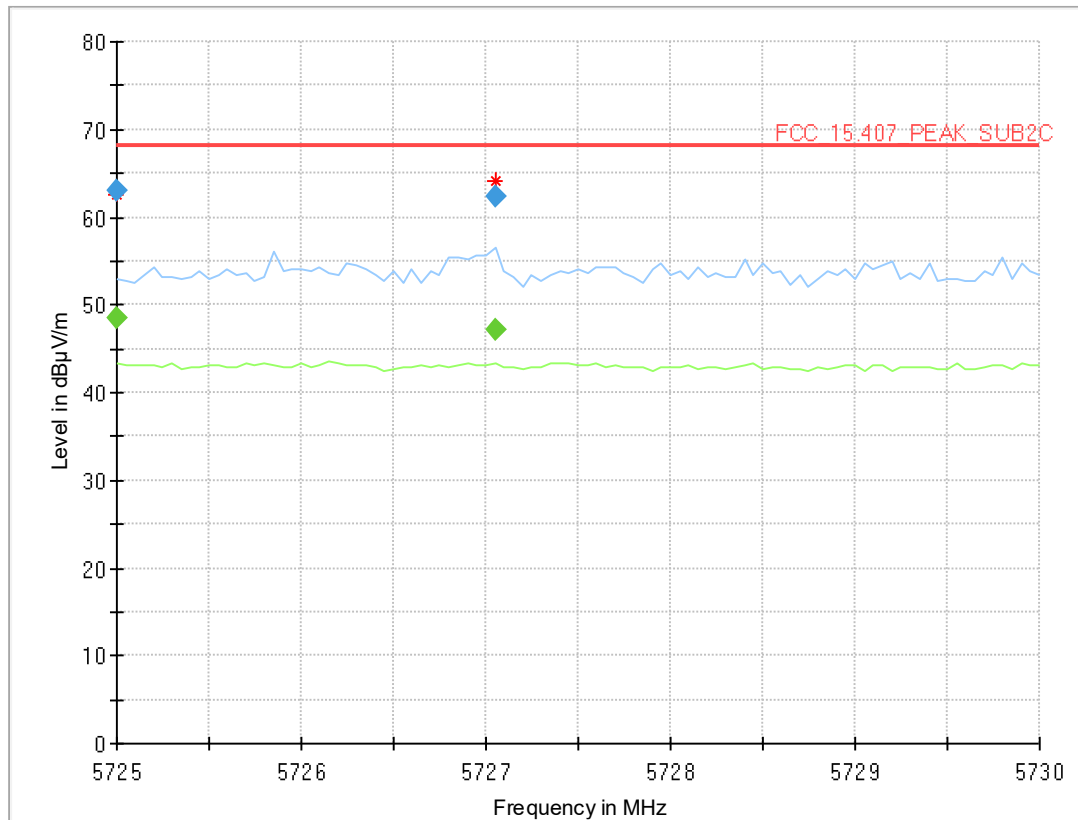

Final Result

Frequency (MHz)	MaxPeak (dBµV/m)	CAverage (dBµV/m)	Limit (dBµV/m)	Margin (dB)	Meas. Time (ms)	Bandwidth (kHz)	Height (cm)	Pol	Azimuth (deg)	Elevation (deg)	Corr. (dB/m)
5725.000	---	48.6	---	---	1000.0	1000.000	150.0	H	-134.0	12.0	14.2
5725.000	62.9	---	68.20	5.29	1000.0	1000.000	150.0	H	-134.0	12.0	14.2
5727.050	---	47.2	---	---	1000.0	1000.000	150.0	H	-134.0	2.0	14.2
5727.050	62.3	---	68.20	5.95	1000.0	1000.000	150.0	H	-134.0	2.0	14.2

Radio Technology = WLAN n 40 MHz, Operating Frequency = low, Subband = U-NII-3 (S02_166_AE01)

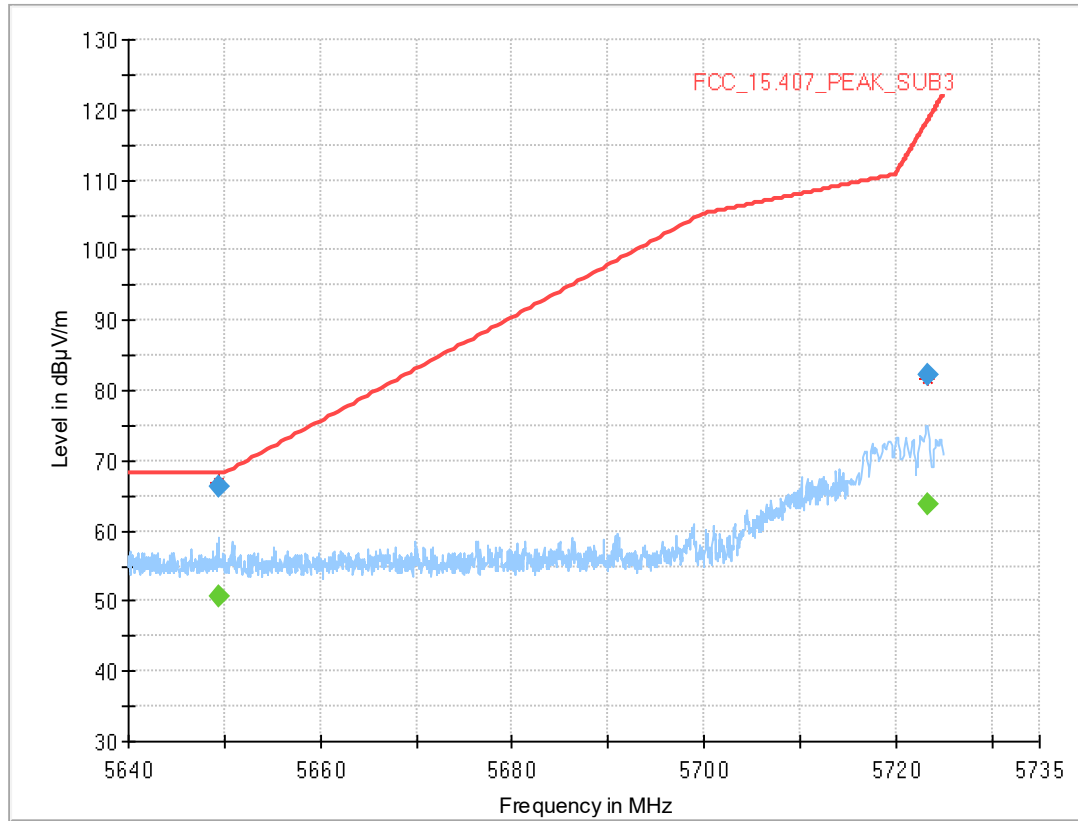

Final Result

Frequency (MHz)	MaxPeak (dBµV/m)	CAverage (dBµV/m)	Limit (dBµV/m)	Margin (dB)	Meas. Time (ms)	Bandwidth (kHz)	Height (cm)	Pol	Azimuth (deg)	Elevation (deg)	Corr. (dB/m)
5649.413	---	50.6	---	---	1000.0	1000.000	150.0	H	-139.0	15.0	14.1
5649.413	66.2	---	68.20	1.96	1000.0	1000.000	150.0	H	-139.0	15.0	14.1
5723.300	---	63.7	---	---	1000.0	1000.000	150.0	H	-143.0	6.0	14.2
5723.300	82.2	---	118.3	36.17	1000.0	1000.000	150.0	H	-143.0	6.0	14.2

Radio Technology = WLAN n 40 MHz, Operating Frequency = high, Subband = U-NII-3 (S02_166_AE01)

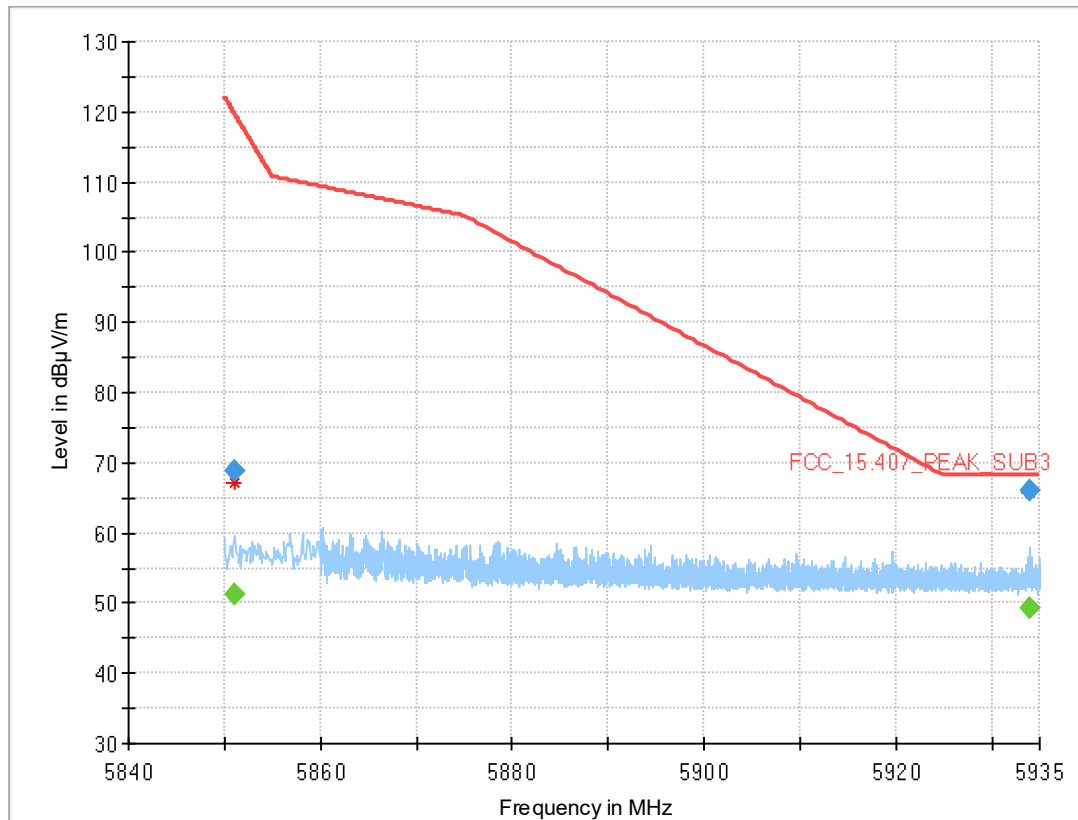

Final Result

Frequency (MHz)	MaxPeak (dBµV/m)	CAverage (dBµV/m)	Limit (dBµV/m)	Margin (dB)	Meas. Time (ms)	Bandwidth (kHz)	Height (cm)	Pol	Azimuth (deg)	Elevation (deg)	Corr. (dB/m)
5851.000	68.9	---	119.9	51.03	1000.0	1000.000	150.0	H	-145.0	4.0	14.9
5851.000	---	51.2	---	---	1000.0	1000.000	150.0	H	-145.0	4.0	14.9
5933.905	---	49.4	---	---	1000.0	1000.000	150.0	H	-145.0	8.0	15.0
5933.905	66.0	---	68.20	2.18	1000.0	1000.000	150.0	H	-145.0	8.0	15.0

5.4.5 TEST EQUIPMENT USED

- Radiated Emissions FAR 5 GHz FCC
- R&S TS8997

6 TEST EQUIPMENT

- 1 Conducted Emissions FCC
Conducted Emissions AC Mains for FCC standards

Ref.No.	Device Name	Description	Manufacturer	Serial Number	Last Calibration	Calibration Due
1.1	MFS	Rubidium Frequency Normal MFS	Datum GmbH	002	2021-11	2022-11
1.2	Opus10 TPR (8253.00)	T/P Logger 13	Lufft Mess- und Regeltechnik GmbH	13936	2021-10	2023-10
1.3	Chroma 6404	AC Source	Chroma ATE INC.	64040001304		
1.4	Shielded Room 02	Shielded Room 4m x 3m	Frankonia Germany EMC Solution GmbH	-		
1.5	ESH3-Z5	Two-Line V-Network (EUT)	Rohde & Schwarz GmbH & Co. KG	829996/002	2021-08	2023-08
1.6	ESR 7	EMI Receiver / Spectrum Analyzer	Rohde & Schwarz	101424	2021-01	2023-01
1.7	Opus10 THI (8152.00)	T/H Logger 02	Lufft Mess- und Regeltechnik GmbH	7489	2021-10	2023-10

- 2 R&S TS8997
2.4 and 5 GHz Bands Conducted Test Lab

Ref.No.	Device Name	Description	Manufacturer	Serial Number	Last Calibration	Calibration Due
2.1	MFS	Rubidium Frequency Normal MFS	Datum GmbH	002	2021-11	2022-11
2.2	Opus10 TPR (8253.00)	T/P Logger 13	Lufft Mess- und Regeltechnik GmbH	13936	2021-10	2023-10
2.3	SMB100A	Signal Generator 9 kHz - 6 GHz	Rohde & Schwarz	107695	2021-06	2024-06
2.4	EX520	Digital Multimeter 12	Extech Instruments Corp	05157876	2022-06	2024-06
2.5	NGSM 32/10	Power Supply	Rohde & Schwarz GmbH & Co. KG	3456	2022-01	2024-01
2.6	Temperature Chamber KWP 120/70	Temperature Chamber Weiss 01	Weiss	59226012190010	2022-05	2024-05
2.7	Temperature Chamber VT 4002	Temperature Chamber Vötsch 03	Vötsch	58566002150010	2022-05	2024-05
2.8	FSW43	Signal analyser	Rohde & Schwarz GmbH & Co. KG	102013	2021-06	2023-06
2.9	Opus10 THI (8152.00)	T/H Logger 14	Lufft Mess- und Regeltechnik GmbH	13993	2021-08	2023-08
2.10	SMBV100A	Vector Signal Generator 9 kHz - 6 GHz	Rohde & Schwarz	259291	2019-11	2022-11
2.11	OSP120	Contains Power Meter and Switching Unit OSP-B157W8	Rohde & Schwarz	101158	2021-08	2024-08

3 Radiated Emissions FAR 5 GHz FCC
Radiated Emissions Tests for 5 GHz bands in a fully anechoic room

Ref.No.	Device Name	Description	Manufacturer	Serial Number	Last Calibration	Calibration Due
3.1	Opus10 TPR (8253.00)	T/P Logger 13	Lufft Mess- und Regeltechnik GmbH	13936	2021-10	2023-10
3.2	AMF-7D00101800-30-10P-R	Broadband Amplifier 100 MHz - 18 GHz	Miteq			
3.3	Anechoic Chamber 03	FAR, 8.80m x 4.60m x 4.05m (l x w x h)	Albatross Projects	P26971-647-001-PRB	2021-04	2023-04
3.4	Fluke 177	Digital Multimeter 03 (Multimeter)	Fluke Europe B.V.	86670383	2022-06	2024-06
3.5	JS4-18002600-32-5P	Broadband Amplifier 18 GHz - 26 GHz	Miteq	849785		
3.6	FSW 43	Spectrum Analyzer	Rohde & Schwarz	103779	2021-06	2023-06
3.7	EP 1200/B, NA/B1	AC Source, Amplifier with integrated variable Oscillator	Spitzenberger & Spies GmbH & Co. KG	B6278		
3.8	3160-09	Standard Gain / Pyramidal Horn Antenna 26.5 GHz	EMCO Elektronik GmbH	00083069		
3.9	WHKX 7.0/18G-8SS	High Pass Filter	Wainwright Instruments GmbH	09		
3.10	TT 1.5 WI	Turn Table	Maturo GmbH	-		
3.11	3160-10	Standard Gain / Pyramidal Horn Antenna 40 GHz	EMCO Elektronik GmbH	00086675		
3.12	Opus 20 THI (8120.00)	ThermoHygro Datalogger	Lufft Mess- und Regeltechnik GmbH	115.0318.0802.033	2020-10	2022-10
3.13	TD1.5-10kg	EUT Tilt Device (Rohacell)	Maturo GmbH	TD1.5-10kg/024/3790709		
3.14	PAS 2.5 - 10 kg	Antenna Mast	Maturo GmbH	-		
3.15	AFS42-00101800-25-S-42	Broadband Amplifier 25 MHz - 18 GHz	Miteq	2035324		
3.16	HF 907	Double-ridged horn	Rohde & Schwarz	102444	2021-09	2024-09

4 Radiated Emissions SAC H-Field
Radiated emission tests in the H-Field in a semi anechoic room

Ref.No.	Device Name	Description	Manufacturer	Serial Number	Last Calibration	Calibration Due
4.1	Opus10 TPR (8253.00)	T/P Logger 13	Lufft Mess- und Regeltechnik GmbH	13936	2021-10	2023-10
4.2	ESW44	EMI Receiver / Spectrum Analyzer	Rohde & Schwarz GmbH & Co. KG	101603	2022-01	2024-01
4.3	Anechoic Chamber 01	SAC/FAR, 10.58 m x 6.38 m x 6.00 m	Frankonia	none		
4.4	Opus10 THI (8152.00)	T/H Logger 10	Lufft Mess- und Regeltechnik GmbH	12488	2021-08	2023-08
4.5	EP 1200/B, NA/B1	AC Source, Amplifier with integrated variable Oscillator	Spitzenberger & Spies GmbH & Co. KG	B6278		
4.6	DS 420S	Turn Table 2 m diameter	HD GmbH	420/573/99		
4.7	HFH2-Z2	Loop Antenna + 3 Axis Tripod	Rohde & Schwarz GmbH & Co. KG	829324/006	2021-01	2024-01

5 Radiated Emissions SAC up to 1 GHz
Radiated emission tests up to 1 GHz in a semi anechoic room

Ref.No.	Device Name	Description	Manufacturer	Serial Number	Last Calibration	Calibration Due
5.1	Opus10 TPR (8253.00)	T/P Logger 13	Lufft Mess- und Regeltechnik GmbH	13936	2021-10	2023-10
5.2	ESW44	EMI Receiver / Spectrum Analyzer	Rohde & Schwarz GmbH & Co. KG	101603	2022-01	2024-01
5.3	Anechoic Chamber 01	SAC/FAR, 10.58 m x 6.38 m x 6.00 m	Frankonia	none		
5.4	HL 562 ULTRALOG	Biconical-log-per antenna (30 MHz - 3 GHz) with HL 562E biconicals	Rohde & Schwarz GmbH & Co. KG	830547/003	2021-09	2024-09
5.5	Opus10 THI (8152.00)	T/H Logger 10	Lufft Mess- und Regeltechnik GmbH	12488	2021-08	2023-08
5.6	EP 1200/B, NA/B1	AC Source, Amplifier with integrated variable Oscillator	Spitzenberger & Spies GmbH & Co. KG	B6278		
5.7	DS 420S	Turn Table 2 m diameter	HD GmbH	420/573/99		
5.8	AM 4.0	Antenna Mast 4 m	Maturo GmbH	AM4.0/180/11920513		

The calibration interval is the time interval between “Last Calibration” and “Calibration Due”

7 ANTENNA FACTORS, CABLE LOSS AND SAMPLE CALCULATIONS

This chapter contains the antenna factors with their corresponding path loss of the used measurement path for all antennas as well as the insertion loss of the LISN.

7.1 LISN R&S ESH3-Z5 (150 KHZ – 30 MHZ)

Frequency MHz	Corr. dB	LISN insertion loss ESH3- Z5 dB	cable loss (incl. 10 dB atten- uator) dB
0.15	10.1	0.1	10.0
5	10.3	0.1	10.2
7	10.5	0.2	10.3
10	10.5	0.2	10.3
12	10.7	0.3	10.4
14	10.7	0.3	10.4
16	10.8	0.4	10.4
18	10.9	0.4	10.5
20	10.9	0.4	10.5
22	11.1	0.5	10.6
24	11.1	0.5	10.6
26	11.2	0.5	10.7
28	11.2	0.5	10.7
30	11.3	0.5	10.8

Sample calculation

$$U_{\text{LISN}} (\text{dB } \mu\text{V}) = U (\text{dB } \mu\text{V}) + \text{Corr. (dB)}$$

U = Receiver reading

LISN Insertion loss = Voltage Division Factor of LISN

Corr. = sum of single correction factors of used LISN, cables, switch units (if used)

Linear interpolation will be used for frequencies in between the values in the table.

7.2 ANTENNA R&S HFH2-Z2 (9 KHZ – 30 MHZ)

Frequency MHz	AF HFH-Z2) dB (1/m)	Corr. dB	cable loss 1 (inside chamber) dB	cable loss 2 (outside chamber) dB	cable loss 3 (switch unit) dB	cable loss 4 (to receiver) dB	distance corr. (-40 dB/ decade) dB	d _{Limit} (meas. distance (limit) m	d _{used} (meas. distance (used) m
0.009	20.50	-79.6	0.1	0.1	0.1	0.1	-80	300	3
0.01	20.45	-79.6	0.1	0.1	0.1	0.1	-80	300	3
0.015	20.37	-79.6	0.1	0.1	0.1	0.1	-80	300	3
0.02	20.36	-79.6	0.1	0.1	0.1	0.1	-80	300	3
0.025	20.38	-79.6	0.1	0.1	0.1	0.1	-80	300	3
0.03	20.32	-79.6	0.1	0.1	0.1	0.1	-80	300	3
0.05	20.35	-79.6	0.1	0.1	0.1	0.1	-80	300	3
0.08	20.30	-79.6	0.1	0.1	0.1	0.1	-80	300	3
0.1	20.20	-79.6	0.1	0.1	0.1	0.1	-80	300	3
0.2	20.17	-79.6	0.1	0.1	0.1	0.1	-80	300	3
0.3	20.14	-79.6	0.1	0.1	0.1	0.1	-80	300	3
0.49	20.12	-79.6	0.1	0.1	0.1	0.1	-80	300	3
0.490001	20.12	-39.6	0.1	0.1	0.1	0.1	-40	30	3
0.5	20.11	-39.6	0.1	0.1	0.1	0.1	-40	30	3
0.8	20.10	-39.6	0.1	0.1	0.1	0.1	-40	30	3
1	20.09	-39.6	0.1	0.1	0.1	0.1	-40	30	3
2	20.08	-39.6	0.1	0.1	0.1	0.1	-40	30	3
3	20.06	-39.6	0.1	0.1	0.1	0.1	-40	30	3
4	20.05	-39.5	0.2	0.1	0.1	0.1	-40	30	3
5	20.05	-39.5	0.2	0.1	0.1	0.1	-40	30	3
6	20.02	-39.5	0.2	0.1	0.1	0.1	-40	30	3
8	19.95	-39.5	0.2	0.1	0.1	0.1	-40	30	3
10	19.83	-39.4	0.2	0.1	0.2	0.1	-40	30	3
12	19.71	-39.4	0.2	0.1	0.2	0.1	-40	30	3
14	19.54	-39.4	0.2	0.1	0.2	0.1	-40	30	3
16	19.53	-39.3	0.3	0.1	0.2	0.1	-40	30	3
18	19.50	-39.3	0.3	0.1	0.2	0.1	-40	30	3
20	19.57	-39.3	0.3	0.1	0.2	0.1	-40	30	3
22	19.61	-39.3	0.3	0.1	0.2	0.1	-40	30	3
24	19.61	-39.3	0.3	0.1	0.2	0.1	-40	30	3
26	19.54	-39.3	0.3	0.1	0.2	0.1	-40	30	3
28	19.46	-39.2	0.3	0.1	0.3	0.1	-40	30	3
30	19.73	-39.1	0.4	0.1	0.3	0.1	-40	30	3

Sample calculation

$$E \text{ (dB } \mu\text{V/m)} = U \text{ (dB } \mu\text{V)} + AF \text{ (dB 1/m)} + Corr. \text{ (dB)}$$

U = Receiver reading

AF = Antenna factor

Corr. = sum of single correction factors of used cables, switch unit, distance correction, amplifier (if applicable)

distance correction = $-40 * \text{LOG} (d_{\text{Limit}} / d_{\text{used}})$

Linear interpolation will be used for frequencies in between the values in the table.

Table shows an extract of values

7.3 ANTENNA R&S HL562 (30 MHZ – 1 GHZ)

($d_{Limit} = 3\text{ m}$)

Frequency	AF R&S HL562	Corr.
MHz	dB (1/m)	dB
30	18.6	0.6
50	6.0	0.9
100	9.7	1.2
150	7.9	1.6
200	7.6	1.9
250	9.5	2.1
300	11.0	2.3
350	12.4	2.6
400	13.6	2.9
450	14.7	3.1
500	15.6	3.2
550	16.3	3.5
600	17.2	3.5
650	18.1	3.6
700	18.5	3.6
750	19.1	4.1
800	19.6	4.1
850	20.1	4.4
900	20.8	4.7
950	21.1	4.8
1000	21.6	4.9

cable loss 1 (inside chamber)	cable loss 2 (outside chamber)	cable loss 3 (switch unit)	cable loss 4 (to receiver)	distance corr. (-20 dB/ decade)	d_{Limit} (meas. distance (limit))	d_{used} (meas. distance (used))
dB	dB	dB	dB	dB	m	m
0.29	0.04	0.23	0.02	0.0	3	3
0.39	0.09	0.32	0.08	0.0	3	3
0.56	0.14	0.47	0.08	0.0	3	3
0.73	0.20	0.59	0.12	0.0	3	3
0.84	0.21	0.70	0.11	0.0	3	3
0.98	0.24	0.80	0.13	0.0	3	3
1.04	0.26	0.89	0.15	0.0	3	3
1.18	0.31	0.96	0.13	0.0	3	3
1.28	0.35	1.03	0.19	0.0	3	3
1.39	0.38	1.11	0.22	0.0	3	3
1.44	0.39	1.20	0.19	0.0	3	3
1.55	0.46	1.24	0.23	0.0	3	3
1.59	0.43	1.29	0.23	0.0	3	3
1.67	0.34	1.35	0.22	0.0	3	3
1.67	0.42	1.41	0.15	0.0	3	3
1.87	0.54	1.46	0.25	0.0	3	3
1.90	0.46	1.51	0.25	0.0	3	3
1.99	0.60	1.56	0.27	0.0	3	3
2.14	0.60	1.63	0.29	0.0	3	3
2.22	0.60	1.66	0.33	0.0	3	3
2.23	0.61	1.71	0.30	0.0	3	3

($d_{Limit} = 10\text{ m}$)

30	18.6	-9.9
50	6.0	-9.6
100	9.7	-9.2
150	7.9	-8.8
200	7.6	-8.6
250	9.5	-8.3
300	11.0	-8.1
350	12.4	-7.9
400	13.6	-7.6
450	14.7	-7.4
500	15.6	-7.2
550	16.3	-7.0
600	17.2	-6.9
650	18.1	-6.9
700	18.5	-6.8
750	19.1	-6.3
800	19.6	-6.3
850	20.1	-6.0
900	20.8	-5.8
950	21.1	-5.6
1000	21.6	-5.6

0.29	0.04	0.23	0.02	-10.5	10	3
0.39	0.09	0.32	0.08	-10.5	10	3
0.56	0.14	0.47	0.08	-10.5	10	3
0.73	0.20	0.59	0.12	-10.5	10	3
0.84	0.21	0.70	0.11	-10.5	10	3
0.98	0.24	0.80	0.13	-10.5	10	3
1.04	0.26	0.89	0.15	-10.5	10	3
1.18	0.31	0.96	0.13	-10.5	10	3
1.28	0.35	1.03	0.19	-10.5	10	3
1.39	0.38	1.11	0.22	-10.5	10	3
1.44	0.39	1.20	0.19	-10.5	10	3
1.55	0.46	1.24	0.23	-10.5	10	3
1.59	0.43	1.29	0.23	-10.5	10	3
1.67	0.34	1.35	0.22	-10.5	10	3
1.67	0.42	1.41	0.15	-10.5	10	3
1.87	0.54	1.46	0.25	-10.5	10	3
1.90	0.46	1.51	0.25	-10.5	10	3
1.99	0.60	1.56	0.27	-10.5	10	3
2.14	0.60	1.63	0.29	-10.5	10	3
2.22	0.60	1.66	0.33	-10.5	10	3
2.23	0.61	1.71	0.30	-10.5	10	3

Sample calculation

$$E \text{ (dB } \mu\text{V/m)} = U \text{ (dB } \mu\text{V)} + \text{AF (dB 1/m)} + \text{Corr. (dB)}$$

U = Receiver reading

AF = Antenna factor

Corr. = sum of single correction factors of used cables, switch unit, distance correction, amplifier (if applicable)

distance correction = $-20 * \text{LOG} (d_{Limit} / d_{used})$

Linear interpolation will be used for frequencies in between the values in the table.

Tables show an extract of values.

7.4 ANTENNA R&S HF907 (1 GHZ – 18 GHZ)

Frequency	AF R&S HF907	Corr.
MHz	dB (1/m)	dB
1000	24.4	-19.4
2000	28.5	-17.4
3000	31.0	-16.1
4000	33.1	-14.7
5000	34.4	-13.7
6000	34.7	-12.7
7000	35.6	-11.0

cable loss 1 (relay + cable inside chamber)	cable loss 2 (outside chamber)	cable loss 3 (switch unit, attenuator & pre-amp)	cable loss 4 (to receiver)		
dB	dB	dB	dB		
0.99	0.31	-21.51	0.79		
1.44	0.44	-20.63	1.38		
1.87	0.53	-19.85	1.33		
2.41	0.67	-19.13	1.31		
2.78	0.86	-18.71	1.40		
2.74	0.90	-17.83	1.47		
2.82	0.86	-16.19	1.46		

Frequency	AF R&S HF907	Corr.
MHz	dB (1/m)	dB
3000	31.0	-23.4
4000	33.1	-23.3
5000	34.4	-21.7
6000	34.7	-21.2
7000	35.6	-19.8

cable loss 1 (relay inside chamber)	cable loss 2 (inside chamber)	cable loss 3 (outside chamber)	cable loss 4 (switch unit, attenuator & pre-amp)	cable loss 5 (to receiver)	used for FCC 15.247
dB	dB	dB	dB	dB	
0.47	1.87	0.53	-27.58	1.33	
0.56	2.41	0.67	-28.23	1.31	
0.61	2.78	0.86	-27.35	1.40	
0.58	2.74	0.90	-26.89	1.47	
0.66	2.82	0.86	-25.58	1.46	

Frequency	AF R&S HF907	Corr.
MHz	dB (1/m)	dB
7000	35.6	-57.3
8000	36.3	-56.3
9000	37.1	-55.3
10000	37.5	-56.2
11000	37.5	-55.3
12000	37.6	-53.7
13000	38.2	-53.5
14000	39.9	-56.3
15000	40.9	-54.1
16000	41.3	-54.1
17000	42.8	-54.4
18000	44.2	-54.7

cable loss 1 (relay inside chamber)	cable loss 2 (High Pass)	cable loss 3 (pre-amp)	cable loss 4 (inside chamber)	cable loss 5 (outside chamber)	cable loss 6 (to receiver)
dB	dB	dB	dB	dB	dB
0.56	1.28	-62.72	2.66	0.94	1.46
0.69	0.71	-61.49	2.84	1.00	1.53
0.68	0.65	-60.80	3.06	1.09	1.60
0.70	0.54	-61.91	3.28	1.20	1.67
0.80	0.61	-61.40	3.43	1.27	1.70
0.84	0.42	-59.70	3.53	1.26	1.73
0.83	0.44	-59.81	3.75	1.32	1.83
0.91	0.53	-63.03	3.91	1.40	1.77
0.98	0.54	-61.05	4.02	1.44	1.83
1.23	0.49	-61.51	4.17	1.51	1.85
1.36	0.76	-62.36	4.34	1.53	2.00
1.70	0.53	-62.88	4.41	1.55	1.91

Sample calculation

$$E \text{ (dB } \mu\text{V/m)} = U \text{ (dB } \mu\text{V)} + \text{AF (dB 1/m)} + \text{Corr. (dB)}$$

U = Receiver reading

AF = Antenna factor

Corr. = sum of single correction factors of used cables, switch unit, distance correction, amplifier (if applicable)

Linear interpolation will be used for frequencies in between the values in the table.

Tables show an extract of values.

7.5 ANTENNA EMCO 3160-09 (18 GHZ – 26.5 GHZ)

Frequency MHz	AF EMCO 3160-09 dB (1/m)	Corr. dB
18000	40.2	-23.5
18500	40.2	-23.2
19000	40.2	-22.0
19500	40.3	-21.3
20000	40.3	-20.3
20500	40.3	-19.9
21000	40.3	-19.1
21500	40.3	-19.1
22000	40.3	-18.7
22500	40.4	-19.0
23000	40.4	-19.5
23500	40.4	-19.3
24000	40.4	-19.8
24500	40.4	-19.5
25000	40.4	-19.3
25500	40.5	-20.4
26000	40.5	-21.3
26500	40.5	-21.1

cable loss 1 (inside chamber) dB	cable loss 2 (pre- amp) dB	cable loss 3 (inside chamber) dB	cable loss 4 (switch unit) dB	cable loss 5 (to receiver) dB
0.72	-35.85	6.20	2.81	2.65
0.69	-35.71	6.46	2.76	2.59
0.76	-35.44	6.69	3.15	2.79
0.74	-35.07	7.04	3.11	2.91
0.72	-34.49	7.30	3.07	3.05
0.78	-34.46	7.48	3.12	3.15
0.87	-34.07	7.61	3.20	3.33
0.90	-33.96	7.47	3.28	3.19
0.89	-33.57	7.34	3.35	3.28
0.87	-33.66	7.06	3.75	2.94
0.88	-33.75	6.92	3.77	2.70
0.90	-33.35	6.99	3.52	2.66
0.88	-33.99	6.88	3.88	2.58
0.91	-33.89	7.01	3.93	2.51
0.88	-33.00	6.72	3.96	2.14
0.89	-34.07	6.90	3.66	2.22
0.86	-35.11	7.02	3.69	2.28
0.90	-35.20	7.15	3.91	2.36

Sample calculation

$$E \text{ (dB } \mu\text{V/m)} = U \text{ (dB } \mu\text{V)} + AF \text{ (dB 1/m)} + Corr. \text{ (dB)}$$

U = Receiver reading

AF = Antenna factor

Corr. = sum of single correction factors of used cables, switch unit, distance correction, amplifier (if applicable)

Linear interpolation will be used for frequencies in between the values in the table.

Table shows an extract of values.

7.6 ANTENNA EMCO 3160-10 (26.5 GHZ – 40 GHZ)

Frequency GHz	AF EMCO 3160-10 dB (1/m)	Corr. dB	cable loss 1 (inside chamber) dB	cable loss 2 (outside chamber) dB	cable loss 3 (switch unit) dB	cable loss 4 (to receiver) dB	distance corr. (-20 dB/ decade) dB	d _{Limit} (meas. distance (limit) m	d _{used} (meas. distance (used) m
26.5	43.4	-11.2	4.4				-9.5	3	1.0
27.0	43.4	-11.2	4.4				-9.5	3	1.0
28.0	43.4	-11.1	4.5				-9.5	3	1.0
29.0	43.5	-11.0	4.6				-9.5	3	1.0
30.0	43.5	-10.9	4.7				-9.5	3	1.0
31.0	43.5	-10.8	4.7				-9.5	3	1.0
32.0	43.5	-10.7	4.8				-9.5	3	1.0
33.0	43.6	-10.7	4.9				-9.5	3	1.0
34.0	43.6	-10.6	5.0				-9.5	3	1.0
35.0	43.6	-10.5	5.1				-9.5	3	1.0
36.0	43.6	-10.4	5.1				-9.5	3	1.0
37.0	43.7	-10.3	5.2				-9.5	3	1.0
38.0	43.7	-10.2	5.3				-9.5	3	1.0
39.0	43.7	-10.2	5.4				-9.5	3	1.0
40.0	43.8	-10.1	5.5				-9.5	3	1.0

Sample calculation

$$E \text{ (dB } \mu\text{V/m)} = U \text{ (dB } \mu\text{V)} + \text{AF (dB 1/m)} + \text{Corr. (dB)}$$

U = Receiver reading

AF = Antenna factor

Corr. = sum of single correction factors of used cables, switch unit, distance correction, amplifier (if applicable)

Linear interpolation will be used for frequencies in between the values in the table.

distance correction = $-20 * \text{LOG} (d_{\text{Limit}} / d_{\text{used}})$

Linear interpolation will be used for frequencies in between the values in the table.

Table shows an extract of values.

8 MEASUREMENT UNCERTAINTIES

Test Case	Parameter	Uncertainty
AC Power Line	Power	± 3.4 dB
Field Strength of spurious radiation	Power	± 5.5 dB
6 dB / 26 dB / 99% Bandwidth	Power Frequency	± 2.9 dB ± 11.2 kHz
Conducted Output Power	Power	± 2.2 dB
Band Edge Compliance	Power Frequency	± 2.2 dB ± 11.2 kHz
Frequency Stability	Frequency	± 25 Hz
Power Spectral Density	Power	± 2.2 dB

The measurement uncertainties for all parameters are calculated with an expansion factor (coverage factor) $k = 1.96$. This means, that the true value is in the corresponding interval with a probability of 95 %.

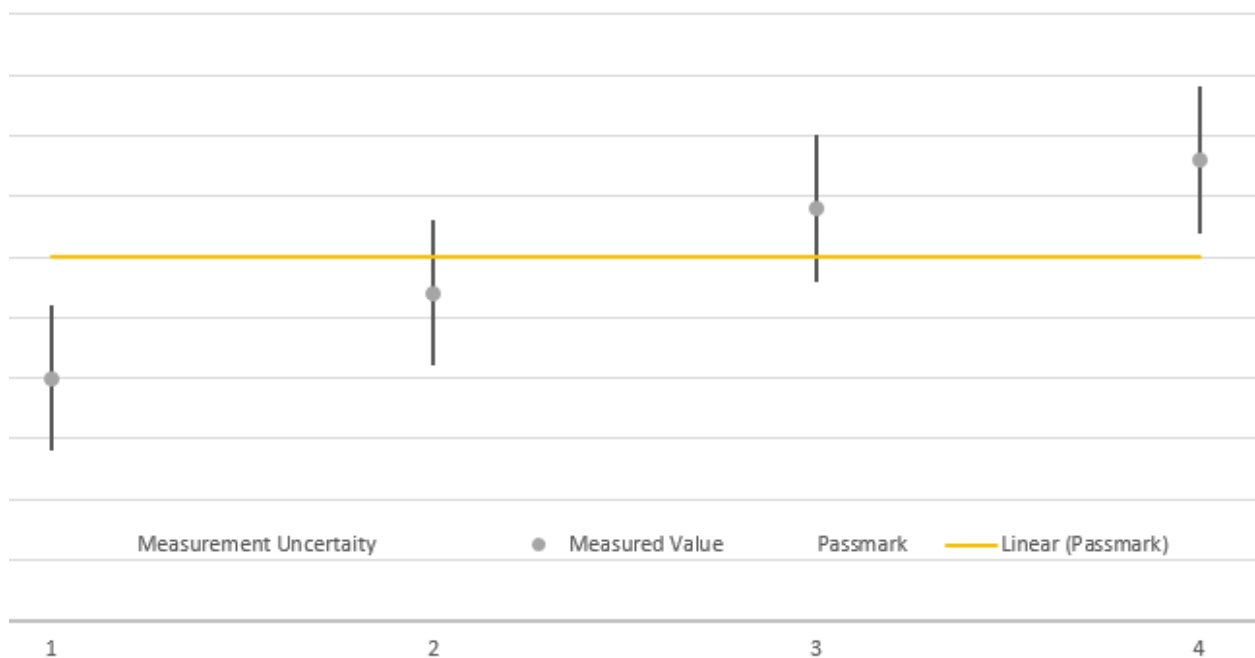

The verdicts in this test report are given according the above diagram:

Case	Measured Value	Uncertainty Range	Verdict
1	below pass mark	below pass mark	Passed
2	below pass mark	within pass mark	Passed
3	above pass mark	within pass mark	Failed
4	above pass mark	above pass mark	Failed

That means, the laboratory applies, as decision rule (see ISO/IEC 17025:2017), the so called shared risk principle.

9 PHOTO REPORT

Please see separate photo report.