

Radio Technology = Bluetooth BDR, Operating Frequency = low, Measurement range = 30 MHz - 1 GHz  
(S01\_161\_AD01)

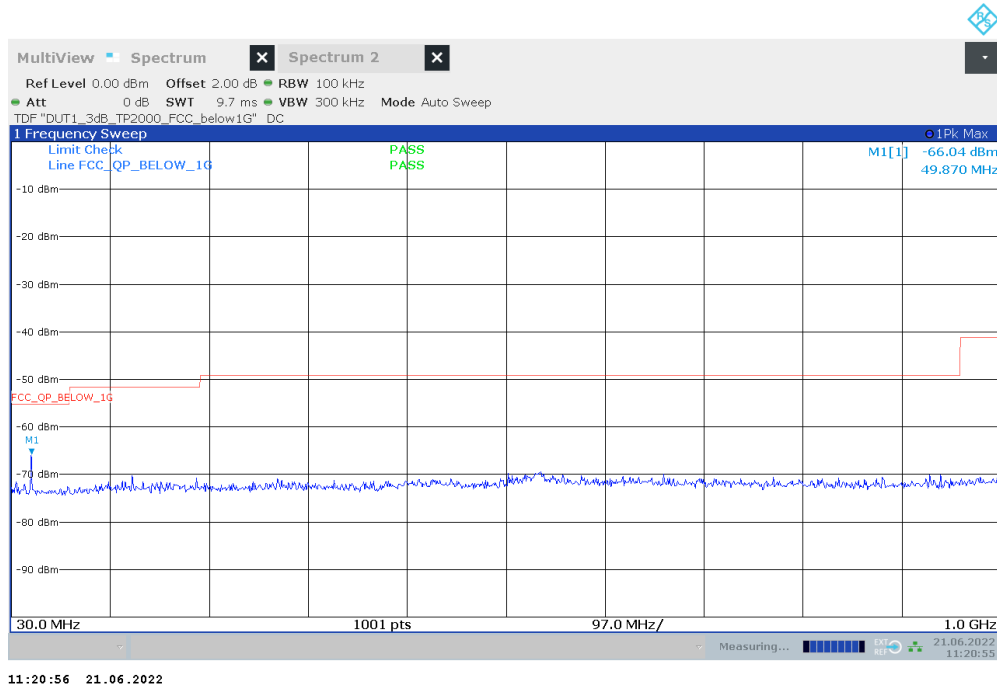

Radio Technology = Bluetooth BDR, Operating Frequency = low, Measurement range = 30 MHz - 1 GHz  
(S02\_161\_AB01)

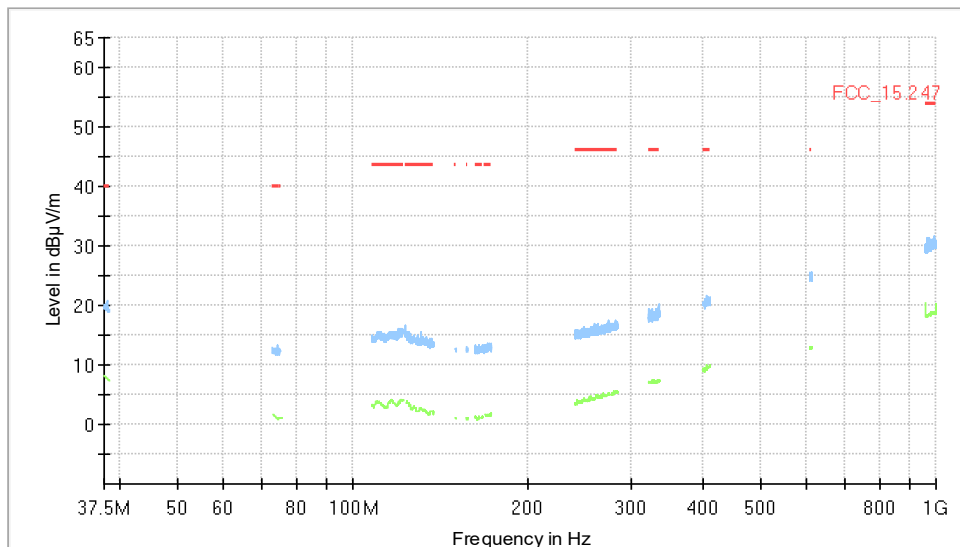

### Final Result

Frequency (MHz)	QuasiPeak (dBµV/m)	Limit (dBµV/m)	Margin (dB)	Meas. Time (ms)	Bandwidth (kHz)	Height (cm)	Pol	Azimuth (deg)	Corr. (dB/m)
---	---	---	---	---	---	---	---	---	---

Radio Technology = Bluetooth BDR, Operating Frequency = mid, Measurement range = 30 MHz - 1 GHz  
(S01\_161\_AD01)

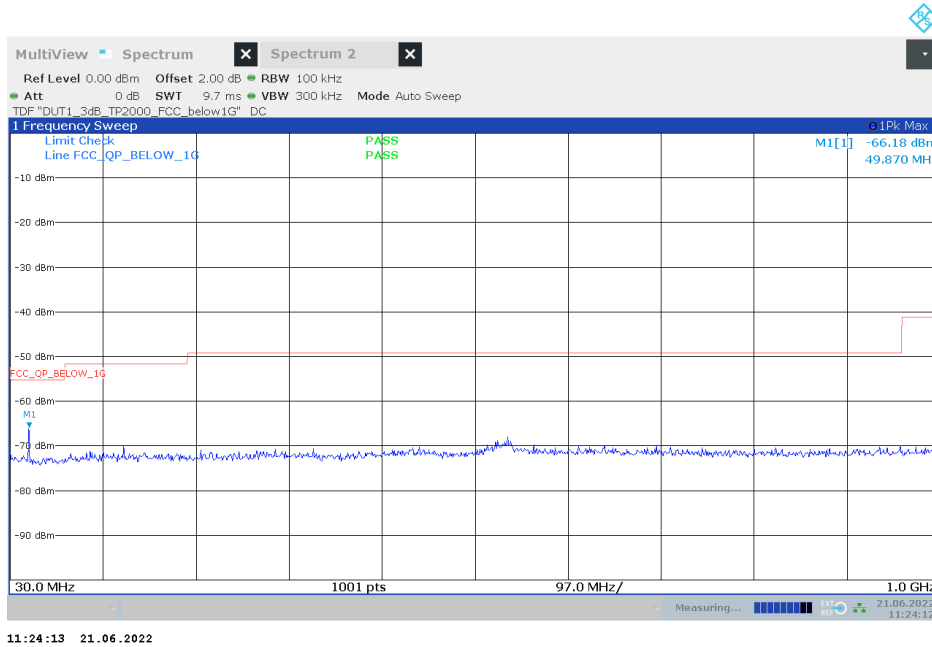

Radio Technology = Bluetooth BDR, Operating Frequency = mid, Measurement range = 30 MHz - 1 GHz  
(S02\_161\_AB01)

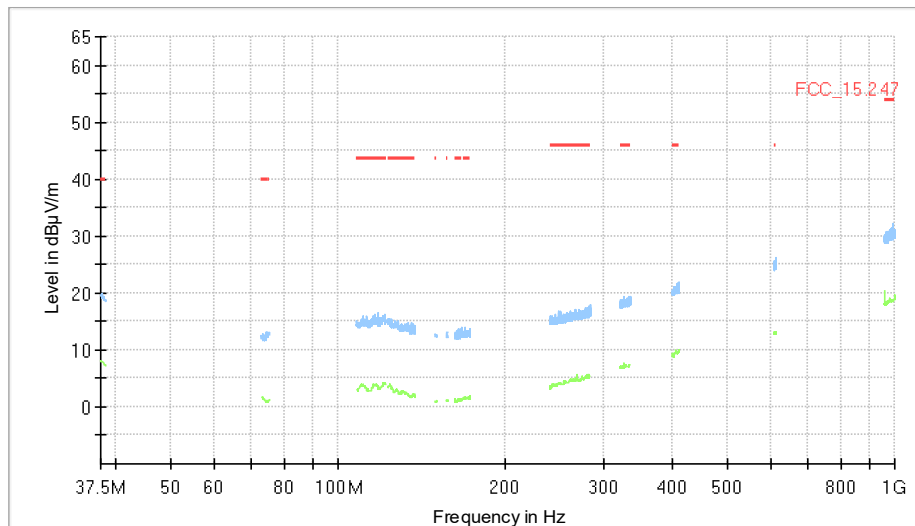

## Final Result

Frequency (MHz)	QuasiPeak (dBµV/m)	Limit (dBµV/m)	Margin (dB)	Meas. Time (ms)	Bandwidth (kHz)	Height (cm)	Pol	Azimuth (deg)	Corr. (dB/m)
---	---	---	---	---	---	---	---	---	---

Radio Technology = Bluetooth BDR, Operating Frequency = high, Measurement range = 30 MHz - 1 GHz  
(S01\_161\_AD01)

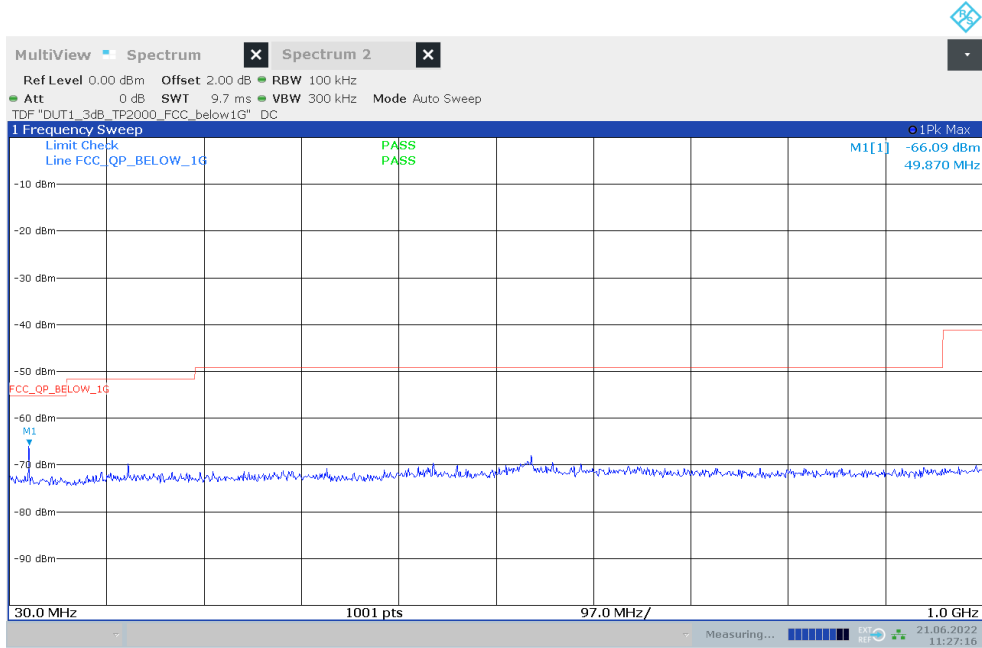

11:27:17 21.06.2022

Radio Technology = Bluetooth BDR, Operating Frequency = high, Measurement range = 30 MHz - 1 GHz  
(S02\_161\_AB01)

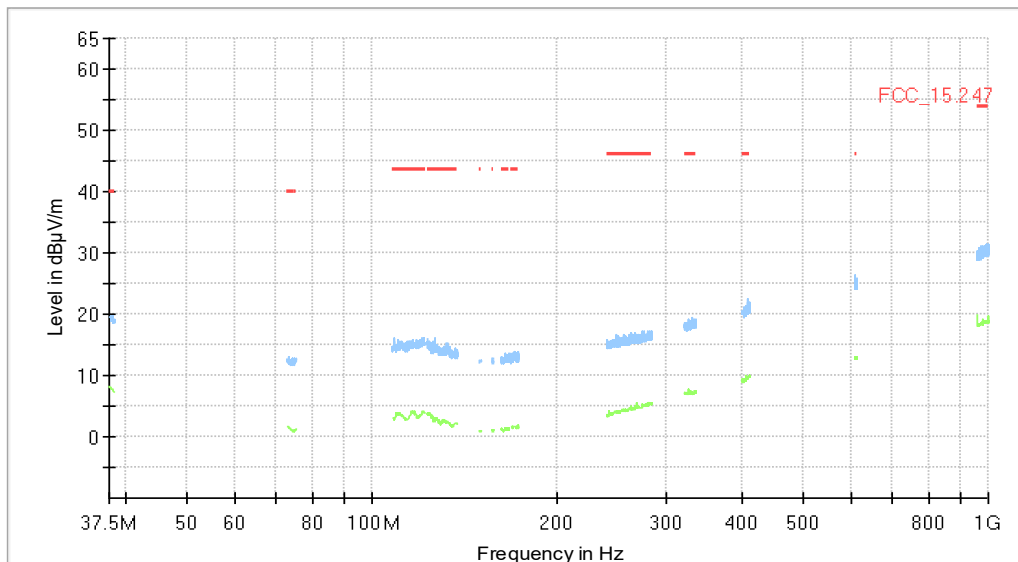

### Final Result

Frequency (MHz)	QuasiPeak (dBµV/m)	Limit (dBµV/m)	Margin (dB)	Meas. Time (ms)	Bandwidth (kHz)	Height (cm)	Pol	Azimuth (deg)	Corr. (dB/m)
---	---	---	---	---	---	---	---	---	---

Radio Technology = WLAN b, Operating Frequency = low, Measurement range = 30 MHz - 1 GHz  
(S01\_161\_AD01)

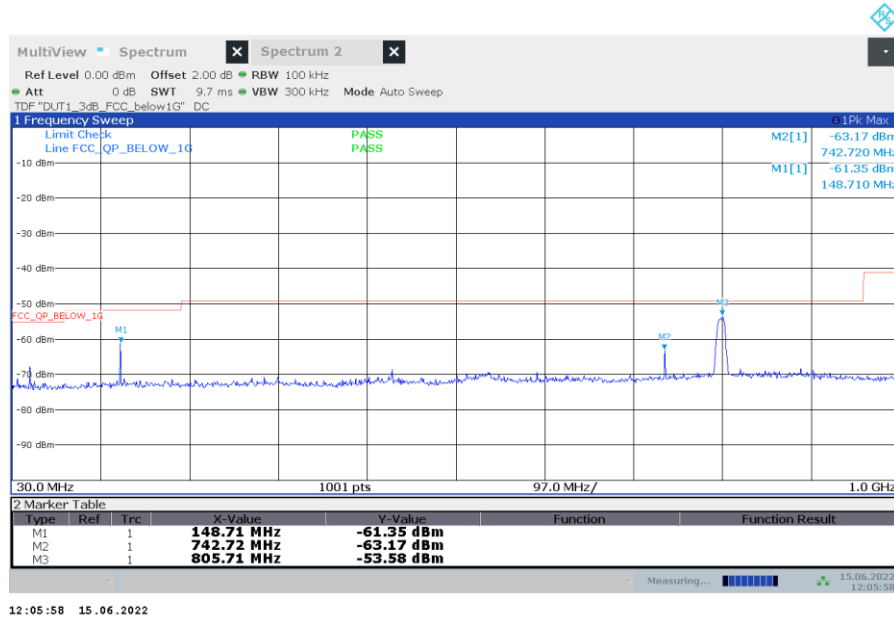

Radio Technology = WLAN b, Operating Frequency = low, Measurement range = 30 MHz - 1 GHz  
(S02\_161\_AB01)

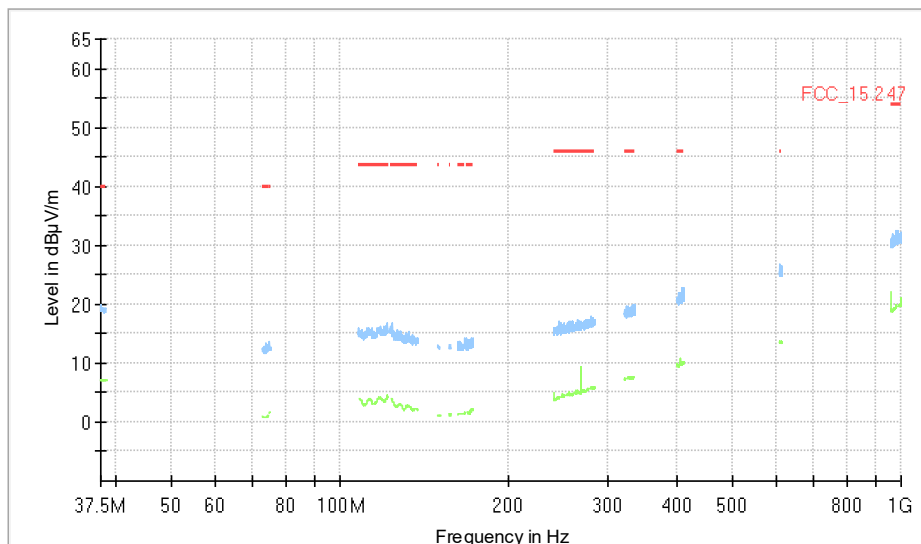

### Final Result

Frequency (MHz)	QuasiPeak (dBµV/m)	Limit (dBµV/m)	Margin (dB)	Meas. Time (ms)	Bandwidth (kHz)	Height (cm)	Pol	Azimuth (deg)	Corr. (dB/m)
---	---	---	---	---	---	---	---	---	---

Radio Technology = WLAN b, Operating Frequency = mid, Measurement range = 30 MHz - 1 GHz  
(S02\_161\_AB01)

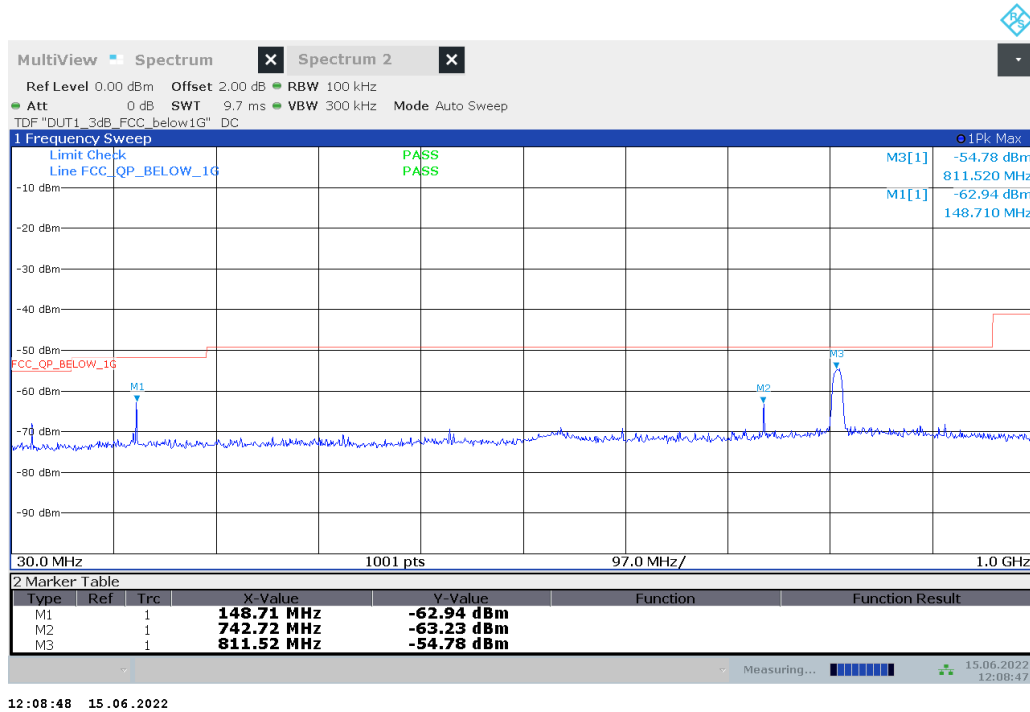

Radio Technology = WLAN b, Operating Frequency = high, Measurement range = 30 MHz - 1 GHz  
(S02\_161\_AB01)

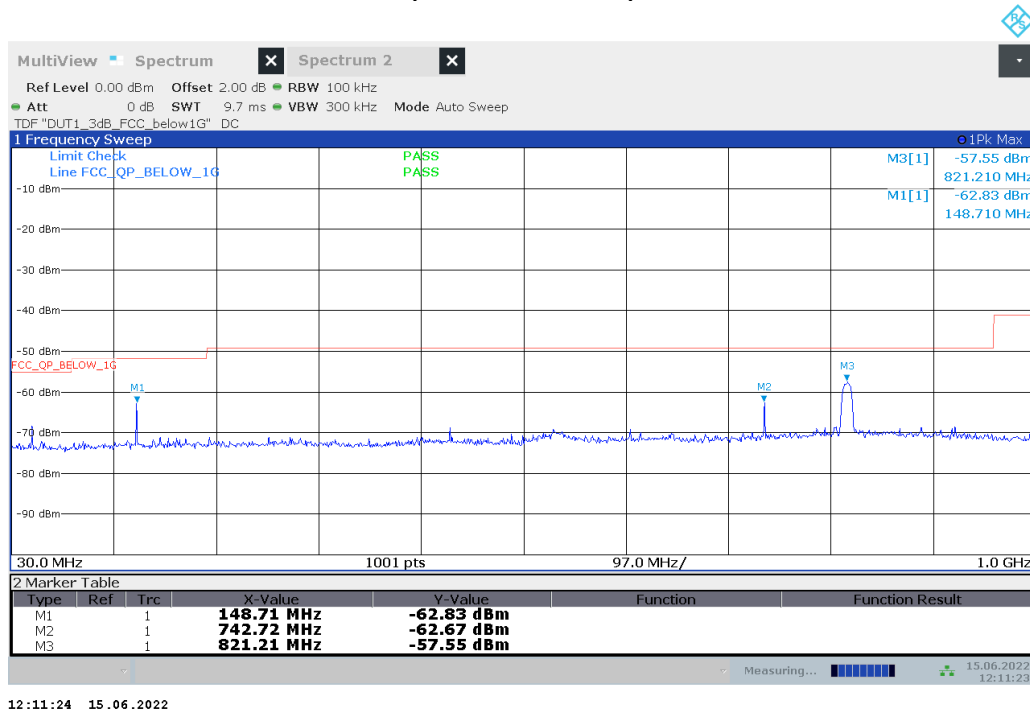

Radio Technology = WLAN b, Operating Frequency = high, Measurement range = 30 MHz - 1 GHz  
(S02\_161\_AB01)

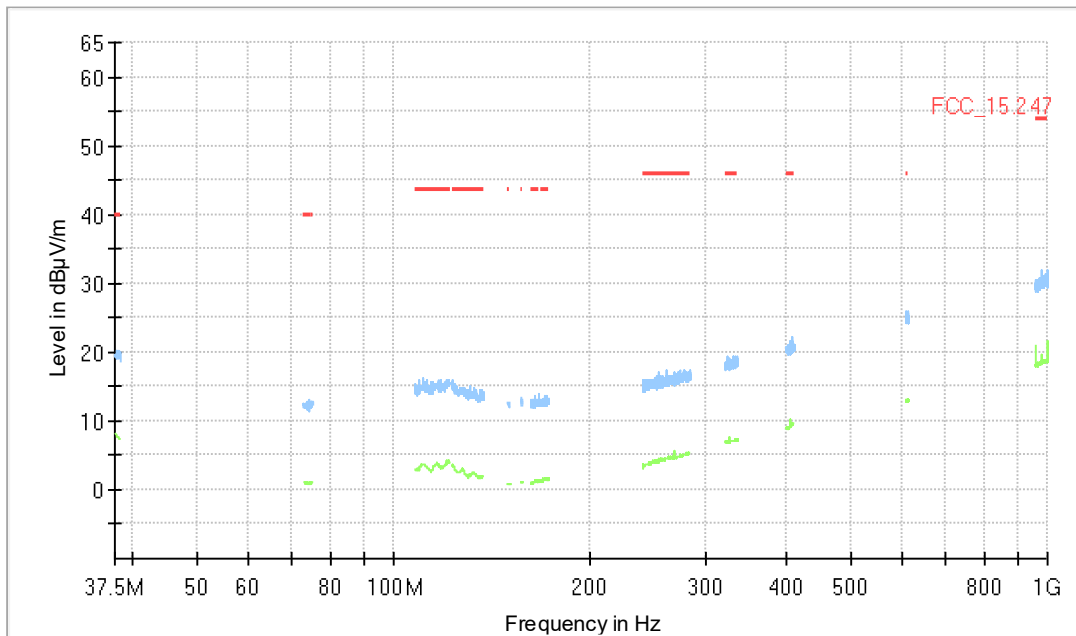

### Final Result

Frequency (MHz)	QuasiPeak (dBµV/m)	Limit (dBµV/m)	Margin (dB)	Meas. Time (ms)	Bandwidth (kHz)	Height (cm)	Pol	Azimuth (deg)	Corr. (dB/m)
---	---	---	---	---	---	---	---	---	---

Radio Technology = Bluetooth BDR, Operating Frequency = low, Measurement range = 1 GHz - 26 GHz  
(S01\_161\_AD01)

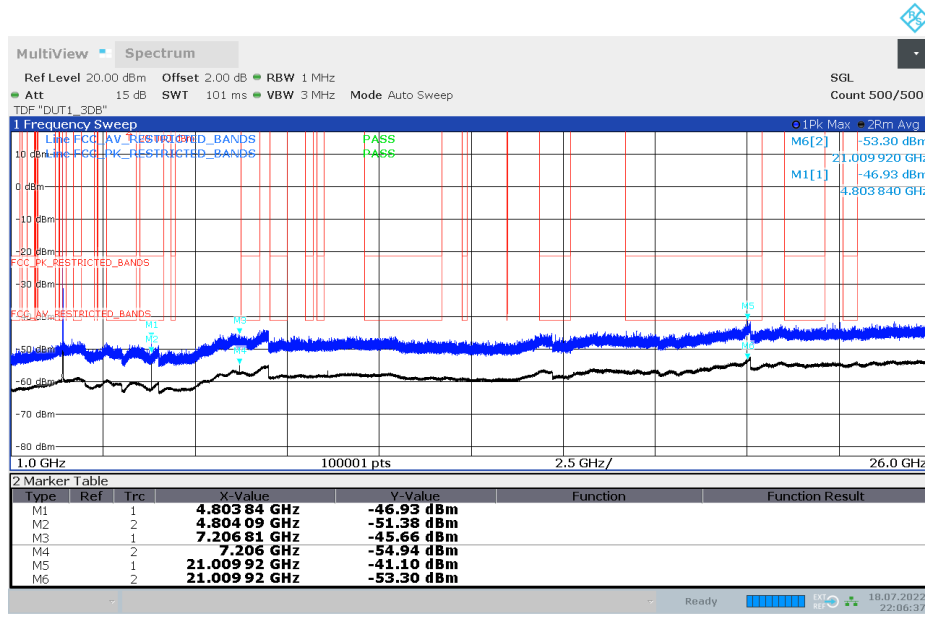

22:06:38 18.07.2022

Radio Technology = Bluetooth BDR, Operating Frequency = low, Measurement range = 1 GHz - 26 GHz  
(S02\_161\_AB01)

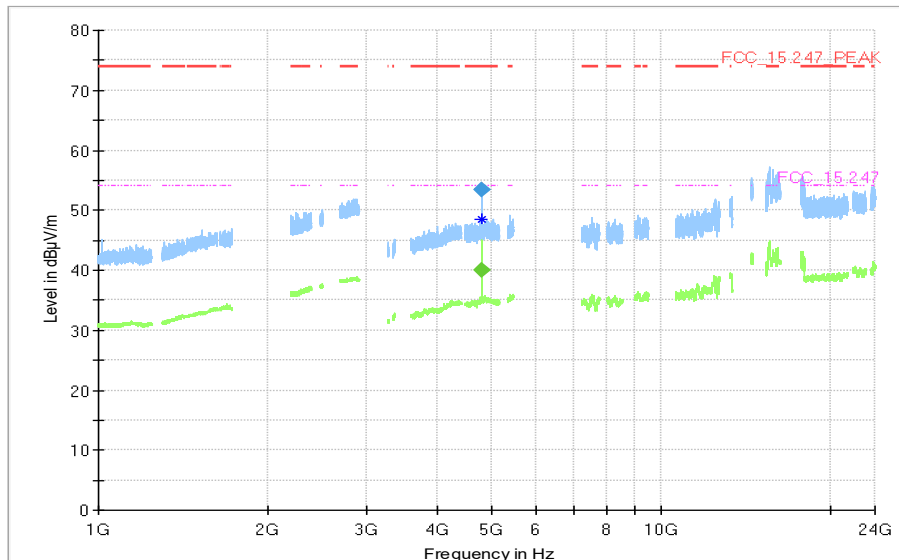

### Final Result

Frequency (MHz)	MaxPeak (dBµV/m)	CAverage (dBµV/m)	Limit (dBµV/m)	Margin (dB)	Meas. Time (ms)	Bandwidth (kHz)	Height (cm)	Pol	Azimuth (deg)	Elevation (deg)	Corr. (dB/m)
4803.713	---	40.0	54.00	13.97	1000.0	1000.000	150.0	V	-91.0	-12.0	4.9
4803.713	53.5	---	74.00	20.48	1000.0	1000.000	150.0	V	-91.0	-12.0	4.9

Radio Technology = Bluetooth BDR, Operating Frequency = mid, Measurement range = 1 GHz - 26 GHz  
(S01\_161\_AD01)

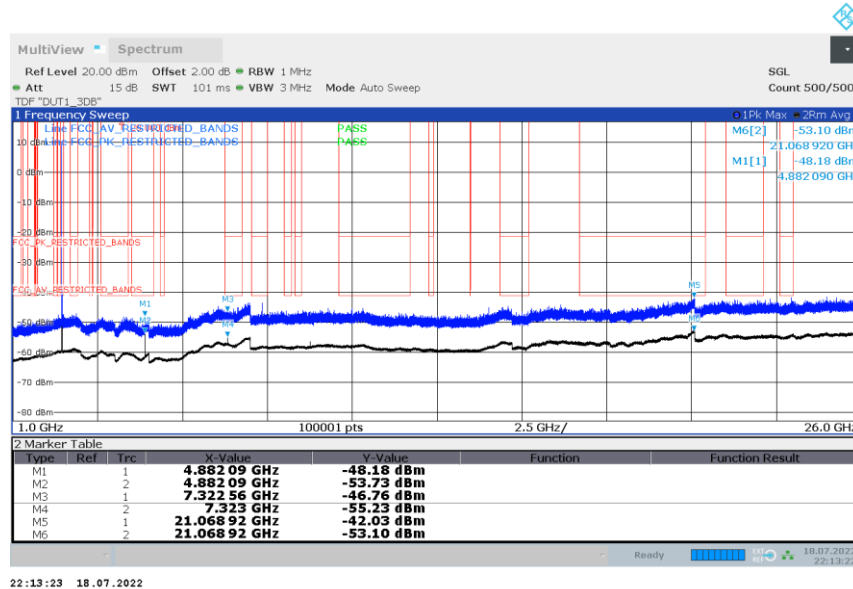

Radio Technology = Bluetooth BDR, Operating Frequency = mid, Measurement range = 1 GHz - 26 GHz  
(S02\_161\_AB01)

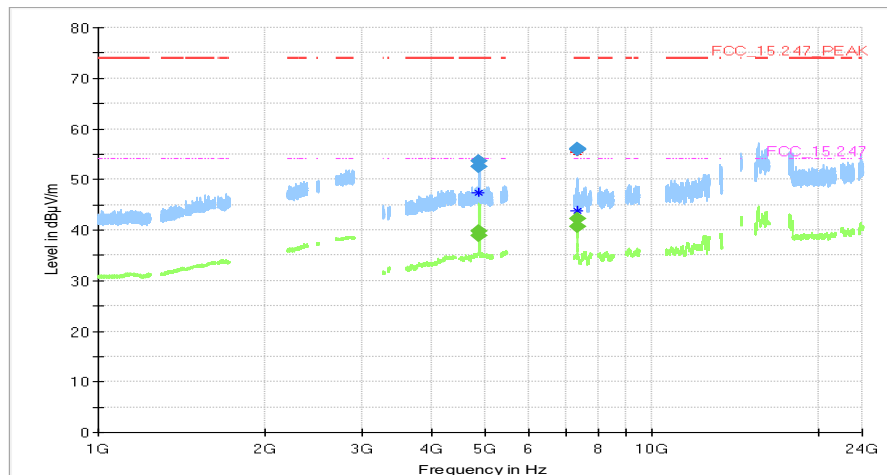

### Final Result

Frequency (MHz)	MaxPeak (dBµV/m)	CAverage (dBµV/m)	Limit (dBµV/m)	Margin (dB)	Meas. Time (ms)	Bandwidth (kHz)	Height (cm)	Pol	Azimuth (deg)	Elevation (deg)	Corr. (dB/m)
4881.388	---	39.0	54.00	15.02	1000.0	1000.000	150.0	H	-34.0	95.0	4.5
4881.388	53.7	---	74.00	20.31	1000.0	1000.000	150.0	H	-34.0	95.0	4.5
4882.038	52.5	---	74.00	21.54	1000.0	1000.000	150.0	V	-90.0	-1.0	4.5
4882.038	---	39.8	54.00	14.17	1000.0	1000.000	150.0	V	-90.0	-1.0	4.5
7322.375	55.9	---	74.00	18.11	1000.0	1000.000	150.0	V	-154.0	-15.0	-13.2
7322.375	---	40.7	54.00	13.32	1000.0	1000.000	150.0	V	-154.0	-15.0	-13.2
7323.000	---	42.3	54.00	11.67	1000.0	1000.000	150.0	V	-153.0	-15.0	-13.2
7323.000	56.0	---	74.00	18.00	1000.0	1000.000	150.0	V	-153.0	-15.0	-13.2



Radio Technology = Bluetooth BDR, Operating Frequency = high, Measurement range = 1 GHz - 26 GHz  
(S01\_161\_AD01)

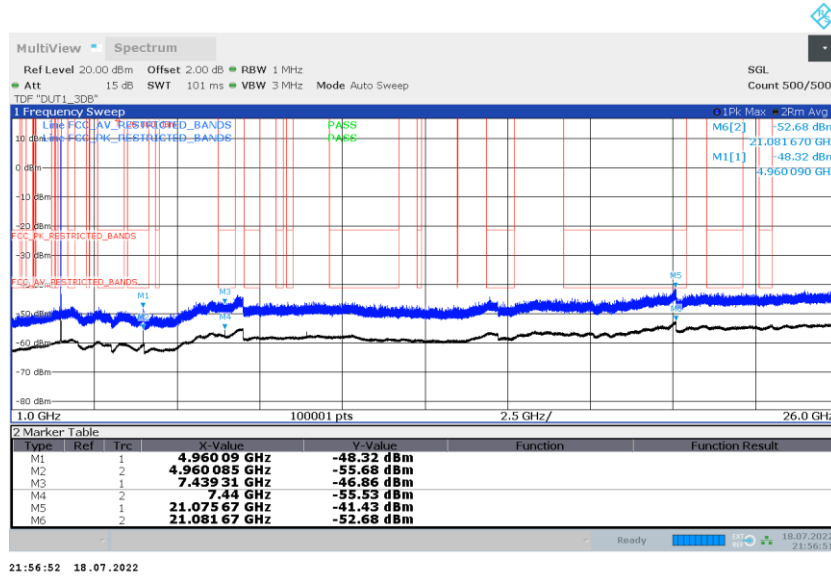

Radio Technology = Bluetooth BDR, Operating Frequency = high, Measurement range = 1 GHz - 26 GHz  
(S02\_161\_AB01)

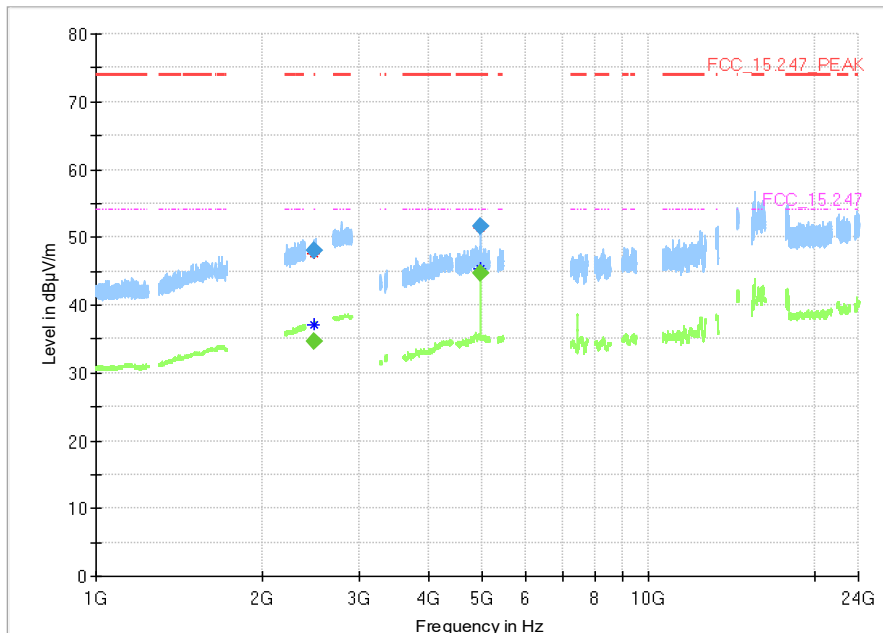

### Final Result

Frequency (MHz)	MaxPeak (dBµV/m)	CAverage (dBµV/m)	Limit (dBµV/m)	Margin (dB)	Meas. Time (ms)	Bandwidth (kHz)	Height (cm)	Pol	Azimuth (deg)	Elevation (deg)	Corr. (dB/m)
2483.500	---	34.7	54.00	19.33	1000.0	1000.000	150.0	H	-149.0	8.0	5.3
2483.500	48.1	---	74.00	25.89	1000.0	1000.000	150.0	H	-149.0	8.0	5.3
4960.038	---	44.8	54.00	9.24	1000.0	1000.000	150.0	V	-59.0	-12.0	4.4
4960.038	51.5	---	74.00	22.49	1000.0	1000.000	150.0	V	-59.0	-12.0	4.4

Radio Technology = Bluetooth EDR 2, Operating Frequency = low, Measurement range = 1 GHz - 26 GHz (S01\_161\_AD01)

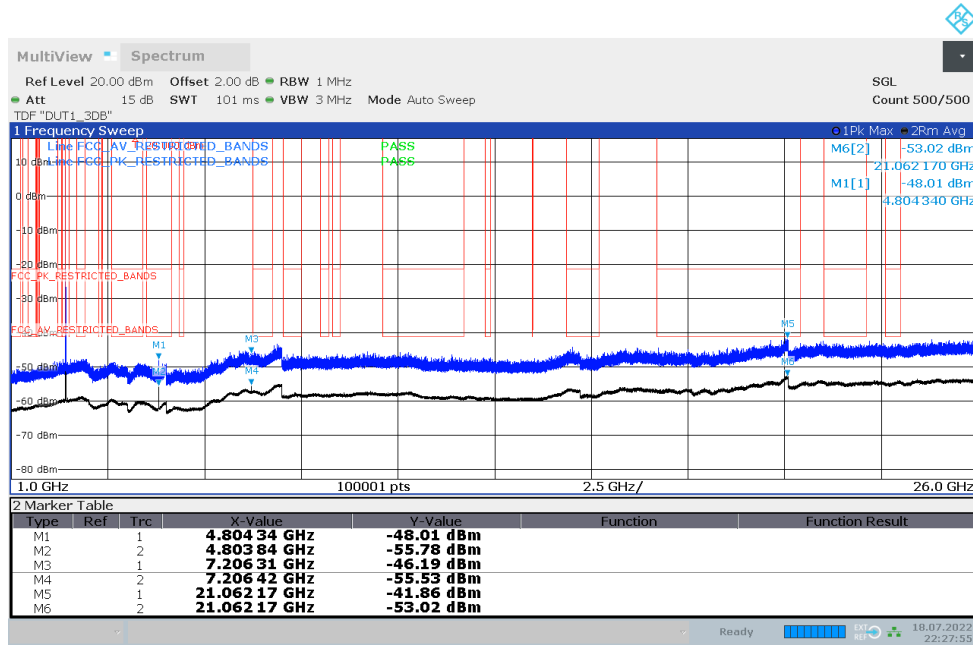

22:27:55 18.07.2022

Radio Technology = Bluetooth EDR 2, Operating Frequency = mid, Measurement range = 1 GHz - 26 GHz (S01\_161\_AD01)

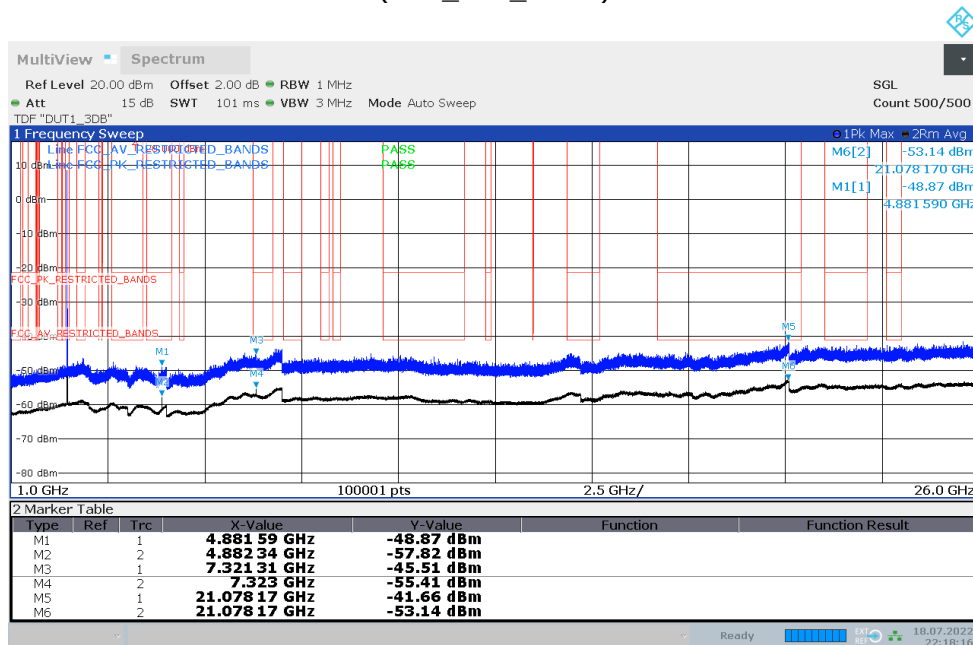

22:18:16 18.07.2022

Radio Technology = Bluetooth EDR 2, Operating Frequency = high, Measurement range = 1 GHz - 26 GHz (S01\_161\_AD01)

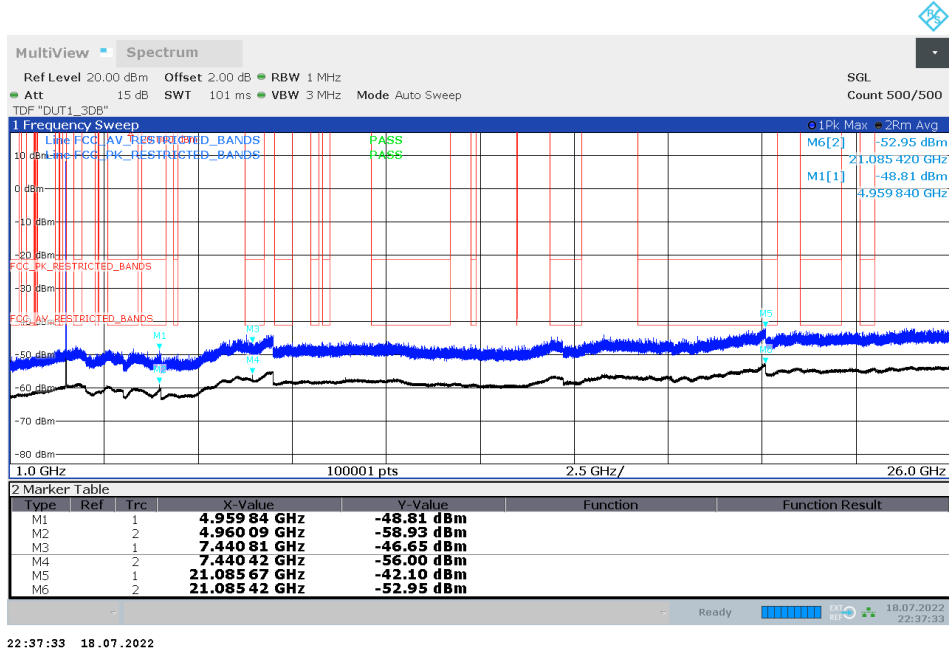

Radio Technology = Bluetooth EDR 3, Operating Frequency = low, Measurement range = 1 GHz - 26 GHz (S01\_161\_AD01)

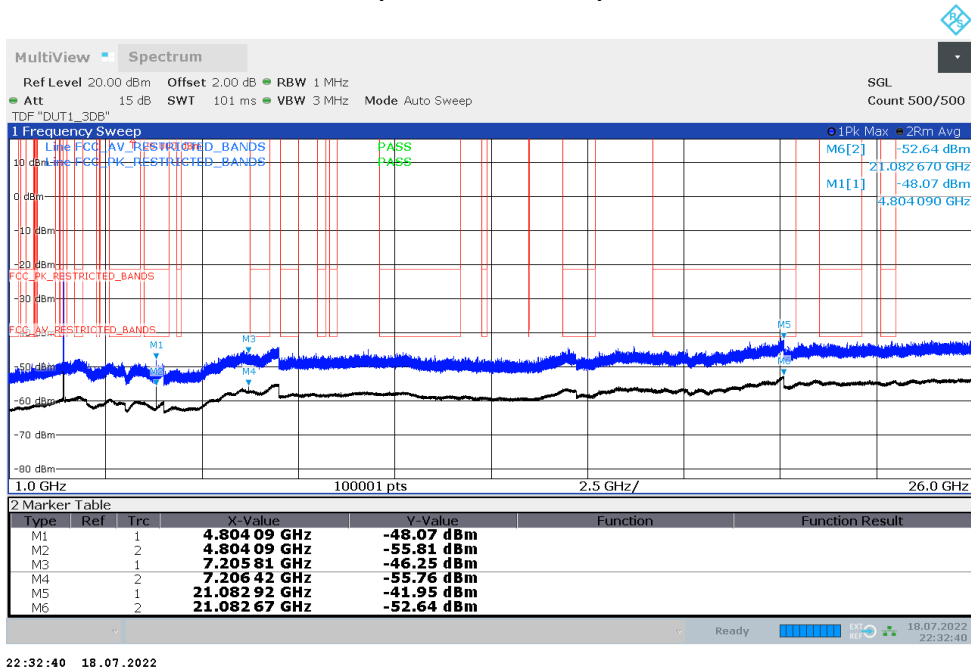



Radio Technology = Bluetooth LE 1 Mbps, Operating Frequency = low, Measurement range = 1 GHz - 26 GHz (S01\_161\_AD01)

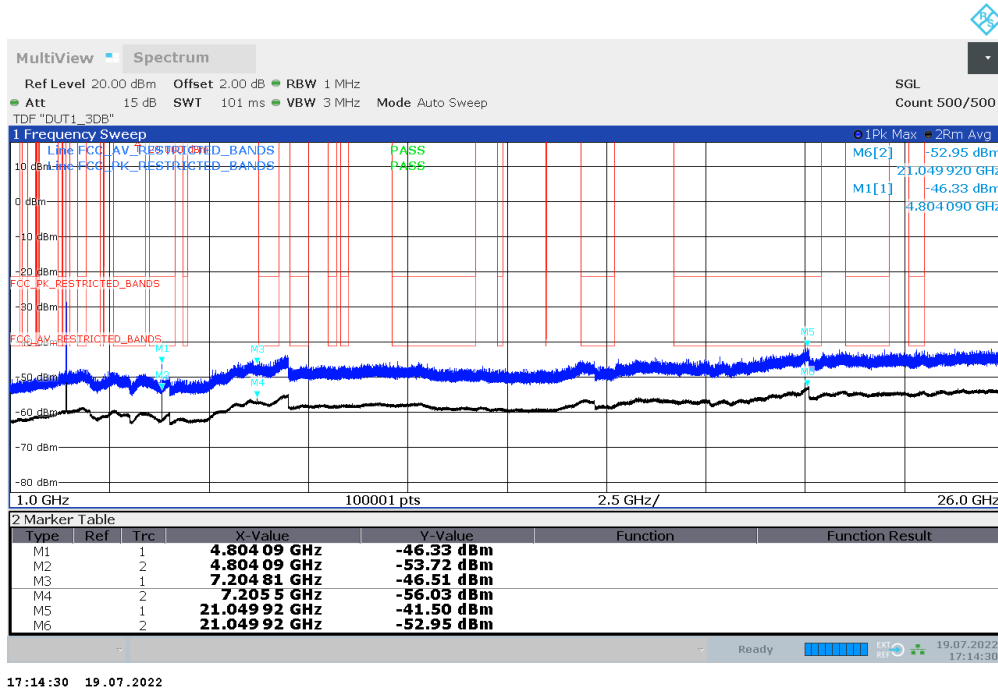

17:14:30 19.07.2022

Radio Technology = Bluetooth LE 1 Mbps, Operating Frequency = mid, Measurement range = 1 GHz - 26 GHz (S01\_161\_AD01)

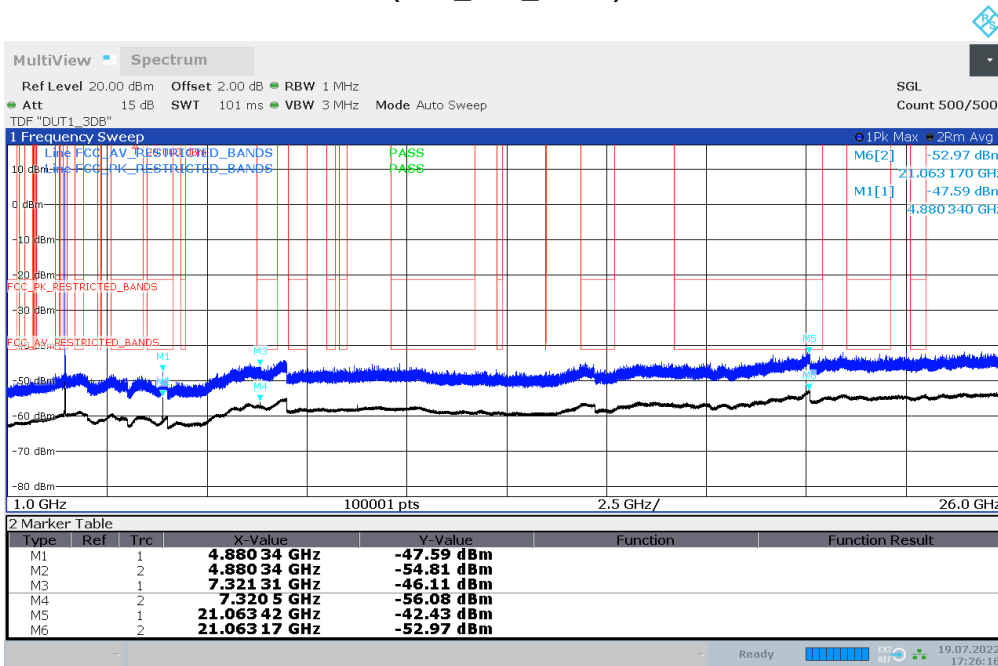

17:26:16 19.07.2022

Radio Technology = Bluetooth LE 1 Mbps, Operating Frequency = high, Measurement range = 1 GHz - 26 GHz (S01\_161\_AD01)

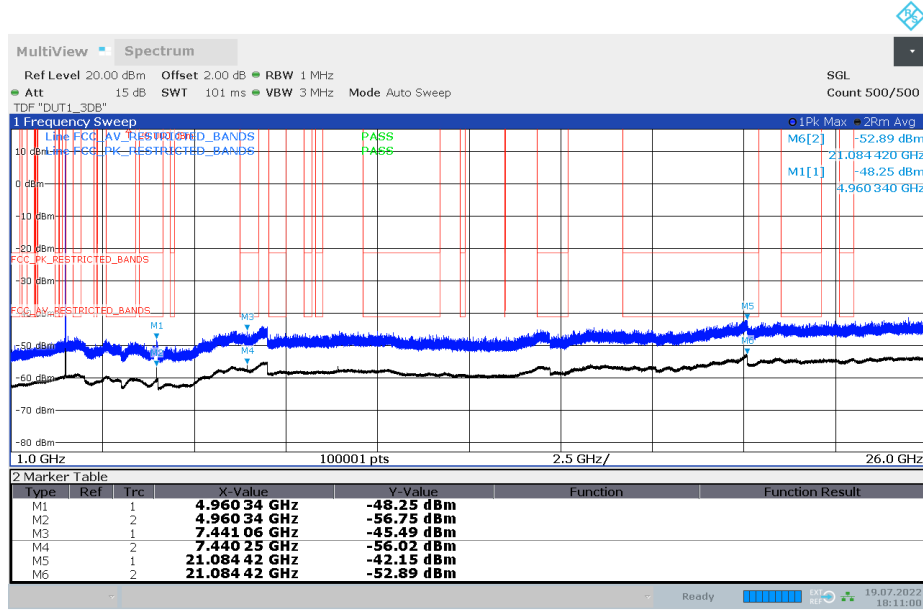

18:11:01 19.07.2022

Radio Technology = Bluetooth LE 2 Mbps, Operating Frequency = low, Measurement range = 1 GHz - 26 GHz (S01\_161\_AD01)

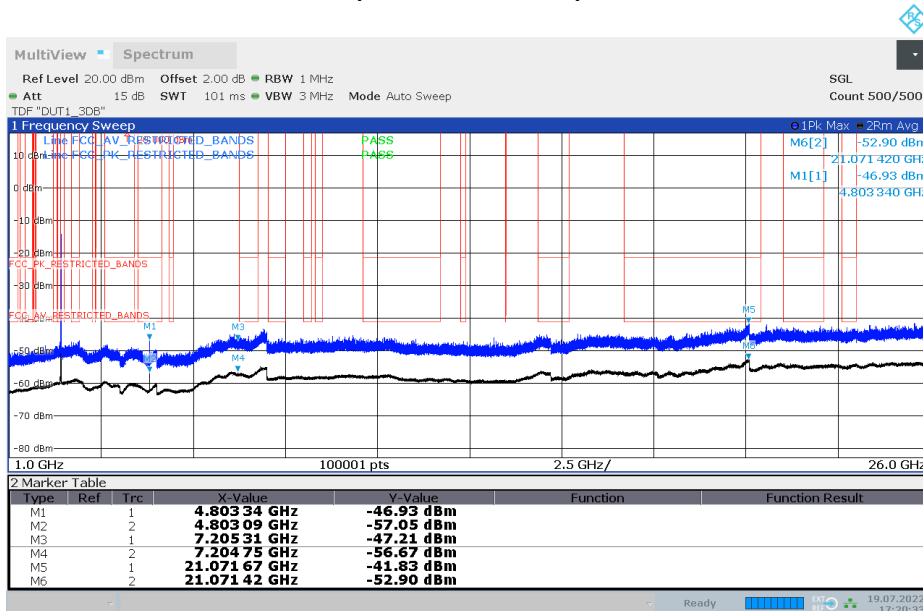

17:20:34 19.07.2022

Radio Technology = Bluetooth LE 2 Mbps, Operating Frequency = mid, Measurement range = 1 GHz - 26 GHz (S01\_161\_AD01)

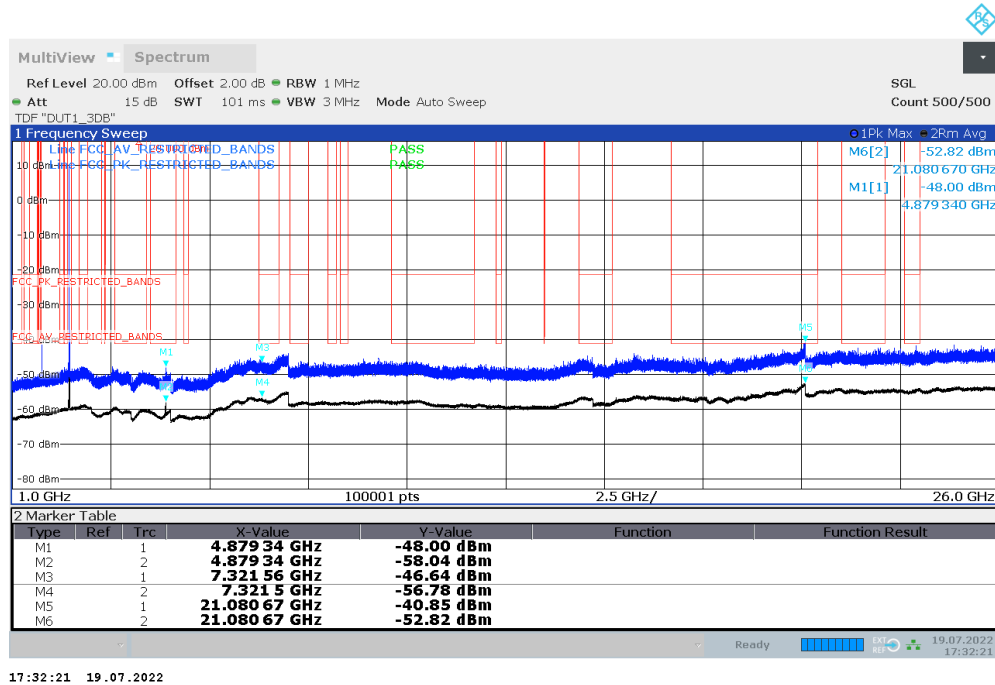

17:32:21 19.07.2022

Radio Technology = Bluetooth LE 2 Mbps, Operating Frequency = high, Measurement range = 1 GHz - 26 GHz (S01\_161\_AD01)

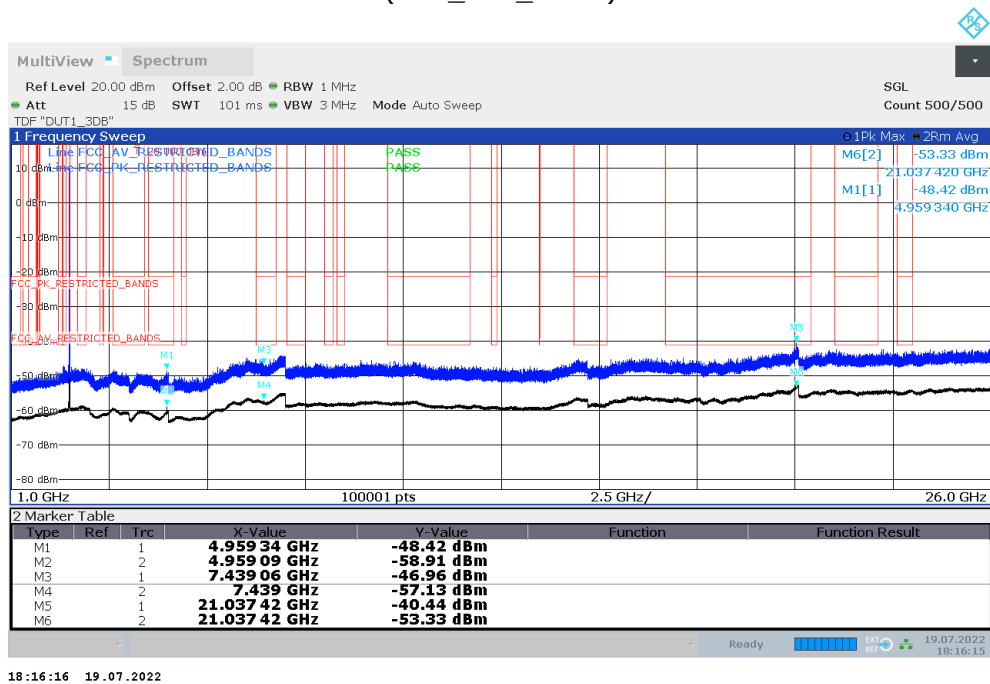

18:16:16 19.07.2022

Radio Technology = WLAN b, Operating Frequency = low, Measurement range = 1 GHz - 26 GHz  
 (S01\_161\_AD01)

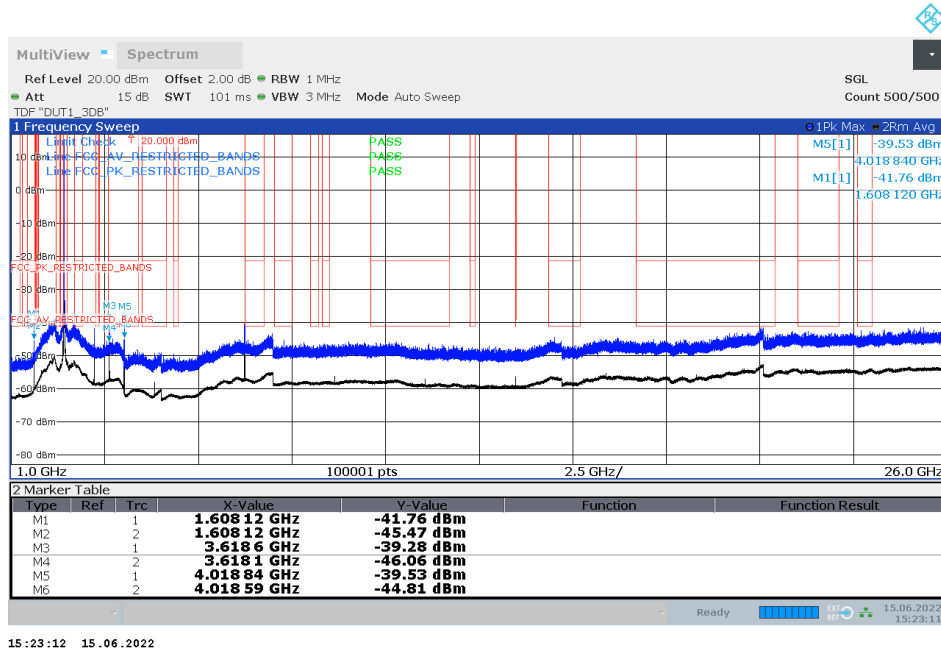

Radio Technology = WLAN b, Operating Frequency = low, Measurement range = 1 GHz - 26 GHz  
 (S02\_161\_AB01)

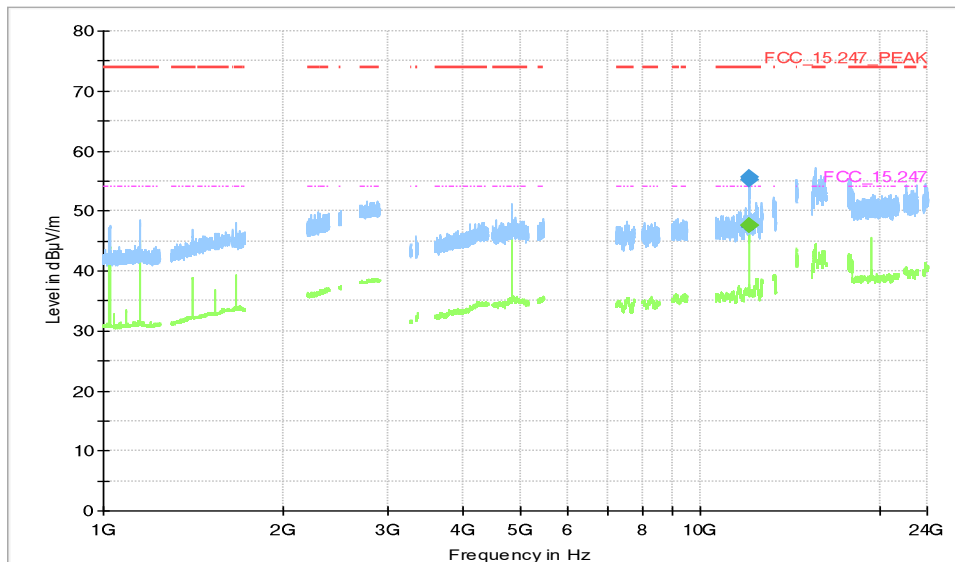

## Final Result

Frequency (MHz)	MaxPeak (dBµV/m)	CAverage (dBµV/m)	Limit (dBµV/m)	Marg in (dB)	Meas. Time (ms)	Bandwidth (kHz)	Height (cm)	Pol	Azimuth (deg)	Elevation (deg)	Cor r. (dB/m)
12060.865	55.2	---	74.0	18.81	1000.0	1000.00	150.	H	52.0	86.0	-7.6
12060.865	---	47.6	54.0	6.40	1000.0	1000.00	150.	H	52.0	86.0	-7.6
12061.810	55.7	---	74.0	18.33	1000.0	1000.00	150.	H	49.0	88.0	-7.6
12061.810	---	47.7	54.0	6.27	1000.0	1000.00	150.	H	49.0	88.0	-7.6



Radio Technology = WLAN b, Operating Frequency = mid, Measurement range = 1 GHz - 26 GHz  
(S01\_161\_AD01)

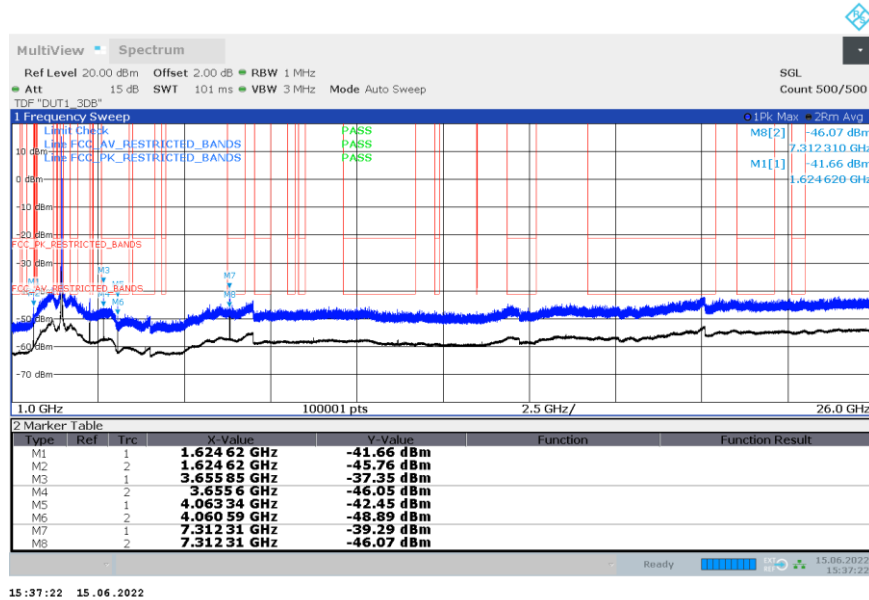

Radio Technology = WLAN b, Operating Frequency = high, Measurement range = 1 GHz - 26 GHz  
(S01\_161\_AD01)

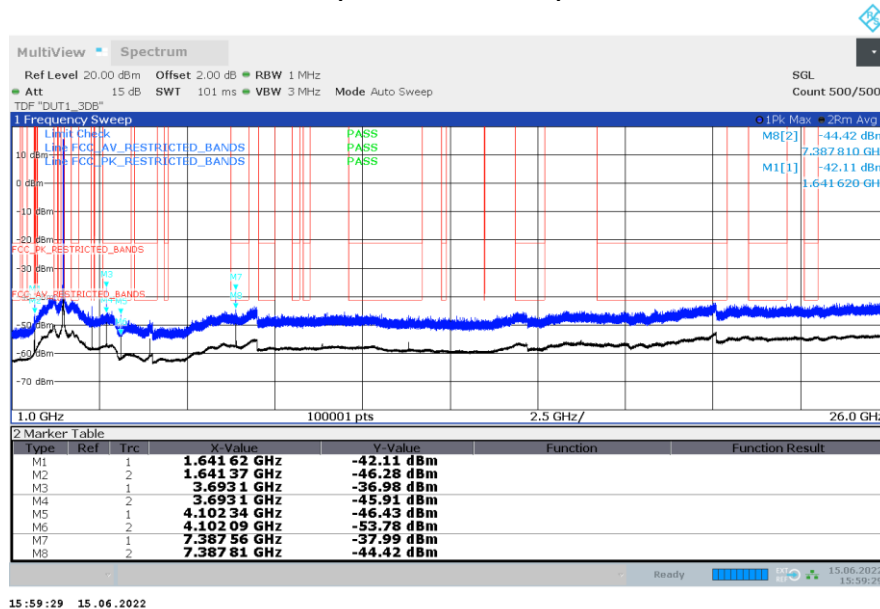

Radio Technology = WLAN b, Operating Frequency = high, Measurement range = 1 GHz - 26 GHz  
(S02\_161\_AB01)

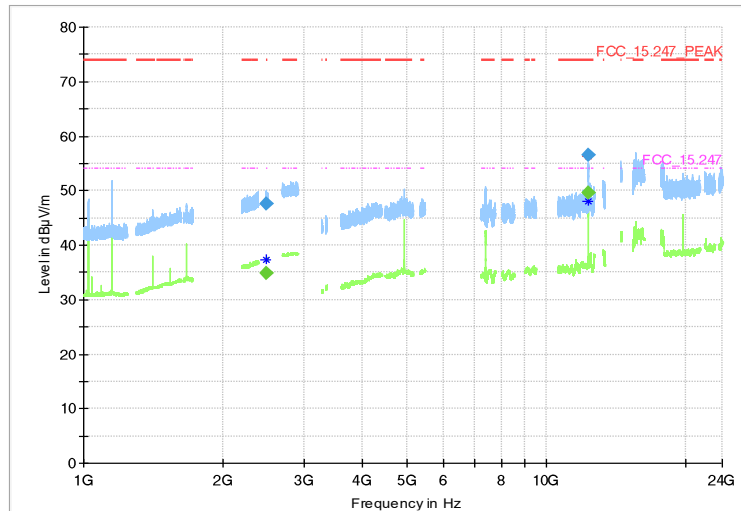

## Final\_Result

Frequency (MHz)	MaxPeak (dBµV/m)	CAverage (dBµV/m)	Limit (dBµV/m)	Marg in (dB)	Meas. Time (ms)	Bandwidth (kHz)	Height (cm)	Pol	Azimuth (deg)	Elevation (deg)	Corr. (dB/m)
2483.995	---	34.8	54.0	19.17	1000.0	1000.00	150.	V	-130.0	-10.0	5.3
2483.995	47.7	---	74.0	26.26	1000.0	1000.00	150.	V	-130.0	-10.0	5.3
12311.185	---	49.5	54.0	4.46	1000.0	1000.00	150.	H	56.0	78.0	-7.0
12311.185	56.6	---	74.0	17.40	1000.0	1000.00	150.	H	56.0	78.0	-7.0

Radio Technology = WLAN g, Operating Frequency = low, Measurement range = 1 GHz - 26 GHz  
 (S01\_161\_AD01)

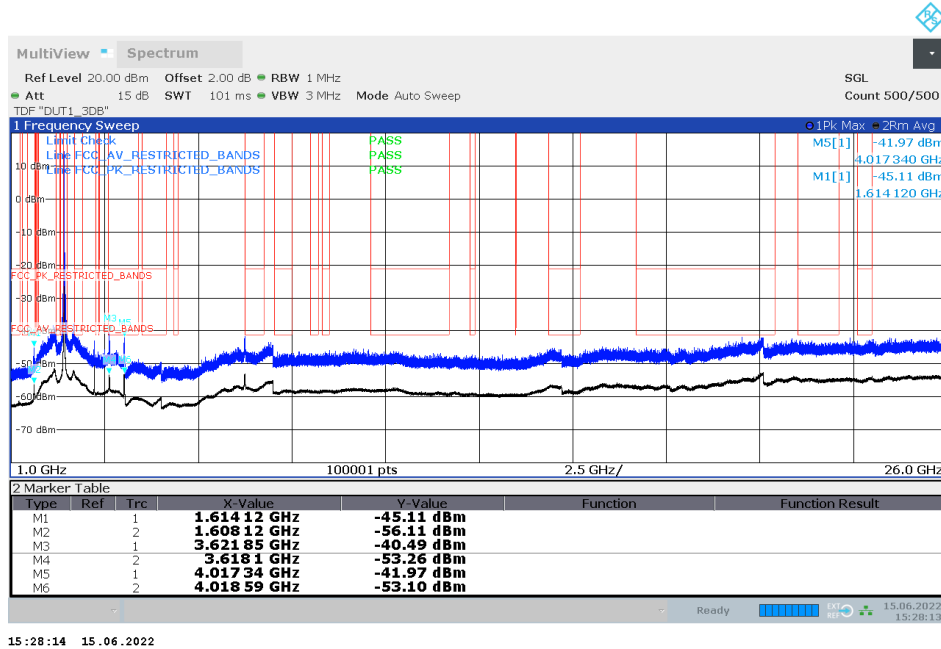

Radio Technology = WLAN g, Operating Frequency = mid, Measurement range = 1 GHz - 26 GHz  
 (S01\_161\_AD01)

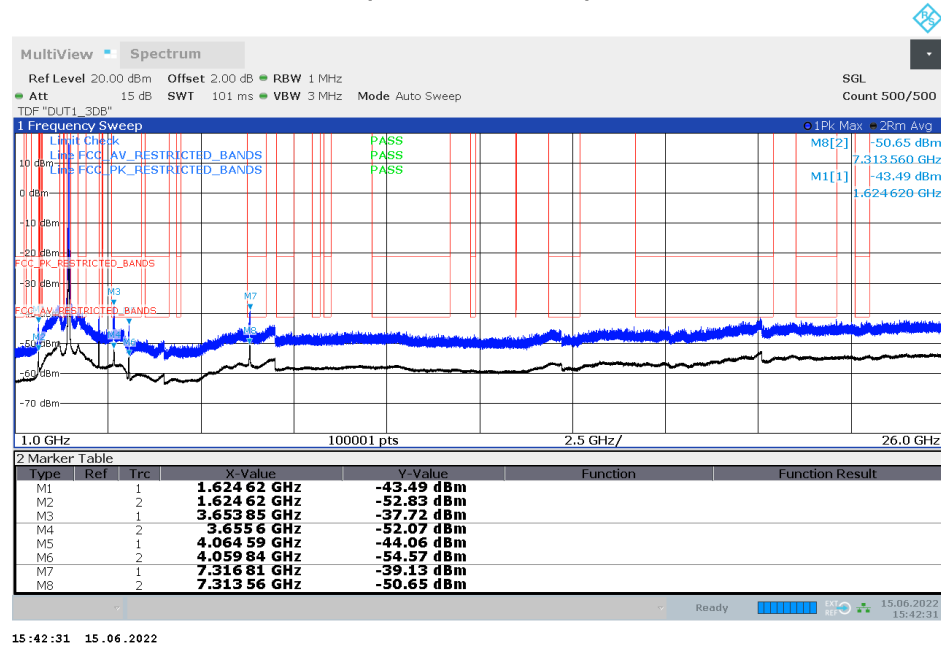

Radio Technology = WLAN n 20 MHz, Operating Frequency = low, Measurement range = 1 GHz - 26 GHz  
(S01\_161\_AD01)

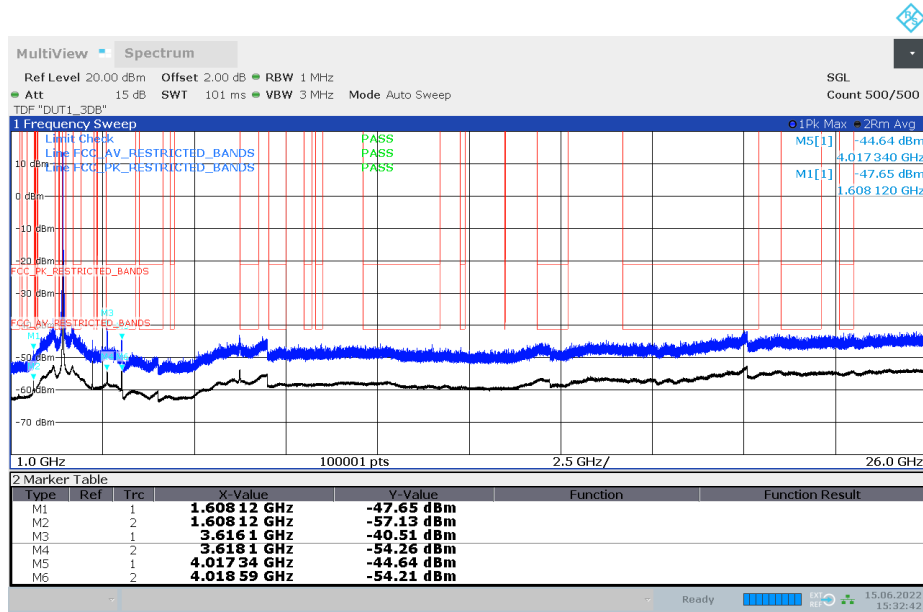

15:32:43 15.06.2022

Radio Technology = WLAN n 20 MHz, Operating Frequency = mid, Measurement range = 1 GHz - 26 GHz  
(S01\_161\_AD01)

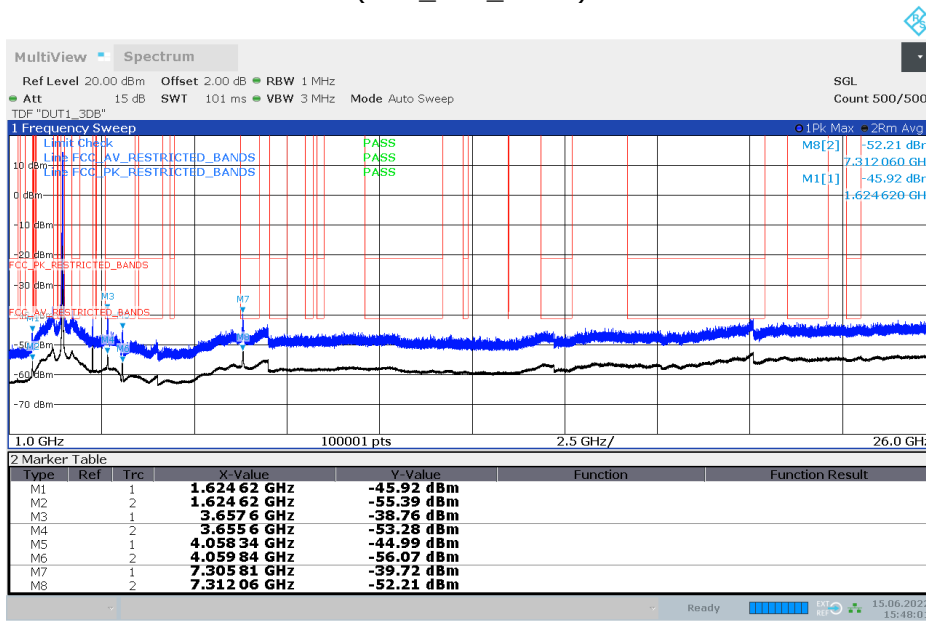

15:48:01 15.06.2022

Radio Technology = WLAN n 40 MHz, Operating Frequency = mid, Measurement range = 1 GHz - 26 GHz (S01\_161\_AD01)

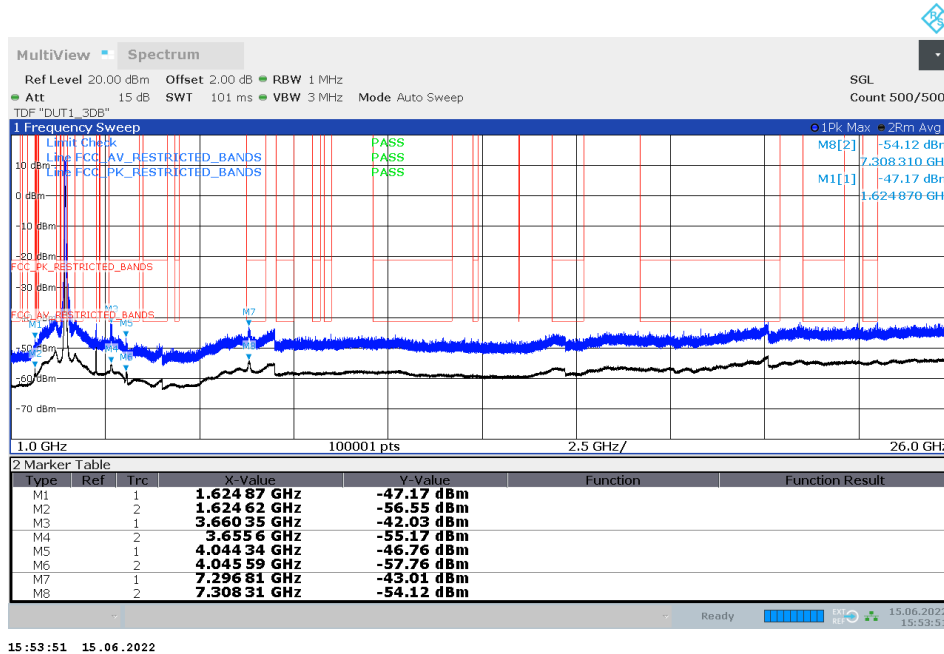

### 5.6.5 TEST EQUIPMENT USED

- Radiated Emissions FAR 2.4 GHz FCC
- Radiated Emissions SAC H-Field
- Radiated Emissions SAC up to 1 GHz
- R&S TS8997

## 5.7 BAND EDGE COMPLIANCE CONDUCTED

Standard **FCC Part 15 Subpart C**

**The test was performed according to:**  
ANSI C63.10 11.11

### 5.7.1 TEST DESCRIPTION

For the conducted measurement, the Equipment Under Test (EUT) is placed in a shielded room. The reference power was measured in the test case "Spurious RF Conducted Emissions".

The EUT was connected to the test system as described in the block diagram below. The complete attenuation of the measurement path is known and considered.

Analyser settings:

- Lower Band Edge:  
Measured range: 2310.0 MHz to 2483.5 MHz  
Upper Band Edge  
Measured range: 2400.0 MHz to 2500 MHz
- Detector: Peak
- Resolution Bandwidth (RBW): 100 kHz
- Video Bandwidth (VBW): 300 kHz
- Sweptime: Auto
- Sweeps: Till stable (min. 300, max. 15000)
- Trace: Maxhold

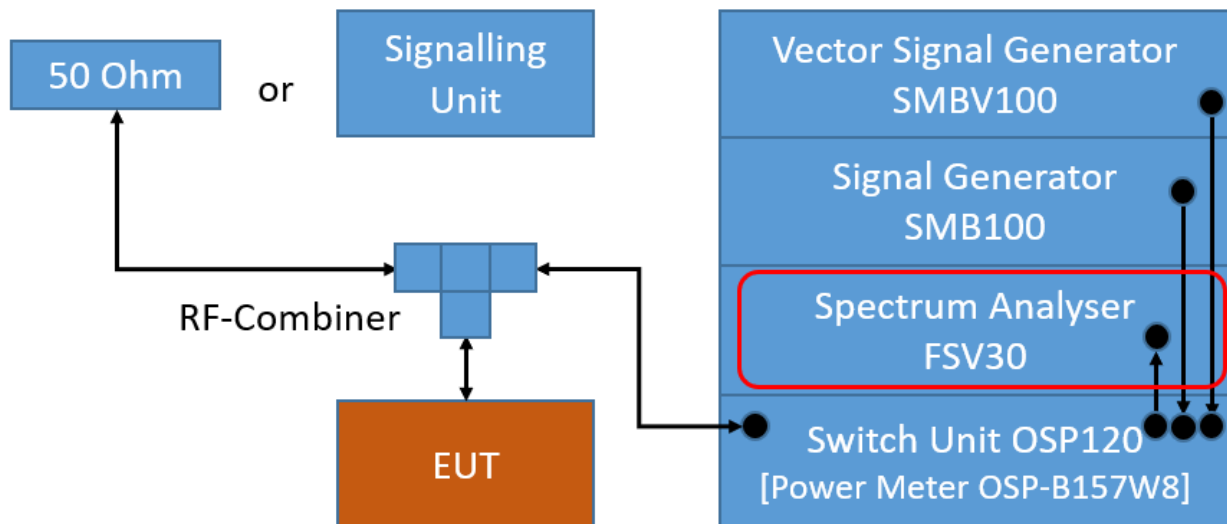

TS8997; Band Edge Conducted

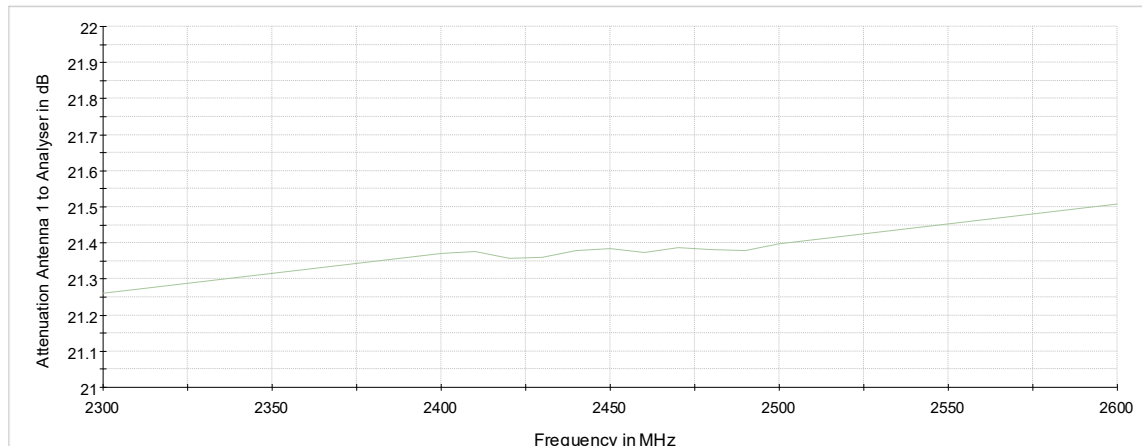

Attenuation of the measurement path

## 5.7.2 TEST REQUIREMENTS / LIMITS

### FCC Part 15.247 (d)

“In any 100 kHz bandwidth outside the frequency band in which the spread spectrum or digitally modulated intentional radiator is operating, the radio frequency power that is produced by the intentional radiator shall be at least 20 dB below that in the 100 kHz bandwidth within the band that contains the highest level of the desired power, based on either an RF conducted or a radiated measurement, provided the transmitter demonstrates compliance with the peak conducted power limits. ...

If the transmitter complies with the conducted power limits based on the use of RMS averaging over a time interval, as permitted under paragraph (b)(3) of this section, the attenuation required under this paragraph shall be 30 dB instead of 20 dB. Attenuation below the general limits specified in Section 15.209(a) is not required. In addition, radiated emissions which fall in the restricted bands, as defined in Section 15.205(a), must also comply with the radiated emission limits specified in Section 15.209(a) (see Section 15.205(c)).”

For the conducted measurement the RF power at the band edge shall be “at least 20 dB below that in the 100 kHz bandwidth within the band that contains the highest level of the desired power...”

### 5.7.3 TEST PROTOCOL

Ambient temperature: 23-25 °C  
 Air Pressure: 990-1024 hPa  
 Humidity: 30-40%  
 BT GFSK (1-DH1)

Channel No.	Channel Center Frequency [MHz]	Band Edge Freq. [MHz]	Spurious Level [dBm]	Detector	RBW [kHz]	Ref. Level [dBm]	Limit [dBm]	Margin to Limit [dB]
0	2402	2400.0	-48.2	PEAK	100	7.2	-12.8	35.4
78	2480	2483.5	-45.1	PEAK	100	6.8	-13.2	31.9

BT π/4 DQPSK (2-DH1)

Channel No.	Channel Center Frequency [MHz]	Band Edge Freq. [MHz]	Spurious Level [dBm]	Detector	RBW [kHz]	Ref. Level [dBm]	Limit [dBm]	Margin to Limit [dB]
0	2402	2400.0	-44.9	PEAK	100	3.8	-16.2	28.7
78	2480	2483.5	-45.6	PEAK	100	3.9	-16.1	29.5

BT 8-DPSK (3-DH1)

Channel No.	Channel Center Frequency [MHz]	Band Edge Freq. [MHz]	Spurious Level [dBm]	Detector	RBW [kHz]	Ref. Level [dBm]	Limit [dBm]	Margin to Limit [dB]
0	2402	2400.0	-43.0	PEAK	100	4.2	-15.8	27.2
78	2480	2483.5	-45.7	PEAK	100	3.9	-16.1	29.6

BT LE 1 Mbit/s

Channel No.	Channel Center Frequency [MHz]	Band Edge Freq. [MHz]	Spurious Level [dBm]	Detector	RBW [kHz]	Ref. Level [dBm]	Limit [dBm]	Margin to Limit [dB]
0	2402	2400.0	-47.5	PEAK	100	7.5	-12.5	35.0
39	2480	2483.5	-51.3	PEAK	100	7.2	-12.8	38.5

BT LE 2 Mbit/s

Channel No.	Channel Center Frequency [MHz]	Band Edge Freq. [MHz]	Spurious Level [dBm]	Detector	RBW [kHz]	Ref. Level [dBm]	Limit [dBm]	Margin to Limit [dB]
0	2402	2400.0	-22.4	PEAK	100	7.5	-12.5	9.9
39	2480	2483.5	-50.0	PEAK	100	7.1	-12.9	37.1

WLAN b-Mode; 20 MHz; 1 Mbit/s

Channel No.	Channel Center Frequency [MHz]	Band Edge Freq. [MHz]	Spurious Level [dBm]	Detector	RBW [kHz]	Ref. Level [dBm]	Limit [dBm]	Margin to Limit [dB]
1	2412	2400.0	-37.4	PEAK	100	9.0	-21.0	16.4
11	2462	2483.5	-45.2	PEAK	100	8.9	-21.1	24.1

WLAN g-Mode; 20 MHz; 6 Mbit/s

Channel No.	Channel Center Frequency [MHz]	Band Edge Freq. [MHz]	Spurious Level [dBm]	Detector	RBW [kHz]	Ref. Level [dBm]	Limit [dBm]	Margin to Limit [dB]
1	2412	2400.0	-31.9	PEAK	100	5.1	-24.9	7.0
11	2462	2483.5	-41.3	PEAK	100	5.1	-24.9	16.4



WLAN n-Mode; 20 MHz; MCS0

Channel No.	Channel Center Frequency [MHz]	Band Edge Freq. [MHz]	Spurious Level [dBm]	Detector	RBW [kHz]	Ref. Level [dBm]	Limit [dBm]	Margin to Limit [dB]
1	2412	2400.0	-33.3	PEAK	100	4.1	-25.9	7.4
11	2462	2483.5	-40.7	PEAK	100	4.1	-25.9	14.8

WLAN n-Mode; 40 MHz; MCS0

Channel No.	Channel Center Frequency [MHz]	Band Edge Freq. [MHz]	Spurious Level [dBm]	Detector	RBW [kHz]	Ref. Level [dBm]	Limit [dBm]	Margin to Limit [dB]
3	2422	2400.0	-35.1	PEAK	100	0.5	-29.5	5.6
9	2452	2483.5	-37.3	PEAK	100	1.5	-28.5	8.8

Remark: Please see next sub-clause for the measurement plot.

### 5.7.4 MEASUREMENT PLOTS

Radio Technology = Bluetooth BDR, Operating Frequency = low, Band Edge = low (S01\_161\_AD01)

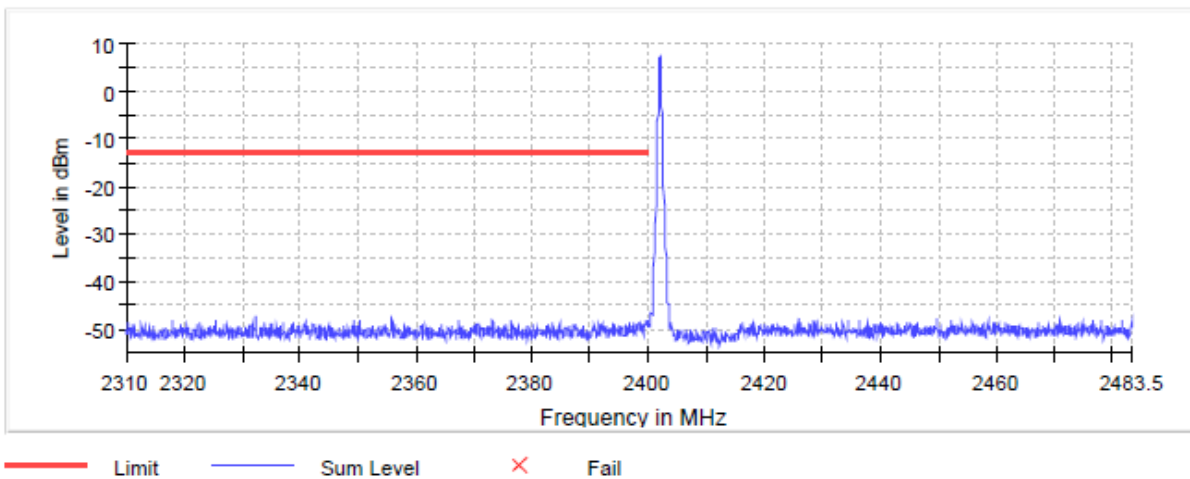

Radio Technology = Bluetooth BDR, Operating Frequency = high, Band Edge = high  
(S01\_161\_AD01)

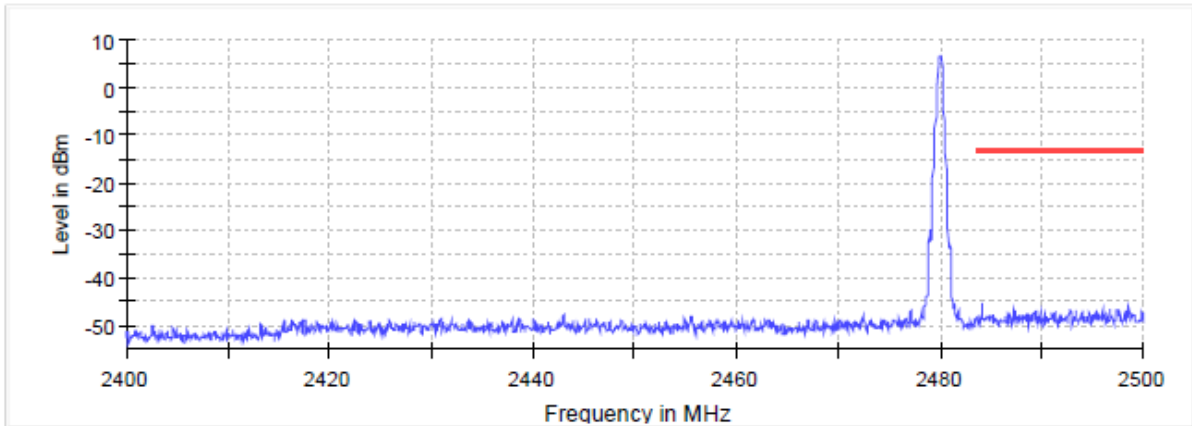

— Limit    — Sum Level    × Fail

Radio Technology = Bluetooth EDR 2, Operating Frequency = low, Band Edge = low  
(S01\_161\_AD01)

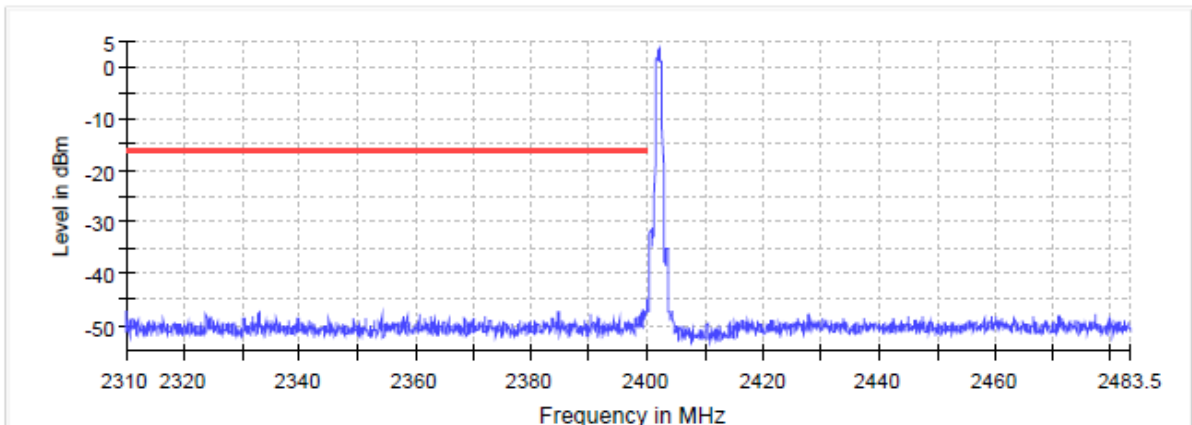

— Limit    — Sum Level    × Fail

Radio Technology = Bluetooth EDR 2, Operating Frequency = high, Band Edge = high  
(S01\_161\_AD01)

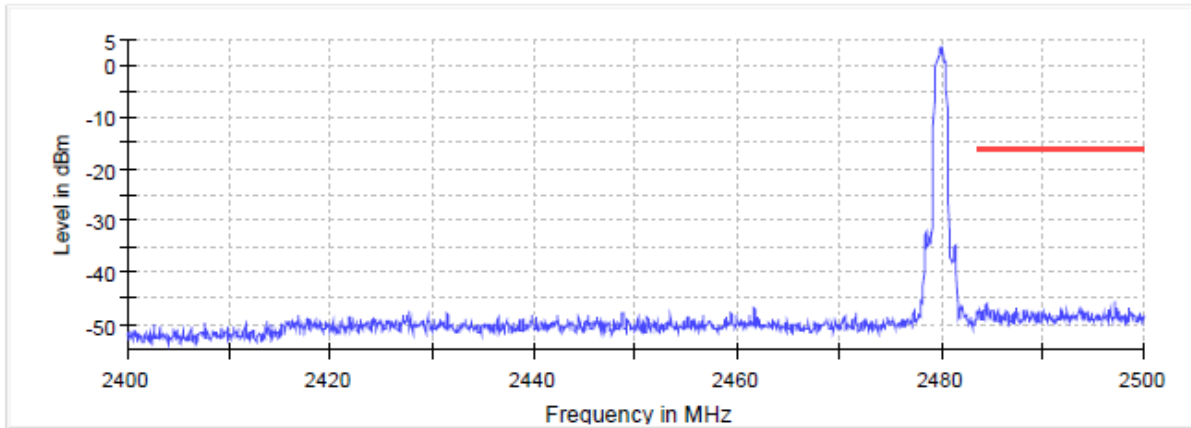

— Limit    — Sum Level    × Fail

Radio Technology = Bluetooth EDR 3, Operating Frequency = low, Band Edge = low  
(S01\_161\_AD01)

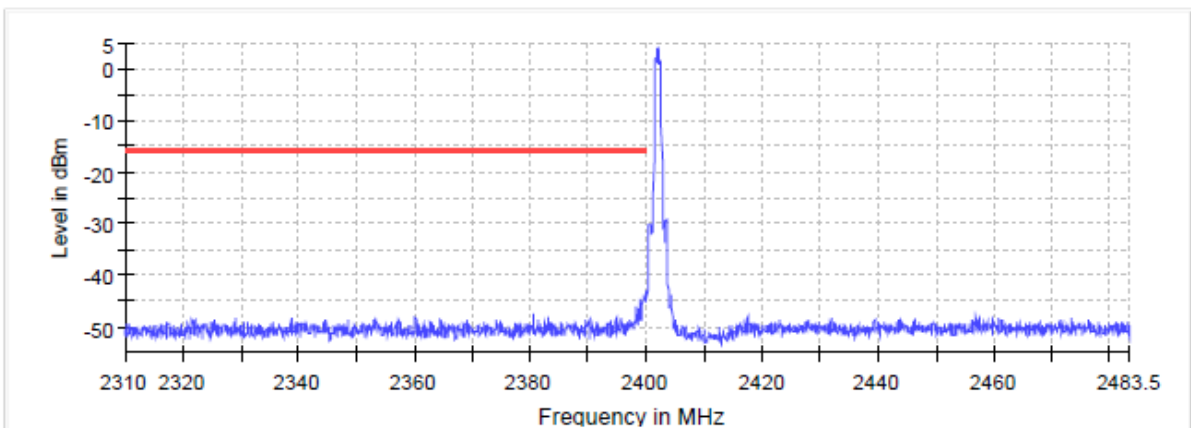

— Limit    — Sum Level    × Fail

Radio Technology = Bluetooth EDR 3, Operating Frequency = high, Band Edge = high  
(S01\_161\_AD01)

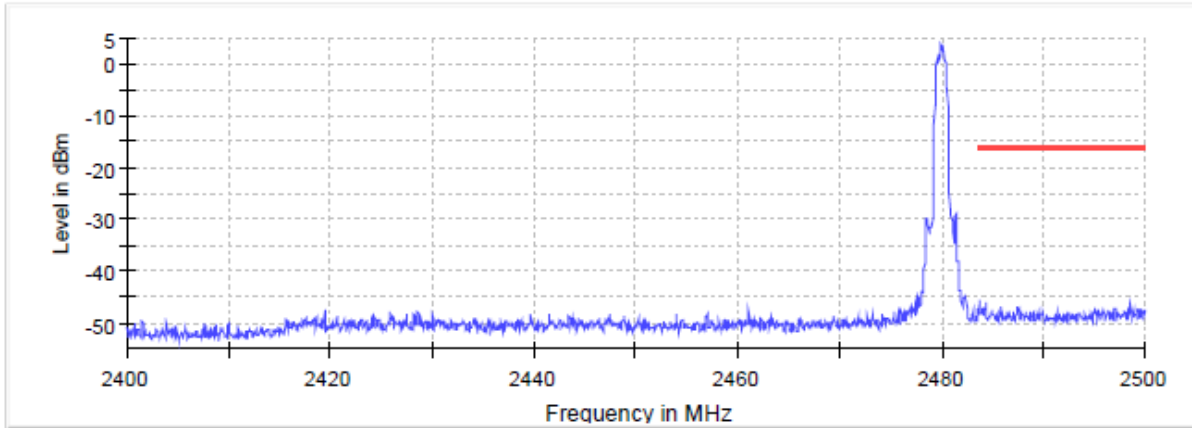

— Limit    — Sum Level    × Fail

Radio Technology = Bluetooth LE 1 Mbps, Operating Frequency = low, Band Edge = low  
(S01\_161\_AD01)

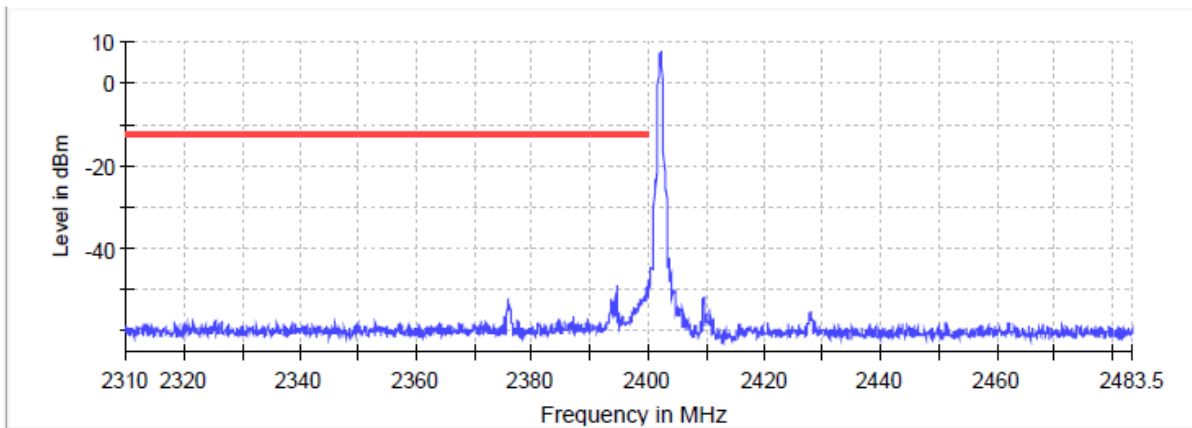

— Limit    — Sum Level    × Fail

Radio Technology = Bluetooth LE 1 Mbps, Operating Frequency = high, Band Edge = high  
(S01\_161\_AD01)

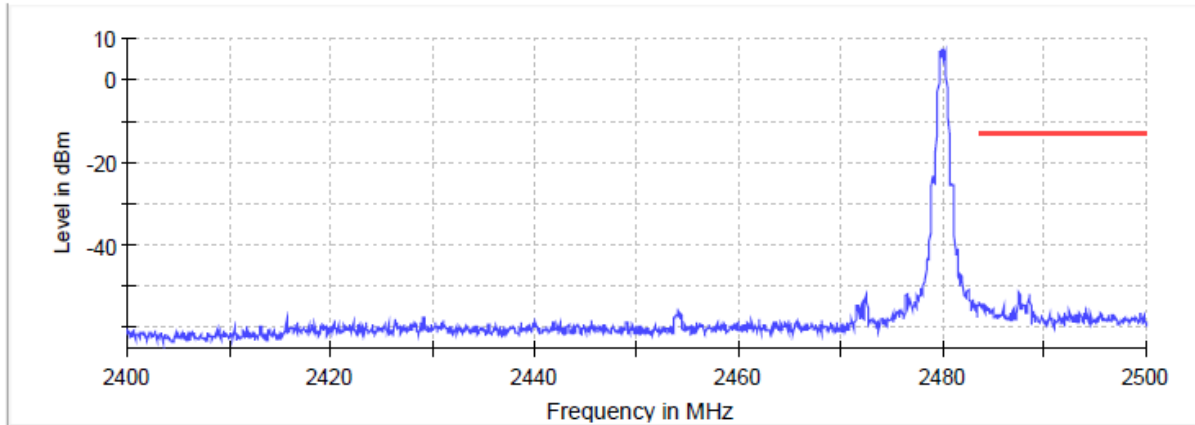

— Limit    — Sum Level    × Fail

Radio Technology = Bluetooth LE 2 Mbps, Operating Frequency = low, Band Edge = low  
(S01\_161\_AD01)

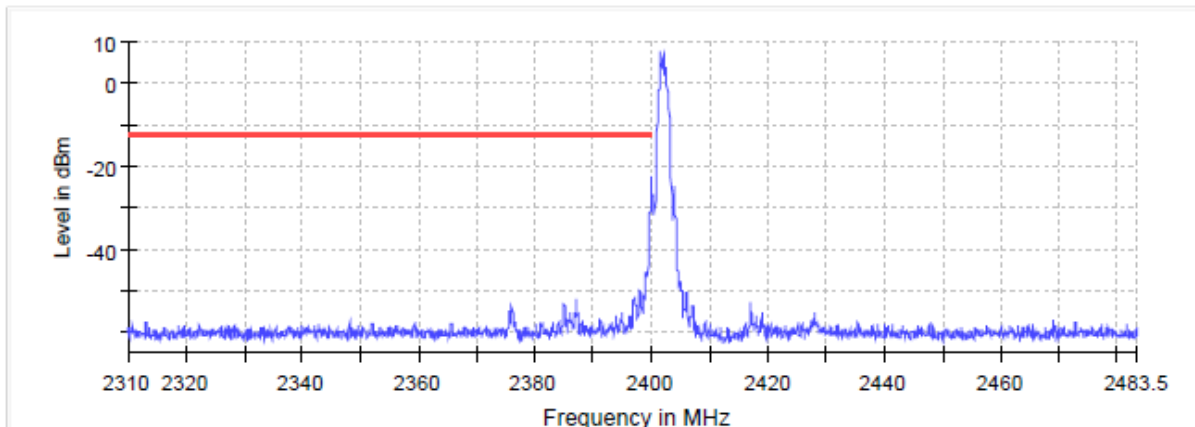

— Limit    — Sum Level    × Fail

Radio Technology = Bluetooth LE 2 Mbps, Operating Frequency = high, Band Edge = high  
(S01\_161\_AD01)

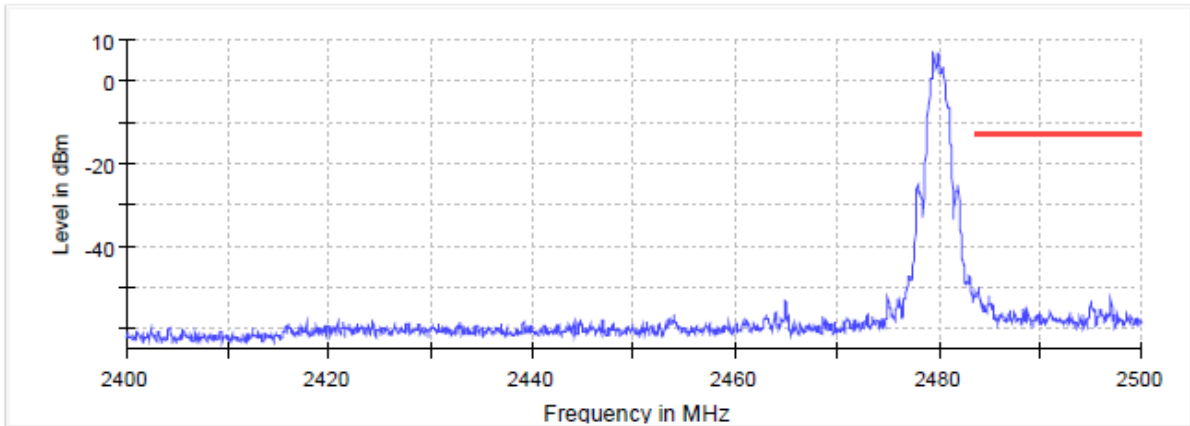

— Limit    — Sum Level    × Fail

Radio Technology = WLAN b, Operating Frequency = low, Band Edge = low  
(S01\_161\_AC01)

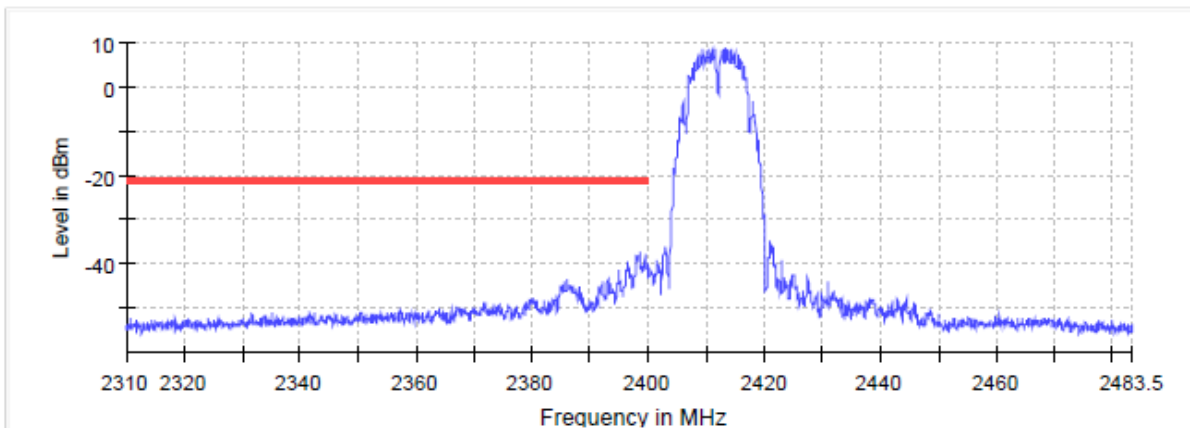

— Limit    — Sum Level    × Fail

Radio Technology = WLAN b, Operating Frequency = high, Band Edge = high  
(S01\_161\_AC01)

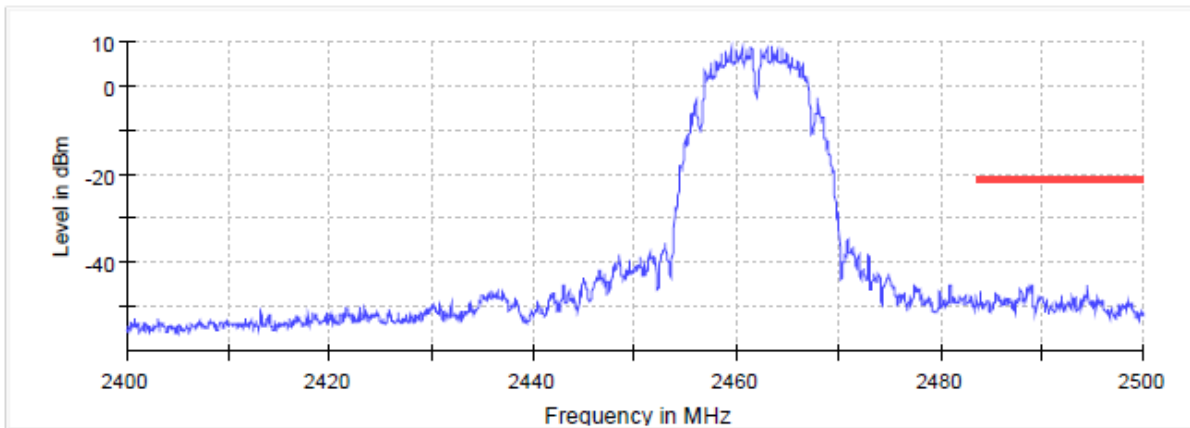

— Limit    — Sum Level    × Fail

Radio Technology = WLAN g, Operating Frequency = low, Band Edge = low  
(S01\_161\_AC01)

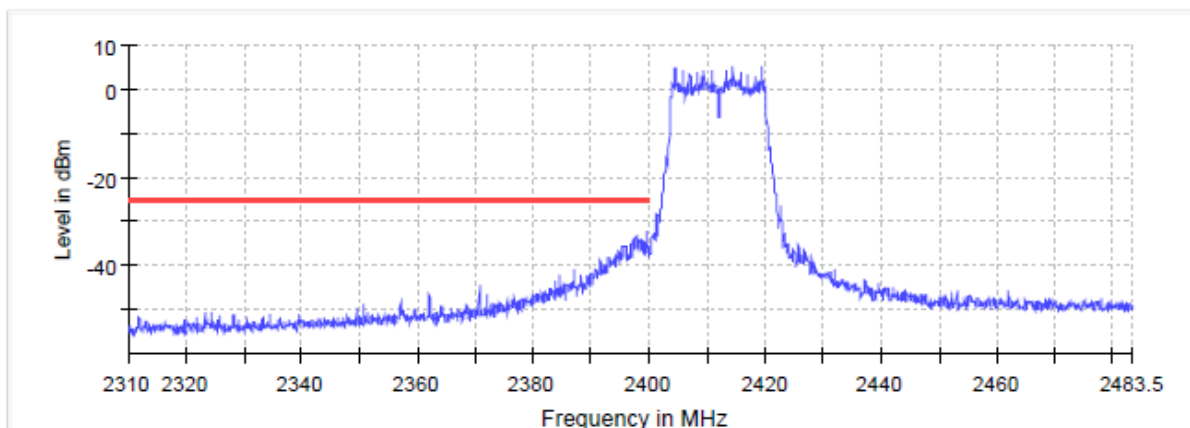

— Limit    — Sum Level    × Fail

Radio Technology = WLAN g, Operating Frequency = high, Band Edge = high  
(S01\_161\_AC01)

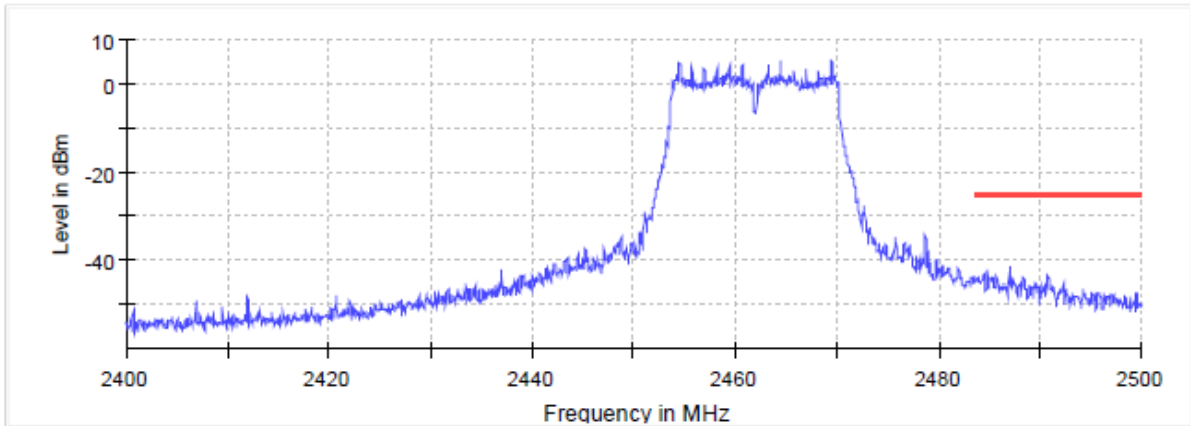

— Limit    — Sum Level    × Fail

Radio Technology = WLAN n 20 MHz, Operating Frequency = low, Band Edge = low  
(S01\_161\_AC01)

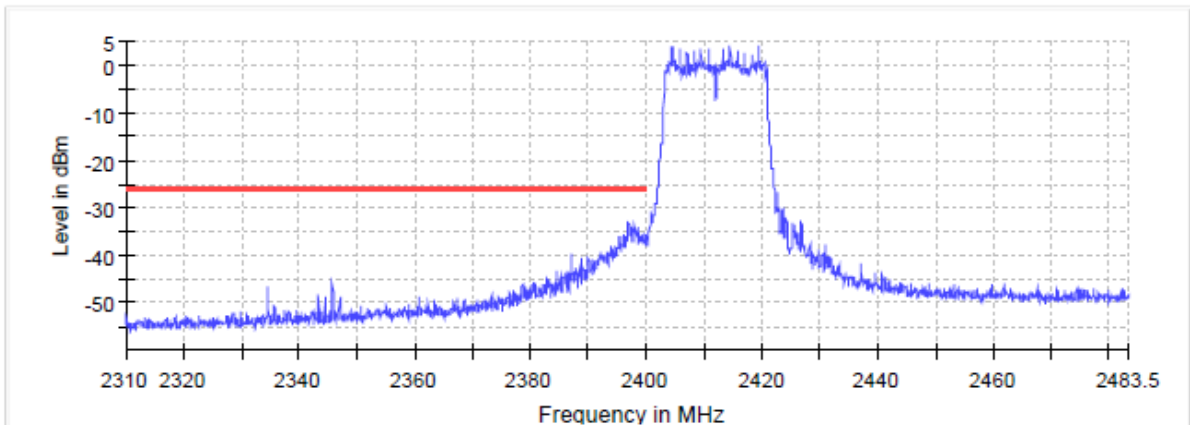

— Limit    — Sum Level    × Fail



Radio Technology = WLAN n 20 MHz, Operating Frequency = high, Band Edge = high  
(S01\_161\_AC01)

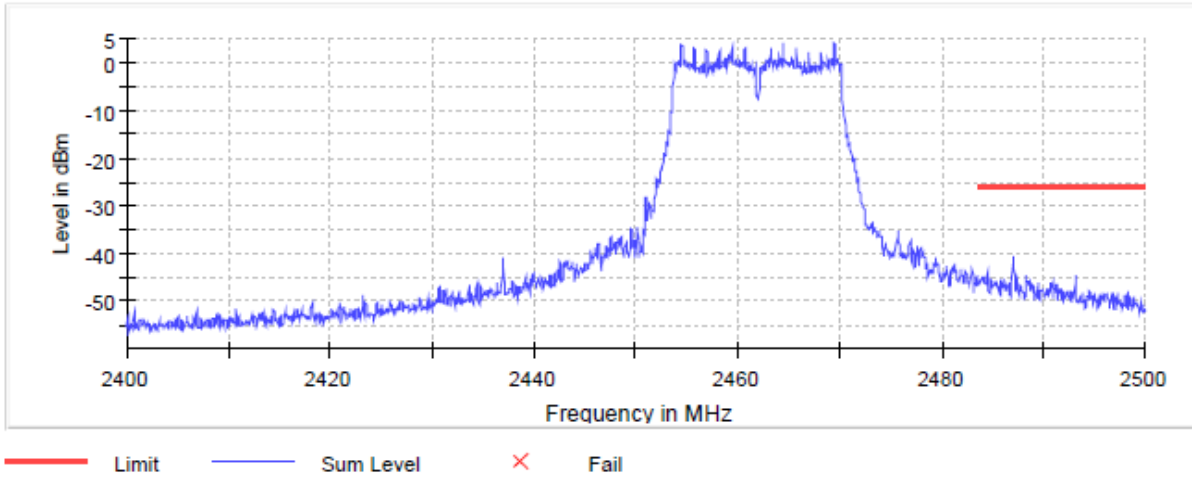

Radio Technology = WLAN n 40 MHz, Operating Frequency = low, Band Edge = low  
(S01\_161\_AC01)

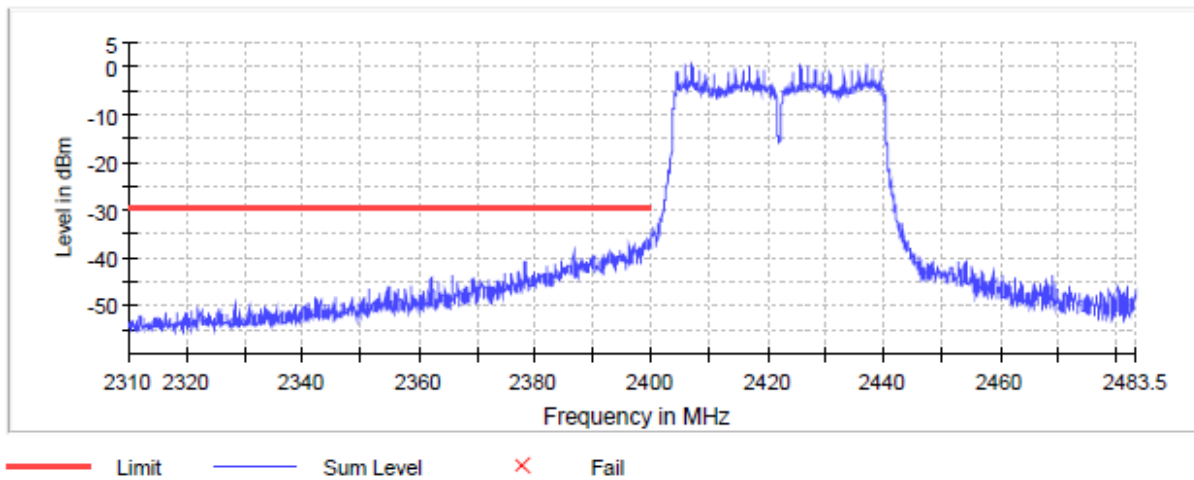

Radio Technology = WLAN n 40 MHz, Operating Frequency = high, Band Edge = high  
(S01\_161\_AC01)

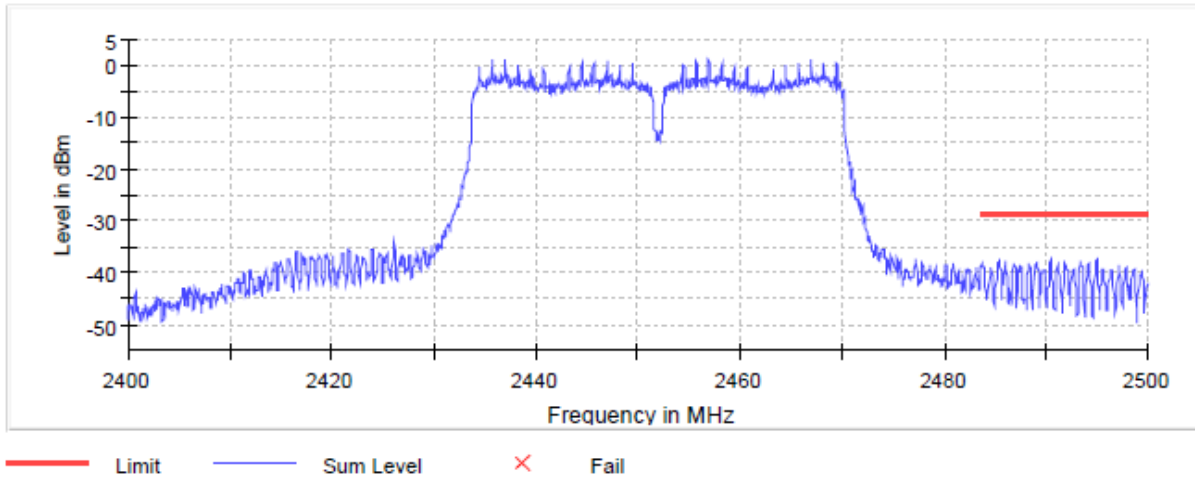

### 5.7.5 TEST EQUIPMENT USED

- R&S TS8997

## 5.8 BAND EDGE COMPLIANCE RADIATED

Standard **FCC Part 15 Subpart C**

**The test was performed according to:**  
ANSI C63.10

### 5.8.1 TEST DESCRIPTION

#### Radiated Measurement with 50 Ohm termination at antenna ports

The test set-up was made in accordance to the general provisions of ANSI C63.10 in a typical installation configuration. The measurements were performed according the following sub-chapter of ANSI C63.10:

- Chapter 6.10.5

The Equipment Under Test (EUT) was set up on a non-conductive support (tilt device) at 1.5 m height in the fully-anechoic chamber.

All steps were performed with one height (1.5 m) of the receiving antenna only (procedure according ANSI C63.10, chapter 6.6.5).

#### 3. Measurement above 1 GHz

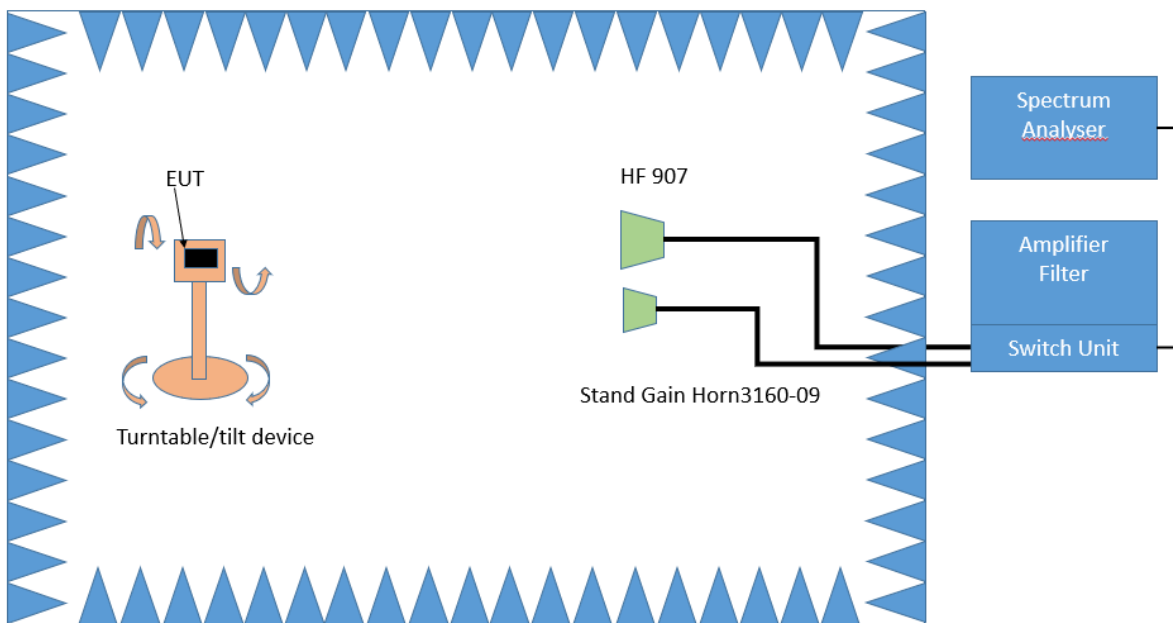

Test Setup; Spurious Emission Radiated (FAC), 1 GHz-26.5 GHz

#### Step 1:

The EUT is turned during the preliminary measurement across the elevation axis, with a step size of 90 °.

The turn table step size (azimuth angle) for the preliminary measurement is 45 °.

Spectrum analyser settings:

- Detector: Peak, Average
- RBW = 1 MHz
- VBW = 3 MHz

#### Step 2:

The turn table azimuth will slowly vary by  $\pm 22.5^\circ$ .  
 The elevation angle will slowly vary by  $\pm 45^\circ$   
 Spectrum analyser settings:  
 - Detector: Peak

**Step 3:**

Spectrum analyser settings for step 3:  
 - Detector: Peak / CISPR Average  
 - Measured frequencies: in step 1 determined frequencies  
 - RBW = 1 MHz  
 - VBW = 3 MHz  
 - Measuring time: 1 s

**Conducted Measurements at antenna ports**

The Equipment Under Test (EUT) was set up to perform the spurious emissions measurements.

The EUT was connected to the test system as described in the block diagram below. The complete attenuation of the measurement path is known and considered.

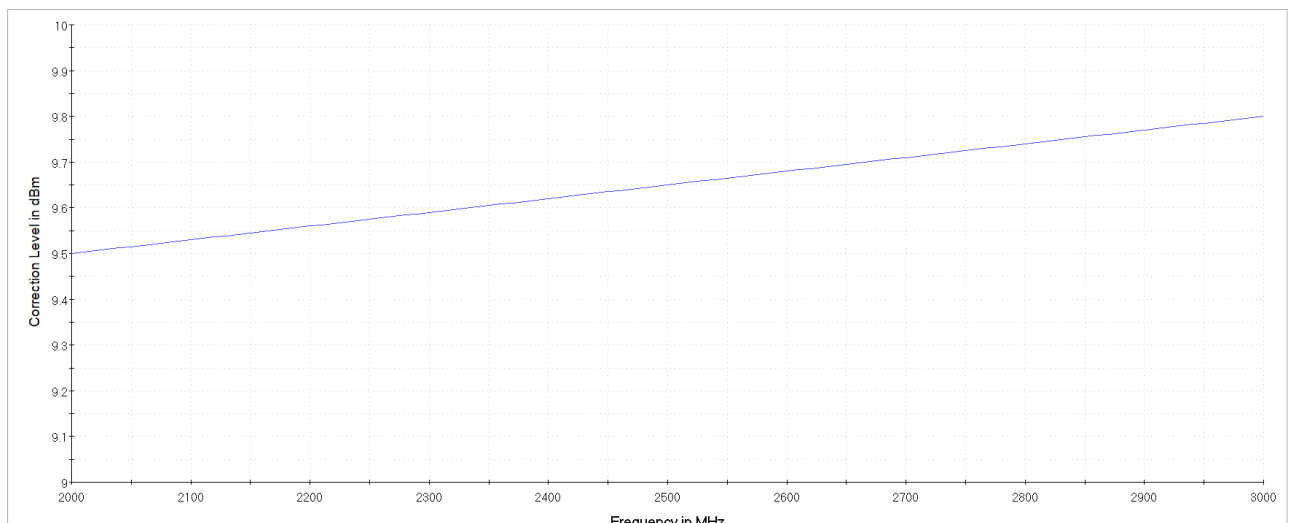
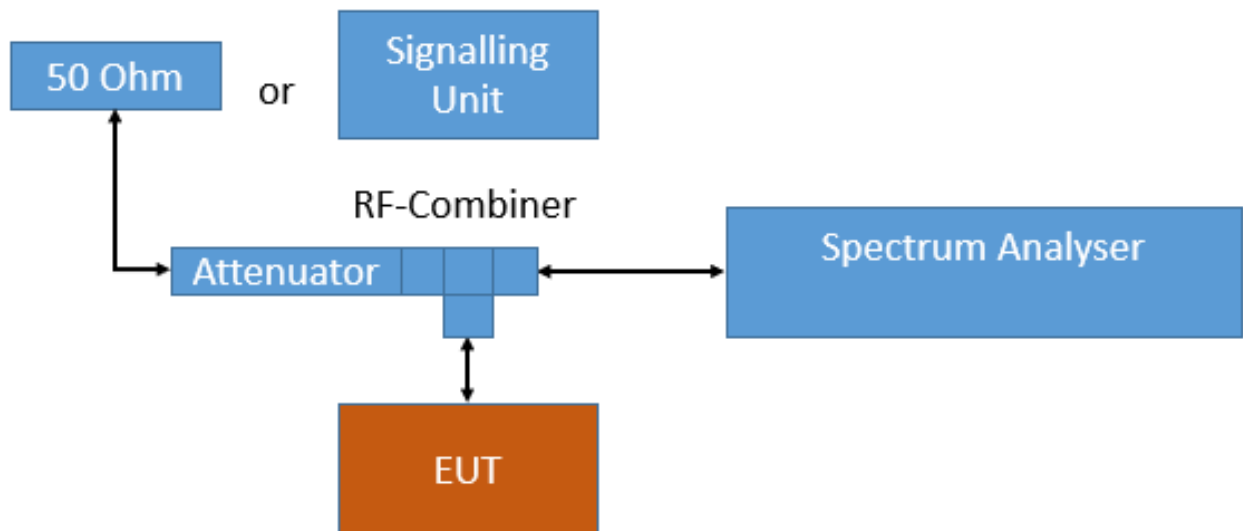

Analyser settings:

- Frequency range: 2350 – 2500 MHz
- Resolution Bandwidth (RBW): 1000 kHz
- Video Bandwidth (VBW): 3000 kHz
- Trace: Maxhold, Average Power
- Sweeps: 10000
- Sweep Time: coupled
- Detector: Peak, RMS

For the conducted emissions in restricted bands the Value is measured in dBm and then converted to dB $\mu$ V/m as given in KDB 558074:

1. Measure the conducted output power in dBm.
2. Add the maximum antenna gain in dBi. (Included in measurement result by offset)
3. Add the appropriate ground reflection factor (0 for measured range)
  - 6 dB for frequencies  $\leq$  30 MHz;
  - 4.7 dB for frequencies between 30 MHz and 1000 MHz, inclusive; and
  - 0 dB for frequencies  $>$  1000 MHz).
4. Convert the resultant EIRP level to an equivalent electric field strength level using the following relationship:  
$$E = \text{EIRP} - 20 \log D + 104.8$$
Where E is the electric field strength in dB $\mu$ V/m,  
EIRP is the equivalent isotropically radiated power in dBm  
D is the specified measurement distance in m

Value [dB $\mu$ V/m] = Measured value [dBm] (including gain and ground reflection factor) – 20 log D + 104.8

## 5.8.2 TEST REQUIREMENTS / LIMITS

For band edges connected to a restricted band, the limits are specified in Section 15.209(a)

FCC Part 15, Subpart C, §15.209, Radiated Emission Limits

Frequency in MHz	Limit ( $\mu\text{V}/\text{m}$ )	Measurement distance (m)	Limits ( $\text{dB}\mu\text{V}/\text{m}$ )
0.009 – 0.49	2400/F(kHz)@300m	3	(48.5 – 13.8)@300m
0.49 – 1.705	24000/F(kHz)@30m	3	(33.8 – 23.0)@30m
1.705 – 30	30@30m	3	29.5@30m

The measured values are corrected with an inverse linear distance extrapolation factor (40 dB/decade) according FCC 15.31 (2).

Frequency in MHz	Limit ( $\mu\text{V}/\text{m}$ )	Measurement distance (m)	Limits ( $\text{dB}\mu\text{V}/\text{m}$ )
30 – 88	100@3m	3	40.0@3m
88 – 216	150@3m	3	43.5@3m
216 – 960	200@3m	3	46.0@3m
960 - 26000	500@3m	3	54.0@3m
26000 - 40000	500@3m	1	54.0@3m

The measured values above 26 GHz are corrected with an inverse linear distance extrapolation factor (20 dB/decade).

§15.35(b) ..., there is also a limit on the radio frequency emissions, as measured using instrumentation with a peak detector function, corresponding to 20 dB above the maximum permitted average limit....

Used conversion factor:  $\text{Limit (dB}\mu\text{V}/\text{m)} = 20 \log (\text{Limit } (\mu\text{V}/\text{m})/1\mu\text{V}/\text{m})$

### 5.8.3 TEST PROTOCOL

Ambient temperature: 23– 27 °C  
 Air Pressure: 1006–1018 hPa  
 Humidity: 35–40 %  
 BT GFSK  
 Applied duty cycle correction (AV): 0.1 dB

Measurement Method	Ch. Center Freq. [MHz]	Band Edge Freq. [MHz]	Spurious Level [dBµV/m]	Detector	RBW [kHz]	Limit [dBµV/m]	Margin to Limit [dB]
Radiated	2480	2483.5	54.2	PEAK	1000	74.0	19.8
Radiated	2480	2483.5	34.9	AV	1000	54.0	19.1
Conducted	2402	2390	44.6	PEAK	1000	74.0	29.4
Conducted	2402	2390	34.3	AV	1000	54.0	19.7
Conducted	2480	2483.5	53.6	PEAK	1000	74.0	20.4
Conducted	2480	2483.5	41.5	AV	1000	54.0	12.5

BT n/4 DQPSK  
 Applied duty cycle correction (AV): 0.2 dB

Measurement Method	Ch. Center Freq. [MHz]	Band Edge Freq. [MHz]	Spurious Level [dBµV/m]	Detector	RBW [kHz]	Limit [dBµV/m]	Margin to Limit [dB]
Radiated	2480	2483.5	47.8	PEAK	1000	74.0	26.2
Radiated	2480	2483.5	34.9	AV	1000	54.0	19.1
Conducted	2402	2390	47.3	PEAK	1000	74.0	26.7
Conducted	2402	2390	33.6	AV	1000	54.0	20.4
Conducted	2480	2483.5	58.8	PEAK	1000	74.0	15.2
Conducted	2480	2483.5	41.0	AV	1000	54.0	13.0

BT 8-DPSK  
 Applied duty cycle correction (AV): 0.3 dB

Measurement Method	Ch. Center Freq. [MHz]	Band Edge Freq. [MHz]	Spurious Level [dBµV/m]	Detector	RBW [kHz]	Limit [dBµV/m]	Margin to Limit [dB]
Radiated	2480	2483.5	48.5	PEAK	1000	74.0	25.5
Radiated	2480	2483.5	35.0	AV	1000	54.0	19.0
Conducted	2402	2390	45.0	PEAK	1000	74.0	29.0
Conducted	2402	2390	33.7	AV	1000	54.0	20.3
Conducted	2480	2483.5	58.7	PEAK	1000	74.0	15.3
Conducted	2480	2483.5	42.9	AV	1000	54.0	11.1

BT LE 1 Mbit/s  
 Applied duty cycle correction (AV): 7.4 dB

Measurement Method	Ch. Center Freq. [MHz]	Band Edge Freq. [MHz]	Spurious Level [dBµV/m]	Detector	RBW [kHz]	Limit [dBµV/m]	Margin to Limit [dB]
Conducted	2402	2390	43.8	PEAK	1000	74.0	30.2
Conducted	2402	2390	32.9	AV	1000	54.0	21.1
Conducted	2480	2483.5	50.5	PEAK	1000	74.0	23.5
Conducted	2480	2483.5	36.5	AV	1000	54.0	17.5

BT LE 2 Mbit/s  
 Applied duty cycle correction (AV): 7.4 dB

Measurement Method	Ch. Center Freq. [MHz]	Band Edge Freq. [MHz]	Spurious Level [dBµV/m]	Detector	RBW [kHz]	Limit [dBµV/m]	Margin to Limit [dB]
Radiated	2480	2483.5	47.7	PEAK	1000	74.0	26.3
Radiated	2480	2483.5	42.1	AV	1000	54.0	11.9
Conducted	2402	2390	43.1	PEAK	1000	74.0	30.9
Conducted	2402	2390	32.8	AV	1000	54.0	21.3
Conducted	2480	2483.5	57.4	PEAK	1000	74.0	16.6
Conducted	2480	2483.5	40.2	AV	1000	54.0	13.8

WLAN b-Mode; 20 MHz; 1 Mbit/s  
Applied duty cycle correction (AV): 0 dB

Measurement Method	Ch. Center Freq. [MHz]	Band Edge Freq. [MHz]	Spurious Level [dBµV/m]	Detector	RBW [kHz]	Limit [dBµV/m]	Margin to Limit [dB]
Radiated	2462	2483.5	47.7	PEAK	1000	74.0	26.3
Radiated	2462	2483.5	34.8	AV	1000	54.0	19.2
Conducted	2412	2390.0	61.1	PEAK	1000	74.0	12.9
Conducted	2412	2390.0	52.8	AV	1000	54.0	1.2
Conducted	2462	2483.5	58.8	PEAK	1000	74.0	15.2
Conducted	2462	2483.5	50.0	AV	1000	54.0	4.0

WLAN g-Mode; 20 MHz; 6 Mbit/s  
Applied duty cycle correction (AV): 0.1 dB

Measurement Method	Ch. Center Freq. [MHz]	Band Edge Freq. [MHz]	Spurious Level [dBµV/m]	Detector	RBW [kHz]	Limit [dBµV/m]	Margin to Limit [dB]
Radiated	2462	2483.5	49.6	PEAK	1000	74.0	24.4
Radiated	2462	2483.5	34.8	AV	1000	54.0	19.2
Conducted	2412	2390.0	71.4	PEAK	1000	74.0	2.6
Conducted	2412	2390.0	51.6	AV	1000	54.0	2.4
Conducted	2417	2390.0	70.9	PEAK	1000	74.0	3.1
Conducted	2417	2390.0	52.6	AV	1000	54.0	1.4
Conducted	2452	2483.5	72.2	PEAK	1000	74.0	1.8
Conducted	2452	2483.5	50.7	AV	1000	54.0	3.3
Conducted	2457	2483.5	72.8	PEAK	1000	74.0	1.3
Conducted	2457	2483.5	49.3	AV	1000	54.0	4.7
Conducted	2462	2483.5	71.9	PEAK	1000	74.0	2.1
Conducted	2462	2483.5	50.7	AV	1000	54.0	3.3

WLAN n-Mode; 20 MHz; MCS0  
Applied duty cycle correction (AV): 0.1 dB

Measurement Method	Ch. Center Freq. [MHz]	Band Edge Freq. [MHz]	Spurious Level [dBµV/m]	Detector	RBW [kHz]	Limit [dBµV/m]	Margin to Limit [dB]
Radiated	2462	2483.5	47.9	PEAK	1000	74.0	26.1
Radiated	2462	2483.5	34.9	AV	1000	54.0	19.1
Conducted	2412	2390.0	71.6	PEAK	1000	74.0	2.4
Conducted	2412	2390.0	51.0	AV	1000	54.0	3.0
Conducted	2417	2390.0	68.5	PEAK	1000	74.0	5.5
Conducted	2417	2390.0	49.4	AV	1000	54.0	4.6
Conducted	2457	2483.5	69.5	PEAK	1000	74.0	4.5
Conducted	2457	2483.5	49.6	AV	1000	54.0	4.4
Conducted	2462	2483.5	71.7	PEAK	1000	74.0	2.3
Conducted	2462	2483.5	49.0	AV	1000	54.0	5.0

WLAN n-Mode; 40 MHz; MCS0  
Applied duty cycle correction (AV): 0.2 dB

Measurement Method	Ch. Center Freq. [MHz]	Band Edge Freq. [MHz]	Spurious Level [dBµV/m]	Detector	RBW [kHz]	Limit [dBµV/m]	Margin to Limit [dB]
Radiated	2452	2483.5	47.7	PEAK	1000	74.0	26.3
Radiated	2452	2483.5	35.0	AV	1000	54.0	19.0
Conducted	2432	2390.0	71.3	PEAK	1000	74.0	2.7
Conducted	2432	2390.0	50.9	AV	1000	54.0	3.1
Conducted	2437	2390.0	70.3	PEAK	1000	74.0	3.7
Conducted	2437	2390.0	50.9	AV	1000	54.0	3.1
Conducted	2437	2483.5	72.0	PEAK	1000	74.0	2.0
Conducted	2437	2483.5	49.2	AV	1000	54.0	4.8
Conducted	2452	2483.5	73.0	PEAK	1000	74.0	1.0
Conducted	2452	2483.5	51.4	AV	1000	54.0	2.6

Remark: Please see next sub-clause for the measurement plot.



### 5.8.4 MEASUREMENT PLOT (EXAMPLE PLOT, SHOWING WORST CASE, IF APPLICABLE)

Radio Technology = Bluetooth BDR, Operating Frequency = low + high, Band Edge = low + high  
(S01\_161\_AD01)

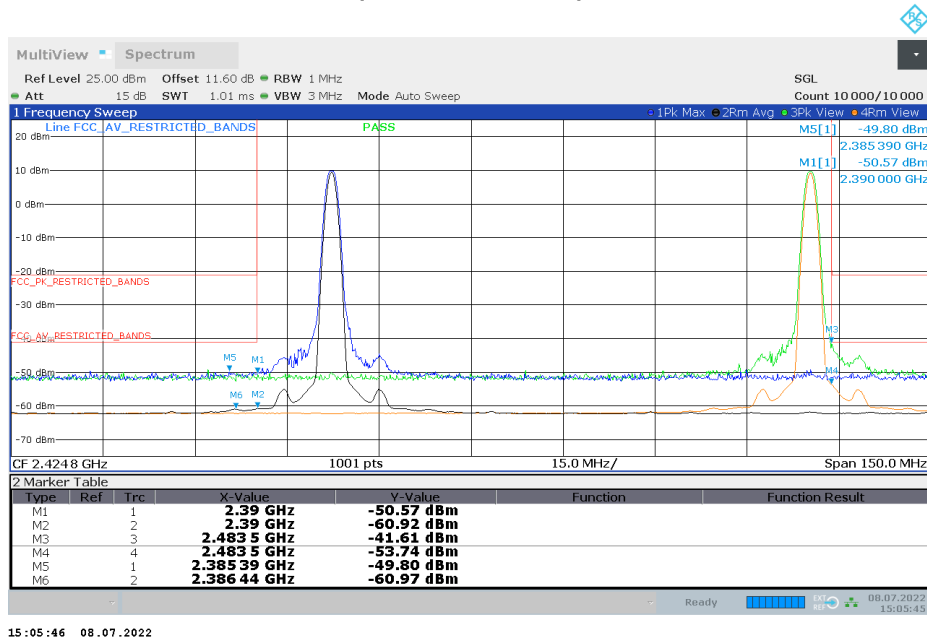

Radio Technology = Bluetooth BDR, Operating Frequency = high, Band Edge = high  
(S02\_161\_AB01)

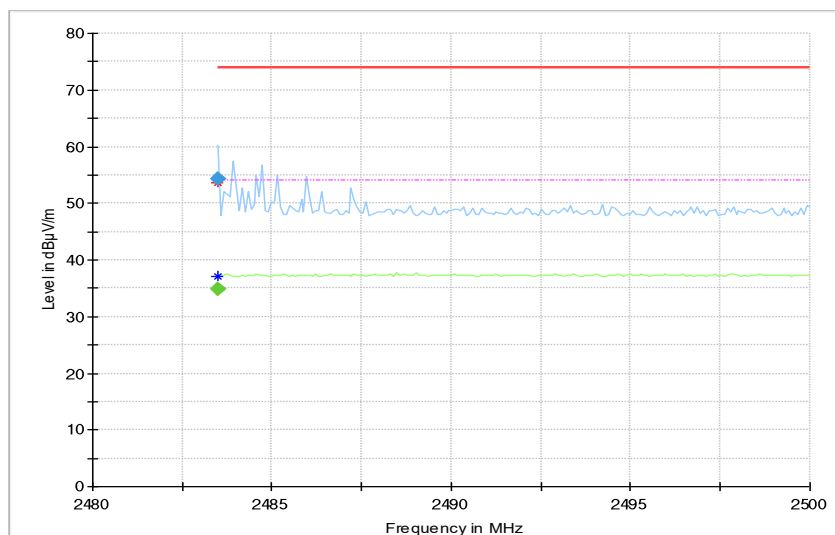

### Final Result

Frequency (MHz)	MaxPeak (dBµV/m)	CAverage (dBµV/m)	Limit (dBµV/m)	Margin (dB)	Meas. Time (ms)	Bandwidth (kHz)	Height (cm)	Pol	Azimuth (deg)	Elevation (deg)	Corr. (dB/m)
2483.500	---	34.8	54.00	19.17	1000.0	1000.000	150.0	H	154.0	15.0	5.3
2483.500	54.2	---	74.00	19.76	1000.0	1000.000	150.0	H	154.0	15.0	5.3

Radio Technology = Bluetooth EDR 2, Operating Frequency = low + high, Band Edge = low + high  
(S01\_161\_AD01)

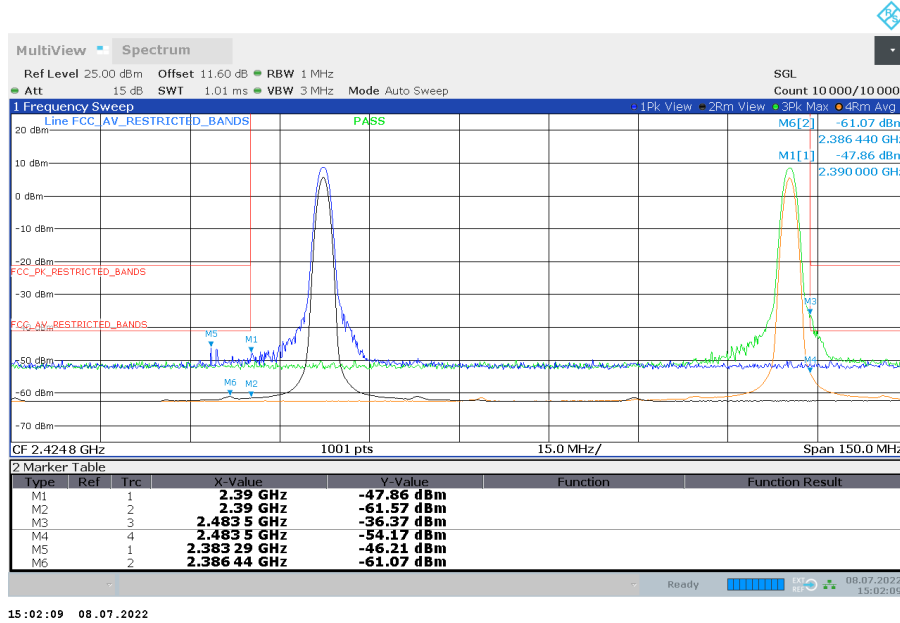

Radio Technology = Bluetooth EDR 2, Operating Frequency = high, Band Edge = high  
(S02\_161\_AB01)

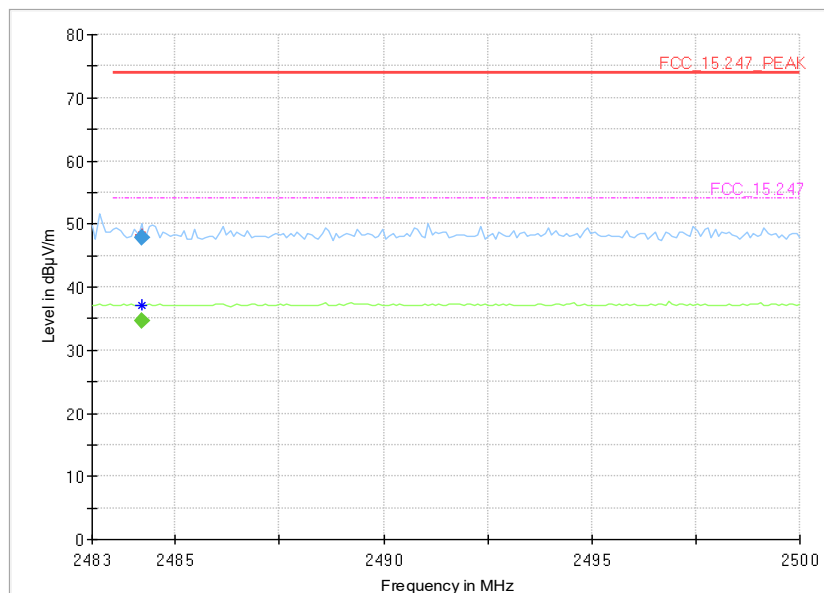

### Final\_Result

Frequency (MHz)	MaxPeak (dBµV/m)	CAverage (dBµV/m)	Limit (dBµV/m)	Margin (dB)	Meas. Time (ms)	Bandwidth (kHz)	Height (cm)	Pol	Azimuth (deg)	Elevation (deg)	Corr. (dB/m)
2484.190	---	34.7	54.00	19.30	1000.0	1000.000	150.0	V	144.0	15.0	5.3
2484.190	47.8	---	74.00	26.20	1000.0	1000.000	150.0	V	144.0	15.0	5.3

Radio Technology = Bluetooth EDR 3, Operating Frequency = low + high, Band Edge = low + high  
(S01\_161\_AD01)

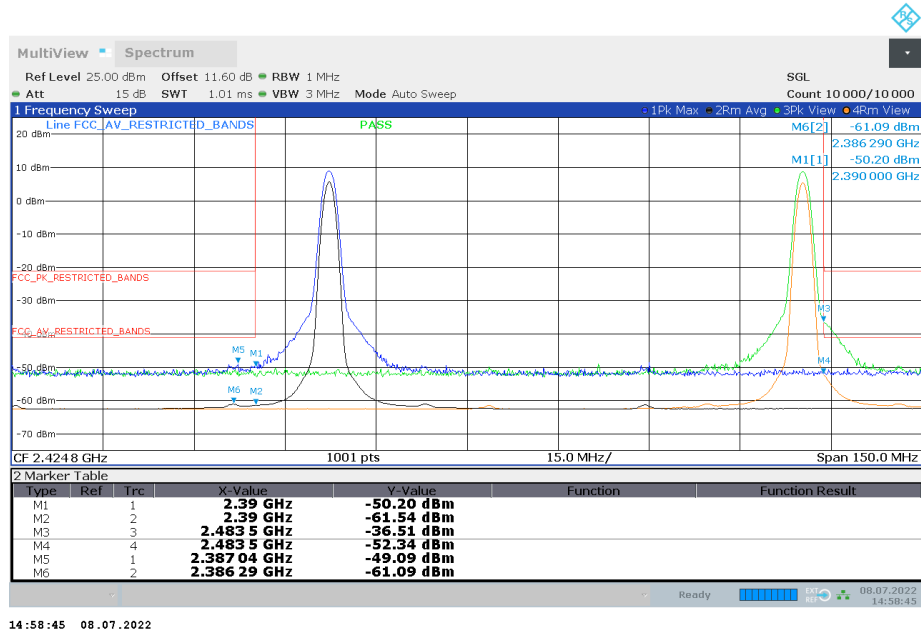

Radio Technology = Bluetooth EDR 3, Operating Frequency = high, Band Edge = high  
(S02\_161\_AB01)

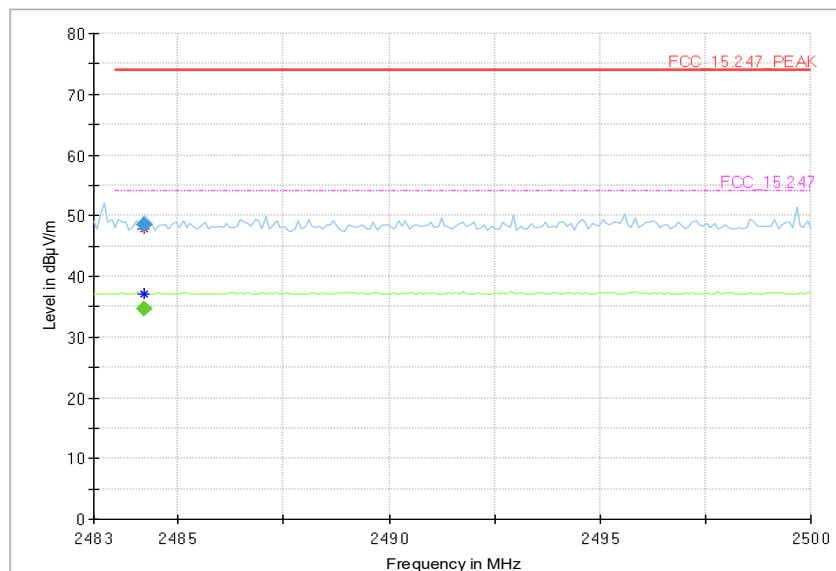

### Final Result

Frequency (MHz)	MaxPeak (dBµV/m)	CAverage (dBµV/m)	Limit (dBµV/m)	Margin (dB)	Meas. Time (ms)	Bandwidth (kHz)	Height (cm)	Pol	Azimuth (deg)	Elevation (deg)	Corr. (dB/m)
2484.190	---	34.7	54.00	19.31	1000.0	1000.000	150.0	V	-115.0	15.0	5.3
2484.190	48.5	---	74.00	25.54	1000.0	1000.000	150.0	V	-115.0	15.0	5.3

Radio Technology = Bluetooth LE 1 Mbps, Operating Frequency = low + high, Band Edge = low + high  
(S01\_161\_AD01)

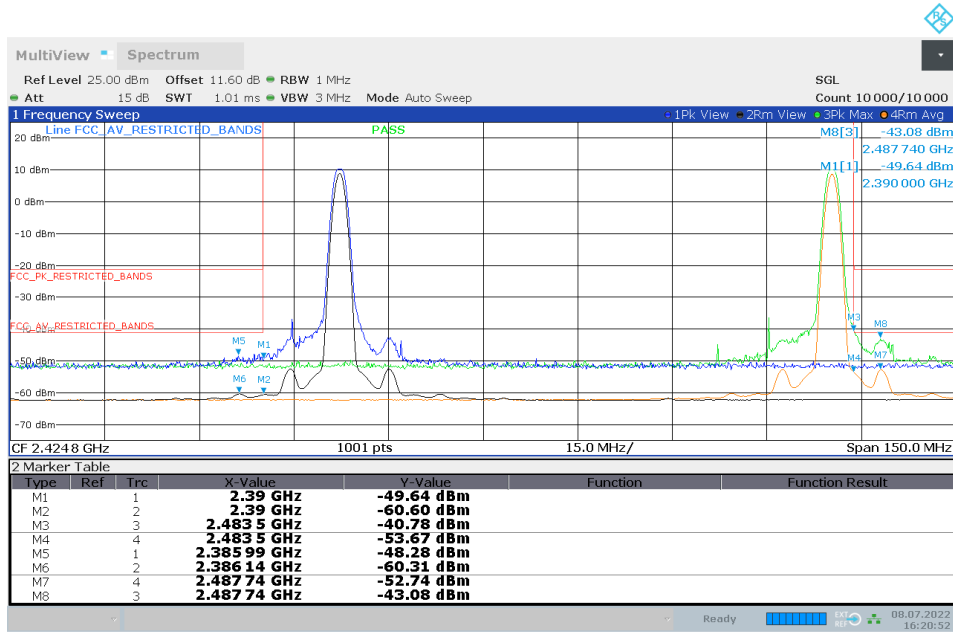

16:20:52 08.07.2022

Radio Technology = Bluetooth LE 2 Mbps, Operating Frequency = low + high, Band Edge = low + high  
(S01\_161\_AD01)

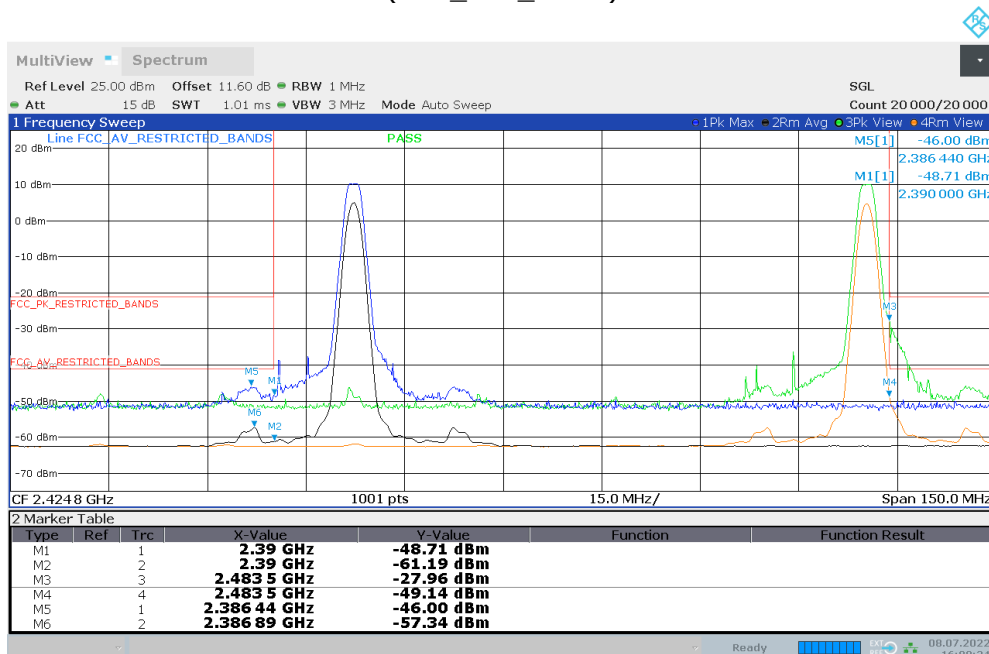

16:00:34 08.07.2022

Radio Technology = Bluetooth LE 2 Mbps, Operating Frequency = high, Band Edge = high  
(S02\_161\_AB01)

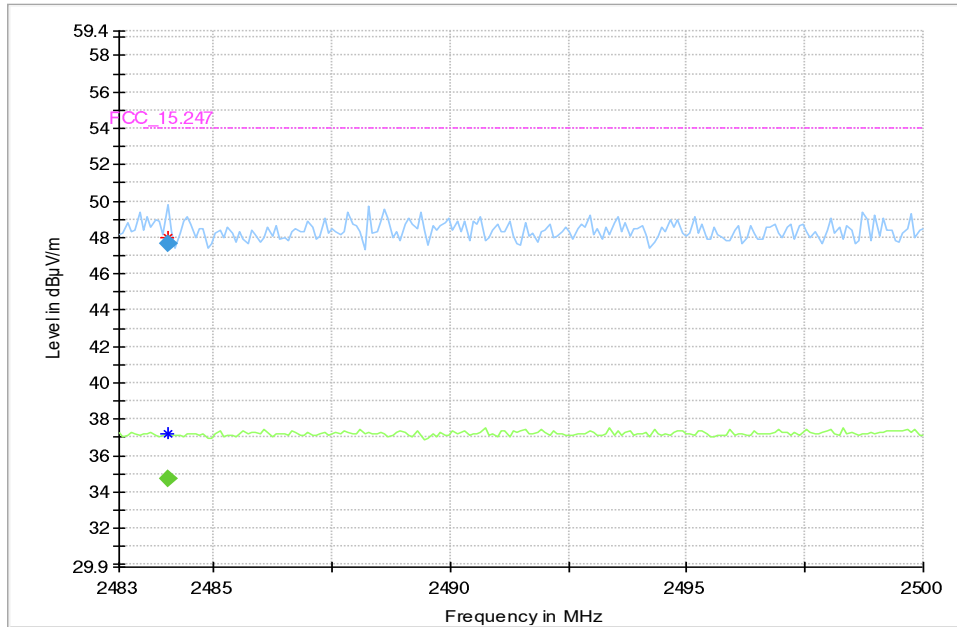

### Final\_Result

Frequency (MHz)	MaxPeak (dBµV/m)	CAverage (dBµV/m)	Limit (dBµV/m)	Marg in (dB)	Meas. Time (ms)	Bandwidth (kHz)	Height (cm)	Pol	Azimuth (deg)	Elevation (deg)	Corr. (dB/m)
2484.020	47.7	---	74.0	26.27	1000.0	1000.00	150.	H	-19.0	-15.0	5.3
2484.020	---	34.7	54.0	19.28	1000.0	1000.00	150.	H	-19.0	-15.0	5.3

Radio Technology = WLAN b, Operating Frequency = low + high, Band Edge = low + high (S01\_161\_AA01)

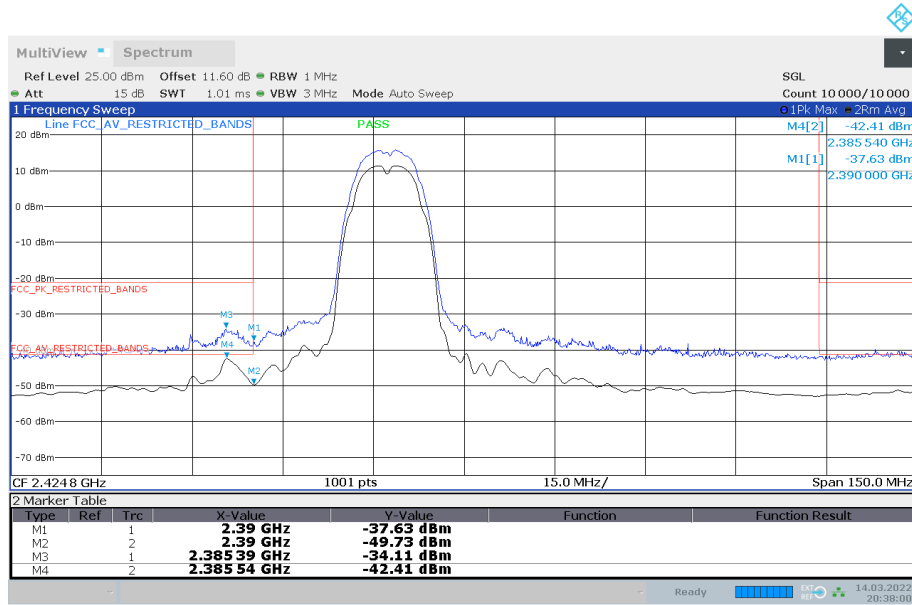

20:38:01 14.03.2022

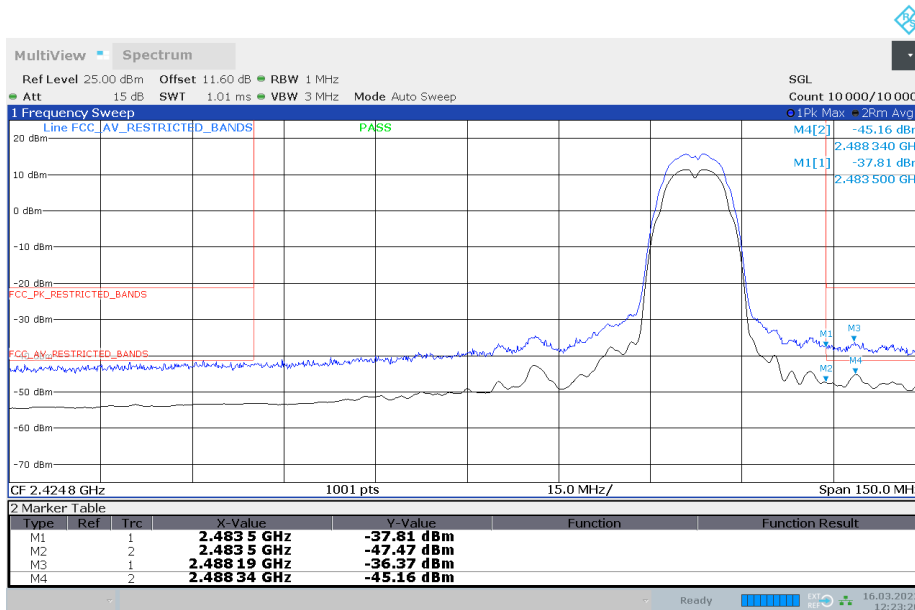

12:23:20 16.03.2022

Radio Technology = WLAN b, Operating Frequency = high, Band Edge = high  
(S02\_161\_AB01)

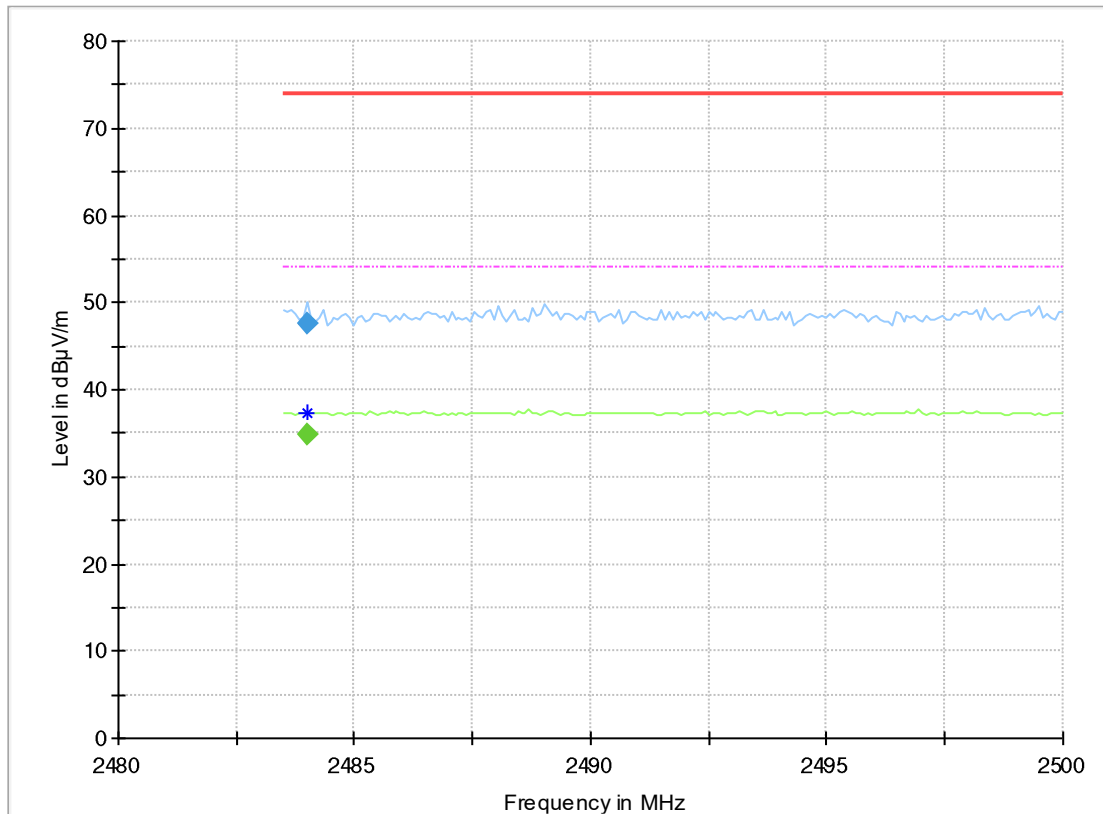

### Final Result

Frequency (MHz)	MaxPeak (dBµV/m)	CAverage (dBµV/m)	Limit (dBµV/m)	Marg in (dB)	Meas. Time (ms)	Bandwidth (kHz)	Height (cm)	Pol	Azimuth (deg)	Elevation (deg)	Corr. (dB/m)
2483.995	---	34.8	54.0	19.17	1000.0	1000.00	150.	V	-130.0	-10.0	5.3
2483.995	47.7	---	74.0	26.26	1000.0	1000.00	150.	V	-130.0	-10.0	5.3

Radio Technology = WLAN g, Operating Frequency = low + high, Band Edge = low + high (S01\_161\_AA01)

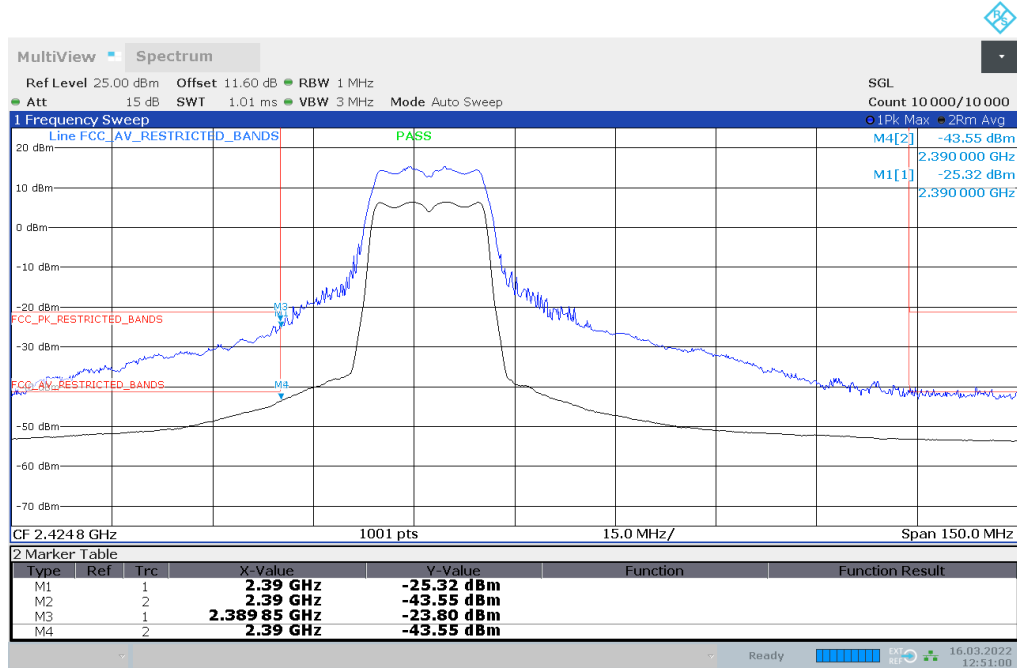

12:51:00 16.03.2022

TX on 2412 MHz

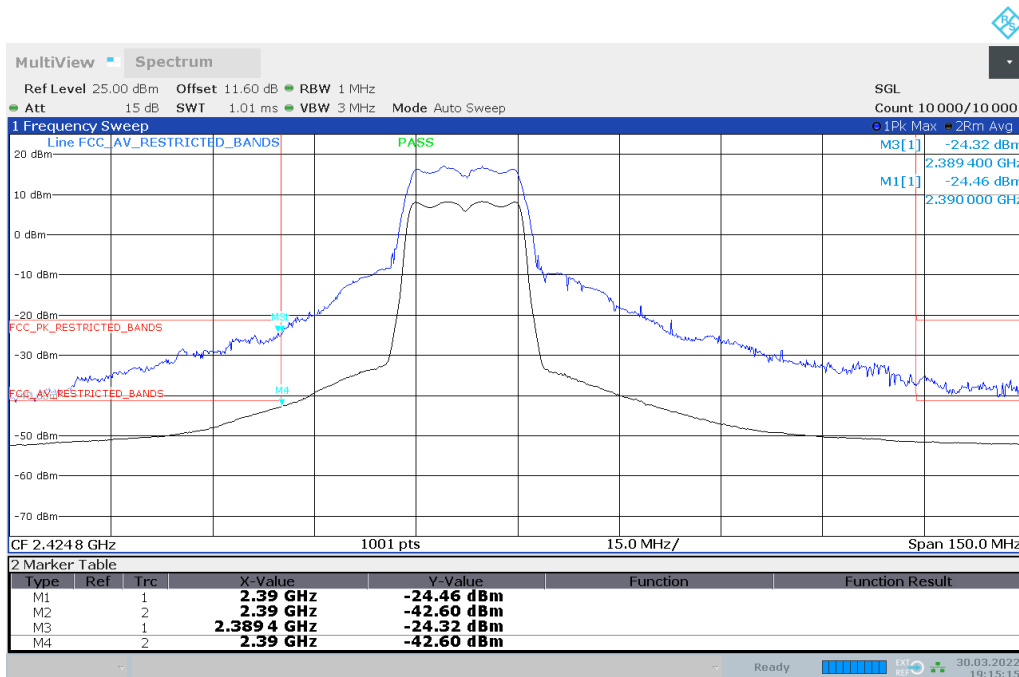

19:15:16 30.03.2022

TX on 2417 MHz



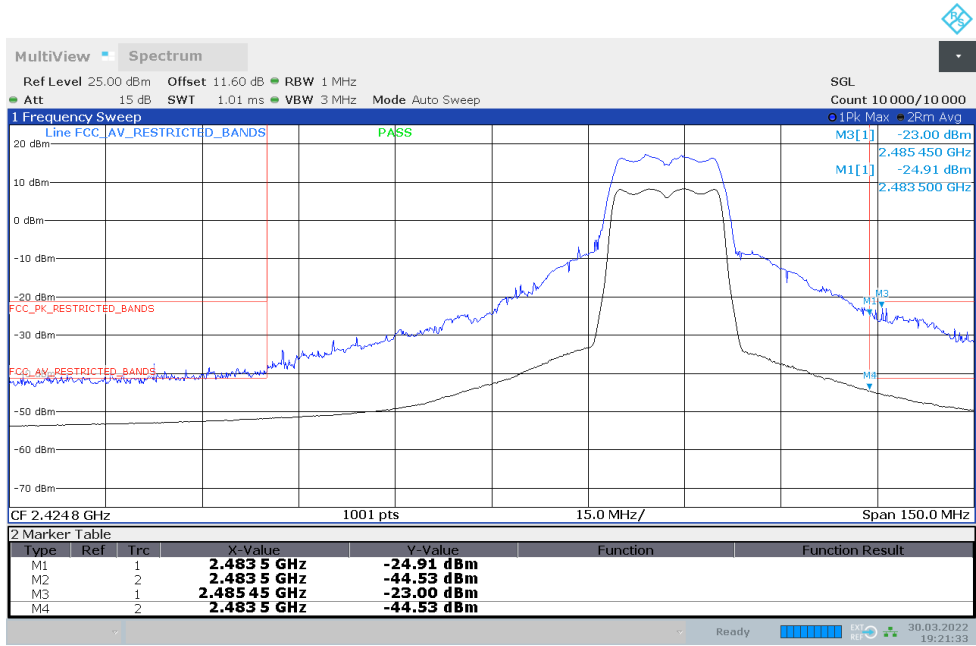

19:21:34 30.03.2022

TX on 2452 MHz

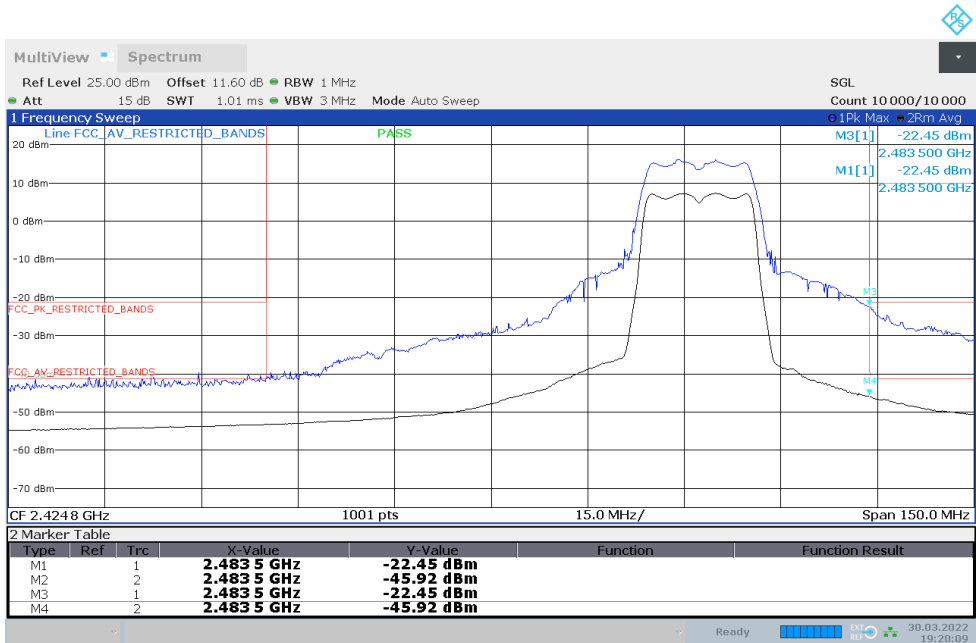

19:20:09 30.03.2022

TX on 2457 MHz

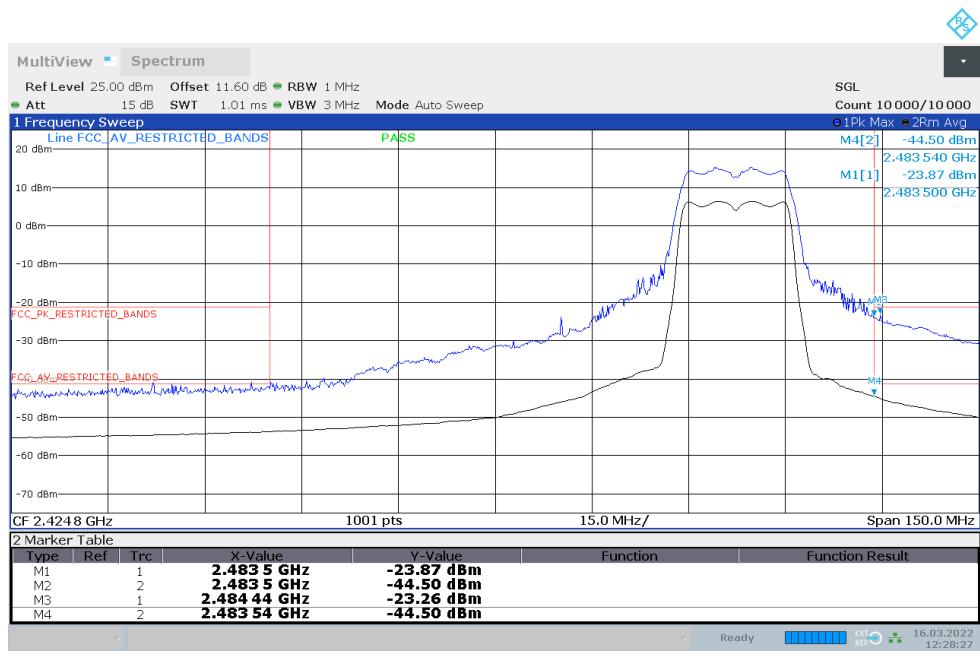

12:28:28 16.03.2022

TX on 2462 MHz

Radio Technology = WLAN g, Operating Frequency = high, Band Edge = high  
(S02\_161\_AB01)

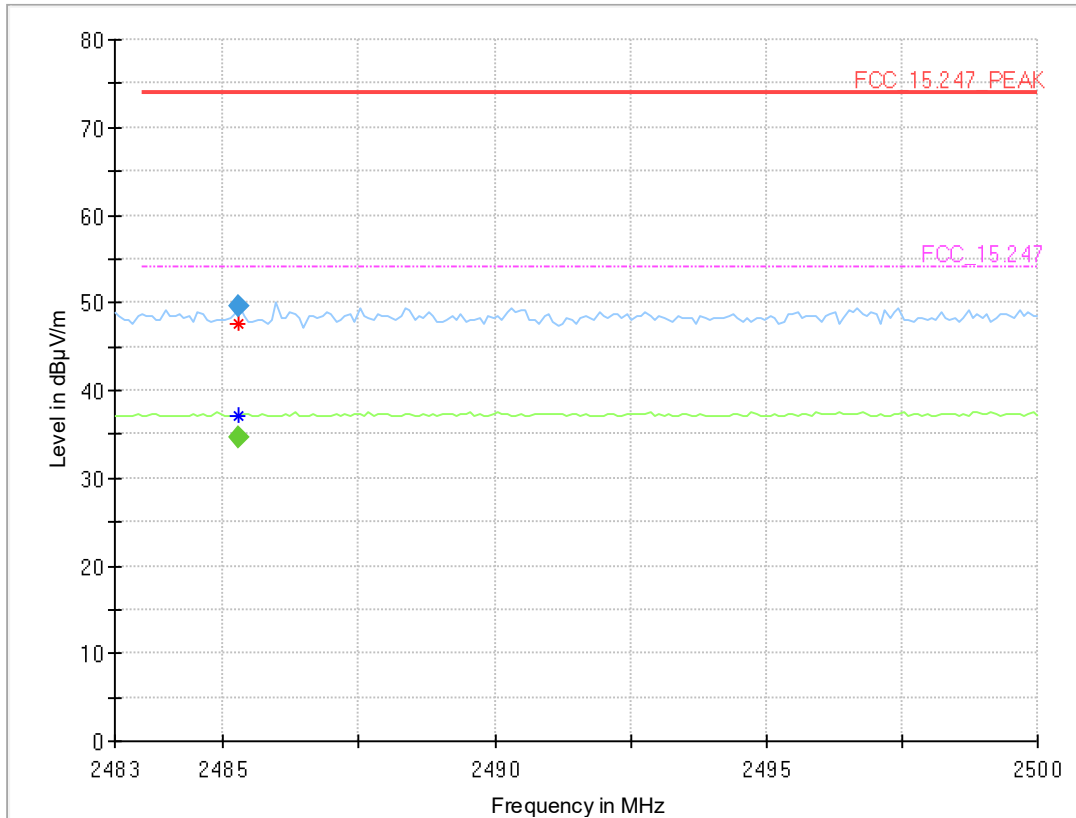

### Final Result

Frequency (MHz)	MaxPeak (dBµV/m)	CAverage (dBµV/m)	Limit (dBµV/m)	Margin (dB)	Meas. Time (ms)	Bandwidth (kHz)	Height (cm)	Pol	Azimuth (deg)	Elevation (deg)	Corr. (dB/m)
2485.295	---	34.7	54.00	19.27	1000.0	1000.000	150.0	H	-186.0	6.0	5.3
2485.295	49.6	---	74.00	24.42	1000.0	1000.000	150.0	H	-186.0	6.0	5.3

Radio Technology = WLAN n 20 MHz, Operating Frequency = low + high, Band Edge = low + high  
(S01\_161\_AA01)

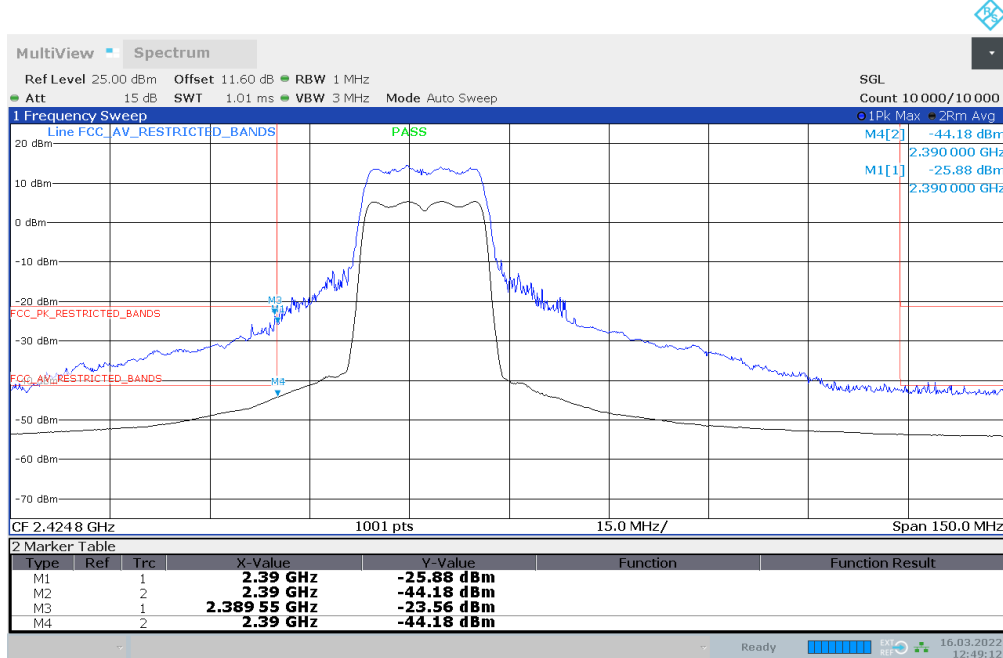

12:49:13 16.03.2022

TX on 2412 MHz

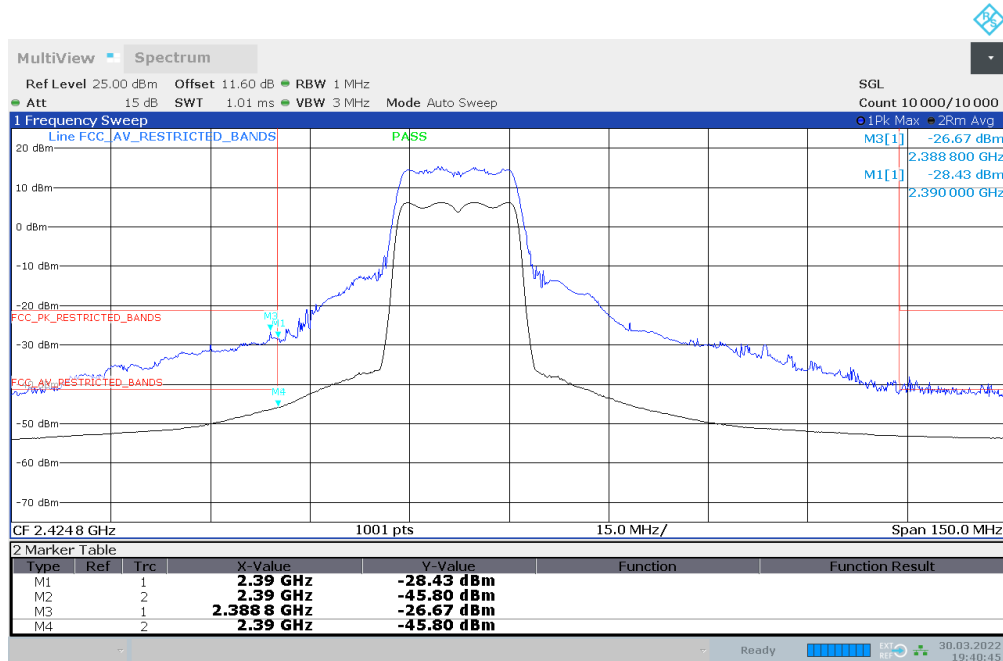

19:40:46 30.03.2022

TX on 2417 MHz

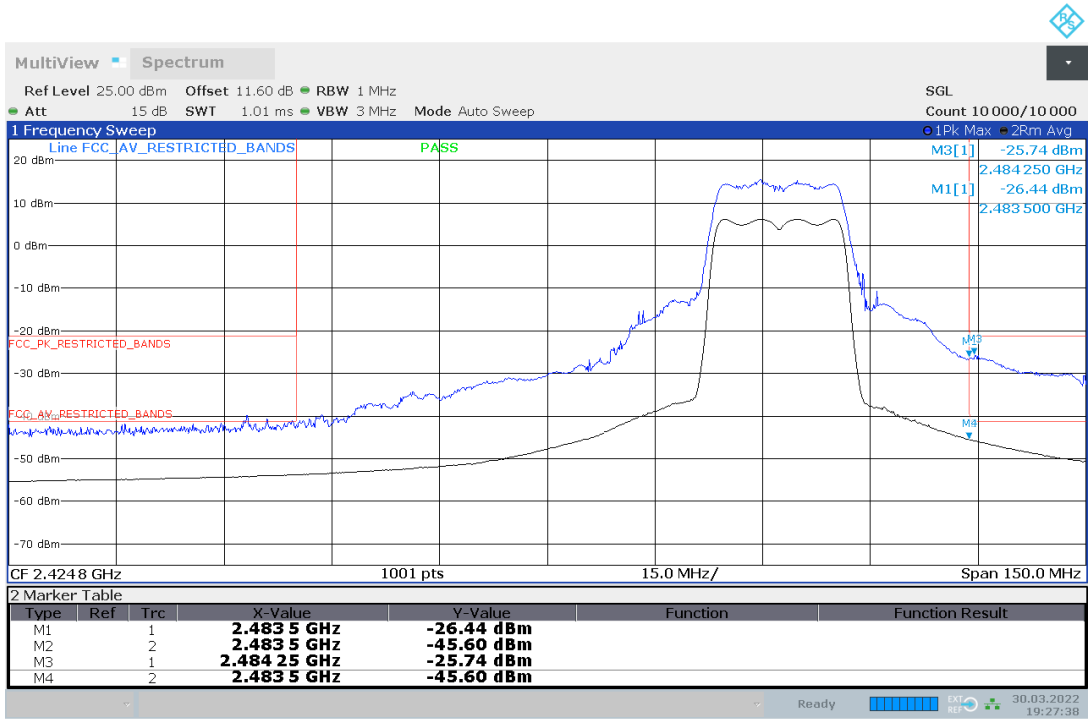

19:27:39 30.03.2022

TX on 2457 MHz

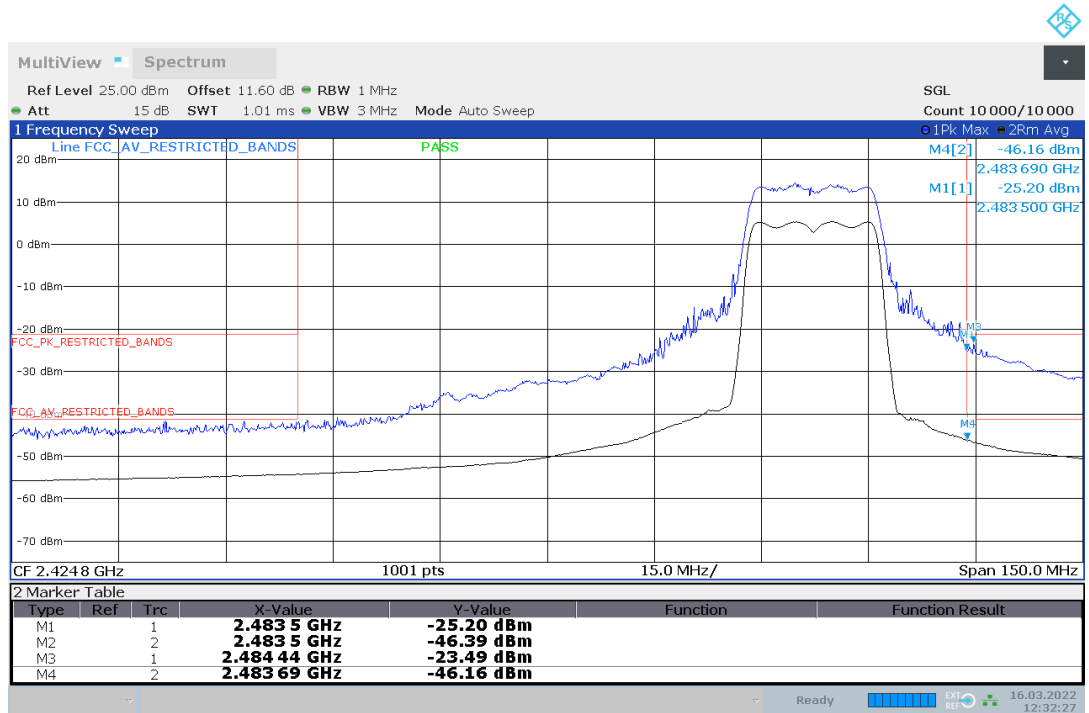

12:32:28 16.03.2022

TX on 2462 MHz

Radio Technology = WLAN n 20 MHz, Operating Frequency = high, Band Edge = high  
(S02\_161\_AB01)

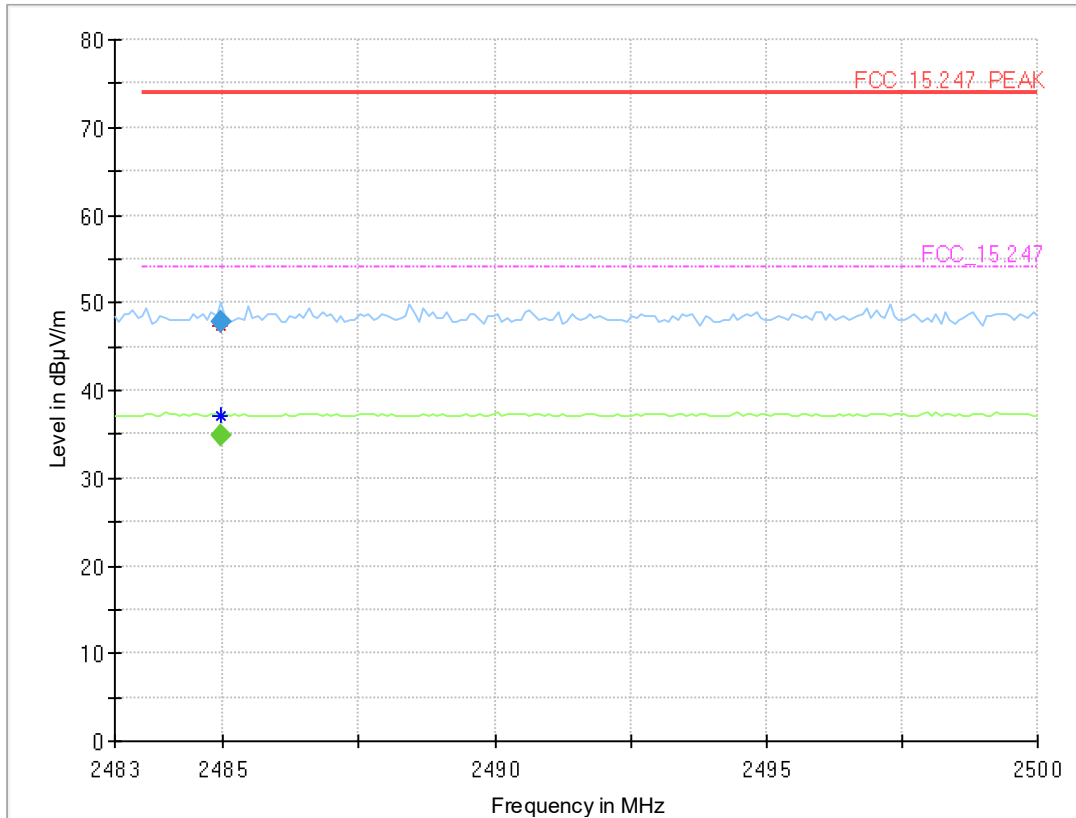

### Final Result

Frequency (MHz)	MaxPeak (dBµV/m)	CAverage (dBµV/m)	Limit (dBµV/m)	Margin (dB)	Meas. Time (ms)	Bandwidth (kHz)	Height (cm)	Pol	Azimuth (deg)	Elevation (deg)	Corr. (dB/m)
2484.955	---	34.8	54.00	19.23	1000.0	1000.000	150.0	V	131.0	87.0	5.3
2484.955	47.9	---	74.00	26.07	1000.0	1000.000	150.0	V	131.0	87.0	5.3

Radio Technology = WLAN n 40 MHz, Operating Frequency = low + high, Band Edge = low + high  
(S01\_161\_AA01)

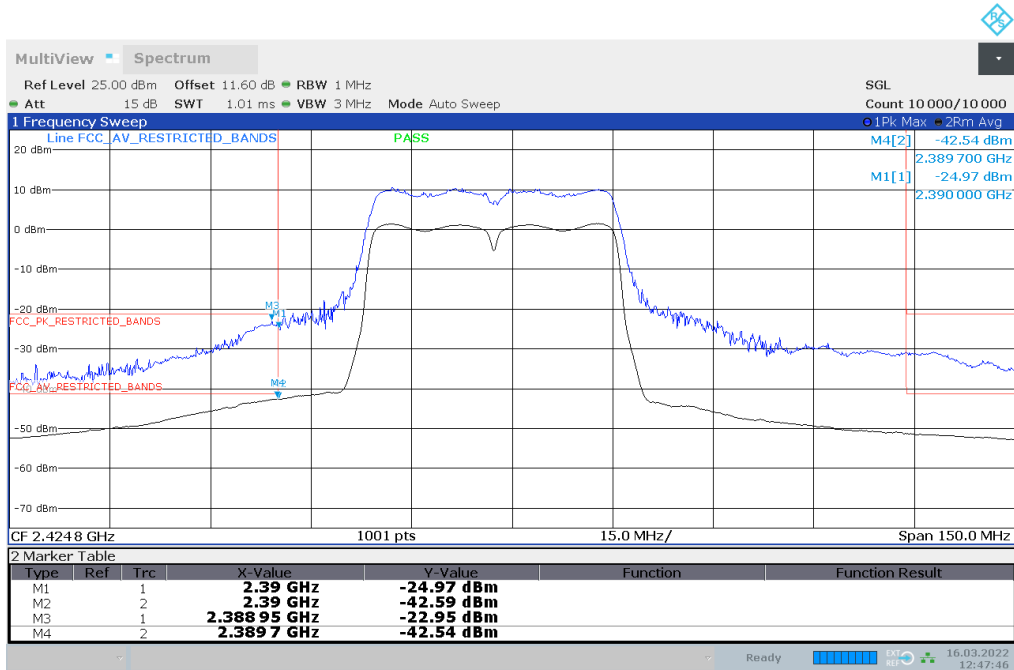

12:47:46 16.03.2022

TX on 2422 MHz

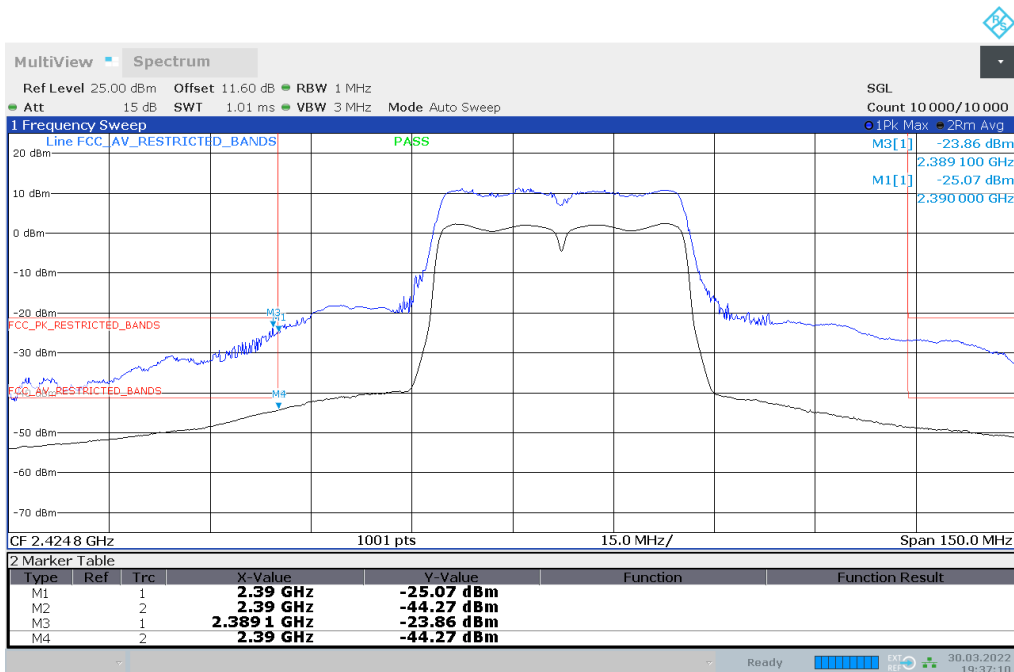

19:37:11 30.03.2022

TX on 2432 MHz

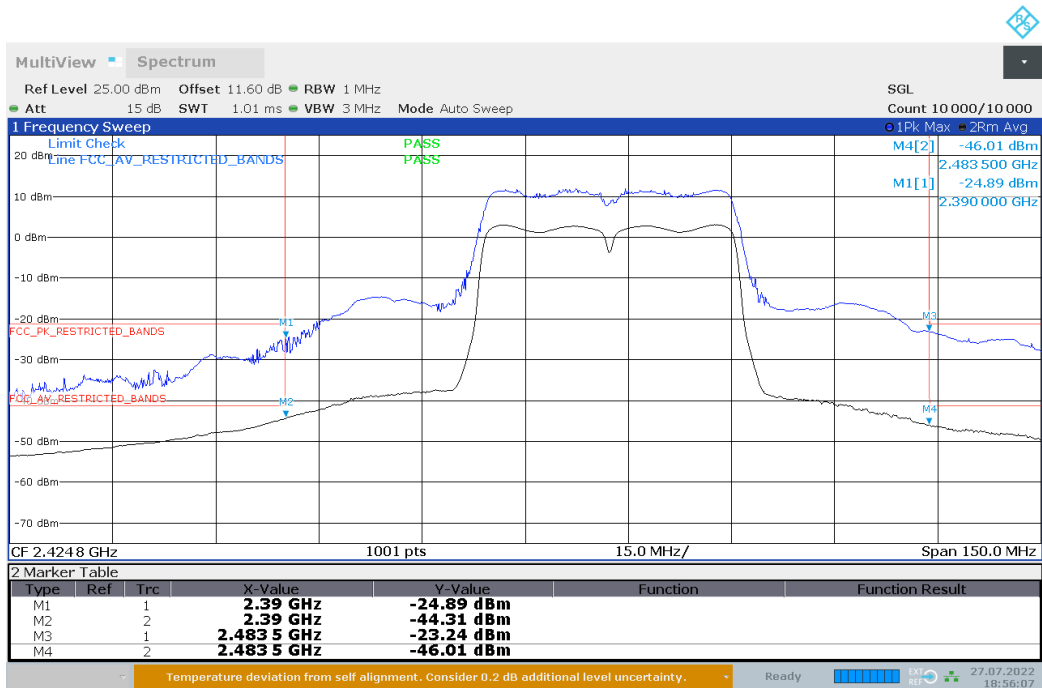

18:56:07 27.07.2022

### TX on 2437 MHz

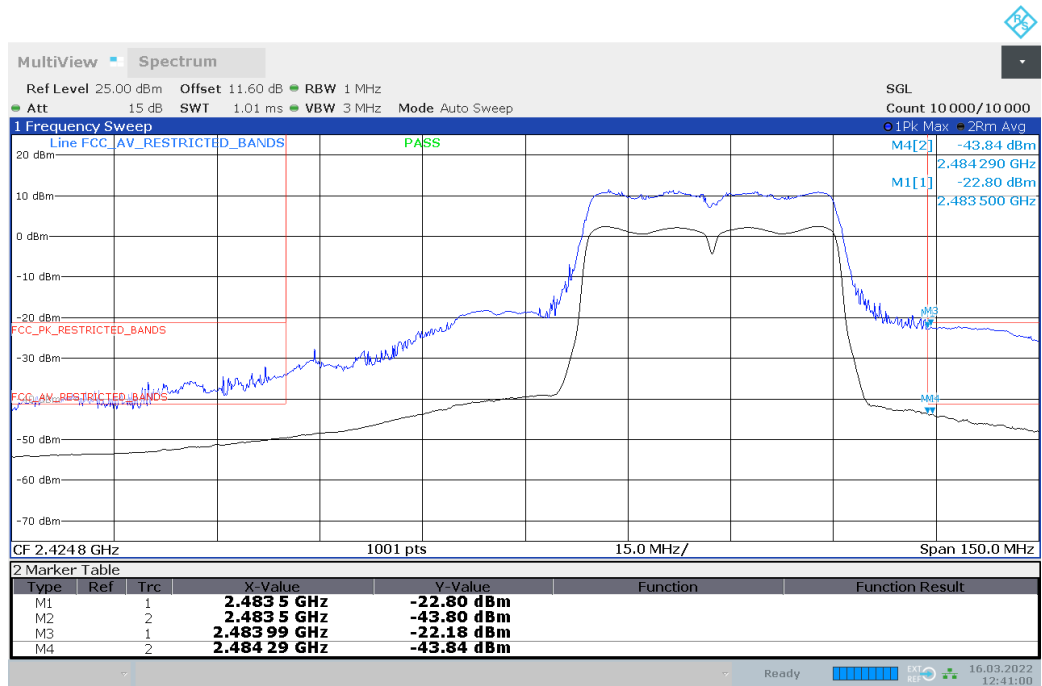

12:41:01 16.03.2022

### TX on 2462 MHz



Radio Technology = WLAN n 40 MHz, Operating Frequency = high, Band Edge = high  
(S02\_161\_AB01)

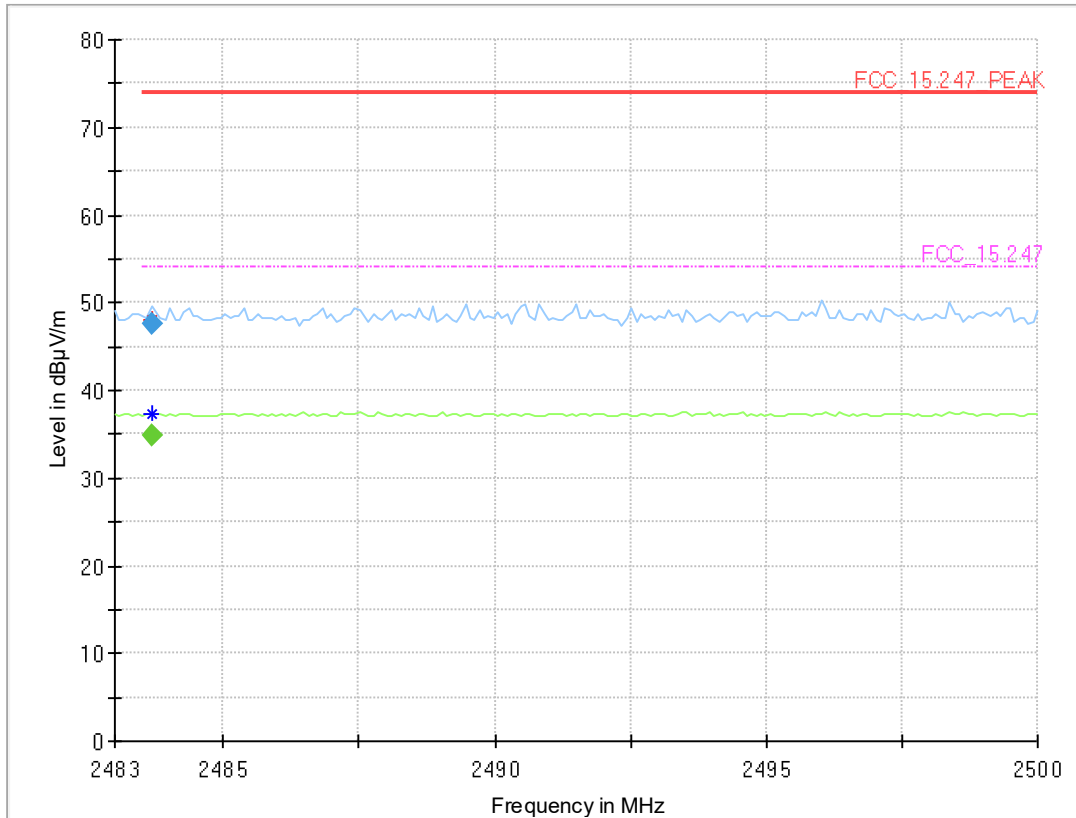

### Final Result

Frequency (MHz)	MaxPeak (dBµV/m)	CAverage (dBµV/m)	Limit (dBµV/m)	Margin (dB)	Meas. Time (ms)	Bandwidth (kHz)	Height (cm)	Pol	Azimuth (deg)	Elevation (deg)	Corr. (dB/m)
2483.680	---	34.8	54.00	19.21	1000.0	1000.000	150.0	V	-38.0	15.0	5.3
2483.680	47.7	---	74.00	26.33	1000.0	1000.000	150.0	V	-38.0	15.0	5.3

### 5.8.5 TEST EQUIPMENT USED

- Radiated Emissions FAR 2.4 GHz FCC
- R&S TS8997

## 5.9 POWER DENSITY

Standard **FCC Part 15 Subpart C**

**The test was performed according to:**

ANSI C63.10 11.10.2, 11.10.7

### 5.9.1 TEST DESCRIPTION

The Equipment Under Test (EUT) was set up in a shielded room to perform the Power Density measurements.

The results recorded were measured with the modulation which produces the worst-case (highest) power density.

The EUT was connected to the test system as described in the block diagram below. The complete attenuation of the measurement path is known and considered.

Maximum Peak Power Spectral Density (e.g. Bluetooth low energy):

Analyser settings:

- Resolution Bandwidth (RBW): 100 kHz, 10 kHz or 3 kHz
- Video Bandwidth (VBW):  $\geq 3$  times RBW
- Trace: Maxhold
- Sweeps: Till stable (min. 200, max. 15000)
- Sweeptime: Auto
- Detector: Peak

Maximum Average Power Spectral Density (e.g. WLAN):

Analyser settings:

- Resolution Bandwidth (RBW): 100 kHz, 10 kHz or 3 kHz
- Video Bandwidth (VBW):  $\geq 3$  times RBW
- Sweep Points:  $\geq 2$  times span / RBW
- Trace: Maxhold
- Sweeps: Till stable (max. 150)
- Sweeptime:  $\leq$  Number of Sweep Points x minimum transmission duration
- Detector: RMS

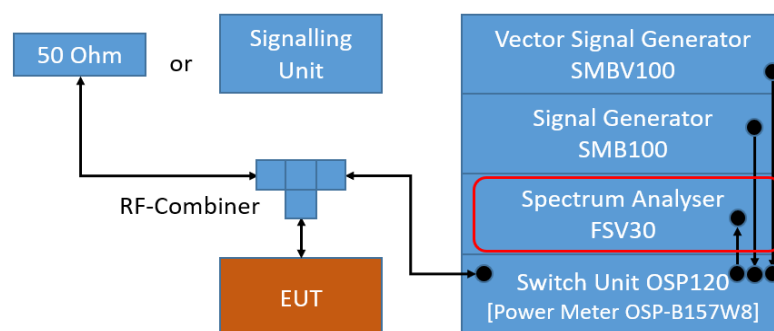

TS8997; Power Spectral Density

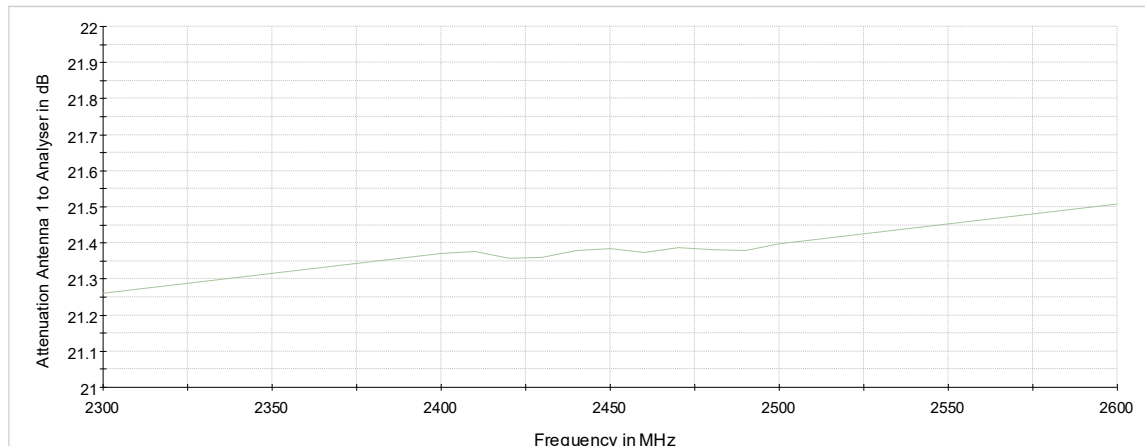

Attenuation of the measurement path

## 5.9.2 TEST REQUIREMENTS / LIMITS

FCC Part 15, Subpart C, §15.247 (e)

For digitally modulated systems, the peak power spectral density conducted from the intentional radiator to the antenna shall not be greater than 8 dBm in any 3 kHz band during any time interval of continuous transmission.

...

The same method of determining the conducted output power shall be used to determine the power spectral density.

FCC Part 15, Subpart C, §15.247 (f)

(f) For the purposes of this section, hybrid systems are those that employ a combination of both frequency hopping and digital modulation techniques.

...

The power spectral density conducted from the intentional radiator to the antenna due to the digital modulation operation of the hybrid system, with the frequency hopping operation turned off, shall not be greater than 8 dBm in any 3 kHz band during any time interval of continuous transmission

### 5.9.3 TEST PROTOCOL

Ambient temperature: 23-25 °C  
 Air Pressure: 990-1024 hPa  
 Humidity: 30-40%

#### BT GFSK

Band	Channel No.	Frequency [MHz]	Power Density [dBm / RBW]	RBW [kHz]	Limit [dBm/3kHz]	Margin to Limit [dB]
2.4 GHz ISM	0	2402	2.2	10.0	8.0	5.8
	39	2441	1.9	10.0	8.0	6.1
	78	2480	1.8	10.0	8.0	6.2

#### BT π/4 DQPSK

Band	Channel No.	Frequency [MHz]	Power Density [dBm / RBW]	RBW [kHz]	Limit [dBm/3kHz]	Margin to Limit [dB]
2.4 GHz ISM	0	2402	-1.2	10.0	8.0	9.2
	39	2441	-1.3	10.0	8.0	9.3
	78	2480	-1.5	10.0	8.0	9.5

#### BT 8-DPSK

Band	Channel No.	Frequency [MHz]	Power Density [dBm / RBW]	RBW [kHz]	Limit [dBm/3kHz]	Margin to Limit [dB]
2.4 GHz ISM	0	2402	-1.4	10.0	8.0	9.4
	39	2441	-1.3	10.0	8.0	9.3
	78	2480	-1.5	10.0	8.0	9.5

#### BT LE 1 Mbit/s

Band	Channel No.	Frequency [MHz]	Power Density [dBm / RBW]	RBW [kHz]	Limit [dBm/3kHz]	Margin to Limit [dB]
2.4 GHz ISM	0	2402	-1.9	10.0	8.0	9.9
	19	2440	-2.1	10.0	8.0	10.1
	39	2480	-2.3	10.0	8.0	10.3

#### BT LE 2 Mbit/s

Band	Channel No.	Frequency [MHz]	Power Density [dBm / RBW]	RBW [kHz]	Limit [dBm/3kHz]	Margin to Limit [dB]
2.4 GHz ISM	0	2402	-5.1	10.0	8.0	13.1
	19	2440	-5.5	10.0	8.0	13.5
	39	2480	-5.7	10.0	8.0	13.7

#### WLAN b-Mode; 20 MHz; 1 Mbit/s

Band	Channel No.	Frequency [MHz]	Power Density [dBm / RBW]	RBW [kHz]	Limit [dBm/3kHz]	Margin to Limit [dB]
2.4 GHz ISM	1	2412	1.1	100.0	8.0	6.9
	6	2437	1.0	100.0	8.0	7.0
	11	2462	0.9	100.0	8.0	7.1

#### WLAN g-Mode; 20 MHz; 6 Mbit/s

Band	Channel No.	Frequency [MHz]	Power Density [dBm / RBW]	RBW [kHz]	Limit [dBm/3kHz]	Margin to Limit [dB]
2.4 GHz ISM	1	2412	-3.8	100.0	8.0	11.8
	6	2437	-1.8	100.0	8.0	9.8
	11	2462	-3.8	100.0	8.0	11.8

#### WLAN n-Mode; 20 MHz; MCS0

Band	Channel No.	Frequency [MHz]	Power Density [dBm / RBW]	RBW [kHz]	Limit [dBm/3kHz]	Margin to Limit [dB]
2.4 GHz ISM	1	2412	-4.7	100.0	8.0	12.7
	6	2437	-3.7	100.0	8.0	11.7
	11	2462	-4.9	100.0	8.0	12.9

WLAN n-Mode; 40 MHz; MCS0

Band	Channel No.	Frequency [MHz]	Power Density [dBm / RBW]	RBW [kHz]	Limit [dBm/3kHz]	Margin to Limit [dB]
2.4 GHz ISM	3	2422	-8.5	100.0	8.0	16.5
	6	2437	-6.3	100.0	8.0	14.3
	9	2452	-7.6	100.0	8.0	15.6

Remark: Please see next sub-clause for the measurement plot.

### 5.9.4 MEASUREMENT PLOT (EXAMPLE PLOT, SHOWING WORST CASE, IF APPLICABLE)

Radio Technology = Bluetooth BDR, Operating Frequency = low (S01\_161\_AD01)

#### Result

DUT Frequency (MHz)	Frequency (MHz)	PSD (dBm)	Limit Max (dBm)	Result
2402.000000	2402.027500	2.170	8.0	PASS

#### Ports

Port	State
1	used

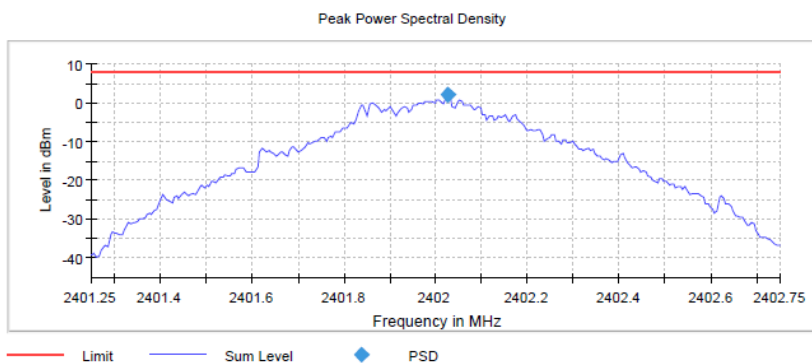

Setting	Instrument Value
Start Frequency	2.40125 GHz
Stop Frequency	2.40275 GHz
Span	1.500 MHz
RBW	10.000 kHz
VBW	30.000 kHz
SweepPoints	300
Sweeptime	1.500 ms
Reference Level	10.000 dBm
Attenuation	20.000 dB
Detector	MaxPeak
SweepCount	100
Filter	3 dB
Trace Mode	Max Hold
Sweeptype	Sweep
Preamp	off
Stablemode	Trace
Stablevalue	0.50 dB
Run	9 / max. 150
Stable	2 / 2
Max Stable Difference	0.16 dB

Radio Technology = Bluetooth EDR 2, Operating Frequency = low (S01\_161\_AD01)

#### Result

DUT Frequency (MHz)	Frequency (MHz)	PSD (dBm)	Limit Max (dBm)	Result
2402.000000	2402.002500	-1.194	8.0	PASS

#### Ports

Port	State
1	used

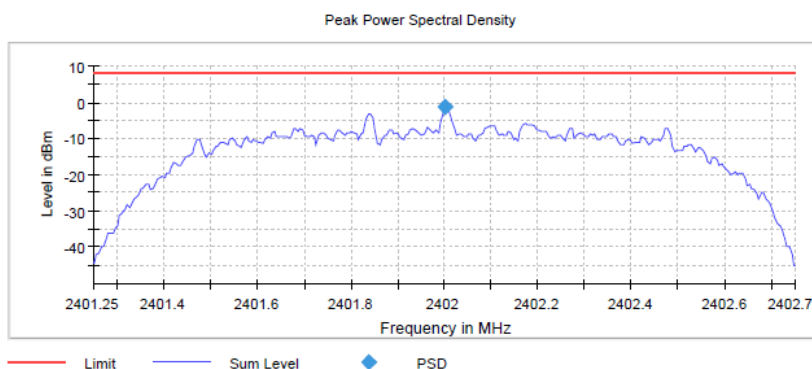

Setting	Instrument Value
Start Frequency	2.40125 GHz
Stop Frequency	2.40275 GHz
Span	1.500 MHz
RBW	10.000 kHz
VBW	30.000 kHz
SweepPoints	300
Sweeptime	1.500 ms
Reference Level	10.000 dBm
Attenuation	20.000 dB
Detector	MaxPeak
SweepCount	100
Filter	3 dB
Trace Mode	Max Hold
Sweeptype	Sweep
Preamp	off
Stablemode	Trace
Stablevalue	0.50 dB
Run	9 / max. 150
Stable	2 / 2
Max Stable Difference	0.06 dB

Radio Technology = Bluetooth EDR 3, Operating Frequency = mid  
(S01\_161\_AD01)

**Result**

DUT Frequency (MHz)	Frequency (MHz)	PSD (dBm)	Limit Max (dBm)	Result
2441.000000	2441.007500	-1.282	8.0	PASS

**Ports**

Port	State
1	used

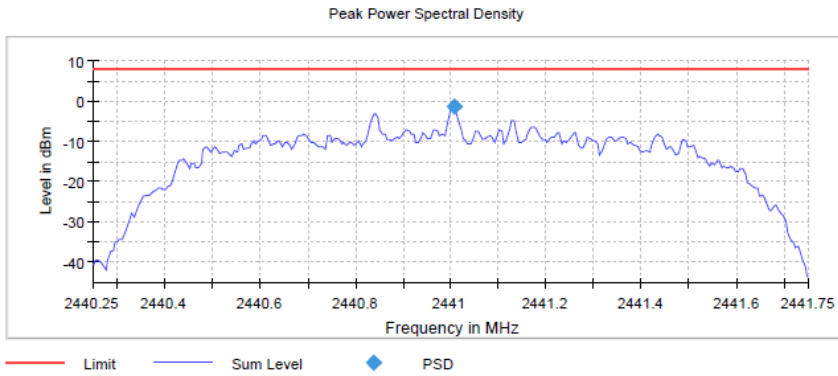

Setting	Instrument Value
Start Frequency	2.44025 GHz
Stop Frequency	2.44175 GHz
Span	1.500 MHz
RBW	10.000 kHz
VBW	30.000 kHz
SweepPoints	300
Sweeptime	1.500 ms
Reference Level	10.000 dBm
Attenuation	20.000 dB
Detector	MaxPeak
SweepCount	100
Filter	3 dB
Trace Mode	Max Hold
Sweeptype	Sweep
Preamp	off
Stablemode	Trace
Stablevalue	0.50 dB
Run	6 / max. 150
Stable	2 / 2
Max Stable Difference	0.27 dB

Radio Technology = Bluetooth LE 1 Mbps, Operating Frequency = low  
(S01\_161\_AD01)

**Result**

DUT Frequency (MHz)	Frequency (MHz)	PSD (dBm)	Limit Max (dBm)	Result
2402.000000	2401.977500	-1.858	8.0	PASS

**Ports**

Port	State
1	used

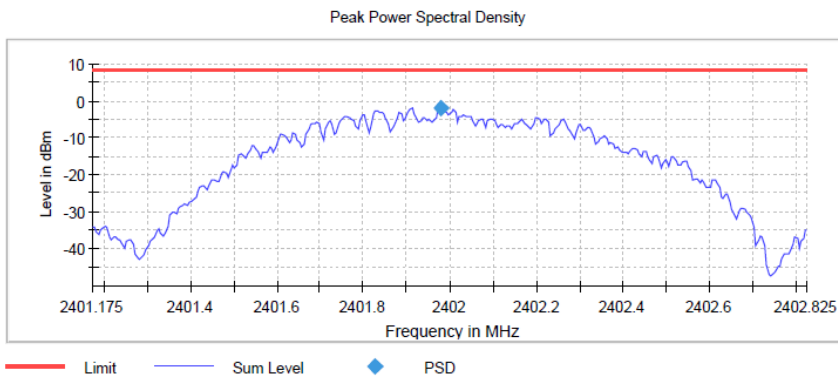

Setting	Instrument Value
Start Frequency	2.40118 GHz
Stop Frequency	2.40283 GHz
Span	1.650 MHz
RBW	10.000 kHz
VBW	30.000 kHz
SweepPoints	330
Sweeptime	1.650 ms
Reference Level	0.000 dBm
Attenuation	10.000 dB
Detector	MaxPeak
SweepCount	100
Filter	3 dB
Trace Mode	Max Hold
Sweeptype	Sweep
Preamp	off
Stablemode	Trace
Stablevalue	0.50 dB
Run	3 / max. 150
Stable	2 / 2
Max Stable Difference	0.24 dB

Radio Technology = Bluetooth LE 2 Mbps, Operating Frequency = low  
(S01\_161\_AD01)

**Result**

DUT Frequency (MHz)	Frequency (MHz)	PSD (dBm)	Limit Max (dBm)	Result
2402.000000	2401.967500	-5.130	8.0	PASS

**Ports**

Port	State
1	used

Setting	Instrument Value
Start Frequency	2.40043 GHz
Stop Frequency	2.40358 GHz
Span	3.150 MHz
RBW	10.000 kHz
VBW	30.000 kHz
SweepPoints	630
Sweeptime	3.150 ms
Reference Level	0.000 dBm
Attenuation	10.000 dB
Detector	MaxPeak
SweepCount	100
Filter	3 dB
Trace Mode	Max Hold
Sweeptype	Sweep
Preamp	off
Stablemode	Trace
Stablevalue	0.50 dB
Run	4 / max. 150
Stable	2 / 2
Max Stable Difference	0.20 dB

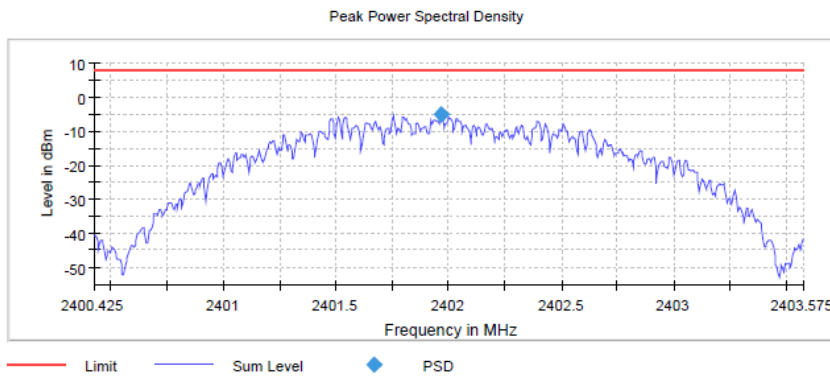

Radio Technology = WLAN b, Operating Frequency = low  
(S01\_161\_AC01)

**Result**

DUT Frequency (MHz)	Frequency (MHz)	PSD (dBm)	Limit Max (dBm)	Result
2412.000000	2411.225000	1.063	8.0	PASS

**Ports**

Port	State
1	used

Setting	Instrument Value
Start Frequency	2.39700 GHz
Stop Frequency	2.42700 GHz
Span	30.000 MHz
RBW	100.000 kHz
VBW	300.000 kHz
SweepPoints	600
Sweeptime	600.000 ms
Reference Level	0.000 dBm
Attenuation	10.000 dB
Detector	RMS
SweepCount	1
Filter	3 dB
Trace Mode	Max Hold
Sweeptype	Sweep
Preamp	off
Stablemode	Trace
Stablevalue	0.50 dB
Run	9 / max. 150
Stable	3 / 3
Max Stable Difference	0.45 dB

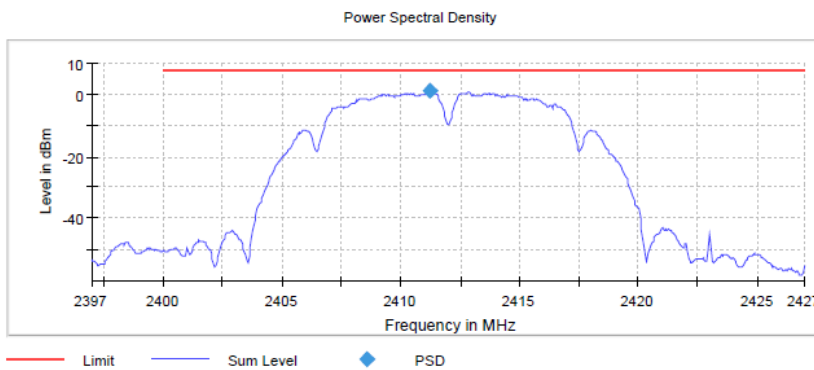

Radio Technology = WLAN g, Operating Frequency = mid  
(S01\_161\_AC01)

**Result**

DUT Frequency (MHz)	Frequency (MHz)	PSD (dBm)	Limit Max (dBm)	Result
2437.000000	2433.875000	-1.802	8.0	PASS

**Ports**

Port	State
1	used

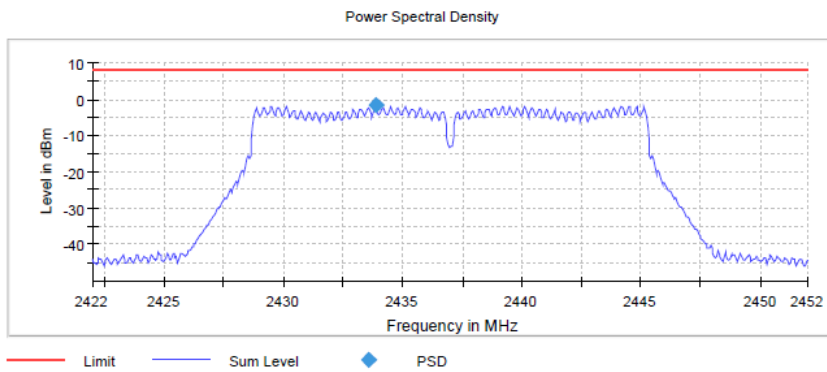

Setting	Instrument Value
Start Frequency	2.42200 GHz
Stop Frequency	2.45200 GHz
Span	30.000 MHz
RBW	100.000 kHz
VBW	300.000 kHz
SweepPoints	600
Sweptime	600.000 ms
Reference Level	10.000 dBm
Attenuation	20.000 dB
Detector	RMS
SweepCount	1
Filter	3 dB
Trace Mode	Max Hold
SweepType	Sweep
Preamp	off
Stablemode	Trace
Stablevalue	0.50 dB
Run	7 / max. 150
Stable	3 / 3
Max Stable Difference	0.39 dB

Radio Technology = WLAN n 20 MHz, Operating Frequency = mid  
(S01\_161\_AC01)

**Result**

DUT Frequency (MHz)	Frequency (MHz)	PSD (dBm)	Limit Max (dBm)	Result
2437.000000	2444.525000	-3.727	8.0	PASS

**Ports**

Port	State
1	used

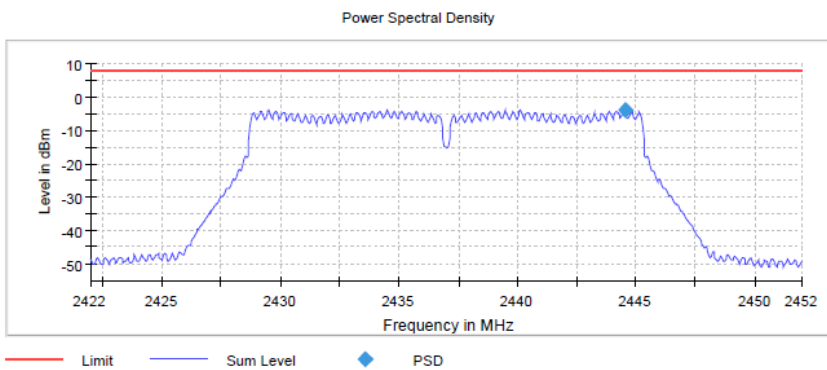

Setting	Instrument Value
Start Frequency	2.42200 GHz
Stop Frequency	2.45200 GHz
Span	30.000 MHz
RBW	100.000 kHz
VBW	300.000 kHz
SweepPoints	600
Sweptime	600.000 ms
Reference Level	0.000 dBm
Attenuation	10.000 dB
Detector	RMS
SweepCount	1
Filter	3 dB
Trace Mode	Max Hold
SweepType	Sweep
Preamp	off
Stablemode	Trace
Stablevalue	0.50 dB
Run	6 / max. 150
Stable	3 / 3
Max Stable Difference	0.36 dB



Radio Technology = WLAN n 40 MHz, Operating Frequency = mid  
(S01\_161\_AC01)

**Result**

DUT Frequency (MHz)	Frequency (MHz)	PSD (dBm)	Limit Max (dBm)	Result
2437.000000	2451.975000	-6.320	8.0	PASS

**Ports**

Port	State
1	used

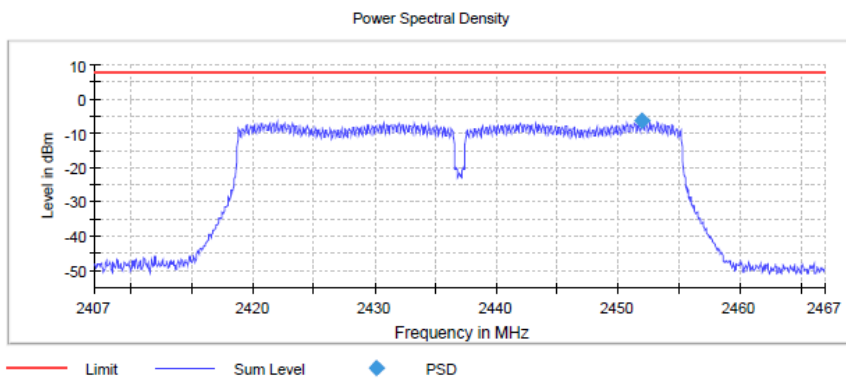

Setting	Instrument Value
Start Frequency	2.40700 GHz
Stop Frequency	2.46700 GHz
Span	60.000 MHz
RBW	100.000 kHz
VBW	300.000 kHz
SweepPoints	1200
SweepTime	1.200 s
Reference Level	10.000 dBm
Attenuation	20.000 dB
Detector	RMS
SweepCount	1
Filter	3 dB
Trace Mode	Max Hold
SweepType	Sweep
Preamplifier	off
Stablemode	Trace
Stablevalue	0.50 dB
Run	13 / max. 150
Stable	3 / 3
Max Stable Difference	0.35 dB

**5.9.5 TEST EQUIPMENT USED**

- R&S TS8997

## 6 TEST EQUIPMENT

- 1 R&S TS8997  
2.4 and 5 GHz Bands Conducted Test Lab

Ref.No.	Device Name	Description	Manufacturer	Serial Number	Last Calibration	Calibration Due
1.1	MFS	Rubidium Frequency Normal MFS	Datum GmbH	002	2021-11	2022-11
1.2	Opus10 TPR (8253.00)	T/P Logger 13	Lufft Mess- und Regeltechnik GmbH	13936	2021-10	2023-10
1.3	SMB100A	Signal Generator 9 kHz - 6 GHz	Rohde & Schwarz	107695	2021-06	2024-06
1.4	EX520	Digital Multimeter 12	Extech Instruments Corp	05157876	2022-06	2024-06
1.5	NGSM 32/10	Power Supply	Rohde & Schwarz GmbH & Co. KG	3456	2022-01	2024-01
1.6	FSW43	Signal analyser	Rohde & Schwarz GmbH & Co. KG	102013	2021-06	2023-06
1.7	Opus10 THI (8152.00)	T/H Logger 14	Lufft Mess- und Regeltechnik GmbH	13993	2021-08	2023-08
1.8	SMBV100A	Vector Signal Generator 9 kHz - 6 GHz	Rohde & Schwarz	259291	2019-11	2022-11
1.9	OSP120	Contains Power Meter and Switching Unit OSP-B157W8	Rohde & Schwarz	101158	2021-08	2024-08

- 2 Radiated Emissions FAR 2.4 GHz FCC  
Radiated emission tests for 2.4 GHz ISM devices in a fully anechoic room

Ref.No.	Device Name	Description	Manufacturer	Serial Number	Last Calibration	Calibration Due
2.1	Opus10 TPR (8253.00)	T/P Logger 13	Lufft Mess- und Regeltechnik GmbH	13936	2021-10	2023-10
2.2	AMF-7D00101800-30-10P-R	Broadband Amplifier 100 MHz - 18 GHz	Miteq			
2.3	Anechoic Chamber 03	FAR, 8.80m x 4.60m x 4.05m (l x w x h)	Albatross Projects	P26971-647-001-PRB	2021-04	2023-04
2.4	Fluke 177	Digital Multimeter 03 (Multimeter)	Fluke Europe B.V.	86670383	2022-06	2024-06
2.5	JS4-18002600-32-5P	Broadband Amplifier 18 GHz - 26 GHz	Miteq	849785		
2.6	FSW 43	Spectrum Analyzer	Rohde & Schwarz	103779	2021-06	2023-06
2.7	EP 1200/B, NA/B1	AC Source, Amplifier with integrated variable Oscillator	Spitzenberger & Spies GmbH & Co. KG	B6278		

Ref.No.	Device Name	Description	Manufacturer	Serial Number	Last Calibration	Calibration Due
2.8	3160-09	Standard Gain / Pyramidal Horn Antenna 26.5 GHz	EMCO Elektronik GmbH	00083069		
2.9	WHKX 7.0/18G-8SS	High Pass Filter	Wainwright Instruments GmbH	09		
2.10	TT 1.5 WI	Turn Table	Maturo GmbH	-		
2.11	5HC3500/18000-1.2-KK	High Pass Filter	Trilithic	200035008		
2.12	Opus 20 THI (8120.00)	ThermoHygro Datalogger	Lufft Mess- und Regeltechnik GmbH	115.0318.0802.033	2020-10	2022-10
2.13	TD1.5-10kg	EUT Tilt Device (Rohacell)	Maturo GmbH	TD1.5-10kg/024/3790709		
2.14	PAS 2.5 - 10 kg	Antenna Mast	Maturo GmbH	-		
2.15	AFS42-00101800-25-S-42	Broadband Amplifier 25 MHz - 18 GHz	Miteq	2035324		
2.16	HF 907	Double-ridged horn	Rohde & Schwarz	102444	2021-09	2024-09

3 Radiated Emissions SAC H-Field  
Radiated emission tests in the H-Field in a semi anechoic room

Ref.No.	Device Name	Description	Manufacturer	Serial Number	Last Calibration	Calibration Due
3.1	Opus10 TPR (8253.00)	T/P Logger 13	Lufft Mess- und Regeltechnik GmbH	13936	2021-10	2023-10
3.2	ESW44	EMI Receiver / Spectrum Analyzer	Rohde & Schwarz GmbH & Co. KG	101603	2022-01	2024-01
3.3	Anechoic Chamber 01	SAC/FAR, 10.58 m x 6.38 m x 6.00 m	Frankonia	none		
3.4	Opus10 THI (8152.00)	T/H Logger 10	Lufft Mess- und Regeltechnik GmbH	12488	2021-08	2023-08
3.5	EP 1200/B, NA/B1	AC Source, Amplifier with integrated variable Oscillator	Spitzenberger & Spies GmbH & Co. KG	B6278		
3.6	DS 420S	Turn Table 2 m diameter	HD GmbH	420/573/99		
3.7	HFH2-Z2	Loop Antenna + 3 Axis Tripod	Rohde & Schwarz GmbH & Co. KG	829324/006	2021-01	2024-01

4 Radiated Emissions SAC up to 1 GHz  
Radiated emission tests up to 1 GHz in a semi anechoic room

Ref.No.	Device Name	Description	Manufacturer	Serial Number	Last Calibration	Calibration Due
4.1	Opus10 TPR (8253.00)	T/P Logger 13	Lufft Mess- und Regeltechnik GmbH	13936	2021-10	2023-10
4.2	ESW44	EMI Receiver / Spectrum Analyzer	Rohde & Schwarz GmbH & Co. KG	101603	2022-01	2024-01
4.3	Anechoic Chamber 01	SAC/FAR, 10.58 m x 6.38 m x 6.00 m	Frankonia	none		
4.4	HL 562 ULTRALOG	Biconical-log-per antenna (30 MHz - 3 GHz) with HL 562E biconicals	Rohde & Schwarz GmbH & Co. KG	830547/003	2021-09	2024-09
4.5	Opus10 THI (8152.00)	T/H Logger 10	Lufft Mess- und Regeltechnik GmbH	12488	2021-08	2023-08
4.6	EP 1200/B, NA/B1	AC Source, Amplifier with integrated variable Oscillator	Spitzenberger & Spies GmbH & Co. KG	B6278		
4.7	DS 420S	Turn Table 2 m diameter	HD GmbH	420/573/99		
4.8	AM 4.0	Antenna Mast 4 m	Maturo GmbH	AM4.0/180/1192 0513		

5 Conducted Emissions FCC  
Conducted Emissions AC Mains for FCC standards

Ref.No.	Device Name	Description	Manufacturer	Serial Number	Last Calibration	Calibration Due
5.1	MFS	Rubidium Frequency Normal MFS	Datum GmbH	002	2021-11	2022-11
5.2	Opus10 TPR (8253.00)	T/P Logger 13	Lufft Mess- und Regeltechnik GmbH	13936	2021-10	2023-10
5.3	Chroma 6404	AC Source	Chroma ATE INC.	64040001304		
5.4	Shielded Room 02	Shielded Room 4m x 3m	Frankonia Germany EMC Solution GmbH	-		
5.5	ESH3-Z5	Two-Line V-Network (EUT)	Rohde & Schwarz GmbH & Co. KG	829996/002	2021-08	2023-08
5.6	ESR 7	EMI Receiver / Spectrum Analyzer	Rohde & Schwarz	101424	2021-01	2023-01
5.7	Opus10 THI (8152.00)	T/H Logger 02	Lufft Mess- und Regeltechnik GmbH	7489	2021-10	2023-10

The calibration interval is the time interval between "Last Calibration" and "Calibration Due"

## 7 ANTENNA FACTORS, CABLE LOSS AND SAMPLE CALCULATIONS

This chapter contains the antenna factors with their corresponding path loss of the used measurement path for all antennas as well as the insertion loss of the LISN.

### 7.1 LISN R&S ESH3-Z5 (150 KHZ – 30 MHZ)

Frequency MHz	Corr. dB	LISN insertion loss ESH3- Z5 dB	cable loss (incl. 10 dB atten- uator) dB
0.15	10.1	0.1	10.0
5	10.3	0.1	10.2
7	10.5	0.2	10.3
10	10.5	0.2	10.3
12	10.7	0.3	10.4
14	10.7	0.3	10.4
16	10.8	0.4	10.4
18	10.9	0.4	10.5
20	10.9	0.4	10.5
22	11.1	0.5	10.6
24	11.1	0.5	10.6
26	11.2	0.5	10.7
28	11.2	0.5	10.7
30	11.3	0.5	10.8

#### Sample calculation

$$U_{\text{LISN}} (\text{dB } \mu\text{V}) = U (\text{dB } \mu\text{V}) + \text{Corr. (dB)}$$

U = Receiver reading

LISN Insertion loss = Voltage Division Factor of LISN

Corr. = sum of single correction factors of used LISN, cables, switch units (if used)

Linear interpolation will be used for frequencies in between the values in the table.