

MAYA-W1 series

Host-based modules with Wi-Fi and Bluetooth
System integration manual



Abstract

Used together with the module data sheet, this manual provides a functional overview combined with best-practice design guidelines for integrating MAYA-W1 host-based modules in an end product. With several supporting examples, the document explains how applications are developed with MAYA-W1 using the integrated Linux board support package (BSP). It also describes the hardware design-in, software, component handling, regulatory compliance, and testing of the module.

Document information

Title	MAYA-W1 series	
Subtitle	Host-based modules with Wi-Fi and Bluetooth	
Document type	System integration manual	
Document number	UBX-21010495	
Revision and date	R07	6-Sep-2024
Disclosure Restriction	C1-Public	

Document status explanation

Draft	For functional testing. Revised and supplementary data will be published later.
Objective Specification	Target values. Revised and supplementary data will be published later.
Advance Information	Data based on early testing. Revised and supplementary data will be published later.
Early Production Information	Data from product verification. Revised and supplementary data may be published later.
Production Information	Document contains the final product specification.

This document applies to the following products:

Product name	Type number
MAYA-W160	MAYA-W160-00B-00
MAYA-W161	MAYA-W161-00B-00
MAYA-W161	MAYA-W161-00C-00
MAYA-W166	MAYA-W166-00B-00
MAYA-W166	MAYA-W166-01B-00

 For information about the related hardware, software, and status of listed product types, see also the respective data sheets [\[1\]](#).

u-blox or third parties may hold intellectual property rights in the products, names, logos and designs included in this document. Copying, reproduction, or modification of this document or any part thereof is only permitted with the express written permission of u-blox. Disclosure to third parties is permitted for clearly public documents only. The information contained herein is provided "as is". No warranty of any kind, either express or implied, is made in relation to the accuracy, reliability, fitness for a particular purpose or content of this document. This document may be revised by u-blox at any time. For most recent documents, please visit www.u-blox.com.
Copyright © u-blox AG.

Contents

Document information	2
Contents	3
1 System description	6
1.1 Overview.....	6
1.2 Module architecture	6
1.2.1 Block diagrams.....	7
2 Module integration	9
2.1 Power supply interface.....	10
2.1.1 Digital I/O interfaces reference voltage (VIO)	11
2.2 Antenna interfaces.....	11
2.2.1 Approved antenna designs.....	11
2.2.2 MAYA-W160, MAYA-W161, and MAYA-W166-01B	11
2.2.3 MAYA-W166-00B.....	12
2.3 Antenna Diversity	13
2.4 System function interfaces	14
2.4.1 Power-up sequence	14
2.4.2 Reset	15
2.4.3 Power-off sequence.....	15
2.4.4 Wake-up signals.....	15
2.4.5 Configuration pins	15
2.4.6 Sleep clock.....	16
2.4.7 Power states	16
2.5 Host interfaces.....	17
2.5.1 SDIO 3.0 interface.....	17
2.5.2 High-speed UART interface.....	18
2.5.3 PCM/I2S - Audio interface.....	18
2.6 Other remarks.....	19
2.6.1 Unused pins	19
2.6.2 GPIO usage.....	19
3 Design-in	20
3.1 Overview.....	20
3.2 RF interface options	20
3.2.1 Antenna design	21
3.3 Supply interfaces	26
3.3.1 Module supply design	26
3.4 Data communication interfaces	27
3.4.1 SDIO 3.0.....	27
3.4.2 High-speed UART interface.....	29
3.5 Other interfaces and notes.....	29
3.6 General high-speed layout guidelines	30

3.6.1	General considerations for schematic design and PCB floor planning	30
3.6.2	Component placement	30
3.6.3	Layout and manufacturing	30
3.7	Module footprint and paste mask	31
3.8	Thermal guidelines	32
3.9	ESD guidelines	33
3.10	Design-in checklists	34
3.10.1	Schematic checklist	34
3.10.2	Layout checklist	34
4	Software	35
4.1	Available software packages	35
4.1.1	Open-source Linux/Android drivers	35
4.1.2	MCUXpresso SDK	35
4.2	u-blox software deliverables	35
4.2.1	Yocto meta layer	36
4.3	Software architecture	36
4.4	Linux drivers bring-up	37
4.4.1	Downloading Wi-Fi driver sources	37
4.4.2	Building the Wi-Fi driver	38
4.4.3	Downloading the firmware	38
4.4.4	Deployment to the target file system	38
4.4.5	Bluetooth driver	39
4.4.6	Driver loading	39
4.4.7	Verification	39
4.5	Usage examples	40
4.6	Configuration of TX power limits and energy detection	40
4.6.1	Wi-Fi power table	40
4.6.2	Bluetooth TX power levels	43
4.6.3	Adaptivity configuration (energy detection)	44
4.7	Assigning MAC addresses	44
5	Handling and soldering	46
5.1	ESD handling precautions	46
5.2	Packaging, shipping, storage, and moisture preconditioning	46
5.3	Reflow soldering process	47
5.3.1	Cleaning	48
5.3.2	Other notes	48
6	Regulatory compliance	49
6.1	General requirements	49
6.2	European Union regulatory compliance	49
6.2.1	CE End-product regulatory compliance	49
6.2.2	Compliance with the RoHS directive	50
6.3	Great Britain regulatory compliance	50

6.3.1	UK Conformity Assessed (UKCA).....	50
6.4	United States/Canada End-product regulatory compliance	50
6.4.1	United States compliance statement (FCC).....	51
6.4.2	Canada compliance statement (ISED)	52
6.4.3	Referring to the u-blox FCC/ISED certification ID.....	53
6.4.4	Obtaining your own FCC/ISED certification ID.....	53
6.4.5	Antenna requirements	54
6.4.6	Configuration control and software security of end-products	54
6.4.7	Operating frequencies	55
6.4.8	End product labeling requirements	56
6.5	Japan radio equipment compliance.....	58
6.5.1	Compliance statement.....	58
6.5.2	End product labeling requirement.....	58
6.6	KCC South Korea compliance.....	59
6.7	Approved antennas	59
7	Product testing	61
7.1	u-blox in-line production testing	61
7.2	OEM manufacturer production test	62
	Appendix	63
	Wi-Fi transmit output power limits	63
A.1	FCC / ISED regulatory domain	63
A.1.1	Wi-Fi output power for 2.4 GHz band	63
A.1.2	Wi-Fi output power for 5 GHz band.....	64
A.2	RED and UKCA regulatory domains	64
A.2.1	Wi-Fi output power for 2.4 GHz band	64
A.2.2	Wi-Fi output power for 5 GHz band.....	65
A.3	Japan regulatory domain (Giteki).....	65
A.3.1	Wi-Fi output power for 2.4 GHz band	65
A.3.2	Wi-Fi output power for 5 GHz band.....	65
A.4	South Korea regulatory domain (KCC)	66
A.4.1	Wi-Fi output power for 2.4 GHz band	66
A.4.2	Wi-Fi output power for 5 GHz band.....	66
	Glossary.....	67
	Related documents	69
	Revision history	70
	Contact.....	70

1 System description

1.1 Overview

MAYA-W1 series modules are ultra-compact, multiradio modules with Wi-Fi 4 and Bluetooth 5.1, including variants with or without an internal antenna. MAYA-W1 supports IEEE 802.11 a/b/g/n Wi-Fi standards delivering up to 150 Mbps data throughput. With dual band 2.4 / 5 GHz and 40 MHz channel width, the modules can work as a station with different types of AP, as simple Access Point, in P2P communication, or a combination of these.

MAYA-W1 supports both Bluetooth BR/EDR and the full Bluetooth Low Energy 5.1 feature set, including long-range PHY. MAYA-W166-00B modules include an internal antenna with an optional sharp SAW filter. The module comes with RF calibration and MAC address available in the on-board OTP memory. The modules are developed for reliable, industrial devices and applications that demand high performance.

Radio type approvals for Europe (RED), Great Britain (UKCA), United States (FCC), Canada (ISED), Japan (MIC), and South Korea (KCC) are completed.

1.2 Module architecture

MAYA-W1 includes an NXP IW416 System-On-Chip (SoC), Wi-Fi 4 and BT 5.1 chipset, RF components, and an internal SMPS (DC/DC) converter that provides power to the internal voltage domains of the SoC.

MAYA-W1 supports a Secure Digital Input Output (SDIO) 3.0 and Universal Asynchronous Receiver Transmitter (UART) interfaces. The SDIO 3.0 interface is used for Wi-Fi communication with the Host CPU and to download MAYA-W1 firmware. Bluetooth data is transferred through the high-speed UART interface. The host interfaces must be selected through [configuration pins](#).

A PCM/I2S interface is available to connect an external audio codec and external audio system. A 2-wire Wireless Coexistence Interface 2 (WCI-2) is also available to enable signaling between the modules and an external co-located wireless device to manage wireless medium sharing for optimal performance.

Four different module variants are supported: MAYA-W161 supports two RF pins and MAYA-W160 has two U.FL connectors for attaching an external antenna. MAYA-W166-00B is equipped with a single, embedded PCB antenna and MAYA-W166-01B with a single antenna pin.

Variant / Ordering code	Antenna configuration	Antenna type	Host interfaces
MAYA-W160-00B	RF_ANT0: 2.4 GHz and 5 GHz Wi-Fi	Two U.FL connectors	
MAYA-W161-00B	RF_ANT1: Bluetooth	Two antenna pins	
MAYA-W161-00C		Two antenna pins	SDIO for Wi-Fi
MAYA-W166-00B	Switched 2.4 GHz Wi-Fi, Bluetooth, and 5 GHz Wi-Fi	Single embedded PCB antenna	UART for Bluetooth
MAYA-W166-01B	RF_ANT1: Switched 2.4 GHz Wi-Fi, Bluetooth, and 5 GHz Wi-Fi	Single antenna pin	

Table 1: Supported module configurations

1.2.1 Block diagrams

Figure 1 shows how the RF section of MAYA-W166 interfaces with the integrated Wi-Fi 4 and Bluetooth 5.1 chipset, external power management circuitry, and RF components in the NXP IW416 SoC.

Switch SW1 directs either the Bluetooth or 2.4 GHz Wi-Fi signal from the SoC to the internal module antenna or antenna pin through the Diplexer and (optional) LTE bypass filter (2.4 GHz BPF). SW2 is used to suppress harmonics reflected from the 5 GHz port by disconnecting the 5 GHz path when 2.4 GHz is active.

Bluetooth and 5 GHz Wi-Fi can operate simultaneously, whereas Bluetooth and 2.4 GHz Wi-Fi are time multiplexed and do not operate simultaneously.

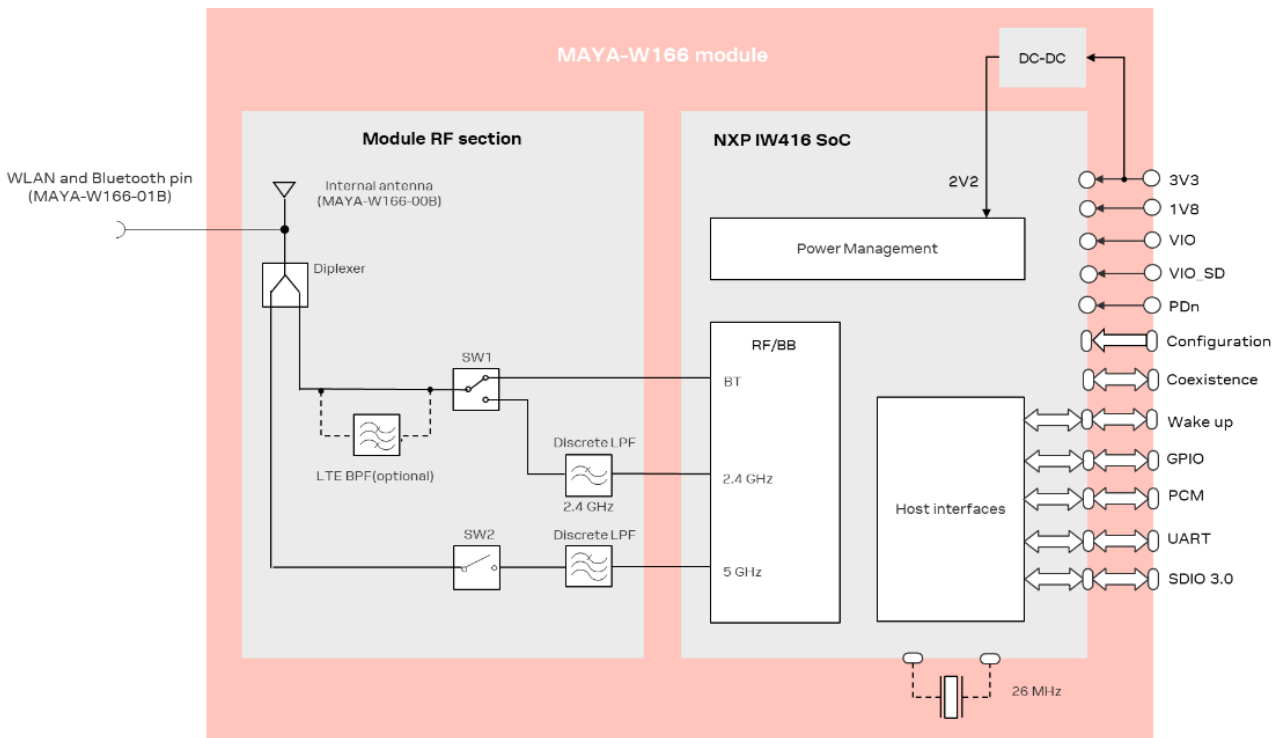

Figure 1: Block diagram of MAYA-W166

Figure 2 shows how the RF section of the MAYA-W160 and MAYA-W161 interfaces with the integrated Wi-Fi 4 and Bluetooth 5.1 chipset, external power management circuitry, and RF components in the NXP IW416 SoC.

Similar to MAYA-W166, but in these variants the Bluetooth signal is connected directly to the Bluetooth pin (W161) or U.FL connector (W160) for use with an external antenna. Bluetooth can operate simultaneously with 2.4/5 GHz Wi-Fi.

The 2.4 GHz and 5 GHz Wi-Fi signals are multiplexed through the diplexer and are connected to the WLAN pin (W161) or U.FL connector (W160). SW1 is used to suppress harmonics reflected from the 5 GHz port by disconnecting the 5 GHz path when 2.4 GHz is active.

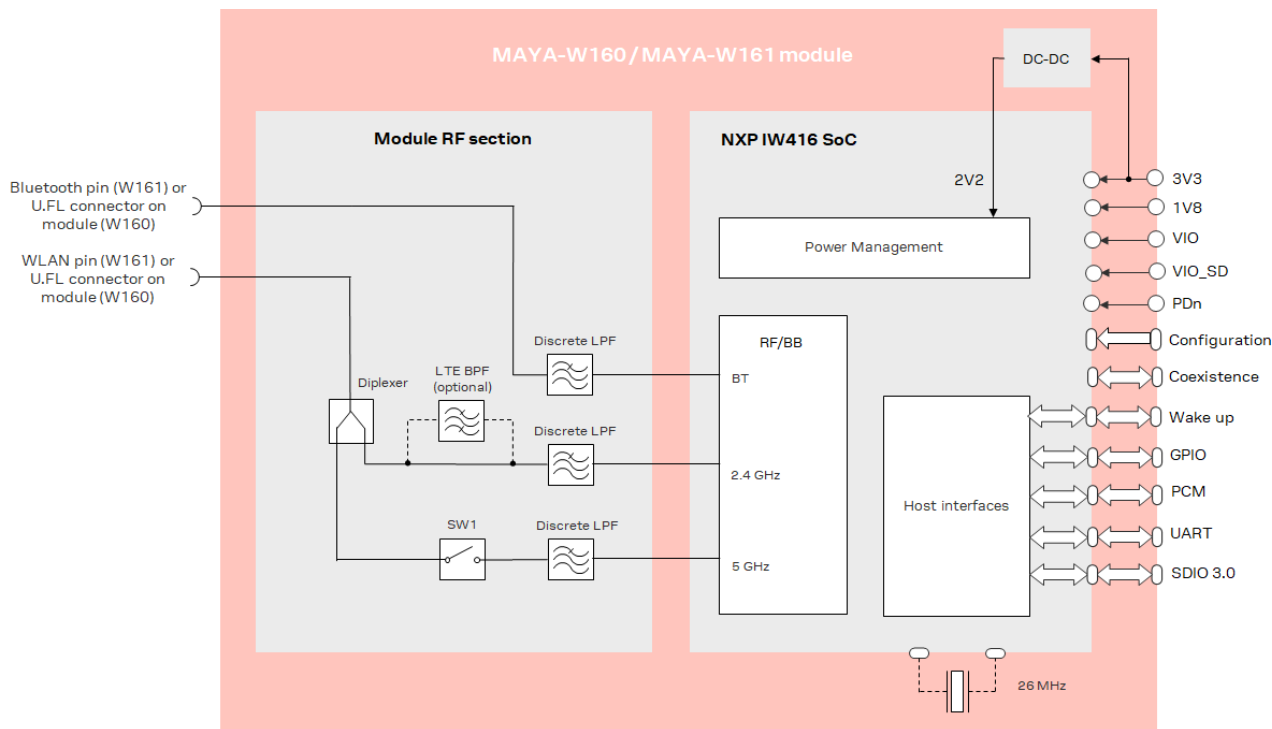



Figure 2: Block diagram of MAYA-W161 and MAYA-W160

 MAYA-W1 series modules with dedicated LTE coexistence filters (2.4 GHz BPF) are available on request. Coexistence filters are recommended for designs with co-located LTE devices operating in bands 7, 38, 40, or 41. Depending on the design, standard MAYA-W1 series modules include ceramic diplexer and LPF filters.

2 Module integration

MAYA-W1 must be integrated into the application product together with a Host CPU system. Figure 3 shows a typical integration.

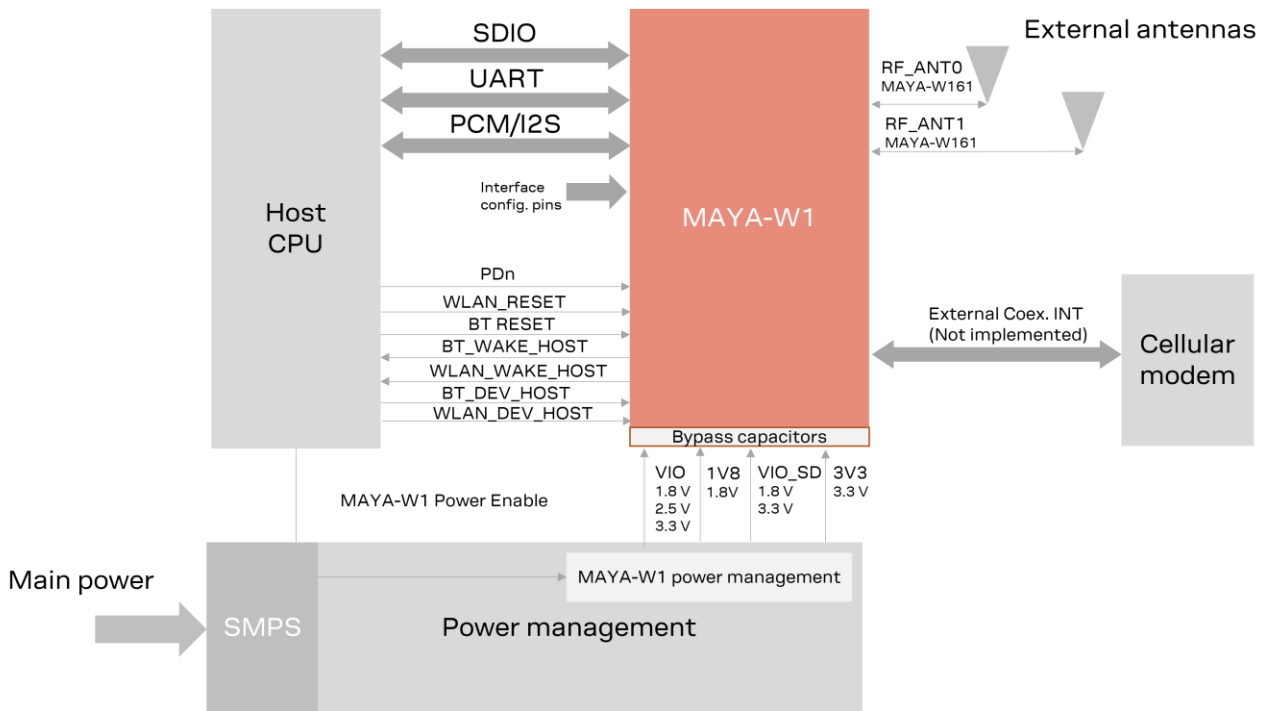

Figure 3. MAYA-W1 integration in host system

- The SDIO provides the main interface for firmware download and Wi-Fi data. The UART interface is used for handling Bluetooth data.
- Control signals for power down, reset, and host and module wake up are available to control MAYA-W1 from host CPU.
- The preferred data and communication interface between Host CPU and MAYA-W1 is set according with the instructions for [Configuration pins](#).
- The module power supply sources the **3V3**, **1V8**, **VIO**, and **VIO_SD** domain pins. To match the host CPU pad voltage, **VIO** can be set to either 1.8 V or 3.3 V. **VIO_SD** can be set to 1.8 V or 3.3 V to match the SDIO interface voltage of the Host CPU.
- Select MAYA-W1 version according to the MAYA-W1 product summary [17].
- MAYA-W160 and W161 modules support dual antenna configuration for simultaneous Bluetooth and Wi-Fi 2.4 or 5 GHz operation through the U.FL connectors or RF pins, W160 and W161. See also [Block diagrams](#) and [Antenna interfaces](#).
- MAYA-W166-00B includes an integrated antenna and MAYA-W166-01B uses a single antenna pin. In these modules, Bluetooth and Wi-Fi 2.4 GHz are time multiplexed. If requiring simultaneous Bluetooth and Wi-Fi 2.4 GHz, MAYA-W160 or MAYA-W161 must be selected
- For correct operation, it is important to correctly configure MAYA-W1 with the settings and start-up sequences described in the MAYA-W1 data sheet [1]. This configuration puts requirements on the power sources, timing, and assertion of **PDn**.
- MAYA-W1 includes a PCM/I2S interface that can be used to connect a codec for Bluetooth audio. If the interface is not used, it can be omitted.

2.1 Power supply interface

MAYA-W1 series power supply pins **3V3**, **1V8**, **VIO**, and **VIO_SD** pins must be sourced by a regulated DC power supply, such as an LDO or SMPS. The appropriate type for your design depends on the main power source of the application.

The DC power supply can be taken from any of the following sources:

- Switched Mode Power Supply (SMPS)
- Low Drop Out (LDO) regulator

When choosing between an SMPS or LDO to supply the modules, it is advisable to consider the acceptable power and thermal dissipation of the application product. See also [Guidelines for supply circuit design using an SMPS](#) and [Guidelines for supply circuit design using a LDO linear regulator](#).

Module power up must strictly follow the defined [power-up sequence](#). It is important to design the power management to comply with the recommended power-up sequence. The host integration and power supply sequence proposals shown in [Figure 3](#) and [Figure 4](#), feature a power-up mechanism that is triggered by a host GPIO and described as “MAYA-W1 Power Enable”.

The current consumed through the supply pins by MAYA-W1 series modules can vary by several orders of magnitude depending on the operation mode and state. The current consumption can change from high consumption, experienced during Wi-Fi transmission at maximum RF power level in connected-mode, to low current consumption during the low power idle-mode when power saving is enabled. Regardless of the chosen DC power supply, it is crucial that it can satisfy the high peak current consumed by the module. When designing the supply circuitry for the module, a contingency of at least 20% over the stated peak current is recommended. See also [Module supply design](#).

Domain	Allowable ripple (peak to peak) ² over DC supply			Current consumption, peak
	10-100 kHz	100 kHz-1 MHz	>1 MHz	
3V3	65 mV _{pk-pk}	25 mV _{pk-pk}	10 mV _{pk-pk}	750 mA
1V8	65 mV	25 mV _{pk-pk}	10 mV _{pk-pk}	450 mA
VIO_SD	65 mV _{pk-pk}	25 mV _{pk-pk}	10 mV _{pk-pk}	10 mA
VIO	65 mV _{pk-pk}	25 mV _{pk-pk}	10 mV _{pk-pk}	10 mA

Table 2: Summary of voltage supply requirements

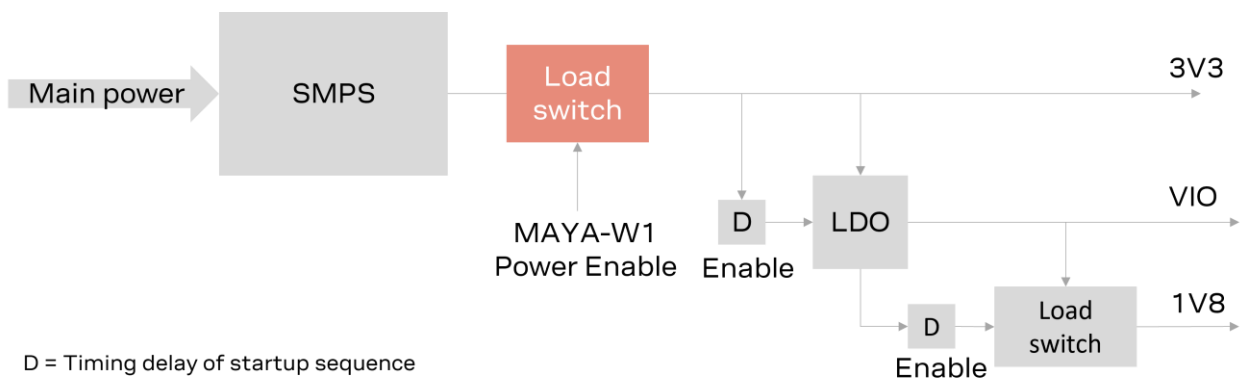

Figure 4. Example of hardware-sequenced power supply

² Ripple measured on EVK-MAYA-W1 power connectors

2.1.1 Digital I/O interfaces reference voltage (VIO)

The dedicated **VIO** pin enables integration of MAYA-W1 in either 1.8 V or 3.3 V applications without the need for level converters according to the voltage level selected.

For information about the supply voltage requirements, see also the MAYA-W1 series data sheet [1].

2.2 Antenna interfaces

MAYA-W1 series modules support three different antenna solutions:

- MAYA-W160 includes an integrated and external antenna through U.FL connectors, which makes this module particularly suitable for application products hosted in a metal enclosure where external antennas must be used.
- MAYA-W161 has two antenna pads that make it ideal for use with SMD antennas mounted on the main PCB.
- MAYA-W166-00B includes an integrated antenna. Utilization of the integrated antenna leverages the module pre-certification and eases integration of the module into the application.
- MAYA-W166-01B has a single antenna pad that make it ideal for use with SMD antenna mounted on the main PCB.

2.2.1 Approved antenna designs

MAYA-W1 modules come with a pre-certified antenna design that can be used to save cost and time during the certification process. To leverage this benefit, customers are required to implement an antenna layout that is fully compliant with the u-blox reference design outlined in the MAYA-W1 antenna reference design application note [11]. Reference design source files are available from u-blox on request.

For Bluetooth and Wi-Fi operation, MAYA-W1 modules have been tested and approved for use with the antennas featured in the list of [Approved antennas](#).

-  To avoid invalidating the compliance and pre-certification of u-blox modules with the various regulatory bodies, use only external antennas included the list of [Approved antennas](#). u-blox modules may also be integrated with other antennas. In which case, OEM installers must certify their own designs with the respective regulatory agencies.

2.2.2 MAYA-W160, MAYA-W161, and MAYA-W166-01B

MAYA-W161 and MAYA-W166-01B are ideally used with SMD antennas mounted on the main PCB connected through the transmission lines to the RF pins.

MAYA-W160 includes two U.FL connectors to connect external antennas using coaxial cables. For proper implementation, follow the [Antenna design](#) instructions.



Figure 5. MAYA-W160 with U.FL connectors RF_ANT0 is the top connector and RF_ANT1 is the lower connector

Follow instruction in the MAYA-W1 antenna reference design application note [11] to implement a design compliant with the u-blox FCC certification Grant.

Table 3 describes the RF pin functions for MAYA-W160 and MAYA-W161 modules.

Pin	Function
RF_ANT0	2.4 GHz and 5 GHz Wi-Fi
RF_ANT1	2.4 GHz Bluetooth

Table 3: RF pin functions MAYA-W160 and MAYA-W161

Table 4 describes the RF pin functions for MAYA-W166 modules.

Pin	Function
RF_ANT1	Combined 2.4 GHz and 5 GHz Wi-Fi and Bluetooth

Table 4: RF pin functions MAYA-W166-01B

For more information about the pin configurations for each module variant, see RF interface options.

2.2.3 MAYA-W166-00B

MAYA-W166-00B includes a Niche antenna that is printed on the module PCB. The antenna utilizes antenna technology from Proant AB. For proper antenna performance observe the following design considerations. If a metal enclosure is required, use a module variant with either antenna pin or U.FL connector to connect external antennas.

- To enable good antenna radiation performance, it is important to place the module on the edge of the main PCB with the antenna facing outwards.
- A ground plane extending at least 10 mm on both sides of the module is recommended.
- Include a non-disruptive GND plane underneath the module with a clearance, cut out, underneath the antenna, as shown in Figure 6.
- Observe the antenna clearance shall be implemented on all layers.
- To avoid degradation of the antenna characteristics, do not place physically tall or large components closer than 10 mm to the module antenna.
- To avoid any adverse impact on antenna performance, include a 5 mm clearance between the antenna and the casing. Polycarbonate (PC) and Acrylonitrile butadiene styrene (ABS) materials have less impact on antenna performance than other types of thermoplastics.
- Include plenty of stitching vias from the module ground pads to the GND plane layer. Ensure that the impedance between the module pads and ground reference is minimal.
- Consider the end products use case and assembly to make sure that the antenna is not obstructed by any external item.

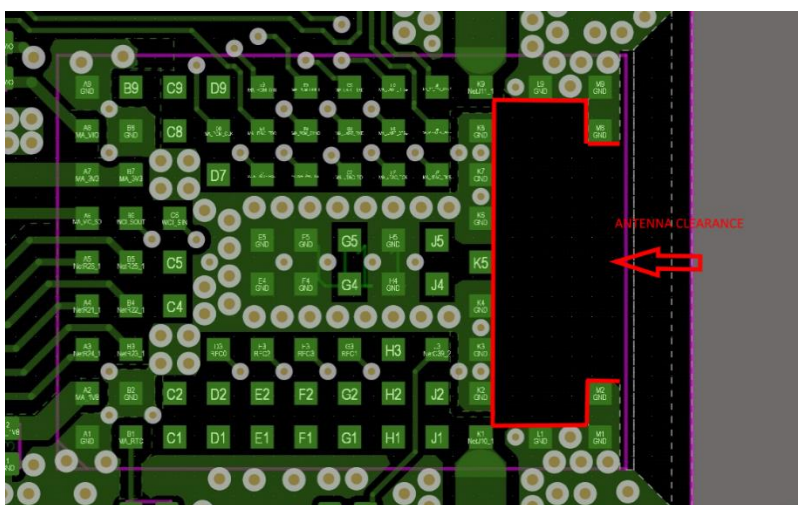

Figure 6: PCB artwork on main PCB top layer showing MAYA-W166-00B placement and GND clearance

2.3 Antenna Diversity

Antenna diversity can be implemented for the module variants with antenna pin by adding an external antenna switch, which is controlled by the antenna diversity algorithm using the RF control pin **RF_CNTL3_P**.

Antenna switching diversity is only supported in Wi-Fi station mode and is enabled by default. The antenna diversity algorithm is triggered periodically by evaluating the link quality. If the link quality is unchanged the algorithm keeps the current antenna until the next evaluation. This mainly addresses multipath fading when the conditions change slowly and makes fixed installations less critical for optimum placement.

For optimal efficiency, it is advisable to separate the diversity antennas by at least $\frac{1}{4}$ wavelength and preferably $\frac{1}{2}$ of one wavelength. To achieve further minimum antenna correlation, it is beneficial to implement orthogonal polarization of the antennas.

The Infineon BGS12WN6 is as an example of an external antenna switch with up to 9 GHz operating frequency and a single control pin. The circuit of a typical antenna diversity implementation is shown in [Figure 7](#).

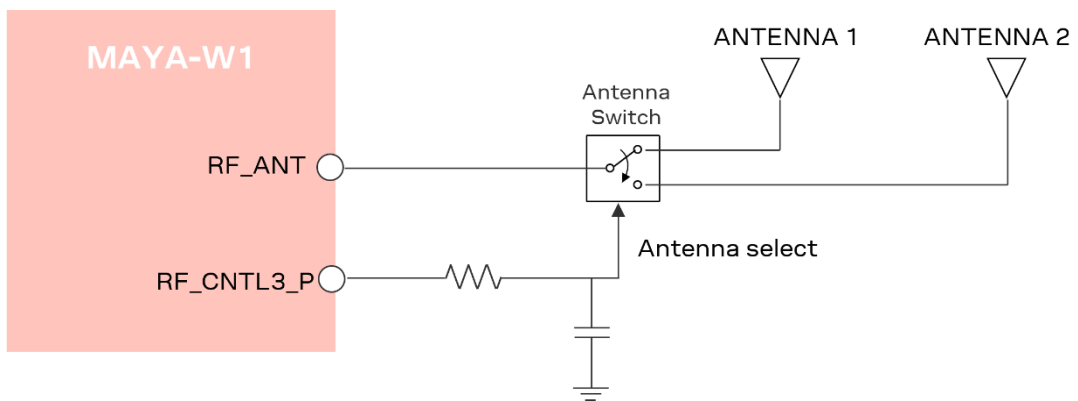

Figure 7: Typical implementation of antenna diversity

2.4 System function interfaces

2.4.1 Power-up sequence

Figure 8 shows two power-up sequences recommended for MAYA-W1 series module. During the power up of MAYA-W1 series modules, **3V3** shall be enabled first together with or followed by **VIO**. **VIO_SD** shall be supplied shortly thereafter, and later followed by **1V8**.

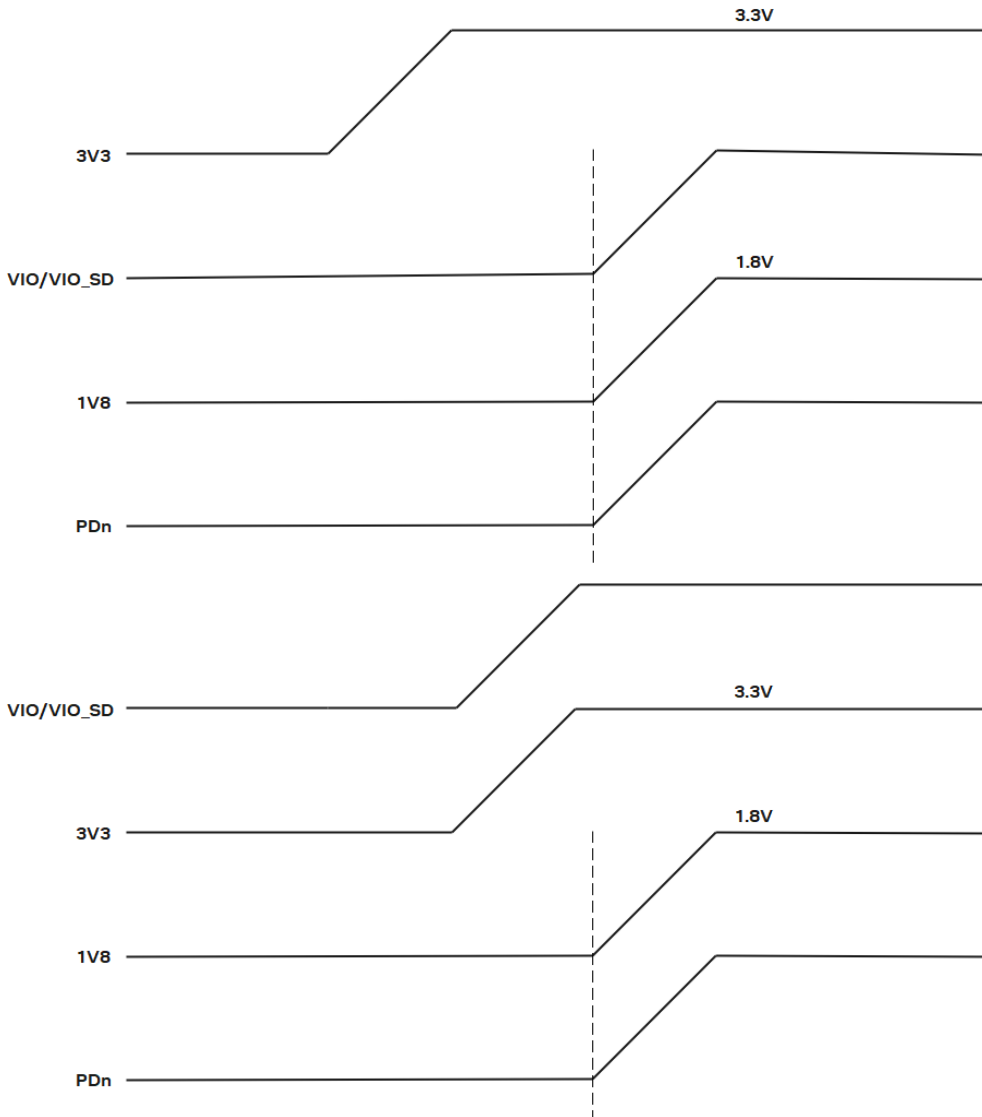

Figure 8: MAYA-W1 power sequencing

In both recommended sequences, **PDn** is ideally held low during start up and released when the power is stable, or later when the module must be turned on. **PDn** is powered by the **1V8** voltage domain and is connected through a 10 k Ω pull up resistor to **1V8**.

Optionally, the **PDn** pad can be left unconnected so that it follows **1V8** through the pull up resistor. In which case, the power down mode is not accessible and a further full-power cycle must be made to reset the module.

During the power sequence, the internal DC/DC converter that is sourced from **3V3** must start-up before **1V8** and **PDn** are applied. This takes up to 1.15 ms until the internal **VPA** has stabilized.



Power down mode can only be entered through **PDn** assertion by the host. **PDn** must be asserted for a minimum of 100 ms for correct reset.

2.4.2 Reset

Although external reset is not a prerequisite for correct operation, it can be asserted by the host controller through **PDn** in the event of any abnormal module behavior.

MAYA-W1 series modules are reset to a default operating state by any of the following events:

- Power on: Module is powered on and internal voltages are good
- **PDn** assert: The device is reset when the **PDn** input pin is < 0.5 V and transitions from low to high



A firmware download to the module is required after each reset. For information about downloading the firmware, see also [Software](#).



Optional independent software reset for the WLAN and Bluetooth subsystems is provided through the **WLAN_RESET** and **BT_RESET** pins, respectively. The pins can be left open if they are not needed.

2.4.3 Power-off sequence

MAYA-W1 modules enter **Power Down** mode when **PDn** is asserted. After assertion, the power on the **3V3**, **1V8**, **VIO**, and **VIO_SD** supplies can be removed and the module enters the **Power Off** mode.

2.4.4 Wake-up signals

MAYA-W1 series modules provide wake-up input and output signals that handle the low-power modes for both Wi-Fi and Bluetooth. See also [Power states](#).

The wake-up signals are used to exit MAYA-W1 or Host CPU from sleep modes. Wake-up signals are powered by the **VIO** voltage domain. **WLAN_DEV_WAKE** and **BT_DEV_WAKE** are optional, out-of-band, wake-up pins that are used to wake up the transceiver from sleep mode.

Name	I/O	Description
WLAN_DEV_WAKE	I/O	Host to Wi-Fi Module wake-up signal (input) / GPIO[13]
WLAN_WAKE_HOST	I/O	Wi-Fi Module to Host wake-up signal (output) / GPIO[1] Used as configuration pin, see also Configuration pins .
BT_DEV_WAKE	I/O	Host to Bluetooth Module wake-up signal (input) / GPIO[12]
BT_WAKE_HOST	I/O	Bluetooth Module to Host wake-up signal (output) / GPIO[0] Alternatively, PCM_DOUT/GPIO[4] can be used as host wake-up signal.

Table 5: Wake-up signal definitions

2.4.5 Configuration pins

MAYA-W1 series modules have configuration pins to set specific interface configuration and other reserved functions following a reset. The function of these configuration pins changes immediately (~1 ms) to their initial function after reset, as shown in [Table 6](#).

Configuration pins CON[1:0] are used to set the firmware boot options that subsequently select the interfaces according to table 7.

Configuration pins CON[5,9] are reserved and must be set according to the settings described in [Table 6](#).

Default state is logic high, “1”, unless otherwise stated, and no external circuitry or pull-up resistor is required to set high. To set a configuration pin to low, “0” a 51 kΩ pull-down resistor connected to GND shall be included, [Table 6](#).

If a configuration pin is used for another function, it is important that the state during boot is according to boot-up definition. In certain applications a pull-up resistor might be needed to achieve this. In this case, a value of 100 kohm or higher is recommended. Do not connect directly to supply voltage.

Configuration bits	Pin name	Pin number	Configuration settings		
CON[9]	WLAN_WAKE_HOST	F7	Reserved set to 1		
CON[8]	UART_RTSn	H9	Reserved set to 1		
CON[7]	UART_CTSn	H8	Reserved set to 1		
CON[5]	RF_CNTL3_P	F3	Reserved set to 1		
Firmware boot options					
CON[1:0]	CONFIG[1:0]	CONFIG[1]: E3 CONFIG[0]: D3	Strap value	Wi-Fi	Bluetooth
			10	SDIO	UART
			Others	Reserved	Reserved

Table 6: Configuration pins

2.4.6 Sleep clock

An optional external low power oscillator (LPO) for lower power operation in sleep mode can be connected to the **SLP_CLK_IN** pin. The external LPO must meet the requirements described in [Table 8](#).

Name	I/O	Description	Remarks
SLP_CLK_IN	I	32.768 kHz sleep clock input	If no external sleep clock is used, leave this pin unconnected.

Table 7: External sleep clock signal description

Parameter	LPO clock	Unit
Nominal input frequency	32.768	kHz
Frequency accuracy	±250	ppm
Phase noise (@ 100 kHz)	-125	dBc/Hz
Cycle jitter	1.5	ns (RMS)
Slew rate limit (10-90%)	< 100	ns
Duty cycle tolerance	20 – 80	%

Table 8: External sleep clock specification

 Frequency accuracy includes temperature and aging characteristics.

2.4.7 Power states

MAYA-W1 series modules have several operation states. The power states and general guidelines for Wi-Fi and Bluetooth operations are defined in [Table 9](#).

General status	Power state	Description
Power-down	Not Powered	3V3 , 1V8 , VIO , and VIO_SD supplies not present or below the operating range. The module is switched off.
	Power Down	Asserting PDn while 3V3 , 1V8 , VIO , and VIO_SD supplies are present powers down the module. This represents the lowest leakage mode of operation with active voltage rails. Register and memory states are not maintained in power-down mode. The module is automatically reset after exiting power-down mode, which means that the firmware must be downloaded again. If firmware is not downloaded, the device must be kept in its power-down state to reduce the leakage.
Normal operation	Active	Enables TX/RX data connection with the system running at the specified power consumption.

General status	Power state	Description
	Deep sleep	Low-power state used in the sleep state of many power-save modes. Memory is placed in low-power retention mode.

Table 9: Description of module power states

2.5 Host interfaces

MAYA-W1 series modules support SDIO 3.0 and high-speed UART host interfaces. This means that all Wi-Fi traffic is communicated through SDIO. By setting the appropriate boot option, the high-speed UART interface between the host and the MAYA-W1 module is configured for the Bluetooth traffic. For information about the configuration options for the host interface, see also [Configuration pins](#).

2.5.1 SDIO 3.0 interface

MAYA-W1 series modules include a SDIO device interface that is compatible with the industry-standard SDIO 3.0 specification with a clock range of up to 100 MHz. The host controller uses the SDIO bus protocol to access the Wi-Fi function. The interface supports 4-bit SDIO transfer mode with data rates up to 50 MB/s in SDR50 or DDR50 modes. The modules also support the legacy modes, Default Speed (DS) and High-Speed (HS).

 The SDIO interface voltage is set by **VIO_SD** to either 1.8 V or 3.3 V.

MAYA-W1 modules act as devices on the SDIO bus. [Table 10](#) summarizes the supported bus speed modes.

Bus speed mode	Max. bus speed [MB/s]	Max. clock frequency [MHz]	VIO_SD / Signal voltage [V]
SDR50	50	100	1.8
DDR50	50	50	1.8
SDR25	25	50	1.8
SDR12	12.5	25	1.8
HS: High-Speed	25	50	3.3
DS: Default Speed	12.5	25	3.3

Table 10: SDIO bus speeds

MAYA includes internal 90 kΩ pull-up resistors on the SDIO signals. Depending on the routing and trace impedance of the SDIO lines, it is recommended to connect pull-up and in-series termination resistors to these lines. See also [Data communication interfaces](#).

Name	I/O	Description	Remarks
SD_CLK	I	SDIO Clock input	
SD_CMD	I/O	SDIO Command line	External PU required
SD_DAT[3:0]	I/O	SDIO Data line bits [3:0]	External PU required

Table 11: SDIO signal definitions

SDIO interface pins are powered by the **VIO_SD** voltage domain.

2.5.2 High-speed UART interface

MAYA-W1 series modules support a high-speed Universal Asynchronous Receiver/Transmitter (UART) interface in compliance with the industry standard 16550 specification.

The main features of the UART interface include:

- FIFO mode permanently selected for transmit and receive operations
- Two pins for transmit and receive operations
- Two flow control pins (**RTS/CTS**)
- Interrupt triggers for low-power, high-throughput operation
- Supports standard baud rates and high throughput up to 4 Mbps.

The UART interface operation includes:

- Bluetooth firmware upload to the module
- Bluetooth data

Name	I/O	Description	Remarks
UART_SOUT	O	UART TX signal	Connect to Host RX
UART_SIN	I	UART RX signal	Connect to Host TX
UART_RTSn	O	UART RTS signal	Connect to Host CTS. Used as configuration pin. See also Configuration pins .
UART_CTSn	I	UART CTS signal	Connect to Host RTS. Used as configuration pin. See also Configuration pins .

Table 12: UART signal description

High-Speed UART signals are powered by the **VIO** voltage domain.

2.5.3 PCM/I2S - Audio interface

MAYA-W1 series modules include a bi-directional 4-wire PCM digital audio interface for digital audio communication with external digital audio devices like an audio codec.

The interface supports:

- PCM master or slave mode
- PCM bit width size of 8 bits or 16 bits
- Up to four PCM slots with configurable bit width and start positions
- PCM short frame and long frame synchronization
- I2S master and slave modes for I2S, MSB, and LSB audio interfaces



PCM pins are shared with the I2S interface and can be configured to I2S mode using HCI commands.

Name	I/O	Description	Remarks
PCM_CLK	I/O	PCM clock. Alternate function: I2S clock	Master output. Slave input.
PCM_MCLK	O	PCM Master clock	Optional clock used by some codecs
PCM_SYNC	I/O	PCM frame sync. Alternate function: I2S word select	Master output. Slave input.
PCM_DIN	I	PCM data in. Alternate function: I2S data in	
PCM_DOUT	O	PCM data out. Alternate function: I2S data out	

Table 13: PCM digital audio signal descriptions

PCM/I2S signals are powered by the **VIO** voltage domain.

2.6 Other remarks

2.6.1 Unused pins

MAYA-W1 series modules have unconnected (NC) pins that are reserved for future use. These pins must be left unconnected on the application board.

2.6.2 GPIO usage

GPIOs are used to connect MAYA-W1 to various external devices. [Table 14](#) shows the typical assignments for some of the GPIO pins. Other GPIO signals, described in , have not yet been assigned by the chip manufacturer. The exact function of these signals is normally dependent on the firmware releases.

GPIO	Module pin	Function
GPIO[0]	BT_WAKE_HOST	Bluetooth to host wake-up signal Can also be used to indicate the sleep mode of the module. Put to test point for debug purpose.
GPIO[1]	WLAN_WAKE_HOST	Wi-Fi to host wake-up signal. Used as configuration pin. See also Configuration pins
GPIO[4]	PCM_DOUT	PCM data out or optional Bluetooth to host wake-up signal
GPIO[12]	BT_DEV_WAKE	Host to Bluetooth Module wake-up signal
GPIO[13]	WLAN_DEV_WAKE	Host to Wi-Fi Module wake-up signal
GPIO[14]	WLAN_RESET	Wi-Fi independent reset
GPIO[15]	BT_RESET	Bluetooth independent reset

Table 14: Assigned GPIO functions

3 Design-in

Follow the design guidelines stated in this chapter to optimize the integration of MAYA-W1 series modules in the final application board.

3.1 Overview

Although all application circuits must be properly designed, several aspects of the application design require special attention. A list of these points, in order of importance, follow:

- Module antenna connection:
 - **RF_ANT0** and **RF_ANT1** pins for MAYA-W161 and U.FL connectors for MAYA-W160, and **RF_ANT1** for MAYA-W166-01B:
Antenna circuits affect the RF compliance of all applications that include the certification schemes supported by MAYA-W1 modules. To maintain compliance and subsequent certification of the application design, it is important to observe the applicable parts of antenna schematic and layout design described in [Antenna interfaces](#).
 - Internal antenna, MAYA-W166-00B:
It is important to place the module on the main PCB such that the internal antenna is aligned with an outer edge of the main PCB. No GND plane or traces must be routed on any layer underneath the antenna part of the module.
- Module supply: **3V3**, **1V8**, **VIO_SD**, **VIO**, and **GND** pins.
Supply circuits can affect the RF performance. It is important to observe the schematic and layout design for these supplies. See also [Supply interfaces](#).
- High-speed interfaces: **SDIO**, high-speed **UART** pins, and **PCM**.
High-speed interfaces are a potential source of radiated noise that can affect the regulatory compliance standards for radiated emissions. It is important to follow the schematic and layout design recommendations described in [SDIO 3.0 interface](#) and the [General high-speed layout guidelines](#).
- System functions: **PDn** and [Configuration pins](#).
Careful utilization of these pins in the application design is required to guarantee that the voltage level is correctly defined during module boot. It is important to follow the pin design described in the [General high-speed layout guidelines](#).
- Other pins: Specific signals and NC pins.
Careful utilization of these pins is required to guarantee proper functionality. It is important to follow the schematic and design layout recommendations described in the [General high-speed layout guidelines](#).

3.2 RF interface options

MAYA-W1 modules provide several RF interface options for connecting external antennas:

- MAYA-W160/MAYA-W161/MAYA-W166-01B
 - MAYA-W160 includes U.FL connectors for **RF_ANT0** and **RF_ANT1**, whereas MAYA-W161 includes pads for these signals:
 - **RF_ANT0** for Wi-Fi 2.4 and 5 GHz connectivity
 - **RF_ANT1** for Bluetooth connectivity
 - MAYA-W166-01B includes a **RF_ANT1** pad for combined Bluetooth and Wi-Fi.
 - The **RF_ANT** ports have a nominal characteristic impedance of 50 Ω . For correct impedance matching these ports must be connected to the respective antenna through a 50 Ω U.FL connector and coax or a transmission line – depending on the type of module connector. Poor termination of **RF_ANT** pins can result in degraded performance of the module.

- Follow the requirements described in [Table 15](#) and [Table 16](#) to optimize the isolation between the antennas and ensure good application performance.
- MAYA-W166-00B
 - MAYA-W166-00B includes an embedded antenna, which for optimal performance requires the module to be placed on the edge of the host PCB with the “antenna side” closest to the edge.

 According to FCC regulations, the transmission line from the module antenna pin to the physical antenna (or antenna connector on the host PCB) is considered part of the approved antenna design. Therefore, module integrators must use exactly the antenna reference design used in the module FCC type approval or certify their own design.

For instructions on how to design circuits that comply with these requirements, see also [Antenna interfaces](#).

3.2.1 Antenna design

To optimize the radiated performance of the final product, the selection and placement of both the module and antenna must be chosen with due regard to the mechanical structure and electrical design of the product. To avoid later redesigns, it is important to decide the positioning of these components at an early phase of the product design

The compliance and subsequent certification of the RF design depends heavily on the radiating performance of the antennas.

To ensure that the RF certification of MAYA-W1 modules is extended through to the application design, carefully follow the guidelines outlined below.

- External antennas, including, linear monopole classes:
 - Place the module and antenna in any convenient area on the board. External antennas do not impose any restriction on where the module is placed on the PCB.
 - Select antennas with an optimal radiating performance in the operating bands. The radiation performance depends mainly on the antennas.
 - Choose RF cables that offer minimum insertion loss. Unnecessary insertion loss is introduced by low quality or long cables. Large insertion losses reduce radiation performance.
 - Use a high-quality 50 Ω coaxial connector for proper PCB-to-RF-cable transition.
- Integrated antennas, such as patch-like antennas:
 - Internal integrated antennas impose some physical restrictions on the PCB design:
 - Integrated antennas excite RF currents on its counterpoise, typically the PCB ground plane of the device that becomes part of the antenna; its dimension defines the minimum frequency that can be radiated. Therefore, the ground plane can be reduced to a minimum size that should be similar to the quarter of the wavelength of the minimum frequency that has to be radiated, given that the orientation of the ground plane related to the antenna element must be considered.
 - Find a numerical example to estimate the physical restrictions on a PCB, where:
Frequency = 2.4 GHz → Wavelength = 12.5 cm → Quarter wavelength = 3.5 cm in free space or 1.5 cm on a FR4 substrate PCB.
- Choose antennas with optimal radiating performance in the operating bands. Radiation performance depends on the complete product and antenna system design, including the mechanical design and usage of the product. [Table 15](#) summarizes the requirements for the antenna RF interface.
- Make the RF isolation between the system antennas as high as possible, and the correlation between the 3D radiation patterns of the two antennas as low as possible. In general, RF separation of at least a quarter wavelength between the two antennas is required to achieve a minimum isolation and low pattern correlation. If possible, increase the separation to maximize the performance and fulfill the requirements in [Table 16](#).

Item	Requirements	Remarks
Impedance	50 Ω nominal characteristic impedance	The impedance of the antenna RF connection must match the 50 Ω impedance of Antenna pins.
Frequency Range	2400 - 2500 MHz 5150 - 5850 MHz	For 802.11b/g/n/ax and Bluetooth. For 802.11a/n/ac/ax.
Return Loss	S11 < -10 dB (VSWR < 2:1) recommended S11 < -6 dB (VSWR < 3:1) acceptable	The Return loss or the S11, as the VSWR, refers to the amount of reflected power, measuring how well the primary antenna RF connection matches the 50 Ω characteristic impedance of antenna pins. The impedance of the antenna termination must match as much as possible the 50 Ω nominal impedance of antenna pins over the operating frequency range, to maximize the amount of power transferred to the antenna.
Efficiency	> -1.5 dB (> 70%) recommended > -3.0 dB (> 50%) acceptable	Radiation efficiency is the ratio of the radiated power to the power fed to the antenna input: the efficiency is a measure of how well an antenna receives or transmits.
Maximum Gain		To comply with regulatory agencies radiation exposure limits the maximum antenna gain must not exceed the value specified in type approval documentation.

Table 15: Summary of antenna interface requirements

Table 16 specifies additional requirements for implementing a dual antenna design.

Item	Requirements	Remarks
Isolation (in-band)	S21 > 30 dB recommended	The antenna-to-antenna isolation is the S21 parameter between the two antennas in the band of operation. Lower isolation might be acceptable depending on use-case scenario and performance requirements.
Isolation (out-of-band)	S21 > 35 dB recommended S21 > 30 dB acceptable	Out-of-band isolation is evaluated in the band of the aggressor. This ensures that the transmitting signal from the other radio is sufficiently attenuated by the receiving antenna. It also avoids any saturation and intermodulation effect on the receiver port.
Envelope Correlation Coefficient (ECC)	ECC < 0.1 recommended ECC < 0.5 acceptable	The ECC parameter correlates the far field parameters between antennas in the same system. A low ECC parameter is fundamental in improving the performance of MIMO-based systems.

Table 16: Summary of Wi-Fi/Bluetooth coexistence requirements

 When operating dual antennas in the same 2.4 GHz band, sufficient isolation is critical for attaining an optimal throughput performance in Wi-Fi/Bluetooth coexistence mode.

Select antennas that provide:

- Optimal return loss (or VSWR) over all the operating frequencies.
- Optimal efficiency figure over all the operating frequencies.
- An appropriate gain that does not exceed the regulatory limits specified in some regulatory country authorities like the FCC in the United States.

A useful approach for the antenna micro-strip design is to place an U.FL connector close to the embedded PCB or chip antenna. The U.FL connector only needs to be mounted on units used for verification.

3.2.1.1 Integrated antenna design

If integrated antennas are used, the transmission line is terminated by the antennas themselves or by the antenna together with the connected coaxial cable and U.FL plug.

Consider the following the guidelines when designing the antenna:

- The antenna design process should commence at the same time as the mechanical design of the product. PCB mock-ups are useful in estimating overall efficiency and radiation path of the intended design during early development stages.
- Use antennas designed by an antenna manufacturer that provide the best possible return loss (or VSWR).
- Provide a ground plane large enough according to the related integrated antenna requirements. The ground plane of the application PCB may be reduced to a minimum size that must be similar to one quarter of wavelength of the minimum frequency that has to be radiated. The overall antenna efficiency may benefit from larger ground planes.
- Proper placement of the antenna and its surroundings is also critical for antenna performance. Avoid placing the antenna close to conductive or RF-absorbing parts, such as metal objects or ferrite sheets, as these may absorb part of the radiated power, shift the resonant antenna frequency of the antenna, or otherwise affect the antenna radiation pattern.
- Ensure that correct the installation and deployment of the antenna system, including PCB layout and matching circuitry, is done correctly. In this regard, it is recommended that you strictly follow the specific guidelines provided by the antenna manufacturer.
- Further to the custom PCB and product restrictions, antennas may also require tuning/matching to reach the target performance. It is recommended that you plan measurement and validation activities with the antenna manufacturer before releasing the end-product to manufacturing.
- The receiver section may be affected by noise sources like hi-speed digital busses. Avoid placing the antenna close to busses as DDR. Otherwise, consider taking specific countermeasures, like metal shields or ferrite sheets, to reduce the interference.
- Be aware of interaction between co-located RF systems, like LTE sidebands on 2.4 GHz band. Transmitted power may interact or disturb the performance of MAYA-W1 modules where specific LTE filter is not present.

3.2.1.2 RF transmission line design

RF transmission lines, such as those that connect from **RF_ANT** pins to their related antenna connectors or antenna, must be designed with a characteristic impedance of 50 Ω .

Figure 9 shows the design options for implementing a transmission line, namely:

- Microstrip – track separated with dielectric material and coupled to a single ground plane.
- Coplanar microstrip – track separated with dielectric material and coupled to both the ground plane and side conductor. This is the most common transmission line implementation.
- Stripline – track separated by dielectric material and sandwiched between two parallel ground planes.

The parameters shown in the cross-sectional area of each trace design include:

- Width (W) – shows the width of the copper layer on the top layer
- Distance (S) – shows the distance between the top copper layer and the two adjacent GND planes.
- Dielectric substrate thickness (H) – shows the distance between the GND reference on the bottom plane and the copper layer on the top layer.
- Thickness of the copper layer (T) – can also be represented by “Base Copper Weight”, which is commonly used as the parameter for PCB stack-up.
- Dielectric constant (ϵ_r) defines the ratio between the electric permeability of the material against the electric permeability of free space.



The width of a 50 Ω microstrip depends on “ ϵ_r ” and “H”, which must be calculated for each PCB layer stack-up.

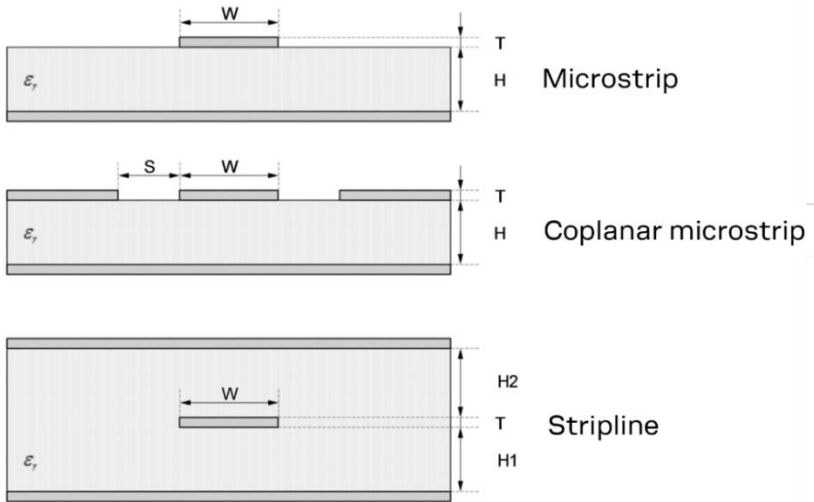

Figure 9: Transmission line trace design

Follow these recommendations to design a 50 Ω transmission line correctly:

- Designers must provide enough clearance from surrounding traces and ground in the same layer. In general, the trace to ground clearance should be at least twice that of the trace width. The transmission line should also be “guarded” by the ground plane area on each side.
- In the first iteration, calculate the characteristic impedance using tools provided by the layout software. Ask the PCB manufacturer to provide the final values usually calculated using dedicated software and production stack-ups. It is sometimes possible to request an impedance test coupon on side of the panel to measure the real impedance of the traces.
- Although FR-4 dielectric material can result in high losses at high frequencies, it can still be an appropriate choice for RF designs. In which case, aim to:
 - Minimize RF trace lengths to reduce dielectric losses.
 - If traces longer than few centimeters are needed, use a coaxial connector and cable to reduce losses.
 - For good impedance control over the PCB manufacturing process, design the stack-up with wide 50 Ω traces with width of at least 200 μm .
 - Contact the PCB manufacturer for specific tolerance of controlled impedance traces. As FR-4 material exhibits poor thickness stability it gives less control of impedance over the trace width.
- For PCBs with components larger than 0402 and dielectric thickness below 200 μm , add a keep-out, that is, some clearance (void area) on the ground reference layer below any pin on the RF transmission lines. This helps to reduce the parasitic capacitance to ground.
- Route RF lines in 45 $^\circ$ angle and avoid acute angles. The transmission lines width and spacing to GND must be uniform and routed as smoothly as possible.
- Add GND stitching vias around transmission lines.
- Provide a sufficient number of vias on the adjacent metal layer. Include a solid metal connection between the adjacent metal layer on the PCB stack-up to the main ground layer.
- To avoid crosstalk between RF traces and Hi-impedance or analog signals, route RF transmission lines as far from noise sources (like switching supplies and digital lines) and any other sensitive circuit.
- Avoid stubs on the transmission lines. Any component on the transmission line should be placed with the connected pin located over the trace. Also avoid any unnecessary components on RF traces.

Figure 10 shows a trace and ground design example. From top left to bottom right: layer 1 mirrored, layer 1, layer 2, layer 3, layer 4, and so on.



Figure 10: RF trace and ground design example

Figure 11 shows typical artwork implementing a coplanar microstrip on an 8-layer PCB. The trace includes, from the module pad to the PCB edge, the (module-side) coplanar microstrip section, RF connector with switch (optional), impedance matching PI network, (SMA-side) coplanar microstrip section (2), and edge mounted SMA RF connector. The ground clearance on L2 and L3 allows for a wider microstrip, which is less lossy than a narrow one. The ground clearance is especially critical in the 5 GHz band. A wider trace also has less impedance variation over PCB production batches due to the absolute tolerances in the PCB etching process.

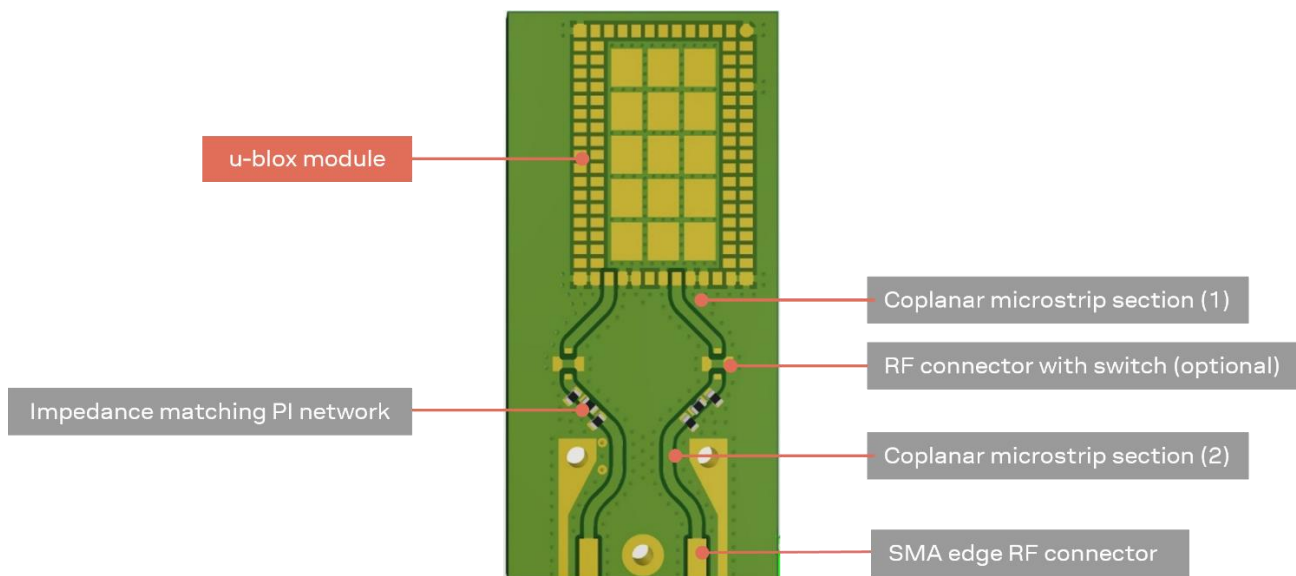

Figure 11: Layout example showing implementation

Figure 12 shows layout of pads for U.FL connector. Consider especially the GND clearance under the signal pad.

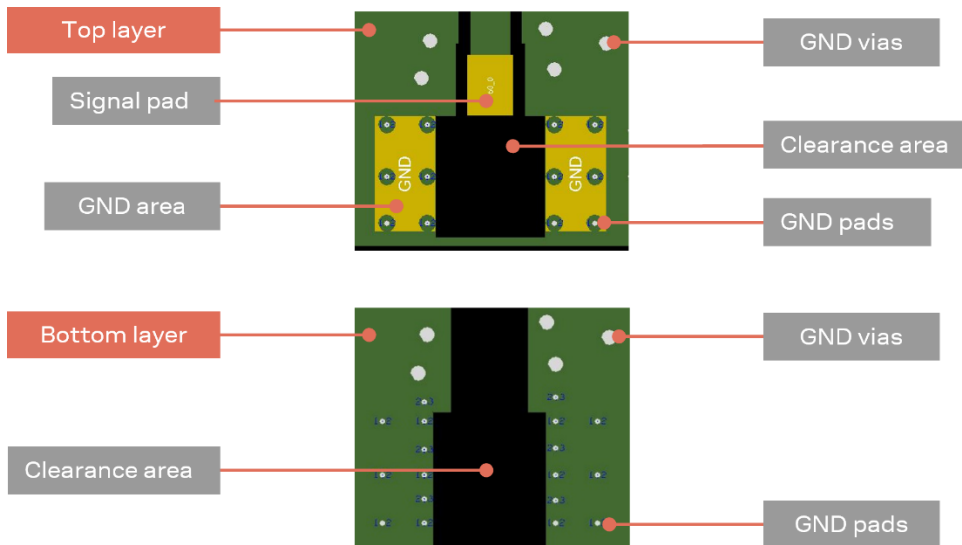

Figure 12: U.FL connector layout, top layer to the left and inner layer 1 to the right

3.3 Supply interfaces

3.3.1 Module supply design

Although the GND pins are internally connected, it is advisable to connect all available ground pins on the application board to solid ground with a good (low impedance) connection to external ground. This minimizes power loss, improves RF performance, and better thermal performance.

Good connection of the module supply pins, supplied by a DC supply source, is required for accurate RF performance.

Consider the following guidelines when developing the schematic:

- All power supply pins must be connected to an appropriate DC source.
- Any series component with an Equivalent Series Resistance (ESR) greater than a few $m\Omega$ should be avoided. The only exception to this general rule is the use of ferrite beads for DC filtering. To avoid possible instability in the DC supply, only use ferrite beads if needed.
- For high-frequency filtering, additional bypass capacitors in the range of 100 nF to 1 μ F are required on all supply pins. Offering low ESR/ESL resistance, a class II ceramic capacitor with an X7R or X5R dielectric is well suited for this purpose. Bypass capacitors of a smaller size can be chosen to minimize ESL (Equivalent Series Inductance) in the manufacturing process. The capacitor should be placed as close as possible to the module supply pin.
- To help filter current spikes from the RF section and avoid ground bounce, a minimum bulk capacitance of 10 μ F should be applied to the **1V8** and **3V3** rails (optionally on **VIO_SD** and **VIO**) and placed close to the module supply pins. Offering low ESR/ESL resistance, a class II ceramic capacitor with an X7R or X5R dielectric is well suited for this purpose. Special care should be taken in the selection of X5R/X7R dielectrics due to capacitance derating versus DC bias voltage.

3.3.1.1 Guidelines for supply circuit design using an SMPS

A Switched Mode Power Supply (SMPS) is generally recommended for converting the main supply to the module supply when the voltage difference is relatively high. In these circumstances, the use of an SMPS dissipate less power and subsequently generates less power dissipation and heat than an LDO. By contrast, an LDO is generally simpler to use and does not generate the amount of noise an SMPS might.

The characteristics of the SMPS should meet the following prerequisites to comply with the module requirements described in [Table 2](#).

- **Power capability:** The regulator, together with any additional filter in front of the module, must be capable of providing a voltage within the specified operating range. It must also be capable of delivering the specified peak current.
- **Low output ripple:** The peak-to-peak ripple voltage of the switching regulator must not exceed the specified limits. This requirement is applicable to both the voltage ripple generated by the SMPS at operating frequency and the high-frequency noise generated by power switching.
- **PWM/PFM mode operation:** It is advisable to select regulators that support a fixed Pulse Width Modulation (PWM) mode. Pulse Frequency Modulation (PFM) mode typically exhibits higher ripple and can affect RF performance. If power consumption is not a primary concern, PFM/PWM mode transitions should be avoided in favor of fixed PWM operation to reduce the peak-to-peak noise on voltage rails. Switching regulators with mixed PWM/PFM mode can be used provided that the PFM/PWM modes and transition between modes complies with the requirements.

3.3.1.2 Guidelines for supply circuit design using a LDO linear regulator

The use of a linear regulator is appropriate when the difference between the available supply rail and the module supply is relatively low. Linear regulators can also be considered for powering 1.8 V domains – particularly those having low current requirements and those cascaded from an SMPS-generated low voltage rail.

The characteristics of the Low Drop-Out (LDO) linear regulator used to power the voltage rails must meet the following prerequisites to comply with the requirements summarized in [Table 2](#).

- **Power capabilities:** The LDO linear regulator must be able to provide a voltage within the specified operating range. It must also be capable of withstanding and delivering the maximum specified peak current while in “connected mode”.
- **Power dissipation:** The power handling capability of the LDO linear regulator must be checked to limit its junction temperature to the maximum rated operating range. The worst-case junction temperature can be estimated as shown below:

$$T_{j,est} = (V_{in} - V_{out}) * I_{avg} * \theta_{ja} + T_a$$

Where: θ_{ja} is the junction-to-ambient thermal resistance of the LDO package³, I_{avg} is the current consumption of the given voltage rail in continuous TX/RX mode and T_a is the maximum operating temperature of the end product inside the housing.

3.4 Data communication interfaces

3.4.1 SDIO 3.0

The SDIO 3.0 bus in MAYA-W1 series modules can support a clock frequency up to 100 MHz, which means that special care must be taken to guarantee signal integrity and minimize electromagnetic interference (EMI) issues. The signals should be routed with a single-ended impedance of 50 Ω.

³ Thermal dissipation capability reported on datasheets is usually tested on a reference board with adequate copper area (see also JESD51 [10]). Junction temperature on a typical PCB can be higher than the estimated value due to the limited space to dissipate the heat. Thermal reliefs on pads also affect the capability of a device to dissipate heat.

It is advisable to route all signals in the bus so that they have the same length and the appropriate grounding in the surrounding layers. The total bus length should be kept to a minimum. To minimize crosstalk with other parts of the circuit, the layout of the SDIO bus should be designed with adequate isolation between the signals, clock, and surrounding busses/traces.

Implement an uninterrupted return-current path in close vicinity to the signal traces. Figure 13 shows an optional application schematic for the SDIO bus in MAYA-W1, while Table 17 summarizes the electrical requirements of the bus. Even though MAYA-W1 includes on chip Pull-up resistors it is advisable to add external ones for optimum pull-up to match routing and host CPU impedance.

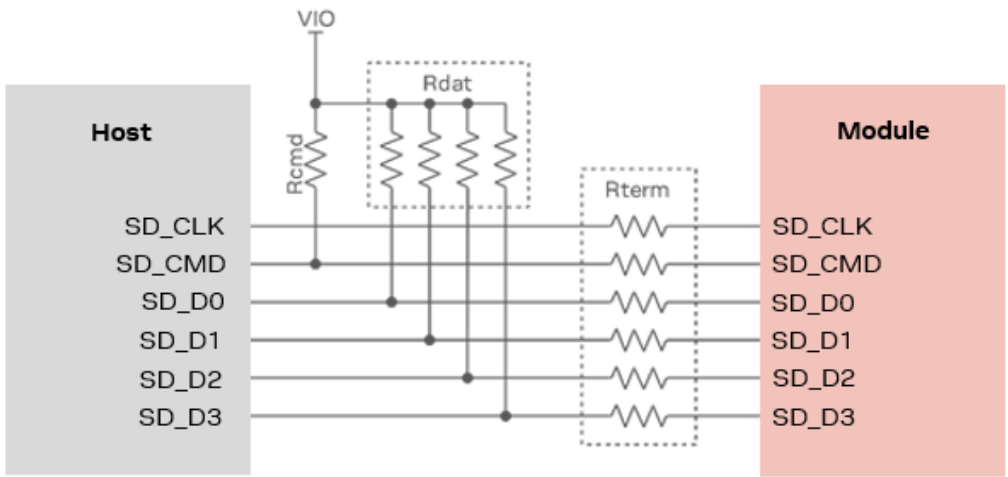

Figure 13: SDIO application schematic

A small value capacitor in the range of a few pF to GND could be considered for SDIO_CLK as an EMI debug option and signal termination. This capacitor should be placed as close as possible to the MAYA-W1 clock input pin and can be assembled only for EMI purpose. The capacitor value adds to total line capacitance and must not exceed total allowed capacitance to avoid violating clock rise and fall timing specifications.

Signal group	Parameter	Min.	Typ.	Max.	Unit
CLK, CMD, DAT[0:3]	Single ended impedance, Z_0		50		Ω
CLK, CMD, DAT[0:3]	Impedance control	$Z_0 - 10\%$	Z_0	$Z_0 + 10\%$	Ω
DAT[0:3]	Pull-Up range, Rdat	10	47	100	k Ω
CMD	Pull-Up range, Rcmd	10	10	50	k Ω
CLK, CMD, DAT[0:3]	Series termination (Host side), Rterm ⁴	0	0		Ω
CLK, CMD, DAT[0:3]	Bus length ⁵			100	mm
CMD, DAT[0:3]	Bus skew length mismatch to CLK	-3		+3	mm
CLK	Center to center CLK to other SDIO signals ⁶	4*W			
CMD, DAT[0:3]	Center to center between signals ¹¹	3*W			

Table 17: SDIO bus requirements

⁴ Series termination values larger than typical recommended only for addressing EMI issues

⁵ Routing should minimize the total bus length.

⁶ To accommodate BGA escape, center-to-center spacing requirements can be ignored for up to 10 mm of routed length.

3.4.2 High-speed UART interface

The high-speed UART interface for the MAYA-W1 complies with the HCI UART Transport layer and uses the settings shown in [Table 18](#).

UART Settings	
Baud rate default after reset	115 200 baud
Baud rate default after firmware load	3 000 000 baud
Data bits	8
Parity bit	No parity
Stop bit	1 stop bit
Flow Control	RTS/CTS

Table 18: HCI UART transport layer settings

RTS/CTS flow control is used to prevent temporary UART buffer overrun.

- If CTS is 1 the host UART controller is allowed to send.
- If CTS is 0 the host UART controller is not allowed to send.



The use of hardware flow control with RTS/CTS is mandatory.

Baud rate				
1200	38400	460800	1500000	3000000
2400	57600	500000	1843200	
4800	76800	921600	2000000	
9600	115200	1000000	2100000	
19200	230400	1382400	2764800	

Table 19: Possible baud rates for the UART interface

After a hardware reset, the UART interface is configured for 115 200 baud without flow control. After loading the firmware, the baud rate is set to 3 000 000 baud and flow control is enabled. A host application can configure the desired baud rate for the UART interface with the vendor specific HCI command `HCI_CMD_MARVELL_UART_BAUD`.

HCI command syntax using `hcitool`:

```
hcitool -i hci0 cmd 0x3F 0x0009 <4-byte value for baud rate>
```

In the following example, the baud rate is set to 3 000 000 baud.

```
$ hcitool -i hci0 cmd 0x3F 0x0009 0xC0 0xC6 0x2D 0x00
< HCI Command: ogf 0x3f, ocf 0x0009, plen 4
  C0 C6 2D 00
> HCI Event: 0x0e plen 4
  01 7A 0C 00
```

The command complete event is transmitted to the host at the old baud rate. Once the host receives it, it can switch to the new baud rate and should wait for 5 ms or more before sending the next command.

3.5 Other interfaces and notes

All pins have internal keeper resistors; leave un-used pins open.

3.6 General high-speed layout guidelines

These guidelines describe best practices for the layout of all high-speed busses on MAYA-W1. Designers should prioritize the layout of higher speed busses. Low frequency signals, other than those with high-impedance traces, are generally not critical to the layout.

- ⚠ Low frequency signals with high-impedance traces (such as signals driven by weak pull resistors) may be affected by crosstalk. For these high impedance traces, a supplementary isolation of $4*W$ from other busses is recommended.

3.6.1 General considerations for schematic design and PCB floor planning

- Verify which signal bus requires termination and add appropriate series resistor terminations to the schematics.
- Carefully consider the placement of the module with respect to the antenna position and host processor; minimize RF trace length first and then the SDIO bus length.
- SDIO bus routing must aim to keep layer-to-layer transition to a minimum.
- Verify the allowable stack-ups, and the controlled impedance dimensioning for antenna traces and busses, with the PCB manufacturer.
- Verify that the power supply design and power sequence are compliant with the MAYA-W1 specifications described in [System function interfaces](#).

3.6.2 Component placement

- Accessory parts like bypass capacitors must be placed as close as possible to the module to improve filtering capability. Prioritize placing the smallest capacitors close to module pins.
- Do not place components close to the antenna area. Follow the recommendations of the antenna manufacturer to determine distance of the antenna in relation to other parts of the system. Designers should also maximize the distance of the antenna to High-frequency busses, like DDRs and related components. Alternatively, consider an optional metal shield to reduce interferences that might otherwise be picked up by the antenna and subsequently reduce module sensitivity.

3.6.3 Layout and manufacturing

- Avoid stubs on high-speed signals. Test points or component pads should be placed over the PCB trace.
- Verify the recommended maximum signal skew for differential pairs and length matching of busses.
- Minimize the routing length; longer traces degrade signal performance. Ensure that maximum allowable length for high-speed busses is not exceeded.
- Ensure to track your impedance matched traces. Consult early with your PCB manufacturer for proper stack-up definition.
- RF, analog, and digital sections should have dedicated and clearly separated areas on the board.
- No digital routing is allowed in the GND reference plane area of RF traces (ANT pins and Antenna).
- Designers are strongly recommended to avoid digital routing beneath all layers of RF traces.
- Ground cuts or separation are not allowed below the module.
- As a first priority, minimize the length of the RF traces. Then, minimize bus length to reduce potential EMI issues related to the radiation of digital busses.
- All traces (including low speed or DC traces) must couple with a reference plane (GND or power). High-speed busses should be referenced to the ground plane. If designers need to change the ground reference, an adequate number of GND vias must be added in the area of transition. This facilitates a low-impedance path between the two GND layers for the return current.

- Hi-speed busses are not allowed to change reference plane. If a change to the reference plane is unavoidable, some capacitors should be added in the area to provide a low impedance return path through the various reference planes.
- Trace routing should maintain a distance that is greater than $3 \cdot W$ from the edge of the ground plane routing.
- Power planes should maintain a safe distance from the edge of the PCB. The distance must be sufficient to route a ground ring around the PCB, and the ground ring must then be stitched to other layers through vias.
- Route the power supply in low impedance power planes. If you choose to route the power supply with traces, do not route loop structures.

⚠ The heat dissipation during continuous transmission at maximum power can significantly raise the temperature of application baseboards under MAYA-W1 series modules. Avoid placing temperature sensitive devices close to the module and provide these devices with sufficient grounding to transfer generated heat to the PCB.

3.7 Module footprint and paste mask

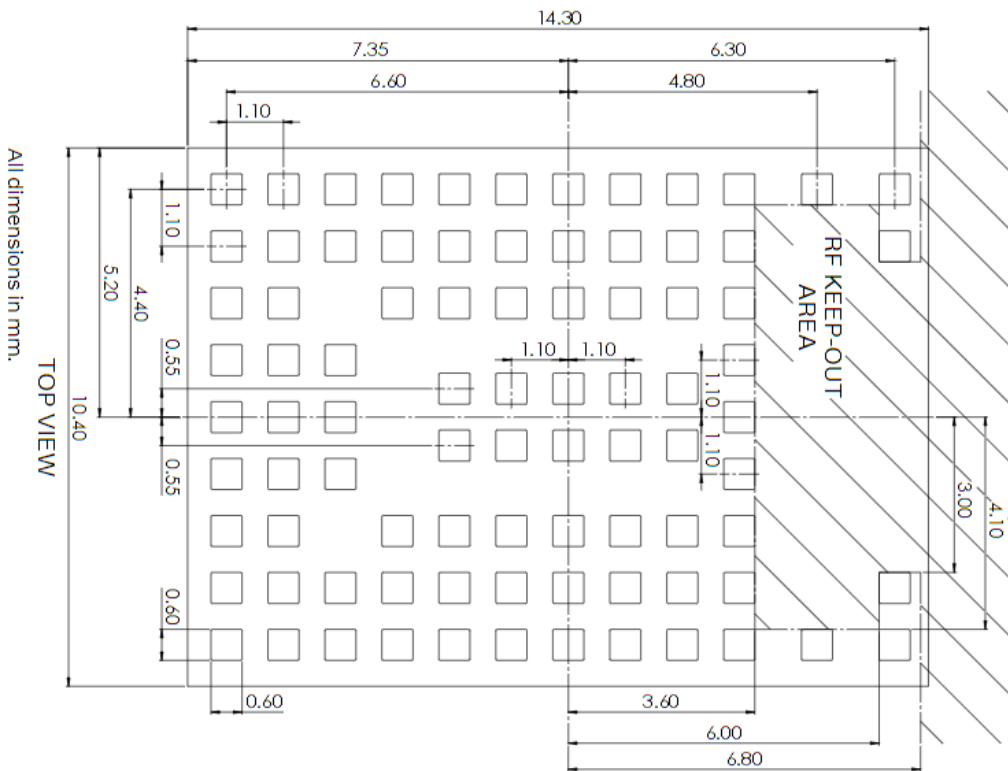

Figure 14: Recommended footprint for MAYA-W1, bottom view

Figure 14 shows the pin layout of MAYA-W1 series modules. The ground clearance, marked as “RF KEEP-OUT AREA”, is only required for the MAYA-W166-00B variant with an internal antenna. The proposed land pattern layout complements the pin layout of the module. Both Solder Mask Defined (SMD) and Non Solder Mask Defined (NSMD) pins can be used with adherence to the following considerations:

- All pins should be Non-Solder Mask Defined (NSMD)
- To help with the dissipation of the heat generated by the module, GND pads must have good thermal bonding to PCB ground planes.

The suggested stencil layout for the MAYA-W1 module should follow the copper pad layout, as shown in Figure 14.

3.8 Thermal guidelines

MAYA-W1 series modules are designed to operate from -40 °C to +85 °C at an ambient temperature inside the enclosure box. The board generates heat during high loads that must be dissipated to sustain the lifetime of the components.

The improvement of thermal dissipation in the module decreases its internal temperature and consequently increases the long-term reliability of device applications operating at high ambient temperatures.

For best performance, layouts should adhere to the following guidelines:

- Vias specification for ground filling: 300/600 μ m, with no thermal reliefs allowed on vias.
- Ground via densities under the module: 50 vias/cm²; thermal vias can be placed in gaps between the thermal pads of the module.
- Minimum layer count and copper thickness: 4 layers, 35 μ m.
- Minimum board size: 55x70 mm.
- To optimize the heat flow from the module, power planes and signal traces should not cross the layers beneath the module.

These recommendations facilitate a design that is capable of achieving a thermal characterization parameter of $\psi_{JB} = 18.2\text{ }^{\circ}\text{C}/\text{W}$ for MAYA-W160 and MAYA-W161 and $\psi_{JB} = 19.4\text{ }^{\circ}\text{C}/\text{W}$ for MAYA-W166, where, *JB* refers to the junction between the module and the bottom side of the main PCB characterization parameter.

Use the following hardware techniques to further improve thermal dissipation in the module and optimize its performance in customer applications:

- Maximize the return loss of the antenna to reduce reflected RF power to the module.
- Improve the efficiency of any component that generates heat, including power supplies and processor, by dissipating it evenly throughout the application device.
- Provide sufficient ventilation in the mechanical enclosure of the application.
- For continuous operation at high temperatures, particularly in high-power density applications or smaller PCB sizes, include a heat sink on the bottom side of the main PCB. The heat sink is best connected using electrically insulated / high thermal conductivity adhesive⁷.

⁷ Typically not required.

3.9 ESD guidelines

MAYA-W1 modules are manufactured using a highly automated process, which complies with IEC61340-5-1 [6] (STM5.2-1999 Class M1 devices) standard. Customer on-site manufacturing processes that satisfy the basic ESD control program are sufficient to comply with the necessary precautions⁸ for handling the modules. The ESD ratings for MAYA-W1 module pins are stated in MAYA-W1 series data sheet, UBX-21006380, [1].

In compliance with the following European regulations, designers must implement proper protection measures against ESD events on any pin exposed to end users:

- ESD testing standard CENELEC EN 61000-4-2 [4]
- Radio equipment standard ETSI EN 301 489-1 [5]

The minimum requirements as per these European regulations are summarized in [Table 20](#).

Application	Category	Immunity level
All exposed surfaces of the radio equipment and any ancillary equipment in the end product.	Contact discharge	4 kV
	Air discharge	8 kV

Table 20: Minimum ESD immunity requirements based on EN 61000-4-2

Compliance with the protection levels specified in EN 61000-4-2 [4] are fulfilled by including proper ESD protection in parallel to any susceptible trace that is close to areas accessible to end users.

-  Special care should be taken with the **RF_ANT** pins that must be protected by choosing an ESD absorber with adequate parasitic capacitance. For 5 GHz operation, a protection with maximum internal capacitance of 0.1 pF is advised.

⁸ Minimum ESD protection level for safe handling is specified in JEDEC JEP155 (HBM) and JEP157 (CDM) for ±500 V and ±250 V respectively.

3.10 Design-in checklists

3.10.1 Schematic checklist

- MAYA-W1 module pins have been properly numbered and designated in the schematic (including thermal pins). See Pin definition in the MAYA-W1 data sheet [1].
- Power supply design complies with the voltage supply requirements in Table 2 and the power supply requirements described in the MAYA-W1 data sheet [1].
- The [Power-up sequence](#) has been properly implemented
- Adequate bypassing has been included in front of each power pin. See [Component placement](#).
- Each signal group is consistent with its own power rail supply or proper signal translation has been provided. See Pin definition in the MAYA-W1 data sheet [1].
- Configuration pins are properly set at bootstrap. See [Configuration pins](#).
- SDIO bus includes series resistors and pull-ups, if needed. See [SDIO 3.0](#).
- Unused pins are properly terminated. See [Unused pins](#).
- A pi-filter is provided in front of each antenna for final matching. See [Antenna design](#).
- Additional RF co-location filters have been considered in the design. See [Block diagrams](#).

3.10.2 Layout checklist

- PCB stack-up and controlled impedance traces follow the recommendations given by the PCB manufacturer. See [RF transmission line design](#).
- All pins are properly connected, and the footprint follows u-blox pin design recommendations. See [Module footprint and paste mask](#).
- Proper clearance has been provided between the RF and digital sections of the design. See [Layout and manufacturing](#).
- Proper isolation has been provided between antennas (RF co-location, diversity, or multi-antenna design). See [Layout and manufacturing](#).
- Bypass capacitors have been placed close to the module. See [Component placement](#).
- Low impedance power path has been provided to the module. See [Module supply design](#).
- Controlled impedance traces have been properly implemented in the layout (both RF and digital) and the recommendations provided by the PCB manufacturer have been followed. See [RF transmission line design](#) and [Component placement](#).
- 50 Ω RF traces and connectors follow the rules described in [RF interface options](#).
- Antenna integration has been reviewed by the antenna manufacturer.
- Proper grounding has been provided to the module for the low impedance return path and heat sink. See [Layout and manufacturing](#).
- Reference plane skipping has been minimized for high frequency busses. See [Layout and manufacturing](#).
- All traces and planes are routed inside the area defined by the main ground plane. See [Layout and manufacturing](#)
- u-blox has reviewed and approved the PCB⁹.

⁹ This is applicable only for end-products based on u-blox reference designs.

4 Software

This chapter describes the available software options for MAYA-W1 series modules, which are based on the NXP IW416 chipset. The drivers and firmware required to operate MAYA-W1 series modules are developed by NXP and are pre-integrated into the Linux BSP for NXP i.MX processors [12] and the MCUXpresso SDK for NXP MCU devices [13].

4.1 Available software packages

Wi-Fi and Bluetooth drivers for MAYA-W1 series modules are pre-integrated into the software images for NXP based host platforms. The documentation for the software releases from NXP contains Wi-Fi and Bluetooth release notes and a list of supported software features. The driver source code is provided free of charge as open source under NXP licensing terms.

 As open-source code, the Wi-Fi and Bluetooth drivers can be integrated or ported to other non-NXP based host platforms.

4.1.1 Open-source Linux/Android drivers

The Wi-Fi driver and firmware for MAYA-W1 series modules are integrated into the Linux BSP for NXP i.MX processors. Yocto recipes for the driver and firmware, that can be used to develop custom Linux-based systems, are part of the NXP i.MX Linux BSP.

The latest version of the driver source code and Wi-Fi/Bluetooth firmware are available from the following open-source repositories:

- Wi-Fi driver: <https://github.com/nxp-imx/mwifiex>
- Firmware: <https://github.com/NXP/imx-firmware/>

 Use the repository branches matching to the latest Linux BSP release version. As of writing, this is release 6.1.36_2.1.0.

Yocto recipes for the driver and firmware (nxp-wlan-sdk, kernel-module-nxp-wlan, firmware-nxp-wifi) are included in the NXP [meta-imx](#) and [meta-freescale](#) layers.

4.1.2 MCUXpresso SDK

The MCUXpresso SDK is a comprehensive software enablement package for MCU devices from NXP. It includes production-grade software with optionally integrated real-time operation systems (RTOS), integrated enabling software technologies (stacks and middleware), reference software, and more. The SDK includes the Wi-Fi and Bluetooth drivers and firmware for MAYA-W1 series modules for supported NXP MCUs. MCUXpresso Wi-Fi/Bluetooth support for NXP IW416 chipset in MAYA-W1 is currently available for FreeRTOS™ real-time operation system.

4.2 u-blox software deliverables

The following additional software deliverables are provided by u-blox for MAYA-W1 series modules:

- A Yocto/OpenEmbedded meta layer, which includes recipes for related development tools. For more information about the Yocto layer, see also [Yocto meta layer](#).

 For the latest MAYA-W1 series software deliverables, [contact](#) your local support team.



4.2.1 Yocto meta layer

Yocto is an open-source project aimed at helping the development of custom Linux-based systems for embedded products. It provides a complete development environment with tools, documentation, and metadata like recipes, classes, and configuration. Yocto is based on the OpenEmbedded build system.

A Yocto/OpenEmbedded meta layer “meta-ublox-modules” is provided by u-blox for all host-based modules. This layer is used in Yocto projects to build the image for most host platforms that run Linux kernels. It contains the recipes used to build the Linux drivers, support tools, and any configuration files that are needed to operate the modules.

Item	Description
Build recipe	Includes all the instructions to extract, compile and install the drivers, firmware and tools in the root file system of the host system image.
Patches	Used to fix bugs in u-blox-distributed drivers seen either locally or reported by the vendor.
Calibration files	Calibration files, provided by u-blox, used while loading the driver. These files store the tuning parameters needed for RF parts present in the module, like the crystal.
Output power configuration	RF power specific files for the different bands, rates and countries are stored in configuration files provided by u-blox.
Modprobe rules	Configuration files for the modprobe utility used to store the driver load parameters.
Manufacturing package recipes	Includes different recipes for building the manufacturing tools. These recipes are used in production and RF-related tests.

Table 21: Content of the Yocto layer

-  Calibration files are needed for the modules during the prototype stage of development. After prototyping, all required calibrations are programmed into the OTP on the module.
-  Further information about the Yocto layer and how to integrate it into the development environment is provided in the `README` files of the meta layer.

4.3 Software architecture

From the software point of view, host-based MAYA-W1 series modules contain only on-board OTP memory with calibration parameters and MAC addresses. Consequently, the modules require a host-side driver and device firmware to run. At startup and at every reset or power cycle, the host driver needs to download the firmware binary file to the module. The firmware binary file is typically a “combo” firmware, which comprises the Wi-Fi and Bluetooth firmware images, and it is downloaded to the module by the Wi-Fi driver through the Wi-Fi host interface.

Figure 15 shows the basic architecture of the Linux open source, Wi-Fi driver (*mxm_mwifiex*), which is a unified driver for all supported NXP Wi-Fi chipsets. The driver allows simple migration and forward compatibility with future devices. Driver sources can be used or ported for other non-NXP host platforms. Bluetooth uses the Linux BlueZ host stack through the HCI UART interface of the module, but other stacks can also be supported.

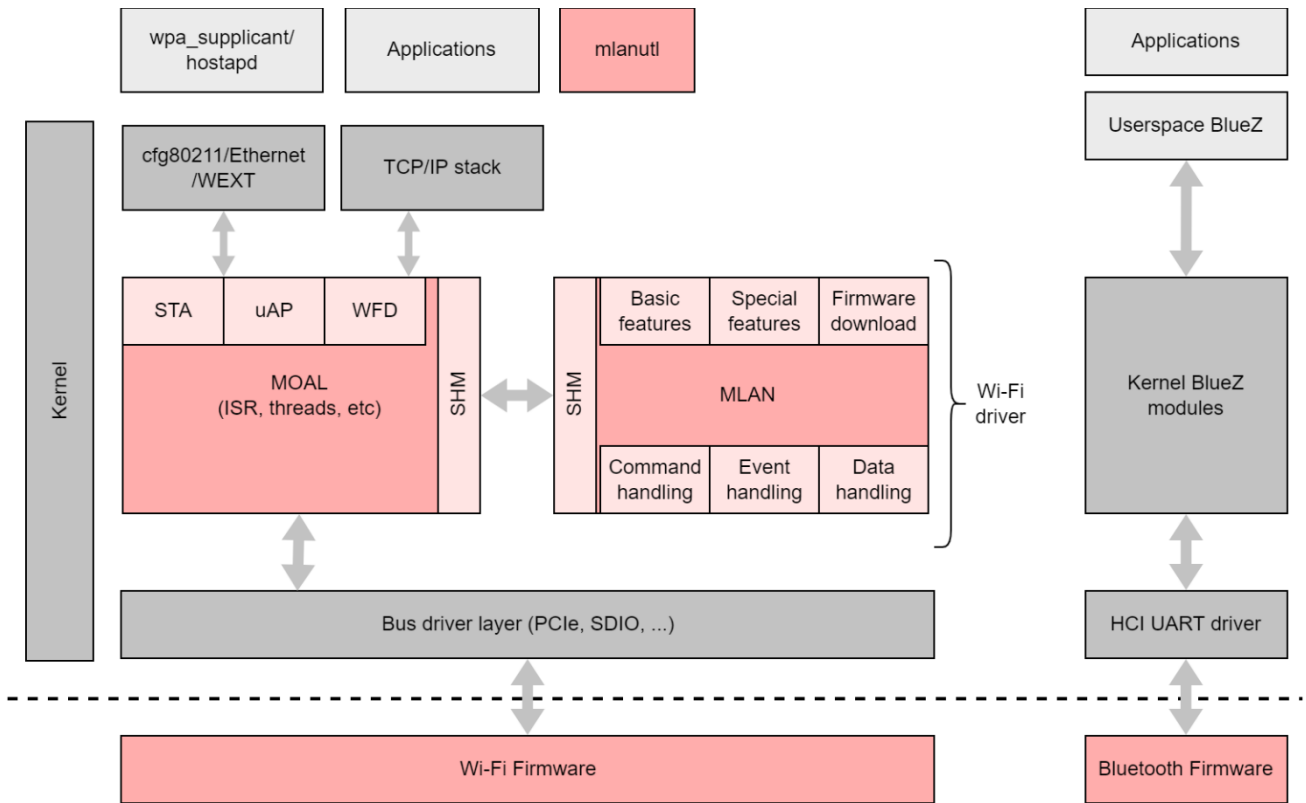

Figure 15: Basic Wi-Fi and Bluetooth driver architecture

The host driver interfaces the lower-layer bus drivers with the upper-layer protocol stacks of the operating system. The Wi-Fi driver uses the TCP/IP stack from the Linux kernel for data transmission, and the *cfg80211* subsystem in the kernel is used for configuration and control. The *hci_uart* driver from the Linux kernel and BlueZ host stack are used for the Bluetooth part.

4.4 Linux drivers bring-up

The following steps explain how to download, build, and load the open-source Linux drivers for the MAYA-W1 series modules.

4.4.1 Downloading Wi-Fi driver sources

Download the Wi-Fi driver sources from the Git repository:

```
$ git clone http://source.codeaurora.org/external/imx/mwifiex
$ cd mwifiex/
$ git checkout <release-tag> # for example, git checkout lf-6.1.36-2.1.0
```

4.4.2 Building the Wi-Fi driver

A (cross-)toolchain for the target system is required and configured kernel sources must be available and prepared for building external kernel modules. Make sure that `CONFIG_CFG80211` is enabled in the kernel configuration. To prepare fresh kernel sources, configure the kernel and run `make modules_prepare` in the kernel source directory.

Before building the driver, make sure that the NXP chipset (IW416, formerly 88W8978) used in the MAYA-W1 module is enabled in the driver `Makefile` and disable i.MX support on non-NXP platforms:

```
CONFIG_SD8978=y
CONFIG_IMX_SUPPORT=n
```

Environment variables `ARCH`, `CROSS_COMPILE`, and `KERNELDIR` must be set accordingly for building the driver.

```
$ cd mxm_wifiex/wlan_src/
$ export ARCH=<target architecture, e.g. arm64>
$ export CROSS_COMPILE=<cross-toolchain prefix>
$ export KERNELDIR=<path to kernel build dir>
$ make build
```

The build results will be stored in the directory `../bin_wlan/`:

- Driver kernel modules: `mLAN.ko`, `moal.ko`
- Configuration tool: `mLANutil` (see `README_MLAN` for usage details)

4.4.3 Downloading the firmware

```
$ git clone https://github.com/NXP/imx-firmware.git
$ cd imx-firmware/nxp/
$ git checkout <release-tag> # for example, git checkout lf-6.1.36-2.1.0
```

The Wi-Fi/Bluetooth combo firmware image for the MAYA-W1 series is located at `imx-firmware/nxp/FwImage_IW416_SD/sdiouartiw416_combo_v0.bin`.

4.4.4 Deployment to the target file system

Copy the compiled driver kernel modules `mLAN.ko` and `moal.ko` below `/lib/modules/<kernel-version>` on the target system, for example:

```
mxm_wifiex/bin_wlan/mLAN.ko → /lib/modules/<kernel-version>/extra/mLAN.ko
mxm_wifiex/bin_wlan/moal.ko → /lib/modules/<kernel-version>/extra/moal.ko
```

Then run `depmod` on the target system to create the module dependencies.

Copy the firmware image and driver configuration file to `/lib/firmware/nxp/` on the target system:

```
imx-firmware/nxp/FwImage_IW416_SD/sdiouartiw416_combo_v0.bin →
  /lib/firmware/nxp/sdiouartiw416_combo_v0.bin
imx-firmware/nxp/wifi_mod_para.conf → /lib/firmware/nxp/wifi_mod_para.conf
```

Copy the `mLANutil` tool¹⁰ to a location on the target file system, for example:

```
mxm_wifiex/bin_wlan/mLANutil → /usr/share/nxp_wireless/mLANutil
```

¹⁰ Not included in the latest NXP releases. If needed, use `mLANutil` from `lf-5.15.52_2.1.0`.

4.4.5 Bluetooth driver

The standard `hci_uart` or `btmxcuart` driver from the Linux kernel is used for the Bluetooth HCI UART interface. Make sure to enable `CONFIG_BT_HCIUART` and `CONFIG_BT_HCIUART_H4` in the kernel configuration.

4.4.6 Driver loading

Prior to loading the drivers, make sure that the MAYA-W1 series module is detected by the host system on the SDIO bus and reported in the kernel log as shown in the example below:

```
mmcl: new ultra high speed DDR50 SDIO card at address 0001
```

The Wi-Fi driver parameters are configured in the `/lib/firmware/nxp/wifi_mod_para.conf` file in a chipset specific block for MAYA-W1:

```
SD8978 = {
    cfg80211_wext=0xf
    max_vir_bss=1
    cal_data_cfg=none
    ps_mode=1
    auto_ds=1
    host_mlme=1
    fw_name=nxp/sdiouartiw416_combo_v0.bin
}
```

The Wi-Fi driver and firmware are loaded with the following command:

```
$ modprobe moal mod_para=nxp/wifi_mod_para.conf
```

The serial device for the HCI UART interface is attached to the Linux BlueZ stack with the following commands (example using `/dev/ttyUSB0`):

```
$ modprobe hci_uart
$ hciattach /dev/ttyUSB0 any 3000000 flow
$ hciconfig hci0 up
```

4.4.7 Verification

The version of the loaded Wi-Fi driver and firmware can be verified using the following command:

```
$ /usr/share/nxp_wireless/mlanut1 mlan0 version
Version string received: SDIW416---16.92.21.p84.3-MM5X16408.p2-GPL-(FP92)
```

Use command `iw dev` to display the available Wi-Fi interfaces (excerpt):

```
phy#0
    Interface wfd0
        addr 6e:1d:eb:90:b8:c5
        type managed
    Interface uap0
        addr 6c:1d:eb:90:b9:c5
        type AP
    Interface mlan0
        addr 6c:1d:eb:90:b8:c5
        type managed
```

Table 22 describes the functions of the Wi-Fi interfaces.

Interface	Function
mlan0	Network interface used for station mode functionality. Typically used with wpa_supplicant.
uap0	Network interface used for access-point functionality. Typically used with hostapd.
wfd0	Network interface used for P2P functionality. Can operate in both group owner (GO) and group client (GC) modes.

Table 22: Available Wi-Fi network interfaces



The system/udev managers in modern Linux distributions automatically try to assign predictable, stable network interface names for all local Ethernet and Wi-Fi interfaces. This can result in different names being used for the network interfaces. Use the kernel command line option `net.ifnames=0` to override this behavior and use the driver default names.

The `hciconfig` command from BlueZ can be used to verify that the Bluetooth HCI interface is up:

```
hci0: Type: Primary Bus: UART
      BD Address: 6C:1D:EB:90:B8:C4 ACL MTU: 1021:7 SCO MTU: 120:6
      UP RUNNING
      RX bytes:1498 acl:0 sco:0 events:90 errors:0
      TX bytes:1270 acl:0 sco:0 commands:90 errors:0
```

4.5 Usage examples

The Wi-Fi and Bluetooth features and configurations for NXP-based wireless modules on i.MX Linux host platforms are described in the NXP User Manual UM11490 [14]. The document covers the initialization and configuration of the Wi-Fi and Bluetooth interfaces. It is applicable for MAYA-W1 series on i.MX 8 family NXP host processors and other NXP-based wireless modules.

The Wi-Fi features demonstrated in the NXP User Manual [14] are configured with the open source wpa_supplicant/hostapd and Linux utilities. Wi-Fi features include scanning for nearby access points, connecting to an access point, configuring the device as an access point, Wi-Fi security, Wi-Fi Direct, and throughput testing using the iperf utility.

The Bluetooth features use the Linux BlueZ host stack and comprise scan, pair, Bluetooth or Bluetooth Low Energy (LE) device connection, A2DP profile, hands-free profile, and Bluetooth LE device GATT server operation. Guidelines for enabling driver debug logging are also provided.

The manual also explains how to perform radio testing for Wi-Fi and Bluetooth using the open-source drivers.

4.6 Configuration of TX power limits and energy detection

4.6.1 Wi-Fi power table

The Wi-Fi TX power table defines the transmit power levels for the Wi-Fi radio. The power levels are based on regulatory compliance, IEEE 802.11 requirements, and product design constraints. The TX power table can be adjusted to achieve the highest transmit power level for each Wi-Fi channel, bandwidth, and modulation within the constraints defined by the certification.

 The correct TX power limits must be applied to the module after startup of the host system and adjusted after some change of the regulatory domain or country specific requirements during runtime.

The Wi-Fi TX power levels are configured with the `txpwrlimit_2g_cfg_set` and `txpwrlimit_5g_cfg_set` data structures defined in the `txpwrlimit_cfg.conf` configuration file. The configuration file allows integrators to fine tune specific transmit power levels for the Wi-Fi radio, including:

- Band (2.4, 5 GHz)
- Channel
- Modulation rate (CCK, OFDM, HT20, HT40)
- Channel bandwidth (20, 40 MHz)

 Transmit power limit configuration files are provided by u-blox for the certified regulatory domains accommodated in the available reference designs and [Approved antennas](#). The configuration files for completed certifications are included in the [Yocto meta layer](#).

An example of the `txpwrlimit_2g_cfg_set` structure for the 2.4 GHz band channels is shown below:

```
## 2G Tx power limit CFG
txpwrlimit_2g_cfg_set={
    CmdCode=0x00fb          # do NOT change this line
    Action:2=1             # 1 - SET
    RSVD:2=0               # do NOT change this line

    ChanTRPC.TlvType:2=0x0189
    ChanTRPC.TlvLength:2={
        TLVStartFreq:2=2407
        TLVChanWidth:1=20
        TLVChanNum:1=1
        TLVPwr:20='0,12,1,11,2,11,3,11,4,11,5,11,6,11,7,0,8,0,9,0'
    }
    ChanTRPC.TlvType:2=0x0189
    ChanTRPC.TlvLength:2={
        TLVStartFreq:2=2407
        TLVChanWidth:1=20
        TLVChanNum:1=2
        TLVPwr:20='0,12,1,16,2,16,3,16,4,16,5,16,6,16,7,0,8,0,9,0'
    }
    ChanTRPC.TlvType:2=0x0189
    ChanTRPC.TlvLength:2={
        TLVStartFreq:2=2407
        TLVChanWidth:1=20
        TLVChanNum:1=3
        TLVPwr:20='0,12,1,16,2,16,3,16,4,16,5,16,6,16,7,15,8,15,9,15'
    }
    ...
}
```

The parameters inside `txpwrlimit_cfg.conf` are described in [Table 23](#).

Parameter	Description
TLVType	Internal parameter set to 0x189. Do not change this value.
TLVStartFreq	Starting frequency of the band for this channel <ul style="list-style-type: none"> • 2407, 2414 or 2400 for 2.4 GHz • 5000 for 5 GHz
TLVChanWidth	Channel bandwidth in MHz (20)
TLVChanNum	Logical 5 MHz channel number (1-255). Channel of the center frequency for HT40 operation in the 2.4 GHz band and primary channel for 40/80 MHz operation in 5 GHz.
TLVPwr:<Length>	Specifies the transmit power limits for specific modulations as a list with the length: <length> of (ModulationGroup,Power) tuples, where ModulationGroup specifies the mapping for the modulation. See also Table 24 . Power specifies the Tx power limit in dBm.

Table 23: Parameters in `txpwrlimit_cfg.conf` file

The mapping of multiple wireless data rates into ModulationGroup values is shown in [Table 24](#).

ModulationGroup	Mode	Bandwidth [MHz]	Description
0	802.11b	20	CCK (1,2,5,5,11 Mbps)
1	802.11g	20	OFDM (6,9,12,18 Mbps)
2			OFDM (24,36 Mbps)
3			OFDM (48,54 Mbps)
4	802.11n	20	HT20 (MCS 0,1,2)
5			HT20 (MCS 3,4)
6			HT20 (MCS 5,6,7)
7		40	HT40 (MCS 0,1,2)
8			HT40 (MCS 3,4)
9			HT40 (MCS 5,6,7)

Table 24: ModulationGroup information

The configuration file example above sets the following transmit power limits for channels 1-3 in the 2.4 GHz band:

- 12 dBm for 802.11b rates on channels 1-3
- 11 dBm for 802.11g and 802.11n HT20 rates on channel 1
- 16 dBm for 802.11g and 802.11n HT20 rates on channels 2 and 3
- 15 dBm for 802.11n HT40 rates on channel 3 (first valid 40 MHz channel)



For HT40 operation in the 2.4 GHz band, the transmit power limits are selected from the channel of the center frequency. For example, the first 40 MHz channel at the center frequency 2422 MHz (20 MHz channels 1+5) uses the transmit power limits from HT40 values in the entry with TLVChanNum=3.

An example of the txpwrlimit_5g_cfg_set structure for the 5 GHz channels is shown below:

```
## 5G Tx power limit CFG
txpwrlimit_5g_cfg_set={
    CmdCode=0x00fb          # do NOT change this line
    Action:2=1              # 1 - SET
    RSVD:2=0                # do NOT change this line

    ChanTRPC.TlvType:2=0x0189
    ChanTRPC.TlvLength:2={
        TLVStartFreq:2=5000
        TLVChanWidth:1=20
        TLVChanNum:1=36
        TLVPwr:30='1,15,2,15,3,15,4,15,5,15,6,15,7,15,8,15,9,15'
    }
    ChanTRPC.TlvType:2=0x0189
    ChanTRPC.TlvLength:2={
        TLVStartFreq:2=5000
        TLVChanWidth:1=20
        TLVChanNum:1=40
        TLVPwr:30='1,15,2,15,3,15,4,15,5,15,6,15,7,15,8,15,9,1'
    }
    ...
}
```



The transmit power limit configurations for 40 MHz operation in the 5 GHz band must be specified for all related 20 MHz channels. For example, the 40 MHz channel at the center frequency 5190 MHz (20 MHz channels 36+40) uses the transmit power limits from HT40 values in the entry with `TLVChanNum=36` (secondary channel above primary channel) or `TLVChanNum=40` (secondary channel below primary channel), which should be equal.

For the exact power limits used in the u-blox reference design for the various certifications, see the [Appendix: Wi-Fi Tx output power limits](#).

4.6.1.1 Applying the TX power limit configuration

The TX power configuration file `txpwrlimit_cfg.conf` must first be converted to a binary format before the Wi-Fi driver can use it. The following example command uses the `mланutl` tool to create the binary file `txpower_US.bin` from the configuration file:

```
mланutl mлан0 hostcmd txpwrlimit_cfg.conf generate_raw txpower_US.bin
```

To apply the TX power limit configuration when the driver is loaded, copy the binary file to the firmware directory and add the `txpwrlimit_cfg` parameter to the `wifi_mod_para.conf` driver parameter configuration file:

```
SD8978 = {
  ...
  fw_name=nxp/sdiouartiw416_combo_v0.bin
  txpwrlimit_cfg=nxp/txpower_US.bin
}
```

The Wi-Fi driver can also be configured with the driver option `cntry_txpwr=1` to automatically load the corresponding binary TX power configuration file whenever the regulatory domain is changed. For this, the file name of the TX power files should be `txpower_XX.bin`, where “XX” is the ISO/IEC 3166 alpha2 country code. The files are expected to reside in the same folder as the firmware.

4.6.1.2 Reading the TX power limit configuration

The current TX power limit configuration can be read from the firmware using the `mланutl` tool as shown below:

```
mланutl mлан0 get_txpwrlimit <n> [raw_data_file]
  where <n>
    0:      Get 2.4G txpwrlimit table
    0x10:   Get 5G sub0 txpwrlimit table
    0x11:   Get 5G sub1 txpwrlimit table
    0x12:   Get 5G sub2 txpwrlimit table
    0x1f:   Get all 5G txpwrlimit table
    0xff:   Get both 2G and 5G txpwrlimit table
  <raw_data_file> driver will save fw raw data to this file.
```

4.6.2 Bluetooth TX power levels

The vendor specific HCI command `HCI_CMD_UPDATE_TX_MAX_PWR_LVL` can be used to update the maximum transmit power level for Bluetooth BR/EDR, as shown in the following usage example:

```
# hcitool -i hci0 cmd 0x3F 0xEE 0x01 <signed TX power value in dBm>
# set max. TX power level to 10 dBm:
hcitool -i hci0 cmd 0x3F 0xEE 0x01 0x0A
hciconfig hci0 reset
```



HCI reset is required after this command for the TX power change to take effect. A maximum TX power level of 12 dBm can be configured.

Bluetooth LE transmit power level can be set using the vendor specific HCI command `HCI_CMD_BLE_WRITE_TRANSMIT_POWER_LEVEL`, as shown in the following example:

```
# hcitool -i hci0 cmd 0x3F 0x87 <signed TX power value in dBm>
# set BLE TX power level to 10 dBm:
hcitool -i hci0 cmd 0x3F 0x87 0x0A
```



Bluetooth LE TX power setting will be cleared with HCI reset. A maximum of TX power level of 10 dBm can be configured.

4.6.3 Adaptivity configuration (energy detection)

MAYA-W1 modules support the adaptivity requirements (energy detection) from EN 300 328 and EN 301 893 for Wi-Fi. The Energy Detect mechanism must be explicitly enabled after the startup of the module, and correct detection threshold values must be configured. These threshold values depend on the combined gain of the antenna and antenna trace used in the end-product.

Energy detection is enabled and threshold values are configured through a configuration file, as shown below:

```
## Set Energy Detect Threshold for EU Adaptivity test
ed_mac_ctrl_v2={
  CmdCode=0x0130          # Command code, DO NOT change this line
  ed_ctrl_2g.enable:2=0x1 # 0 - disable EU adaptivity for 2.4GHz band
                          # 1 - enable EU adaptivity for 2.4GHz band
  ed_ctrl_2g.offset:2=0x6 # Default Energy Detect threshold
                          # offset value range: 0x80 to 0x7F
  ed_ctrl_5g.enable:2=0x1 # 0 - disable EU adaptivity for 5GHz band
                          # 1 - enable EU adaptivity for 5GHz band
  ed_ctrl_5g.offset:2=0x6 # Default Energy Detect threshold
                          # offset value range: 0x80 to 0x7F
  ed_ctrl_txq_lock:4=0xFF # DO NOT Change this line
}
```

The offset values `ed_ctrl_2g.offset` and `ed_ctrl_5g.offset` are used to adjust the energy detection thresholds during the EU adaptivity test. Increasing the values results in a more sensitive behavior to compensate for additional attenuation in the antenna path. Decreasing the values lowers the sensitivity.

The following command enables energy detection and configures the detection thresholds according to the settings in the `ed_mac_ctrl_v2.conf` configuration file:

```
mланut1 mлан0 hostcmd ed_mac_ctrl_V2.conf ed_mac_ctrl_v2
```

4.7 Assigning MAC addresses

MAYA-W1 series has four unique MAC addresses reserved for each module. The first MAC address is used for Bluetooth and the second address is used for the Wi-Fi radio. The third and fourth MAC addresses are reserved for use with other local interfaces.

Example

6C:1D:EB:00:4B:40 – Bluetooth interface (hci0)

6C:1D:EB:00:4B:41 – Wi-Fi station interface (mлан0)

6C:1D:EB:00:4B:42 – Reserved for use with other interfaces

6C:1D:EB:00:4B:43 – Reserved for use with other interfaces



The Wi-Fi driver automatically assigns locally unique MAC addresses to any additional Wi-Fi network interfaces, which are derived from the radio's primary Wi-Fi station interface MAC address. The use of reserved unique MAC addresses is recommended to avoid possible collisions with the MAC addresses of other modules.

The MAC addresses of the interfaces can be configured through an `init_cfg.conf` file while loading the driver using the driver option `init_cfg=nxp/init_cfg.conf`. Note that the driver expects the configuration file to be present in a directory relative to `/lib/firmware/`.

In the following example, the MAC address of the `uap0` Wi-Fi interface has been changed to use one of the reserved MAC addresses:

```
# File: /lib/firmware/nxp/init_cfg.conf
# MAC address (interface: address)
mac_addr=uap0: 6C:1D:EB:00:4B:42
```

5 Handling and soldering

⚠ MAYA-W1 series modules are Electrostatic Sensitive Devices that demand the observance of special handling precautions against static damage. Failure to observe these precautions can result in severe damage to the product.

5.1 ESD handling precautions

As the risk of electrostatic discharge in the RF transceivers and patch antennas of the module is of particular concern, standard ESD safety practices are prerequisite. See also [Figure 16](#).

Consider also:

- When connecting test equipment or any other electronics to the module (as a standalone or PCB-mounted device), the first point of contact must always be to local GND.
- Before mounting an antenna patch, connect the device to ground.
- When handling the RF pin, do not touch any charged capacitors. Be especially careful when handling materials like patch antennas (~10 pF), coaxial cables (~50-80 pF/m), soldering irons, or any other materials that can develop charges.
- To prevent electrostatic discharge through the RF input, do not touch any exposed antenna area. If there is any risk of the exposed antenna being touched in an unprotected ESD work area, be sure to implement proper ESD protection measures in the design.
- When soldering RF connectors and patch antennas to the RF pin on the receiver, be sure to use an ESD-safe soldering iron (tip).

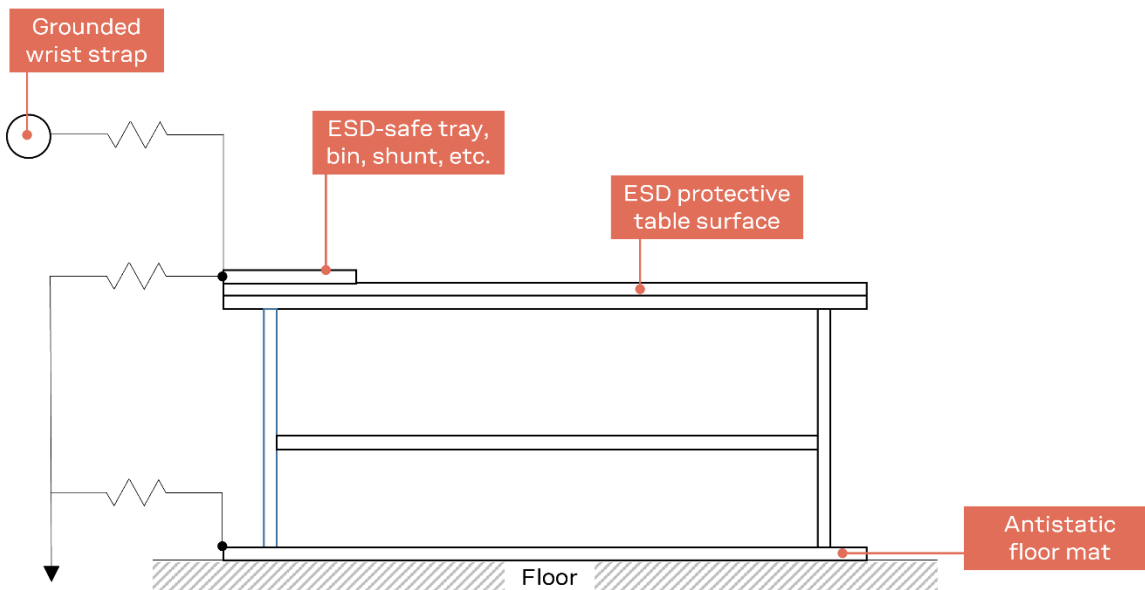



Figure 16: Standard workstation setup for safe handling of ESD-sensitive devices

5.2 Packaging, shipping, storage, and moisture preconditioning

For information pertaining to reels, tapes, or trays, moisture sensitivity levels (MSL), storage, shipment, and drying preconditioning, see the MAYA-W1 series data sheet [\[1\]](#) and Packaging information reference guide [\[2\]](#).

5.3 Reflow soldering process

 MAYA-W160 is approved for one-time reflow processes only. MAYA-W161 and MAYA-W166 are approved for two-time reflow processes.

MAYA-W1 modules are surface mounted devices supplied on a multi-layer FR4-type PCB with gold-plated connection pads. The modules are produced in a lead-free process using lead-free soldering paste. The thickness of solder resist between the host PCB top side and the bottom side of the MAYA-W1 module must be considered for the soldering process.

MAYA-W1 modules are compatible with industrial reflow profile for RoHS solders, and “no-clean” soldering paste is strongly recommended.

The reflow profile used is dependent on the thermal mass of the entire populated PCB, the heat transfer efficiency of the oven, and the type of solder paste that is used. The optimal soldering profile must be trimmed for the specific process and PCB layout

A vacuum reflow process is not recommended to use for MAYA-W1 modules.

 The target values shown in [Table 25](#) and [Figure 17](#) are given as general guidelines for a Pb-free process only. For further information, see also the JEDEC J-STD-020E [7] standard.

Process parameter		Unit	Target
Pre-heat	Ramp up rate to T_{SMIN}	K/s	3
	T_{SMIN}	°C	150
	T_{SMAX}	°C	200
	t_s (from 25°C)	s	150
	t_s (Pre-heat)	s	110
Peak	T_L	°C	217
	t_L (time above T_L)	s	90
	T_P	°C	245-250
	t_p (time above $T_P - 5^\circ\text{C}$)	s	30
Cooling	Ramp-down from T_L (max)	K/s	6
General	$T_{to\ peak}$	s	300
	Allowed reflow soldering cycles	-	1 (MAYA-W160) 2 (MAYA-W161 and MAYA-W166 only)

Table 25: Recommended reflow profile

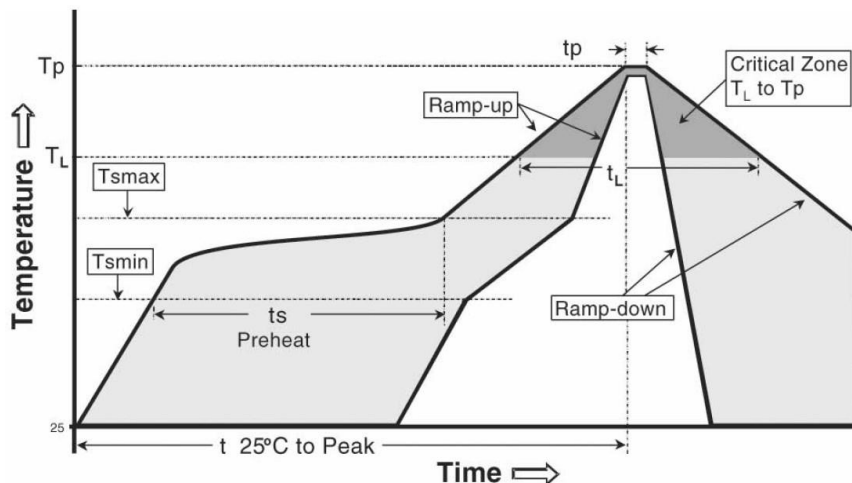



Figure 17: Reflow profile

 The lower value of T_P and slower ramp down rate is preferred.

5.3.1 Cleaning

Cleaning the modules is not recommended. Residues underneath the modules cannot be easily removed with a washing process.

- Cleaning with water will lead to capillary effects where water is absorbed in the gap between the baseboard and the module. The combination of residues of soldering flux and encapsulated water leads to short circuits or resistor-like interconnections between neighboring pins. Water will also damage the sticker and the ink-jet printed text.
- Cleaning with alcohol or other organic solvents can result in soldering flux residues flooding into the housing, areas that are not accessible for post-wash inspections. The solvent will also damage the label and the ink-jet printed text.
- Ultrasonic cleaning will permanently damage the module and the crystal oscillators in particular.

For best results use a "no clean" soldering paste and circumvent the need for a cleaning stage after the soldering process.

5.3.2 Other notes

- Boards with combined through-hole technology (THT) components and surface-mount technology (SMT) devices may require wave soldering to solder the THT components. Only a single wave-soldering process is allowed for boards populated with the modules. Miniature Wave Selective Solder processes are preferred over traditional wave soldering processes.
- Hand-soldering is not recommended.
- Rework is not recommended.
- Conformal coating can affect the performance of the module, which means that it is important to prevent the liquid from flowing into the module. The RF shields do not provide protection for the module from coating liquids with low viscosity; therefore, care is required while applying the coating. Conformal coating of the module will void the warranty.
- Grounding metal covers: Attempts to improve grounding by soldering ground cables, wick, or other forms of metal strips directly onto the EMI covers is done so at the customer's own risk and will void the module warranty. The numerous ground pins on the module are adequate to provide optimal immunity to interferences.
- The modules contain components which are sensitive to Ultrasonic Waves. Use of any Ultrasonic Processes (cleaning, welding, etc.) may damage the module. The use of ultrasonic processes during the integration of the module into an end product will void the warranty.

6 Regulatory compliance

6.1 General requirements

MAYA-W1 series modules are designed to comply with the regulatory demands of Federal Communications Commission (FCC), Innovation, Science and Economic Development Canada (ISED)¹¹ and the CE mark. This chapter contains instructions on the process needed for an integrator when including the MAYA-W1 module into an end-product.

- Any deviation from the process described may cause the MAYA-W1 series module not to comply with the regulatory authorizations of the module and thus void the user's authority to operate the equipment.
- Any changes to hardware, hosts or co-location configuration may require new radiated emission and SAR evaluation and/or testing.
- The regulatory compliance of MAYA-W1 does not exempt the end-product from being evaluated against applicable regulatory demands; for example, FCC Part 15B criteria for unintentional radiators [9].
- The end-product manufacturer must follow all the engineering and operating guidelines as specified by the grantee (u-blox).
- The MAYA-W1 is for OEM integrators only.
- Only authorized antenna(s) may be used. Refer to MAYA-W1 data sheet [1] for the list of authorized antennas. In the end-product, the MAYA-W1 module must be installed in such a way that only authorized antennas can be used.
- The end-product must use the specified antenna trace reference design, as described in the MAYA-W1 antenna reference design application note [11].
- Any notification to the end user about how to install or remove the integrated radio module is NOT allowed.

 If these conditions cannot be met or any of the operating instructions are violated, the u-blox regulatory authorization will be considered invalid. Under these circumstances, the integrator is responsible to re-evaluate the end-product including the MAYA-W1 series module and obtain their own regulatory authorization, or u-blox may be able to support updates of the u-blox regulatory authorization. See also [Antenna requirements](#).

6.2 European Union regulatory compliance

MAYA-W1 series modules comply with the essential requirements and other relevant provisions of Radio Equipment Directive (RED) 2014/53/EU.

For information about the regulatory compliance of MAYA-W1 series modules against requirements and provisions in the European Union, see the MAYA-W1 Declaration of Conformity [19].

6.2.1 CE End-product regulatory compliance

6.2.1.1 Safety standard

In order to fulfill the safety standard EN 60950-1 [8], the MAYA-W1 module must be supplied with a Class-2 Limited Power Source.

¹¹ Formerly known as IC (Industry Canada).

6.2.1.2 CE Equipment classes

In accordance with Article 1 of Commission Decision 2000/299/EC¹², MAYA-W1 is defined as either Class-1 or Class-2 radio equipment, the end-product integrating MAYA-W1 inherits the equipment class of the module.



For guidance on end product marking in accordance with RED, see <http://ec.europa.eu/>

-  The EIRP of the MAYA-W1 module must not exceed the limits of the regulatory domain that the module operates in. Depending on the host platform implementation and antenna gain, integrators must limit the maximum output power of the module through the host software. See [Approved antennas](#) for the list of approved antennas and [Wi-Fi transmit output power limits](#) for the corresponding maximum transmit power levels.

6.2.2 Compliance with the RoHS directive

MAYA-W1 series modules comply with the Directive 2011/65/EU (EU RoHS 2) and its amendment Directive (EU) 2015/863 (EU RoHS 3).

6.3 Great Britain regulatory compliance

For information about the regulatory compliance of MAYA-W1 series modules against requirements and provisions in Great Britain, see also the MAYA-W1 UKCA Declaration of Conformity [18].

6.3.1 UK Conformity Assessed (UKCA)

-
- The United Kingdom is made up of the Great Britain (including England, Scotland, and Wales) and the Northern Ireland. Northern Ireland continues to accept the CE marking. The following notice is applicable to Great Britain only.

MAYA-W1 series modules have been evaluated against the essential requirements of the Radio Equipment Regulations 2017 (SI 2017 No. 1206, as amended by SI 2019 No. 696).

For guidance on end product marking in accordance with UKCA, see <https://www.gov.uk/guidance/using-the-ukca-marking>.

6.4 United States/Canada End-product regulatory compliance

u-blox represents that the modular transmitter fulfills the FCC/ISED regulations when operating in authorized modes on any host product given that the integrator follows the instructions as described in this document. Accordingly, the host product manufacturer acknowledges that all host products referring to the FCC ID or ISED certification number of the modular transmitter and placed on the market by the host product manufacturer need to fulfil all of the requirements mentioned below. Non-compliance with these requirements may result in revocation of the FCC approval and removal of the host products from the market. These requirements correspond to questions featured in the FCC guidance for software security requirements for U-NII devices, FCC OET KDB 594280 D02 [16].

-  The modular transmitter approval of MAYA-W1, or any other radio module, does not exempt the end product from being evaluated against applicable regulatory demands.

¹² 2000/299/EC: Commission Decision of 6 April 2000 establishing the initial classification of radio equipment and telecommunications terminal equipment and associated identifiers.

The evaluation of the end product shall be performed with the MAYA-W1 module installed and operating in a way that reflects the intended end product use case. The upper frequency measurement range of the end product evaluation is the 10th harmonic of 5.8 GHz as described in KDB 996369 D04.

The following requirements apply to all products that integrate a radio module:

- **Subpart B - UNINTENTIONAL RADIATORS**
To verify that the composite device of host and module comply with the requirements of FCC part 15B, the integrator shall perform sufficient measurements using ANSI 63.4-2014.
- **Subpart C - INTENTIONAL RADIATORS**
It is required that the integrator carries out sufficient verification measurements using ANSI 63.10-2013 to validate that the fundamental and out of band emissions of the transmitter part of the composite device complies with the requirements of FCC part 15C.

When the items listed above are fulfilled, the end product manufacturer can use the authorization procedures as mentioned in Table 1 of 47 CFR Part 15.101, before marketing the end product. This means the customer has to either market the end product under a Suppliers Declaration of Conformity (SDoC) or to certify the product using an accredited test lab.

The description is a subset of the information found in applicable publications of FCC Office of Engineering and Technology (OET) Knowledge Database (KDB). We recommend the integrator to read the complete document of the referenced OET KDB's.

- KDB 178919 D01 Permissive Change Policy
- KDB 447498 D01 General RF Exposure Guidance
- KDB 594280 D01 Configuration Control
- KDB 594280 D02 U-NII Device Security
- KDB 784748 D01 Labeling Part 15 18 Guidelines
- KDB 996369 D01 Module certification Guide
- KDB 996369 D02 Module Q&A
- KDB 996369 D04 Module Integration Guide

6.4.1 United States compliance statement (FCC)

MAYA-W1 series modules have modular approval and comply with Part 15 of the FCC Rules. Operation is subject to the following two conditions:

1. This device may not cause harmful interference, and
2. This device must accept any interference received, including interference that may cause undesired operation.

 Any changes or modifications NOT explicitly APPROVED by u-blox could cause the MAYA-W1 series module to cease to comply with FCC rules part 15 thus void the user's authority to operate the equipment.

The internal / external antenna(s) used for this module must provide a separation distance of at least 20 cm from all persons and must not be co-located or operating in conjunction with any other antenna or transmitter.

Table 26 shows the FCC IDs allocated to MAYA-W1 series modules.

Model ¹³	FCC ID
MAYA-W160-00B	XPYMAYAW160
MAYA-W161-00B	XPYMAYAW161

¹³ The model name is identical to the ordering code. For details, see the MAYA-W1 data sheet [1].

Model ¹³	FCC ID
MAYA-W166-00B	XPYMAYAW166
MAYA-W166-01B	XPYMAYAW166

Table 26: FCC IDs for different variants of MAYA-W1 series modules

For FCC end-product labeling requirements, see [End product labeling requirements](#).

6.4.2 Canada compliance statement (ISED)

MAYA-W1 series modules are certified for use in accordance with the Canada Innovation, Science and Economic Development Canada (ISED) Radio Standards Specification (RSS) RSS-247 Issue 2 and RSS-Gen. [Table 27](#) shows the ISED certification IDs allocated to MAYA-W1 series modules.

Model	ISED certification ID
MAYA-W160-00B	8595A-MAYAW160
MAYA-W161-00B	8595A-MAYAW161
MAYA-W166-00B	8595A-MAYAW166
MAYA-W166-01B	8595A-MAYAW166

Table 27: ISED IDs for different variants of MAYA-W1 series modules

MAYA-W1 complies with ISED (Innovation, Science and Economic Development Canada)¹⁴ license-exempt RSSs. Operation is subject to the following two conditions:

1. This device may not cause interference, and
2. This device must accept any interference, including interference that may cause undesired operation of the device.

 Any notification to the end user of installation or removal instructions about the integrated radio module is NOT allowed. Unauthorized modification could void authority to use this equipment.

This equipment complies with ISED RSS-102 radiation exposure limits set forth for an uncontrolled environment. This equipment should be installed and operated with minimum distance 20 cm between the radiator and your body.

This radio transmitter IC: 8595A-MAYAW16x has been approved by ISED to operate with the antenna types listed in [Approved antennas](#) with the maximum permissible gain indicated. Antenna types not included in this list, having a gain greater than the maximum gain indicated for that type, are strictly prohibited for use with this device.

 Operation in the band 5150–5250 MHz is only for indoor use to reduce the potential for harmful interference to co-channel mobile satellite systems.

 Operation in the 5600-5650 MHz band is not allowed in Canada. High-power radars are allocated as primary users (i.e., priority users) of the bands 5250-5350 MHz and 5650-5850 MHz and that these radars could cause interference and/or damage to LE-LAN devices.

Le présent appareil est conforme aux CNR d'ISED applicables aux appareils radio exempts de licence. L'exploitation est autorisée aux deux conditions suivantes :

- (1) l'appareil ne doit pas produire de brouillage, et
- (2) l'utilisateur de l'appareil doit accepter tout brouillage radioélectrique subi, même si le brouillage est susceptible d'en compromettre le fonctionnement.

¹⁴ Formerly known as IC (Industry Canada).

Cet équipement est conforme aux limites d'exposition de rayonnement d'ISED RSS-102 déterminées pour un environnement non contrôlé. Cet équipement devrait être installé et actionné avec la distance minimum 20 cm entre le radiateur et votre corps.

Cet émetteur radio, IC: 8595A-MAYA-W16x été approuvé par ISED pour fonctionner avec les types d'antenne énumérés dans la section [Approved antennas](#) avec le gain maximum autorisé et l'impédance nécessaire pour chaque type d'antenne indiqué. Les types d'antenne ne figurant pas dans cette liste et ayant un gain supérieur au gain maximum indiqué pour ce type-là sont strictement interdits d'utilisation avec cet appareil.

 Le dispositif de fonctionnement dans la bande 5150-5250 MHz est réservé à une utilisation en intérieur pour réduire le risque d'interférences nuisibles à la co-canal systèmes mobiles par satellite

 Opération dans la bande 5600-5650 MHz n'est pas autorisée au Canada. Haute puissance radars sont désignés comme utilisateurs principaux (c.-à utilisateurs prioritaires) des bandes 5250-5350 MHz et 5650-5850 MHz et que ces radars pourraient causer des interférences et / ou des dommages à dispositifs LAN-EL.

The internal / external antenna(s) used for this module must provide a separation distance of at least 20 cm from all persons and must not be co-located or operating in conjunction with any other antenna or transmitter.

For ISED end-product labeling requirements, see [End product labeling requirements](#).

 The approval type for all MAYA-W1 series variants is a single modular approval. Due to ISED Modular Approval Requirements (Source: RSP-100 Issue 10), any application which includes the module must be approved by the module manufacturer (u-blox). The application manufacturer must provide design data for the review procedure

6.4.3 Referring to the u-blox FCC/ISED certification ID

If the [General requirements](#), [FCC/ISED End-product regulatory compliance](#), and all [Antenna requirements](#) are met, the u-blox modular FCC/ISED regulatory authorization is valid and the end-product may refer to the u-blox FCC ID and ISED certification number. u-blox may be able to support updates to the u-blox regulatory authorization by adding new antennas to the u-blox authorization for example. See also [Antenna requirements](#).

 To use the u-blox FCC / ISED grant and refer to the u-blox FCC ID / ISED certification ID, the integrator must confirm with u-blox that all requirements associated with the [Configuration control and software security of end-products](#) are fulfilled.

6.4.4 Obtaining your own FCC/ISED certification ID

Integrators who do not want to refer to the u-blox FCC/ISED certification ID, or who do not fulfil all requirements to do so may instead obtain their own certification. With their own certification, the integrator has full control of the grant to make changes.

Integrators who want to base their own certification on the u-blox certification can do so via a process called “Change in ID” (FCC) / “Multiple listing” (ISED). With this, the integrator becomes the grantee of a copy of the u-blox FCC/ISED certification. u-blox will support with an approval letter that shall be filed as a Cover Letter exhibit with the application.

 For modules where the FCC ID / ISED certification ID is printed on the label, the integrator must replace the module label with a new label containing the new FCC/ISED ID. For a description of the labeling requirements, see also [End product labeling requirements](#).

 It is the responsibility of the integrator to comply with any upcoming regulatory requirements.

6.4.5 Antenna requirements

In addition to the general requirement to use only authorized antennas, the u-blox grant also requires a separation distance of at least 20 cm from the antenna(s) to all persons. The antenna(s) must not be co-located with any other antenna or transmitter (simultaneous transmission) as well. If this cannot be met, a Permissive Change as described below must be made to the grant.

 To support verification activities that may be required by certification laboratories, customers applying for Class-II Permissive changes must implement the setup described in [Software](#).

6.4.5.1 Separation distance

If the required separation distance of 20 cm cannot be fulfilled, a SAR evaluation must be performed. This consists of additional calculations and/or measurements. The result must be added to the grant file as a Class II Permissive Change.

6.4.5.2 Co-location (simultaneous transmission)

If the module is to be co-located with another transmitter, additional measurements for simultaneous transmission are required. The results must be added to the grant file as a Class II Permissive Change.

6.4.5.3 Adding a new antenna for authorization

If the authorized antennas and/or antenna trace design cannot be used, the new antenna and/or antenna trace designs must be added to the grant file. This is done by a Class I Permissive Change or a Class II Permissive Change, depending on the specific antenna and antenna trace design.

- Antennas of the same type and with less or same gain as those included in the list of [Approved antennas](#) can be added under a Class I Permissive Change.
- Antenna trace designs deviating from the u-blox reference design and new antenna types are added under a Class II Permissive Change.
- For 5 GHz modules, the combined minimum gain of antenna trace and antenna must be greater than 0 dBi to comply with DFS testing requirements.



 Integrators intending to refer to the u-blox FCC ID / ISED certification ID must [contact](#) their local support team to discuss the Permissive Change Process. Class II Permissive Changes are subject to NRE costs.

6.4.6 Configuration control and software security of end-products

 “Modular transmitter” hereafter refers to MAYA-W160 (FCC ID XPYMAYAW160), MAYA-W161 (FCC ID XPYMAYAW161), and MAYA-W166 (FCC ID XPYMAYAW166).

As the end-product must comply with the requirements addressed by the OET KDB 594280 [15], the host product integrating the MAYA-W1 must comply with the following requirements:

- Upon request from u-blox, the host product manufacturer will provide all of the necessary information and documentation to demonstrate how the requirements listed below are met.
- The host product manufacturer will not modify the modular transmitter hardware.

- The configuration of the modular transmitter when installed into the host product must be within the authorization of the modular transmitter at all times and cannot be changed to include unauthorized modes of operation through accessible interfaces of the host product. The [Wi-Fi Tx output power limits](#) must be followed. In particular, the modular transmitter installed in the host product will not have the capability to operate on the operating channels/frequencies referred to in the section(s) below, namely one or several of the following channels: 12 (2467 MHz), 13 (2472 MHz), 120 (5600 MHz), 124 (5620 MHz), and 128 (5640 MHz). The channels 12 (2467 MHz), 13 (2472 MHz), 120 (5600 MHz), 124 (5620 MHz), and 128 (5640 MHz) are allowed to be used only for modules that are certified for the usage (“modular transmitter”). Customers must verify that the module in use is certified as supporting DFS client/master functionality.
 - The host product uses only authorized firmware images provided by u-blox and/or by the manufacturer of the RF chipset used inside the modular transmitter.
 - The configuration of the modular transmitter must always follow the requirements specified in [Operating frequencies](#) and cannot be changed to include unauthorized modes of operation through accessible interfaces of the host product.
 - The modular transmitter must when installed into the host product have a regional setting that is compliant with authorized US modes and the host product is protected from being modified by third parties to configure unauthorized modes of operation for the modular transmitter, including the country code.
 - The host product into which the modular transmitter is installed does not provide any interface for the installer to enter configuration parameters into the end product that exceeds those authorized.
 - The host product into which the modular transmitter is installed does not provide any interface to third parties to upload any unauthorized firmware images into the modular transmitter and prevents third parties from making unauthorized changes to all or parts of the modular transmitter device driver software and configuration.
-  OET KDB 594280 D01 [\[15\]](#) lists the topics that must be addressed to ensure that the end-product specific host meets the Configuration Control requirements.
-  OET KDB 594280 D02 [\[15\]](#) lists the topics that must be addressed to ensure that the end-product specific host meets the Software Security Requirements for U-NII Devices.

6.4.7 Operating frequencies

MAYA-W1 802.11b/g/n operation outside the 2412–2462 MHz band is prohibited in the US and Canada and 802.11a/n operation in the 5600–5650 MHz band is prohibited in Canada. Configuration of the module to operate on channels 12–13 and 120–128 must be prevented accordingly. The channels allowed while operating under the definition of a master or client device¹⁵ are described in [Table 28](#).

¹⁵ 47 CFR §15.202

Channel number	Channel center frequency [MHz]	Master device	Client device	Remarks
1 – 11	2412 – 2462	Yes	Yes	
12 – 13	2467 – 2472	No	No	
36 – 48	5180 – 5240	Yes	Yes	Canada (ISED): Devices are restricted to indoor operation only and the end product must be labelled accordingly.
52 – 64	5260 – 5320	No ¹⁶	Yes	
100 – 116	5500 – 5580	No ¹⁶	Yes	
120 – 128	5600 – 5640	No	No	USA (FCC): Client device operation allowed under KDB 905462
132 – 140	5660 – 5700	No ¹⁶	Yes	
149 – 165	5745 – 5825	Yes	Yes	

Table 28: Allowed channel usage under FCC/ISED regulation



15.407 (j) Operator Filing Requirement:

Before deploying an aggregate total of more than one thousand outdoor access points within the 5.15–5.25 GHz band, parties must submit a letter to the Commission acknowledging that, should harmful interference to licensed services in this band occur, they will be required to take corrective action. Corrective actions may include reducing power, turning off devices, changing frequency bands, and/or further reducing power radiated in the vertical direction. This material shall be submitted to Laboratory Division, Office of Engineering and Technology, Federal Communications Commission, 7435 Oakland Mills Road, Columbia, MD 21046. Attn: U-NII Coordination, or via Web site at <https://www.fcc.gov/labhelp> with the subject line: “U-NII-1 Filing”.

6.4.8 End product labeling requirements

For an end-product using the MAYA-W1, there must be a label containing, at least, the following information:

This device contains
FCC ID: (XYZ)(UPN)
IC: (CN)-(UPN)

(XYZ) represents the FCC "Grantee Code", this code may consist of Arabic numerals, capital letters, or other characters, the format for this code will be specified by the Commission's Office of Engineering and Technology¹⁷. (CN) is the Company Number registered at ISED. (UPN) is the Unique Product Number decided by the grant owner.

The label must be affixed on an exterior surface of the end product such that it will be visible upon inspection in compliance with the modular labeling requirements of OET KDB 784748. The host user manual must also contain clear instructions on how end users can find and/or access the FCC ID of the end product.

The label on the MAYA-W1 module containing the original FCC ID acquired by u-blox can be replaced with a new label stating the end-product's FCC/ISED ID in compliance with the modular labeling requirements of OET KDB 784748.

¹⁶ DFS master certification is pending

¹⁷ 47 CFR 2.926

FCC end product labeling

The outside of final products containing the MAYA-W1 module must display in a user accessible area a label referring to the enclosed module. This exterior label can use wording such as the following: “Contains Transmitter Module FCC ID: XPYMAYAW16x” or “Contains FCC ID: XPYMAYAW16x”.

In accordance with 47 CFR § 15.19, the end product shall bear the following statement in a conspicuous location on the device:

This device complies with Part 15 of the FCC Rules. Operation is subject to the following two conditions: This device may not cause harmful interference, and This device must accept any interference received, including interference that may cause undesired operation.

ISED end product labeling

The ISED certification label of a module shall be clearly visible at all times when installed in the host device; otherwise, the host device must be labeled to display the ISED certification number for the module, preceded by the words “Contains transmitter module”, or the word “Contains”, or similar wording expressing the same meaning, as follows: “Contains transmitter module IC: 8595A-MAYAW16x”.

L'étiquette d'homologation d'ISED d'un module donné doit être posée sur l'appareil hôte à un endroit bien en vue en tout temps. En l'absence d'étiquette, l'appareil hôte doit porter une étiquette sur laquelle figure le numéro d'homologation du module d'ISED, précédé des mots « Contient un module d'émission », ou du mot « Contient », ou d'une formulation similaire allant dans le même sens et qui va comme suit : « Contient le module d'émission IC: 8595A-MAYA-W16x.

The end product shall bear the following statement in both English and French in a conspicuous location on the device:

Operation is subject to the following two conditions: This device may not cause interference, and This device must accept any interference, including interference that may cause undesired operation of the device.
--

Son utilisation est soumise aux deux conditions suivantes: Cet appareil ne doit pas causer d'interférences et il doit accepter toutes interférences reçues, y compris celles susceptibles d'avoir des effets indésirables sur son fonctionnement.

Labels of end products capable to operate within the band 5150–5250 MHz shall also include:

For indoor use only

Pour usage intérieur seulement

When the end-product is so small or for such use that it is not practical to place the above statements on it, the information shall be placed in a prominent location in the instruction manual or pamphlet supplied to the user or on the container in which the device is marketed. However, the FCC/ISED ID label must be displayed on the device.

If the end-product will be installed in locations where the end-user is not able to see the FCC/ISED ID and/or this statement, the FCC/ISED ID and the statement shall also be included in the end-product manual.

6.5 Japan radio equipment compliance

6.5.1 Compliance statement

MAYA-W1 series modules comply with the Japanese Technical Regulation Conformity Certification of Specified Radio Equipment (ordinance of MPT N°. 37, 1981), Article 2, Paragraph 1:

- Item 19 "2.4 GHz band wide band low power data communication system"
- Item 19-3 "Low power data communications system in the 5.2/5.3 GHz band"
- Item 19-3-2 "Low power data communications system in the 5.6 GHz band"

The MAYA-W1 series module is restricted on the Japanese market to be used indoors only if the product is operating in the 5.2/5.3 GHz band.

Table 29 shows the Giteki certification IDs allocated to MAYA-W1 series modules.

Model	Giteki ID
MAYA-W160-00B	MIC ID: R 022-220054, MIC ID: T D220006022
MAYA-W161-00B	MIC ID: R 022-220054, MIC ID: T D220006022
MAYA-W166-00B	MIC ID: R 022-220055, MIC ID: T D220007022
MAYA-W166-01B	MIC ID: R 022-220055, MIC ID: T D220007022

Table 29: Giteki IDs for different variants of MAYA-W1 series modules

6.5.2 End product labeling requirement

End products based on MAYA-W1 series modules and targeted for distribution in Japan must be affixed with a label with the "Giteki" marking, as shown in Figure 18 and Figure 19. The "Indoor use only" information translated into Japanese below is mandatory if the product is operating in the 5.2/5.3 GHz band. The product marking must be visible for inspection.

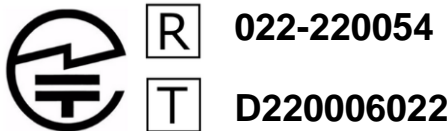

この製品は屋内においてのみ使用可能です

Figure 18: Giteki R and T marks with the MAYA-W160 and MAYA-W161 MIC certification numbers

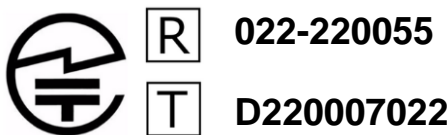

この製品は屋内においてのみ使用可能です

Figure 19: Giteki R and T marks with the MAYA-W166 MIC certification numbers

6.6 KCC South Korea compliance

The MAYA-W1 series modules are certified by the Korea Communications Commission (KCC).

Table 30 shows the KCC certification IDs allocated to MAYA-W1 series modules.

Model	KCC ID
MAYA-W160-00B	R-C-ULX-MAYA-W161-00B
MAYA-W161-00B	R-C-ULX-MAYA-W161-00B
MAYA-W166-00B	R-C-ULX-MAYA-W166-01B
MAYA-W166-01B	R-C-ULX-MAYA-W166-01B

Table 30: KCC certification IDs for different variants of MAYA-W1 series modules

End products based on MAYA-W1 series modules and targeted for distribution in South Korea must carry labels containing the KCC logo and certification number, as shown in Figure 20. This information must also be included in the product user manuals.

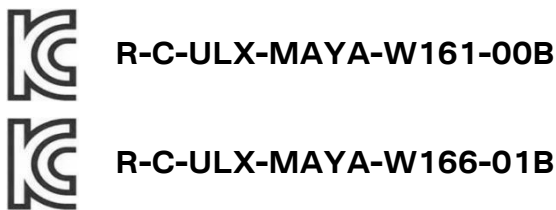

Figure 20: KCC marks with the MAYA-W160 and MAYA-W161 KCC certification numbers

 The height of the KCC logo must be at least 5 mm.

6.7 Approved antennas

Refer to the MAYA-W1 antenna reference design application note [11] for the specifications that must be fulfilled in the end product that uses radio type approval of the MAYA-W1 module. The MAYA-W1 antenna reference design application note provides PCB layout details and electrical specifications.

For Wi-Fi and BT operation in the 2.4 GHz band and Wi-Fi operation in the 5 GHz band, the MAYA-W1 series module has been tested and approved for use with the antennas listed in Table 31.

Manufacturer	Part number	Antenna type	Peak gain [dBi] / band		Validated regulatory domain	Valid for
			2.4 GHz	5 GHz		
-	-	-	2	2	US/Canada (FCC/ISED)	All variants
-	-	-	0	0	EU/Great Britain (RED/UKCA)	All variants
Taoglas	GW.59.3153	Dual-band dipole antenna	3.8	5.3	US/Canada/EU/Great Britain (FCC/ISED/RED/UKCA)	MAYA-W160-00B MAYA-W161-00B
Molex	146153-0100	Dual-band PCB patch	3.0	4.0	US/Canada/EU/Great Britain (FCC/ISED/RED/UKCA)	MAYA-W160-00B MAYA-W161-00B
Linx Technologies	ANT-DB1-RAF	Dual-band dipole antenna	4.1	5.1	US/Canada/EU/Great Britain (FCC/ISED/RED/UKCA)	MAYA-W160-00B MAYA-W161-00B
Linx Technologies	ANT-DB1-RAF	Dual-band dipole antenna	4.1	5.1	South Korea (KCC)	All variants

Linx Technologies	ANT-2.4-CW-RCT-RP	Single-band dipole antenna	2.2	-	South Korea (KCC)	All variants
-------------------	-------------------	----------------------------	-----	---	-------------------	--------------

Table 31: List of approved antennas



No antennas have been used for FCC/ISED and RED/UKCA certifications. All radiated measurements were performed with 50 Ω terminations. The power limits in [Wi-Fi transmit output power limits](#) are valid for the antenna gains stated in [Table 31](#).



For compliance with FCC §15.407(a) the EIRP must not exceed 125 mW (21 dBm) at any elevation angle above 30 degrees – as measured from the horizon when operated as an outdoor access point in U-NII-1 band, 5.150-5.250 GHz.

7 Product testing

7.1 u-blox in-line production testing

As part of our focus on high quality products, u-blox maintain stringent quality controls throughout the production process. This means that all units in our manufacturing facilities are fully tested and that any identified defects are carefully analyzed to improve future production quality.

The Automatic test equipment (ATE) deployed in u-blox production lines logs all production and measurement data – from which a detailed test report for each unit can be generated. [Figure 21](#) shows the ATE typically used during u-blox production.

u-blox in-line production testing includes:

- Digital self-tests (firmware download, MAC address programming)
- Measurement of voltages and currents
- Functional tests (host interface communication)
- Digital I/O tests
- Measurement and calibration of RF characteristics in all supported bands, including RSSI calibration, frequency tuning of reference clock, calibration of transmitter power levels, etc.
- Verification of Wi-Fi and Bluetooth RF characteristics after calibration, like modulation accuracy, power levels, and spectrum, are checked to ensure that all characteristics are within tolerance when the calibration parameters are applied.



Figure 21: Automatic test equipment for module test

7.2 OEM manufacturer production test

As all u-blox products undergo thorough in-series production testing prior to delivery, OEM manufacturers do not need to repeat any firmware tests or measurements that might otherwise be necessary to confirm RF performance. Testing over analog and digital interfaces is also unnecessary during an OEM production test.

OEM manufacturer testing should ideally focus on:

- Module assembly on the device; it should be verified that:
 - Soldering and handling process did not damage the module components
 - All module pins are well soldered on the application board
 - There are no short circuits between pins
- Component assembly on the device; it should be verified that:
 - Communication with host controller can be established
 - The interfaces between module and device are working
 - Overall RF performance test of the device including antenna

In addition to this testing, OEMs can also perform other dedicated tests to check the device. For example, the measurement of module current consumption in a specified operating state can identify a short circuit if the test result deviates that from that taken against a “Golden Device”.

The standard operational module firmware and test software on the host can be used to perform functional tests (communication with the host controller, interface checks, etc.) and perform basic RF performance testing. Special manufacturing firmware can also be used to perform more advanced RF performance tests.

Appendix

Wi-Fi transmit output power limits

A.1 FCC / ISED regulatory domain

Table 33 and Table 35 list the maximum allowable conducted¹⁸ output power limits for operation in the FCC/ISED regulatory domains. The output power limits are applicable with an external antenna gain of 2 dBi.

A.1.1 Wi-Fi output power for 2.4 GHz band

Mode	Channel(s)	Maximum power setting
802.11b, CCK/DSSS	1 – 11	16 dBm
802.11g, OFDM	1, 11	14 dBm
	2 – 9	16 dBm
	10	15 dBm
802.11n, HT20	1, 11	13 dBm
	2 – 10	14 dBm
802.11n, HT40	3, 4	12 dBm
	5, 7 – 9	13 dBm
	6	14 dBm

Table 32: FCC / ISED Wi-Fi power table for operation in the 2.4 GHz band for MAYA-W160-00B and MAYA-W161-00B

Mode	Channel(s)	Maximum power setting
802.11b, CCK/DSSS	1 – 11	18 dBm
802.11g, OFDM	1 – 11	16 dBm
802.11n, HT20	1, 11	15 dBm
	2 – 10	16 dBm
802.11n, HT40	3, 4	14 dBm
	5, 7 – 9	15 dBm
	6	16 dBm

Table 33: FCC / ISED Wi-Fi power table for operation in the 2.4 GHz band for MAYA-W166-0xB

¹⁸ Output power at the antenna connector, without antenna gain.

A.1.2 Wi-Fi output power for 5 GHz band

Mode	Channel(s)	Maximum power setting
802.11a, OFDM	36 – 48, 52 – 60, 157	14 dBm
	64, 100, 136, 149, 153	13 dBm
	104 – 132, 161, 165	15 dBm
	140	13 dBm
802.11n, HT20	36 – 48, 52 – 60, 104 – 136, 149 – 165	13 dBm
	64, 100	12 dBm
	140	11 dBm
802.11n, HT40	38, 62	11 dBm
	46, 54, 110 – 126, 151, 159	13 dBm
	102, 134	10 dBm

Table 34: FCC / ISED Wi-Fi power table for operation in the 5 GHz bands for MAYA-W160-00B and MAYA-W161-00B

Mode	Channel(s)	Maximum power setting
802.11a, OFDM	36 – 48, 52 – 60, 157	17 dBm
	64, 100, 136, 149, 153	16 dBm
	104 – 132, 161, 165	18 dBm
	140	14 dBm
802.11n, HT20	36 – 48, 52 – 60, 104 – 136, 149 – 165	16 dBm
	64, 100	15 dBm
	140	14 dBm
802.11n, HT40	38, 62	14 dBm
	46, 54, 110 – 126, 151, 159	16 dBm
	102, 134	13 dBm

Table 35: FCC / ISED Wi-Fi power table for operation in the 5 GHz bands for MAYA-W166-0xB

A.2 RED and UKCA regulatory domains

Table 36 and Table 38 list the maximum allowable conducted¹⁸ output power limits for operation in the RED and UKCA regulatory domains. The output power limits are applicable with an external antenna gain of 0 dBi.

A.2.1 Wi-Fi output power for 2.4 GHz band

Mode	Channel(s)	Maximum power setting
802.11b, CCK/DSSS	1 – 13	13 dBm
802.11g, OFDM	1 – 13	13 dBm
802.11n, HT20	1 – 13	11 dBm
802.11n, HT40	3 – 11	11 dBm

Table 36: RED Wi-Fi power table for operation in the 2.4 GHz band for MAYA-W160-00B and MAYA-W161-00B

Mode	Channel(s)	Maximum power setting
802.11b, CCK/DSSS	1 – 13	18 dBm
802.11g, OFDM	1 – 13	18 dBm
802.11n, HT20	1 – 13	16 dBm
802.11n, HT40	3 – 11	16 dBm

Table 37: RED Wi-Fi power table for operation in the 2.4 GHz band for MAYA-W166-0xB

A.2.2 Wi-Fi output power for 5 GHz band

Mode	Channel(s)	Maximum power setting
802.11a, OFDM	36 – 64, 100 – 140, 149 - 165	12 dBm
802.11n, HT20	36 – 64, 100 – 140, 149 - 165	10 dBm
802.11n, HT40	38 – 62, 102 – 134, 151, 159	10 dBm

Table 38: RED Wi-Fi power table for operation in the 5 GHz bands for MAYA-W160-00B and MAYA-W161-00B

Mode	Channel(s)	Maximum power setting
802.11a, OFDM	36 – 64, 100 – 140	18 dBm
	149 – 165	12 dBm
802.11n, HT20	36 – 64, 100 – 140	16 dBm
	149 – 165	12 dBm
802.11n, HT40	38 – 62, 102 – 134	16 dBm
	151, 159	12 dBm

Table 39: RED Wi-Fi power table for operation in the 5 GHz bands for MAYA-W166-0xB

A.3 Japan regulatory domain (Giteki)

A.3.1 Wi-Fi output power for 2.4 GHz band

Mode	Channel(s)	Maximum power setting
802.11b, CCK/DSSS	1 – 13	18 dBm
802.11g, OFDM	1 – 13	18 dBm
802.11n, HT20	1 – 13	16 dBm
802.11n, HT40	3 – 11	16 dBm

Table 40: Japan Wi-Fi power table for operation in the 2.4 GHz band

A.3.2 Wi-Fi output power for 5 GHz band

Mode	Channel(s)	Maximum power setting
802.11a, OFDM	36 – 64, 100 – 144	18 dBm
802.11n, HT20	36 – 64, 100 – 144	16 dBm
802.11n, HT40	38 – 62, 102 – 142	16 dBm

Table 41: Japan Wi-Fi power table for operation in the 5 GHz bands

A.4 South Korea regulatory domain (KCC)

A.4.1 Wi-Fi output power for 2.4 GHz band

Mode	Channel(s)	Maximum power setting
802.11b, CCK/DSSS	1 – 13	18 dBm
802.11g, OFDM	1 – 13	18 dBm
802.11n, HT20	1 – 13	16 dBm
802.11n, HT40	3 – 11	16 dBm

Table 42: KCC Wi-Fi power table for operation in the 2.4 GHz band

A.4.2 Wi-Fi output power for 5 GHz band

Mode	Channel(s)	Maximum power setting
802.11a, OFDM	36 – 64, 100 – 144, 149 – 165	18 dBm
802.11n, HT20	36 – 64, 100 – 144, 149 – 165	16 dBm
802.11n, HT40	38 – 62, 102 – 142, 151 – 159	16 dBm

Table 43: KCC Wi-Fi power table for operation in the 5 GHz bands

Glossary

Abbreviation	Definition
AEC	Automotive Electronics Council
AP	Access Point
API	Application Programming Interface
ATE	Automatic Test Equipment
BT	Bluetooth
CDM	Charged Device Model
CE	European Conformity
CTS	Clear to Send
DC	Direct Current
DDR	Double Data Rate
DFS	Dynamic Frequency Selection
DHCP	Dynamic Host Configuration Interface
EDR	Enhanced Data Rate
EEPROM	Electrically Erasable Programmable Read-Only Memory
EIRP	Equivalent Isotropic Radiated Power
EMI	Electromagnetic Interference
ESD	Electro Static Discharge
ESL	Equivalent Series Inductance
ESR	Equivalent Series Resistance
FCC	Federal Communications Commission
GND	Ground
GPIO	General Purpose Input/Output
HBM	Human Body Model
HS	High-Speed
HCI	Host Controller Interface
ISED	Innovation, Science and Economic Development Canada
I2C	Inter-Integrated Circuit
KDB	Knowledge Database
LAN	Local Area Network
LDO	Low Drop Out
LED	Light-Emitting Diode
LPO	Low Power Oscillator
LTE	Long Term Evolution
MAC	Medium Access Control
MMC	Multi Media Card
MWS	Mobile Wireless Standards
NRE	Non-recurring engineering
NSMD	Non Solder Mask Defined
OEM	Original equipment manufacturer
OET	Office of Engineering and Technology
OS	Operating System
PCB	Printed Circuit Board
PCI	Peripheral Component Interconnect

Abbreviation	Definition
PCIe	PCI Express
PCM	Pulse-code modulation
PHY	Physical layer (of the OSI model)
PMU	Power Management Unit
RF	Radio Frequency
RSDB	Real Simultaneous Dual Band
RST	Request to Send
SDIO	Secure Digital Input Output
SMD	Solder Mask Defined
SMPS	Switching Mode Power Supply
SMT	Surface-Mount Technology
SSID	Service Set Identifier
STA	Station
TBD	To be Decided
THT	Through-Hole Technology
UART	Universal Asynchronous Receiver-Transmitter
VCC	IC power-supply pin
VIO	Input offset voltage
VSDB	Virtual Simultaneous Dual Band
VSWR	Voltage Standing Wave Ratio
WFD	Wi-Fi Direct
WLAN	Wireless local area network
WPA	Wi-Fi Protected Access

Table 44: Explanation of the abbreviations and terms used

Related documents

- [1] MAYA-W1 series data sheet, [UBX-21006380](#)
- [2] Packaging information reference, [UBX-14001652](#)
- [3] u-blox Limited Use License Agreement, LULA-M
- [4] IEC EN 61000-4-2 - Electromagnetic compatibility (EMC) - Part 4-2: Testing and measurement techniques – Electrostatic discharge immunity test
- [5] ETSI EN 301 489-1 - Electromagnetic compatibility and Radio spectrum Matters (ERM); ElectroMagnetic Compatibility (EMC) standard for radio equipment and services; Part 1: Common technical requirements
- [6] IEC61340-5-1 - Protection of electronic devices from electrostatic phenomena – General requirements
- [7] JEDEC J-STD-020E - Moisture/Reflow Sensitivity Classification for Nonhermetic Surface Mount Devices
- [8] ETSI EN 60950-1:2006 - Information technology equipment – Safety – Part 1: General requirements
- [9] FCC Regulatory Information, Title 47 – Telecommunication
- [10] JESD51 – Overview of methodology for thermal testing of single semiconductor devices
- [11] MAYA-W1 antenna reference design application note, [UBX-22022671](#)
- [12] [Embedded Linux for i.MX Applications Processors](#)
- [13] [MCUXpresso Software Development Kit \(SDK\)](#)
- [14] [NXP UM11490, Feature Configuration Guide for NXP-based Wireless Modules on i.MX 8M Quad EVK](#)
- [15] FCC guidance [594280 D01 Configuration Control v02 r01](#),
- [16] FCC guidance [594280 D02 U-NII Device Security v01r03](#)
- [17] MAYA-W1 product summary, [UBX-20047825](#)
- [18] UKCA Declaration of Conformity, [UBX-22036489](#)
- [19] EU Declaration of Conformity, [UBX-22018372](#)



For product change notifications and regular updates of u-blox documentation, register on our website, www.u-blox.com.

Revision history

Revision	Date	Name	Comments
R01	21-Jul-2021	lber, mzes	Initial release.
R02	04-Jan-2022	lber, mzes, mape	Editorial changes, including content restructuring in several sections throughout the document. SDIO line Pull-up resistor recommendation added in SDIO 3.0 interface and SDIO 3.0 . Aligned Pin list with the MAYA-W1 data sheet. Revised Module integration .
R03	04-Mar-2022	lber	Updated Block diagrams in Figure 1 and Figure 2 (removed LDO with 1V8 output supply shown in previous document release). Alternative start-up sequence added to Figure 8 in Power-up sequence section.
R04	04-May-2022	lber	Affirmed MAYA-W166-00B as the product variant with integrated antenna and included details of its integration in Antenna interfaces . Extended document scope to include product variant MAYA-W166-01B in Document information . Reorganized power management information under new Power states section and created new System function interfaces section.
R05	04-Jul-2022	lber, mzes	Added Pre-approved antennas . Updated Software architecture and added Linux drivers bring-up , Configuration of TX power limits and energy detection , and Assigning MAC addresses in the Software section. Updated Configuration control and software security of end-products . Updated contact information.
R06	08-May-2023	lber, mzes	Extended document scope to include MAYA-W161-00C variant: Included in Document information and all other relevant sections. Revised document Abstract. Added Antenna Diversity section. Updated Open-source Linux/Android drivers information. Updated FCC/ISED Operating frequencies . Restructured Regulatory compliance section with rationalized content moved from the data sheet. Added also Japan radio equipment compliance , KCC South Korea compliance , Great Britain regulatory compliance , and Wi-Fi transmit output power limits . Included parameter descriptions in the RF transmission line design . Updated ESD guidelines . Updated Configuration pins section.
R07	6-Sept-2023	lber, frca	Included information relating to use of special manufacturing firmware for advanced RF performance tests in OEM manufacturer production test . Removed Pin definition section with added reference to data sheet. Updated Antenna Diversity . Updated certification information to include antennas and related power settings for MAYA-W160 and -W161.

Contact

u-blox AG

Address: Zürcherstrasse 68
8800 Thalwil
Switzerland

For further support and contact information, visit us at www.u-blox.com/support.