

# FCC Measurement/Technical Report on WLAN and Bluetooth Module MAYA W160

FCC ID: XPYMAW160  
IC: 8595A-MAYAW160

**Test Report Reference:** MDE\_UBLOX\_2110\_FCC\_06

**Test Laboratory:**

7layers GmbH  
Borsigstrasse 11  
40880 Ratingen  
Germany



Deutsche  
Akkreditierungsstelle  
D-PL-12140-01-01  
D-PL-12140-01-02  
D-PL-12140-01-03

**Note:**

The following test results relate only to the devices specified in this document. This report shall not be reproduced in parts without the written approval of the test laboratory.

**7layers GmbH**

Borsigstraße 11  
40880 Ratingen, Germany  
T +49 (0) 2102 749 0  
F +49 (0) 2102 749 350

Geschäftsführer/  
Managing Directors:  
Sebastian Doose  
Stefan Kischka  
Bernhard Retka

Registergericht/registered:  
Düsseldorf HRB 75554  
USt-Id.-Nr./VAT-No. DE203159652  
Steuer-Nr./TAX-No. 147/5869/0385

*a Bureau Veritas  
Group Company*

*www.7layers.com*

## Table of Contents

<b>1 Applied Standards and Test Summary</b>	<b>3</b>
1.1 Applied Standards	3
1.2 FCC-IC Correlation Table	4
1.3 Measurement Summary	4
<b>2 Revision History / Signatures</b>	<b>6</b>
<b>3 Administrative Data</b>	<b>7</b>
3.1 Testing Laboratory	7
3.2 Project Data	7
3.3 Applicant Data	7
3.4 Manufacturer Data	8
<b>4 Test object Data</b>	<b>9</b>
4.1 General EUT Description	9
4.2 EUT Main components	9
4.3 Ancillary Equipment	10
4.4 Auxiliary Equipment	10
4.5 EUT Setups	10
4.6 Operating Modes / Test Channels	11
4.7 Product labelling	11
<b>5 Test Results</b>	<b>12</b>
5.1 Transmitter Spurious Radiated Emissions	12
5.2 Band Edge Compliance Radiated	28
<b>6 Test Equipment</b>	<b>35</b>
6.1 Test Equipment Hardware	35
6.2 Test Equipment Software	35
<b>7 Antenna Factors, Cable Loss and Sample Calculations</b>	<b>38</b>
7.1 LISN R&S ESH3-Z5 (150 kHz – 30 MHz)	38
7.2 Antenna R&S HFH2-Z2 (9 kHz – 30 MHz)	39
7.3 Antenna R&S HL562 (30 MHz – 1 GHz)	40
7.4 Antenna R&S HF907 (1 GHz – 18 GHz)	41
7.5 Antenna EMCO 3160-09 (18 GHz – 26.5 GHz)	42
7.6 Antenna EMCO 3160-10 (26.5 GHz – 40 GHz)	43
<b>8 Measurement Uncertainties</b>	<b>44</b>
<b>9 Photo Report</b>	<b>45</b>

## 1 APPLIED STANDARDS AND TEST SUMMARY

### 1.1 APPLIED STANDARDS

#### **Type of Authorization**

Certification for an Intentional Radiator.

#### **Applicable FCC Rules**

Prepared in accordance with the requirements of FCC Rules and Regulations as listed in 47 CFR Ch.1 Parts 2 and 15 (10-1-21 Edition). The following subparts are applicable to the results in this test report.

Part 2, Subpart J - Equipment Authorization Procedures, Certification

Part 15, Subpart C – Intentional Radiators

§ 15.201 Equipment authorization requirement

§ 15.207 Conducted limits

§ 15.209 Radiated emission limits; general requirements

§ 15.247 Operation within the bands 902-928 MHz, 2400-2483.5 MHz

#### **Note:**

The tests were selected and performed with reference to the FCC Public Notice "Guidance for Compliance Measurements on Digital Transmission System, Frequency Hopping Spread Spectrum System, and Hybrid System Devices Operating under Section 15.247 of the FCC Rules, 558074 D01 15.247 Meas Guidance v05r02, 2019-04-02". ANSI C63.10-2013 is applied.

## 1.2 FCC-IC CORRELATION TABLE

### Correlation of measurement requirements for DTS (e.g. WLAN 2.4 GHz, BT LE) equipment from FCC and IC

#### DTS equipment

Measurement	FCC reference	IC reference
Conducted emissions on AC Mains	§ 15.207	RSS-Gen Issue 5: 8.8
Occupied bandwidth	§ 15.247 (a) (2)	RSS-247 Issue 2: 5.2 (a)
Peak conducted output power	§ 15.247 (b) (3), (4)	RSS-247 Issue 2: 5.4 (d)
Transmitter spurious RF conducted emissions	§ 15.247 (d)	RSS-Gen Issue 5: 6.13 / 8.9/8.10; RSS-247 Issue 2: 5.5
Transmitter spurious radiated emissions	§ 15.247 (d); § 15.209 (a)	RSS-Gen Issue 5: 6.13 / 8.9/8.10; RSS-247 Issue 2: 5.5
Band edge compliance	§ 15.247 (d)	RSS-247 Issue 2: 5.5
Power density	§ 15.247 (e)	RSS-247 Issue 2: 5.2 (b)
Antenna requirement	§ 15.203 / 15.204	RSS-Gen Issue 5: 8.3
Receiver spurious emissions	-	-

### 1.3 MEASUREMENT SUMMARY

**47 CFR CHAPTER I FCC PART 15 § 15.247 (d)**  
**Subpart C §15.247**

Transmitter Spurious Radiated Emissions

The measurement was performed according to ANSI C63.10, chapter 6.4, 6.5, 6.6.5

**Final Result**

<b>OP-Mode</b>	<b>Setup</b>	<b>Date</b>	<b>FCC</b>	<b>IC</b>
Radio Technology, Operating Frequency, Measurement range				
Bluetooth BDR, high, 1 GHz - 26 GHz	S01_160_AC03	2022-08-15	Passed	Passed
Bluetooth BDR, high, 30 MHz - 1 GHz	S01_160_AC03	2022-09-05	Passed	Passed
Bluetooth BDR, low, 1 GHz - 26 GHz	S01_160_AC03	2022-10-20	Passed	Passed
Bluetooth BDR, low, 30 MHz - 1 GHz	S01_160_AC03	2022-09-05	Passed	Passed
Bluetooth BDR, mid, 1 GHz - 26 GHz	S01_160_AC03	2022-10-20	Passed	Passed
Bluetooth BDR, mid, 30 MHz - 1 GHz	S01_160_AC03	2022-09-05	Passed	Passed
Bluetooth BDR, mid, 9 kHz - 30 MHz	S01_160_AC03	2022-09-05	Passed	Passed
WLAN b, high, 1 GHz - 26 GHz	S01_160_AC03	2022-08-15	Passed	Passed
WLAN b, high, 30 MHz - 1 GHz	S01_160_AC03	2022-09-05	Passed	Passed
WLAN b, mid, 9 kHz - 30 MHz	S01_160_AC03	2022-09-05	Passed	Passed

**47 CFR CHAPTER I FCC PART 15 § 15.247 (d)**  
**Subpart C §15.247**

Band Edge Compliance Radiated

The measurement was performed according to ANSI C63.10, chapter 6.6.5

**Final Result**

<b>OP-Mode</b>	<b>Setup</b>	<b>Date</b>	<b>FCC</b>	<b>IC</b>
Radio Technology, Operating Frequency, Band Edge				
Bluetooth BDR, high, high	S01_160_AC03	2022-08-22	Passed	Passed
Bluetooth EDR 2, high, high	S01_160_AC03	2022-10-20	Passed	Passed
Bluetooth EDR 3, high, high	S01_160_AC03	2022-10-20	Passed	Passed
WLAN b, high, high	S01_160_AC03	2022-08-22	Passed	Passed

N/A: Not applicable

N/P: Not performed

## 2 REVISION HISTORY / SIGNATURES

Report version control			
Version	Release date	Change Description	Version validity
initial	2022-10-31	--	valid
--	--	--	--

COMMENT: According to the applicant the MAYA-W160 is identical to the MAYA-W161 except for having U.FL antenna connectors. Due to this only radiated spurious emissions testing has been performed. Report of MAYA-W161 variant: MDE\_UBLOX\_2110\_FCC\_01

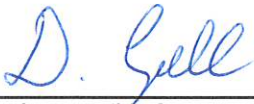

(responsible for accreditation scope)  
Dipl.-Ing. Daniel Gall

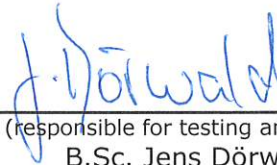

(responsible for testing and report)  
B.Sc. Jens Dörwald



7 layers GmbH, Borsigstr. 11  
40880 Ratingen, Germany  
Phone +49 (0)2102 749 0

### 3 ADMINISTRATIVE DATA

#### 3.1 TESTING LABORATORY

Company Name: 7layers GmbH  
Address: Borsigstr. 11  
40880 Ratingen  
Germany

The test facility is accredited by the following accreditation organisation:

Laboratory accreditation no: DAKKS D-PL-12140-01-01 | -02 | -03  
FCC Designation Number: DE0015  
FCC Test Firm Registration: 929146  
ISED CAB Identifier DE0007; ISED#: 3699A

Responsible for accreditation scope: Dipl.-Ing. Daniel Gall

Report Template Version: 2022-05-25

#### 3.2 PROJECT DATA

Responsible for testing and report: B.Sc. Jens Dörwald  
Employees who performed the tests: documented internally at 7Layers  
Date of Report: 2022-10-31  
Testing Period: 2022-08-15 to 2022-10-20

#### 3.3 APPLICANT DATA

Company Name: u-blox AG  
Address: Zürcherstrasse 68  
8800 Thalwil  
Switzerland  
Contact Person: Filip Kruzela

### 3.4 MANUFACTURER DATA

Company Name: please see Applicant Data

Address:

Contact Person:



## 4 TEST OBJECT DATA

### 4.1 GENERAL EUT DESCRIPTION

Kind of Device product description	Host-based module with WLAN and Bluetooth technology
Product name	MAYA W160-00B-00
Type	MAYA W160-00B-00
<b>Declared EUT data by the supplier</b>	
Voltage Type	DC
Voltage Level	1.8 V + 3.3 V
Antenna / Gain	External / 2 dBi (No antennas were provided for the tests, radiated measurements were performed with 50 Ohm terminations)
Tested Modulation Type	BT Classic: GFSK (BDR), Pi/4 DQPSK (EDR 2), 8DPSK (EDR 3) BT LE: GFSK WLANb: DSSS WLANg/n: OFDM
Specific product description for the EUT	The EUT is a Bluetooth and WLAN module. In the 2.4 GHz band it supports SISO Mode only. Supported technologies are Bluetooth Classic, Bluetooth Low Energy and WLAN b, g, n 20 and 40 MHz bandwidth.
EUT ports (connected cables during testing):	Enclosure Data DC Antenna The EUT is a module with solder pads for surface mounting, so no cables were connected to the EUT itself.
Tested datarates	BT Classic: 1 (BDR), 2 (EDR 2) and 3 Mbps (EDR 3) BT LE: 1 and 2 Mbps WLAN b: 1 Mbps, g: 6 Mbps, n: MCS 0
Special software used for testing	Scripts were provided by the applicant on a laptop that control a board computer, which sets the test modes of the EUT.

### 4.2 EUT MAIN COMPONENTS

Sample Name	Sample Code	Description
MAYA W160 AC03	DE1015157ac03	
Sample Parameter	Value	
Serial No.	M426C1DEB90FBA80400	
HW Version	04	
SW Version	W16.92.21.p22-16.92.21.p22-MXM5X16298_V0	
Comment		

NOTE: The short description is used to simplify the identification of the EUT in this test report.

### 4.3 ANCILLARY EQUIPMENT

For the purposes of this test report, ancillary equipment is defined as equipment which is used in conjunction with the EUT to provide operational and control features to the EUT. It is necessary to configure the system in a typical fashion, as a customer would normally use it. But nevertheless Ancillary Equipment can influence the test results.

<b>Device</b>	<b>Details (Manufacturer, Type Model, OUT Code)</b>	<b>Description</b>
-	-	-

### 4.4 AUXILIARY EQUIPMENT

For the purposes of this test report, auxiliary equipment is defined as equipment which is used temporarily to enable operational and control features especially used for the tests of the EUT which is not used during normal operation or equipment that is used during the tests in combination with the EUT but is not subject of this test report. It is necessary to configure the system in a typical fashion, as a customer would normally use it. But nevertheless Auxiliary Equipment can influence the test results.

<b>Device</b>	<b>Details (Manufacturer, Type Model, HW, SW, S/N)</b>	<b>Description</b>
AUX1	UBLOX, MAYA-W1 EVK, Rev. A, - , 10000002386976004002	Evaluation Board for module providing ports

### 4.5 EUT SETUPS

This chapter describes the combination of EUTs and equipment used for testing. The rationale for selecting the EUTs, ancillary and auxiliary equipment and interconnecting cables, is to test a representative configuration meeting the requirements of the referenced standards.

<b>Setup</b>	<b>Combination of EUTs</b>	<b>Description and Rationale</b>
S01_160_AC03	MAYA W160 AC03, AUX1,	Radiated Setup

## 4.6 OPERATING MODES / TEST CHANNELS

This chapter describes the operating modes of the EUTs used for testing.

<b>WLAN</b> <b>20 MHz Test Channels:</b>	<b>2.4 GHz ISM</b> <b>2400 - 2483.5 MHz</b>		
	<b>low</b>	<b>mid</b>	<b>high</b>
	<b>Channel:</b> 1	6	11
<b>Frequency [MHz]</b>	2412	2437	2462

<b>40 MHz Test Channels:</b>	<b>low</b>	<b>mid</b>	<b>high</b>
	3	6	9
	<b>Channel:</b>	2422	2437
<b>Frequency [MHz]</b>			

<b>BT Test Channels:</b>	<b>2.4 GHz ISM</b> <b>2400 - 2483.5 MHz</b>		
	<b>low</b>	<b>mid</b>	<b>high</b>
	0	39	78
<b>Channel:</b>	2402	2441	2480
<b>Frequency [MHz]</b>			

<b>BT LE Test Channels:</b>	<b>2.4 GHz ISM</b> <b>2400 - 2483.5 MHz</b>		
	<b>low</b>	<b>mid</b>	<b>high</b>
	0	19	39
<b>Channel:</b>	2402	2440	2480
<b>Frequency [MHz]</b>			

## 4.7 PRODUCT LABELLING

### 4.7.1 FCC ID LABEL

Please refer to the documentation of the applicant.

### 4.7.2 LOCATION OF THE LABEL ON THE EUT

Please refer to the documentation of the applicant.

## 5 TEST RESULTS

### 5.1 TRANSMITTER SPURIOUS RADIATED EMISSIONS

Standard **FCC Part 15 Subpart C**

**The test was performed according to:**

ANSI C63.10, chapter 6.4, 6.5, 6.6.5

#### 5.1.1 TEST DESCRIPTION

The test set-up was made in accordance to the general provisions of ANSI C63.10 in a typical installation configuration. The measurements were performed according the following sub-chapters of ANSI C63.10:

- < 30 MHz: Chapter 6.4
- 30 MHz – 1 GHz: Chapter 6.5
- > 1 GHz: Chapter 6.6 (procedure according 6.6.5 used)

The measurement procedure is implemented into the EMI test software EMC32 from R&S. Exploratory tests are performed at 3 orthogonal axes to determine the worst-case orientation of a body-worn or handheld EUT. The final test on all kind of EUTs is also performed at 3 axes. A pre-check is performed while the EUT is powered.

#### **Below 1 GHz:**

The Equipment Under Test (EUT) was set up on a non-conductive table in the semi-anechoic chamber. The influence of the EUT support table that is used between 30–1000 MHz was evaluated.

#### **1. Measurement up to 30 MHz**

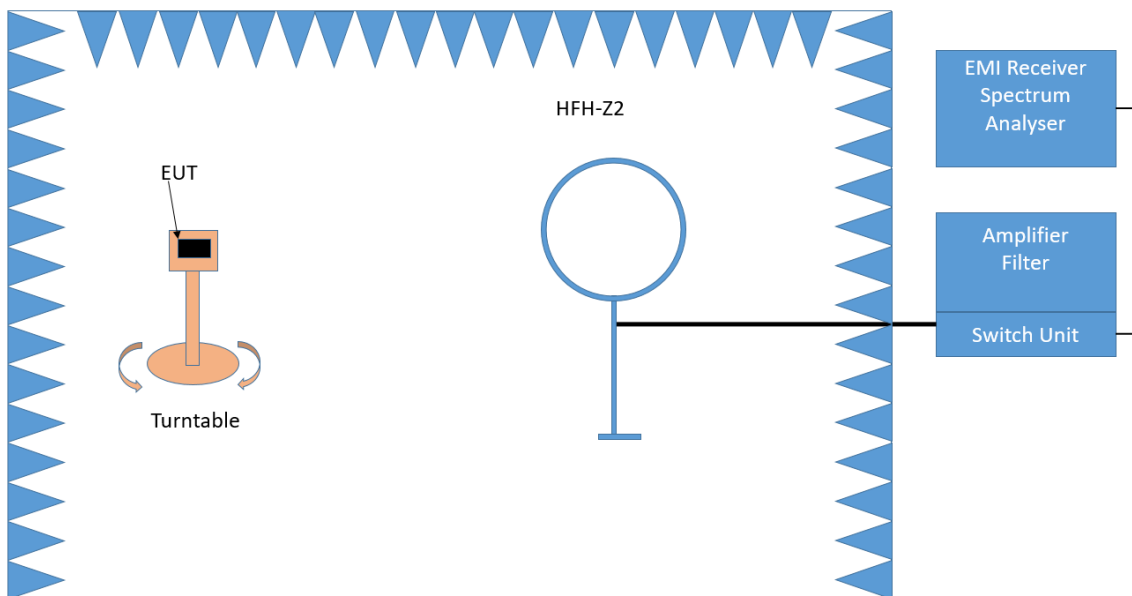

Test Setup; Spurious Emission Radiated (SAC), 9 kHz – 30 MHz

The Loop antenna HFH2-Z2 is used.

**Step 1:** pre measurement

- Anechoic chamber
- Antenna distance: 3 m
- Antenna height: 1 m
- Detector: Peak-Maxhold
- Frequency range: 0.009 - 0.15 MHz and 0.15 - 30 MHz
- Frequency steps: 0.05 kHz and 2.25 kHz
- IF-Bandwidth: 0.2 kHz and 9 kHz
- Measuring time / Frequency step: 100 ms (FFT-based)

Intention of this step is, to determine the radiated EMI-profile of the EUT. Afterwards the relevant emissions for the final measurement are identified.

**Step 2:** final measurement

For the relevant emissions determined in step 1, an additional measurement with the following settings will be performed. Intention of this step is to find the maximum emission level.

- Detector: Quasi-Peak (9 kHz - 150 kHz, Peak / Average 150 kHz- 30 MHz)
- Frequency range: 0.009 - 30 MHz
- Frequency steps: measurement at frequencies detected in step 1
- IF-Bandwidth: 0.2 - 10 kHz
- Measuring time / Frequency step: 1 s

**2. Measurement above 30 MHz and up to 1 GHz**

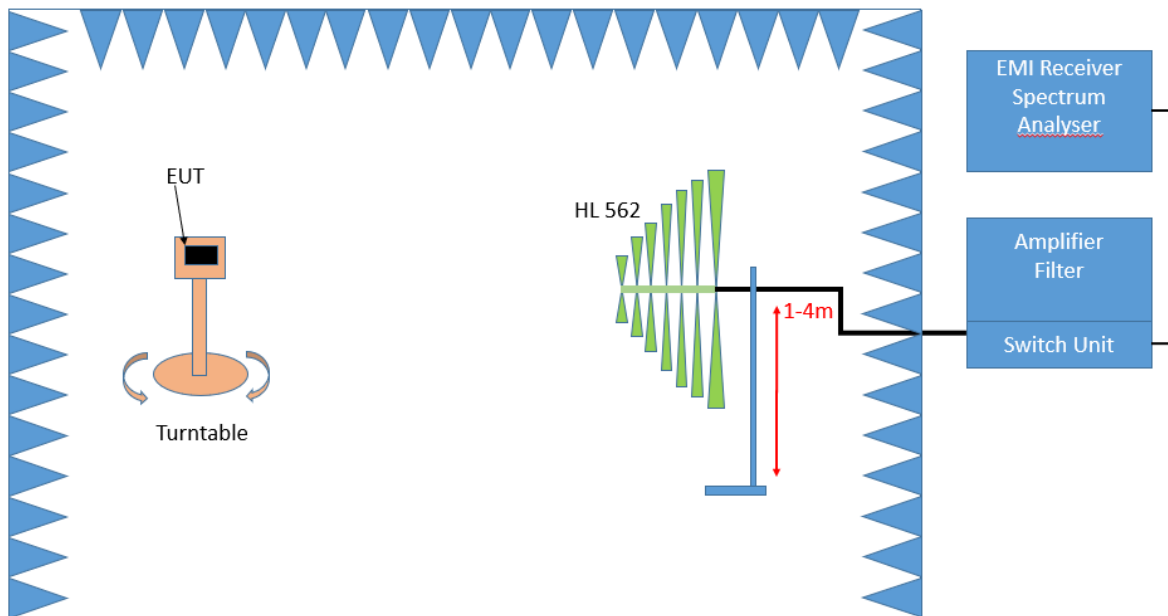

Test Setup; Spurious Emission Radiated (SAC), 30 MHz- 1GHz

**Step 1:** Preliminary scan

This is a preliminary test to identify the highest amplitudes relative to the limit.

Settings for step 1:

- Antenna distance: 3 m
- Detector: Peak-Maxhold / Quasipeak (FFT-based)
- Frequency range: 30 - 1000 MHz
- Frequency steps: 30 kHz

- IF-Bandwidth: 120 kHz
- Measuring time / Frequency step: 100 ms
- Turntable angle range:  $-180^{\circ}$  to  $90^{\circ}$
- Turntable step size:  $90^{\circ}$
- Height variation range: 1 – 4 m
- Height variation step size: 1.5 m
- Polarisation: Horizontal + Vertical

Intention of this step is, to determine the radiated EMI-profile of the EUT. Afterwards the relevant emissions for the final measurement are identified.

### **Step 2:** Adjustment measurement

In this step the accuracy of the turntable azimuth and antenna height will be improved. This is necessary to find out the maximum value of every frequency.

For each frequency, which was determined the turntable azimuth and antenna height will be adjusted. The turntable azimuth will slowly vary by  $360^{\circ}$ . During this action, the value of emission is continuously measured. The turntable azimuth at the highest emission will be recorded and adjusted. In this position, the antenna height will also slowly vary between 1 – 4 meter. During this action, the value of emission is also continuously measured. The antenna height of the highest emission will also be recorded and adjusted.

- Detector: Peak – Maxhold
- Measured frequencies: in step 1 determined frequencies
- IF – Bandwidth: 120 kHz
- Measuring time: 100 ms
- Turntable angle range:  $360^{\circ}$
- Height variation range: 1 – 4 m
- Antenna Polarisation: max. value determined in step 1

### **Step 3:** Final measurement with QP detector

With the settings determined in step 2, the final measurement will be performed:

EMI receiver settings for step 3:

- Detector: Quasi-Peak ( $< 1$  GHz)
- Measured frequencies: in step 1 determined frequencies
- IF – Bandwidth: 120 kHz
- Measuring time: 1 s

After the measurement a plot will be generated which contains a diagram with the results of the preliminary scan and a chart with the frequencies and values of the results of the final measurement.

### Above 1 GHz:

The Equipment Under Test (EUT) was set up on a non-conductive support (tilt device) at 1.5 m height in the fully-anechoic chamber.

All steps were performed with one height (1.5 m) of the receiving antenna only.

### 3. Measurement above 1 GHz

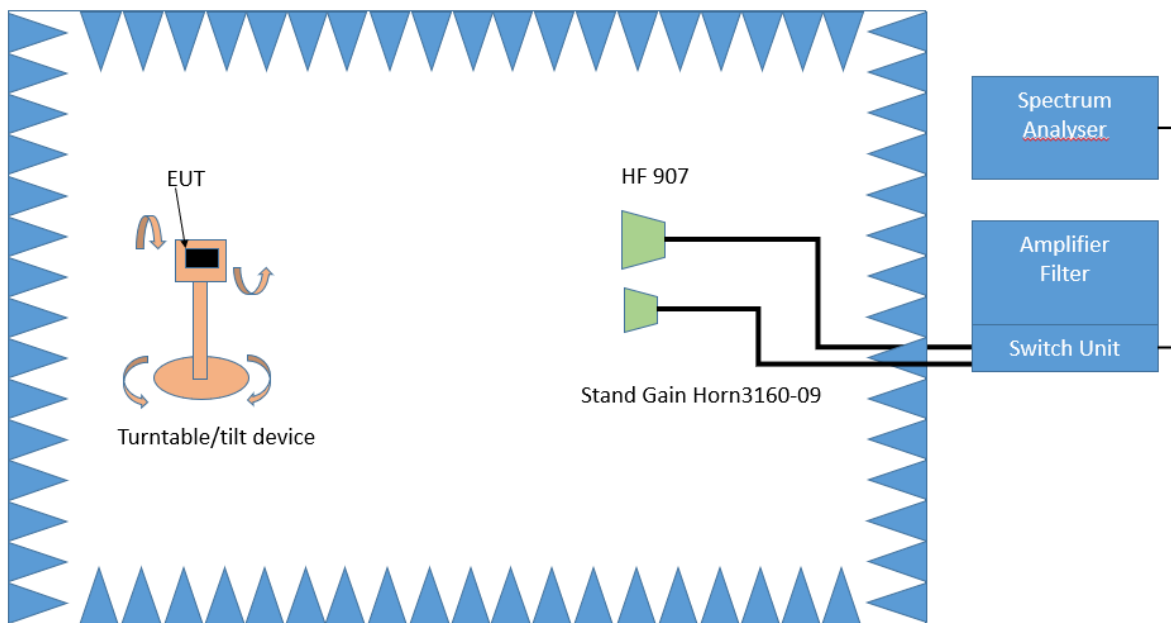

Test Setup; Spurious Emission Radiated (FAC), 1 GHz-26.5 GHz

#### Step 1:

The EUT is turned during the preliminary measurement across the elevation axis, with a step size of 90 °.

The turn table step size (azimuth angle) for the preliminary measurement is 45 °.

Spectrum analyser settings:

- Detector: Peak, Average
- RBW = 1 MHz
- VBW = 3 MHz

#### Step 2:

The turn table azimuth will slowly vary by  $\pm 22.5^\circ$ .

The elevation angle will slowly vary by  $\pm 45^\circ$

Spectrum analyser settings:

- Detector: Peak

#### Step 3:

Spectrum analyser settings for step 3:

- Detector: Peak / CISPR Average
- Measured frequencies: in step 1 determined frequencies
- RBW = 1 MHz
- VBW = 3 MHz
- Measuring time: 1 s

### 5.1.2 TEST REQUIREMENTS / LIMITS

FCC Part 15, Subpart C, §15.247 (d)

... In addition, radiated emissions which fall in the restricted bands, as defined in Section 15.205(a), must also comply with the radiated emission limits specified in Section 15.209(a) (see Section 15.205(c)).

FCC Part 15, Subpart C, §15.209, Radiated Emission Limits

Frequency in MHz	Limit ( $\mu\text{V}/\text{m}$ )	Measurement distance (m)	Limits ( $\text{dB}\mu\text{V}/\text{m}$ )
0.009 – 0.49	2400/F(kHz)@300m	3	(48.5 – 13.8)@300m
0.49 – 1.705	24000/F(kHz)@30m	3	(33.8 – 23.0)@30m
1.705 – 30	30@30m	3	29.5@30m

The measured values are corrected with an inverse linear distance extrapolation factor (40 dB/decade) according FCC 15.31 (2).

Frequency in MHz	Limit ( $\mu\text{V}/\text{m}$ )	Measurement distance (m)	Limits ( $\text{dB}\mu\text{V}/\text{m}$ )
30 – 88	100@3m	3	40.0@3m
88 – 216	150@3m	3	43.5@3m
216 – 960	200@3m	3	46.0@3m
960 - 26000	500@3m	3	54.0@3m
26000 - 40000	500@3m	1	54.0@3m

The measured values above 26 GHz are corrected with an inverse linear distance extrapolation factor (20 dB/decade).

§15.35(b) ..., there is also a limit on the radio frequency emissions, as measured using instrumentation with a peak detector function, corresponding to 20 dB above the maximum permitted average limit....

Used conversion factor:  $\text{Limit (dB}\mu\text{V}/\text{m)} = 20 \log (\text{Limit } (\mu\text{V}/\text{m})/1\mu\text{V}/\text{m})$



### 5.1.3 TEST PROTOCOL

Ambient temperature: 28 °C  
 Air Pressure: 997-998 hPa  
 Humidity: 43-48 %  
 BT GFSK  
 Applied duty cycle correction (AV): 0.1 dB

Ch. No.	Ch. Center Freq. [MHz]	Spurious Freq. [MHz]	Spurious Level [dBµV/m]	Detector	RBW [kHz]	Limit [dBµV/m]	Margin to Limit [dB]	Limit Type
0	2402	-	-	-	1000	-	-	RB
39	2441	-	-	-	1000	-	-	RB
78	2480	2483.7	47.5	PEAK	1000	74.0	26.5	RB
78	2480	2483.7	35.1	AV	1000	54.0	18.9	RB
78	2480	4960.0	54.3	PEAK	1000	74.0	19.7	RB
78	2480	4960.0	49.8	AV	1000	54.0	4.2	RB

WLAN b-Mode; 20 MHz; 1 Mbit/s  
 Applied duty cycle correction (AV): 0 dB

Ch. No.	Ch. Center Freq. [MHz]	Spurious Freq. [MHz]	Spurious Level [dBµV/m]	Detector	RBW [kHz]	Limit [dBµV/m]	Margin to Limit [dB]	Limit Type
11	2462	2483.5	47.9	PEAK	1000	74.0	26.1	RB
11	2462	2483.5	35.0	AV	1000	54.0	19.0	RB
11	2462	12311.1	51.5	PEAK	1000	74.0	22.5	RB
11	2462	12311.1	41.1	AV	1000	54.0	12.9	RB

Comparison to W161:

	BT GFSK PK [dBµV/m]	BT GFSK AV [dBµV/m]	WLAN b PK [dBµV/m]	WLAN b AV [dBµV/m]
MAYA-W160	54.3	49.8	51.5	41.1
MAYA-W161	51.5	44.9	56.6	49.5

Remark: Please see next sub-clause for the measurement plot.

### 5.1.4 MEASUREMENT PLOT (EXAMPLE PLOT, SHOWING WORST CASE, IF APPLICABLE)

Radio Technology = WLAN b, Operating Frequency = mid, Measurement range = 9 kHz - 30 MHz  
(S01\_160\_AC03)

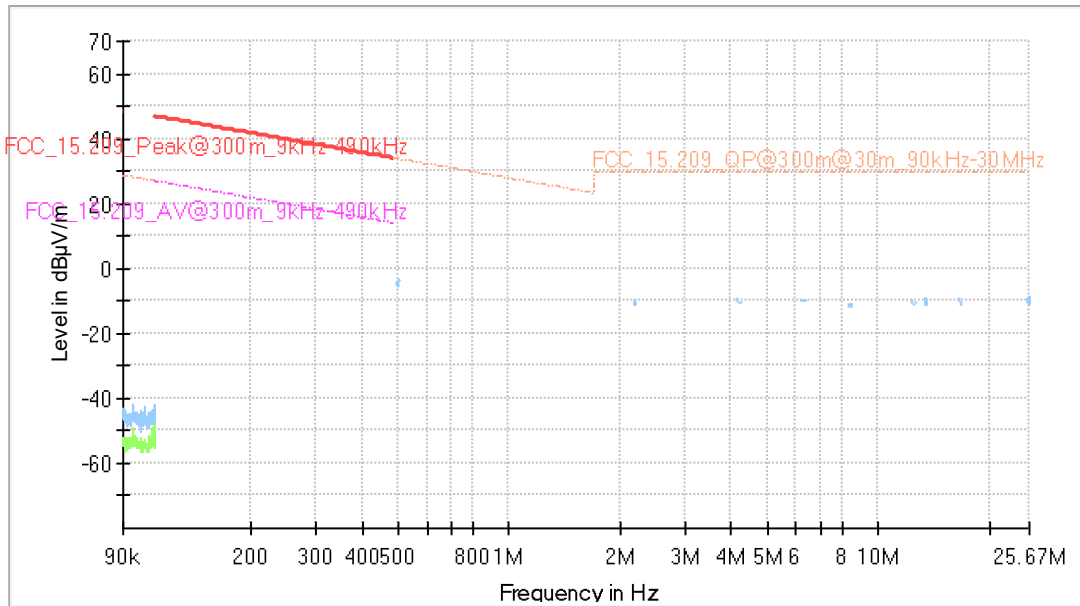

### Final\_Result

Frequency (MHz)	MaxPeak (dBµV/m)	QuasiPeak (dBµV/m)	Limit (dBµV/m)	Margin (dB)	Meas. Time (ms)	Bandwidth (kHz)	Height (cm)	Azimuth (deg)	Corr. (dB/m)
---	---	---	---	---	---	---	---	---	---

Radio Technology = Bluetooth BDR, Operating Frequency = mid, Measurement range = 9 kHz  
 - 30 MHz  
 (S01\_160\_AC03)

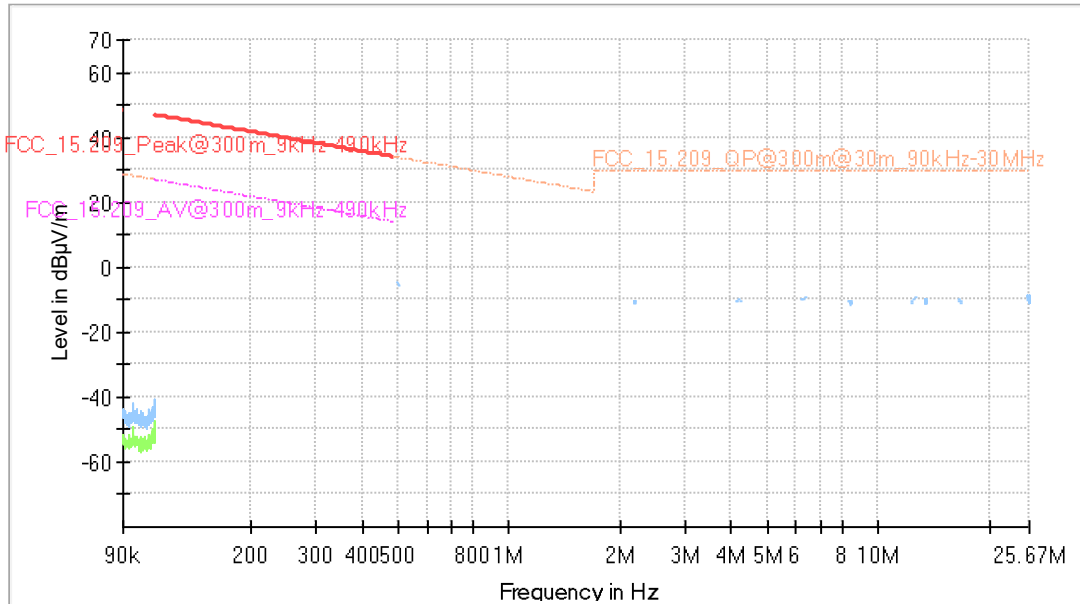

### Final Result

Frequency (MHz)	MaxPeak (dBµV/m)	QuasiPeak (dBµV/m)	Limit (dBµV/m)	Margin (dB)	Meas. Time (ms)	Bandwidth (kHz)	Height (cm)	Azimuth (deg)	Corr. (dB/m)
---	---	---	---	---	---	---	---	---	---

Radio Technology = Bluetooth BDR, Operating Frequency = high, Measurement range = 30 MHz - 1 GHz  
(S01\_160\_AC03)

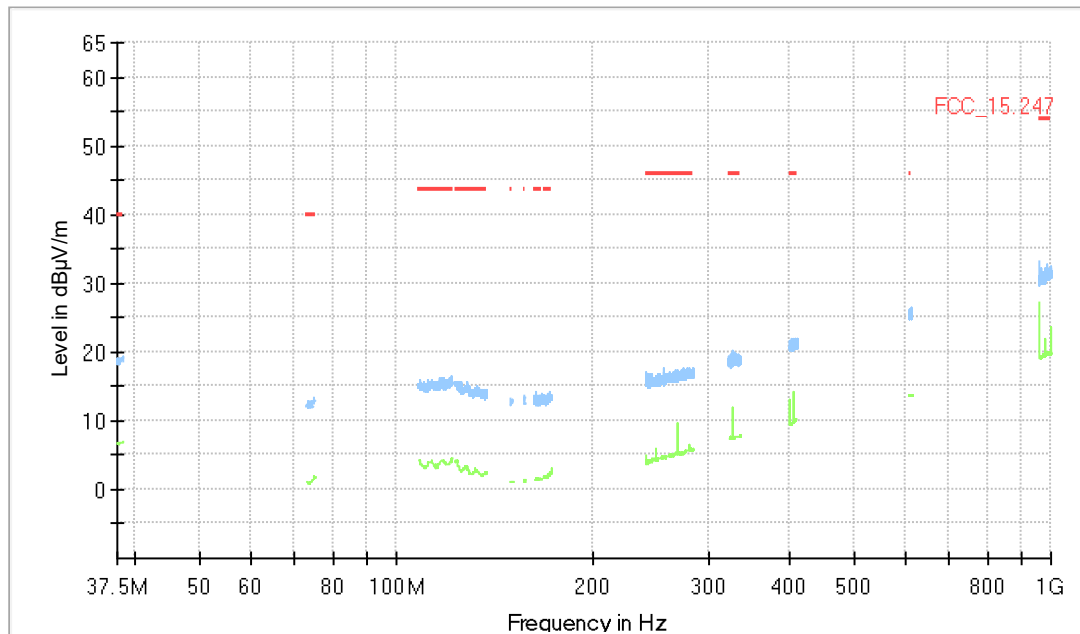

### Final Result

Frequency (MHz)	QuasiPeak (dBµV/m)	Limit (dBµV/m)	Margin (dB)	Meas. Time (ms)	Bandwidth (kHz)	Height (cm)	Pol	Azimuth (deg)	Corr. (dB/m)
---	---	---	---	---	---	---	---	---	---

Radio Technology = WLAN b, Operating Frequency = high, Measurement range = 30 MHz - 1 GHz  
(S01\_160\_AC03)

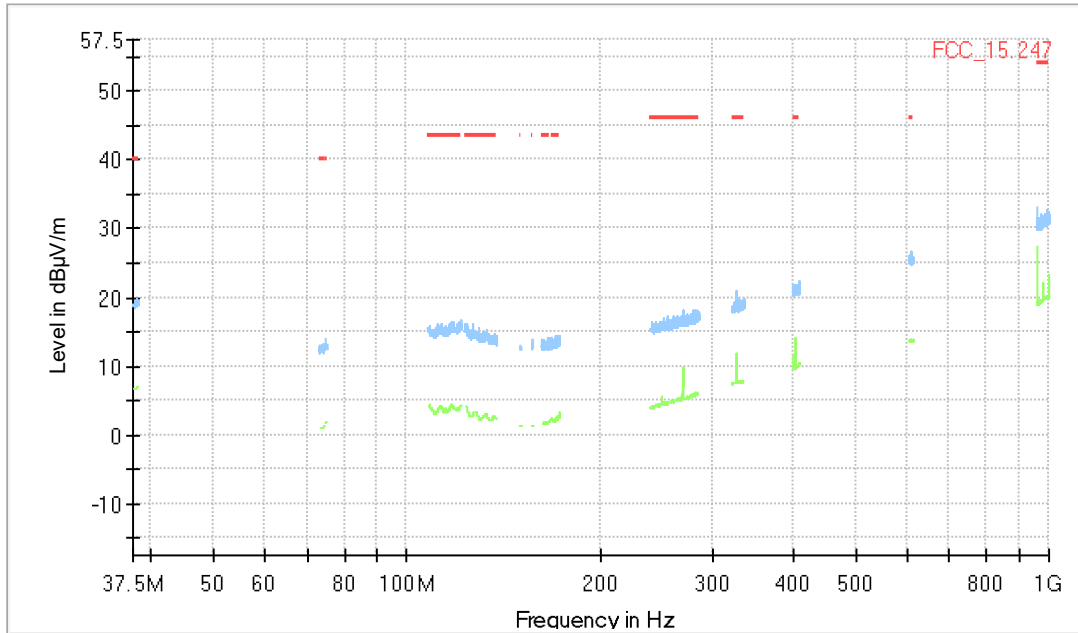

### Final Result

Frequency (MHz)	QuasiPeak (dBµV/m)	Limit (dBµV/m)	Margin (dB)	Meas. Time (ms)	Bandwidth (kHz)	Height (cm)	Pol	Azimuth (deg)	Corr. (dB/m)
---	---	---	---	---	---	---	---	---	---

Radio Technology = Bluetooth BDR, Operating Frequency = mid, Measurement range = 30 MHz - 1 GHz  
(S01\_160\_AC03)

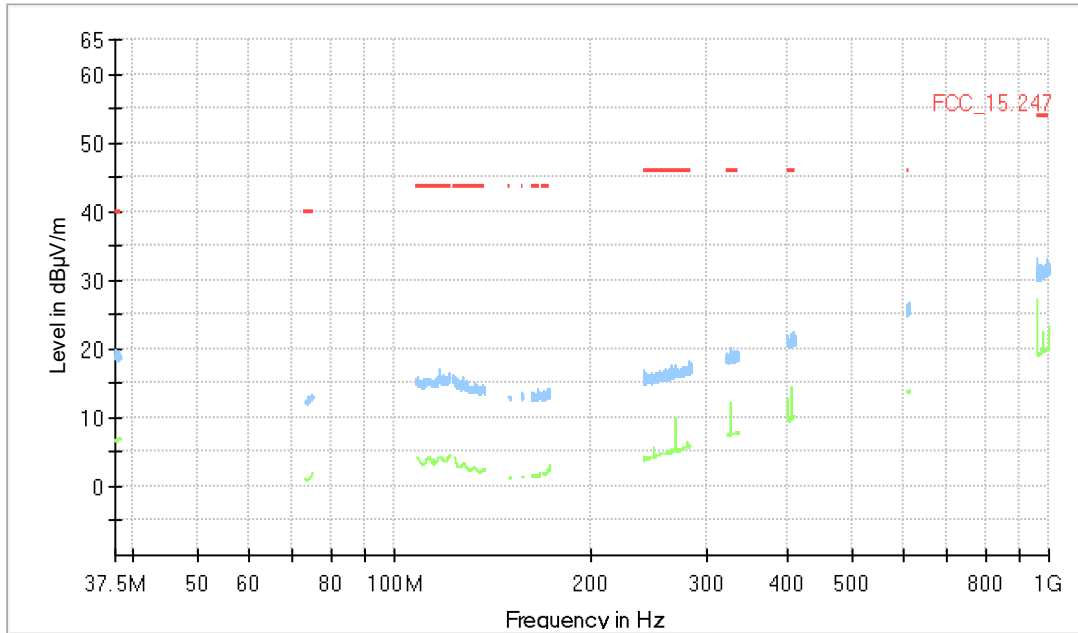

### Final Result

Frequency (MHz)	QuasiPeak (dBµV/m)	Limit (dBµV/m)	Margin (dB)	Meas. Time (ms)	Bandwidth (kHz)	Height (cm)	Pol	Azimuth (deg)	Corr. (dB/m)
---	---	---	---	---	---	---	---	---	---

Radio Technology = Bluetooth BDR, Operating Frequency = low, Measurement range = 30 MHz  
 - 1 GHz  
 (S01\_160\_AC03)

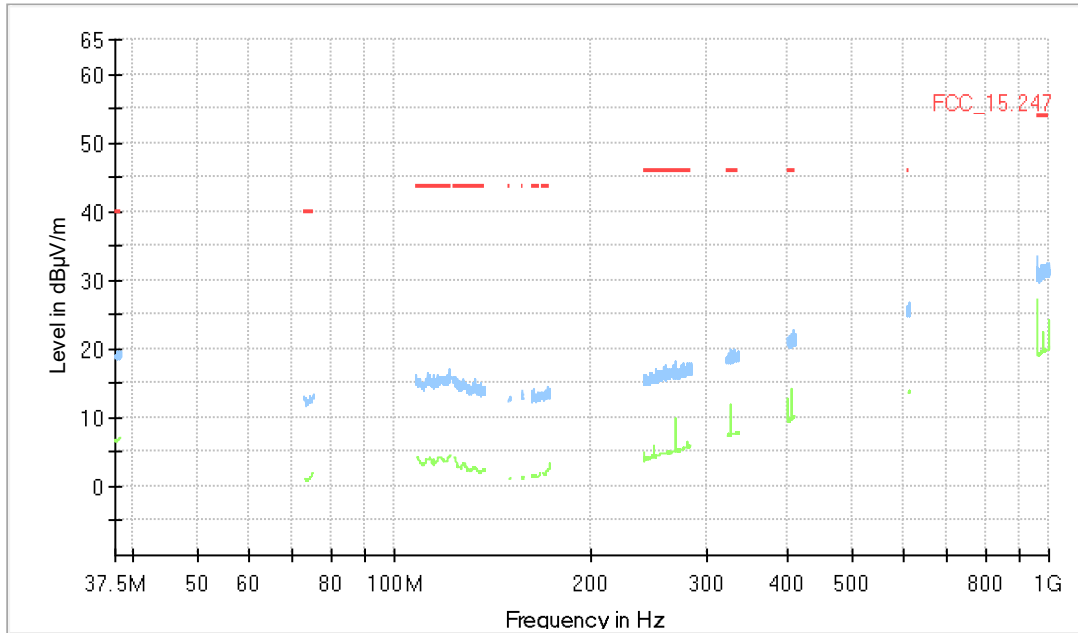

### Final Result

Frequency (MHz)	QuasiPeak (dBµV/m)	Limit (dBµV/m)	Margin (dB)	Meas. Time (ms)	Bandwidth (kHz)	Height (cm)	Pol	Azimuth (deg)	Corr. (dB/m)
---	---	---	---	---	---	---	---	---	---

Radio Technology = Bluetooth BDR, Operating Frequency = low, Measurement range = 1 GHz - 26 GHz  
(S01\_160\_AC03)

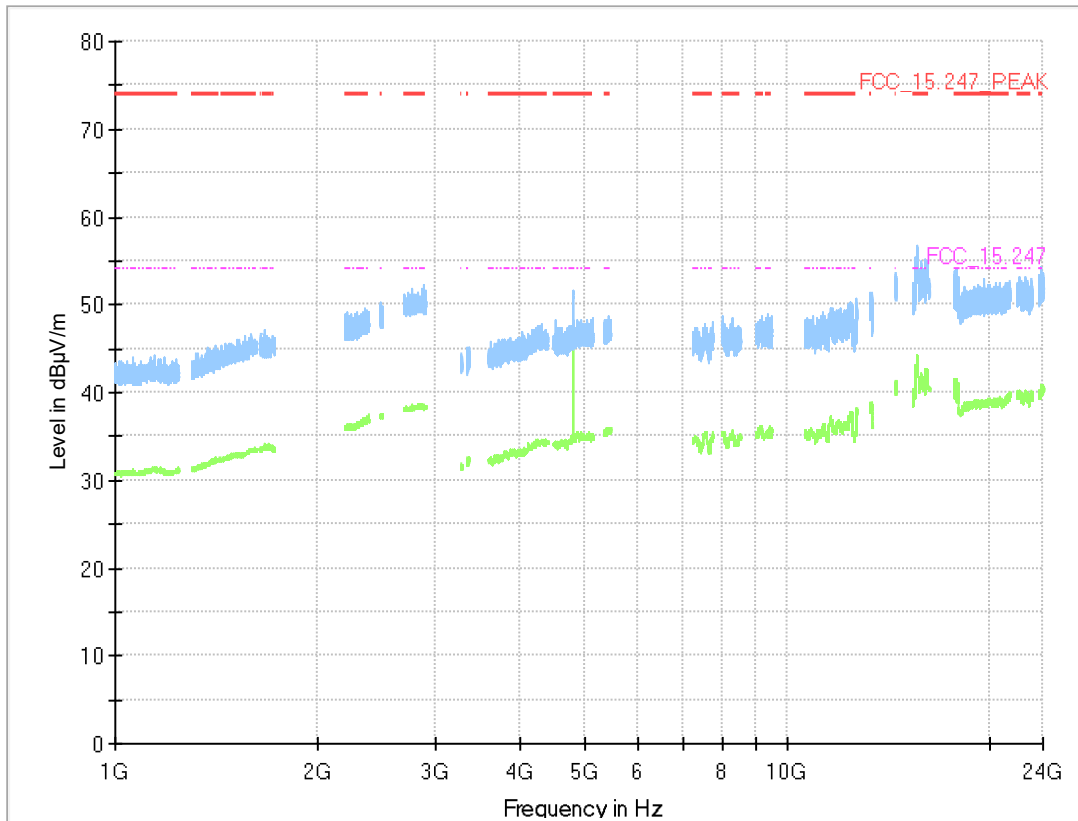

**Final Result**

Frequency (MHz)	MaxPeak (dBµV/m)	CAverage (dBµV/m)	Limit (dBµV/m)	Margin (dB)	Meas. Time (ms)	Bandwidth (kHz)	Height (cm)	Pol	Azimuth (deg)	Elevation (deg)	Corr. (dB/m)
---	---	---	---	---	---	---	---	---	---	---	---



Radio Technology = Bluetooth BDR, Operating Frequency = mid, Measurement range = 1 GHz - 26 GHz  
(S01\_160\_AC03)

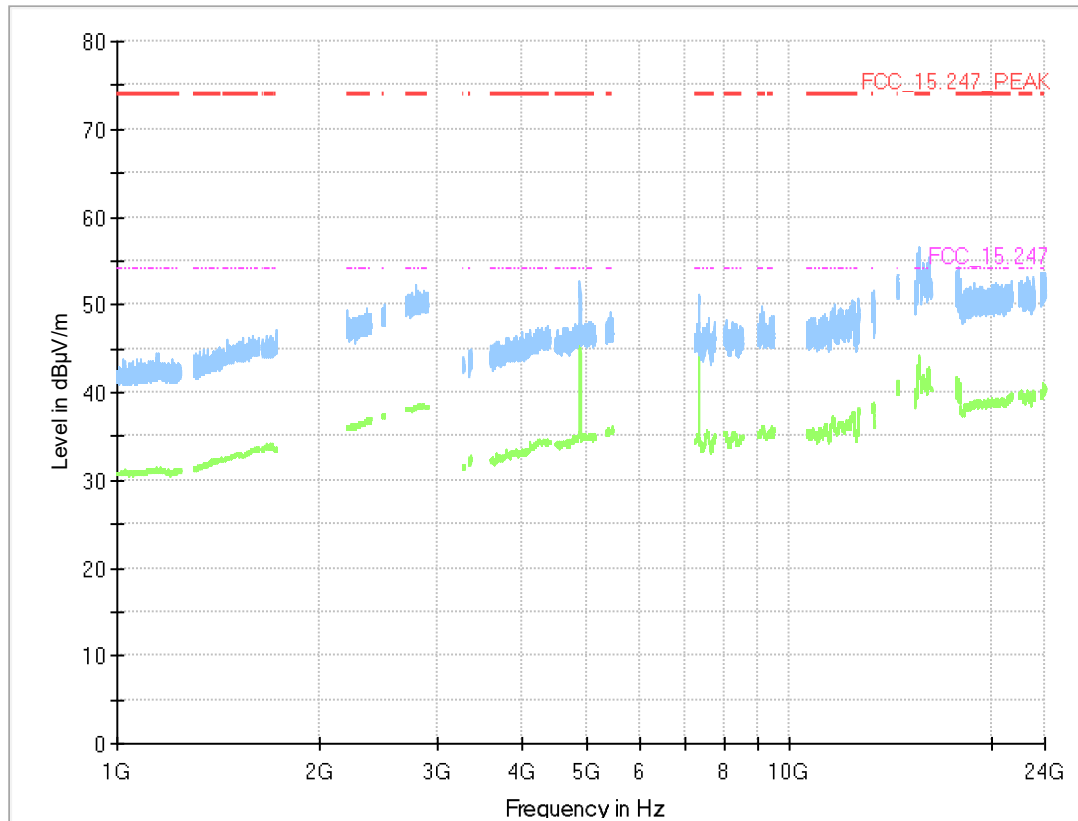

### Final Result

Frequency (MHz)	MaxPeak (dBµV/m)	CAverage (dBµV/m)	Limit (dBµV/m)	Margin (dB)	Meas. Time (ms)	Bandwidth (kHz)	Height (cm)	Pol	Azimuth (deg)	Elevation (deg)	Corr. (dB/m)
---	---	---	---	---	---	---	---		---	---	---

Radio Technology = Bluetooth BDR, Operating Frequency = high, Measurement range = 1 GHz - 26 GHz  
(S01\_160\_AC03)

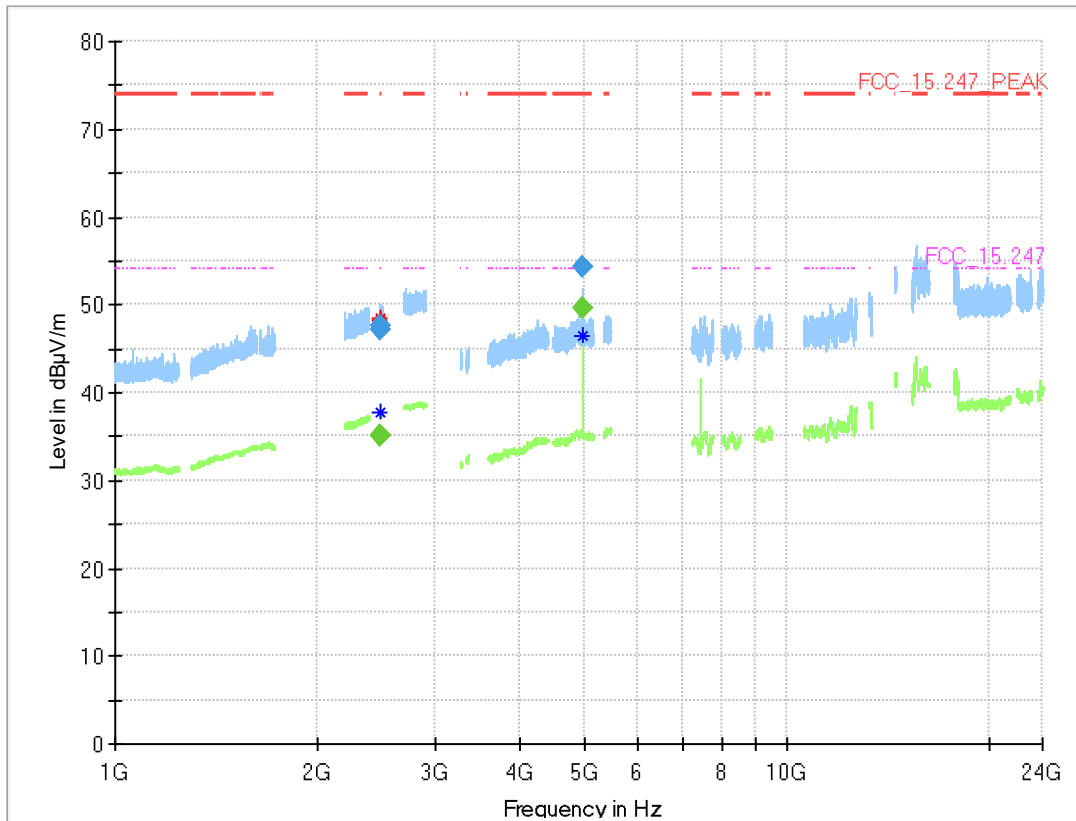

### Final Result

Frequency (MHz)	MaxPeak (dBµV/m)	CAverage (dBµV/m)	Limit (dBµV/m)	Margin (dB)	Meas. Time (ms)	Bandwidth (kHz)	Height (cm)	Pol	Azimuth (deg)	Elevation (deg)	Corr. (dB/m)
2483.665	---	35.0	54.00	18.97	1000.0	1000.000	150.0	H	149.0	-2.0	5.3
2483.665	47.5	---	74.00	26.46	1000.0	1000.000	150.0	H	149.0	-2.0	5.3
2484.738	---	35.0	54.00	18.99	1000.0	1000.000	150.0	H	60.0	105.0	5.3
2484.738	47.2	---	74.00	26.77	1000.0	1000.000	150.0	H	60.0	105.0	5.3
4960.038	---	49.7	54.00	4.31	1000.0	1000.000	150.0	H	26.0	-12.0	4.4
4960.038	54.3	---	74.00	19.72	1000.0	1000.000	150.0	H	26.0	-12.0	4.4

Radio Technology = WLAN b, Operating Frequency = high, Measurement range = 1 GHz - 26 GHz  
(S01\_160\_AC03)

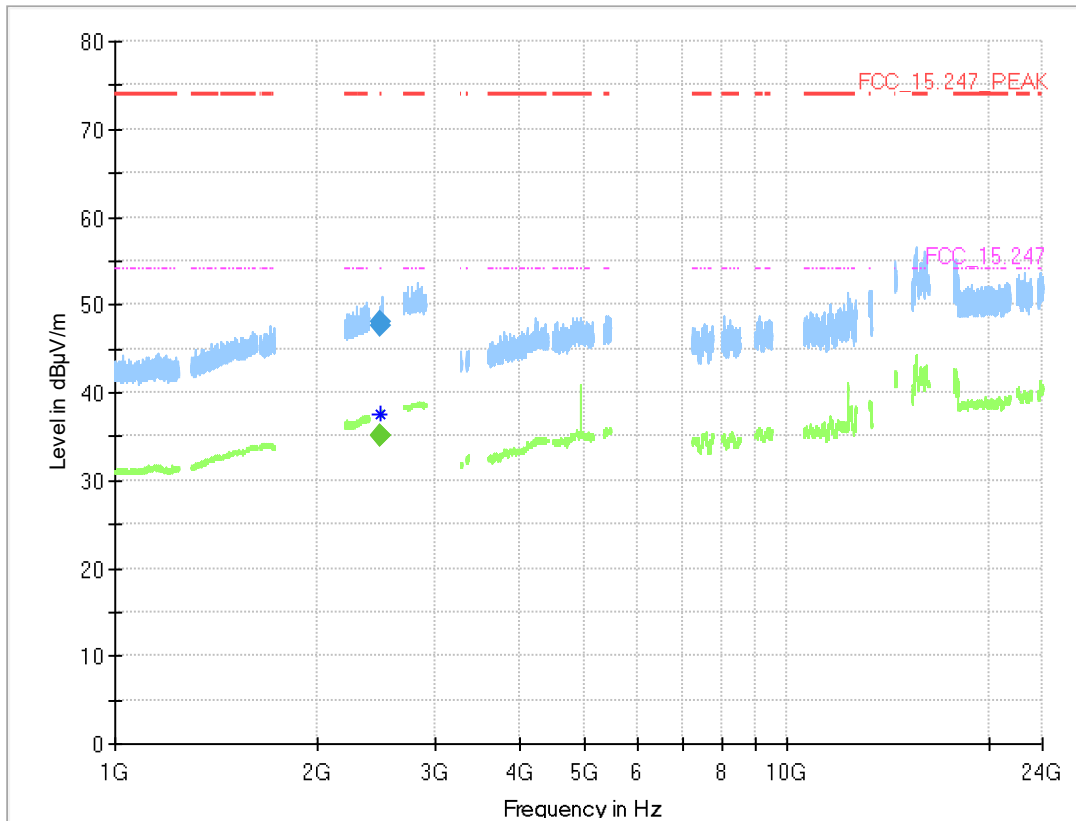

### Final Result

Frequency (MHz)	MaxPeak (dBµV/m)	CAverage (dBµV/m)	Limit (dBµV/m)	Margin (dB)	Meas. Time (ms)	Bandwidth (kHz)	Height (cm)	Pol	Azimuth (deg)	Elevation (deg)	Corr. (dB/m)
2483.500	---	35.0	54.00	18.99	1000.0	1000.000	150.0	H	-23.0	87.0	5.3
2483.500	47.9	---	74.00	26.06	1000.0	1000.000	150.0	H	-23.0	87.0	5.3
2484.243	---	35.0	54.00	18.99	1000.0	1000.000	150.0	V	41.0	101.0	5.3
2484.243	47.6	---	74.00	26.37	1000.0	1000.000	150.0	V	41.0	101.0	5.3

### 5.1.5 TEST EQUIPMENT USED

- Radiated Emissions FAR 2.4 GHz FCC
- Radiated Emissions SAC H-Field
- Radiated Emissions SAC up to 1 GHz

## 5.2 BAND EDGE COMPLIANCE RADIATED

Standard **FCC Part 15 Subpart C**

**The test was performed according to:**

ANSI C63.10, chapter 6.6.5

### 5.2.1 TEST DESCRIPTION

The test set-up was made in accordance to the general provisions of ANSI C63.10 in a typical installation configuration. The measurements were performed according the following sub-chapter of ANSI C63.10:

- Chapter 6.10.5

The Equipment Under Test (EUT) was set up on a non-conductive support (tilt device) at 1.5 m height in the fully-anechoic chamber.

All steps were performed with one height (1.5 m) of the receiving antenna only (procedure according ANSI C63.10, chapter 6.6.5).

### 3. Measurement above 1 GHz

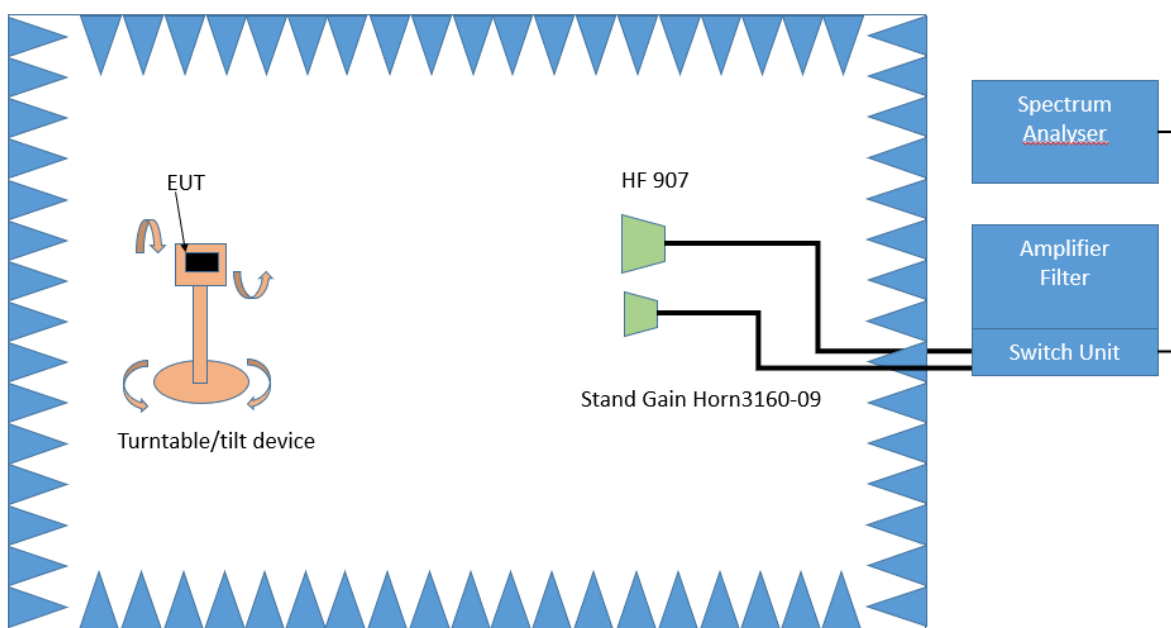

Test Setup; Spurious Emission Radiated (FAC), 1 GHz-26.5 GHz

#### Step 1:

The EUT is turned during the preliminary measurement across the elevation axis, with a step size of 90 °.

The turn table step size (azimuth angle) for the preliminary measurement is 45 °.

Spectrum analyser settings:

- Detector: Peak, Average
- RBW = 1 MHz
- VBW = 3 MHz

#### Step 2:

The turn table azimuth will slowly vary by  $\pm 22.5^\circ$ .

The elevation angle will slowly vary by  $\pm 45^\circ$

Spectrum analyser settings:

- Detector: Peak

**Step 3:**

Spectrum analyser settings for step 3:

- Detector: Peak / CISPR Average
- Measured frequencies: in step 1 determined frequencies
- RBW = 1 MHz
- VBW = 3 MHz
- Measuring time: 1 s

**5.2.2 TEST REQUIREMENTS / LIMITS**

For band edges connected to a restricted band, the limits are specified in Section 15.209(a)

FCC Part 15, Subpart C, §15.209, Radiated Emission Limits

Frequency in MHz	Limit (µV/m)	Measurement distance (m)	Limits (dBµV/m)
0.009 – 0.49	2400/F(kHz)@300m	3	(48.5 – 13.8)@300m
0.49 – 1.705	24000/F(kHz)@30m	3	(33.8 – 23.0)@30m
1.705 – 30	30@30m	3	29.5@30m

The measured values are corrected with an inverse linear distance extrapolation factor (40 dB/decade) according FCC 15.31 (2).

Frequency in MHz	Limit (µV/m)	Measurement distance (m)	Limits (dBµV/m)
30 – 88	100@3m	3	40.0@3m
88 – 216	150@3m	3	43.5@3m
216 – 960	200@3m	3	46.0@3m
960 - 26000	500@3m	3	54.0@3m
26000 - 40000	500@3m	1	54.0@3m

The measured values above 26 GHz are corrected with an inverse linear distance extrapolation factor (20 dB/decade).

§15.35(b) ..., there is also a limit on the radio frequency emissions, as measured using instrumentation with a peak detector function, corresponding to 20 dB above the maximum permitted average limit....

Used conversion factor:  $\text{Limit (dBµV/m)} = 20 \log (\text{Limit (µV/m)}/1µV/m)$

### 5.2.3 TEST PROTOCOL

Ambient temperature: 24–28 °C  
 Air Pressure: 997–1007 hPa  
 Humidity: 43–48 %  
 BT GFSK  
 Applied duty cycle correction (AV): 0.1 dB

Ch. No.	Ch. Center Freq. [MHz]	Band Edge Freq. [MHz]	Spurious Level [dBμV/m]	Detector	RBW [kHz]	Limit [dBμV/m]	Margin to Limit [dB]
78	2480	2483.5	47.5	PEAK	1000	74.0	26.5
78	2480	2483.5	35.1	AV	1000	54.0	18.9

BT n/4 DQPSK  
 Applied duty cycle correction (AV): 0.2 dB

Ch. No.	Ch. Center Freq. [MHz]	Band Edge Freq. [MHz]	Spurious Level [dBμV/m]	Detector	RBW [kHz]	Limit [dBμV/m]	Margin to Limit [dB]
78	2480	2483.5	47.5	PEAK	1000	74.0	26.5
78	2480	2483.5	34.9	AV	1000	54.0	19.1

BT 8-DPSK  
 Applied duty cycle correction (AV): 0.3 dB

Ch. No.	Ch. Center Freq. [MHz]	Band Edge Freq. [MHz]	Spurious Level [dBμV/m]	Detector	RBW [kHz]	Limit [dBμV/m]	Margin to Limit [dB]
78	2480	2483.5	48.0	PEAK	1000	74.0	26.0
78	2480	2483.5	35.0	AV	1000	54.0	19.0

WLAN b-Mode; 20 MHz; 1 Mbit/s  
 Applied duty cycle correction (AV): 0 dB

Ch. No.	Ch. Center Freq. [MHz]	Band Edge Freq. [MHz]	Spurious Level [dBμV/m]	Detector	RBW [kHz]	Limit [dBμV/m]	Margin to Limit [dB]
11	2462	2483.5	47.9	PEAK	1000	74.0	26.1
11	2462	2483.5	35.0	AV	1000	54.0	19.0

Comparison to W161:

	GFSK PK [dBμV/m]	GFSK AV [dBμV/m]	n/4 DQPSK PK [dBμV/m]	n/4 DQPSK AV [dBμV/m]	8-DPSK PK [dBμV/m]	8-DPSK AV [dBμV/m]	WLAN b PK [dBμV/m]	WLAN b AV [dBμV/m]
MAYA-W160	47.5	35.1	47.5	34.9	48.0	35.0	47.9	35.0
MAYA-W161	54.2	34.9	47.8	34.9	48.5	35.0	47.7	34.8

Remark: Please see next sub-clause for the measurement plot.

### 5.2.4 MEASUREMENT PLOT (EXAMPLE PLOT, SHOWING WORST CASE, IF APPLICABLE)

Radio Technology = Bluetooth BDR, Operating Frequency = high, Band Edge = high (S01\_160\_AC03)

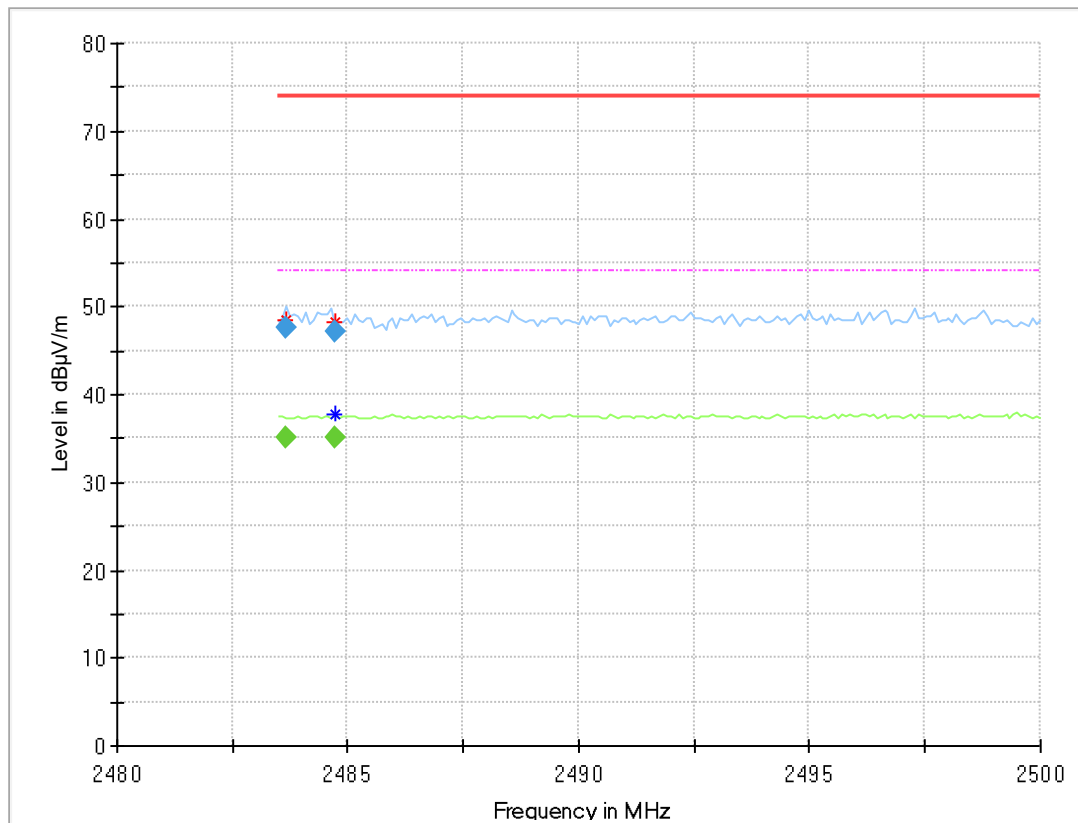

### Final Result

Frequency (MHz)	MaxPeak (dBµV/m)	CAverage (dBµV/m)	Limit (dBµV/m)	Margin (dB)	Meas. Time (ms)	Bandwidth (kHz)	Height (cm)	Pol	Azimuth (deg)	Elevation (deg)	Corr. (dB/m)
2483.665	---	35.0	54.00	18.97	1000.0	1000.000	150.0	H	149.0	-2.0	5.3
2483.665	47.5	---	74.00	26.46	1000.0	1000.000	150.0	H	149.0	-2.0	5.3
2484.738	---	35.0	54.00	18.99	1000.0	1000.000	150.0	H	60.0	105.0	5.3
2484.738	47.2	---	74.00	26.77	1000.0	1000.000	150.0	H	60.0	105.0	5.3
4960.038	---	49.7	54.00	4.31	1000.0	1000.000	150.0	H	26.0	-12.0	4.4
4960.038	54.3	---	74.00	19.72	1000.0	1000.000	150.0	H	26.0	-12.0	4.4

Radio Technology = Bluetooth EDR 2, Operating Frequency = high, Band Edge = high  
(S01\_160\_AC03)

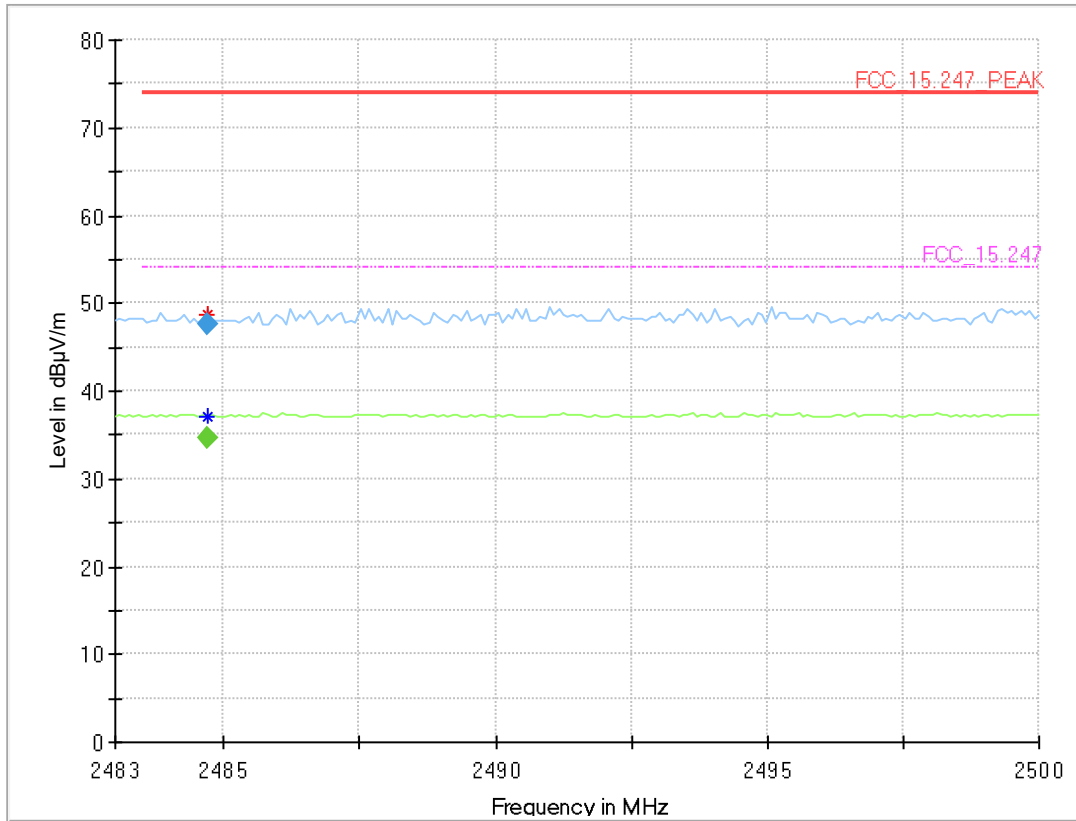

### Final Result

Frequency (MHz)	MaxPeak (dBµV/m)	CAverage (dBµV/m)	Limit (dBµV/m)	Margin (dB)	Meas. Time (ms)	Bandwidth (kHz)	Height (cm)	Pol	Azimuth (deg)	Elevation (deg)	Corr. (dB/m)
2484.700	---	34.7	54.00	19.28	1000.0	1000.000	150.0	H	-3.0	-10.0	5.3
2484.700	47.5	---	74.00	26.47	1000.0	1000.000	150.0	H	-3.0	-10.0	5.3



Radio Technology = Bluetooth EDR 3, Operating Frequency = high, Band Edge = high (S01\_160\_AC03)

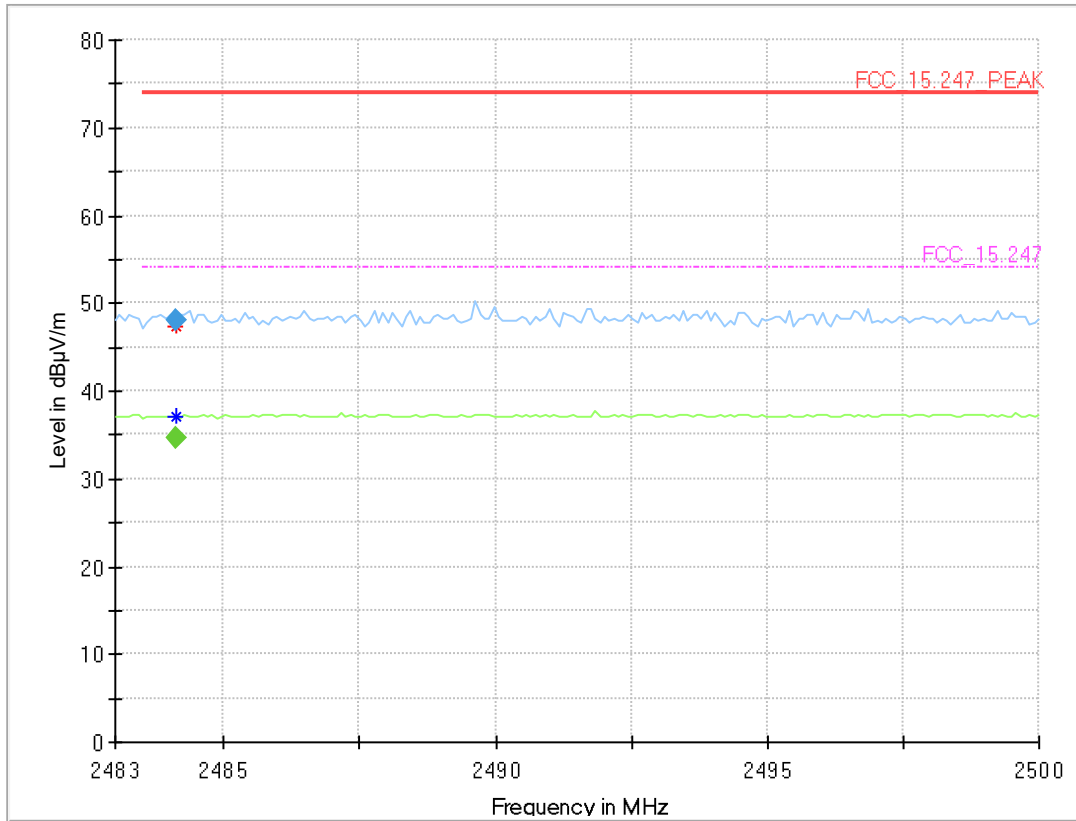

### Final Result

Frequency (MHz)	MaxPeak (dBµV/m)	CAverage (dBµV/m)	Limit (dBµV/m)	Margin (dB)	Meas. Time (ms)	Bandwidth (kHz)	Height (cm)	Pol	Azimuth (deg)	Elevation (deg)	Corr. (dB/m)
2484.105	---	34.7	54.00	19.30	1000.0	1000.000	150.0	V	131.0	12.0	5.3
2484.105	48.0	---	74.00	25.99	1000.0	1000.000	150.0	V	131.0	12.0	5.3

Radio Technology = WLAN b, Operating Frequency = high, Band Edge = high  
(S01\_160\_AC03)

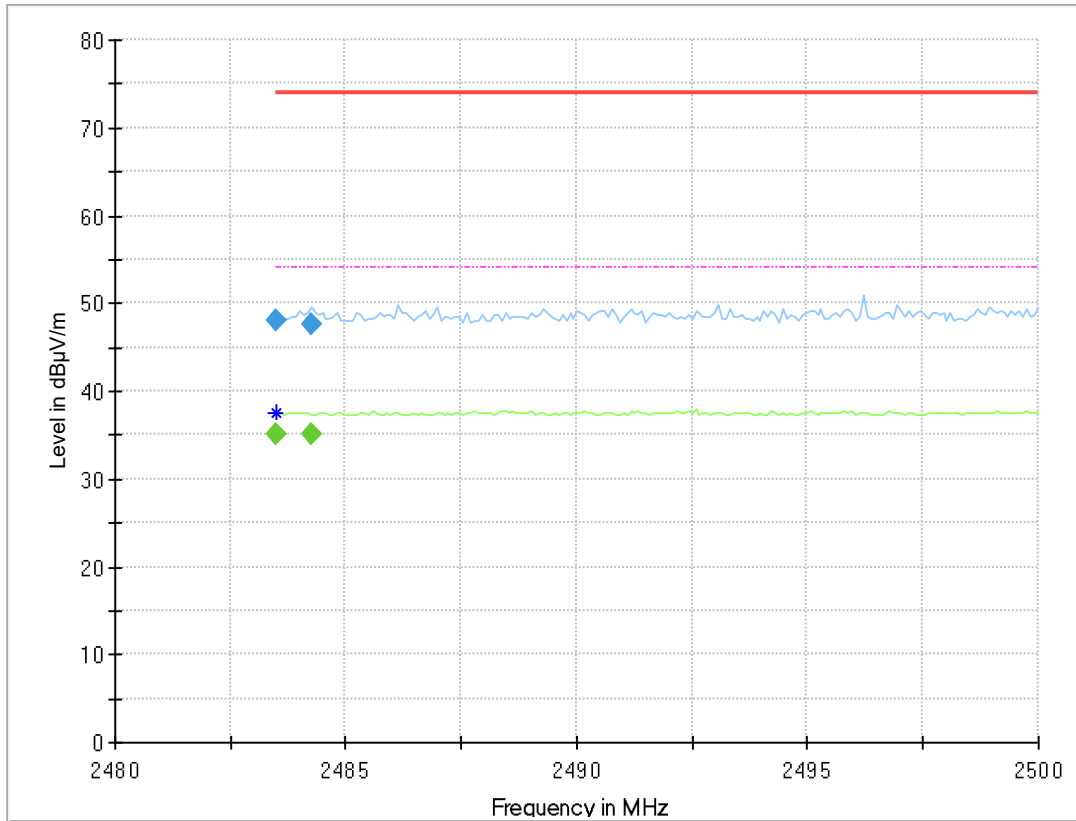

### Final Result

Frequency (MHz)	MaxPeak (dBµV/m)	CAverage (dBµV/m)	Limit (dBµV/m)	Margin (dB)	Meas. Time (ms)	Bandwidth (kHz)	Height (cm)	Pol	Azimuth (deg)	Elevation (deg)	Corr. (dB/m)
2483.500	---	35.0	54.00	18.99	1000.0	1000.000	150.0	H	-23.0	87.0	5.3
2483.500	47.9	---	74.00	26.06	1000.0	1000.000	150.0	H	-23.0	87.0	5.3
2484.243	---	35.0	54.00	18.99	1000.0	1000.000	150.0	V	41.0	101.0	5.3
2484.243	47.6	---	74.00	26.37	1000.0	1000.000	150.0	V	41.0	101.0	5.3

### 5.2.5 TEST EQUIPMENT USED

- Radiated Emissions FAR 2.4 GHz FCC

## 6 TEST EQUIPMENT

### 6.1 TEST EQUIPMENT HARDWARE

- 1 Radiated Emissions FAR 2.4 GHz FCC  
 Radiated emission tests for 2.4 GHz ISM devices in a fully anechoic room

Ref.No.	Device Name	Description	Manufacturer	Serial Number	Last Calibration	Calibration Due
1.1	Opus10 TPR (8253.00)	T/P Logger 13	Lufft Mess- und Regeltechnik GmbH	13936	2021-10	2023-10
1.2	AMF-7D00101800-30-10P-R	Broadband Amplifier 100 MHz - 18 GHz	Miteq			
1.3	Anechoic Chamber 03	FAR, 8.80m x 4.60m x 4.05m (l x w x h)	Albatross Projects	P26971-647-001-PRB	2021-04	2023-04
1.4	Fluke 177	Digital Multimeter 03 (Multimeter)	Fluke Europe B.V.	86670383	2022-06	2024-06
1.5	JS4-18002600-32-5P	Broadband Amplifier 18 GHz - 26 GHz	Miteq	849785		
1.6	FSW 43	Spectrum Analyzer	Rohde & Schwarz GmbH & Co. KG	103779	2021-06	2023-06
1.7	EP 1200/B, NA/B1	AC Source, Amplifier with integrated variable Oscillator	Spitzenberger & Spies GmbH & Co. KG	B6278		
1.8	3160-09	Standard Gain / Pyramidal Horn Antenna 26.5 GHz	EMCO Elektronik GmbH	00083069		
1.9	WHKX 7.0/18G-8SS	High Pass Filter	Wainwright Instruments GmbH	09		
1.10	TT 1.5 WI	Turn Table	Maturo GmbH	-		
1.11	5HC3500/18000-1.2-KK	High Pass Filter	Trilithic	200035008		
1.12	Opus 20 THI (8120.00)	ThermoHygro Datalogger	Lufft Mess- und Regeltechnik GmbH	115.0318.0802.033	2020-10	2022-10
1.13	TD1.5-10kg	EUT Tilt Device (Rohacell)	Maturo GmbH	TD1.5-10kg/024/3790709		
1.14	PAS 2.5 - 10 kg	Antenna Mast	Maturo GmbH	-		
1.15	AFS42-00101800-25-S-42	Broadband Amplifier 25 MHz - 18 GHz	Miteq	2035324		
1.16	HF 907	Double-ridged horn	Rohde & Schwarz	102444	2021-09	2024-09

- 2 Radiated Emissions SAC H-Field  
 Radiated emission tests in the H-Field in a semi anechoic room

Ref.No.	Device Name	Description	Manufacturer	Serial Number	Last Calibration	Calibration Due
2.1	N5000/NP	Filter for EUT, 2 Lines, 250 V, 16 A	ETS-LINDGREN	241515		
2.2	Opus10 TPR (8253.00)	T/P Logger 13	Lufft Mess- und Regeltechnik GmbH	13936	2021-10	2023-10
2.3	ESW44	EMI Receiver / Spectrum Analyzer	Rohde & Schwarz GmbH & Co. KG	101603	2022-01	2024-01
2.4	Anechoic Chamber 01	SAC/FAR, 10.58 m x 6.38 m x 6.00 m	Frankonia	none		
2.5	Opus10 THI (8152.00)	T/H Logger 10	Lufft Mess- und Regeltechnik GmbH	12488	2021-08	2023-08
2.6	EP 1200/B, NA/B1	AC Source, Amplifier with integrated variable Oscillator	Spitzenberger & Spies GmbH & Co. KG	B6278		
2.7	DS 420S	Turn Table 2 m diameter	HD GmbH	420/573/99		
2.8	HFH2-Z2	Loop Antenna + 3 Axis Tripod	Rohde & Schwarz GmbH & Co. KG	829324/006	2021-01	2024-01

- 3 Radiated Emissions SAC up to 1 GHz  
Radiated emission tests up to 1 GHz in a semi anechoic room

Ref.No.	Device Name	Description	Manufacturer	Serial Number	Last Calibration	Calibration Due
3.1	N5000/NP	Filter for EUT, 2 Lines, 250 V, 16 A	ETS-LINDGREN	241515		
3.2	Opus10 TPR (8253.00)	T/P Logger 13	Lufft Mess- und Regeltechnik GmbH	13936	2021-10	2023-10
3.3	ESW44	EMI Receiver / Spectrum Analyzer	Rohde & Schwarz GmbH & Co. KG	101603	2022-01	2024-01
3.4	Anechoic Chamber 01	SAC/FAR, 10.58 m x 6.38 m x 6.00 m	Frankonia	none		
3.5	HL 562 ULTRALOG	Biconical-log- per antenna (30 MHz - 3 GHz) with HL 562E biconicals	Rohde & Schwarz GmbH & Co. KG	830547/003	2021-09	2024-09
3.6	Opus10 THI (8152.00)	T/H Logger 10	Lufft Mess- und Regeltechnik GmbH	12488	2021-08	2023-08
3.7	EP 1200/B, NA/B1	AC Source, Amplifier with integrated variable Oscillator	Spitzenberger & Spies GmbH & Co. KG	B6278		
3.8	DS 420S	Turn Table 2 m diameter	HD GmbH	420/573/99		

Ref.No.	Device Name	Description	Manufacturer	Serial Number	Last Calibration	Calibration Due
3.9	AM 4.0	Antenna Mast 4 m	Maturo GmbH	AM4.0/180/1192 0513		

The calibration interval is the time interval between "Last Calibration" and "Calibration Due"

## 6.2 TEST EQUIPMENT SOFTWARE

<b>Semi-Anechoic Chamber:</b>	
Software	Version
EMC32 Measurement Software	10.60.10
INNCO Mast Controller	1.02.62
MATURO Mast Controller	12.19
MATURO Turn-Table Controller	30.10
<b>Fully-Anechoic Chamber:</b>	
Software	Version
EMC32 Measurement Software	10.60.10
MATURO Turn-Unit Controller	11.10
MATURO Mast Controller	12.10
MATURO Turntable Controller	12.11
<b>Conducted AC Emissions:</b>	
Software	Version
EMC32 Measurement Software	10.60.20

## 7 ANTENNA FACTORS, CABLE LOSS AND SAMPLE CALCULATIONS

This chapter contains the antenna factors with their corresponding path loss of the used measurement path for all antennas as well as the insertion loss of the LISN.

### 7.1 LISN R&S ESH3-Z5 (150 KHZ – 30 MHZ)

Frequency MHz	Corr. dB	LISN insertion loss ESH3- Z5 dB	cable loss (incl. 10 dB atten- uator) dB
0.15	10.1	0.1	10.0
5	10.3	0.1	10.2
7	10.5	0.2	10.3
10	10.5	0.2	10.3
12	10.7	0.3	10.4
14	10.7	0.3	10.4
16	10.8	0.4	10.4
18	10.9	0.4	10.5
20	10.9	0.4	10.5
22	11.1	0.5	10.6
24	11.1	0.5	10.6
26	11.2	0.5	10.7
28	11.2	0.5	10.7
30	11.3	0.5	10.8

#### Sample calculation

$$U_{\text{LISN}} \text{ (dB } \mu\text{V)} = U \text{ (dB } \mu\text{V)} + \text{Corr. (dB)}$$

U = Receiver reading

LISN Insertion loss = Voltage Division Factor of LISN

Corr. = sum of single correction factors of used LISN, cables, switch units (if used)

Linear interpolation will be used for frequencies in between the values in the table.

## 7.2 ANTENNA R&S HFH2-Z2 (9 KHZ – 30 MHZ)

Frequency MHz	AF HFH-Z2) dB (1/m)	Corr. dB	cable loss 1 (inside chamber) dB	cable loss 2 (outside chamber) dB	cable loss 3 (switch unit) dB	cable loss 4 (to receiver) dB	distance corr. (-40 dB/ decade) dB	d <sub>Limit</sub> (meas. distance (limit) m	d <sub>used</sub> (meas. distance (used) m
0.009	20.50	-79.6	0.1	0.1	0.1	0.1	-80	300	3
0.01	20.45	-79.6	0.1	0.1	0.1	0.1	-80	300	3
0.015	20.37	-79.6	0.1	0.1	0.1	0.1	-80	300	3
0.02	20.36	-79.6	0.1	0.1	0.1	0.1	-80	300	3
0.025	20.38	-79.6	0.1	0.1	0.1	0.1	-80	300	3
0.03	20.32	-79.6	0.1	0.1	0.1	0.1	-80	300	3
0.05	20.35	-79.6	0.1	0.1	0.1	0.1	-80	300	3
0.08	20.30	-79.6	0.1	0.1	0.1	0.1	-80	300	3
0.1	20.20	-79.6	0.1	0.1	0.1	0.1	-80	300	3
0.2	20.17	-79.6	0.1	0.1	0.1	0.1	-80	300	3
0.3	20.14	-79.6	0.1	0.1	0.1	0.1	-80	300	3
0.49	20.12	-79.6	0.1	0.1	0.1	0.1	-80	300	3
0.490001	20.12	-39.6	0.1	0.1	0.1	0.1	-40	30	3
0.5	20.11	-39.6	0.1	0.1	0.1	0.1	-40	30	3
0.8	20.10	-39.6	0.1	0.1	0.1	0.1	-40	30	3
1	20.09	-39.6	0.1	0.1	0.1	0.1	-40	30	3
2	20.08	-39.6	0.1	0.1	0.1	0.1	-40	30	3
3	20.06	-39.6	0.1	0.1	0.1	0.1	-40	30	3
4	20.05	-39.5	0.2	0.1	0.1	0.1	-40	30	3
5	20.05	-39.5	0.2	0.1	0.1	0.1	-40	30	3
6	20.02	-39.5	0.2	0.1	0.1	0.1	-40	30	3
8	19.95	-39.5	0.2	0.1	0.1	0.1	-40	30	3
10	19.83	-39.4	0.2	0.1	0.2	0.1	-40	30	3
12	19.71	-39.4	0.2	0.1	0.2	0.1	-40	30	3
14	19.54	-39.4	0.2	0.1	0.2	0.1	-40	30	3
16	19.53	-39.3	0.3	0.1	0.2	0.1	-40	30	3
18	19.50	-39.3	0.3	0.1	0.2	0.1	-40	30	3
20	19.57	-39.3	0.3	0.1	0.2	0.1	-40	30	3
22	19.61	-39.3	0.3	0.1	0.2	0.1	-40	30	3
24	19.61	-39.3	0.3	0.1	0.2	0.1	-40	30	3
26	19.54	-39.3	0.3	0.1	0.2	0.1	-40	30	3
28	19.46	-39.2	0.3	0.1	0.3	0.1	-40	30	3
30	19.73	-39.1	0.4	0.1	0.3	0.1	-40	30	3

### Sample calculation

$$E \text{ (dB } \mu\text{V/m)} = U \text{ (dB } \mu\text{V)} + AF \text{ (dB 1/m)} + Corr. \text{ (dB)}$$

U = Receiver reading

AF = Antenna factor

Corr. = sum of single correction factors of used cables, switch unit, distance correction, amplifier (if applicable)

distance correction =  $-40 * \text{LOG} (d_{\text{Limit}} / d_{\text{used}})$

Linear interpolation will be used for frequencies in between the values in the table.

Table shows an extract of values

### 7.3 ANTENNA R&S HL562 (30 MHZ – 1 GHZ)

( $d_{Limit} = 3\text{ m}$ )

Frequency	AF R&S HL562	Corr.
MHz	dB (1/m)	dB
30	18.6	0.6
50	6.0	0.9
100	9.7	1.2
150	7.9	1.6
200	7.6	1.9
250	9.5	2.1
300	11.0	2.3
350	12.4	2.6
400	13.6	2.9
450	14.7	3.1
500	15.6	3.2
550	16.3	3.5
600	17.2	3.5
650	18.1	3.6
700	18.5	3.6
750	19.1	4.1
800	19.6	4.1
850	20.1	4.4
900	20.8	4.7
950	21.1	4.8
1000	21.6	4.9

cable loss 1 (inside chamber)	cable loss 2 (outside chamber)	cable loss 3 (switch unit)	cable loss 4 (to receiver)	distance corr. (-20 dB/decade)	$d_{Limit}$ (meas. distance (limit))	$d_{used}$ (meas. distance (used))
dB	dB	dB	dB	dB	m	m
0.29	0.04	0.23	0.02	0.0	3	3
0.39	0.09	0.32	0.08	0.0	3	3
0.56	0.14	0.47	0.08	0.0	3	3
0.73	0.20	0.59	0.12	0.0	3	3
0.84	0.21	0.70	0.11	0.0	3	3
0.98	0.24	0.80	0.13	0.0	3	3
1.04	0.26	0.89	0.15	0.0	3	3
1.18	0.31	0.96	0.13	0.0	3	3
1.28	0.35	1.03	0.19	0.0	3	3
1.39	0.38	1.11	0.22	0.0	3	3
1.44	0.39	1.20	0.19	0.0	3	3
1.55	0.46	1.24	0.23	0.0	3	3
1.59	0.43	1.29	0.23	0.0	3	3
1.67	0.34	1.35	0.22	0.0	3	3
1.67	0.42	1.41	0.15	0.0	3	3
1.87	0.54	1.46	0.25	0.0	3	3
1.90	0.46	1.51	0.25	0.0	3	3
1.99	0.60	1.56	0.27	0.0	3	3
2.14	0.60	1.63	0.29	0.0	3	3
2.22	0.60	1.66	0.33	0.0	3	3
2.23	0.61	1.71	0.30	0.0	3	3

( $d_{Limit} = 10\text{ m}$ )

30	18.6	-9.9
50	6.0	-9.6
100	9.7	-9.2
150	7.9	-8.8
200	7.6	-8.6
250	9.5	-8.3
300	11.0	-8.1
350	12.4	-7.9
400	13.6	-7.6
450	14.7	-7.4
500	15.6	-7.2
550	16.3	-7.0
600	17.2	-6.9
650	18.1	-6.9
700	18.5	-6.8
750	19.1	-6.3
800	19.6	-6.3
850	20.1	-6.0
900	20.8	-5.8
950	21.1	-5.6
1000	21.6	-5.6

0.29	0.04	0.23	0.02	-10.5	10	3
0.39	0.09	0.32	0.08	-10.5	10	3
0.56	0.14	0.47	0.08	-10.5	10	3
0.73	0.20	0.59	0.12	-10.5	10	3
0.84	0.21	0.70	0.11	-10.5	10	3
0.98	0.24	0.80	0.13	-10.5	10	3
1.04	0.26	0.89	0.15	-10.5	10	3
1.18	0.31	0.96	0.13	-10.5	10	3
1.28	0.35	1.03	0.19	-10.5	10	3
1.39	0.38	1.11	0.22	-10.5	10	3
1.44	0.39	1.20	0.19	-10.5	10	3
1.55	0.46	1.24	0.23	-10.5	10	3
1.59	0.43	1.29	0.23	-10.5	10	3
1.67	0.34	1.35	0.22	-10.5	10	3
1.67	0.42	1.41	0.15	-10.5	10	3
1.87	0.54	1.46	0.25	-10.5	10	3
1.90	0.46	1.51	0.25	-10.5	10	3
1.99	0.60	1.56	0.27	-10.5	10	3
2.14	0.60	1.63	0.29	-10.5	10	3
2.22	0.60	1.66	0.33	-10.5	10	3
2.23	0.61	1.71	0.30	-10.5	10	3

#### Sample calculation

$$E \text{ (dB } \mu\text{V/m)} = U \text{ (dB } \mu\text{V)} + \text{AF (dB 1/m)} + \text{Corr. (dB)}$$

U = Receiver reading

AF = Antenna factor

Corr. = sum of single correction factors of used cables, switch unit, distance correction, amplifier (if applicable)

distance correction =  $-20 * \text{LOG} (d_{Limit} / d_{used})$

Linear interpolation will be used for frequencies in between the values in the table.

Tables show an extract of values.



### 7.4 ANTENNA R&S HF907 (1 GHZ – 18 GHZ)

Frequency MHz	AF R&S HF907 dB (1/m)	Corr. dB
1000	24.4	-19.4
2000	28.5	-17.4
3000	31.0	-16.1
4000	33.1	-14.7
5000	34.4	-13.7
6000	34.7	-12.7
7000	35.6	-11.0

cable loss 1 (relay + cable inside chamber) dB	cable loss 2 (outside chamber) dB	cable loss 3 (switch unit, atten- uator & pre-amp) dB	cable loss 4 (to receiver) dB
0.99	0.31	-21.51	0.79
1.44	0.44	-20.63	1.38
1.87	0.53	-19.85	1.33
2.41	0.67	-19.13	1.31
2.78	0.86	-18.71	1.40
2.74	0.90	-17.83	1.47
2.82	0.86	-16.19	1.46

Frequency MHz	AF R&S HF907 dB (1/m)	Corr. dB
3000	31.0	-23.4
4000	33.1	-23.3
5000	34.4	-21.7
6000	34.7	-21.2
7000	35.6	-19.8

cable loss 1 (relay inside chamber) dB	cable loss 2 (inside chamber) dB	cable loss 3 (outside chamber) dB	cable loss 4 (switch unit, atten- uator & pre-amp) dB	cable loss 5 (to receiver) dB	used for FCC 15.247
0.47	1.87	0.53	-27.58	1.33	
0.56	2.41	0.67	-28.23	1.31	
0.61	2.78	0.86	-27.35	1.40	
0.58	2.74	0.90	-26.89	1.47	
0.66	2.82	0.86	-25.58	1.46	

Frequency MHz	AF R&S HF907 dB (1/m)	Corr. dB
7000	35.6	-57.3
8000	36.3	-56.3
9000	37.1	-55.3
10000	37.5	-56.2
11000	37.5	-55.3
12000	37.6	-53.7
13000	38.2	-53.5
14000	39.9	-56.3
15000	40.9	-54.1
16000	41.3	-54.1
17000	42.8	-54.4
18000	44.2	-54.7

cable loss 1 (relay inside chamber) dB	cable loss 2 (High Pass) dB	cable loss 3 (pre- amp) dB	cable loss 4 (inside chamber) dB	cable loss 5 (outside chamber) dB	cable loss 6 (to receiver) dB
0.56	1.28	-62.72	2.66	0.94	1.46
0.69	0.71	-61.49	2.84	1.00	1.53
0.68	0.65	-60.80	3.06	1.09	1.60
0.70	0.54	-61.91	3.28	1.20	1.67
0.80	0.61	-61.40	3.43	1.27	1.70
0.84	0.42	-59.70	3.53	1.26	1.73
0.83	0.44	-59.81	3.75	1.32	1.83
0.91	0.53	-63.03	3.91	1.40	1.77
0.98	0.54	-61.05	4.02	1.44	1.83
1.23	0.49	-61.51	4.17	1.51	1.85
1.36	0.76	-62.36	4.34	1.53	2.00
1.70	0.53	-62.88	4.41	1.55	1.91

#### Sample calculation

$E \text{ (dB } \mu\text{V/m)} = U \text{ (dB } \mu\text{V)} + AF \text{ (dB 1/m)} + Corr. \text{ (dB)}$   
 U = Receiver reading  
 AF = Antenna factor  
 Corr. = sum of single correction factors of used cables, switch unit, distance correction, amplifier (if applicable)  
 Linear interpolation will be used for frequencies in between the values in the table.  
 Tables show an extract of values.

### 7.5 ANTENNA EMCO 3160-09 (18 GHZ – 26.5 GHZ)

Frequency MHz	AF EMCO 3160-09 dB (1/m)	Corr. dB	cable loss 1 (inside chamber) dB	cable loss 2 (pre- amp) dB	cable loss 3 (inside chamber) dB	cable loss 4 (switch unit) dB	cable loss 5 (to receiver) dB
18000	40.2	-23.5	0.72	-35.85	6.20	2.81	2.65
18500	40.2	-23.2	0.69	-35.71	6.46	2.76	2.59
19000	40.2	-22.0	0.76	-35.44	6.69	3.15	2.79
19500	40.3	-21.3	0.74	-35.07	7.04	3.11	2.91
20000	40.3	-20.3	0.72	-34.49	7.30	3.07	3.05
20500	40.3	-19.9	0.78	-34.46	7.48	3.12	3.15
21000	40.3	-19.1	0.87	-34.07	7.61	3.20	3.33
21500	40.3	-19.1	0.90	-33.96	7.47	3.28	3.19
22000	40.3	-18.7	0.89	-33.57	7.34	3.35	3.28
22500	40.4	-19.0	0.87	-33.66	7.06	3.75	2.94
23000	40.4	-19.5	0.88	-33.75	6.92	3.77	2.70
23500	40.4	-19.3	0.90	-33.35	6.99	3.52	2.66
24000	40.4	-19.8	0.88	-33.99	6.88	3.88	2.58
24500	40.4	-19.5	0.91	-33.89	7.01	3.93	2.51
25000	40.4	-19.3	0.88	-33.00	6.72	3.96	2.14
25500	40.5	-20.4	0.89	-34.07	6.90	3.66	2.22
26000	40.5	-21.3	0.86	-35.11	7.02	3.69	2.28
26500	40.5	-21.1	0.90	-35.20	7.15	3.91	2.36

#### Sample calculation

$$E \text{ (dB } \mu\text{V/m)} = U \text{ (dB } \mu\text{V)} + AF \text{ (dB 1/m)} + Corr. \text{ (dB)}$$

U = Receiver reading

AF = Antenna factor

Corr. = sum of single correction factors of used cables, switch unit, distance correction, amplifier (if applicable)

Linear interpolation will be used for frequencies in between the values in the table.

Table shows an extract of values.

## 7.6 ANTENNA EMCO 3160-10 (26.5 GHZ – 40 GHZ)

Frequency GHz	AF EMCO 3160-10 dB (1/m)	Corr. dB	cable loss 1 (inside chamber) dB	cable loss 2 (outside chamber) dB	cable loss 3 (switch unit) dB	cable loss 4 (to receiver) dB	distance corr. (-20 dB/ decade) dB	d <sub>Limit</sub> (meas. distance (limit) m	d <sub>used</sub> (meas. distance (used) m
26.5	43.4	-11.2	4.4				-9.5	3	1.0
27.0	43.4	-11.2	4.4				-9.5	3	1.0
28.0	43.4	-11.1	4.5				-9.5	3	1.0
29.0	43.5	-11.0	4.6				-9.5	3	1.0
30.0	43.5	-10.9	4.7				-9.5	3	1.0
31.0	43.5	-10.8	4.7				-9.5	3	1.0
32.0	43.5	-10.7	4.8				-9.5	3	1.0
33.0	43.6	-10.7	4.9				-9.5	3	1.0
34.0	43.6	-10.6	5.0				-9.5	3	1.0
35.0	43.6	-10.5	5.1				-9.5	3	1.0
36.0	43.6	-10.4	5.1				-9.5	3	1.0
37.0	43.7	-10.3	5.2				-9.5	3	1.0
38.0	43.7	-10.2	5.3				-9.5	3	1.0
39.0	43.7	-10.2	5.4				-9.5	3	1.0
40.0	43.8	-10.1	5.5				-9.5	3	1.0

### Sample calculation

$$E \text{ (dB } \mu\text{V/m)} = U \text{ (dB } \mu\text{V)} + \text{AF (dB 1/m)} + \text{Corr. (dB)}$$

U = Receiver reading

AF = Antenna factor

Corr. = sum of single correction factors of used cables, switch unit, distance correction, amplifier (if applicable)

Linear interpolation will be used for frequencies in between the values in the table.

$$\text{distance correction} = -20 * \text{LOG} (d_{\text{Limit}} / d_{\text{used}})$$

Linear interpolation will be used for frequencies in between the values in the table.

Table shows an extract of values.

## 8 MEASUREMENT UNCERTAINTIES

Test Case	Parameter	Uncertainty
AC Power Line	Power	± 3.4 dB
Field Strength of spurious radiation	Power	± 5.5 dB
6 dB / 26 dB / 99% Bandwidth	Power Frequency	± 2.9 dB ± 11.2 kHz
Conducted Output Power	Power	± 2.2 dB
Band Edge Compliance	Power Frequency	± 2.2 dB ± 11.2 kHz
Frequency Stability	Frequency	± 25 Hz
Power Spectral Density	Power	± 2.2 dB

The measurement uncertainties for all parameters are calculated with an expansion factor (coverage factor)  $k = 1.96$ . This means, that the true value is in the corresponding interval with a probability of 95 %.

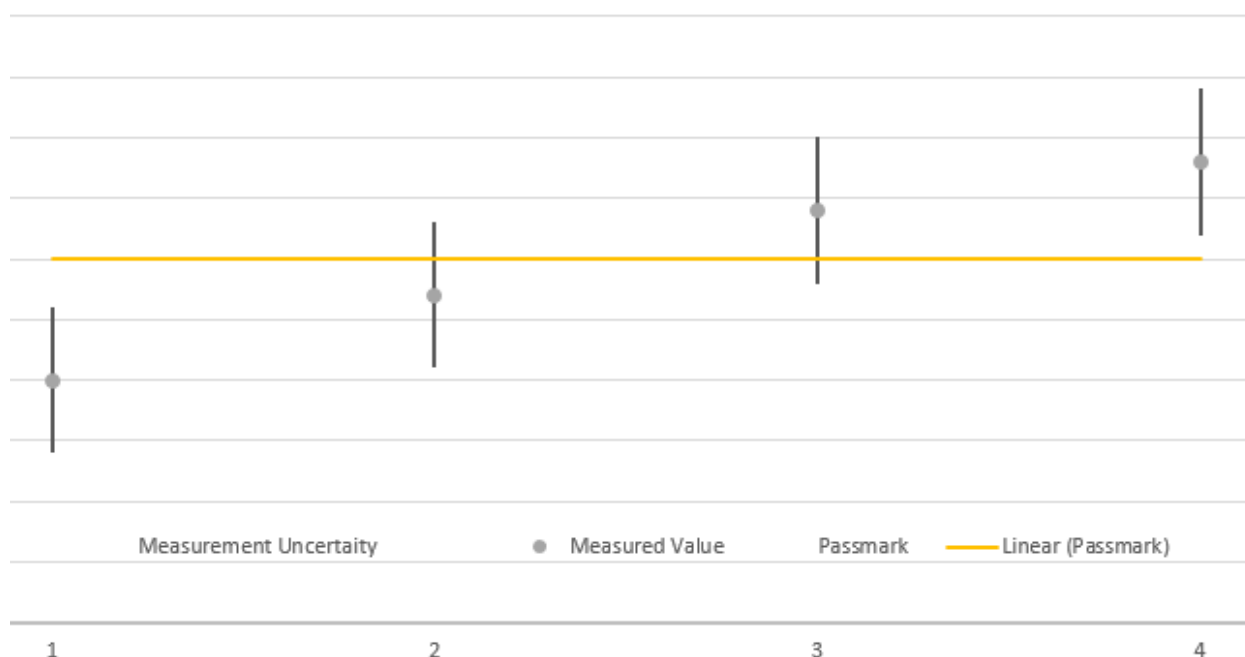

The verdicts in this test report are given according the above diagram:

Case	Measured Value	Uncertainty Range	Verdict
1	below pass mark	below pass mark	Passed
2	below pass mark	within pass mark	Passed
3	above pass mark	within pass mark	Failed
4	above pass mark	above pass mark	Failed

That means, the laboratory applies, as decision rule (see ISO/IEC 17025:2017), the so called shared risk principle.

## 9 PHOTO REPORT

Please see separate photo report.