

# FCC Measurement/Technical Report on WLAN and Bluetooth Module MAYA W161

FCC ID: XPYMAYAW161  
IC: 8595A-MAYAW161

**Test Report Reference:** MDE\_UBLOX\_2110\_FCC\_02

**Test Laboratory:**

7layers GmbH  
Borsigstrasse 11  
40880 Ratingen  
Germany



Deutsche  
Akkreditierungsstelle  
D-PL-12140-01-01  
D-PL-12140-01-02  
D-PL-12140-01-03

**Note:**

The following test results relate only to the devices specified in this document. This report shall not be reproduced in parts without the written approval of the test laboratory.

**7layers GmbH**  
Borsigstraße 11  
40880 Ratingen, Germany  
T +49 (0) 2102 749 0  
F +49 (0) 2102 749 350

Geschäftsführer/  
Managing Directors:  
Frank Spiller  
Bernhard Retka  
Alexandre Norré-Oudard

Registergericht/registered:  
Düsseldorf HRB 75554  
USt-Id.-Nr./VAT-No. DE203159652  
Steuer-Nr./TAX-No. 147/5869/0385

*a Bureau Veritas  
Group Company*

*www.7layers.com*

## Table of Contents

<b>1 Applied Standards and Test Summary</b>	<b>3</b>
1.1 Applied Standards	3
1.2 FCC-IC Correlation Table	4
1.3 Measurement Summary	4
<b>2 Revision History / Signatures</b>	<b>12</b>
<b>3 Administrative Data</b>	<b>13</b>
3.1 Testing Laboratory	13
3.2 Project Data	13
3.3 Applicant Data	13
3.4 Manufacturer Data	14
<b>4 Test object Data</b>	<b>15</b>
4.1 General EUT Description	15
4.2 EUT Main components	15
4.3 Ancillary Equipment	16
4.4 Auxiliary Equipment	17
4.5 EUT Setups	18
4.6 Operating Modes / Test Channels	18
4.7 Product labelling	18
<b>5 Test Results</b>	<b>19</b>
5.1 26 dB Bandwidth	19
5.2 6 dB Bandwidth	27
5.3 99 % Bandwidth	30
5.4 Maximum Conducted Output Power	34
5.5 Peak Power Spectral Density	41
5.6 Undesirable Emissions; General Field Strength Limits	48
5.7 Band Edge	93
5.8 Dynamic Frequency Selection	117
<b>6 Test Equipment</b>	<b>121</b>
<b>7 Antenna Factors, Cable Loss and Sample Calculations</b>	<b>124</b>
7.1 LISN R&S ESH3-Z5 (150 kHz – 30 MHz)	124
7.2 Antenna R&S HFH2-Z2 (9 kHz – 30 MHz)	125
7.3 Antenna R&S HL562 (30 MHz – 1 GHz)	126
7.4 Antenna R&S HF907 (1 GHz – 18 GHz)	127
7.5 Antenna EMCO 3160-09 (18 GHz – 26.5 GHz)	128
7.6 Antenna EMCO 3160-10 (26.5 GHz – 40 GHz)	129
<b>8 Measurement Uncertainties</b>	<b>130</b>
<b>9 Photo Report</b>	<b>131</b>

## 1 APPLIED STANDARDS AND TEST SUMMARY

### 1.1 APPLIED STANDARDS

#### **Type of Authorization**

Certification for an Intentional Radiator (Digital Device / Spread Spectrum).

#### **Applicable FCC Rules**

Prepared in accordance with the requirements of FCC Rules and Regulations as listed in 47 CFR Ch.1 Parts 2 (10-1-20 Edition) and 15 (10-1-20 Edition). The following subparts are applicable to the results in this test report.

Part 2, Subpart J - Equipment Authorization Procedures, Certification

Part 15, Subpart C – Intentional Radiators

§ 15.201 Equipment authorization requirement

§ 15.207 Conducted limits

§ 15.209 Radiated emission limits; general requirements

Part 15, Subpart E – Unlicensed National Information Infrastructure Devices

§ 15.403 Definitions

§ 15.407 General technical requirements

#### Note:

The tests were selected and performed with reference to the FCC Public Notice “Guidelines for Compliance Testing of Unlicensed National Information Infrastructure (U-NII) Devices - Part 15, Subpart E, 789033 D02 General U-NII Test Procedures New Rules v02r01, 2017-12-14”.

COMPLIANCE MEASUREMENT PROCEDURES FOR UNLICENSED-NATIONAL INFORMATION INFRASTRUCTURE DEVICES OPERATING IN THE 5250-5350 MHz AND 5470-5725 MHz BANDS INCORPORATING DYNAMIC FREQUENCY SELECTION - 905462 D02 UNII DFS Compliance Procedures New Rules v02

ANSI C63.10-2013 is applied.

## 1.2 FCC-IC CORRELATION TABLE

### Correlation of measurement requirements for UNII / LE-LAN (e.g. WLAN 5 GHz) equipment from FCC and IC

#### UNII equipment

Measurement	FCC reference	IC reference
Conducted emissions on AC Mains	§ 15.207	RSS-Gen Issue 5: 8.8
Occupied bandwidth	§ 15.403 (26 dB) / § 15.407 (e) (6 dB)	RSS-247 Issue 2: 6.2.1.1, 6.2.2.1, 6.2.3.1 (99%) RSS-247 Issue 2: 6.2.4.1 (6 dB)
Maximum conducted output power	§ 15.407 (a) (1) to (8), (11)	RSS-247 Issue 2: 6.2.1.1, 6.2.2.1, 6.2.3.1, 6.2.4.1
Maximum power spectral density	§ 15.407 (a) (1) to (8), (12)	RSS-247 Issue 2: 6.2.1.1, 6.2.2.1, 6.2.3.1, 6.2.4.1
Transmitter undesirable emissions; General Field Strength Limits, Restricted Bands	§ 15.407 (b) § 15.209 (a)	RSS-Gen Issue 5: 6.13/8.9/8.10; RSS-247 Issue 2: 3.3/6.2 6.2.1.2, 6.2.2.2, 6.2.3.2, 6.2.4.2
Frequency stability	§ 15.407 (g)	RSS-Gen Issue 5: 6.11/8.11
Transmit Power Control (TPC) and Dynamic Frequency Selection (DFS)	§ 15.407 (h)	RSS-247 Issue 2: 6.2.2.1, 6.2.3.1, 6.3
Antenna requirement	§ 15.203 / 15.204 § 15.407 (a) (9)	RSS-Gen Issue 5: 8.3
Receiver spurious emissions	-	-

### 1.3 MEASUREMENT SUMMARY

#### 47 CFR CHAPTER I FCC PART 15 Subpart E §15.407

#### FCC §15.207

AC Conducted Emissions

The measurement was performed according to ANSI C63.10 6.2

**Final Result**

OP-Mode Radio Technology, Operating Frequency, Subband	Setup	Date	FCC	IC
WLAN a, mid, U-NII-2C	S03_161_AB01	2022-06-22	Passed	Passed

#### 47 CFR CHAPTER I FCC PART 15 Subpart E §15.407

#### FCC §15.31, §15.403 (i)

26 dB Bandwidth

The measurement was performed according to ANSI C63.10 12.4.1

**Final Result**

OP-Mode Radio Technology, Operating Frequency, Subband	Setup	Date	FCC	IC
WLAN a, high, U-NII-1	S01_161_AD01	2022-07-05	Performed	N/A
WLAN a, high, U-NII-2A	S01_161_AC01	2022-05-05	Performed	N/A
WLAN a, high, U-NII-2C	S01_161_AC01	2022-05-05	Performed	N/A
WLAN a, high, U-NII-3	S01_161_AC01	2022-05-05	Performed	N/A
WLAN a, low, U-NII-1	S01_161_AC01	2022-05-05	Performed	N/A
WLAN a, low, U-NII-2A	S01_161_AD01	2022-07-05	Performed	N/A
WLAN a, low, U-NII-2C	S01_161_AC01	2022-05-05	Performed	N/A
WLAN a, low, U-NII-3	S01_161_AD01	2022-07-05	Performed	N/A
WLAN a, mid, U-NII-1	S01_161_AD01	2022-07-05	Performed	N/A
WLAN a, mid, U-NII-2A	S01_161_AD01	2022-07-05	Performed	N/A
WLAN a, mid, U-NII-2C	S01_161_AC01	2022-05-05	Performed	N/A
WLAN a, mid, U-NII-3	S01_161_AD01	2022-07-05	Performed	N/A
WLAN n 20 MHz, high, U-NII-1	S01_161_AD01	2022-07-06	Performed	N/A
WLAN n 20 MHz, high, U-NII-2A	S01_161_AD01	2022-07-06	Performed	N/A
WLAN n 20 MHz, high, U-NII-2C	S01_161_AD01	2022-07-06	Performed	N/A
WLAN n 20 MHz, high, U-NII-3	S01_161_AD01	2022-07-06	Performed	N/A
WLAN n 20 MHz, low, U-NII-1	S01_161_AD01	2022-07-06	Performed	N/A
WLAN n 20 MHz, low, U-NII-2A	S01_161_AD01	2022-07-06	Performed	N/A
WLAN n 20 MHz, low, U-NII-2C	S01_161_AD01	2022-07-06	Performed	N/A
WLAN n 20 MHz, low, U-NII-3	S01_161_AD01	2022-07-06	Performed	N/A
WLAN n 20 MHz, mid, U-NII-1	S01_161_AD01	2022-07-06	Performed	N/A
WLAN n 20 MHz, mid, U-NII-2A	S01_161_AD01	2022-07-06	Performed	N/A
WLAN n 20 MHz, mid, U-NII-2C	S01_161_AD01	2022-07-06	Performed	N/A
WLAN n 20 MHz, mid, U-NII-3	S01_161_AD01	2022-07-06	Performed	N/A
WLAN n 40 MHz, high, U-NII-1	S01_161_AD01	2022-07-07	Performed	N/A
WLAN n 40 MHz, high, U-NII-2A	S01_161_AD01	2022-07-07	Performed	N/A
WLAN n 40 MHz, high, U-NII-2C	S01_161_AD01	2022-07-07	Performed	N/A
WLAN n 40 MHz, high, U-NII-3	S01_161_AD01	2022-07-07	Performed	N/A
WLAN n 40 MHz, low, U-NII-1	S01_161_AD01	2022-07-07	Performed	N/A

**47 CFR CHAPTER I FCC PART 15  
Subpart E §15.407**

**FCC §15.31, §15.403 (i)**

26 dB Bandwidth

The measurement was performed according to ANSI C63.10 12.4.1

**Final Result**

<b>OP-Mode</b> Radio Technology, Operating Frequency, Subband	<b>Setup</b>	<b>Date</b>	<b>FCC</b>	<b>IC</b>
WLAN n 40 MHz, low, U-NII-2A	S01_161_AD01	2022-07-07	Performed	N/A
WLAN n 40 MHz, low, U-NII-2C	S01_161_AD01	2022-07-07	Performed	N/A
WLAN n 40 MHz, low, U-NII-3	S01_161_AD01	2022-07-07	Performed	N/A
WLAN n 40 MHz, mid, U-NII-2C	S01_161_AD01	2022-07-07	Performed	N/A

**47 CFR CHAPTER I FCC PART 15  
Subpart E §15.407**

**FCC §15.31, §15.407 (e)**

6 dB Bandwidth

The measurement was performed according to ANSI C63.10 6.9.2

**Final Result**

<b>OP-Mode</b> Radio Technology, Operating Frequency, Subband	<b>Setup</b>	<b>Date</b>	<b>FCC</b>	<b>IC</b>
WLAN a, high, U-NII-3	S01_161_AC01	2022-05-05	Passed	Passed
WLAN a, low, U-NII-3	S01_161_AD01	2022-07-05	Passed	Passed
WLAN a, mid, U-NII-3	S01_161_AD01	2022-07-05	Passed	Passed
WLAN n 20 MHz, high, U-NII-3	S01_161_AD01	2022-07-06	Passed	Passed
WLAN n 20 MHz, low, U-NII-3	S01_161_AD01	2022-07-06	Passed	Passed
WLAN n 20 MHz, mid, U-NII-3	S01_161_AD01	2022-07-06	Passed	Passed
WLAN n 40 MHz, high, U-NII-3	S01_161_AD01	2022-07-07	Passed	Passed
WLAN n 40 MHz, low, U-NII-3	S01_161_AD01	2022-07-07	Passed	Passed

**47 CFR CHAPTER I FCC PART 15  
Subpart E §15.407**

**FCC §15.31, IC RSS 247 Ch. 6.2.x**

99 % Bandwidth

The measurement was performed according to ANSI C63.10 12.4.2 (6.9.3)

**Final Result**

<b>OP-Mode</b> Radio Technology, Operating Frequency, Subband	<b>Setup</b>	<b>Date</b>	<b>FCC</b>	<b>IC</b>
WLAN a, high, U-NII-1	S01_161_AD01	2022-07-05	Performed	Performed
WLAN a, high, U-NII-2A	S01_161_AC01	2022-05-05	Performed	Performed
WLAN a, high, U-NII-2C	S01_161_AC01	2022-05-05	Performed	Performed
WLAN a, high, U-NII-3	S01_161_AC01	2022-05-05	Performed	Performed
WLAN a, low, U-NII-1	S01_161_AC01	2022-05-05	Performed	Performed
WLAN a, low, U-NII-2A	S01_161_AD01	2022-07-05	Performed	Performed
WLAN a, low, U-NII-2C	S01_161_AC01	2022-05-05	Performed	Performed
WLAN a, low, U-NII-3	S01_161_AD01	2022-07-05	Performed	Performed
WLAN a, mid, U-NII-1	S01_161_AD01	2022-07-05	Performed	Performed
WLAN a, mid, U-NII-2A	S01_161_AC01	2022-05-05	Performed	Performed
WLAN a, mid, U-NII-2C	S01_161_AC01	2022-05-05	Performed	Performed
WLAN a, mid, U-NII-3	S01_161_AD01	2022-07-05	Performed	Performed
WLAN n 20 MHz, high, U-NII-1	S01_161_AD01	2022-07-06	Performed	Performed

**47 CFR CHAPTER I FCC PART 15  
Subpart E §15.407**

**FCC §15.31, IC RSS 247 Ch. 6.2.x**

99 % Bandwidth

The measurement was performed according to ANSI C63.10 12.4.2 (6.9.3) **Final Result**

<b>OP-Mode</b> Radio Technology, Operating Frequency, Subband	<b>Setup</b>	<b>Date</b>	<b>FCC</b>	<b>IC</b>
WLAN n 20 MHz, high, U-NII-2A	S01_161_AD01	2022-07-06	Performed	Performed
WLAN n 20 MHz, high, U-NII-2C	S01_161_AD01	2022-07-06	Performed	Performed
WLAN n 20 MHz, high, U-NII-3	S01_161_AD01	2022-07-06	Performed	Performed
WLAN n 20 MHz, low, U-NII-1	S01_161_AD01	2022-07-06	Performed	Performed
WLAN n 20 MHz, low, U-NII-2A	S01_161_AD01	2022-07-06	Performed	Performed
WLAN n 20 MHz, low, U-NII-2C	S01_161_AD01	2022-07-06	Performed	Performed
WLAN n 20 MHz, low, U-NII-3	S01_161_AD01	2022-07-06	Performed	Performed
WLAN n 20 MHz, mid, U-NII-1	S01_161_AD01	2022-07-06	Performed	Performed
WLAN n 20 MHz, mid, U-NII-2A	S01_161_AD01	2022-07-06	Performed	Performed
WLAN n 20 MHz, mid, U-NII-2C	S01_161_AD01	2022-07-06	Performed	Performed
WLAN n 20 MHz, mid, U-NII-3	S01_161_AD01	2022-07-06	Performed	Performed
WLAN n 40 MHz, high, U-NII-1	S01_161_AD01	2022-04-27	Performed	Performed
WLAN n 40 MHz, high, U-NII-2A	S01_161_AD01	2022-04-27	Performed	Performed
WLAN n 40 MHz, high, U-NII-2C	S01_161_AD01	2022-04-27	Performed	Performed
WLAN n 40 MHz, high, U-NII-3	S01_161_AD01	2022-04-27	Performed	Performed
WLAN n 40 MHz, low, U-NII-1	S01_161_AD01	2022-04-29	Performed	Performed
WLAN n 40 MHz, low, U-NII-2A	S01_161_AD01	2022-04-27	Performed	Performed
WLAN n 40 MHz, low, U-NII-2C	S01_161_AD01	2022-04-27	Performed	Performed
WLAN n 40 MHz, low, U-NII-3	S01_161_AD01	2022-04-27	Performed	Performed
WLAN n 40 MHz, mid, U-NII-2C	S01_161_AD01	2022-04-27	Performed	Performed

**47 CFR CHAPTER I FCC PART 15  
Subpart E §15.407**

**FCC §15.31, §15.407 (a)(1)**

Maximum Conducted Output Power

The measurement was performed according to ANSI C63.10 12.3.3.2 **Final Result**

<b>OP-Mode</b> Radio Technology, Operating Frequency, Subband	<b>Setup</b>	<b>Date</b>	<b>FCC</b>	<b>IC</b>
WLAN a, high, U-NII-1	S01_161_AD01	2022-07-05	Passed	Passed
WLAN a, high, U-NII-2A	S01_161_AC01	2022-05-05	Passed	Passed
WLAN a, high, U-NII-2C	S01_161_AC01	2022-05-05	Passed	Passed
WLAN a, high, U-NII-3	S01_161_AC01	2022-05-05	Passed	Passed
WLAN a, low, U-NII-1	S01_161_AC01	2022-05-05	Passed	Passed
WLAN a, low, U-NII-2A	S01_161_AD01	2022-07-05	Passed	Passed
WLAN a, low, U-NII-2C	S01_161_AC01	2022-05-05	Passed	Passed
WLAN a, low, U-NII-3	S01_161_AD01	2022-07-05	Passed	Passed
WLAN a, mid, U-NII-1	S01_161_AD01	2022-07-05	Passed	Passed
WLAN a, mid, U-NII-2A	S01_161_AD01	2022-07-05	Passed	Passed
WLAN a, mid, U-NII-2C	S01_161_AC01	2022-05-05	Passed	Passed
WLAN a, mid, U-NII-3	S01_161_AD01	2022-07-05	Passed	Passed
WLAN n 20 MHz, high, U-NII-1	S01_161_AD01	2022-07-06	Passed	Passed

**47 CFR CHAPTER I FCC PART 15  
Subpart E §15.407**

**FCC §15.31, §15.407 (a)(1)**

Maximum Conducted Output Power

The measurement was performed according to ANSI C63.10 12.3.3.2

**Final Result**

<b>OP-Mode</b> Radio Technology, Operating Frequency, Subband	<b>Setup</b>	<b>Date</b>	<b>FCC</b>	<b>IC</b>
WLAN n 20 MHz, high, U-NII-2A	S01_161_AD01	2022-07-06	Passed	Passed
WLAN n 20 MHz, high, U-NII-2C	S01_161_AD01	2022-07-06	Passed	Passed
WLAN n 20 MHz, high, U-NII-3	S01_161_AD01	2022-07-06	Passed	Passed
WLAN n 20 MHz, low, U-NII-1	S01_161_AD01	2022-07-06	Passed	Passed
WLAN n 20 MHz, low, U-NII-2A	S01_161_AD01	2022-07-06	Passed	Passed
WLAN n 20 MHz, low, U-NII-2C	S01_161_AD01	2022-07-06	Passed	Passed
WLAN n 20 MHz, low, U-NII-3	S01_161_AD01	2022-07-06	Passed	Passed
WLAN n 20 MHz, mid, U-NII-1	S01_161_AD01	2022-07-06	Passed	Passed
WLAN n 20 MHz, mid, U-NII-2A	S01_161_AD01	2022-07-06	Passed	Passed
WLAN n 20 MHz, mid, U-NII-2C	S01_161_AD01	2022-07-06	Passed	Passed
WLAN n 20 MHz, mid, U-NII-3	S01_161_AD01	2022-07-06	Passed	Passed
WLAN n 40 MHz, high, U-NII-1	S01_161_AD01	2022-07-07	Passed	Passed
WLAN n 40 MHz, high, U-NII-2A	S01_161_AD01	2022-07-07	Passed	Passed
WLAN n 40 MHz, high, U-NII-2C	S01_161_AD01	2022-07-07	Passed	Passed
WLAN n 40 MHz, high, U-NII-3	S01_161_AD01	2022-07-07	Passed	Passed
WLAN n 40 MHz, low, U-NII-1	S01_161_AD01	2022-07-07	Passed	Passed
WLAN n 40 MHz, low, U-NII-2A	S01_161_AD01	2022-07-07	Passed	Passed
WLAN n 40 MHz, low, U-NII-2C	S01_161_AD01	2022-07-07	Passed	Passed
WLAN n 40 MHz, low, U-NII-3	S01_161_AD01	2022-07-07	Passed	Passed
WLAN n 40 MHz, mid, U-NII-2C	S01_161_AD01	2022-07-07	Passed	Passed

**47 CFR CHAPTER I FCC PART 15  
Subpart E §15.407**

**FCC §15.31, §15.407 (a) (1),(5)**

Peak Power Spectral Density

The measurement was performed according to ANSI C63.10 12.5 (SA-3)

**Final Result**

<b>OP-Mode</b> Radio Technology, Operating Frequency, Subband	<b>Setup</b>	<b>Date</b>	<b>FCC</b>	<b>IC</b>
WLAN a, high, U-NII-1	S01_161_AD01	2022-07-05	Passed	Passed
WLAN a, high, U-NII-2A	S01_161_AC01	2022-05-05	Passed	Passed
WLAN a, high, U-NII-2C	S01_161_AC01	2022-05-05	Passed	Passed
WLAN a, high, U-NII-3	S01_161_AC01	2022-05-05	Passed	Passed
WLAN a, low, U-NII-1	S01_161_AC01	2022-05-05	Passed	Passed
WLAN a, low, U-NII-2A	S01_161_AD01	2022-07-05	Passed	Passed
WLAN a, low, U-NII-2C	S01_161_AC01	2022-05-05	Passed	Passed
WLAN a, low, U-NII-3	S01_161_AD01	2022-07-05	Passed	Passed
WLAN a, mid, U-NII-1	S01_161_AD01	2022-07-05	Passed	Passed
WLAN a, mid, U-NII-2A	S01_161_AD01	2022-07-05	Passed	Passed
WLAN a, mid, U-NII-2C	S01_161_AC01	2022-05-05	Passed	Passed
WLAN a, mid, U-NII-3	S01_161_AD01	2022-07-05	Passed	Passed
WLAN n 20 MHz, high, U-NII-1	S01_161_AD01	2022-07-06	Passed	Passed



**47 CFR CHAPTER I FCC PART 15  
Subpart E §15.407**

**FCC §15.31, §15.407 (a) (1),(5)**

Peak Power Spectral Density

The measurement was performed according to ANSI C63.10 12.5 (SA-3)

**Final Result**

<b>OP-Mode</b> Radio Technology, Operating Frequency, Subband	<b>Setup</b>	<b>Date</b>	<b>FCC</b>	<b>IC</b>
WLAN n 20 MHz, high, U-NII-2A	S01_161_AD01	2022-07-06	Passed	Passed
WLAN n 20 MHz, high, U-NII-2C	S01_161_AD01	2022-07-06	Passed	Passed
WLAN n 20 MHz, high, U-NII-3	S01_161_AD01	2022-07-06	Passed	Passed
WLAN n 20 MHz, low, U-NII-1	S01_161_AD01	2022-07-06	Passed	Passed
WLAN n 20 MHz, low, U-NII-2A	S01_161_AD01	2022-07-06	Passed	Passed
WLAN n 20 MHz, low, U-NII-2C	S01_161_AD01	2022-07-06	Passed	Passed
WLAN n 20 MHz, low, U-NII-3	S01_161_AD01	2022-07-06	Passed	Passed
WLAN n 20 MHz, mid, U-NII-1	S01_161_AD01	2022-07-06	Passed	Passed
WLAN n 20 MHz, mid, U-NII-2A	S01_161_AD01	2022-07-06	Passed	Passed
WLAN n 20 MHz, mid, U-NII-2C	S01_161_AD01	2022-07-06	Passed	Passed
WLAN n 20 MHz, mid, U-NII-3	S01_161_AD01	2022-07-06	Passed	Passed
WLAN n 40 MHz, high, U-NII-1	S01_161_AD01	2022-07-07	Passed	Passed
WLAN n 40 MHz, high, U-NII-2A	S01_161_AD01	2022-07-07	Passed	Passed
WLAN n 40 MHz, high, U-NII-2C	S01_161_AD01	2022-07-07	Passed	Passed
WLAN n 40 MHz, high, U-NII-3	S01_161_AD01	2022-07-07	Passed	Passed
WLAN n 40 MHz, low, U-NII-1	S01_161_AD01	2022-07-07	Passed	Passed
WLAN n 40 MHz, low, U-NII-2A	S01_161_AD01	2022-07-07	Passed	Passed
WLAN n 40 MHz, low, U-NII-2C	S01_161_AD01	2022-07-07	Passed	Passed
WLAN n 40 MHz, low, U-NII-3	S01_161_AD01	2022-07-07	Passed	Passed
WLAN n 40 MHz, mid, U-NII-2C	S01_161_AD01	2022-07-07	Passed	Passed

**47 CFR CHAPTER I FCC PART 15  
Subpart E §15.407**

**FCC §15.407 (b), (1),(2),(3),(4); FCC  
§15.205, §15.209, §15.407 (b) (5),(6)**

Undesirable Emissions; General Field Strength Limits

The measurement was performed according to ANSI C63.10 6.4, 6.5, 6.6.5

**Final Result**

<b>OP-Mode</b> Radio Technology, Operating Frequency, Measurement range, Subband	<b>Setup</b>	<b>Date</b>	<b>FCC</b>	<b>IC</b>
WLAN a, high, 1GHz - 26GHz, U-NII-1 Remark: harmonics measured only	S02_161_AB01	2022-06-01	Passed	Passed
WLAN a, high, 1GHz - 26GHz, U-NII-1	S01_161_AD01	2022-06-03	Passed	Passed
WLAN a, high, 1GHz - 26GHz, U-NII-2A	S02_161_AC01	2022-04-08	Passed	Passed
WLAN a, high, 1GHz - 26GHz, U-NII-2A	S01_161_AD01	2022-06-03	Passed	Passed
WLAN a, high, 1GHz - 26GHz, U-NII-2C	S02_161_AB01	2022-04-12	Passed	Passed
WLAN a, high, 1GHz - 26GHz, U-NII-2C	S01_161_AD01	2022-06-03	Passed	Passed
WLAN a, high, 1GHz - 26GHz, U-NII-3	S02_161_AB01	2022-04-19	Passed	Passed
WLAN a, high, 1GHz - 26GHz, U-NII-3	S01_161_AD01	2022-06-03	Passed	Passed
WLAN a, high, 9kHz - 30MHz, U-NII-2C	S02_161_AB01	2022-05-09	Passed	Passed
WLAN a, low, 1GHz - 26GHz, U-NII-1	S02_161_AC01	2022-04-07	Passed	Passed
WLAN a, low, 1GHz - 26GHz, U-NII-1	S01_161_AD01	2022-06-03	Passed	Passed
WLAN a, low, 1GHz - 26GHz, U-NII-2A Remark: harmonics measured only	S02_161_AB01	2022-06-02	Passed	Passed

**47 CFR CHAPTER I FCC PART 15  
Subpart E §15.407**

**FCC §15.407 (b), (1),(2),(3),(4); FCC  
§15.205, §15.209, §15.407 (b) (5),(6)**

Undesirable Emissions; General Field Strength Limits

The measurement was performed according to ANSI C63.10 6.4, 6.5, 6.6.5 **Final Result**

<b>OP-Mode</b>	<b>Setup</b>	<b>Date</b>	<b>FCC</b>	<b>IC</b>
Radio Technology, Operating Frequency, Measurement range, Subband				
WLAN a, low, 1GHz - 26GHz, U-NII-2A	S01_161_AD01	2022-06-03	Passed	Passed
WLAN a, low, 1GHz - 26GHz, U-NII-2C	S02_161_AB01	2022-04-11	Passed	Passed
WLAN a, low, 1GHz - 26GHz, U-NII-2C	S01_161_AD01	2022-06-03	Passed	Passed
WLAN a, low, 1GHz - 26GHz, U-NII-3	S02_161_AB01	2022-05-25	Passed	Passed
Remark: harmonics measured only				
WLAN a, low, 1GHz - 26GHz, U-NII-3	S01_161_AD01	2022-06-03	Passed	Passed
WLAN a, low, 9kHz - 30MHz, U-NII-1	S02_161_AB01	2022-05-09	Passed	Passed
WLAN a, mid, 1GHz - 26GHz, U-NII-1	S02_161_AB01	2022-06-01	Passed	Passed
Remark: harmonics measured only				
WLAN a, mid, 1GHz - 26GHz, U-NII-1	S01_161_AD01	2022-06-03	Passed	Passed
WLAN a, mid, 1GHz - 26GHz, U-NII-2A	S02_161_AB01	2022-06-02	Passed	Passed
Remark: harmonics measured only				
WLAN a, mid, 1GHz - 26GHz, U-NII-2A	S01_161_AD01	2022-06-03	Passed	Passed
WLAN a, mid, 1GHz - 26GHz, U-NII-2C	S02_161_AB01	2022-05-05	Passed	Passed
WLAN a, mid, 1GHz - 26GHz, U-NII-2C	S01_161_AD01	2022-06-03	Passed	Passed
WLAN a, mid, 1GHz - 26GHz, U-NII-3	S02_161_AB01	2022-05-25	Passed	Passed
Remark: harmonics measured only				
WLAN a, mid, 1GHz - 26GHz, U-NII-3	S01_161_AD01	2022-06-03	Passed	Passed
WLAN a, mid, 26GHz - 40GHz, U-NII-1	S02_161_AB01	2022-05-05	Passed	Passed
WLAN a, mid, 26GHz - 40GHz, U-NII-1	S01_161_AD01	2022-06-03	Passed	Passed
WLAN a, mid, 26GHz - 40GHz, U-NII-2A	S02_161_AB01	2022-05-05	Passed	Passed
WLAN a, mid, 26GHz - 40GHz, U-NII-2A	S01_161_AD01	2022-06-03	Passed	Passed
WLAN a, mid, 26GHz - 40GHz, U-NII-2C	S02_161_AB01	2022-05-05	Passed	Passed
WLAN a, mid, 26GHz - 40GHz, U-NII-2C	S01_161_AD01	2022-06-03	Passed	Passed
WLAN a, mid, 26GHz - 40GHz, U-NII-3	S02_161_AB01	2022-05-05	Passed	Passed
WLAN a, mid, 26GHz - 40GHz, U-NII-3	S01_161_AD01	2022-06-03	Passed	Passed
WLAN a, mid, 30MHz - 1GHz, U-NII-1	S02_161_AB01	2022-03-28	Passed	Passed
WLAN a, mid, 30MHz - 1GHz, U-NII-1	S01_161_AD01	2022-06-14	Passed	Passed
WLAN a, mid, 30MHz - 1GHz, U-NII-2A	S02_161_AB01	2022-03-28	Passed	Passed
WLAN a, mid, 30MHz - 1GHz, U-NII-2A	S01_161_AD01	2022-06-14	Passed	Passed
WLAN a, mid, 30MHz - 1GHz, U-NII-2C	S02_161_AB01	2022-04-07	Passed	Passed
WLAN a, mid, 30MHz - 1GHz, U-NII-2C	S01_161_AD01	2022-06-14	Passed	Passed
WLAN a, mid, 30MHz - 1GHz, U-NII-3	S02_161_AB01	2022-04-07	Passed	Passed
WLAN a, mid, 30MHz - 1GHz, U-NII-3	S01_161_AD01	2022-06-14	Passed	Passed
WLAN a, mid, 9kHz - 30MHz, U-NII-1	S01_161_AD01	2022-06-14	Passed	Passed
WLAN a, mid, 9kHz - 30MHz, U-NII-2A	S01_161_AD01	2022-06-14	Passed	Passed
WLAN a, mid, 9kHz - 30MHz, U-NII-2C	S01_161_AD01	2022-06-14	Passed	Passed
WLAN a, mid, 9kHz - 30MHz, U-NII-3	S01_161_AD01	2022-06-14	Passed	Passed
WLAN n 20 MHz, low, 1GHz - 26GHz, U-NII-3	S01_161_AD01	2022-06-17	Passed	Passed
WLAN n 20 MHz, mid, 1GHz - 26GHz, U-NII-2C	S01_161_AD01	2022-06-17	Passed	Passed
WLAN n 40 MHz, low, 1GHz - 26GHz, U-NII-3	S01_161_AD01	2022-06-17	Passed	Passed

**47 CFR CHAPTER I FCC PART 15  
Subpart E §15.407**

**FCC §15.407 (b), (1),(2),(3),(4)**

Band Edge

The measurement was performed according to ANSI C63.10 6.6.5

**Final Result**

<b>OP-Mode</b> Radio Technology, Operating Frequency, Subband	<b>Setup</b>	<b>Date</b>	<b>FCC</b>	<b>IC</b>
WLAN a, high, U-NII-2A	S01_161_AA01	2022-03-16	Passed	Passed
WLAN a, high, U-NII-2A	S02_161_AC01	2022-04-08	Passed	Passed
WLAN a, high, U-NII-2C	S01_161_AA01	2022-03-16	Passed	Passed
WLAN a, high, U-NII-2C	S02_161_AB01	2022-04-12	Passed	Passed
WLAN a, high, U-NII-3	S01_161_AA01	2022-03-16	Passed	Passed
WLAN a, high, U-NII-3	S02_161_AB01	2022-05-25	Passed	Passed
WLAN a, low, U-NII-1	S01_161_AA01	2022-03-16	Passed	Passed
WLAN a, low, U-NII-1	S02_161_AC01	2022-04-07	Passed	Passed
WLAN a, low, U-NII-2C	S01_161_AA01	2022-03-16	Passed	Passed
WLAN a, low, U-NII-2C	S02_161_AB01	2022-04-11	Passed	Passed
WLAN a, low, U-NII-3	S01_161_AA01	2022-07-22	Passed	Passed
WLAN a, low, U-NII-3	S02_161_AB01	2022-05-25	Passed	Passed
WLAN n 20 MHz, high, U-NII-2A	S01_161_AA01	2022-03-16	Passed	Passed
WLAN n 20 MHz, high, U-NII-2C	S01_161_AA01	2022-03-16	Passed	Passed
WLAN n 20 MHz, high, U-NII-3	S01_161_AA01	2022-03-16	Passed	Passed
WLAN n 20 MHz, low, U-NII-1	S01_161_AA01	2022-03-16	Passed	Passed
WLAN n 20 MHz, low, U-NII-2C	S01_161_AA01	2022-03-16	Passed	Passed
WLAN n 20 MHz, low, U-NII-3	S01_161_AA01	2022-03-16	Passed	Passed
WLAN n 40 MHz, high, U-NII-2A	S01_161_AA01	2022-03-16	Passed	Passed
WLAN n 40 MHz, high, U-NII-2C	S01_161_AA01	2022-03-16	Passed	Passed
WLAN n 40 MHz, high, U-NII-3	S01_161_AA01	2022-03-16	Passed	Passed
WLAN n 40 MHz, low, U-NII-1	S01_161_AA01	2022-03-16	Passed	Passed
WLAN n 40 MHz, low, U-NII-2C	S01_161_AA01	2022-03-16	Passed	Passed
WLAN n 40 MHz, low, U-NII-3	S01_161_AA01	2022-03-16	Passed	Passed

**47 CFR CHAPTER I FCC PART 15  
Subpart E §15.407**

**FCC §15.31, §15.407 (h)**

Dynamic Frequency Selection

The measurement was performed according to KDB 905462 D02

**Final Result**

<b>OP-Mode</b> Radio Technology, Operating Frequency, Subband	<b>Setup</b>	<b>Date</b>	<b>FCC</b>	<b>IC</b>
WLAN n 40 MHz, mid, U-NII-2C	S01_161_AD01	2022-06-22	Passed	Passed

N/A: Not applicable  
N/P: Not performed

## 2 REVISION HISTORY / SIGNATURES

Report version control			
Version	Release date	Change Description	Version validity
initial	2022-08-08	--	valid
--	--	--	--

COMMENT: -



(responsible for accreditation scope)  
Dipl.-Ing. Daniel Gall

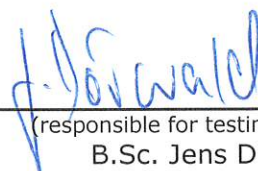

(responsible for testing and report)  
B.Sc. Jens Dörwald



7 layers GmbH, Borsigstr. 11  
40880 Ratingen, Germany  
Phone +49 (0)2102 749 0

### 3 ADMINISTRATIVE DATA

#### 3.1 TESTING LABORATORY

Company Name: 7layers GmbH  
Address: Borsigstr. 11  
40880 Ratingen  
Germany

The test facility is accredited by the following accreditation organisation:

Laboratory accreditation no: DAKKS D-PL-12140-01-01 | -02 | -03  
FCC Designation Number: DE0015  
FCC Test Firm Registration: 929146  
ISED CAB Identifier: DE0007; ISED#: 3699A

Responsible for accreditation scope: Dipl.-Ing. Daniel Gall

Report Template Version: 2021-09-09

#### 3.2 PROJECT DATA

Responsible for testing and report: B.Sc. Jens Dörwald  
Employees who performed the tests: documented internally at 7Layers  
Date of Report: 2022-08-08  
Testing Period: 2022-03-16 to 2022-07-22

#### 3.3 APPLICANT DATA

Company Name: u-blox AG  
Address: Zürcherstrasse 68  
8800 Thalwil  
Switzerland  
Contact Person: Filip Kruzela

### 3.4 MANUFACTURER DATA

Company Name: please see Applicant Data

Address:

Contact Person:

## 4 TEST OBJECT DATA

### 4.1 GENERAL EUT DESCRIPTION

Kind of Device product description	Host-based module with WLAN and Bluetooth technology																																																																																								
Product name	MAYA W161-00B-00																																																																																								
Type	MAYA W161-00B-00																																																																																								
<b>Declared EUT data by the supplier</b>																																																																																									
Voltage Type	DC																																																																																								
Voltage Level	1.8 V + 3.3 V																																																																																								
Tested Modulation Type	OFDM																																																																																								
Specific product description	<p>The EUT is a Bluetooth and WLAN module.</p> <p>In the 5 GHz band it supports SISO Mode only.</p> <p>Supported WLAN modes are a and n with a 20 MHz BW, n with 40 MHz BW.</p> <p>The U-NII bands 1, 2A, 2C and 3 are supported. For this report the EUT is a slave without radar detection in the relevant DFS bands.</p>																																																																																								
Ports of the device	<p>Enclosure</p> <p>Data</p> <p>DC Power</p> <p>Antenna</p> <p>The EUT is a module with solder pads for surface mounting, so no cables were connected to the EUT itself.</p>																																																																																								
Antenna 1	2 dBi																																																																																								
Tested Datarates	<p>WLAN a: 6 Mbit</p> <p>WLAN n: MCS 0</p>																																																																																								
Special software used for testing	Scripts were provided by the applicant on a laptop that control a board computer, which sets the test modes of the EUT.																																																																																								
Used output power	<table border="1"> <thead> <tr> <th>Mode   Ch.</th> <th>36</th> <th>40</th> <th>44</th> <th>48</th> <th>52</th> <th>56</th> <th>60</th> <th>64</th> <th>100</th> <th>104</th> <th>108</th> <th>112</th> <th>116</th> <th>132</th> <th>136</th> <th>140</th> <th>149</th> <th>153</th> <th>157</th> <th>161</th> <th>165</th> </tr> </thead> <tbody> <tr> <td>A</td> <td>17</td> <td>17</td> <td>17</td> <td>17</td> <td>17</td> <td>17</td> <td>17</td> <td>16</td> <td>16</td> <td>18</td> <td>18</td> <td>18</td> <td>18</td> <td>18</td> <td>16</td> <td>14</td> <td>16</td> <td>16</td> <td>17</td> <td>18</td> <td>18</td> </tr> <tr> <td>N20 SISO</td> <td>16</td> <td>16</td> <td>16</td> <td>16</td> <td>16</td> <td>16</td> <td>16</td> <td>15</td> <td>15</td> <td>16</td> <td>16</td> <td>16</td> <td>16</td> <td>16</td> <td>16</td> <td>14</td> <td>16</td> <td>16</td> <td>16</td> <td>16</td> <td>16</td> </tr> <tr> <td>N40 SISO</td> <td>14</td> <td></td> <td>16</td> <td></td> <td>16</td> <td></td> <td>14</td> <td></td> <td>13</td> <td></td> <td>16</td> <td></td> <td>N/A</td> <td>13</td> <td></td> <td></td> <td>16</td> <td></td> <td>16</td> <td></td> <td>N/A</td> </tr> </tbody> </table>	Mode   Ch.	36	40	44	48	52	56	60	64	100	104	108	112	116	132	136	140	149	153	157	161	165	A	17	17	17	17	17	17	17	16	16	18	18	18	18	18	16	14	16	16	17	18	18	N20 SISO	16	16	16	16	16	16	16	15	15	16	16	16	16	16	16	14	16	16	16	16	16	N40 SISO	14		16		16		14		13		16		N/A	13			16		16		N/A
Mode   Ch.	36	40	44	48	52	56	60	64	100	104	108	112	116	132	136	140	149	153	157	161	165																																																																				
A	17	17	17	17	17	17	17	16	16	18	18	18	18	18	16	14	16	16	17	18	18																																																																				
N20 SISO	16	16	16	16	16	16	16	15	15	16	16	16	16	16	16	14	16	16	16	16	16																																																																				
N40 SISO	14		16		16		14		13		16		N/A	13			16		16		N/A																																																																				

#### 4.2 EUT MAIN COMPONENTS

Sample Name	Sample Code	Description
MAYA W161 AA01	DE1015158aa01	
Sample Parameter	Value	
Serial No.	M416C1DEB90BB4C0400	
HW Version	04	
SW Version	W16.92.21.p22-16.92.21.p22-MXM5X16298_V0	
Comment		

Sample Name	Sample Code	Description
MAYA W161 AB01	DE1015158ab01	
Sample Parameter	Value	
Serial No.	M416C1DEB90BA740400	
HW Version	04	
SW Version	W16.92.21.p22-16.92.21.p22-MXM5X16298_V0	
Comment		

Sample Name	Sample Code	Description
MAYA W161 AC01	DE1015158ac01	
Sample Parameter	Value	
Serial No.	M416C1DEB90BA840400	
HW Version	04	
SW Version	W16.92.21.p22-16.92.21.p22-MXM5X16298_V0	
Comment		

Sample Name	Sample Code	Description
MAYA W161 AD01	DE1015158ad01	
Sample Parameter	Value	
Serial No.	M416C1DEB90BB240400	
HW Version	04	
SW Version	W16.92.21.p22-16.92.21.p22-MXM5X16298_V0	
Comment		

NOTE: The short description is used to simplify the identification of the EUT in this test report.

#### 4.3 ANCILLARY EQUIPMENT

For the purposes of this test report, ancillary equipment is defined as equipment which is used in conjunction with the EUT to provide operational and control features to the EUT. It is necessary to configure the system in a typical fashion, as a customer would normally use it. But nevertheless Ancillary Equipment can influence the test results.

Device	Details (Manufacturer, Type Model, OUT Code)	Description
-	-	-



#### 4.4 AUXILIARY EQUIPMENT

For the purposes of this test report, auxiliary equipment is defined as equipment which is used temporarily to enable operational and control features especially used for the tests of the EUT which is not used during normal operation or equipment that is used during the tests in combination with the EUT but is not subject of this test report. It is necessary to configure the system in a typical fashion, as a customer would normally use it. But nevertheless Auxiliary Equipment can influence the test results.

<b>Device</b>	<b>Details (Manufacturer, Type Model, HW, SW, S/N)</b>	<b>Description</b>
AUX1	UBLOX, MAYA-W1 EVK, Rev. A, - , 10000002626314002004	Evaluation Board for module providing ports
AUX10	Toradex, Ixora, V1.2A, -, 10824714	Board Computer connected to Evaluation board for setting modes
AUX11	Toradex, Ixora, V1.2A, -, 10824739	Board Computer connected to Evaluation board for setting modes
AUX12	DELL, Latitude E7250, -, -, 43283371358	Laptop computer with prepared scripts controlling AUX10
AUX13	DELL, Latitude E7270, 2016, -, 14393036990	Laptop computer with prepared scripts controlling AUX11
AUX2	UBLOX, MAYA-W1 EVK, Rev. A, - , 10000002626314002001	Evaluation Board for module providing ports
AUX3	UBLOX, MAYA-W1 EVK, Rev. A, - , 10000002626314002002	Evaluation Board for module providing ports
AUX4	UBLOX, MAYA-W1 EVK, Rev. A, - , 10000002626314001001	Evaluation Board for module providing ports
ACDC1	Agilent, E3631A, -, -, MY40018563	120 V 60 Hz AC laboratory power supply

## 4.5 EUT SETUPS

This chapter describes the combination of EUTs and equipment used for testing. The rationale for selecting the EUTs, ancillary and auxiliary equipment and interconnecting cables, is to test a representative configuration meeting the requirements of the referenced standards.

Setup	Combination of EUTs	Description and Rationale
S01_161_AD01	MAYA W161 AD01, AUX11, AUX4, AUX12, AUX10, AUX13,	Conducted Setup
S01_161_AC01	MAYA W161 AC01, AUX3, AUX11, AUX12, AUX10, AUX13,	Conducted Setup
S02_161_AC01	MAYA W161 AC01, AUX3	Radiated Setup
S01_161_AA01	MAYA W161 AA01, AUX11, AUX12, AUX10, AUX13, AUX1,	Conducted Setup
S01_161_AB01	MAYA W161 AB01, AUX11, AUX2, AUX12, AUX10, AUX13,	Conducted Setup
S02_161_AB01	MAYA W161 AB01, AUX2	Radiated Setup
S03_161_AB01	MAYA W161 AB01, AUX2, ACDC1	Radiated Setup

## 4.6 OPERATING MODES / TEST CHANNELS

This chapter describes the operating modes of the EUTs used for testing.

U-NII-Subband 1 5150 - 5250 MHz			U-NII-Subband 2A 5250 - 5350 MHz			U-NII-Subband 2C 5470 - 5725 MHz			U-NII-Subband 3 5725 - 5850 MHz			Nom. BW
low	mid	high	low	mid	high	low	mid	high	low	mid	high	20 MHz
36	40	48	52	60	64	100	116	140	149	157	165	Ch.-No.
5180	5200	5240	5260	5300	5320	5500	5580	5700	5745	5785	5825	MHz

low	mid	high	low	mid	high	low	mid	high	low	mid	high	40 MHz
38	-	46	54	-	62	102	110	138	151	-	159	Ch.-No.
5190	-	5230	5270	-	5310	5510	5550	5690	5755	-	5795	MHz

## 4.7 PRODUCT LABELLING

### 4.7.1 FCC ID LABEL

Please refer to the documentation of the applicant.

### 4.7.2 LOCATION OF THE LABEL ON THE EUT

Please refer to the documentation of the applicant.

## 5 TEST RESULTS

### 5.1 AC CONDUCTED EMISSIONS

Standard **FCC Part 15 Subpart E**

**The test was performed according to:**  
ANSI C63.10 6.2

#### 5.1.1 TEST DESCRIPTION

The test set-up was made in accordance to the general provisions of ANSI C 63.10. The Equipment Under Test (EUT) was setup in a shielded room to perform the conducted emissions measurements in a typical installation configuration. The EUT was powered from 50 $\mu$ H || 50 Ohm Line Impedance Stabilization Network (LISN). The LISN's unused connections were terminated with 50 Ohm loads.

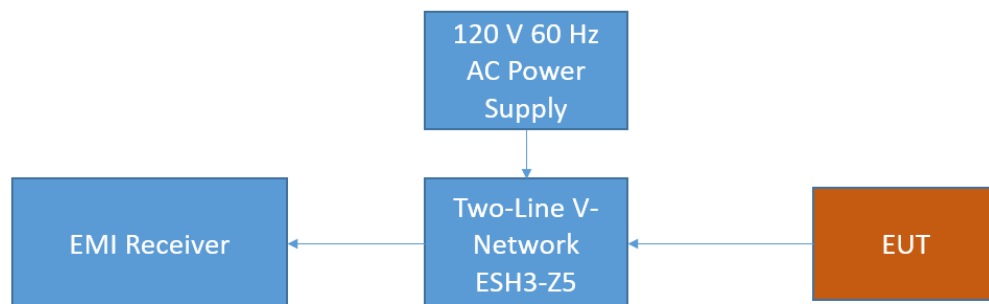

FCC Conducted Emissions on AC

The measurement procedure consists of two steps. It is implemented into the EMI test software EMC-32 from R&S.

#### **Step 1: Preliminary scan**

Intention of this step is, to determine the conducted EMI-profile of the EUT.

EMI receiver settings:

- Detector: Peak – Maxhold & Average
- Frequency range: 150 kHz – 30 MHz
- Frequency steps: 2.5 kHz
- IF-Bandwidth: 9 kHz
- Measuring time / Frequency step: 100 ms (FFT-based)
- Measurement on phase + neutral lines of the power cords

On basis of this preliminary scan the highest amplitudes and the corresponding frequencies relative to the limit are identified. Emissions above the limit and emissions which are in the 10 dB range below the limit are considered.

#### **Step 2: Final measurement**

Intention of this step is, to determine the highest emissions with the settings defined in the test specification for the frequencies identified in step 1.

EMI receiver settings:

- Detector: Quasi-Peak & (CISPR) Average

- IF Bandwidth: 9 kHz
- Measuring time: 1 s / frequency

At each frequency determined in step 1, four measurements are performed in the following combinations:

- 1) Neutral lead - reference ground (PE grounded)
- 2) Phase lead - reference ground (PE grounded)
- 3) Neutral lead - reference ground (PE floating)
- 4) Phase lead - reference ground (PE floating)

The highest value is reported.

### 5.1.2 TEST REQUIREMENTS / LIMITS

FCC Part 15, Subpart C, §15.207

Frequency (MHz)	QP Limits (dB $\mu$ V)	AV Limits (dB $\mu$ V)
0.15 - 0.5	66 - 56	56 - 46
0.5 - 5	56	46
5 - 30	60	50

### 5.1.3 TEST PROTOCOL

Temperature: 28 °C  
 Air Pressure: 1008 hPa  
 Humidity: 40 %

Power line	PE	Frequency [MHz]	Measured value QP [dB $\mu$ V]	Measured value AV [dB $\mu$ V]	Limit [dB $\mu$ V]	Margin [dB]
N	GND	12.005	45.7	-	60.0	14.3
N	GND	12.005	-	42.0	50.0	8.0
N	FLO	24.009	46.2	-	60.0	13.8
N	FLO	24.009	-	43.7	50.0	6.3

Remark: Please see next sub-clause for the measurement plot.

### 5.1.4 MEASUREMENT PLOT (EXAMPLE PLOT, SHOWING WORST CASE, IF APPLICABLE)

(S03\_161\_AB01)

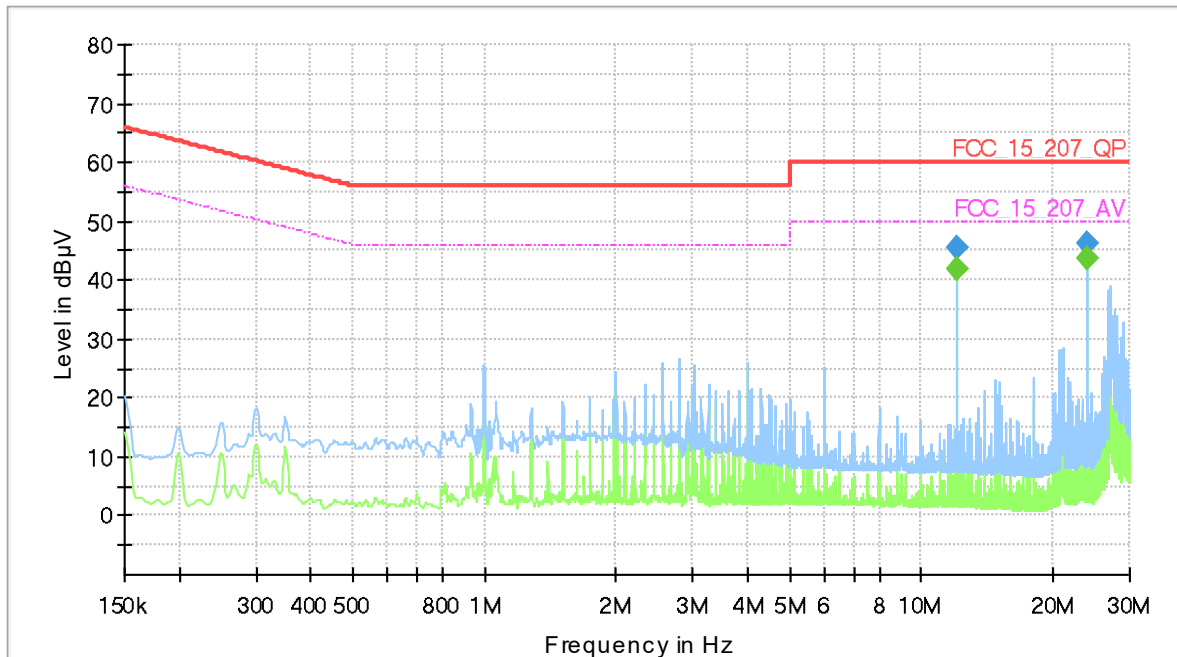

### Final Result

Frequency (MHz)	QuasiPeak (dBµV)	CAverage (dBµV)	Limit (dBµV)	Margin (dB)	Meas. Time	Bandwidth (kHz)	Line	PE	Corr. (dB)
12.005250	---	41.96	50.00	8.04	1000.0	9.000	N	GND	10.7
12.005250	45.68	---	60.00	14.32	1000.0	9.000	N	GND	10.7
24.009000	46.17	---	60.00	13.83	1000.0	9.000	N	FLO	11.2
24.009000	---	43.66	50.00	6.34	1000.0	9.000	N	FLO	11.2

WLAN a mode TX on 5580 MHz

### 5.1.5 TEST EQUIPMENT USED

- Conducted Emissions FCC

## 5.2 26 DB BANDWIDTH

Standard **FCC Part 15 Subpart E**

**The test was performed according to:**  
ANSI C63.10 12.4.1

### 5.2.1 TEST DESCRIPTION

The Equipment Under Test (EUT) was set up to perform the occupied bandwidth measurements.

The reference level is the level of the highest amplitude signal observed from the transmitter at either the fundamental frequency or first-order modulation products in all typical modes of operation, including the unmodulated carrier, even if atypical.

The results recorded were measured with the modulation which produce the worst-case (widest) emission bandwidth.

The EUT was connected to the test system as described in the block diagram below. The complete attenuation of the measurement path is known and considered.

Analyzer settings:

- Resolution Bandwidth (RBW): initially approx. 1 % of nominal emission bandwidth
- Video Bandwidth (VBW): > RBW
- Span: 40 / 80 / 160 / 320 MHz (for 20 / 40 / 80 / 160 MHz nominal bandwidth)
- Trace: Maxhold
- Sweeps: Until the trace is stable
- Sweeptime: Auto
- Detector: Peak

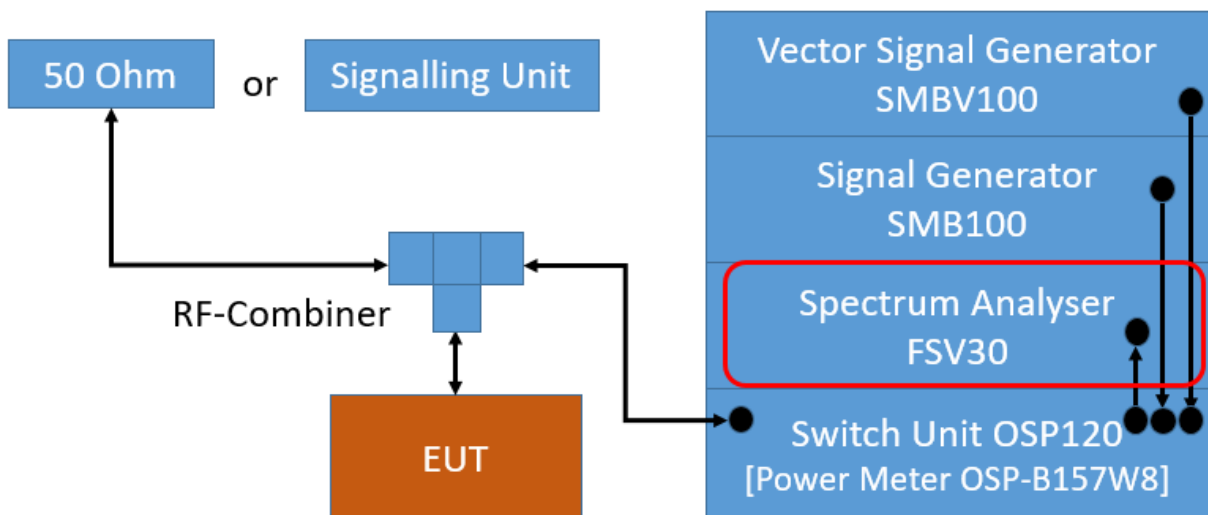

TS8997; Occupied Channel Bandwidth 6 dB / 26 dB / 99 %

## 5.2.2 TEST REQUIREMENTS / LIMITS

FCC Part 15, Subpart E

There exist no applicable limits. The test was performed to determine the limits for the "Maximum Conducted Output Power" and DFS test cases.

Therefore no result was applied.

### 5.2.3 TEST PROTOCOL

Ambient temperature: 23 - 25°C  
 Air Pressure: 990 - 1018 hPa  
 Humidity: 30 - 40%

Radio Technology	Operating Frequency	Subband	26 dB Bandwidth [MHz]
WLAN a	low	U-NII-1	19.8
WLAN a	mid	U-NII-1	19.8
WLAN a	high	U-NII-1	20.1
WLAN a	low	U-NII-2A	20.2
WLAN a	mid	U-NII-2A	20.6
WLAN a	high	U-NII-2A	20.2
WLAN a	low	U-NII-2C	20.0
WLAN a	mid	U-NII-2C	20.0
WLAN a	high	U-NII-2C	19.7
WLAN a	low	U-NII-3	20.3
WLAN a	mid	U-NII-3	20.0
WLAN a	high	U-NII-3	20.9
WLAN n 20 MHz	low	U-NII-1	20.5
WLAN n 20 MHz	mid	U-NII-1	20.5
WLAN n 20 MHz	high	U-NII-1	20.6
WLAN n 20 MHz	low	U-NII-2A	20.5
WLAN n 20 MHz	mid	U-NII-2A	20.9
WLAN n 20 MHz	high	U-NII-2A	21.2
WLAN n 20 MHz	low	U-NII-2C	21.2
WLAN n 20 MHz	mid	U-NII-2C	21.0
WLAN n 20 MHz	high	U-NII-2C	20.6
WLAN n 20 MHz	low	U-NII-3	20.4
WLAN n 20 MHz	mid	U-NII-3	20.5
WLAN n 20 MHz	high	U-NII-3	21.0
WLAN n 40 MHz	low	U-NII-1	41.1
WLAN n 40 MHz	high	U-NII-1	41.1
WLAN n 40 MHz	low	U-NII-2A	41.6
WLAN n 40 MHz	high	U-NII-2A	41.6
WLAN n 40 MHz	low	U-NII-2C	41.0
WLAN n 40 MHz	mid	U-NII-2C	41.9
WLAN n 40 MHz	high	U-NII-2C	41.3
WLAN n 40 MHz	low	U-NII-3	41.7
WLAN n 40 MHz	high	U-NII-3	41.6

Remark: Please see next sub-clause for the measurement plot.



### 5.2.4 MEASUREMENT PLOT (EXAMPLE PLOT, SHOWING WORST CASE, IF APPLICABLE)

Radio Technology = WLAN a, Operating Frequency = high, Subband = U-NII-3 (S01\_161\_AC01)

#### 26 dB Bandwidth

DUT Frequency (MHz)	Bandwidth (MHz)	Limit Min (MHz)	Limit Max (MHz)	Band Edge Left (MHz)	Band Edge Right (MHz)	Max Level (dBm)	Result
5825.000000	20.900000	---	---	5814.250000	5835.150000	7.7	PASS

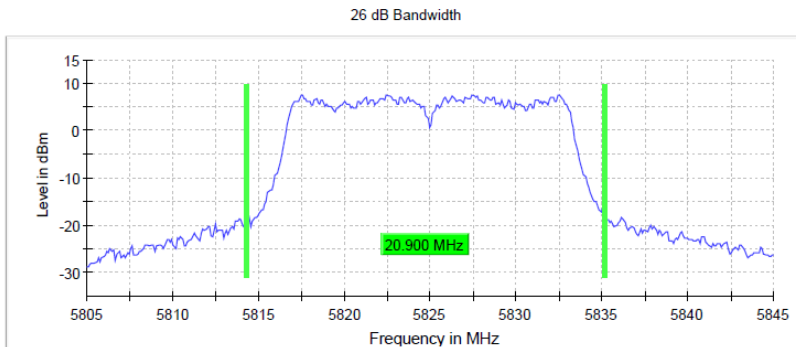

Setting	Instrument Value
Start Frequency	5.80500 GHz
Stop Frequency	5.84500 GHz
Span	40.000 MHz
RBW	200.000 kHz
VBW	1.000 MHz
SweepPoints	400
SweepTime	1.000 ms
Reference Level	0.000 dBm
Attenuation	10.000 dB
Detector	MaxPeak
SweepCount	200
Filter	3 dB
Trace Mode	Max Hold
SweepType	Sweep
Preamp	off
Stablemode	Trace
Stablevalue	0.30 dB
Run	41 / max. 150
Stable	5 / 5
Max Stable Difference	0.07 dB

Radio Technology = WLAN n 20 MHz, Operating Frequency = high, Subband = U-NII-2A (S01\_161\_AD01)

#### 26 dB Bandwidth

DUT Frequency (MHz)	Bandwidth (MHz)	Limit Min (MHz)	Limit Max (MHz)	Band Edge Left (MHz)	Band Edge Right (MHz)	Max Level (dBm)	Result
5320.000000	21.200000	---	---	5309.350000	5330.550000	4.8	PASS

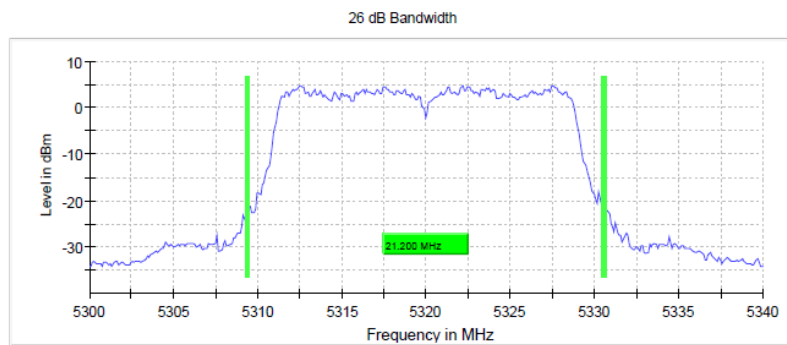

Setting	Instrument Value
Start Frequency	5.30000 GHz
Stop Frequency	5.34000 GHz
Span	40.000 MHz
RBW	200.000 kHz
VBW	1.000 MHz
SweepPoints	400
SweepTime	1.000 ms
Reference Level	0.000 dBm
Attenuation	10.000 dB
Detector	MaxPeak
SweepCount	200
Filter	3 dB
Trace Mode	Max Hold
SweepType	Sweep
Preamp	off
Stablemode	Trace
Stablevalue	0.30 dB
Run	67 / max. 150
Stable	5 / 5
Max Stable Difference	0.06 dB

Radio Technology = WLAN n 40 MHz, Operating Frequency = mid, Subband = U-NII-2C (S01\_161\_AD01)

**26 dB Bandwidth**

DUT Frequency (MHz)	Bandwidth (MHz)	Limit Min (MHz)	Limit Max (MHz)	Band Edge Left (MHz)	Band Edge Right (MHz)	Max Level (dBm)	Result
5550.000000	41.876173	---	---	5528.836773	5570.712946	4.6	PASS

Setting	Instrument Value
Start Frequency	5.51000 GHz
Stop Frequency	5.59000 GHz
Span	80.000 MHz
RBW	300.000 kHz
VBW	1.000 MHz
SweepPoints	533
Sweeptime	1.000 ms
Reference Level	0.000 dBm
Attenuation	10.000 dB
Detector	MaxPeak
SweepCount	200
Filter	3 dB
Trace Mode	Max Hold
SweepType	Sweep
Preamp	off
Stablemode	Trace
Stablevalue	0.30 dB
Run	106 / max. 150
Stable	5 / 5
Max Stable Difference	0.14 dB

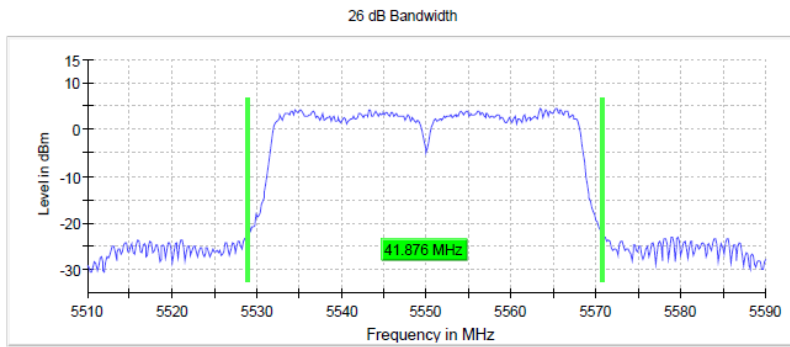

**5.2.5 TEST EQUIPMENT USED**

- R&S TS8997

### 5.3 6 DB BANDWIDTH

Standard **FCC Part 15 Subpart E**

**The test was performed according to:**  
ANSI C63.10 6.9.2

#### 5.3.1 TEST DESCRIPTION

The Equipment Under Test (EUT) was setup in a shielded room to perform the occupied bandwidth measurements.

The reference level is the level of the highest amplitude signal observed from the transmitter at either the fundamental frequency or first-order modulation products in all typical modes of operation, including the unmodulated carrier, even if atypical.

The results recorded were measured with the modulation which produce the worst-case (smallest) emission bandwidth.

The EUT was connected to the test system as described in the block diagram below. The complete attenuation of the measurement path is known and considered.

Analyzer settings:

- Resolution Bandwidth (RBW): 100 kHz
- Video Bandwidth (VBW): 300 kHz
- Span: 40 / 80 / 160 / 320 MHz (for 20 / 40 / 80 / 160 MHz nominal bandwidth))
- Trace: Maxhold
- Sweeps: Until the trace is stable
- Sweeptime: Auto
- Detector: Peak

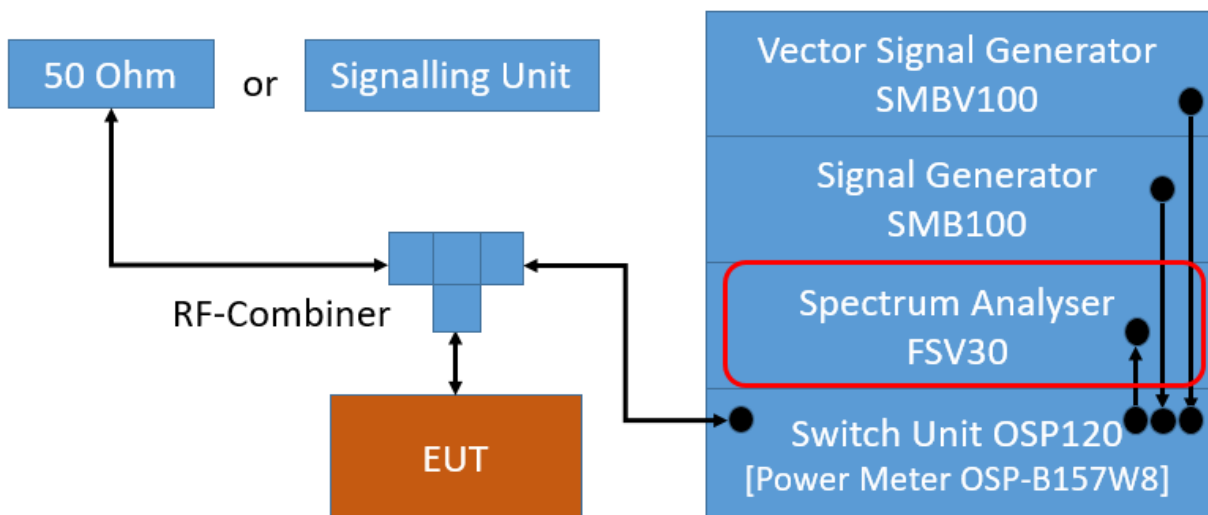

TS8997; Occupied Channel Bandwidth 6 dB / 26 dB / 99 %

### 5.3.2 TEST REQUIREMENTS / LIMITS

FCC Part 15, Subpart E, §15.407 (e)

Within the 5.725-5.850 GHz band, the minimum 6 dB bandwidth of U-NII devices shall be at least 500 kHz.

### 5.3.3 TEST PROTOCOL

Ambient temperature: 23 - 25°C  
 Air Pressure: 990 - 1018 hPa  
 Humidity: 30 - 40%

Radio Technology	Operating Frequency	6 dB Bandwidth [MHz]	Limit [MHz]	Margin [MHz]	Min. 6 dB Frequency [MHz]	Max. 6 dB Frequency [MHz]
WLAN a	low	16.45	0.5	15.95	5736.78	5753.23
WLAN a	mid	16.45	0.5	15.95	5776.78	5793.23
WLAN a	high	16.40	0.5	15.90	5816.78	5833.18
WLAN n 20 MHz	low	17.65	0.5	17.15	5736.18	5753.83
WLAN n 20 MHz	mid	17.65	0.5	17.15	5776.18	5793.83
WLAN n 20 MHz	high	17.65	0.5	17.15	5816.18	5833.83
WLAN n 40 MHz	low	36.10	0.5	35.60	5692.03	5728.13
WLAN n 40 MHz	high	35.90	0.5	35.40	5777.03	5812.93

Remark: Please see next sub-clause for the measurement plot.

### 5.3.4 MEASUREMENT PLOT (EXAMPLE PLOT, SHOWING WORST CASE, IF APPLICABLE)

Radio Technology = WLAN a, Operating Frequency = high, Subband = U-NII-3 (S01\_161\_AC01)

#### 6 dB Bandwidth

DUT Frequency (MHz)	Bandwidth (MHz)	Limit Min (MHz)	Limit Max (MHz)	Band Edge Left (MHz)	Band Edge Right (MHz)	Max Level (dBm)	Result
5825.000000	16.400000	0.500000	--	5816.775000	5833.175000	6.5	PASS

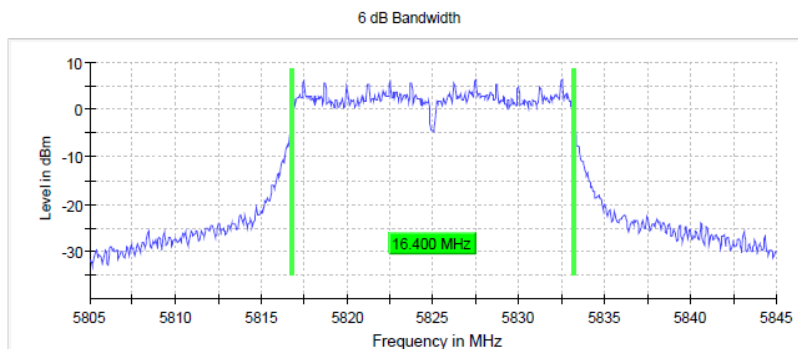

Setting	Instrument Value
Start Frequency	5.80500 GHz
Stop Frequency	5.84500 GHz
Span	40.000 MHz
RBW	100.000 kHz
VBW	300.000 kHz
SweepPoints	800
SweepTime	1.040 ms
Reference Level	0.000 dBm
Attenuation	10.000 dB
Detector	MaxPeak
SweepCount	200
Filter	3 dB
Trace Mode	Max Hold
SweepType	Sweep
Preamp	off
Stablemode	Trace
Stablevalue	0.30 dB
Run	42 / max. 150
Stable	5 / 5
Max Stable Difference	0.14 dB

Radio Technology = WLAN n 20 MHz, Operating Frequency = high, Subband = U-NII-3  
(S01\_161\_AD01)

**6 dB Bandwidth**

DUT Frequency (MHz)	Bandwidth (MHz)	Limit Min (MHz)	Limit Max (MHz)	Band Edge Left (MHz)	Band Edge Right (MHz)	Max Level (dBm)	Result
5825.000000	17.650000	0.500000	---	5816.175000	5833.825000	4.4	PASS

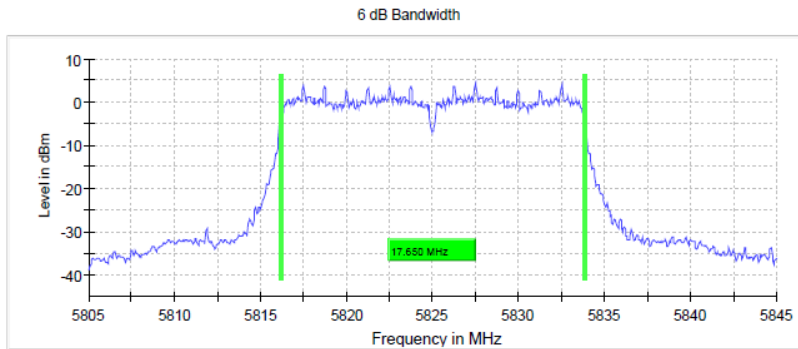

Setting	Instrument Value
Start Frequency	5.80500 GHz
Stop Frequency	5.84500 GHz
Span	40.000 MHz
RBW	100.000 kHz
VBW	300.000 kHz
SweepPoints	800
SweepTime	1.040 ms
Reference Level	0.000 dBm
Attenuation	10.000 dB
Detector	MaxPeak
SweepCount	200
Filter	3 dB
Trace Mode	Max Hold
SweepType	Sweep
Preamp	off
Stablemode	Trace
Stablevalue	0.30 dB
Run	56 / max. 150
Stable	5 / 5
Max Stable Difference	0.06 dB

Radio Technology = WLAN n 40 MHz, Operating Frequency = high, Subband = U-NII-3  
(S01\_161\_AD01)

**6 dB Bandwidth**

DUT Frequency (MHz)	Bandwidth (MHz)	Limit Min (MHz)	Limit Max (MHz)	Band Edge Left (MHz)	Band Edge Right (MHz)	Max Level (dBm)	Result
5795.000000	35.900000	0.500000	---	5777.025000	5812.925000	2.1	PASS

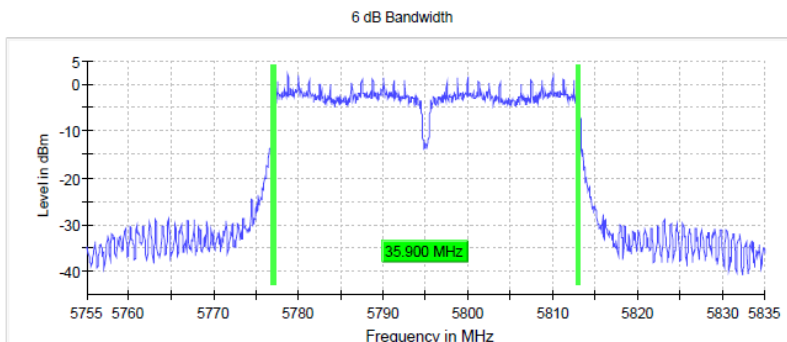

Setting	Instrument Value
Start Frequency	5.75500 GHz
Stop Frequency	5.83500 GHz
Span	80.000 MHz
RBW	100.000 kHz
VBW	300.000 kHz
SweepPoints	1600
SweepTime	1.600 ms
Reference Level	0.000 dBm
Attenuation	10.000 dB
Detector	MaxPeak
SweepCount	200
Filter	3 dB
Trace Mode	Max Hold
SweepType	Sweep
Preamp	off
Stablemode	Trace
Stablevalue	0.30 dB
Run	92 / max. 150
Stable	5 / 5
Max Stable Difference	0.11 dB

**5.3.5 TEST EQUIPMENT USED**

- R&S TS8997

## 5.4 99 % BANDWIDTH

Standard **FCC Part 15 Subpart E**

**The test was performed according to:**  
ANSI C63.10 12.4.2 (6.9.3)

### 5.4.1 TEST DESCRIPTION

The Equipment Under Test (EUT) was set up to perform the occupied bandwidth measurements.

The reference level is the level of the highest amplitude signal observed from the transmitter at either the fundamental frequency or first-order modulation products in all typical modes of operation, including the unmodulated carrier, even if atypical.

The results recorded were measured with the modulation which produce the worst-case (widest) emission bandwidth.

The EUT was connected to the test system as described in the block diagram below. The complete attenuation of the measurement path is known and considered.

Analyzer settings:

- Resolution Bandwidth (RBW): approx.  $\geq 1\%$  of the span, but not below
- Video Bandwidth (VBW):  $\geq 3$  times the RBW
- Span: 40 / 80 / 160 / 320 MHz (for 20 / 40 / 80 / 160 MHz nominal bandwidth)
- Trace: Maxhold
- Sweeps: Until the trace is stable
- Sweeptime: Auto
- Detector: Peak

The 99 % measurement function of the spectrum analyser function was used to determine the 99 % bandwidth.

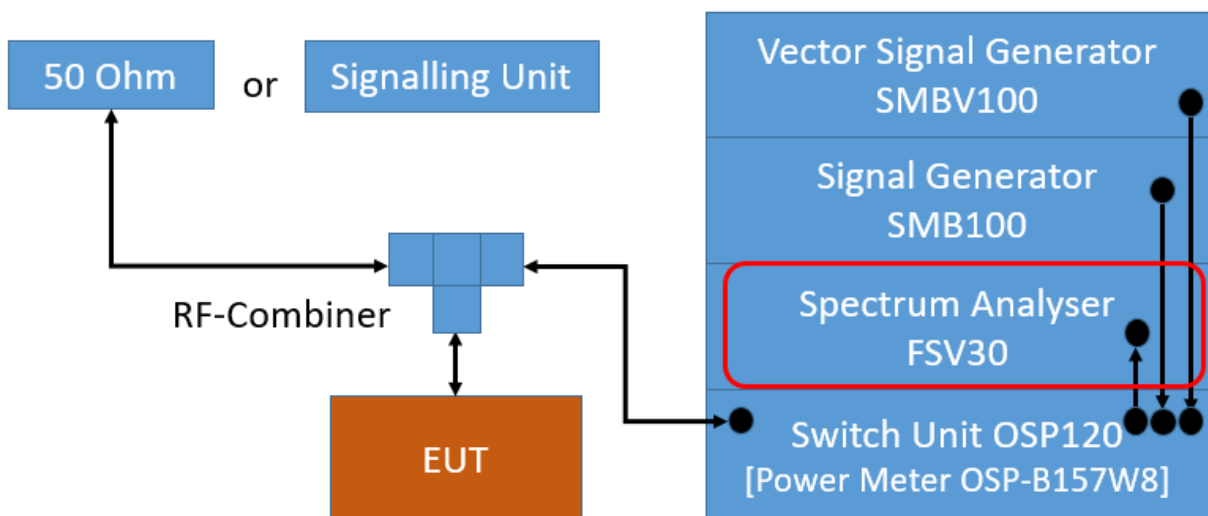

TS8997; Occupied Channel Bandwidth 6 dB / 26 dB / 99 %

## 5.4.2 TEST REQUIREMENTS / LIMITS

No applicable limit.

The test was performed to determine the limits for the "Maximum Conducted Output Power" and DFS test cases.

## 5.4.3 TEST PROTOCOL

Ambient temperature: 23 - 25°C  
 Air Pressure: 990 - 1018 hPa  
 Humidity: 30 - 40%

Radio Technology	Operating Frequency	Subband	99% Bandwidth [MHz]
WLAN a	low	U-NII-1	16.7
WLAN a	mid	U-NII-1	16.7
WLAN a	high	U-NII-1	16.7
WLAN a	low	U-NII-2A	16.7
WLAN a	mid	U-NII-2A	16.7
WLAN a	high	U-NII-2A	16.7
WLAN a	low	U-NII-2C	16.7
WLAN a	mid	U-NII-2C	16.7
WLAN a	high	U-NII-2C	16.7
WLAN a	low	U-NII-3	16.7
WLAN a	mid	U-NII-3	16.7
WLAN a	high	U-NII-3	16.7
WLAN n 20 MHz	low	U-NII-1	17.7
WLAN n 20 MHz	mid	U-NII-1	17.7
WLAN n 20 MHz	high	U-NII-1	17.7
WLAN n 20 MHz	low	U-NII-2A	17.7
WLAN n 20 MHz	mid	U-NII-2A	17.7
WLAN n 20 MHz	high	U-NII-2A	17.7
WLAN n 20 MHz	low	U-NII-2C	17.7
WLAN n 20 MHz	mid	U-NII-2C	17.7
WLAN n 20 MHz	high	U-NII-2C	17.7
WLAN n 20 MHz	low	U-NII-3	17.7
WLAN n 20 MHz	mid	U-NII-3	17.7
WLAN n 20 MHz	high	U-NII-3	17.7
WLAN n 40 MHz	low	U-NII-1	36.3
WLAN n 40 MHz	high	U-NII-1	36.8
WLAN n 40 MHz	low	U-NII-2A	36.8
WLAN n 40 MHz	high	U-NII-2A	36.5
WLAN n 40 MHz	low	U-NII-2C	36.5
WLAN n 40 MHz	mid	U-NII-2C	36.8
WLAN n 40 MHz	high	U-NII-2C	36.3
WLAN n 40 MHz	low	U-NII-3	36.8
WLAN n 40 MHz	high	U-NII-3	36.8

Remark: Please see next sub-clause for the measurement plot.

### 5.4.4 MEASUREMENT PLOT (EXAMPLE PLOT, SHOWING WORST CASE, IF APPLICABLE)

Radio Technology = WLAN a, Operating Frequency = high, Subband = U-NII-3 (S01\_161\_AC01)

#### 99 % Bandwidth

DUT Frequency (MHz)	Bandwidth (MHz)	Limit Min (MHz)	Limit Max (MHz)	Band Edge Left (MHz)	Band Edge Right (MHz)	Result
5825.000000	16.700000	--	--	5816.650000	5833.350000	PASS

Setting	Instrument Value
Start Frequency	5.80500 GHz
Stop Frequency	5.84500 GHz
Span	40.000 MHz
RBW	200.000 kHz
VBW	1.000 MHz
SweepPoints	400
SweepTime	1.000 ms
Reference Level	0.000 dBm
Attenuation	10.000 dB
Detector	MaxPeak
SweepCount	200
Filter	3 dB
Trace Mode	Max Hold
SweepType	Sweep
Preamp	off
Stablemode	Trace
Stablevalue	0.30 dB
Run	52 / max. 150
Stable	5 / 5
Max Stable Difference	0.20 dB

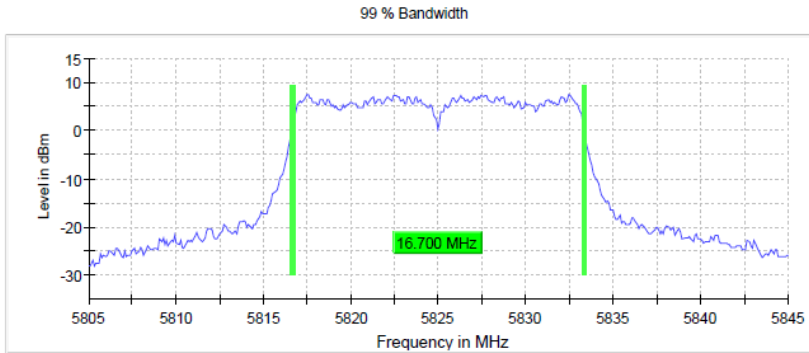

Radio Technology = WLAN n 20 MHz, Operating Frequency = high, Subband = U-NII-3 (S01\_161\_AD01)

#### 99 % Bandwidth

DUT Frequency (MHz)	Bandwidth (MHz)	Limit Min (MHz)	Limit Max (MHz)	Band Edge Left (MHz)	Band Edge Right (MHz)	Result
5825.000000	17.700000	--	--	5816.150000	5833.850000	PASS

Setting	Instrument Value
Start Frequency	5.80500 GHz
Stop Frequency	5.84500 GHz
Span	40.000 MHz
RBW	200.000 kHz
VBW	1.000 MHz
SweepPoints	400
SweepTime	1.000 ms
Reference Level	0.000 dBm
Attenuation	10.000 dB
Detector	MaxPeak
SweepCount	200
Filter	3 dB
Trace Mode	Max Hold
SweepType	Sweep
Preamp	off
Stablemode	Trace
Stablevalue	0.30 dB
Run	48 / max. 150
Stable	5 / 5
Max Stable Difference	0.19 dB

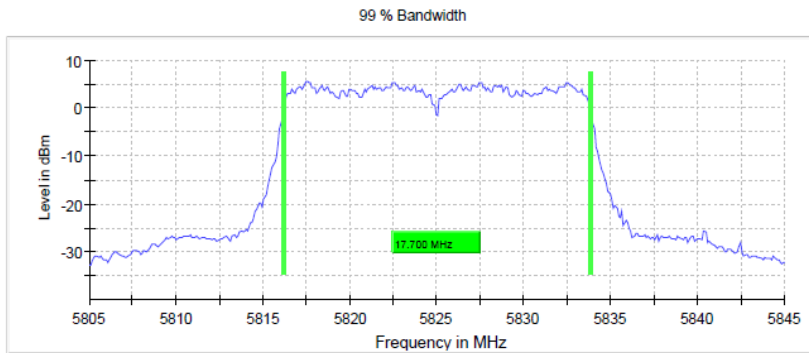



Radio Technology = WLAN n 40 MHz, Operating Frequency = high, Subband = U-NII-3 (S01\_161\_AD01)

**99 % Bandwidth**

DUT Frequency (MHz)	Bandwidth (MHz)	Limit Min (MHz)	Limit Max (MHz)	Band Edge Left (MHz)	Band Edge Right (MHz)	Result
5795.000000	36.750000	---	---	5776.625000	5813.375000	PASS

Setting	Instrument Value
Start Frequency	5.75500 GHz
Stop Frequency	5.83500 GHz
Span	80.000 MHz
RBW	500.000 kHz
VBW	2.000 MHz
SweepPoints	320
SweepTime	1.000 ms
Reference Level	0.000 dBm
Attenuation	10.000 dB
Detector	MaxPeak
SweepCount	200
Filter	3 dB
Trace Mode	Max Hold
SweepType	Sweep
Preamp	off
Stablemode	Trace
Stablevalue	0.30 dB
Run	52 / max. 150
Stable	5 / 5
Max Stable Difference	0.23 dB

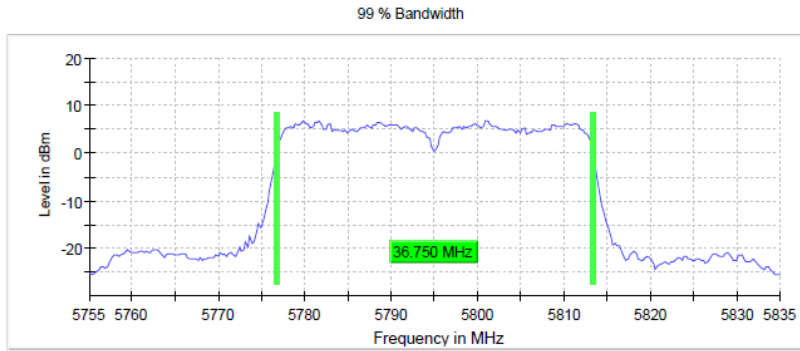

**5.4.5 TEST EQUIPMENT USED**

- R&S TS8997

## 5.5 MAXIMUM CONDUCTED OUTPUT POWER

Standard **FCC Part 15 Subpart E**

**The test was performed according to:**  
ANSI C63.10 12.3.3.2

### 5.5.1 TEST DESCRIPTION

The Equipment Under Test (EUT) was set up to perform the output power measurements. The results recorded were measured with the modulation which produces the worst-case (highest) output power

For U-NII bands 1, 2A, 2C, 3:

The EUT was connected to the test system as described in the block diagram below. The complete attenuation of the measurement path is known and considered.

The OSP-B157W is a gated RF average power meter with a signal bandwidth > 300 MHz.

Note:

The measurement was performed according FCC Public Note "Guidelines for Compliance Testing of Unlicensed National Information Infrastructure (U-NII) Devices - Part 15, Subpart E, 789033 D02", method **PM-G**.

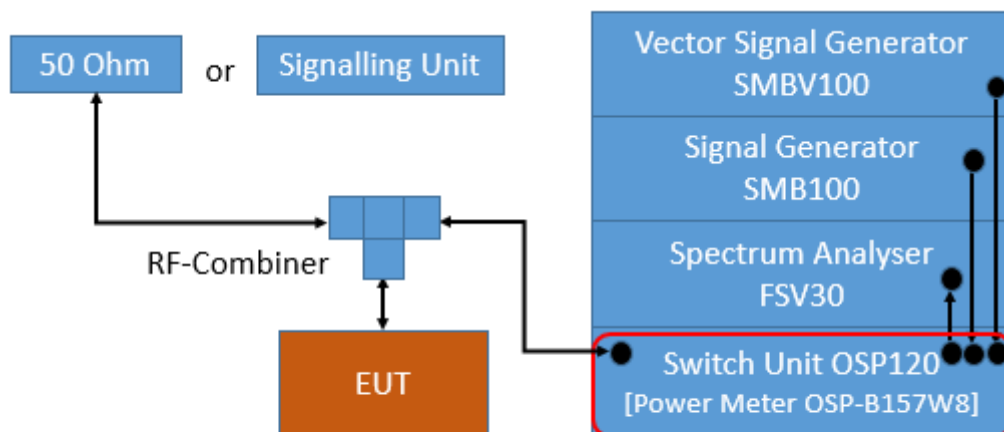

TS8997; Maximum Conducted Output Power

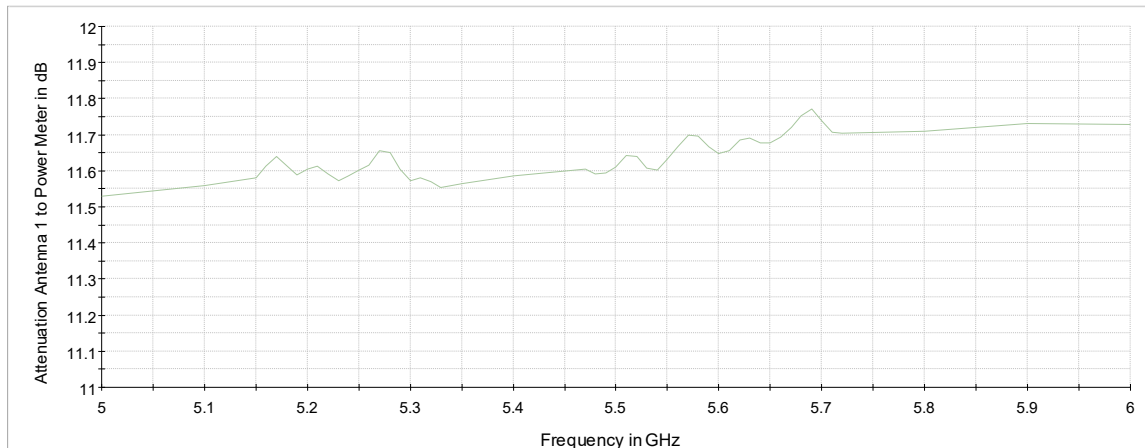

Attenuation of measurement path

For U-NII bands 5,6,7,8:

The EUT was connected to the test system as described in the block diagram below. The complete attenuation of the measurement path is known and considered.

Analyzer settings:

- Resolution Bandwidth (RBW): 1 MHz
- Video Bandwidth (VBW): 3 MHz
- Trace: Average, RMS power averaging mode
- Sweeps: at least 100
- Sweep time: Auto
- Detector: RMS
- Trigger: free run (DC > 98 %) or gated mode (DC < 98 %)

See worst case result plots for details

Note:

The measurement was performed according FCC Public Note "Guidelines for Compliance Testing of Unlicensed National Information Infrastructure (U-NII) Devices - Part 15, Subpart E, 789033 D02", method **SA-1**.

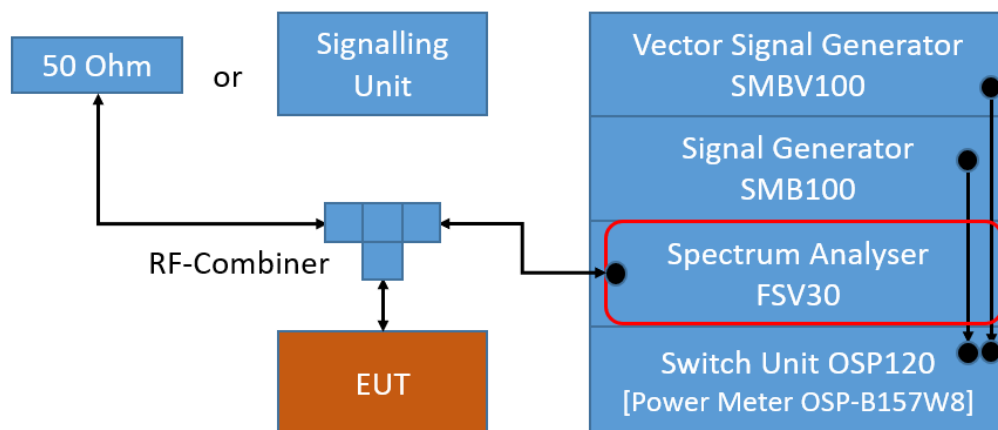

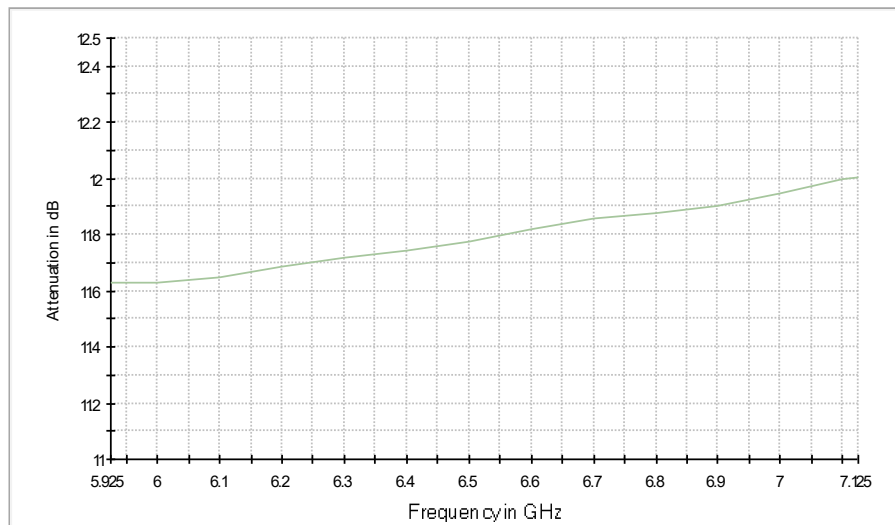

Attenuation of measurement path

## 5.5.2 TEST REQUIREMENTS / LIMITS

### A) FCC

FCC Part 15, Subpart E, §15.407 (a) (1) (i): Outdoor access point:

For systems using digital modulation techniques in the 5.15 – 5.25 GHz bands:

Limit: 1 W (30 dBm) provided the maximum antenna gain does not exceed 6 dBi.

The maximum e.i.r.p. at any elevation angle above 30 degrees as measured from the horizon must not exceed 125 mW (21 dBm).

§15.407 (a) (1) (ii): Indoor access point:

Limit: 1 W (30 dBm) provided the maximum antenna gain does not exceed 6 dBi.

§15.407 (a) (1) (iii): Fixed point-to-point access points:

Limit: 1 W (30 dBm) provided the maximum antenna gain does not exceed 23 dBi.

§15.407 (a) (1) (iv): Client devices:

Limit: 250 mW (24 dBm) provided the maximum antenna gain does not exceed 6 dBi.

FCC Part 15, Subpart E, §15.407 (a) (2)

For systems using digital modulation techniques in the 5.25 – 5.35 GHz and 5.47 – 5.725 GHz bands:

Limit: 250 mW (24 dBm) or  $11 \text{ dBm} + 10 \log (26 \text{ dB bandwidth/MHz})$  whatever is the lesser.

FCC Part 15, Subpart E, §15.407 (a) (3):

For systems using digital modulation techniques in the 5.725 – 5.850 GHz bands:

Limit: 1 W (30 dBm) provided the maximum antenna gain does not exceed 6 dBi. The antenna gain limitation is not applicable for fixed point-to-point devices.

FCC Part 15, Subpart E, §15.407 (a) (4):

For a standard power access point and fixed client devices in the 5.925 – 6.425 GHz and 6.525 – 6.875 GHz bands:

Limit: 4 W (36 dBm) e.i.r.p.

For outdoor devices, the maximum e.i.r.p. at any elevation angle above 30 degrees as measured from the horizon must not exceed 125 mW (21 dBm).

FCC Part 15, Subpart E, §15.407 (a) (5):

For an indoor access point in the 5.925 – 7.125 GHz bands:

Limit: 1 W (30 dBm)e.i.r.p.

FCC Part 15, Subpart E, §15.407 (a) (6):

For a subordinate device operating under an indoor access point in the 5.925 – 7.125 GHz bands:

Limit: 1 W (30 dBm)e.i.r.p.

FCC Part 15, Subpart E, §15.407 (a) (7):

For a client device, except for fixed client devices, operating under standard power access point in the 5.925-6.425 GHz and 6.525-6.875 GHz bands:

Limit: 1 W (30 dBm)e.i.r.p.

The client device must limit it's power to no more than 6 dB below its associated standard power access point's authorized transmit power.

FCC Part 15, Subpart E, §15.407 (a) (8):

For client devices operating under the control of an indoor access point in the 5.925 – 7.125 GHz bands:

Limit: 250 mW (24 dBm)e.i.r.p.

FCC Part 15, Subpart E, §15.407 (a) (11):

The maximum conducted output power must be measured over any interval of continuous transmission using instrumentation calibrated in terms of an rms-equivalent voltage.

## **B) IC**

Different frequency bands and limits apply, as compared to the FCC requirements.

All frequency bands: B is the 99% emission bandwidth in MHz.

### **RSS-247, 6.2.1.1, Band 5150-5250 MHz, indoor operation only, except for OEM devices installed by vehicle manufacturers:**

Limits:

For OEM devices installed in vehicles, the maximum e.i.r.p. shall not exceed 30 mW or  $1.76 + 10 \log_{10}B$ , dBm, whichever is less. Devices shall implement transmitter power control (TPC) in order to have the capability to operate at least 3 dB below the maximum permitted e.i.r.p. of 30 mW. (e.i.r.p.)

Other devices: 200 mW (23 dBm) or  $10 + 10 \log_{10}B$  [dBm], whichever power is less.

### **RSS-247, 6.2.2.1, Band 5250-5350 MHz:**

Limits:

For OEM devices installed in vehicles, the maximum e.i.r.p. shall not exceed 30 mW or  $1.76 + 10 \log_{10}B$ , dBm, whichever is less. Devices shall implement TPC in order to have the capability to operate at least 3 dB below the maximum permitted e.i.r.p. of 30 mW.

Devices, other devices than installed in vehicles:

Maximum conducted Power: 250 mW (24 dBm) or  $11 + 10 \log_{10} B$  [dBm], whichever power is less.

e.i.r.p.: 1.0 W (30 dBm) or  $17 + 10 \log_{10} B$  [dBm], whichever power is less.

Outdoor fixed devices with a maximum e.i.r.p. greater than 200 mW shall comply with the following e.i.r.p. at different elevations, where  $\theta$  is the angle above the local horizontal plane (of the Earth) as shown below:

- i. -13 dBW/MHz for  $0^\circ \leq \theta < 8^\circ$
- ii.  $-13 - 0.716 (\theta - 8)$  dBW/MHz for  $8^\circ \leq \theta < 40^\circ$
- iii.  $-35.9 - 1.22 (\theta - 40)$  dBW/MHz for  $40^\circ \leq \theta \leq 45^\circ$
- iv. -42 dBW/MHz for  $\theta > 45^\circ$

**RSS-247, 6.2.3.1, Bands 5470-5600 MHz and 5650-5725 MHz:**

Limits:

Maximum conducted Power: 250 mW (24 dBm) or  $11 + 10 \log_{10} B$  [dBm], whichever power is less.

e.i.r.p.: 1.0 W (30 dBm) or  $17 + 10 \log_{10} B$  [dBm], whichever power is less.

Note: Devices with a maximum e.i.r.p. greater than 500 mW shall implement TPC in order to have the capability to operate at least 6 dB below the maximum permitted e.i.r.p. of 1 W.

**RSS-247, 6.2.4.1, Band 5725-5850 MHz:**

Limits:

Maximum conducted Power: 1 W (30 dBm)

e.i.r.p.: 4 W (36 dBm)

### 5.5.3 TEST PROTOCOL

Ambient temperature: 23 - 25°C  
 Air Pressure: 990 - 1018 hPa  
 Humidity: 30 - 40%  
 WLAN a-Mode; 20 MHz; 6 Mbit/s

U-NII-Subband	Ch. No.	Freq. [MHz]	Cond. Power [dBm]	EIRP [dBm]	FCC Cond. Limit [dBm]	Margin [dB]	IC Cond. Limit [dBm]	Margin [dB]	IC EIRP Limit [dBm]	Margin [dB]	
1	36	5180	17.1	19.1	30.0	12.9	N/A	-	22.2	3.1	1)
	40	5200	17.0	19.0	30.0	13.0	N/A	-	22.2	3.2	1)
	48	5240	17.2	19.2	30.0	12.8	N/A	-	22.2	3.0	1)
2A	52	5260	17.1	19.1	24.0	6.9	23.2	6.1	29.2	10.1	1)
	60	5300	17.2	19.2	24.0	6.8	23.2	6.0	29.2	10.0	1)
	64	5320	16.4	18.4	24.0	7.6	23.2	6.8	29.2	10.8	1)
2C	100	5500	15.8	17.8	24.0	8.2	23.2	7.4	29.2	11.4	
	116	5580	17.9	19.9	24.0	6.1	23.2	5.3	29.2	9.3	
	140	5700	13.9	15.9	23.9	10.1	23.2	9.4	29.2	13.4	
3	149	5745	16.2	18.2	30.0	13.8	30.0	13.8	36.0	17.8	
	157	5785	17.0	19.0	30.0	13.0	30.0	13.0	36.0	17.0	
	165	5825	17.8	19.8	30.0	12.2	30.0	12.2	36.0	16.2	

WLAN n-Mode; 20 MHz; MCS0; SISO

U-NII-Subband	Ch. No.	Freq. [MHz]	Cond. Power [dBm]	EIRP [dBm]	FCC Cond. Limit [dBm]	Margin [dB]	IC Cond. Limit [dBm]	Margin [dB]	IC EIRP Limit [dBm]	Margin [dB]	
1	36	5180	16.1	18.1	30.0	13.9	N/A	-	22.5	4.4	1)
	40	5200	16.1	18.1	30.0	13.9	N/A	-	22.5	4.4	1)
	48	5240	16.2	18.2	30.0	13.8	N/A	-	22.5	4.3	1)
2A	52	5260	16.2	18.2	24.0	7.8	23.5	7.3	29.5	11.3	1)
	60	5300	16.4	18.4	24.0	7.6	23.5	7.1	29.5	11.1	1)
	64	5320	15.4	17.4	24.0	8.6	23.5	8.1	29.5	12.1	1)
2C	100	5500	15.0	17.0	24.0	9.0	23.5	8.5	29.5	12.5	
	116	5580	16.1	18.1	24.0	7.9	23.5	7.4	29.5	11.4	
	140	5700	14.3	16.3	24.0	9.7	23.5	9.2	29.5	13.2	
3	149	5745	16.3	18.3	30.0	13.7	30.0	13.7	36.0	17.7	
	157	5785	16.2	18.2	30.0	13.8	30.0	13.8	36.0	17.8	
	165	5825	16.1	18.1	30.0	13.9	30.0	13.9	36.0	17.9	

WLAN n-Mode; 40 MHz; MCS0; SISO

U-NII-Subband	Ch. No.	Freq. [MHz]	Cond. Power [dBm]	EIRP [dBm]	FCC Cond. Limit [dBm]	Margin [dB]	IC Cond. Limit [dBm]	Margin [dB]	IC EIRP Limit [dBm]	Margin [dB]	
1	38	5190	14.1	16.1	30.0	15.9	N/A	-	23.0	6.9	1)
	46	5230	16.2	18.2	30.0	13.8	N/A	-	23.0	4.8	1)
2A	54	5270	16.1	18.1	24.0	7.9	24.0	7.9	30.0	11.9	1)
	62	5310	14.3	16.3	24.0	9.7	24.0	9.7	30.0	13.7	1)
2C	102	5510	12.7	14.7	24.0	11.3	24.0	11.3	30.0	15.3	
	110	5550	15.8	17.8	24.0	8.2	24.0	8.2	30.0	12.2	
	134	5670	13.0	15.0	24.0	11.0	24.0	11.0	30.0	15.0	
3	151	5755	16.1	18.1	30.0	13.9	30.0	13.9	36.0	17.9	
	159	5795	16.0	18.0	30.0	14.0	30.0	14.0	36.0	18.0	

1) No further limit applies in regards to the elevation.

Remark: None.

#### 5.5.4 MEASUREMENT PLOTS

Power Meter Measurement, no plots provided.

#### 5.5.5 TEST EQUIPMENT USED

- R&S TS8997



## 5.6 PEAK POWER SPECTRAL DENSITY

Standard **FCC Part 15 Subpart E**

**The test was performed according to:**  
ANSI C63.10 12.5 (SA-3)

### 5.6.1 TEST DESCRIPTION

The Equipment Under Test (EUT) was set up in a shielded room to perform the Maximum Power Spectral Density measurements. The results recorded were measured with the modulation which produces the worst-case (highest) output power.

For U-NII bands 1, 2A, 2C, 3:

The EUT was connected to the test system as described in the block diagram below. The complete attenuation of the measurement path is known and considered.

Analyzer settings:

- Resolution Bandwidth (RBW): 1 MHz (for subband 3: 500 kHz)
- Video Bandwidth (VBW): 3 MHz (for subband 3: 2 MHz)
- Trace: Max Hold
- Sweeps: till stable (at least 180, max. 900)
- Sweep time:  $\leq$  Number of sweep points x Min. Transmitter on time
- Detector: RMS
- Trigger: free run

Note:

The analyser settings are according FCC Public Note "Guidelines for Compliance Testing of Unlicensed National Information Infrastructure (U-NII) Devices - Part 15, Subpart E, 789033 D02", method **SA-3**.

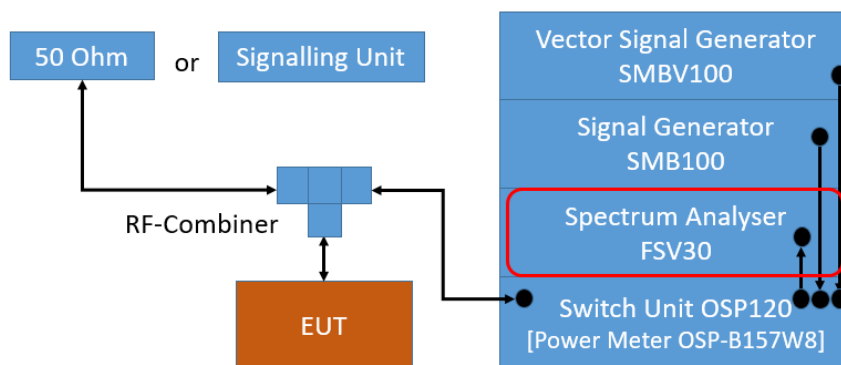

TS8997; Maximum Power Spectral Density

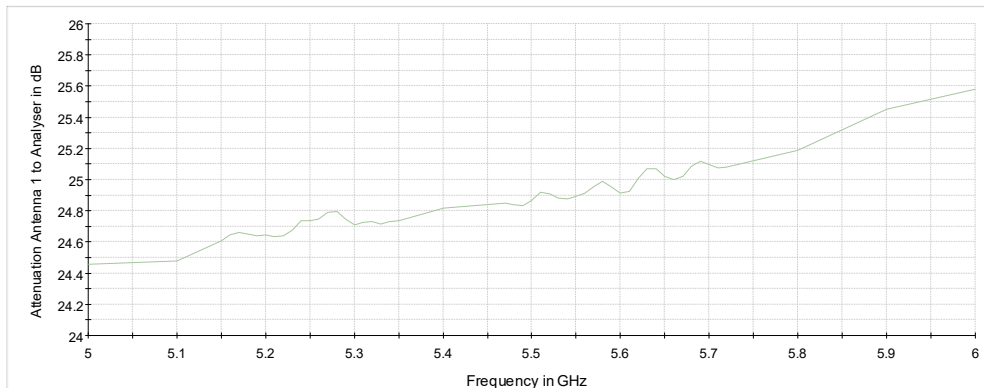

### Attenuation of the measurement path

For U-NII bands 5, 6, 7, 8:

The EUT was connected to the test system as described in the block diagram below. The complete attenuation of the measurement path is known and considered.

Analyzer settings:

- Resolution Bandwidth (RBW): 1 MHz
- Video Bandwidth (VBW): 3 MHz
- Trace: Average, RMS power averaging mode
- Sweeps: at least 100
- Sweptime: Auto
- Detector: RMS
- Trigger: free run (DC >98 %) or gated mode (DC < 98 %)

Note:

The analyser settings are according FCC Public Note "Guidelines for Compliance Testing of Unlicensed National Information Infrastructure (U-NII) Devices - Part 15, Subpart E, 789033 D02", method **SA-1**.

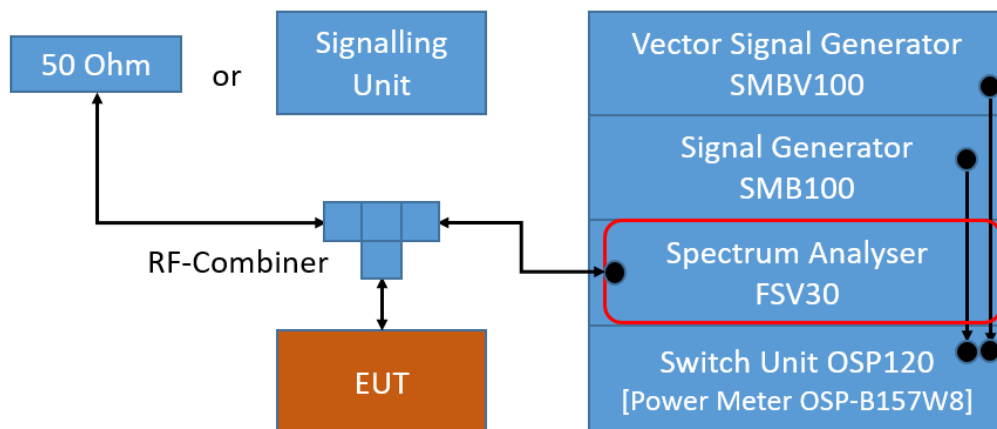

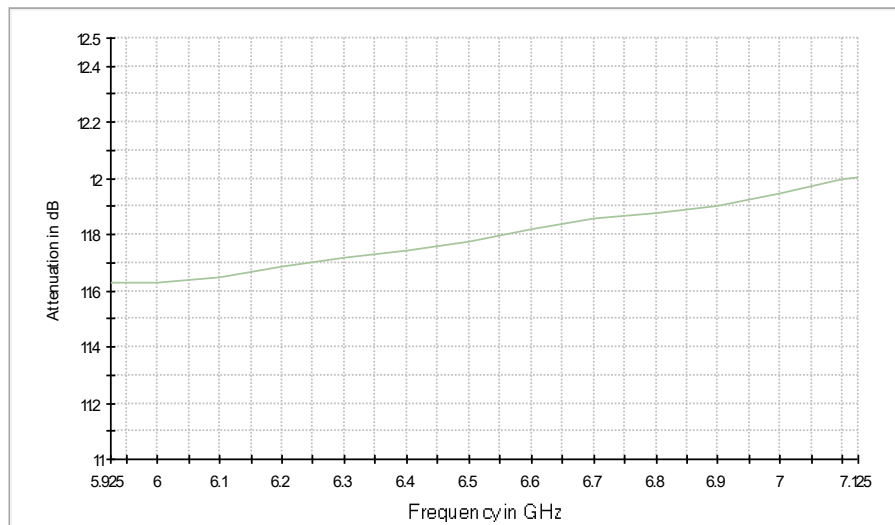

Attenuation of measurement path

## 5.6.2 TEST REQUIREMENTS / LIMITS

### A) FCC

FCC Part 15, Subpart E, §15.407 (a) (1)

For systems using digital modulation techniques in the 5.15 – 5.25 GHz bands:

(i) and (ii), outdoor and indoor access points: Limit: 17 dBm/MHz.

(iv), mobile and portable client devices: Limit: 11 dBm/MHz.

FCC Part 15, Subpart E, §15.407 (a) (2)

For systems using digital modulation techniques in the 5.25 – 5.35 GHz and 5.47 – 5.725 GHz bands:

Limit: 11 dBm/MHz.

FCC Part 15, Subpart E, §15.407 (a) (3)

For systems using digital modulation techniques in the 5.725 – 5.850 GHz bands:

Limit: 30 dBm/500 kHz.

FCC Part 15, Subpart E, §15.407 (a) (4):

For a standard power access point and fixed client devices in the 5.925 – 6.425 GHz and 6.525 – 6.875 GHz bands:

Limit: 23 dBm/MHz e.i.r.p.

FCC Part 15, Subpart E, §15.407 (a) (5):

For an indoor access point in the 5.925 – 7.125 GHz bands:

Limit: 5 dBm/MHz e.i.r.p.

FCC Part 15, Subpart E, §15.407 (a) (6):

For a subordinate device operating under an indoor access point in the 5.925 – 7.125 GHz bands:

Limit: 5 dBm/MHz e.i.r.p.

FCC Part 15, Subpart E, §15.407 (a) (7):

For a client device, except for fixed client devices, operating under standard power access point in the 5.925-6.425 GHz and 6.525-6.875 GHz bands:  
Limit: 17 dBm/MHz e.i.r.p.

FCC Part 15, Subpart E, §15.407 (a) (8):

For client devices operating under the control of an indoor access point in the 5.925 – 7.125 GHz bands:  
Limit: -1 dBm/MHz e.i.r.p.

**B) IC**

Different frequency bands and limits apply, as compared to the FCC requirements.

RSS-247, 6.2.1 (1), Band 5150-5250 MHz, indoor operation only:  
Limit (e.i.r.p.): 10 dBm/MHz.

RSS-247, 6.2.2 (1), Band 5250-5350 MHz:  
Limit: 11 dBm/MHz.

RSS-247, 6.2.3 (1), Bands 5470-5600 MHz and 5650-5725 MHz:  
Limit: 11 dBm/MHz.

RSS-247, 6.2.4 (1), Band 5725-5850 MHz:  
Limit: 30 dBm/500 kHz.

### 5.6.3 TEST PROTOCOL

Ambient temperature: 23 - 25°C  
 Air Pressure: 990 - 1018 hPa  
 Humidity: 30 - 40%  
 WLAN a-Mode; 20 MHz; 6 Mbit/s

U-NII-Subband	Ch. No.	Freq. [MHz]	MPSD [dBm/MHz]	FCC Limit [dBm/MHz]	Margin [dB]	IC Limit [dBm/MHz]	Margin [dB]	IC EIRP MPSD
1	36	5180	5.6	17.0	11.4	10.0	2.4	7.6
	40	5200	5.2	17.0	11.8	10.0	2.8	7.2
	48	5240	5.4	17.0	11.6	10.0	2.6	7.4
2A	52	5260	5.3	11.0	5.7	11.0	5.7	unit:
	60	5300	5.4	11.0	5.6	11.0	5.6	dBm/
	64	5320	4.8	11.0	6.2	11.0	6.2	MHz
2C	100	5500	4.3	11.0	6.7	11.0	6.7	
	116	5580	6.6	11.0	4.4	11.0	4.4	
	140	5700	2.3	11.0	8.7	11.0	8.7	
3	149	5745	1.4	30.0	28.6	30.0	28.6	
	157	5785	2.2	30.0	27.8	30.0	27.8	
	165	5825	3.2	30.0	26.8	30.0	26.8	

WLAN n-Mode; 20 MHz; MCS0; SISO

U-NII-Subband	Ch. No.	Freq. [MHz]	MPSD [dBm/MHz]	FCC Limit [dBm/MHz]	Margin [dB]	IC Limit [dBm/MHz]	Margin [dB]	IC EIRP MPSD
1	36	5180	4.1	17.0	12.9	10.0	3.9	6.1
	40	5200	4.0	17.0	13.0	10.0	4.0	6.0
	48	5240	4.2	17.0	12.8	10.0	3.8	6.2
2A	52	5260	4.1	11.0	6.9	11.0	6.9	unit:
	60	5300	4.2	11.0	6.8	11.0	6.8	dBm/
	64	5320	3.1	11.0	7.9	11.0	7.9	MHz
2C	100	5500	2.9	11.0	8.1	11.0	8.1	
	116	5580	4.3	11.0	6.7	11.0	6.7	
	140	5700	2.0	11.0	9.0	11.0	9.0	
3	149	5745	1.4	30.0	28.6	30.0	28.6	
	157	5785	1.4	30.0	28.6	30.0	28.6	
	165	5825	1.0	30.0	29.0	30.0	29.0	

WLAN n-Mode; 40 MHz; MCS0; SISO

U-NII-Subband	Ch. No.	Freq. [MHz]	MPSD [dBm/MHz]	FCC Limit [dBm/MHz]	Margin [dB]	IC Limit [dBm/MHz]	Margin [dB]	IC EIRP MPSD
1	38	5190	-0.9	17.0	17.9	10.0	8.9	1.2
	46	5230	1.3	17.0	15.7	10.0	6.7	3.3
2A	54	5270	1.2	11.0	9.8	11.0	9.8	unit:
	62	5310	-0.7	11.0	11.7	11.0	11.7	dBm/
2C	102	5510	-2.1	11.0	13.1	11.0	13.1	MHz
	110	5550	1.0	11.0	10.0	11.0	10.0	
	134	5670	-2.0	11.0	13.0	11.0	13.0	
3	151	5755	-1.6	30.0	31.6	30.0	31.6	
	159	5795	-1.6	30.0	31.6	30.0	31.6	

Remark: Please see next sub-clause for the measurement plot.

### 5.6.4 MEASUREMENT PLOT (EXAMPLE PLOT, SHOWING WORST CASE, IF APPLICABLE)

Radio Technology = WLAN a, Operating Frequency = mid, Subband = U-NII-2C (S01\_161\_AC01)

#### Result

DUT Frequency (MHz)	Frequency (MHz)	PSD (dBm)	Limit Max (dBm)	Result
5580.000000	5582.574257	6.591	11.0	PASS

#### Ports

Port	State
1	used

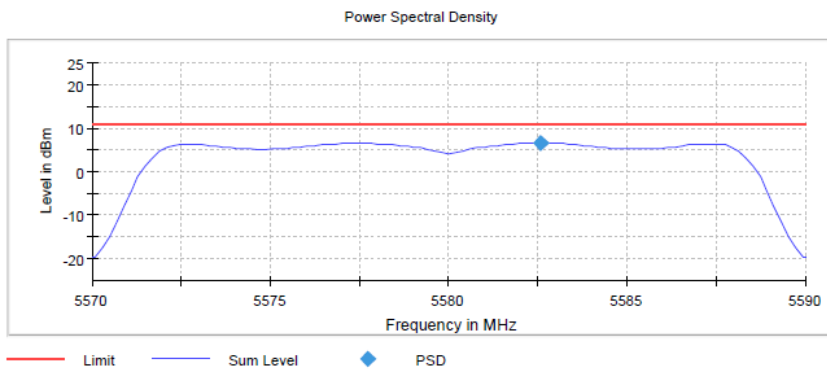

Setting	Instrument Value
Start Frequency	5.57000 GHz
Stop Frequency	5.59000 GHz
Span	20.000 MHz
RBW	1.000 MHz
VBW	3.000 MHz
SweepPoints	101
SweepTime	1.010 s
Reference Level	0.000 dBm
Attenuation	10.000 dB
Detector	RMS
SweepCount	60
Filter	3 dB
Trace Mode	Max Hold
SweepType	Sweep
Preamp	off
Stablemode	Trace
Stablevalue	0.30 dB
Run	4 / max. 15
Stable	3 / 3
Max Stable Difference	0.01 dB

Radio Technology = WLAN n 20 MHz, Operating Frequency = mid, Subband = U-NII-2C (S01\_161\_AD01)

#### Result

DUT Frequency (MHz)	Frequency (MHz)	PSD (dBm)	Limit Max (dBm)	Result
5580.000000	5582.574257	6.535	11.0	PASS

#### Ports

Port	State
1	used

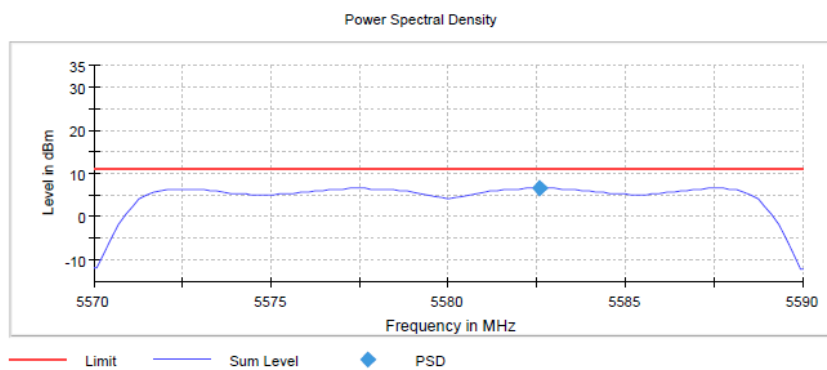

Setting	Instrument Value
Start Frequency	5.57000 GHz
Stop Frequency	5.59000 GHz
Span	20.000 MHz
RBW	1.000 MHz
VBW	3.000 MHz
SweepPoints	101
SweepTime	1.010 s
Reference Level	0.000 dBm
Attenuation	10.000 dB
Detector	RMS
SweepCount	60
Filter	3 dB
Trace Mode	Max Hold
SweepType	Sweep
Preamp	off
Stablemode	Trace
Stablevalue	0.30 dB
Run	4 / max. 15
Stable	3 / 3
Max Stable Difference	0.00 dB

Radio Technology = WLAN n 40 MHz, Operating Frequency = high, Subband = U-NII-1 (S01\_161\_AD01)

**Result**

DUT Frequency (MHz)	Frequency (MHz)	PSD (dBm)	Limit Max (dBm)	Result
5230.000000	5245.049505	1.327	11.0	PASS

**Ports**

Port	State
1	used

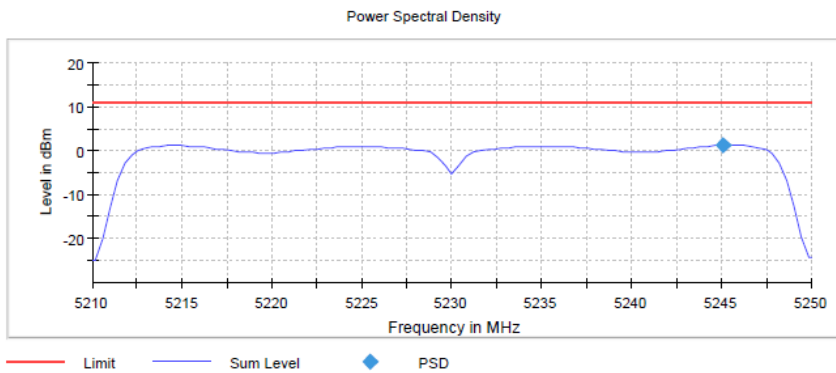

Setting	Instrument Value
Start Frequency	5.21000 GHz
Stop Frequency	5.25000 GHz
Span	40.000 MHz
RBW	1.000 MHz
VBW	3.000 MHz
SweepPoints	101
SweepTime	1.010 s
Reference Level	0.000 dBm
Attenuation	10.000 dB
Detector	RMS
SweepCount	60
Filter	3 dB
Trace Mode	Max Hold
SweepType	Sweep
Preamp	off
Stablemode	Trace
Stablevalue	0.30 dB
Run	4 / max. 15
Stable	3 / 3
Max Stable Difference	0.00 dB

**5.6.5 TEST EQUIPMENT USED**

- R&S TS8997

## 5.7 UNDESIRABLE EMISSIONS; GENERAL FIELD STRENGTH LIMITS

Standard **FCC Part 15 Subpart E**

**The test was performed according to:**  
ANSI C63.10

### 5.7.1 TEST DESCRIPTION

#### **Radiated Measurement with 50 Ohm termination at antenna ports**

The test set-up was made in accordance to the general provisions of ANSI C63.10 in a typical installation configuration. The measurements were performed according the following sub-chapters of ANSI C63.10:

- < 30 MHz: Chapter 6.4
- 30 MHz – 1 GHz: Chapter 6.5
- > 1 GHz: Chapter 6.6 (procedure according 6.6.5 used)

The measurement procedure is implemented into the EMI test software EMC32 from R&S. Exploratory tests are performed at 3 orthogonal axes to determine the worst-case orientation of a body-worn or handheld EUT. The final test on all kind of EUTs is also performed at 3 axes. A pre-check is performed while the EUT is powered.

#### **Below 1 GHz:**

The Equipment Under Test (EUT) was set up on a non-conductive table in the semi-anechoic chamber. The influence of the EUT support table that is used between 30–1000 MHz was evaluated.

#### **1. Measurement up to 30 MHz**

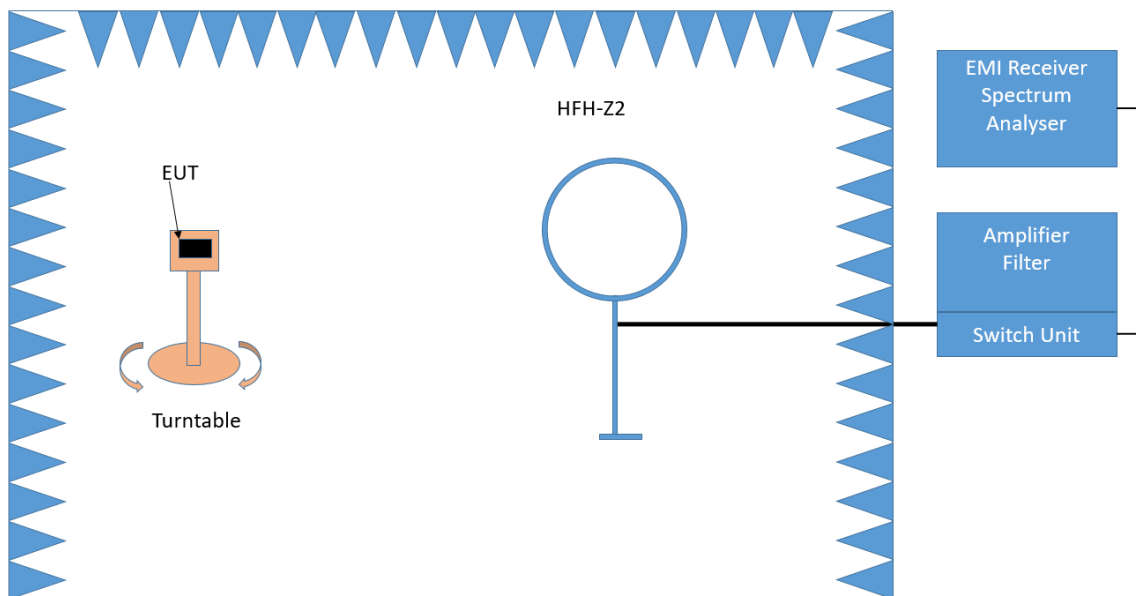

Test Setup; Spurious Emission Radiated (SAC), 9 kHz – 30 MHz

The Loop antenna HFH2-Z2 is used.



### Step 1: pre measurement

- Anechoic chamber
- Antenna distance: 3 m
- Detector: Peak-Maxhold
- Frequency range: 0.009 - 0.15 MHz and 0.15 - 30 MHz
- Frequency steps: 0.05 kHz and 2.25 kHz
- IF-Bandwidth: 0.2 kHz and 9 kHz
- Measuring time / Frequency step: 100 ms (FFT-based)

Intention of this step is, to determine the radiated EMI-profile of the EUT. Afterwards the relevant emissions for the final measurement are identified.

### Step 2: final measurement

For the relevant emissions determined in step 1, an additional measurement with the following settings will be performed. Intention of this step is to find the maximum emission level.

- Open area test site
- Antenna distance: according to the Standard
- Detector: Quasi-Peak
- Frequency range: 0.009 - 30 MHz
- Frequency steps: measurement at frequencies detected in step 1
- IF-Bandwidth: 0.2 - 10 kHz
- Measuring time / Frequency step: 1 s

## 2. Measurement above 30 MHz and up to 1 GHz

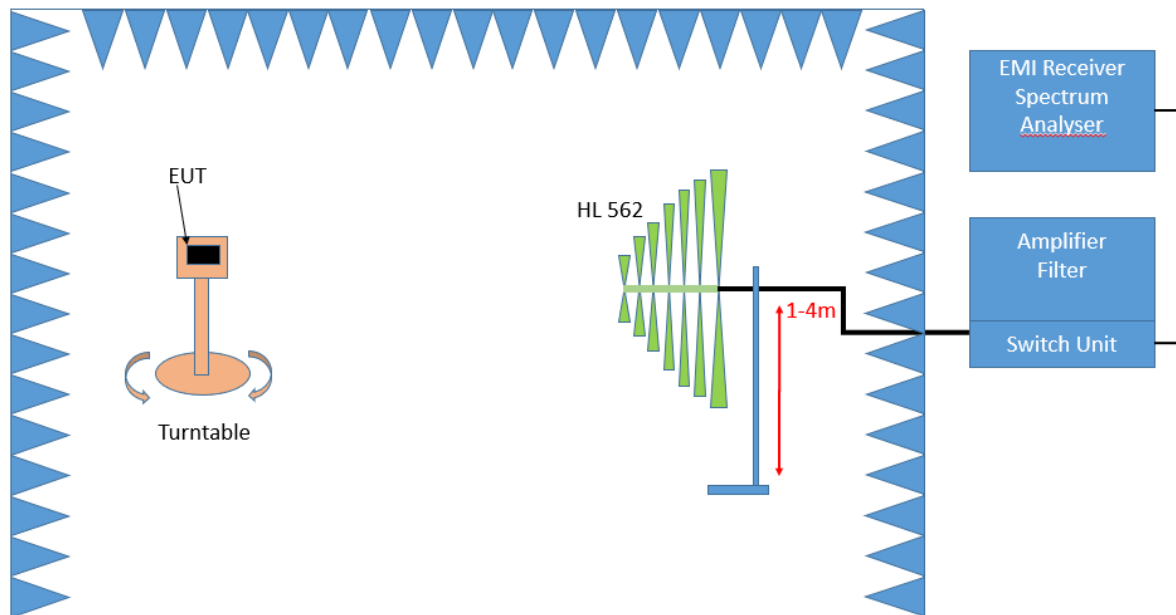

Test Setup; Spurious Emission Radiated (SAC), 30 MHz- 1GHz

### Step 1: Preliminary scan

This is a preliminary test to identify the highest amplitudes relative to the limit.

Settings for step 1:

- Antenna distance: 3 m
- Detector: Peak-Maxhold / Quasipeak (FFT-based)
- Frequency range: 30 - 1000 MHz
- Frequency steps: 30 kHz
- IF-Bandwidth: 120 kHz
- Measuring time / Frequency step: 100 ms
- Turntable angle range: -180° to 90°

- Turntable step size: 90°
- Height variation range: 1 – 4 m
- Height variation step size: 1.5 m
- Polarisation: Horizontal + Vertical

Intention of this step is, to determine the radiated EMI-profile of the EUT. Afterwards the relevant emissions for the final measurement are identified.

### **Step 2:** Adjustment measurement

In this step the accuracy of the turntable azimuth and antenna height will be improved. This is necessary to find out the maximum value of every frequency.

For each frequency, which was determined the turntable azimuth and antenna height will be adjusted. The turntable azimuth will slowly vary by 360°. During this action, the value of emission is continuously measured. The turntable azimuth at the highest emission will be recorded and adjusted. In this position, the antenna height will also slowly vary by 1 – 4 meter. During this action, the value of emission is also continuously measured. The antenna height of the highest emission will also be recorded and adjusted.

- Detector: Peak – Maxhold
- Measured frequencies: in step 1 determined frequencies
- IF – Bandwidth: 120 kHz
- Measuring time: 100 ms
- Turntable angle range: 360 °
- Height variation range: 1 – 4 m
- Antenna Polarisation: max. value determined in step 1

### **Step 3:** Final measurement with QP detector

With the settings determined in step 2, the final measurement will be performed:

EMI receiver settings for step 3:

- Detector: Quasi-Peak (< 1 GHz)
- Measured frequencies: in step 1 determined frequencies
- IF – Bandwidth: 120 kHz
- Measuring time: 1 s

After the measurement a plot will be generated which contains a diagram with the results of the preliminary scan and a chart with the frequencies and values of the results of the final measurement.

### Above 1 GHz:

The Equipment Under Test (EUT) was set up on a non-conductive support (tilt device) at 1.5 m height in the fully-anechoic chamber.

All steps were performed with one height (1.5 m) of the receiving antenna only.

### 3. Measurement 1 GHz up to 26.5 GHz

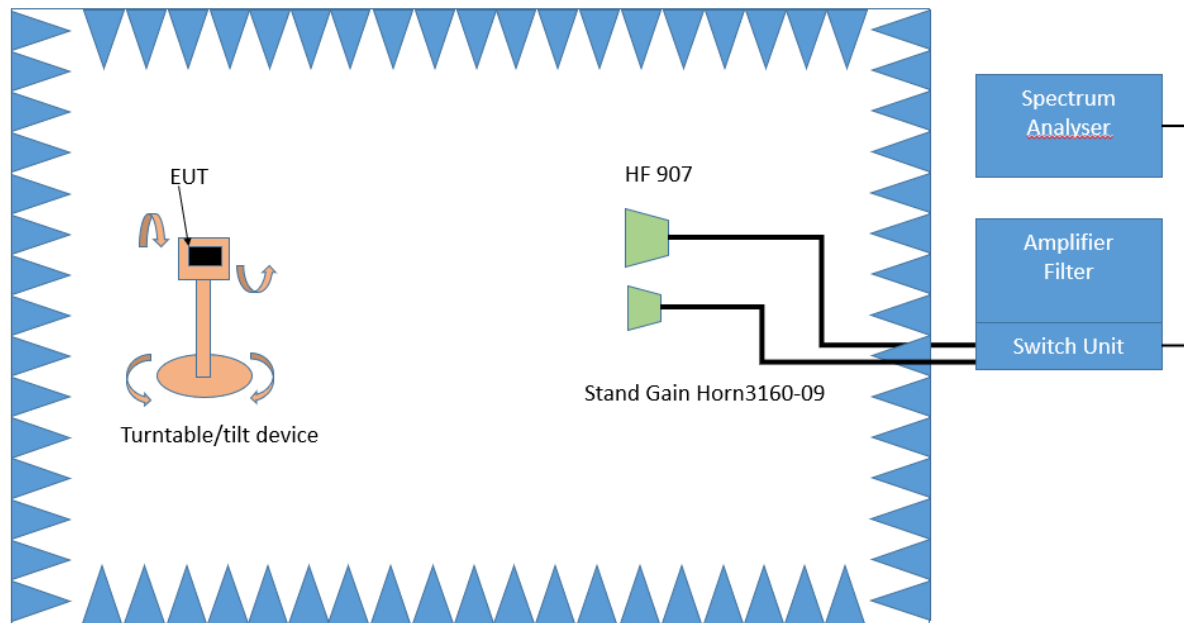

Test Setup; Spurious Emission Radiated (FAC), 1 GHz-26.5 GHz

#### Step 1:

The Equipment Under Test (EUT) was set up on a non-conductive support (tilt device) at 1.5 m height in the fully-anechoic chamber.

All steps were performed with one height (1.5 m) of the receiving antenna only.

The EUT is turned during the preliminary measurement across the elevation axis, with a step size of 90 °.

The turn table step size (azimuth angle) for the preliminary measurement is 45 °.

#### Step 2:

Due to the fact, that in this frequency range the test is performed in a fully anechoic room, the height scan of the receiving antenna instep 2 is omitted. Instead of this, a maximum search with a step size  $\pm 45^\circ$  for the elevation axis is performed.

The turn table azimuth will slowly vary by  $\pm 22.5^\circ$ .

The elevation angle will slowly vary by  $\pm 45^\circ$

EMI receiver settings (for all steps):

- Detector: Peak, Average
- IF Bandwidth = 1 MHz

#### Step 3:

Spectrum analyser settings for step 3:

- Detector: Peak / Average
- Measured frequencies: in step 1 determined frequencies
- IF – Bandwidth: 1 MHz
- Measuring time: 1 s

#### 4. Measurement above 26.5 GHz up to 40 GHz

The following modifications, compared to the frequency range 1 GHz – 26.5 GHz, apply to the measurement procedure for the frequency range above 26.5 GHz:

- Measurement distance: 1m

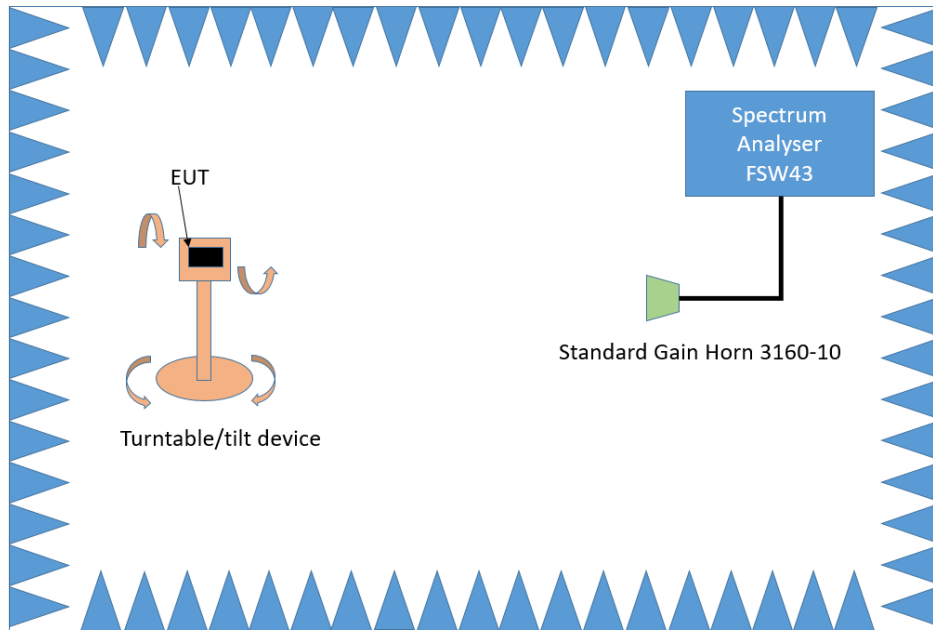

Test Setup; Spurious Emission Radiated (FAC), 26.5 – 40 GHz

### Conducted Measurements at antenna ports

The Equipment Under Test (EUT) was set up to perform the spurious emissions measurements.

The EUT was connected to the test system as described in the block diagram below. The complete attenuation of the measurement path is known and considered.

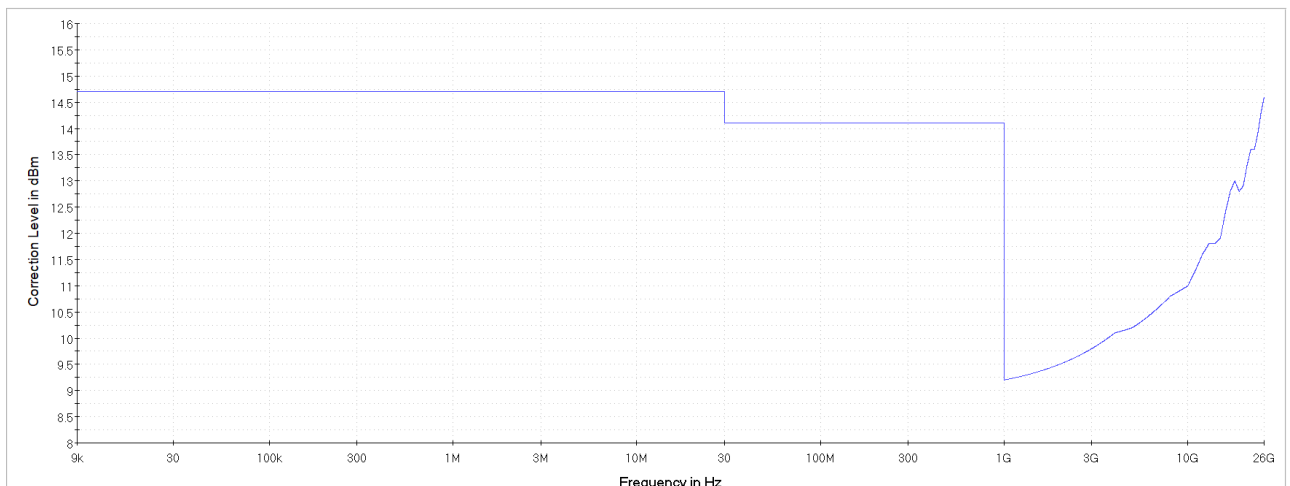
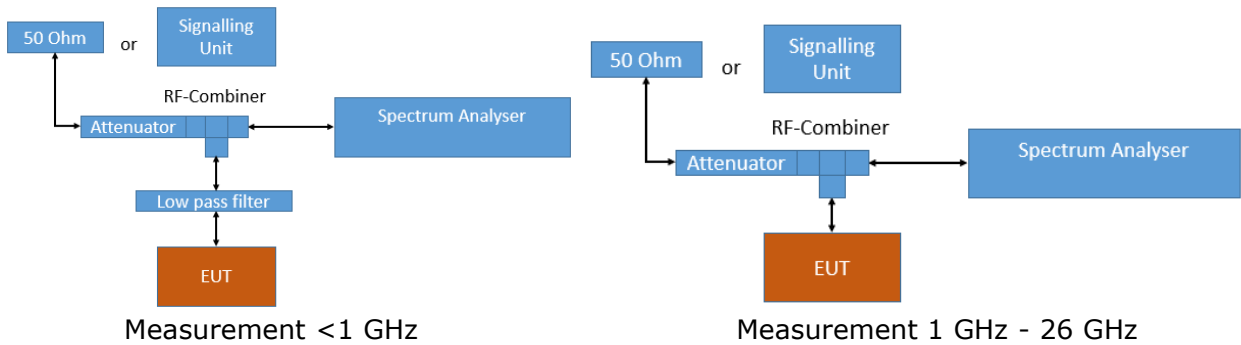

Measurement 26 GHz - 40 GHz

Analyser settings:

- Frequency range: 0.009 – 30 MHz
- Resolution Bandwidth (RBW): 10 kHz
- Video Bandwidth (VBW): 30 kHz
- Trace: Maxhold
- Sweeps: till stable
- Sweep Time: coupled
- Detector: Peak
  
- Frequency range: 30 – 1000 MHz
- Resolution Bandwidth (RBW): 100 kHz
- Video Bandwidth (VBW): 300 kHz
- Trace: Maxhold
- Sweeps: till stable
- Sweep Time: coupled
- Detector: Peak
  
- Frequency range: 1000 – 26000 MHz
- Resolution Bandwidth (RBW): 1000 kHz
- Video Bandwidth (VBW): 3000 kHz
- Trace: Maxhold, Average Power
- Sweeps: 500
- Sweep Time: coupled
- Detector: Peak, RMS
  
- Frequency range: 26000 – 40000 MHz
- Resolution Bandwidth (RBW): 1000 kHz
- Video Bandwidth (VBW): 3000 kHz
- Trace: Maxhold, Average Power
- Sweeps: 1000
- Sweep Time: coupled
- Detector: Peak, RMS

For the conducted emissions in restricted bands the Value is measured in dBm and then converted to dB $\mu$ V/m as given in KDB 789033:

1. Measure the conducted output power in dBm.
2. Add the maximum antenna gain in dBi. (Included in measurement result by offset)
3. Add the appropriate ground reflection factor (included in measurement result by transducer factor)
  - 6 dB for frequencies  $\leq$  30 MHz;
  - 4.7 dB for frequencies between 30 MHz and 1000 MHz, inclusive; and
  - 0 dB for frequencies  $>$  1000 MHz).
4. Convert the resultant EIRP level to an equivalent electric field strength level using the following relationship:
  - $E = \text{EIRP} - 20 \log D + 104.8$
  - Where E is the electric field strength in dB $\mu$ V/m,
  - EIRP is the equivalent isotropically radiated power in dBm
  - D is the specified measurement distance in m

Value [dB $\mu$ V/m] = Measured value [dBm] (including gain and ground reflection factor) – 20 log D + 104.8

## 5.7.2 TEST REQUIREMENTS / LIMITS

### A) FCC

FCC Part 15 Subpart E, §15.407 (b)(1)

For transmitters operating in the 5150–5250 MHz band:

Limit: –27 dBm/MHz EIRP outside of the band 5150–5350 MHz.

FCC Part 15 Subpart E, §15.407 (b)(2)

For transmitters operating in the 5250–5350 MHz band:

Limit: –27 dBm/MHz EIRP outside of the band 5150–5350 MHz.

FCC Part 15 Subpart E, §15.407 (b)(3)

For transmitters operating in the 5470–5725 MHz band:

Limit: –27 dBm/MHz EIRP outside of the band 5470–5725 MHz.

FCC Part 15 Subpart E, §15.407 (b)(4)

For transmitters operating in the 5725–5850 MHz band:

Limit: –27 dBm/MHz at 75 MHz or more above or below the band edge  
increasing linearly to 10 dBm/MHz at 25 MHz above or below the band edge  
increasing linearly to 15.6 dBm/MHz at 5 MHz above or below the band edge  
increasing linearly to 27 dBm/MHz at the band edge.

FCC Part 15 Subpart E, §15.407 (b) (5)

For transmitters operating within the 5.925-7.125 GHz band:

Limit: –27 dBm/MHz EIRP outside of the band 5.925-7.125 GHz.

FCC Part 15 Subpart E, §15.407 (b) (6)

For transmitters operating within the 5.925-7.125 GHz bands:

Power spectral density must be suppressed by 20 dB at 1 MHz outside of channel edge, by 28 dB at one channel bandwidth from the channel center, and by 40 dB at one- and one-half times the channel bandwidth away from channel center. At frequencies between one megahertz outside an unlicensed device's channel edge and one channel bandwidth from the center of the channel, the limits must be linearly interpolated between 20 dB and 28 dB suppression, and at frequencies between one and one- and one-half times an unlicensed device's channel bandwidth, the limits must be linearly interpolated between 28 dB and 40 dB suppression. Emissions removed from the channel center by more than one- and one-half times the channel bandwidth must be suppressed by at least 40 dB.

### B) IC

Different frequency bands and limits apply, as compared to the FCC requirements.

RSS-247, 6.2.1.2, Emissions outside the band 5150-5250 MHz, indoor operation only:

Limit: –27 dBm/MHz EIRP outside of the band 5150–5250 MHz.

RSS-247, 6.2.2.2, Emissions outside the band 5250-5350 MHz:

Limit: –27 dBm/MHz EIRP outside of the band 5250–5350 MHz.

RSS-247, 6.2.3.2, Emissions outside the bands 5470-5600 MHz and 5650-5725 MHz:

Limit: –27 dBm/MHz EIRP outside of the band 5470–5725 MHz.

However, devices with bandwidth overlapping the band edge of 5725 MHz can meet the emission limit of -27 dBm/MHz e.i.r.p.at 5850 MHz instead of 5725 MHz.

Note: No operation is permitted for the frequency range 5600–5650 MHz.

RSS-247, 6.2.4.2, Emissions outside the band 5725-5850 MHz:

- a. 27 dBm/MHz at frequencies from the band edges decreasing linearly to 15.6 Bm/MHz at 5 MHz above or below the band edges;
- b. 15.6 dBm/MHz at 5 MHz above or below the band edges decreasing linearly to 10 dBm/MHz at 25 MHz above or below the band edges;
- c. 10 dBm/MHz at 25 MHz above or below the band edges decreasing linearly to -27 dBm/MHz at 75 MHz above or below the band edges; and
- d. -27 dBm/MHz at frequencies more than 75 MHz above or below the band edges.

### C) FCC & IC

FCC Part 15 Subpart E, §15.405

The provisions of §§ 15.203 and 15.205 are included.

§15.407 (b)(6)

Unwanted emissions below 1 GHz must comply with the general field strength limits set forth in § 15.209.

§15.407 (b)(7)

The provisions of §15.205 apply to intentional radiators operating under this section

FCC Part 15, Subpart C, §15.209, Radiated Emission Limits

Frequency in MHz	Limit (µV/m)	Measurement distance (m)	Limits (dBµV/m)
0.009 – 0.49	2400/F(kHz)@300m	3	(48.5 – 13.8)@300m
0.49 – 1.705	24000/F(kHz)@30m	3	(33.8 – 23.0)@30m
1.705 – 30	30@30m	3	29.5@30m

The measured values are corrected with an inverse linear distance extrapolation factor (40 dB/decade) according FCC 15.31 (2).

Frequency in MHz	Limit (µV/m)	Measurement distance (m)	Limits (dBµV/m)
30 – 88	100@3m	3	40.0@3m
88 – 216	150@3m	3	43.5@3m
216 – 960	200@3m	3	46.0@3m
960 – 26000	500@3m	3	54.0@3m
26000 – 40000	500@3m	1	54.0@3m

The measured values above 26 GHz are corrected with an inverse linear distance extrapolation factor (20 dB/decade).

§15.35(b) ..., there is also a limit on the radio frequency emissions, as measured using instrumentation with a peak detector function, corresponding to 20 dB above the maximum permitted average limit....

Used conversion factor:

- Limit (dBµV/m) = 20 log (Limit (µV/m)/1µV/m)
- Limit (dBµV/m) = EIRP [dBm] – 20 log (d [m]) + 104.8

Limit types (in result tables):

RB – Emissions falls into a “Restricted Band” according FCC §§15.205 and 15.209 \*)

UE – “Undesirable Emission Limit” according FCC §15.407

BE-RB – Band Edge Limit basing on “Restricted Band Limits”

BE-UE – Band Edge Limit basing on “Undesirable Emission Limit”

\*) Below 1 GHz the limits of §15.209 are applied for all frequencies.



### 5.7.3 TEST PROTOCOL

Ambient temperature: 23-27 °C  
 Air Pressure: 1000 - 1008 hPa  
 Humidity: 32-50 %  
 WLAN a-Mode; 20 MHz; 6 Mbit/s  
 Applied duty cycle correction (AV): 0 dB

Measurement Method	Ch. Center Freq. [MHz]	Spurious Freq. [MHz]	Spurious Level [dBµV/m]	Detector	RBW [kHz]	Limit [dBµV/m]	Margin [dB]	Limit Type
Conducted	5180	6906.8	42.9	PEAK	1000	68.2	25.3	UE
Radiated	5180	10360.2	62.4	PEAK	1000	68.2	5.8	UE
Conducted	5200	649.7	29.7	PEAK	100	46.0	16.3	RB
Radiated	5200	10399.9	66.2	PEAK	1000	68.2	2.0	UE
Conducted	5200	5534.6	64.1	PEAK	1000	68.2	4.1	UE
Radiated	5240	10474.3	63.2	PEAK	1000	68.2	5.0	UE
Conducted	5240	4942.6	65.4	PEAK	1000	74.0	8.6	RB
Conducted	5240	4942.6	48.3	AV	1000	54.0	5.7	RB
Radiated	5260	10519.1	67.7	PEAK	1000	68.2	0.5	UE
Radiated	5260	10519.7	67.1	PEAK	1000	68.2	1.1	UE
Conducted	5260	4893.3	63.9	PEAK	1000	74.0	10.1	RB
Conducted	5260	4893.3	46.8	AV	1000	54.0	7.2	RB
Radiated	5300	10599.1	62.4	PEAK	1000	68.2	5.8	UE
Radiated	5320	10640.5	62.7	PEAK	1000	74.0	11.3	RB
Radiated	5320	10640.5	48.8	AV	1000	54.0	5.2	RB
Conducted	5300	662.3	31.1	PEAK	100	46.0	14.9	RB
Conducted	5300	5596.6	62.1	PEAK	1000	68.2	6.1	UE
Conducted	5320	5608.1	62.2	PEAK	1000	68.2	6.0	UE
Conducted	5500	3666.6	49.6	PEAK	1000	74.0	24.4	RB
Conducted	5500	3666.6	42.9	AV	1000	54.0	11.1	RB
Conducted	5500	5769.3	61.8	PEAK	1000	68.2	6.4	UE
Conducted	5580	697.2	35.5	PEAK	100	46.0	10.5	RB
Conducted	5580	3720.1	62.8	PEAK	1000	74.0	11.2	RB
Conducted	5580	3720.1	51.7	AV	1000	54.0	2.3	RB
Conducted	5580	7440.0	54.1	PEAK	1000	74.0	19.9	RB
Conducted	5580	7440.0	46.9	AV	1000	54.0	7.1	RB
Conducted	5700	3799.6	58.3	PEAK	1000	74.0	15.7	RB
Conducted	5700	3800.1	46.1	AV	1000	54.0	7.9	RB
Conducted	5745	3829.4	62.8	PEAK	1000	74.0	11.2	RB
Conducted	5745	3830.1	52.3	AV	1000	54.0	1.7	RB
Conducted	5785	723.3	37.7	PEAK	120	46.0	8.3	RB
Conducted	5785	3856.6	60.1	PEAK	1000	74.0	13.9	RB
Conducted	5785	3856.6	50.4	AV	1000	54.0	3.6	RB
Conducted	5825	3884.1	61.5	PEAK	1000	74.0	12.5	RB
Conducted	5825	3883.4	53.1	AV	1000	54.0	0.9	RB

WLAN n-Mode; 20 MHz; MCS0; SISO  
 Applied duty cycle correction (AV): 0 dB

Ch. No.	Ch. Center Freq. [MHz]	Spurious Freq. [MHz]	Spurious Level [dBµV/m]	Detector	RBW [kHz]	Limit [dBµV/m]	Margin [dB]	Limit Type
116	5580	3719.1	58.6	PEAK	1000	74.0	15.4	RB
116	5580	3720.1	48.1	AV	1000	54.0	5.9	RB
149	5745	3829.9	60.9	PEAK	1000	74.0	13.1	RB
149	5745	3830.1	52.2	AV	1000	54.0	1.8	RB

WLAN n-Mode; 40 MHz; MCS0; SISO  
 Applied duty cycle correction (AV): 0 dB

Ch. No.	Ch. Center Freq. [MHz]	Spurious Freq. [MHz]	Spurious Level [dBµV/m]	Detector	RBW [kHz]	Limit [dBµV/m]	Margin [dB]	Limit Type
151	5755	3837.1	61.8	PEAK	1000	74.0	12.2	RB
151	5755	3836.6	51.4	AV	1000	54.0	2.6	RB

Remark: Please see next sub-clause for the measurement plot.

### 5.7.4 MEASUREMENT PLOT (EXAMPLE PLOT, SHOWING WORST CASE, IF APPLICABLE)

Radio Technology = WLAN a, Operating Frequency = mid, Measurement range = 9kHz - 30MHz, Subband = U-NII-1 (S01\_161\_AD01)

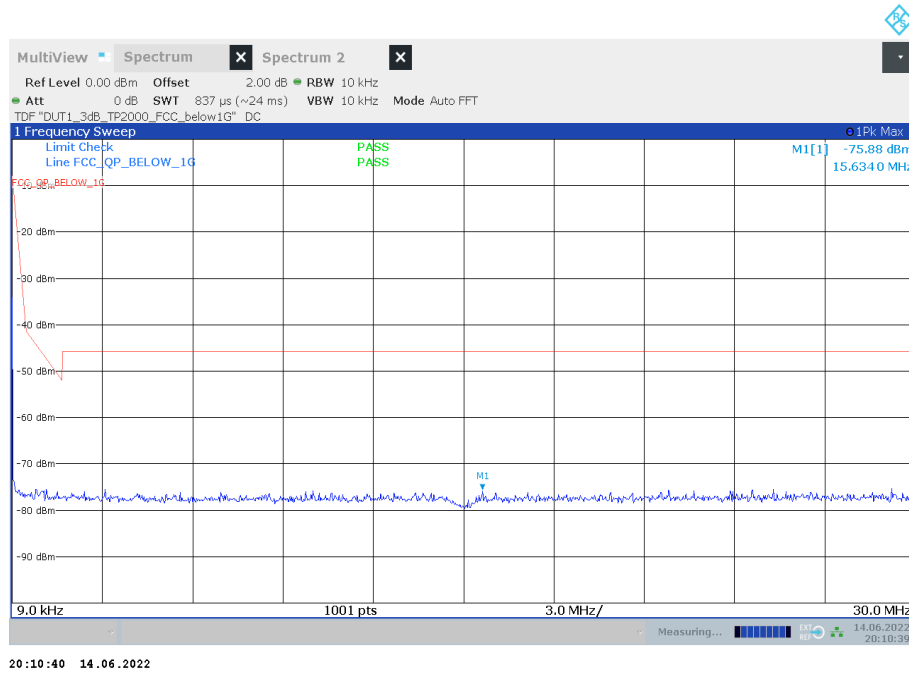

Radio Technology = WLAN a, Operating Frequency = low, Measurement range = 1GHz - 26GHz, Subband = U-NII-3 (S02\_161\_AB01)

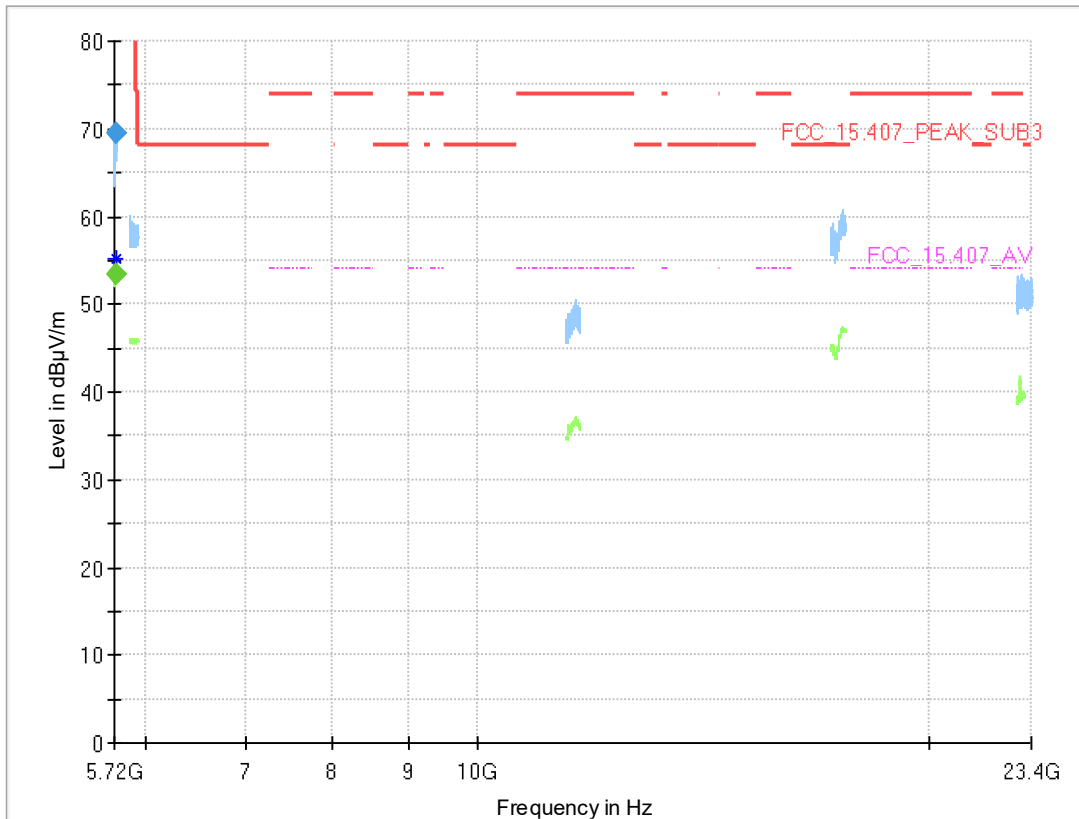

### Final Result

Frequency (MHz)	MaxPeak (dBµV/m)	CAverage (dBµV/m)	Limit (dBµV/m)	Margin (dB)	Meas. Time (ms)	Bandwidth (kHz)	Height (cm)	Pol	Azimuth (deg)	Elevation (deg)	Corr. (dB/m)
5724.600	---	53.4	---	---	1000.0	1000.000	150.0	H	52.0	91.0	14.2
5724.600	69.5	---	121.2	51.81	1000.0	1000.000	150.0	H	52.0	91.0	14.2

Radio Technology = WLAN a, Operating Frequency = mid, Measurement range = 26GHz - 40GHz, Subband = U-NII-1 (S02\_161\_AB01)

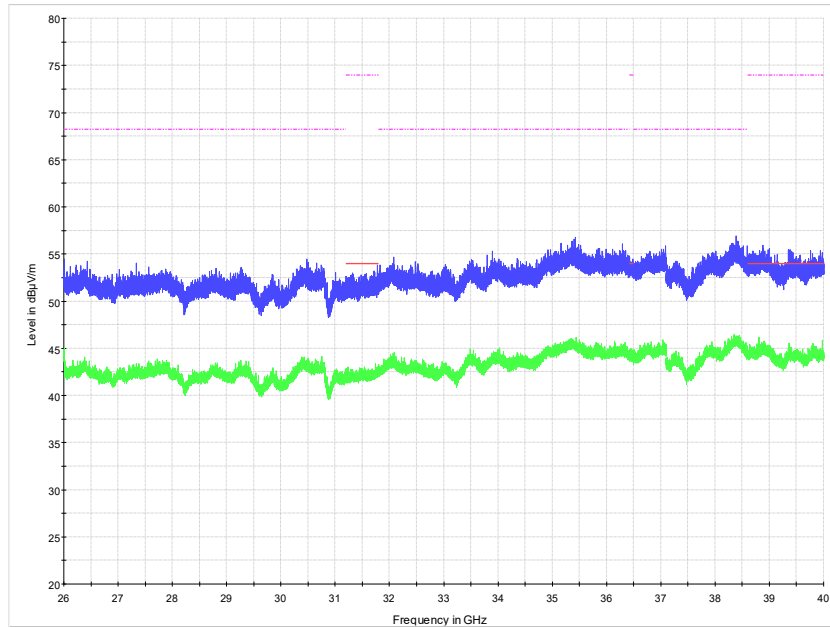

Radio Technology = WLAN a, Operating Frequency = mid, Measurement range = 26GHz - 40GHz, Subband = U-NII-1 (S01\_161\_AD01)

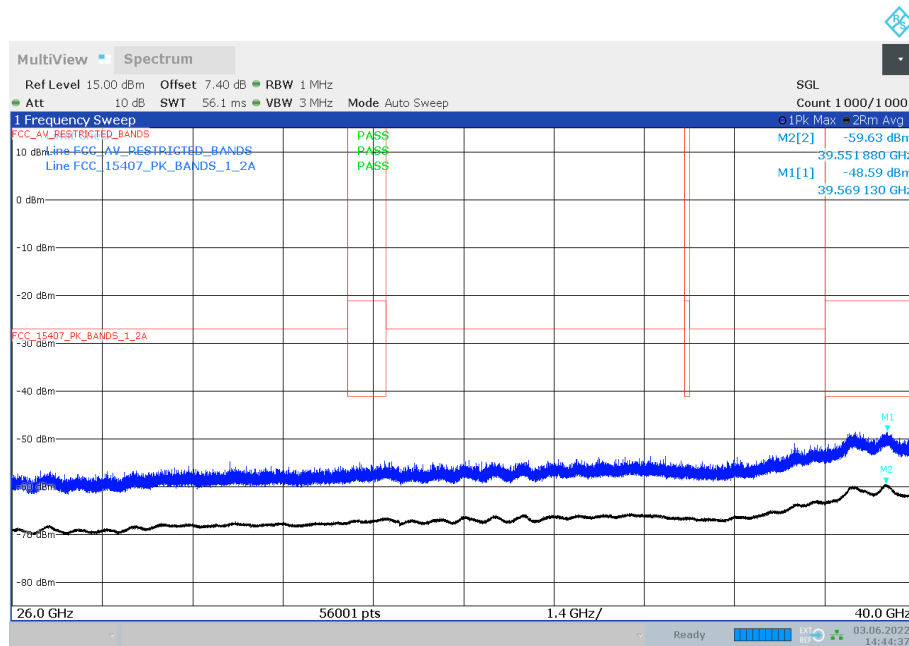

14:44:37 03.06.2022

Radio Technology = WLAN a, Operating Frequency = mid, Measurement range = 9kHz - 30MHz, Subband = U-NII-3 (S01\_161\_AD01)

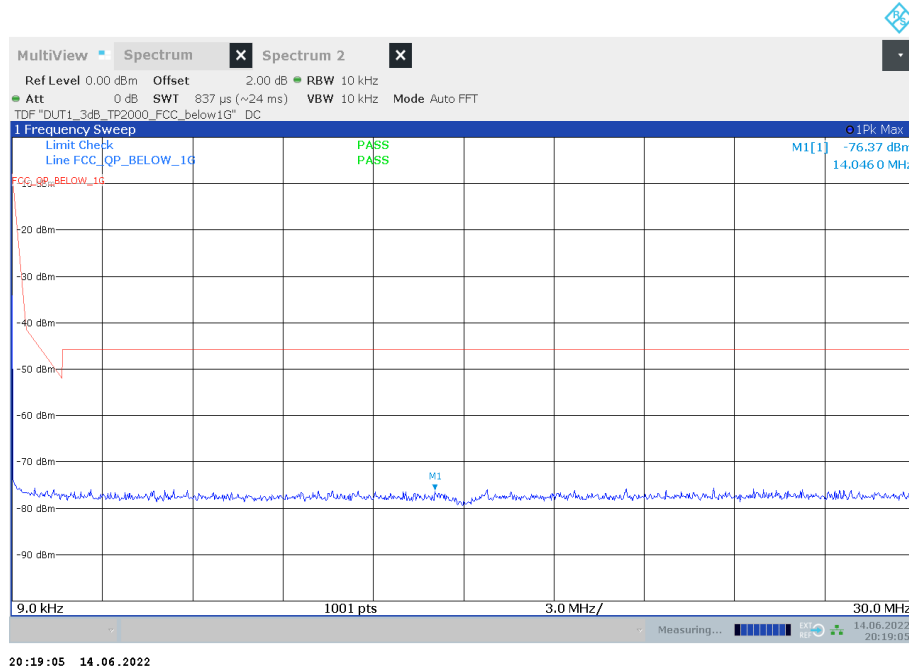

Radio Technology = WLAN a, Operating Frequency = mid, Measurement range = 30MHz - 1GHz, Subband = U-NII-2C (S02\_161\_AB01)

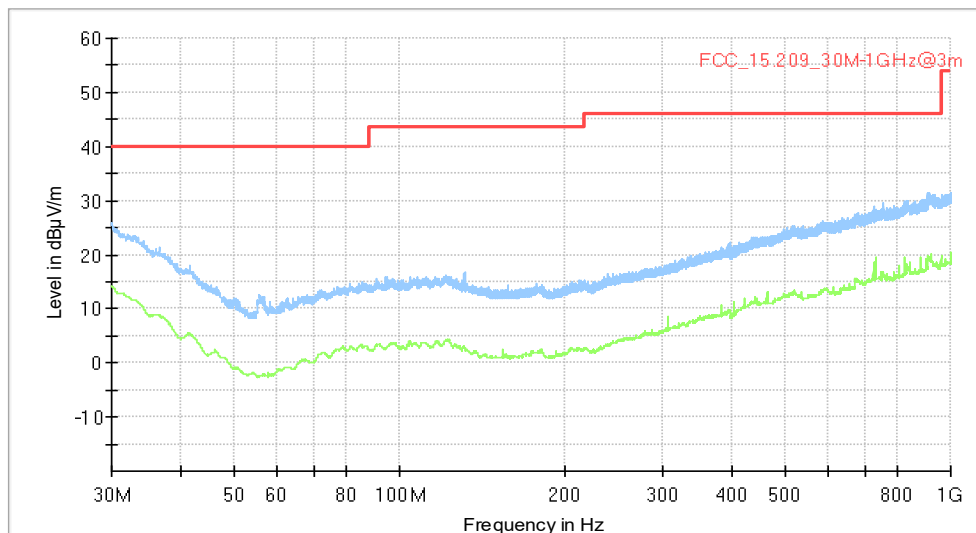

### Final Result

Frequency (MHz)	QuasiPeak (dBμV/m)	Limit (dBμV/m)	Margin (dB)	Meas. Time (ms)	Bandwidth (kHz)	Height (cm)	Pol	Azimuth (deg)	Corr. (dB/m)
---	---	---	---	---	---	---		---	---

Radio Technology = WLAN a, Operating Frequency = mid, Measurement range = 30MHz - 1GHz, Subband = U-NII-2A (S02\_161\_AB01)

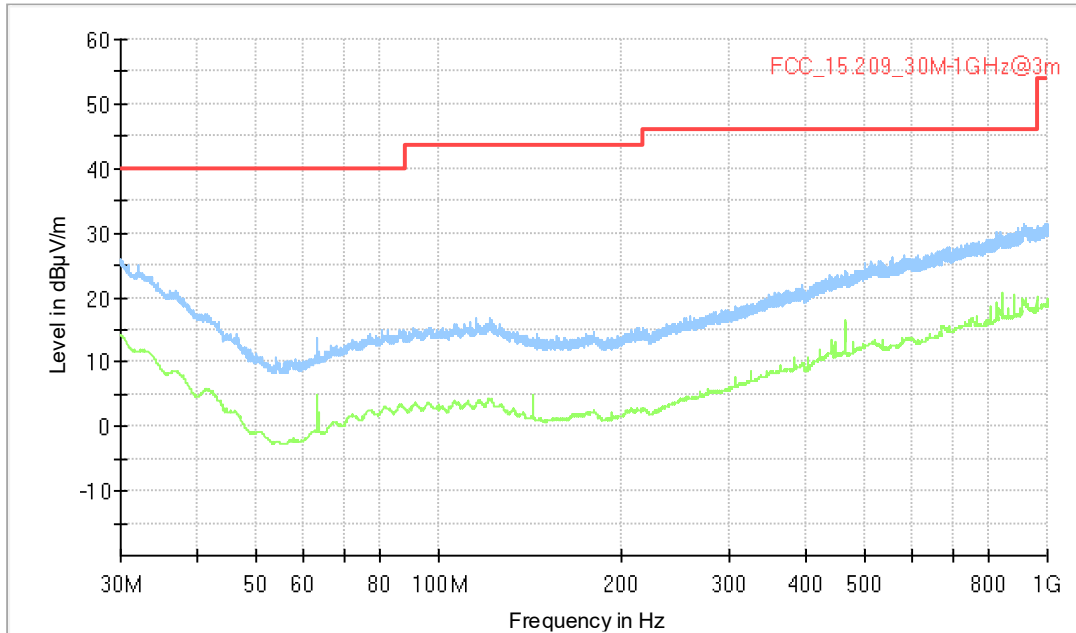

### Final Result

Frequency (MHz)	QuasiPeak (dBµV/m)	Limit (dBµV/m)	Margin (dB)	Meas. Time (ms)	Bandwidth (kHz)	Height (cm)	Pol	Azimuth (deg)	Corr. (dB/m)
---	---	---	---	---	---	---	---	---	---



Radio Technology = WLAN a, Operating Frequency = low, Measurement range = 1GHz - 26GHz, Subband = U-NII-2C (S02\_161\_AB01)

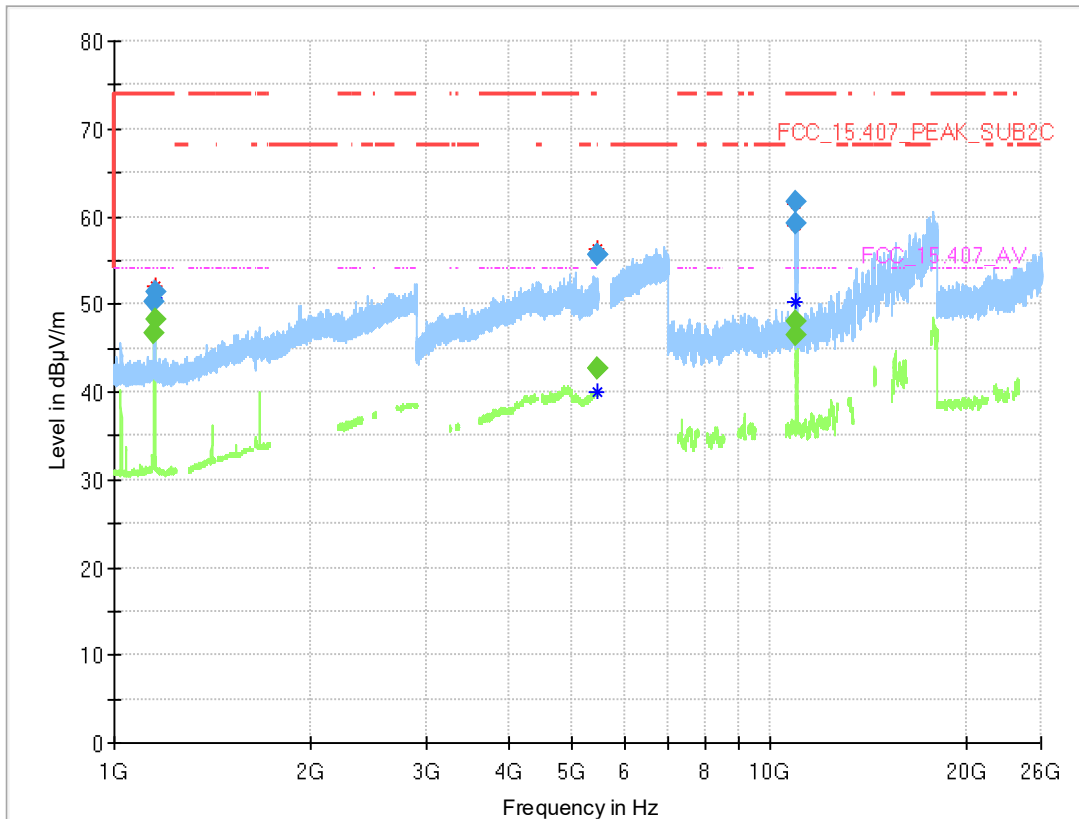

### Final Result

Frequency (MHz)	MaxPeak (dBµV/m)	CAverage (dBµV/m)	Limit (dBµV/m)	Margin (dB)	Meas. Time (ms)	Bandwidth (kHz)	Height (cm)	Pol	Azimuth (deg)	Elevation (deg)	Corr. (dB/m)
1151.920	---	46.8	54.00	7.23	1000.0	1000.000	150.0	H	-34.0	81.0	-1.0
1151.920	50.4	---	74.00	23.61	1000.0	1000.000	150.0	H	-34.0	81.0	-1.0
1152.040	---	48.2	54.00	5.84	1000.0	1000.000	150.0	H	-41.0	91.0	-1.0
1152.040	51.3	---	74.00	22.66	1000.0	1000.000	150.0	H	-41.0	91.0	-1.0
5457.250	---	42.8	54.00	11.22	1000.0	1000.000	150.0	V	11.0	105.0	14.5
5457.250	55.6	---	74.00	18.42	1000.0	1000.000	150.0	V	11.0	105.0	14.5
5459.670	---	42.7	54.00	11.30	1000.0	1000.000	150.0	H	-182.0	15.0	14.5
5459.670	55.6	---	74.00	18.35	1000.0	1000.000	150.0	H	-182.0	15.0	14.5
10999.000	---	46.4	54.00	7.62	1000.0	1000.000	150.0	V	-90.0	3.0	-9.9
10999.000	59.1	---	74.00	14.88	1000.0	1000.000	150.0	V	-90.0	3.0	-9.9
11000.365	---	48.0	54.00	6.01	1000.0	1000.000	150.0	V	-91.0	12.0	-9.9
11000.365	61.7	---	74.00	12.32	1000.0	1000.000	150.0	V	-91.0	12.0	-9.9



Radio Technology = WLAN a, Operating Frequency = high, Measurement range = 9kHz - 30MHz, Subband = U-NII-2C (S02\_161\_AB01)

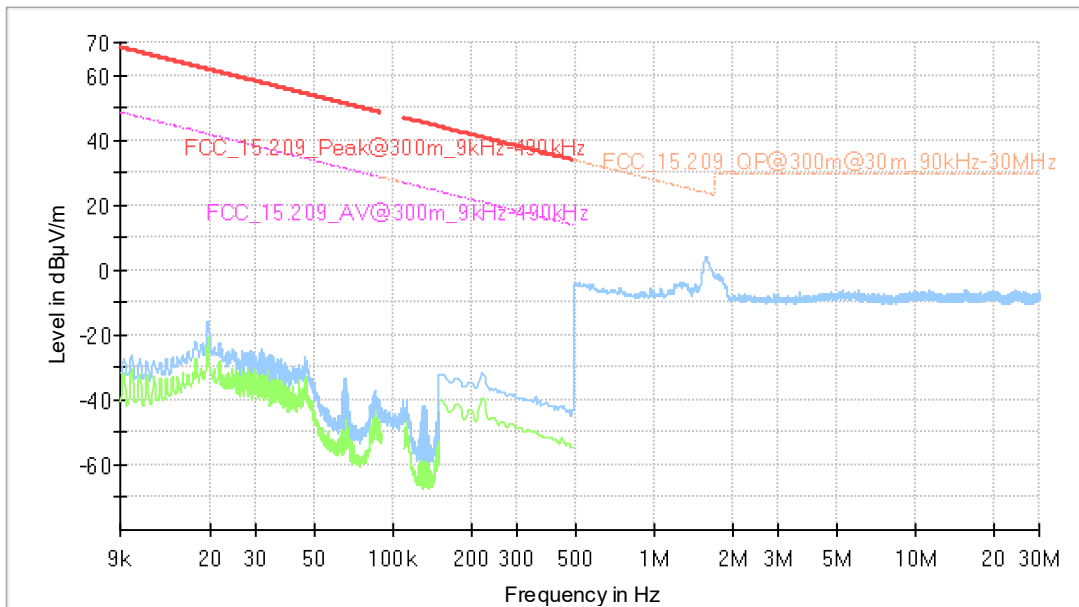

### Final Result

Frequency (MHz)	MaxPeak (dBµV/m)	Average (dBµV/m)	Limit (dBµV/m)	Margin (dB)	Meas. Time (ms)	Bandwidth (kHz)	Height (cm)	Azimuth (deg)	Corr. (dB/m)
---	---	---	---	---	---	---	---	---	---

Radio Technology = WLAN a, Operating Frequency = mid, Measurement range = 30MHz - 1GHz, Subband = U-NII-1 (S02\_161\_AB01)

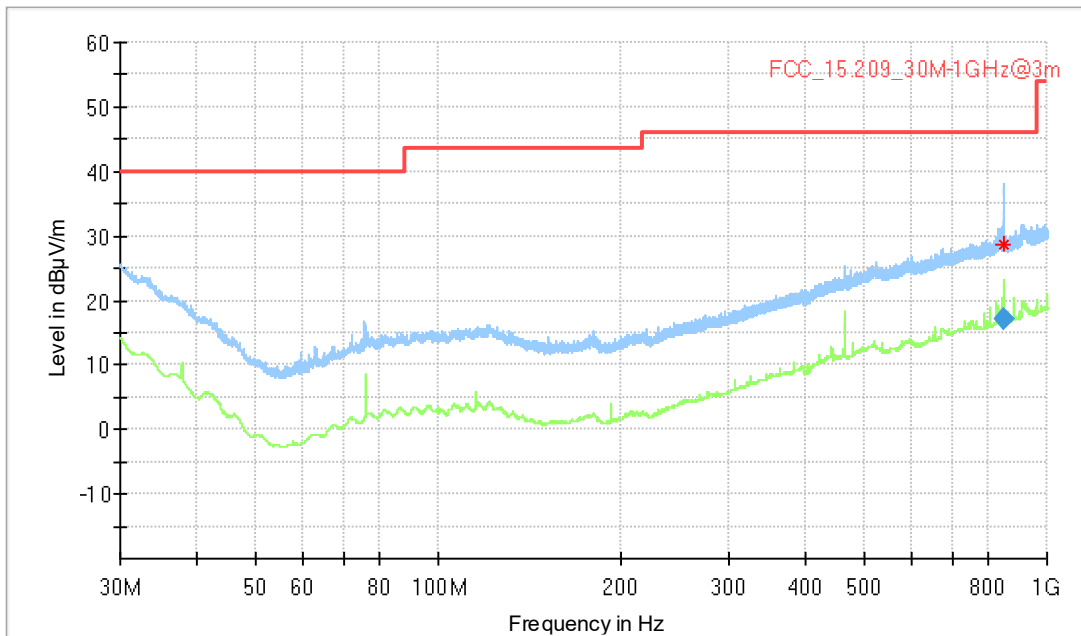

### Final Result

Frequency (MHz)	QuasiPeak (dBµV/m)	Limit (dBµV/m)	Margin (dB)	Meas. Time (ms)	Bandwidth (kHz)	Height (cm)	Pol	Azimuth (deg)	Corr. (dB/m)
848.520000	17.11	46.00	28.89	1000.0	120.000	254.0	H	36.0	24.0

Radio Technology = WLAN a, Operating Frequency = mid, Measurement range = 26GHz - 40GHz, Subband = U-NII-2A (S02\_161\_AB01)

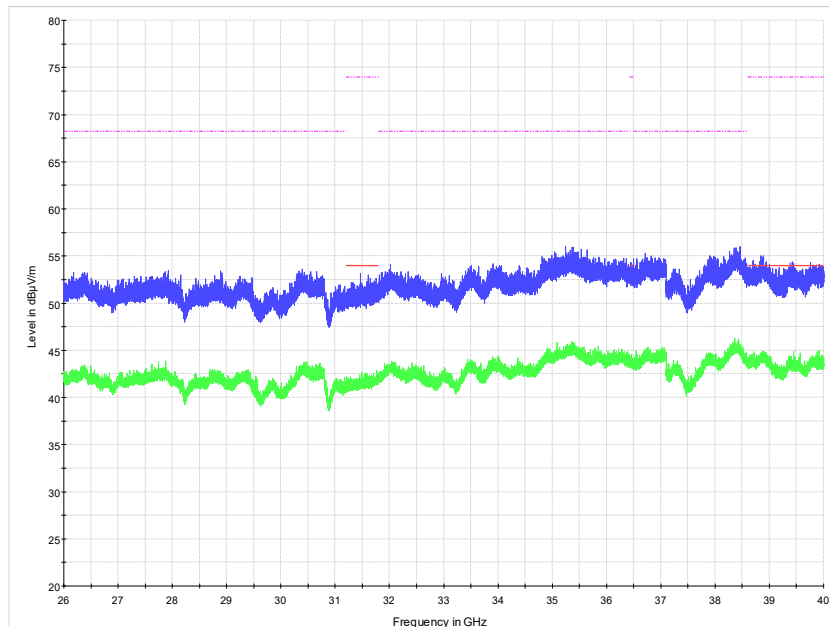

Radio Technology = WLAN a, Operating Frequency = mid, Measurement range = 26GHz - 40GHz, Subband = U-NII-2A (S01\_161\_AD01)

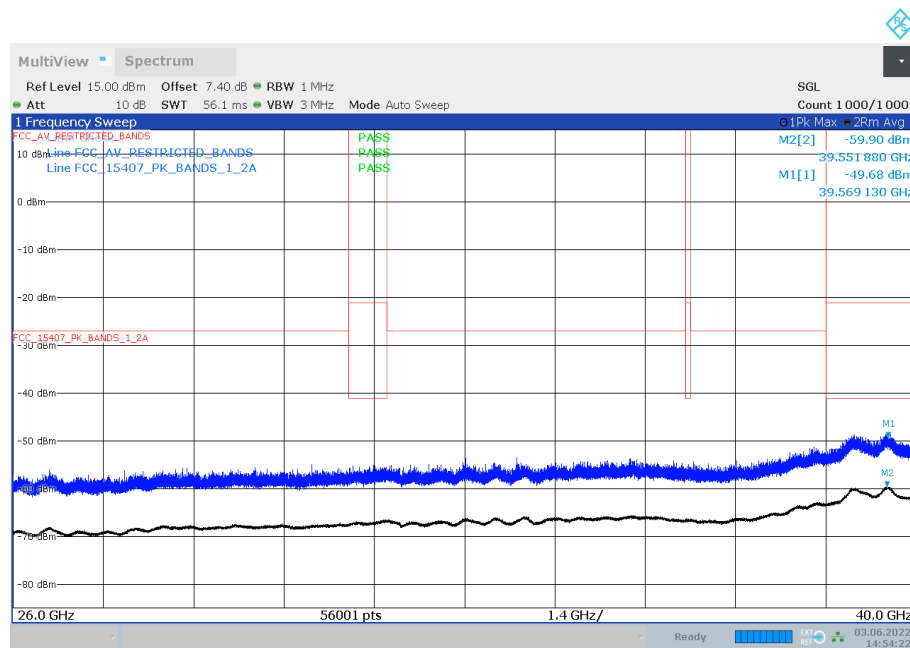

14:54:23 03.06.2022

Radio Technology = WLAN a, Operating Frequency = high, Measurement range = 1GHz - 26GHz, Subband = U-NII-2C (S02\_161\_AB01)

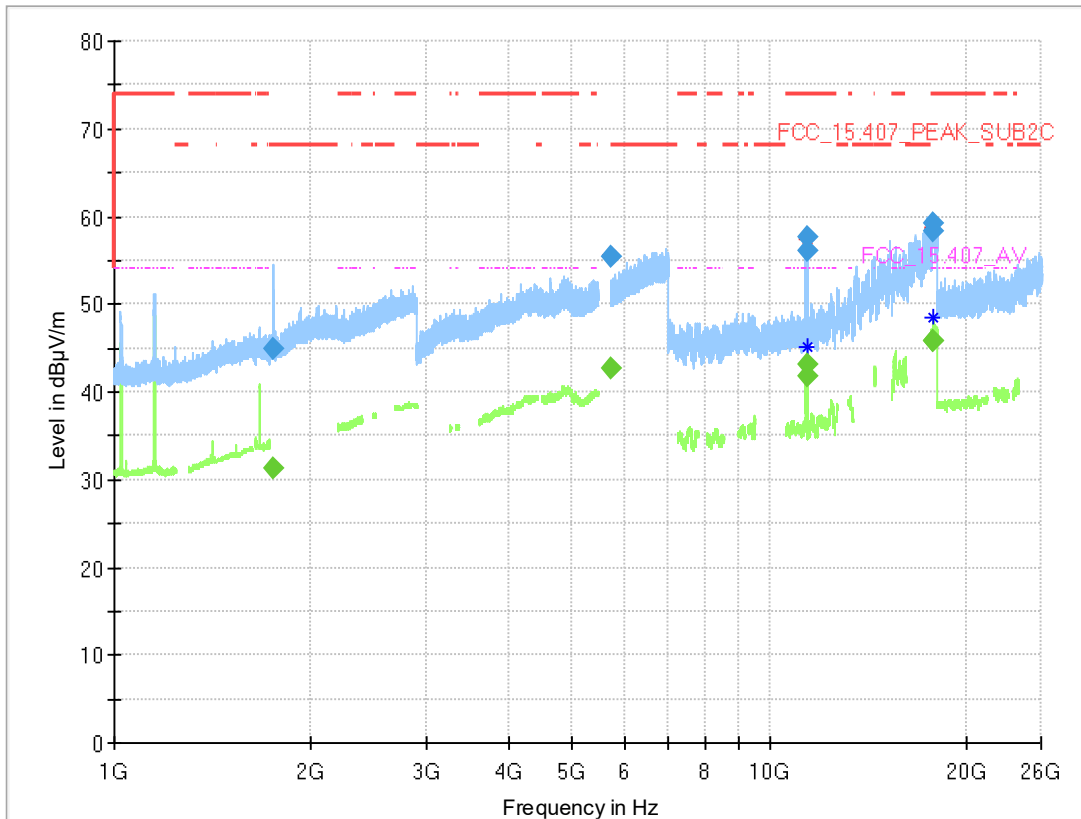

### Final Result

Frequency (MHz)	MaxPeak (dBµV/m)	CAverage (dBµV/m)	Limit (dBµV/m)	Margin (dB)	Meas. Time (ms)	Bandwidth (kHz)	Height (cm)	Pol	Azimuth (deg)	Elevation (deg)	Corr. (dB/m)
1743.940	---	31.3	---	---	1000.0	1000.000	150.0	H	-51.0	-10.0	1.9
1743.940	44.9	---	68.20	23.27	1000.0	1000.000	150.0	H	-51.0	-10.0	1.9
5726.403	---	42.6	---	---	1000.0	1000.000	150.0	V	44.0	100.0	14.2
5726.403	55.5	---	68.20	12.69	1000.0	1000.000	150.0	V	44.0	100.0	14.2
11399.575	---	43.2	54.00	10.77	1000.0	1000.000	150.0	V	-91.0	15.0	-9.2
11399.575	57.6	---	74.00	16.43	1000.0	1000.000	150.0	V	-91.0	15.0	-9.2
11399.995	---	41.8	54.00	12.17	1000.0	1000.000	150.0	V	-90.0	-2.0	-9.2
11399.995	56.1	---	74.00	17.86	1000.0	1000.000	150.0	V	-90.0	-2.0	-9.2
17789.250	---	45.7	54.00	8.30	1000.0	1000.000	150.0	V	11.0	-2.0	1.2
17789.250	59.3	---	74.00	14.71	1000.0	1000.000	150.0	V	11.0	-2.0	1.2
17789.850	---	45.8	54.00	8.23	1000.0	1000.000	150.0	V	-48.0	15.0	1.2
17789.850	58.3	---	74.00	15.66	1000.0	1000.000	150.0	V	-48.0	15.0	1.2

Radio Technology = WLAN a, Operating Frequency = mid, Measurement range = 1GHz - 26GHz, Subband = U-NII-2C (S02\_161\_AB01)

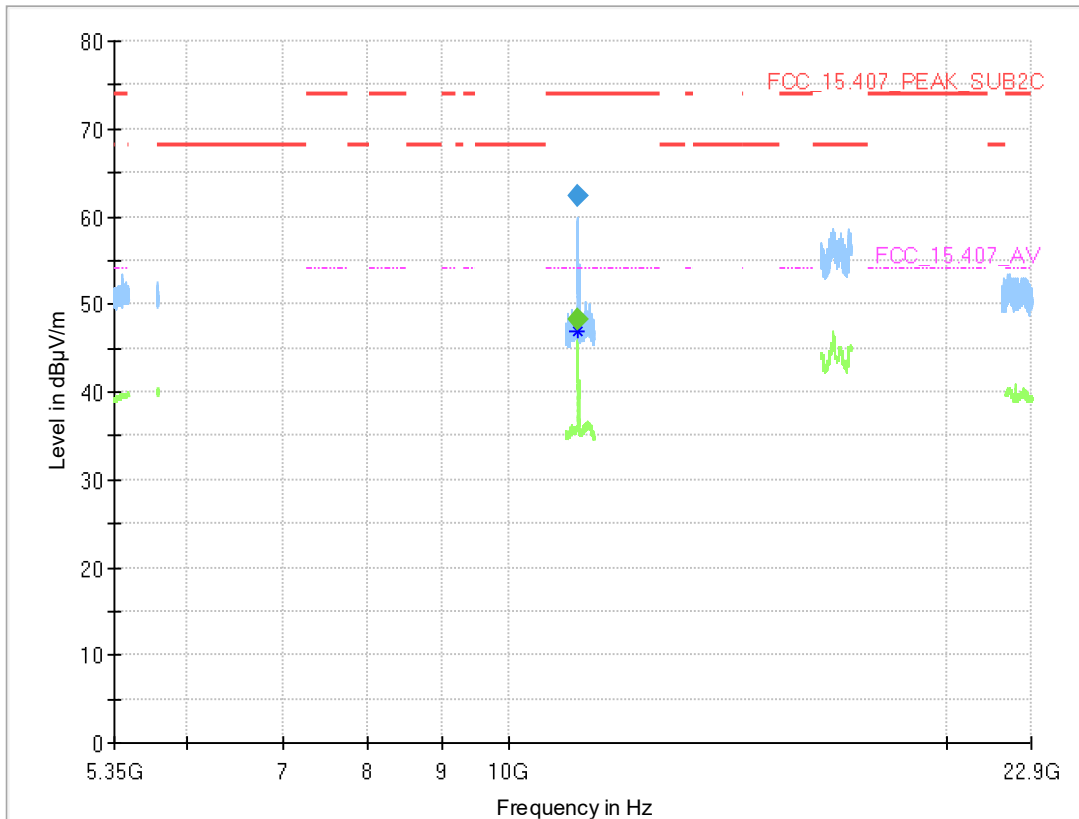

### Final Result

Frequency (MHz)	MaxPeak (dBµV/m)	CAverage (dBµV/m)	Limit (dBµV/m)	Margin (dB)	Meas. Time (ms)	Bandwidth (kHz)	Height (cm)	Pol	Azimuth (deg)	Elevation (deg)	Corr. (dB/m)
11160.320	---	48.2	54.00	5.82	1000.0	1000.000	150.0	H	79.0	90.0	-10.1
11160.320	62.3	---	74.00	11.70	1000.0	1000.000	150.0	H	79.0	90.0	-10.1

Radio Technology = WLAN a, Operating Frequency = mid, Measurement range = 9kHz - 30MHz, Subband = U-NII-2A (S01\_161\_AD01)

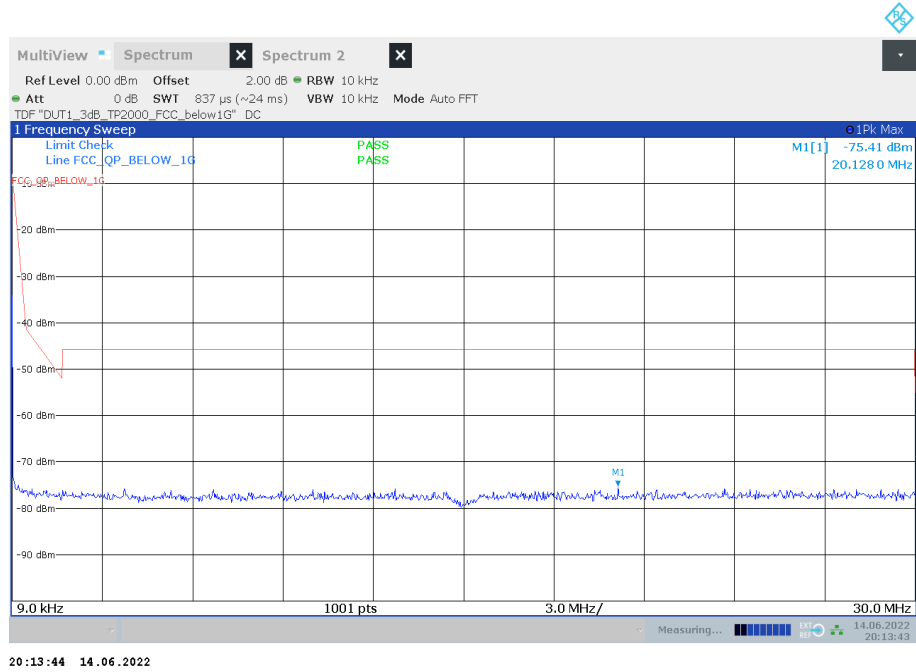

20:13:44 14.06.2022

Radio Technology = WLAN a, Operating Frequency = mid, Measurement range = 1GHz - 26GHz, Subband = U-NII-3 (S02\_161\_AB01)

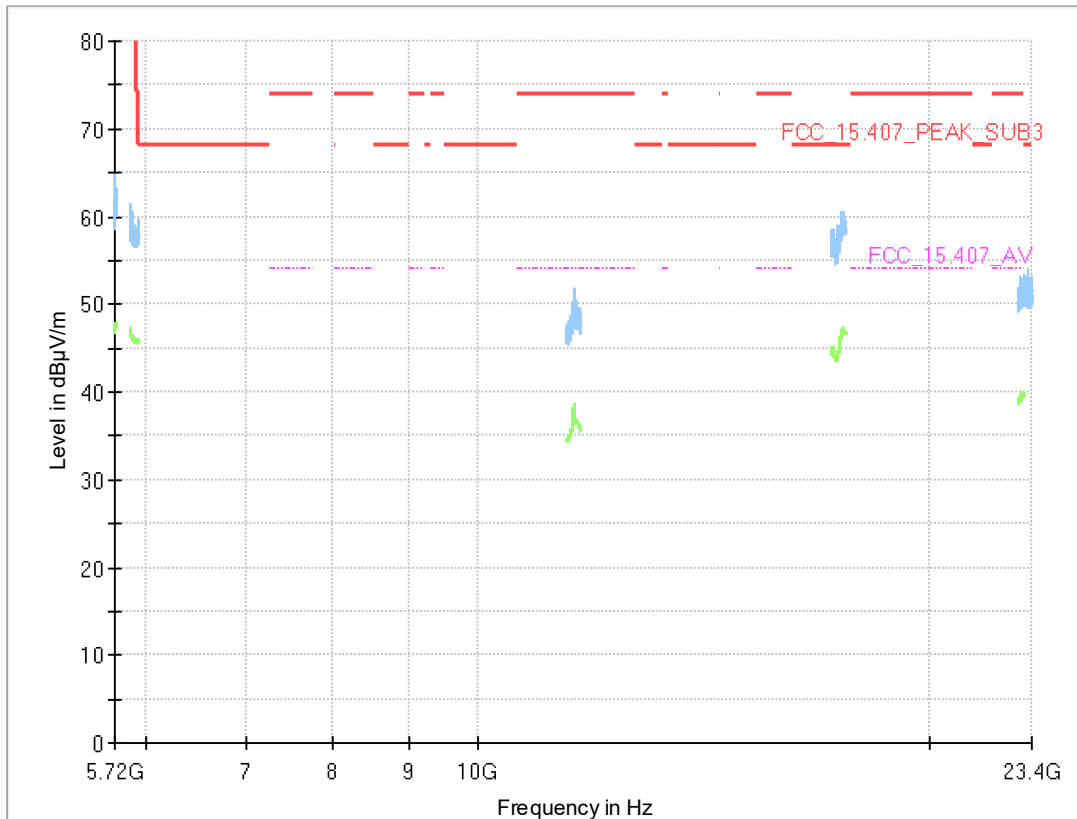

2

### Final Result

Frequency (MHz)	MaxPeak (dBµV/m)	CAverage (dBµV/m)	Limit (dBµV/m)	Margin (dB)	Meas. Time (ms)	Bandwidth (kHz)	Height (cm)	Pol	Azimuth (deg)	Elevation (deg)	Corr. (dB/m)
---	---	---	---	---	---	---	---		---	---	---

Radio Technology = WLAN a, Operating Frequency = mid, Measurement range = 9kHz - 30MHz, Subband = U-NII-2C (S01\_161\_AD01)

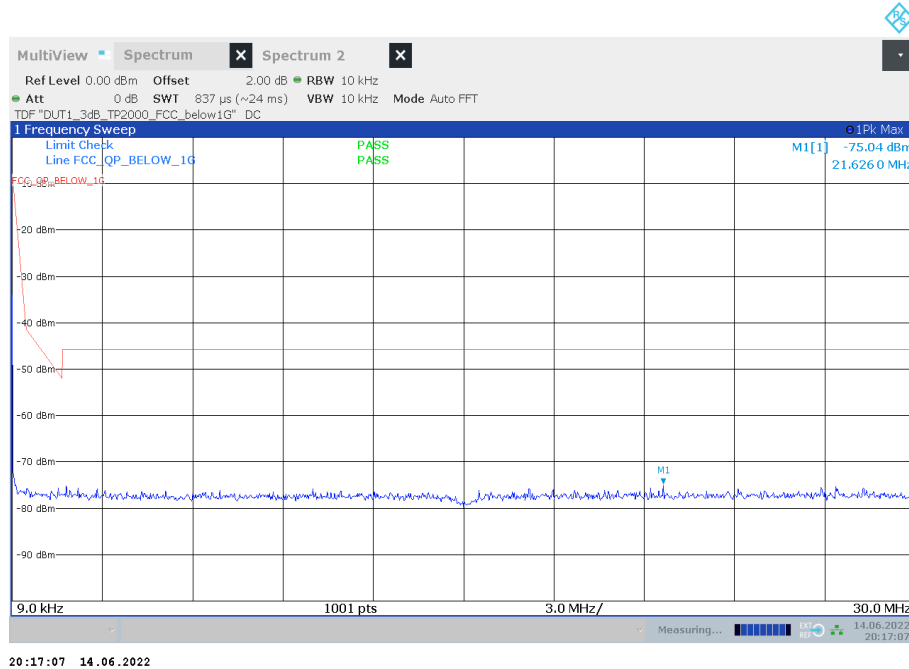

Radio Technology = WLAN a, Operating Frequency = mid, Measurement range = 26GHz - 40GHz, Subband = U-NII-2C (S02\_161\_AB01)

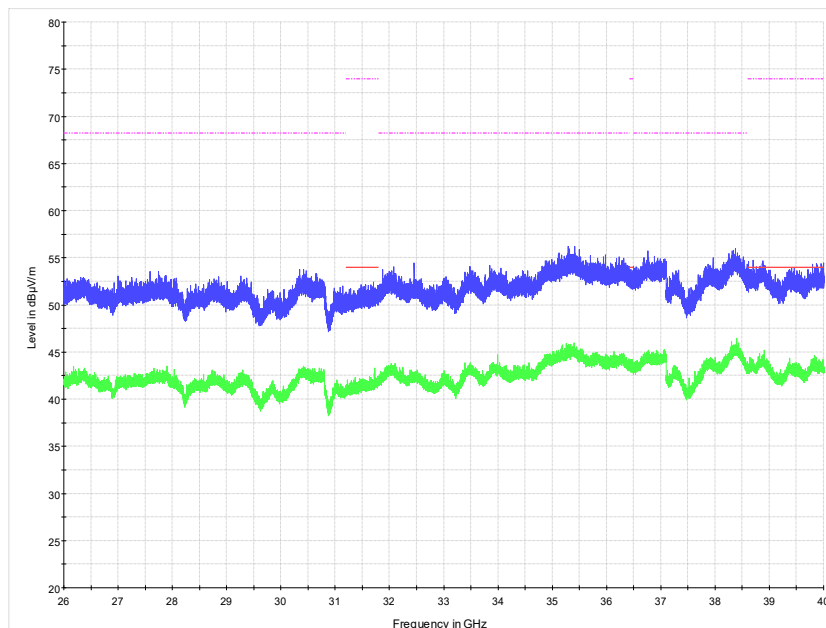



Radio Technology = WLAN a, Operating Frequency = mid, Measurement range = 26GHz - 40GHz, Subband = U-NII-2C (S01\_161\_AD01)

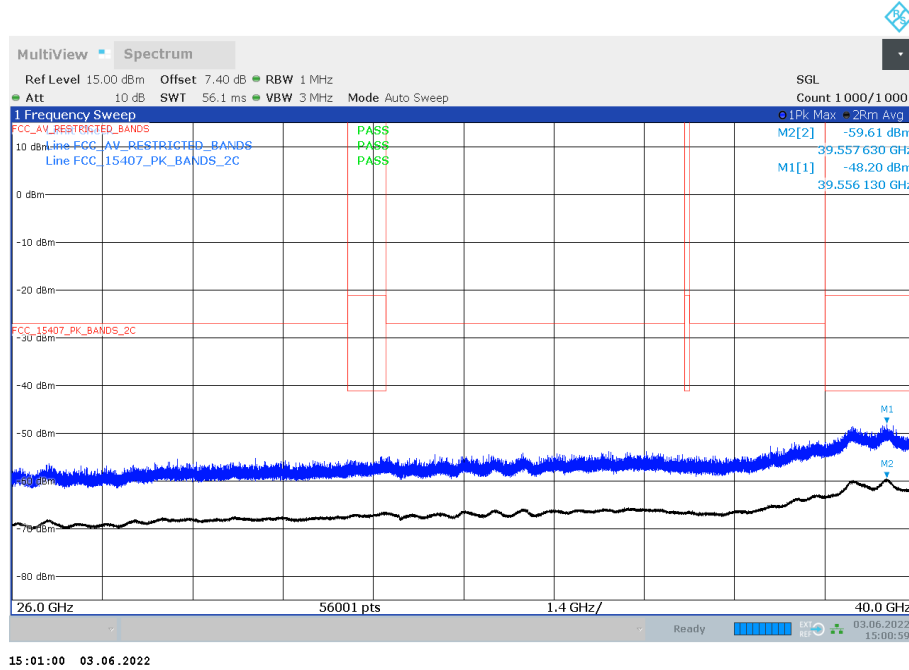

Radio Technology = WLAN a, Operating Frequency = mid, Measurement range = 30MHz - 1GHz, Subband = U-NII-3 (S02\_161\_AB01)

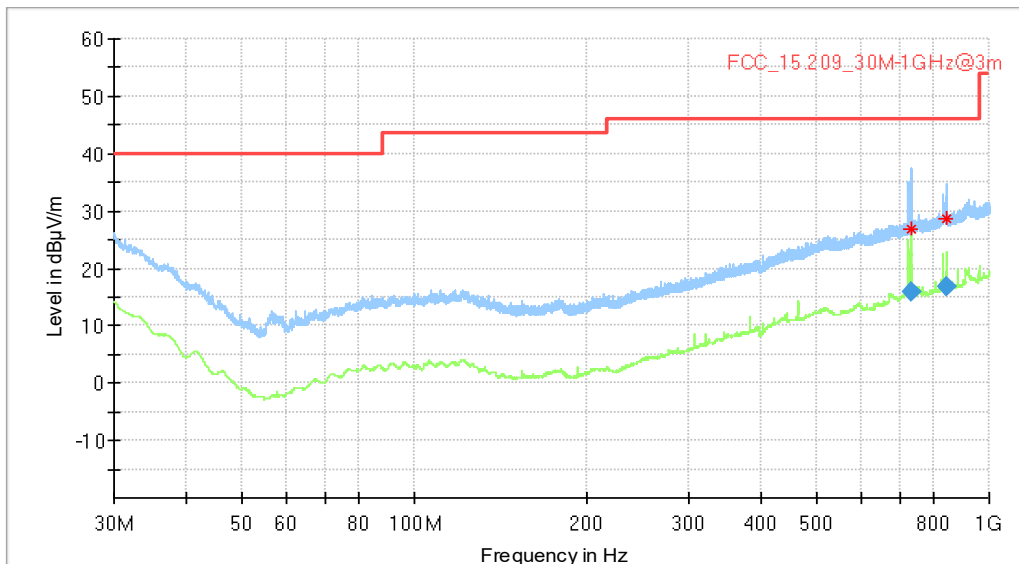

### Final Result

Frequency (MHz)	QuasiPeak (dBµV/m)	Limit (dBµV/m)	Margin (dB)	Meas. Time (ms)	Bandwidth (kHz)	Height (cm)	Pol	Azimuth (deg)	Corr. (dB/m)
730.080000	15.94	46.00	30.06	1000.0	120.000	387.0	V	62.0	23.0
840.660000	16.74	46.00	29.26	1000.0	120.000	290.0	H	-134.0	24.1

Radio Technology = WLAN a, Operating Frequency = low, Measurement range = 9kHz - 30MHz, Subband = U-NII-1 (S02\_161\_AB01)

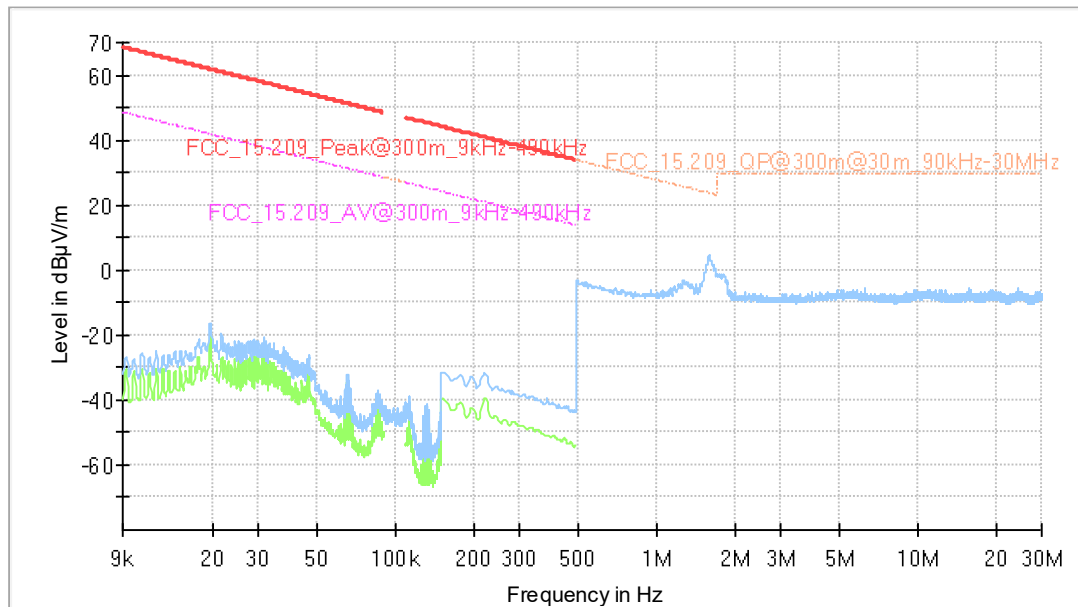

### Final Result

Frequency (MHz)	MaxPeak (dBµV/m)	Average (dBµV/m)	Limit (dBµV/m)	Margin (dB)	Meas. Time (ms)	Bandwidth (kHz)	Height (cm)	Azimuth (deg)	Corr. (dB/m)
---	---	---	---	---	---	---	---	---	---

Radio Technology = WLAN a, Operating Frequency = low, Measurement range = 1GHz - 26GHz, Subband = U-NII-1 (S01\_161\_AD01)

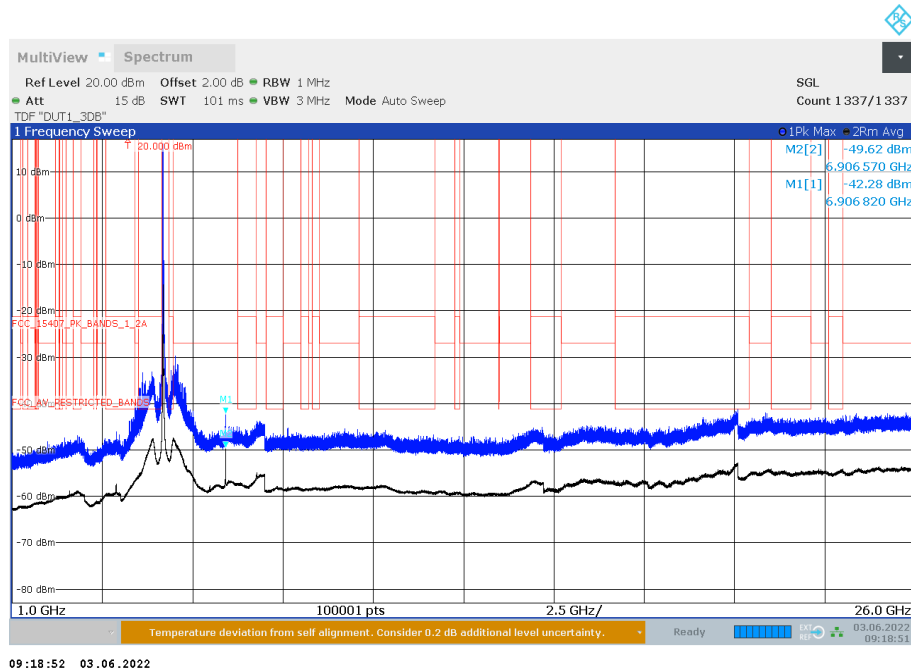

Radio Technology = WLAN a, Operating Frequency = low, Measurement range = 1GHz - 26GHz, Subband = U-NII-1 (S02\_161\_AC01)

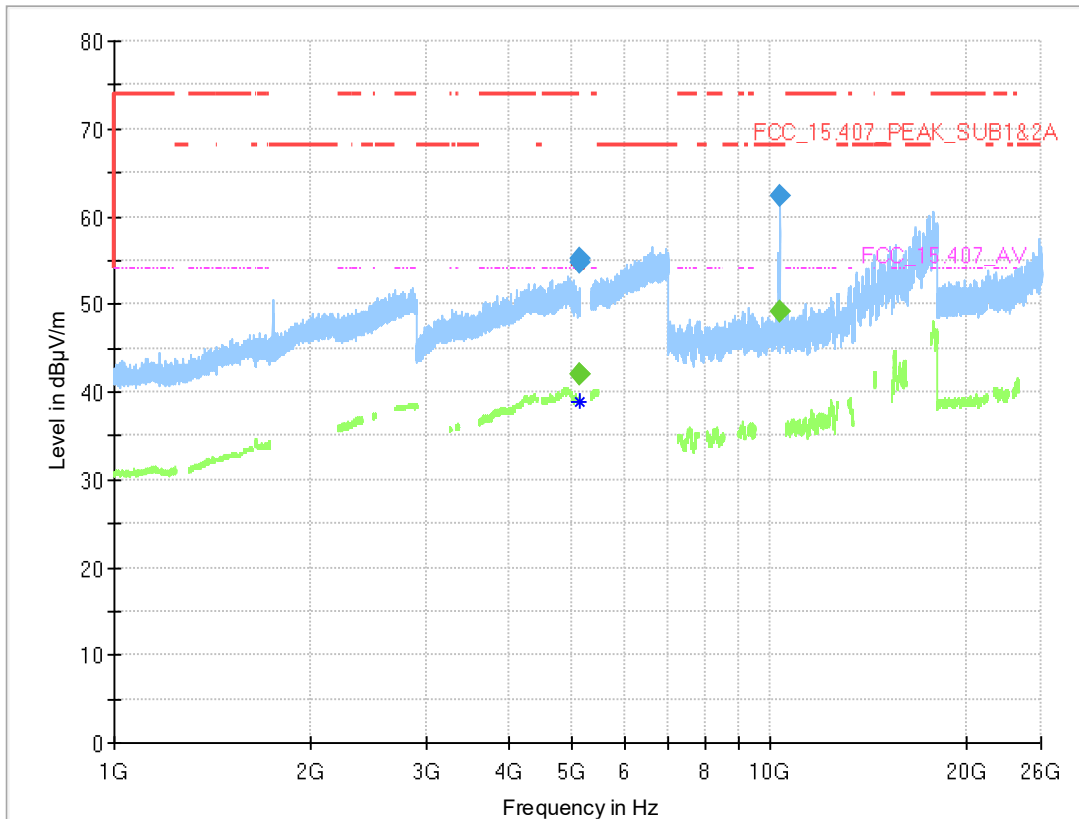

### Final Result

Frequency (MHz)	MaxPeak (dBµV/m)	CAverage (dBµV/m)	Limit (dBµV/m)	Margin (dB)	Meas. Time (ms)	Bandwidth (kHz)	Height (cm)	Pol	Azimuth (deg)	Elevation (deg)	Corr. (dB/m)
5147.400	---	42.0	54.00	12.03	1000.0	1000.000	150.0	H	-169.0	12.0	13.6
5147.400	55.2	---	74.00	18.79	1000.0	1000.000	150.0	H	-169.0	12.0	13.6
5147.725	---	42.0	54.00	11.99	1000.0	1000.000	150.0	V	-11.0	87.0	13.6
5147.725	54.8	---	74.00	19.24	1000.0	1000.000	150.0	V	-11.0	87.0	13.6
10360.200	---	49.1	---	---	1000.0	1000.000	150.0	H	-49.0	90.0	-12.3
10360.200	62.4	---	68.20	5.82	1000.0	1000.000	150.0	H	-49.0	90.0	-12.3

Radio Technology = WLAN a, Operating Frequency = mid, Measurement range = 30MHz - 1GHz, Subband = U-NII-1 (S01\_161\_AD01)

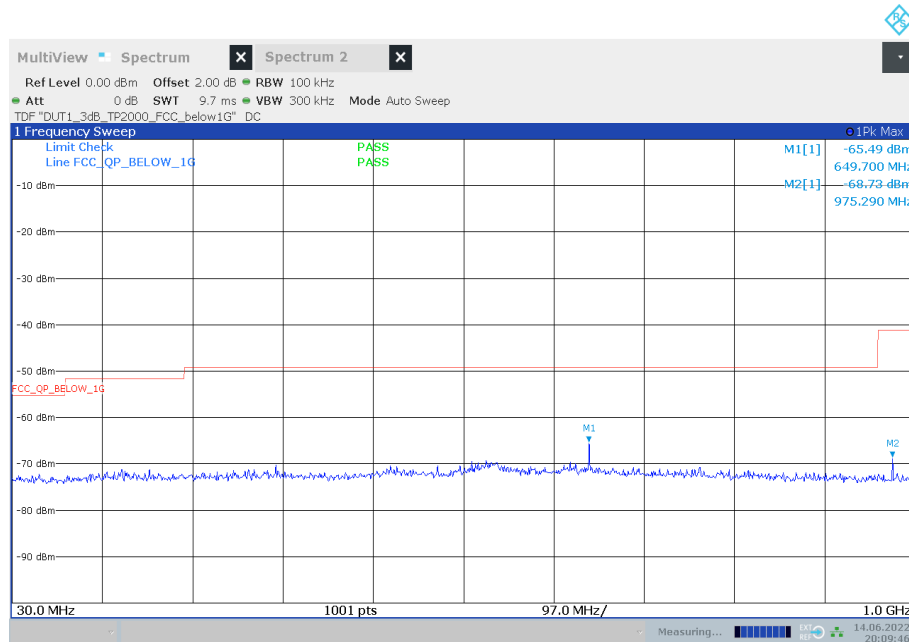

20:09:46 14.06.2022

Radio Technology = WLAN a, Operating Frequency = mid, Measurement range = 1GHz - 26GHz, Subband = U-NII-1 (S02\_161\_AB01)

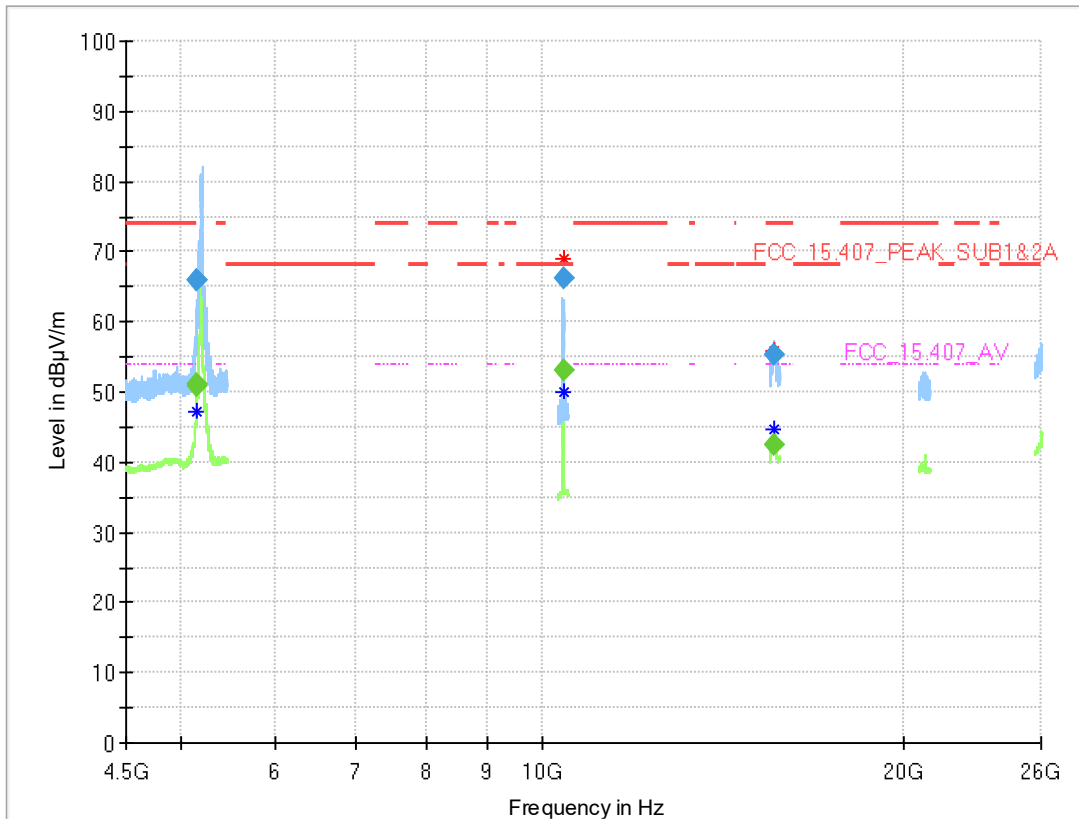

### Final Result

Frequency (MHz)	MaxPeak (dBµV/m)	CAverage (dBµV/m)	Limit (dBµV/m)	Margin (dB)	Meas. Time (ms)	Bandwidth (kHz)	Height (cm)	Pol	Azimuth (deg)	Elevation (deg)	Corr. (dB/m)
5150.000	---	50.7	54.00	3.28	1000.0	1000.000	150.0	V	8.0	88.0	13.5
5150.000	65.8	---	74.00	8.18	1000.0	1000.000	150.0	V	8.0	88.0	13.5
5150.000	---	51.0	---	---	1000.0	1000.000	150.0	V	-1.0	80.0	13.5
5150.000	66.0	---	---	---	1000.0	1000.000	150.0	V	-1.0	80.0	13.5
10399.900	---	53.0	---	---	1000.0	1000.000	150.0	H	81.0	94.0	-11.9
10399.900	66.2	---	68.20	1.97	1000.0	1000.000	150.0	H	81.0	94.0	-11.9
15597.231	---	42.4	54.00	11.62	1000.0	1000.000	150.0	H	125.0	13.0	-1.0
15597.231	55.4	---	74.00	18.59	1000.0	1000.000	150.0	H	125.0	13.0	-1.0

Radio Technology = WLAN a, Operating Frequency = mid, Measurement range = 1GHz - 26GHz, Subband = U-NII-1 (S01\_161\_AD01)

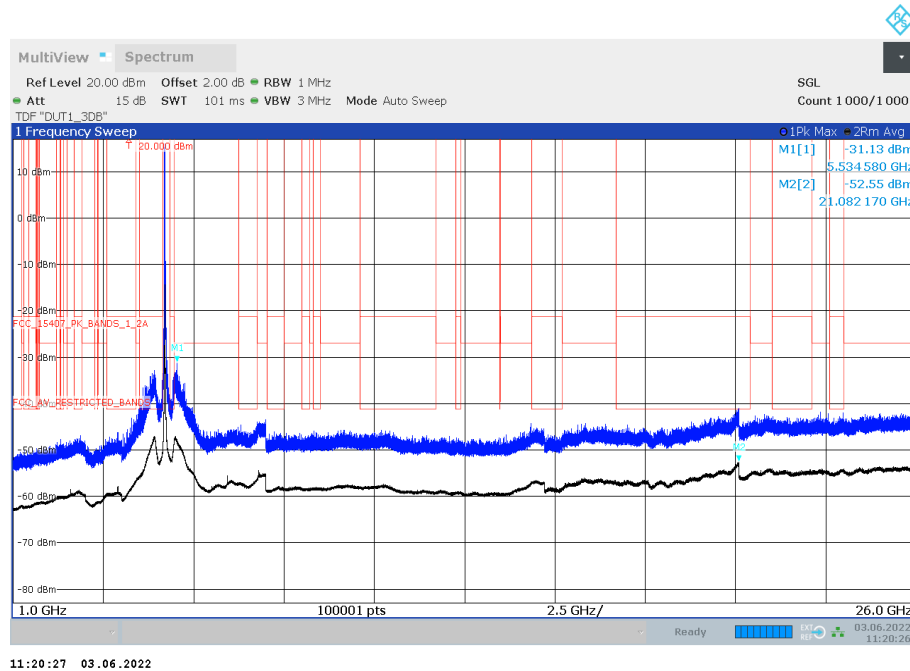

Radio Technology = WLAN a, Operating Frequency = high, Measurement range = 1GHz - 26GHz, Subband = U-NII-1 (S02\_161\_AB01)

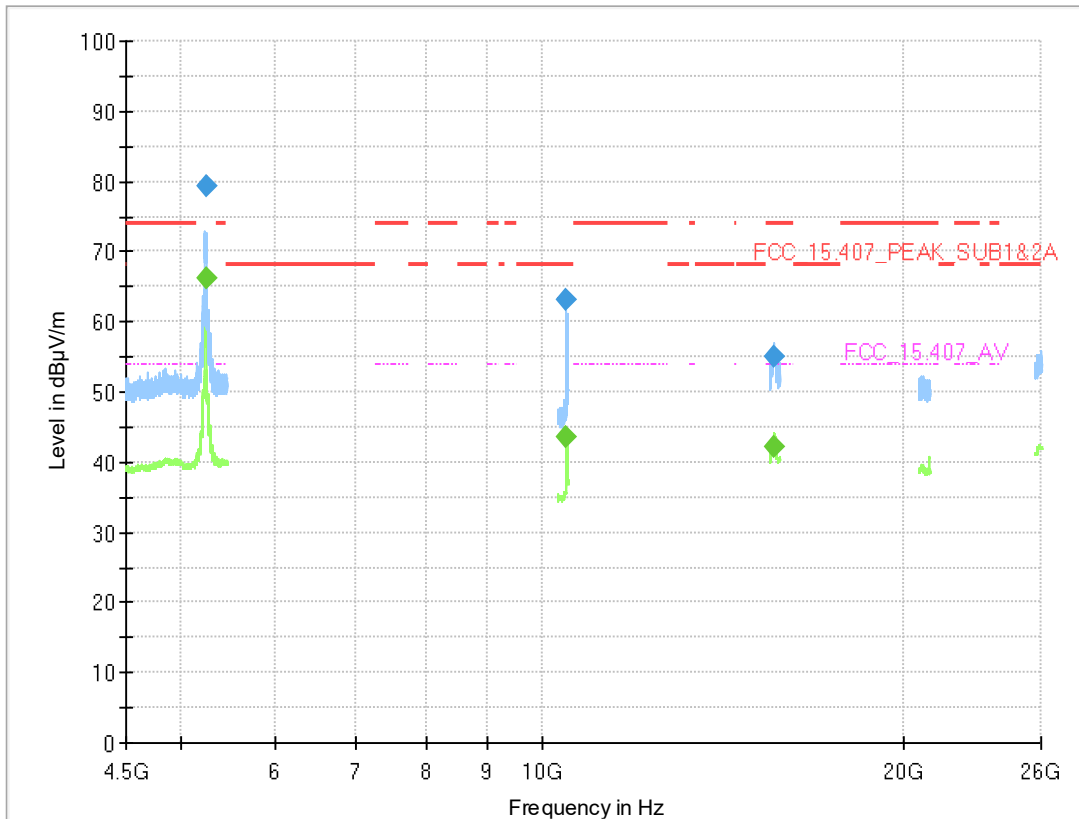

### Final Result

Frequency (MHz)	MaxPeak (dBµV/m)	CAverage (dBµV/m)	Limit (dBµV/m)	Margin (dB)	Meas. Time (ms)	Bandwidth (kHz)	Height (cm)	Pol	Azimuth (deg)	Elevation (deg)	Corr. (dB/m)
5242.400	---	66.1	---	---	1000.0	1000.000	150.0	V	0.0	79.0	13.5
5242.400	79.4	---	---	---	1000.0	1000.000	150.0	V	0.0	79.0	13.5
10474.300	---	43.7	---	---	1000.0	1000.000	150.0	V	-187.0	-15.0	-11.0
10474.300	63.2	---	68.20	5.05	1000.0	1000.000	150.0	V	-187.0	-15.0	-11.0
15593.885	---	42.1	54.00	11.92	1000.0	1000.000	150.0	H	-53.0	15.0	-1.1
15593.885	54.9	---	74.00	19.10	1000.0	1000.000	150.0	H	-53.0	15.0	-1.1



Radio Technology = WLAN a, Operating Frequency = high, Measurement range = 1GHz - 26GHz, Subband = U-NII-1 (S01\_161\_AD01)

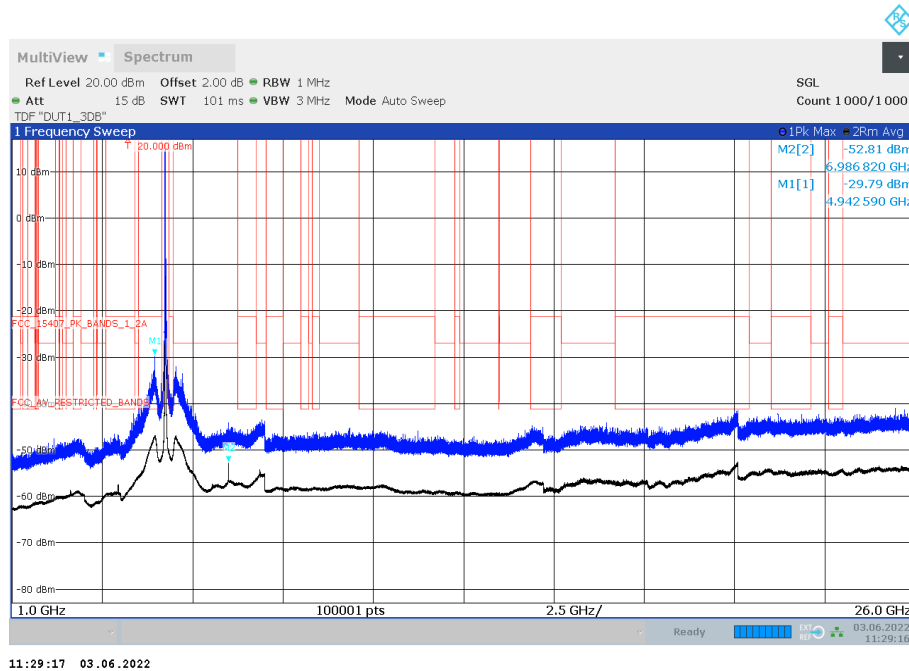

Radio Technology = WLAN a, Operating Frequency = low, Measurement range = 1GHz - 26GHz, Subband = U-NII-2A (S02\_161\_AB01)

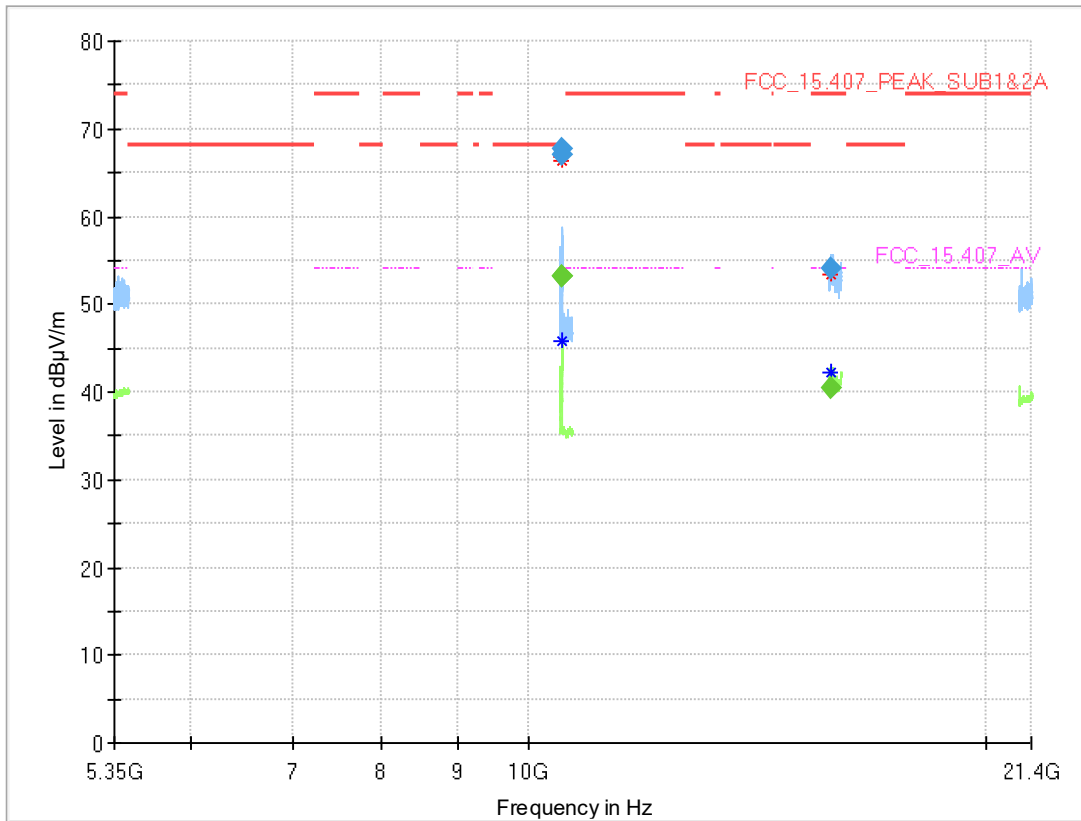

### Final Result

Frequency (MHz)	MaxPeak (dBµV/m)	CAverage (dBµV/m)	Limit (dBµV/m)	Margin (dB)	Meas. Time (ms)	Bandwidth (kHz)	Height (cm)	Pol	Azimuth (deg)	Elevation (deg)	Corr. (dB/m)
10519.100	---	53.1	---	---	1000.0	1000.000	150.0	V	-186.0	-15.0	-11.1
10519.100	67.7	---	68.20	0.54	1000.0	1000.000	150.0	V	-186.0	-15.0	-11.1
10519.700	---	53.2	---	---	1000.0	1000.000	150.0	V	-186.0	-15.0	-11.1
10519.700	67.1	---	68.20	1.12	1000.0	1000.000	150.0	V	-186.0	-15.0	-11.1
15826.900	---	40.4	54.00	13.62	1000.0	1000.000	150.0	H	8.0	0.0	-2.8
15826.900	54.1	---	74.00	19.89	1000.0	1000.000	150.0	H	8.0	0.0	-2.8

Radio Technology = WLAN a, Operating Frequency = low, Measurement range = 1GHz - 26GHz, Subband = U-NII-2A (S01\_161\_AD01)

