

# FCC Measurement/Technical Report on WLAN and Bluetooth Module MAYA W161

FCC ID: XPYMAYAW161  
IC: 8595A-MAYAW161

**Test Report Reference:** MDE\_UBLOX\_2110\_FCC\_01

**Test Laboratory:**

7layers GmbH  
Borsigstrasse 11  
40880 Ratingen  
Germany



Deutsche  
Akkreditierungsstelle  
D-PL-12140-01-01  
D-PL-12140-01-02  
D-PL-12140-01-03

**Note:**

The following test results relate only to the devices specified in this document. This report shall not be reproduced in parts without the written approval of the test laboratory.

**7layers GmbH**

Borsigstraße 11  
40880 Ratingen, Germany  
T +49 (0) 2102 749 0  
F +49 (0) 2102 749 350

Geschäftsführer/  
Managing Directors:  
Frank Spiller  
Bernhard Retka  
Alexandre Norré-Oudard

Registergericht/registered:  
Düsseldorf HRB 75554  
USt-Id.-Nr./VAT-No. DE203159652  
Steuer-Nr./TAX-No. 147/5869/0385

*a Bureau Veritas  
Group Company*

*www.7layers.com*

## Table of Contents

<b>1</b>	<b>Applied Standards and Test Summary</b>	<b>3</b>
1.1	Applied Standards	3
1.2	FCC-IC Correlation Table	4
1.3	Measurement Summary	5
<b>2</b>	<b>Revision History / Signatures</b>	<b>13</b>
<b>3</b>	<b>Administrative Data</b>	<b>14</b>
3.1	Testing Laboratory	14
3.2	Project Data	14
3.3	Applicant Data	14
3.4	Manufacturer Data	15
<b>4</b>	<b>Test object Data</b>	<b>16</b>
4.1	General EUT Description	16
4.2	EUT Main components	17
4.3	Ancillary Equipment	17
4.4	Auxiliary Equipment	18
4.5	EUT Setups	19
4.6	Operating Modes / Test Channels	19
4.7	Product labelling	24
<b>5</b>	<b>Test Results</b>	<b>25</b>
5.1	Conducted Emissions at AC Mains	25
5.2	Occupied Bandwidth (6 dB)	29
5.3	Occupied Bandwidth (99%)	36
5.4	Peak Power Output	43
5.5	Spurious RF Conducted Emissions	51
5.6	Transmitter Spurious Radiated Emissions	64
5.7	Band Edge Compliance Conducted	99
5.8	Band Edge Compliance Radiated	112
5.9	Power Density	135
<b>6</b>	<b>Test Equipment</b>	<b>143</b>
<b>7</b>	<b>Antenna Factors, Cable Loss and Sample Calculations</b>	<b>146</b>
7.1	LISN R&S ESH3-Z5 (150 kHz – 30 MHz)	146
7.2	Antenna R&S HFH2-Z2 (9 kHz – 30 MHz)	147
7.3	Antenna R&S HL562 (30 MHz – 1 GHz)	148
7.4	Antenna R&S HF907 (1 GHz – 18 GHz)	149
7.5	Antenna EMCO 3160-09 (18 GHz – 26.5 GHz)	150
7.6	Antenna EMCO 3160-10 (26.5 GHz – 40 GHz)	151
<b>8</b>	<b>Measurement Uncertainties</b>	<b>152</b>
<b>9</b>	<b>Photo Report</b>	<b>153</b>

## 1 APPLIED STANDARDS AND TEST SUMMARY

### 1.1 APPLIED STANDARDS

#### **Type of Authorization**

Certification for an Intentional Radiator.

#### **Applicable FCC Rules**

Prepared in accordance with the requirements of FCC Rules and Regulations as listed in 47 CFR Ch.1 Parts 2 and 15 (10-1-20 Edition). The following subparts are applicable to the results in this test report.

Part 2, Subpart J - Equipment Authorization Procedures, Certification

Part 15, Subpart C – Intentional Radiators

§ 15.201 Equipment authorization requirement

§ 15.207 Conducted limits

§ 15.209 Radiated emission limits; general requirements

§ 15.247 Operation within the bands 902-928 MHz, 2400-2483.5 MHz

#### **Note:**

The tests were selected and performed with reference to the FCC Public Notice "Guidance for Compliance Measurements on Digital Transmission System, Frequency Hopping Spread Spectrum System, and Hybrid System Devices Operating under Section 15.247 of the FCC Rules, 558074 D01 15.247 Meas Guidance v05r02, 2019-04-02". ANSI C63.10-2013 is applied.

## 1.2 FCC-IC CORRELATION TABLE

### Correlation of measurement requirements for DTS (e.g. WLAN 2.4 GHz, BT LE) equipment from FCC and IC

#### DTS equipment

Measurement	FCC reference	IC reference
Conducted emissions on AC Mains	§ 15.207	RSS-Gen Issue 5: 8.8
Occupied bandwidth	§ 15.247 (a) (2)	RSS-247 Issue 2: 5.2 (a)
Peak conducted output power	§ 15.247 (b) (3), (4)	RSS-247 Issue 2: 5.4 (d)
Transmitter spurious RF conducted emissions	§ 15.247 (d)	RSS-Gen Issue 5: 6.13 / 8.9/8.10; RSS-247 Issue 2: 5.5
Transmitter spurious radiated emissions	§ 15.247 (d); § 15.209 (a)	RSS-Gen Issue 5: 6.13 / 8.9/8.10; RSS-247 Issue 2: 5.5
Band edge compliance	§ 15.247 (d)	RSS-247 Issue 2: 5.5
Power density	§ 15.247 (e)	RSS-247 Issue 2: 5.2 (b)
Antenna requirement	§ 15.203 / 15.204	RSS-Gen Issue 5: 8.3
Receiver spurious emissions	-	-

### 1.3 MEASUREMENT SUMMARY

**47 CFR CHAPTER I FCC PART 15 § 15.207**  
**Subpart C §15.247**

Conducted Emissions at AC Mains

The measurement was performed according to ANSI C63.10 6.2

**Final Result**

<b>OP-Mode</b>	<b>Setup</b>	<b>Date</b>	<b>FCC</b>	<b>IC</b>
Operating mode, Connection to AC mains worst case, via ancillary/auxiliary equipment	S03_161_AB01	2022-06-22	Passed	Passed

**47 CFR CHAPTER I FCC PART 15 Subpart C §15.247 § 15.247 (a) (2)**

Occupied Bandwidth (6 dB)

The measurement was performed according to ANSI C63.10 11.8.1

**Final Result**

<b>OP-Mode</b>	<b>Setup</b>	<b>Date</b>	<b>FCC</b>	<b>IC</b>
Radio Technology, Operating Frequency				
Bluetooth BDR, high	S01_161_AD01	2022-07-07	Passed	Passed
Bluetooth BDR, low	S01_161_AD01	2022-07-07	Passed	Passed
Bluetooth BDR, mid	S01_161_AD01	2022-07-07	Passed	Passed
Bluetooth EDR 2, high	S01_161_AD01	2022-07-07	Passed	Passed
Bluetooth EDR 2, low	S01_161_AD01	2022-07-07	Passed	Passed
Bluetooth EDR 2, mid	S01_161_AD01	2022-07-07	Passed	Passed
Bluetooth EDR 3, high	S01_161_AD01	2022-07-07	Passed	Passed
Bluetooth EDR 3, low	S01_161_AD01	2022-07-07	Passed	Passed
Bluetooth EDR 3, mid	S01_161_AD01	2022-07-07	Passed	Passed
Bluetooth LE 1 Mbps, high	S01_161_AD01	2022-07-08	Passed	Passed
Bluetooth LE 1 Mbps, low	S01_161_AD01	2022-07-08	Passed	Passed
Bluetooth LE 1 Mbps, mid	S01_161_AD01	2022-07-08	Passed	Passed
Bluetooth LE 2 Mbps, high	S01_161_AD01	2022-07-08	Passed	Passed
Bluetooth LE 2 Mbps, low	S01_161_AD01	2022-07-08	Passed	Passed
Bluetooth LE 2 Mbps, mid	S01_161_AD01	2022-07-08	Passed	Passed
WLAN b, high	S01_161_AC01	2022-04-25	Passed	Passed
WLAN b, low	S01_161_AC01	2022-04-25	Passed	Passed
WLAN b, mid	S01_161_AC01	2022-04-25	Passed	Passed
WLAN g, high	S01_161_AC01	2022-04-25	Passed	Passed
WLAN g, low	S01_161_AC01	2022-04-25	Passed	Passed
WLAN g, mid	S01_161_AC01	2022-04-25	Passed	Passed
WLAN n 20 MHz, high	S01_161_AC01	2022-04-25	Passed	Passed
WLAN n 20 MHz, low	S01_161_AC01	2022-04-25	Passed	Passed
WLAN n 20 MHz, mid	S01_161_AC01	2022-04-25	Passed	Passed
WLAN n 40 MHz, high	S01_161_AC01	2022-04-25	Passed	Passed
WLAN n 40 MHz, low	S01_161_AC01	2022-04-25	Passed	Passed
WLAN n 40 MHz, mid	S01_161_AC01	2022-04-25	Passed	Passed

**47 CFR CHAPTER I FCC PART 15 Subpart C §15.247**

**IC RSS-Gen & IC TRC-43;  
Ch. 6.7 & Ch. 8**

Occupied Bandwidth (99%)

The measurement was performed according to ANSI C63.10 6.9.3

**Final Result**

<b>OP-Mode</b>	<b>Setup</b>	<b>Date</b>	<b>FCC</b>	<b>IC</b>
Radio Technology, Operating Frequency				
Bluetooth BDR, high	S01_161_AD01	2022-07-07	Performed	Performed
Bluetooth BDR, low	S01_161_AD01	2022-07-07	Performed	Performed
Bluetooth BDR, mid	S01_161_AD01	2022-07-07	Performed	Performed
Bluetooth EDR 2, high	S01_161_AD01	2022-07-07	Performed	Performed
Bluetooth EDR 2, low	S01_161_AD01	2022-07-07	Performed	Performed
Bluetooth EDR 2, mid	S01_161_AD01	2022-07-07	Performed	Performed
Bluetooth EDR 3, high	S01_161_AD01	2022-07-07	Performed	Performed
Bluetooth EDR 3, low	S01_161_AD01	2022-07-07	Performed	Performed
Bluetooth EDR 3, mid	S01_161_AD01	2022-07-07	Performed	Performed
Bluetooth LE 1 Mbps, high	S01_161_AD01	2022-07-08	Performed	Performed
Bluetooth LE 1 Mbps, low	S01_161_AD01	2022-07-08	Performed	Performed
Bluetooth LE 1 Mbps, mid	S01_161_AD01	2022-07-08	Performed	Performed
Bluetooth LE 2 Mbps, high	S01_161_AD01	2022-07-08	Performed	Performed
Bluetooth LE 2 Mbps, low	S01_161_AD01	2022-07-08	Performed	Performed
Bluetooth LE 2 Mbps, mid	S01_161_AD01	2022-07-08	Performed	Performed
WLAN b, high	S01_161_AC01	2022-04-25	Performed	Performed
WLAN b, low	S01_161_AC01	2022-04-25	Performed	Performed
WLAN b, mid	S01_161_AC01	2022-04-25	Performed	Performed
WLAN g, high	S01_161_AC01	2022-04-25	Performed	Performed
WLAN g, low	S01_161_AC01	2022-04-25	Performed	Performed
WLAN g, mid	S01_161_AC01	2022-04-25	Performed	Performed
WLAN n 20 MHz, high	S01_161_AC01	2022-04-25	Performed	Performed
WLAN n 20 MHz, low	S01_161_AC01	2022-04-25	Performed	Performed
WLAN n 20 MHz, mid	S01_161_AC01	2022-04-25	Performed	Performed
WLAN n 40 MHz, high	S01_161_AC01	2022-04-25	Performed	Performed
WLAN n 40 MHz, low	S01_161_AC01	2022-04-25	Performed	Performed
WLAN n 40 MHz, mid	S01_161_AC01	2022-04-25	Performed	Performed

**47 CFR CHAPTER I FCC PART 15 Subpart C §15.247**

**§ 15.247 (b) (3)**

Peak Power Output

The measurement was performed according to ANSI C63.10  
11.9.1.1, 11.9.2.3.2

**Final Result**

<b>OP-Mode</b> Radio Technology, Operating Frequency, Measurement method	<b>Setup</b>	<b>Date</b>	<b>FCC</b>	<b>IC</b>
Bluetooth BDR, high, conducted	S01_161_AD01	2022-07-07	Passed	Passed
Bluetooth BDR, low, conducted	S01_161_AD01	2022-07-07	Passed	Passed
Bluetooth BDR, mid, conducted	S01_161_AD01	2022-07-07	Passed	Passed
Bluetooth EDR 2, high, conducted	S01_161_AD01	2022-07-07	Passed	Passed
Bluetooth EDR 2, low, conducted	S01_161_AD01	2022-07-07	Passed	Passed
Bluetooth EDR 2, mid, conducted	S01_161_AD01	2022-07-07	Passed	Passed
Bluetooth EDR 3, high, conducted	S01_161_AD01	2022-07-07	Passed	Passed
Bluetooth EDR 3, low, conducted	S01_161_AD01	2022-07-07	Passed	Passed
Bluetooth EDR 3, mid, conducted	S01_161_AD01	2022-07-07	Passed	Passed
Bluetooth LE 1 Mbps, high, conducted	S01_161_AD01	2022-07-08	Passed	Passed
Bluetooth LE 1 Mbps, low, conducted	S01_161_AD01	2022-07-08	Passed	Passed
Bluetooth LE 1 Mbps, mid, conducted	S01_161_AD01	2022-07-08	Passed	Passed
Bluetooth LE 2 Mbps, high, conducted	S01_161_AD01	2022-07-08	Passed	Passed
Bluetooth LE 2 Mbps, low, conducted	S01_161_AD01	2022-07-08	Passed	Passed
Bluetooth LE 2 Mbps, mid, conducted	S01_161_AD01	2022-07-08	Passed	Passed
WLAN b, high, conducted	S01_161_AC01	2022-04-25	Passed	Passed
WLAN b, low, conducted	S01_161_AC01	2022-04-25	Passed	Passed
WLAN b, mid, conducted	S01_161_AC01	2022-04-25	Passed	Passed
WLAN g, high, conducted	S01_161_AC01	2022-04-25	Passed	Passed
WLAN g, low, conducted	S01_161_AC01	2022-04-25	Passed	Passed
WLAN g, mid, conducted	S01_161_AC01	2022-04-25	Passed	Passed
WLAN n 20 MHz, high, conducted	S01_161_AC01	2022-04-25	Passed	Passed
WLAN n 20 MHz, low, conducted	S01_161_AC01	2022-04-25	Passed	Passed
WLAN n 20 MHz, mid, conducted	S01_161_AC01	2022-04-25	Passed	Passed
WLAN n 40 MHz, high, conducted	S01_161_AC01	2022-04-25	Passed	Passed
WLAN n 40 MHz, low, conducted	S01_161_AC01	2022-04-25	Passed	Passed
WLAN n 40 MHz, mid, conducted	S01_161_AC01	2022-04-25	Passed	Passed

**47 CFR CHAPTER I FCC PART 15 Subpart C §15.247**

**§ 15.247 (d)**

Spurious RF Conducted Emissions

The measurement was performed according to ANSI C63.10 11.11

**Final Result**

<b>OP-Mode</b>	<b>Setup</b>	<b>Date</b>	<b>FCC</b>	<b>IC</b>
Radio Technology, Operating Frequency				
Bluetooth BDR, high	S01_161_AD01	2022-07-08	Passed	Passed
Bluetooth BDR, low	S01_161_AD01	2022-07-08	Passed	Passed
Bluetooth BDR, mid	S01_161_AD01	2022-07-08	Passed	Passed
Bluetooth EDR 2, high	S01_161_AD01	2022-07-08	Passed	Passed
Bluetooth EDR 2, low	S01_161_AD01	2022-07-08	Passed	Passed
Bluetooth EDR 2, mid	S01_161_AD01	2022-07-08	Passed	Passed
Bluetooth EDR 3, high	S01_161_AD01	2022-07-08	Passed	Passed
Bluetooth EDR 3, low	S01_161_AD01	2022-07-08	Passed	Passed
Bluetooth EDR 3, mid	S01_161_AD01	2022-07-08	Passed	Passed
Bluetooth LE 1 Mbps, high	S01_161_AD01	2022-07-08	Passed	Passed
Bluetooth LE 1 Mbps, low	S01_161_AD01	2022-07-08	Passed	Passed
Bluetooth LE 1 Mbps, mid	S01_161_AD01	2022-07-08	Passed	Passed
Bluetooth LE 2 Mbps, high	S01_161_AD01	2022-07-08	Passed	Passed
Bluetooth LE 2 Mbps, low	S01_161_AD01	2022-07-08	Passed	Passed
Bluetooth LE 2 Mbps, mid	S01_161_AD01	2022-07-08	Passed	Passed
WLAN b, high	S01_161_AD01	2022-06-17	Passed	Passed
WLAN b, low	S01_161_AD01	2022-06-17	Passed	Passed
WLAN b, mid	S01_161_AD01	2022-06-17	Passed	Passed
WLAN g, high	S01_161_AD01	2022-06-17	Passed	Passed
WLAN g, low	S01_161_AD01	2022-06-17	Passed	Passed
WLAN g, mid	S01_161_AD01	2022-06-17	Passed	Passed
WLAN n 20 MHz, high	S01_161_AD01	2022-06-17	Passed	Passed
WLAN n 20 MHz, low	S01_161_AD01	2022-06-17	Passed	Passed
WLAN n 20 MHz, mid	S01_161_AD01	2022-06-17	Passed	Passed
WLAN n 40 MHz, high	S01_161_AD01	2022-06-17	Passed	Passed
WLAN n 40 MHz, low	S01_161_AD01	2022-06-17	Passed	Passed
WLAN n 40 MHz, mid	S01_161_AD01	2022-06-17	Passed	Passed



**47 CFR CHAPTER I FCC PART 15 Subpart C §15.247**

**§ 15.247 (d)**

Transmitter Spurious Radiated Emissions

The measurement was performed according to ANSI C63.10  
6.4, 6.5, 6.6.5

**Final Result**

<b>OP-Mode</b>	<b>Setup</b>	<b>Date</b>	<b>FCC</b>	<b>IC</b>
Radio Technology, Operating Frequency, Measurement range, Measurement Method				
Bluetooth BDR, high, 1 GHz - 26 GHz, radiated Remark: tested at final output power	S02_161_AB01	2022-07-18	Passed	Passed
Bluetooth BDR, high, 1 GHz - 26 GHz, conducted Remark: tested at final output power	S01_161_AD01	2022-07-18	Passed	Passed
Bluetooth BDR, high, 30 MHz - 1 GHz, radiated Remark: tested at initial output power (worst case)	S02_161_AB01	2022-04-07	Passed	Passed
Bluetooth BDR, high, 30 MHz - 1 GHz, conducted Remark: tested at initial output power (worst case)	S01_161_AD01	2022-06-21	Passed	Passed
Bluetooth BDR, high, 9 kHz - 30 MHz, conducted	S01_161_AA01	2022-07-27	Passed	Passed
Bluetooth BDR, low, 1 GHz - 26 GHz, radiated Remark: tested at initial output power (worst case)	S02_161_AB01	2022-04-17	Passed	Passed
Bluetooth BDR, low, 1 GHz - 26 GHz, conducted Remark: tested at final output power	S01_161_AD01	2022-07-18	Passed	Passed
Bluetooth BDR, low, 30 MHz - 1 GHz, radiated Remark: tested at initial output power (worst case)	S02_161_AB01	2022-04-07	Passed	Passed
Bluetooth BDR, low, 30 MHz - 1 GHz, conducted Remark: tested at initial output power (worst case)	S01_161_AD01	2022-06-21	Passed	Passed
Bluetooth BDR, low, 9 kHz - 30 MHz, conducted	S01_161_AA01	2022-07-27	Passed	Passed
Bluetooth BDR, mid, 1 GHz - 26 GHz, radiated Remark: tested at initial output power (worst case)	S02_161_AB01	2022-04-17	Passed	Passed
Bluetooth BDR, mid, 1 GHz - 26 GHz, conducted Remark: tested at final output power	S01_161_AD01	2022-07-18	Passed	Passed
Bluetooth BDR, mid, 30 MHz - 1 GHz, radiated Remark: tested at initial output power (worst case)	S02_161_AB01	2022-04-07	Passed	Passed
Bluetooth BDR, mid, 30 MHz - 1 GHz, conducted Remark: tested at initial output power (worst case)	S01_161_AD01	2022-06-21	Passed	Passed
Bluetooth BDR, mid, 9 kHz - 30 MHz, radiated Remark: tested at initial output power (worst case)	S02_161_AB01	2022-05-09	Passed	Passed
Bluetooth BDR, mid, 9 kHz - 30 MHz, conducted	S01_161_AA01	2022-07-27	Passed	Passed
Bluetooth EDR 2, high, 1 GHz - 26 GHz, conducted Remark: tested at final output power	S01_161_AD01	2022-07-18	Passed	Passed
Bluetooth EDR 2, low, 1 GHz - 26 GHz, conducted Remark: tested at final output power	S01_161_AD01	2022-07-18	Passed	Passed
Bluetooth EDR 2, mid, 1 GHz - 26 GHz, conducted Remark: tested at final output power	S01_161_AD01	2022-07-18	Passed	Passed
Bluetooth EDR 3, high, 1 GHz - 26 GHz, conducted Remark: tested at final output power	S01_161_AD01	2022-07-18	Passed	Passed
Bluetooth EDR 3, low, 1 GHz - 26 GHz, conducted Remark: tested at final output power	S01_161_AD01	2022-07-18	Passed	Passed
Bluetooth EDR 3, mid, 1 GHz - 26 GHz, conducted Remark: tested at final output power	S01_161_AD01	2022-07-18	Passed	Passed
Bluetooth LE 1 Mbps, high, 1 GHz - 26 GHz, conducted	S01_161_AD01	2022-07-19	Passed	Passed
Bluetooth LE 1 Mbps, low, 1 GHz - 26 GHz, conducted	S01_161_AD01	2022-07-19	Passed	Passed
Bluetooth LE 1 Mbps, mid, 1 GHz - 26 GHz, conducted	S01_161_AD01	2022-07-19	Passed	Passed

**47 CFR CHAPTER I FCC PART 15 Subpart C §15.247**

**§ 15.247 (d)**

Transmitter Spurious Radiated Emissions

The measurement was performed according to ANSI C63.10  
6.4, 6.5, 6.6.5

**Final Result**

<b>OP-Mode</b>	<b>Setup</b>	<b>Date</b>	<b>FCC</b>	<b>IC</b>
Radio Technology, Operating Frequency, Measurement range, Measurement Method				
Bluetooth LE 2 Mbps, high, 1 GHz - 26 GHz, conducted	S01_161_AD01	2022-07-19	Passed	Passed
Bluetooth LE 2 Mbps, low, 1 GHz - 26 GHz, conducted	S01_161_AD01	2022-07-19	Passed	Passed
Bluetooth LE 2 Mbps, mid, 1 GHz - 26 GHz, conducted	S01_161_AD01	2022-07-19	Passed	Passed
WLAN b, high, 1 GHz - 26 GHz, radiated	S02_161_AB01	2022-05-16	Passed	Passed
WLAN b, high, 1 GHz - 26 GHz, conducted	S01_161_AD01	2022-06-15	Passed	Passed
WLAN b, high, 30 MHz - 1 GHz, radiated	S02_161_AB01	2022-04-07	Passed	Passed
WLAN b, high, 30 MHz - 1 GHz, conducted	S01_161_AD01	2022-06-15	Passed	Passed
WLAN b, high, 9 kHz - 30 MHz, conducted	S01_161_AA01	2022-07-27	Passed	Passed
WLAN b, low, 1 GHz - 26 GHz, radiated	S02_161_AB01	2022-05-16	Passed	Passed
WLAN b, low, 1 GHz - 26 GHz, conducted	S01_161_AD01	2022-06-15	Passed	Passed
WLAN b, low, 30 MHz - 1 GHz, radiated	S02_161_AB01	2022-05-09	Passed	Passed
WLAN b, low, 30 MHz - 1 GHz, conducted	S01_161_AD01	2022-06-15	Passed	Passed
WLAN b, low, 9 kHz - 30 MHz, conducted	S01_161_AA01	2022-07-27	Passed	Passed
WLAN b, mid, 1 GHz - 26 GHz, conducted	S01_161_AD01	2022-06-15	Passed	Passed
WLAN b, mid, 30 MHz - 1 GHz, conducted	S01_161_AD01	2022-06-15	Passed	Passed
WLAN b, mid, 9 kHz - 30 MHz, radiated	S02_161_AB01	2022-05-09	Passed	Passed
WLAN b, mid, 9 kHz - 30 MHz, conducted	S01_161_AA01	2022-07-27	Passed	Passed
WLAN g, low, 1 GHz - 26 GHz, conducted	S01_161_AD01	2022-06-15	Passed	Passed
WLAN g, mid, 1 GHz - 26 GHz, conducted	S01_161_AD01	2022-06-15	Passed	Passed
WLAN n 20 MHz, low, 1 GHz - 26 GHz, conducted	S01_161_AD01	2022-06-15	Passed	Passed
WLAN n 20 MHz, mid, 1 GHz - 26 GHz, conducted	S01_161_AD01	2022-06-15	Passed	Passed
WLAN n 40 MHz, mid, 1 GHz - 26 GHz, conducted	S01_161_AD01	2022-06-15	Passed	Passed

**47 CFR CHAPTER I FCC PART 15 Subpart C §15.247**

**§ 15.247 (d)**

Band Edge Compliance Conducted

The measurement was performed according to ANSI C63.10 11.11

**Final Result**

<b>OP-Mode</b> Radio Technology, Operating Frequency, Band Edge	<b>Setup</b>	<b>Date</b>	<b>FCC</b>	<b>IC</b>
Bluetooth BDR, high, high	S01_161_AD01	2022-07-07	Passed	Passed
Bluetooth BDR, low, low	S01_161_AD01	2022-07-07	Passed	Passed
Bluetooth EDR 2, high, high	S01_161_AD01	2022-07-07	Passed	Passed
Bluetooth EDR 2, low, low	S01_161_AD01	2022-07-07	Passed	Passed
Bluetooth EDR 3, high, high	S01_161_AD01	2022-07-07	Passed	Passed
Bluetooth EDR 3, low, low	S01_161_AD01	2022-07-07	Passed	Passed
Bluetooth LE 1 Mbps, high, high	S01_161_AD01	2022-07-08	Passed	Passed
Bluetooth LE 1 Mbps, low, low	S01_161_AD01	2022-07-08	Passed	Passed
Bluetooth LE 2 Mbps, high, high	S01_161_AD01	2022-07-08	Passed	Passed
Bluetooth LE 2 Mbps, low, low	S01_161_AD01	2022-07-08	Passed	Passed
WLAN b, high, high	S01_161_AC01	2022-04-25	Passed	Passed
WLAN b, low, low	S01_161_AC01	2022-04-25	Passed	Passed
WLAN g, high, high	S01_161_AC01	2022-04-25	Passed	Passed
WLAN g, low, low	S01_161_AC01	2022-04-25	Passed	Passed
WLAN n 20 MHz, high, high	S01_161_AC01	2022-04-25	Passed	Passed
WLAN n 20 MHz, low, low	S01_161_AC01	2022-04-25	Passed	Passed
WLAN n 40 MHz, high, high	S01_161_AC01	2022-04-25	Passed	Passed
WLAN n 40 MHz, low, low	S01_161_AC01	2022-04-25	Passed	Passed

**47 CFR CHAPTER I FCC PART 15 Subpart C §15.247**

**§ 15.247 (d)**

Band Edge Compliance Radiated

The measurement was performed according to ANSI C63.10 6.6.5

**Final Result**

<b>OP-Mode</b> Radio Technology, Operating Frequency, Measurement Method	<b>Setup</b>	<b>Date</b>	<b>FCC</b>	<b>IC</b>
Bluetooth BDR, high, radiated	S02_161_AB01	2022-05-11	Passed	Passed
Bluetooth BDR, low + high, conducted	S01_161_AD01	2022-07-08	Passed	Passed
Bluetooth EDR 2, high, radiated	S02_161_AB01	2022-06-07	Passed	Passed
Bluetooth EDR 2, low + high, conducted	S01_161_AD01	2022-07-08	Passed	Passed
Bluetooth EDR 3, high, radiated	S02_161_AB01	2022-06-07	Passed	Passed
Bluetooth EDR 3, low + high, conducted	S01_161_AD01	2022-07-08	Passed	Passed
Bluetooth LE 1 Mbps, low + high, conducted	S01_161_AD01	2022-07-08	Passed	Passed
Bluetooth LE 2 Mbps, high, radiated	S02_161_AB01	2022-06-07	Passed	Passed
Bluetooth LE 2 Mbps, low + high, conducted	S01_161_AD01	2022-07-08	Passed	Passed
WLAN b, high, radiated	S02_161_AB01	2022-05-16	Passed	Passed
WLAN b, low + high, conducted	S01_161_AA01	2022-03-16	Passed	Passed
WLAN g, high, high	S02_161_AB01	2022-05-16	Passed	Passed
WLAN g, low + high, conducted	S01_161_AA01	2022-03-16	Passed	Passed
WLAN n 20 MHz, high, radiated	S02_161_AB01	2022-05-16	Passed	Passed
WLAN n 20 MHz, low + high, conducted	S01_161_AA01	2022-03-16	Passed	Passed
WLAN n 40 MHz, high, radiated	S02_161_AB01	2022-05-16	Passed	Passed
WLAN n 40 MHz, low + high, conducted	S01_161_AA01	2022-03-16	Passed	Passed

**47 CFR CHAPTER I FCC PART 15  
Subpart C §15.247**

**§ 15.247 (e)**

Power Density

The measurement was performed according to ANSI C63.10  
11.10.2, 11.10.7

**Final Result**

<b>OP-Mode</b>	<b>Setup</b>	<b>Date</b>	<b>FCC</b>	<b>IC</b>
Radio Technology, Operating Frequency				
Bluetooth BDR, high	S01_161_AD01	2022-07-07	Passed	Passed
Bluetooth BDR, low	S01_161_AD01	2022-07-07	Passed	Passed
Bluetooth BDR, mid	S01_161_AD01	2022-07-07	Passed	Passed
Bluetooth EDR 2, high	S01_161_AD01	2022-07-07	Passed	Passed
Bluetooth EDR 2, low	S01_161_AD01	2022-07-07	Passed	Passed
Bluetooth EDR 2, mid	S01_161_AD01	2022-07-07	Passed	Passed
Bluetooth EDR 3, high	S01_161_AD01	2022-07-07	Passed	Passed
Bluetooth EDR 3, low	S01_161_AD01	2022-07-07	Passed	Passed
Bluetooth EDR 3, mid	S01_161_AD01	2022-07-07	Passed	Passed
Bluetooth LE 1 Mbps, high	S01_161_AD01	2022-07-08	Passed	Passed
Bluetooth LE 1 Mbps, low	S01_161_AD01	2022-07-08	Passed	Passed
Bluetooth LE 1 Mbps, mid	S01_161_AD01	2022-07-08	Passed	Passed
Bluetooth LE 2 Mbps, high	S01_161_AD01	2022-07-08	Passed	Passed
Bluetooth LE 2 Mbps, low	S01_161_AD01	2022-07-08	Passed	Passed
Bluetooth LE 2 Mbps, mid	S01_161_AD01	2022-07-08	Passed	Passed
WLAN b, high	S01_161_AC01	2022-04-25	Passed	Passed
WLAN b, low	S01_161_AC01	2022-04-25	Passed	Passed
WLAN b, mid	S01_161_AC01	2022-04-25	Passed	Passed
WLAN g, high	S01_161_AC01	2022-04-25	Passed	Passed
WLAN g, low	S01_161_AC01	2022-04-25	Passed	Passed
WLAN g, mid	S01_161_AC01	2022-04-25	Passed	Passed
WLAN n 20 MHz, high	S01_161_AC01	2022-04-25	Passed	Passed
WLAN n 20 MHz, low	S01_161_AC01	2022-04-25	Passed	Passed
WLAN n 20 MHz, mid	S01_161_AC01	2022-04-25	Passed	Passed
WLAN n 40 MHz, high	S01_161_AC01	2022-04-25	Passed	Passed
WLAN n 40 MHz, low	S01_161_AC01	2022-04-25	Passed	Passed
WLAN n 40 MHz, mid	S01_161_AC01	2022-04-25	Passed	Passed

N/A: Not applicable  
N/P: Not performed

2 REVISION HISTORY / SIGNATURES

Report version control			
Version	Release date	Change Description	Version validity
initial	2022-08-08	--	valid
--	--	--	--

COMMENT: -



(responsible for accreditation scope)  
Dipl.-Ing. Daniel Gall

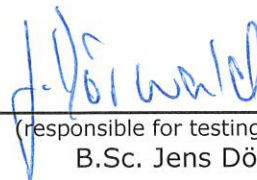

(responsible for testing and report)  
B.Sc. Jens Dörwald



7 layers GmbH, Borsigstr. 11  
40880 Ratingen, Germany  
Phone +49 (0)2102 749 0

### 3 ADMINISTRATIVE DATA

#### 3.1 TESTING LABORATORY

Company Name: 7layers GmbH  
Address: Borsigstr. 11  
40880 Ratingen  
Germany

The test facility is accredited by the following accreditation organisation:

Laboratory accreditation no: DAKKS D-PL-12140-01-01 | -02 | -03  
FCC Designation Number: DE0015  
FCC Test Firm Registration: 929146  
ISED CAB Identifier: DE0007; ISED#: 3699A

Responsible for accreditation scope: Dipl.-Ing. Daniel Gall

Report Template Version: 2021-09-09

#### 3.2 PROJECT DATA

Responsible for testing and report: B.Sc. Jens Dörwald  
Employees who performed the tests: documented internally at 7Layers  
Date of Report: 2022-08-08  
Testing Period: 2022-03-16 to 2022-07-27

#### 3.3 APPLICANT DATA

Company Name: u-blox AG  
Address: Zürcherstrasse 68  
8800 Thalwil  
Switzerland  
Contact Person: Filip Kruzela

### 3.4 MANUFACTURER DATA

Company Name: please see Applicant Data

Address:

Contact Person:

## 4 TEST OBJECT DATA

### 4.1 GENERAL EUT DESCRIPTION

Kind of Device product description	Host-based module with WLAN and Bluetooth technology																																																																							
Product name	MAYA W161-00B-00																																																																							
Type	MAYA W161-00B-00																																																																							
<b>Declared EUT data by the supplier</b>																																																																								
Voltage Type	DC																																																																							
Voltage Level	1.8 V + 3.3 V																																																																							
Antenna / Gain	External / 2 dBi (No antennas were provided for the tests, radiated measurements were performed with 50 Ohm terminations)																																																																							
Tested Modulation Type	BT Classic: GFSK (BDR), Pi/4 DQPSK (EDR 2), 8DPSK (EDR 3) BT LE: GFSK WLANb: DSSS WLANg/n: OFDM																																																																							
Specific product description for the EUT	The EUT is a Bluetooth and WLAN module. In the 2.4 GHz band it supports SISO Mode only. Supported technologies are Bluetooth Classic, Bluetooth Low Energy and WLAN b, g, n 20 and 40 MHz bandwidth.																																																																							
EUT ports (connected cables during testing):	Enclosure Data DC Antenna The EUT is a module with solder pads for surface mounting, so no cables were connected to the EUT itself.																																																																							
Tested datarates	BT Classic: 1 (BDR), 2 (EDR 2) and 3 Mbps (EDR 3) BT LE: 1 and 2 Mbps WLAN b: 1 Mbps, g: 6 Mbps, n: MCS 0																																																																							
Special software used for testing	Scripts were provided by the applicant on a laptop that control a board computer, which sets the test modes of the EUT.																																																																							
Used output power	BT Classic: 8 dBm BT LE: max. power in Direct Test Mode set by applicant's script WLAN: <table border="1" data-bbox="539 1686 1449 1827"> <thead> <tr> <th colspan="11">2.4 GHz</th> </tr> <tr> <th>Mode</th> <th>Ch.1</th> <th>Ch.2</th> <th>Ch.3</th> <th>Ch.4</th> <th>Ch.5</th> <th>Ch.6</th> <th>Ch.7</th> <th>Ch.8</th> <th>Ch.9</th> <th>Ch.10</th> <th>Ch.11</th> </tr> </thead> <tbody> <tr> <td>b</td> <td>18</td> <td></td> <td></td> <td></td> <td></td> <td>18</td> <td></td> <td></td> <td></td> <td></td> <td>18</td> </tr> <tr> <td>g</td> <td>16</td> <td>18</td> <td></td> <td></td> <td></td> <td>18</td> <td></td> <td></td> <td></td> <td>17</td> <td>16</td> </tr> <tr> <td>n20</td> <td>15</td> <td>16</td> <td></td> <td></td> <td></td> <td>16</td> <td></td> <td></td> <td></td> <td>16</td> <td>15</td> </tr> <tr> <td>n40</td> <td>N/A</td> <td>N/A</td> <td></td> <td>14</td> <td>15</td> <td>16</td> <td></td> <td>15</td> <td></td> <td>N/A</td> <td>N/A</td> </tr> </tbody> </table> <p>Note by the laboratory: Testing for Bluetooth Classic started at max power of power control level of test mode and was reduced later on to the final power of 8 dBm. Some radiated spurious emissions tests were not repeated with final power since the original power was worst case.</p>	2.4 GHz											Mode	Ch.1	Ch.2	Ch.3	Ch.4	Ch.5	Ch.6	Ch.7	Ch.8	Ch.9	Ch.10	Ch.11	b	18					18					18	g	16	18				18				17	16	n20	15	16				16				16	15	n40	N/A	N/A		14	15	16		15		N/A	N/A
2.4 GHz																																																																								
Mode	Ch.1	Ch.2	Ch.3	Ch.4	Ch.5	Ch.6	Ch.7	Ch.8	Ch.9	Ch.10	Ch.11																																																													
b	18					18					18																																																													
g	16	18				18				17	16																																																													
n20	15	16				16				16	15																																																													
n40	N/A	N/A		14	15	16		15		N/A	N/A																																																													



## 4.2 EUT MAIN COMPONENTS

Sample Name	Sample Code	Description
MAYA W161 AA01	DE1015158aa01	
Sample Parameter	Value	
Serial No.	M416C1DEB90BB4C0400	
HW Version	04	
SW Version	W16.92.21.p22-16.92.21.p22-MXM5X16298_V0	
Comment		

Sample Name	Sample Code	Description
MAYA W161 AB01	DE1015158ab01	
Sample Parameter	Value	
Serial No.	M416C1DEB90BA740400	
HW Version	04	
SW Version	W16.92.21.p22-16.92.21.p22-MXM5X16298_V0	
Comment		

Sample Name	Sample Code	Description
MAYA W161 AC01	DE1015158ac01	
Sample Parameter	Value	
Serial No.	M416C1DEB90BA840400	
HW Version	04	
SW Version	W16.92.21.p22-16.92.21.p22-MXM5X16298_V0	
Comment		

Sample Name	Sample Code	Description
MAYA W161 AD01	DE1015158ad01	
Sample Parameter	Value	
Serial No.	M416C1DEB90BB240400	
HW Version	04	
SW Version	W16.92.21.p22-16.92.21.p22-MXM5X16298_V0	
Comment		

NOTE: The short description is used to simplify the identification of the EUT in this test report.

## 4.3 ANCILLARY EQUIPMENT

For the purposes of this test report, ancillary equipment is defined as equipment which is used in conjunction with the EUT to provide operational and control features to the EUT. It is necessary to configure the system in a typical fashion, as a customer would normally use it. But nevertheless Ancillary Equipment can influence the test results.

Device	Details (Manufacturer, Type Model, OUT Code)	Description
-	-	-

#### 4.4 AUXILIARY EQUIPMENT

For the purposes of this test report, auxiliary equipment is defined as equipment which is used temporarily to enable operational and control features especially used for the tests of the EUT which is not used during normal operation or equipment that is used during the tests in combination with the EUT but is not subject of this test report. It is necessary to configure the system in a typical fashion, as a customer would normally use it. But nevertheless Auxiliary Equipment can influence the test results.

<b>Device</b>	<b>Details (Manufacturer, Type Model, HW, SW, S/N)</b>	<b>Description</b>
AUX10	Toradex, Ixora, V1.2A, -, 10824714	Board Computer connected to Evaluation board for setting modes
AUX11	Toradex, Ixora, V1.2A, -, 10824739	Board Computer connected to Evaluation board for setting modes
AUX12	DELL, Latitude E7250, -, -, 43283371358	Laptop computer with prepared scripts controlling AUX10
AUX13	DELL, Latitude E7270, 2016, -, 14393036990	Laptop computer with prepared scripts controlling AUX11
AUX1	UBLOX, MAYA-W1 EVK, Rev. A, -, 10000002626314002004	Evaluation Board for module providing ports
AUX2	UBLOX, MAYA-W1 EVK, Rev. A, -, 10000002626314002001	Evaluation Board for module providing ports
AUX3	UBLOX, MAYA-W1 EVK, Rev. A, -, 10000002626314002002	Evaluation Board for module providing ports
AUX4	UBLOX, MAYA-W1 EVK, Rev. A, -, 10000002626314001001	Evaluation Board for module providing ports
ACDC1	Agilent, E3631A, -, -, MY40018563	120 V 60 Hz AC laboratory power supply

## 4.5 EUT SETUPS

This chapter describes the combination of EUTs and equipment used for testing. The rationale for selecting the EUTs, ancillary and auxiliary equipment and interconnecting cables, is to test a representative configuration meeting the requirements of the referenced standards.

Setup	Combination of EUTs	Description and Rationale
S01_161_AC01	MAYA W161 AC01, AUX3, AUX10 + AUX12 or AUX 11 + AUX 13	Conducted Setup
S01_161_AD01	MAYA W161 AD01, AUX4, AUX10 + AUX12 or AUX 11 + AUX 13	Conducted Setup
S01_161_AA01	MAYA W161 AA01, AUX1, AUX10 + AUX12 or AUX 11 + AUX 13	Conducted Setup
S02_161_AB01	MAYA W161 AB01, AUX2	Radiated Setup
S03_161_AB01	MAYA W161 AB01, AUX2, ACDC1	AC Conducted Setup

## 4.6 OPERATING MODES / TEST CHANNELS

This chapter describes the operating modes of the EUTs used for testing.

### WLAN

#### 20 MHz Test Channels:

Channel:

Frequency [MHz]

2.4 GHz ISM 2400 - 2483.5 MHz		
low	mid	high
1	6	11
2412	2437	2462

#### 40 MHz Test Channels:

Channel:

Frequency [MHz]

low	mid	high
3	6	9
2422	2437	2452

### BT Test Channels:

Channel:

Frequency [MHz]

2.4 GHz ISM 2400 - 2483.5 MHz		
low	mid	high
0	39	78
2402	2441	2480

### BT LE Test Channels:

Channel:

Frequency [MHz]

2.4 GHz ISM 2400 - 2483.5 MHz		
low	mid	high
0	19	39
2402	2440	2480

Duty Cycle:

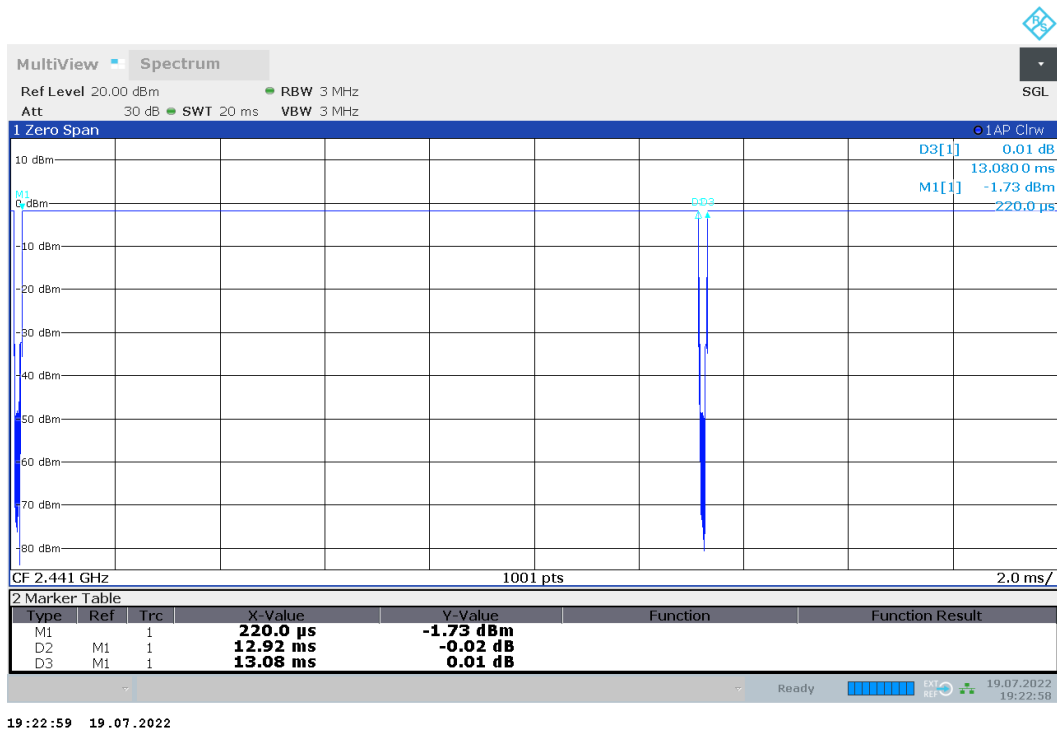

BT GFSK (98.8 %)

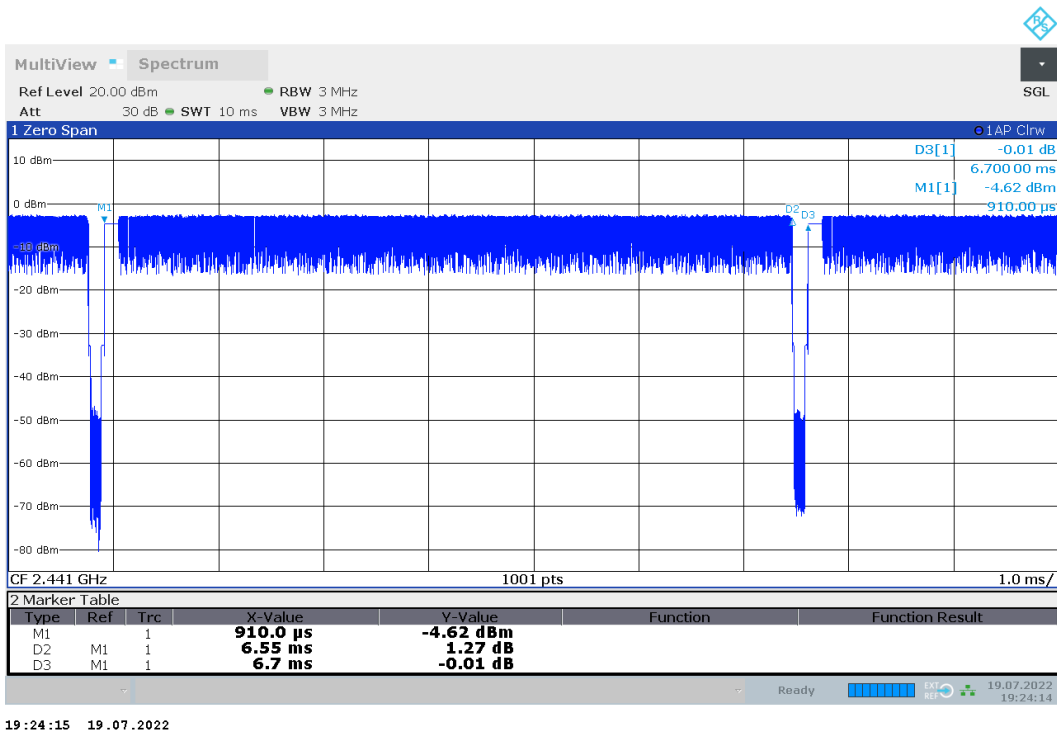

BT Classic Pi/4 DQPSK (97.8 %)

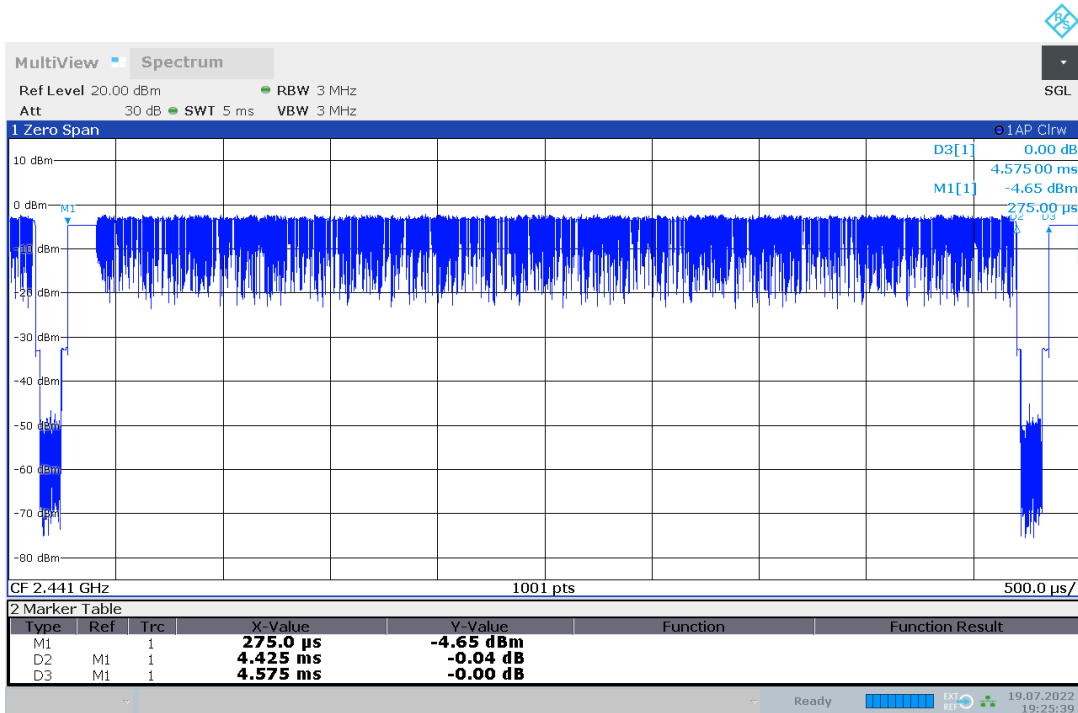

19:25:40 19.07.2022

BT Classic 8DPSK (96.7 %)



16:22:57 08.07.2022

BT LE 1 Mbps (85 %)

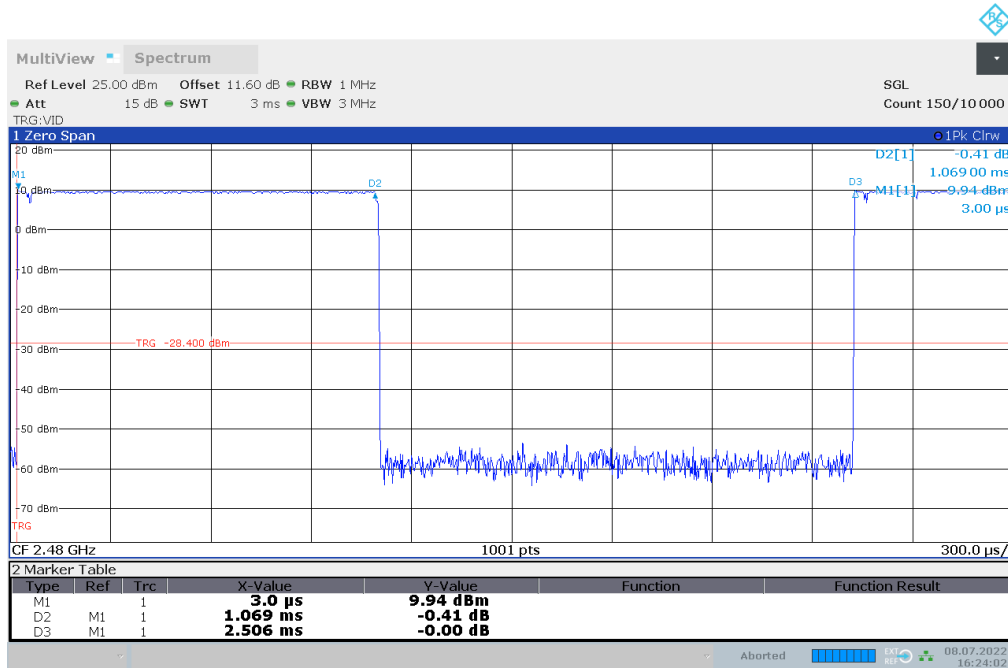

16:24:02 08.07.2022

BT LE 2 Mbps (42.7 %)

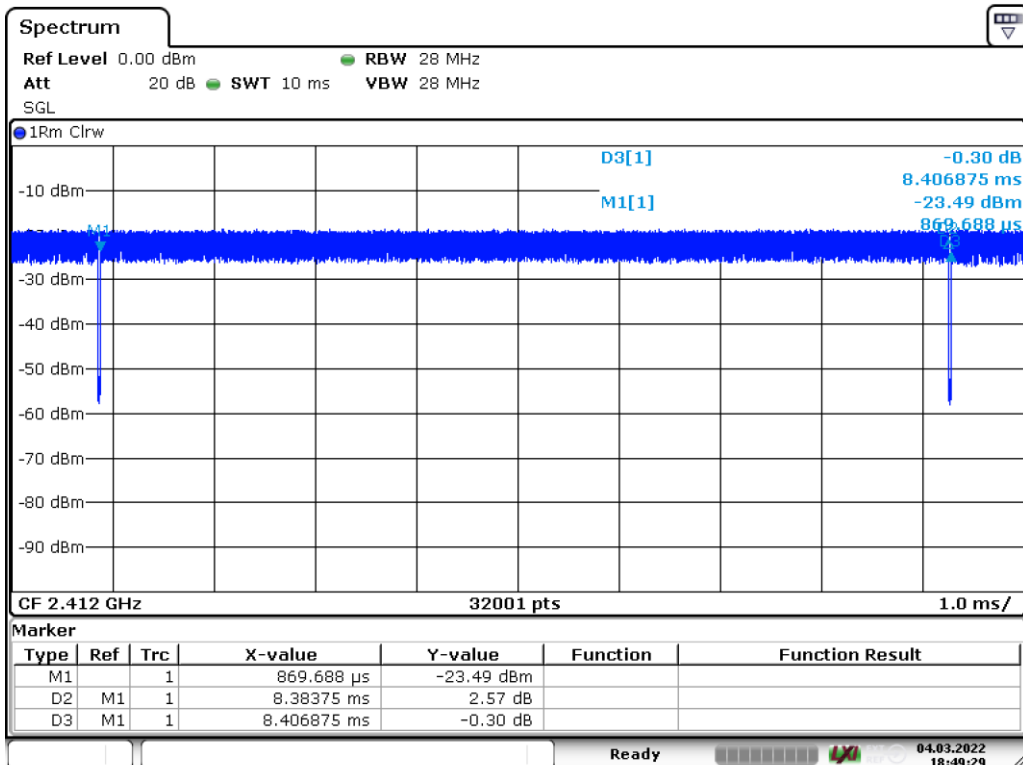

Date: 4.MAR.2022 18:49:29

WLAN b (99.7 %)

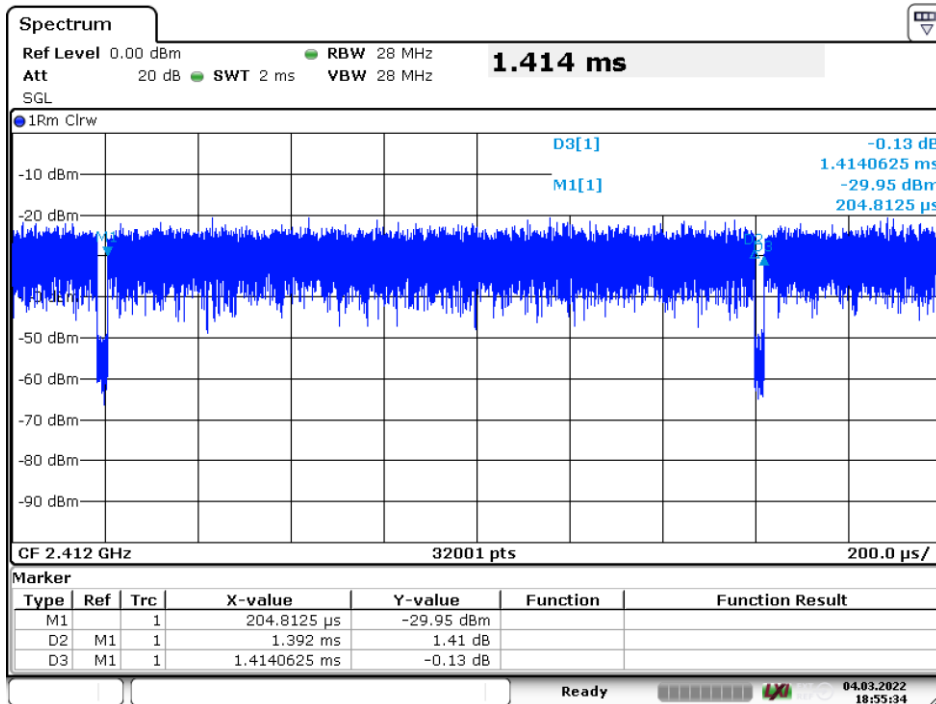

Date: 4.MAR.2022 18:55:34

WLAN g (98.4 %)

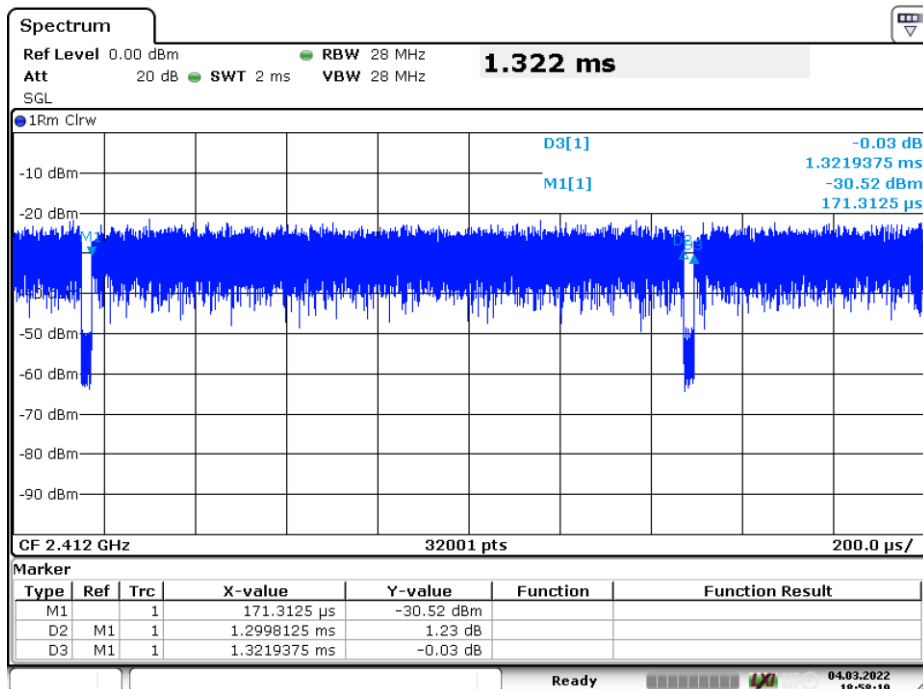

Date: 4.MAR.2022 18:58:20

WLAN n 20 MHz (98.3 %)

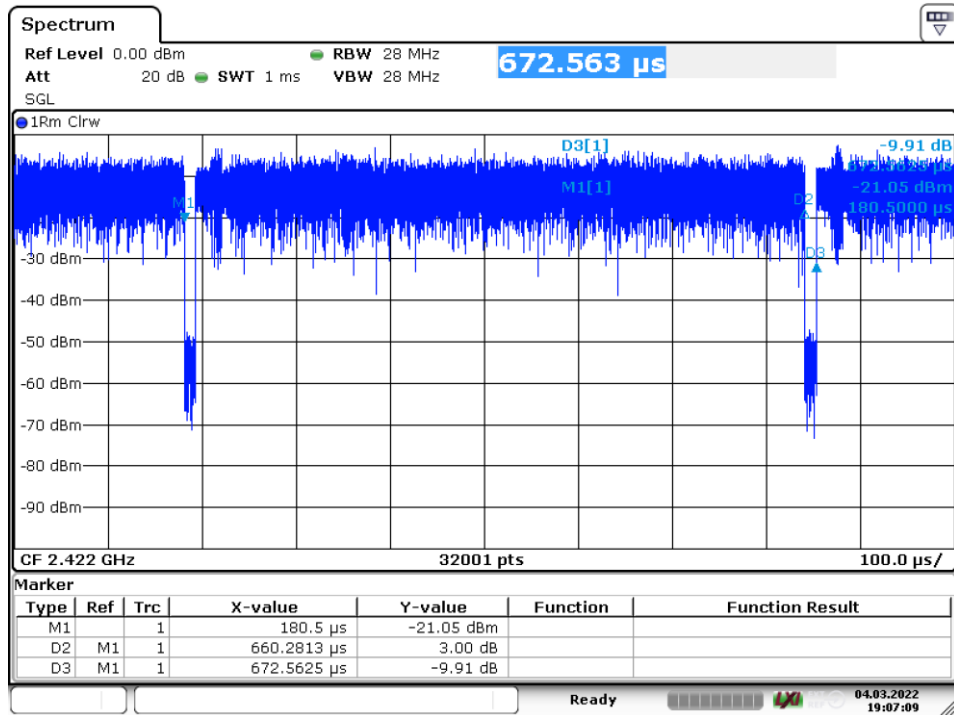

Date: 4.MAR.2022 19:07:09

WLAN n 40 MHz (98.3 %)

## 4.7 PRODUCT LABELLING

### 4.7.1 FCC ID LABEL

Please refer to the documentation of the applicant.

### 4.7.2 LOCATION OF THE LABEL ON THE EUT

Please refer to the documentation of the applicant.



## 5 TEST RESULTS

### 5.1 CONDUCTED EMISSIONS AT AC MAINS

Standard **FCC Part 15 Subpart C**

**The test was performed according to:**  
ANSI C63.10 6.2

#### 5.1.1 TEST DESCRIPTION

The test set-up was made in accordance to the general provisions of ANSI C 63.10. The Equipment Under Test (EUT) was setup in a shielded room to perform the conducted emissions measurements in a typical installation configuration. The EUT was powered from 50 $\mu$ H || 50 Ohm Line Impedance Stabilization Network (LISN). The LISN's unused connections were terminated with 50 Ohm loads.

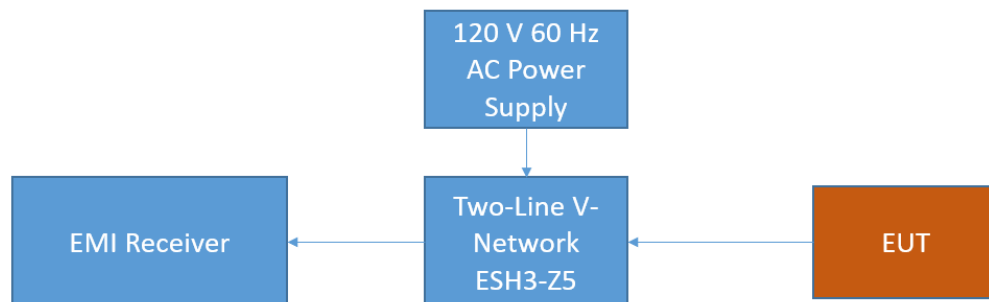

FCC Conducted Emissions on AC

The measurement procedure consists of two steps. It is implemented into the EMI test software EMC-32 from R&S.

#### **Step 1: Preliminary scan**

Intention of this step is, to determine the conducted EMI-profile of the EUT.

EMI receiver settings:

- Detector: Peak – Maxhold & Average
- Frequency range: 150 kHz – 30 MHz
- Frequency steps: 2.5 kHz
- IF-Bandwidth: 9 kHz
- Measuring time / Frequency step: 100 ms (FFT-based)
- Measurement on phase + neutral lines of the power cords

On basis of this preliminary scan the highest amplitudes and the corresponding frequencies relative to the limit are identified. Emissions above the limit and emissions which are in the 10 dB range below the limit are considered.

#### **Step 2: Final measurement**

Intention of this step is, to determine the highest emissions with the settings defined in the test specification for the frequencies identified in step 1.

EMI receiver settings:

- Detector: Quasi-Peak & (CISPR) Average
- IF Bandwidth: 9 kHz
- Measuring time: 1 s / frequency

At each frequency determined in step 1, four measurements are performed in the following combinations:

- 1) Neutral lead - reference ground (PE grounded)
- 2) Phase lead - reference ground (PE grounded)
- 3) Neutral lead - reference ground (PE floating)
- 4) Phase lead - reference ground (PE floating)

The highest value is reported.

### 5.1.2 TEST REQUIREMENTS / LIMITS

FCC Part 15, Subpart C, §15.207

Frequency (MHz)	QP Limits (dBµV)	AV Limits (dBµV)
0.15 - 0.5	66 - 56	56 - 46
0.5 - 5	56	46
5 - 30	60	50

Used conversion factor: Limit (dBµV) = 20 log (Limit (µV)/1µV).

### 5.1.3 TEST PROTOCOL

Temperature: 28 °C  
 Air Pressure: 1008 hPa  
 Humidity: 40 %

Power line	PE	Frequency [MHz]	Measured value QP [dBµV]	Measured value AV [dBµV]	Limit [dBµV]	Margin [dB]
N	GND	12.005	45.7	-	60.0	14.3
N	GND	12.005	-	42.0	50.0	8.0
N	FLO	24.009	46.4	-	60.0	13.6
N	FLO	24.009	-	43.9	50.0	6.1

Remark: Please see next sub-clause for the measurement plot.

### 5.1.4 MEASUREMENT PLOTS

Operating mode = worst case, Connection to AC mains = via ancillary/auxiliary equipment (S03\_161\_AB01)

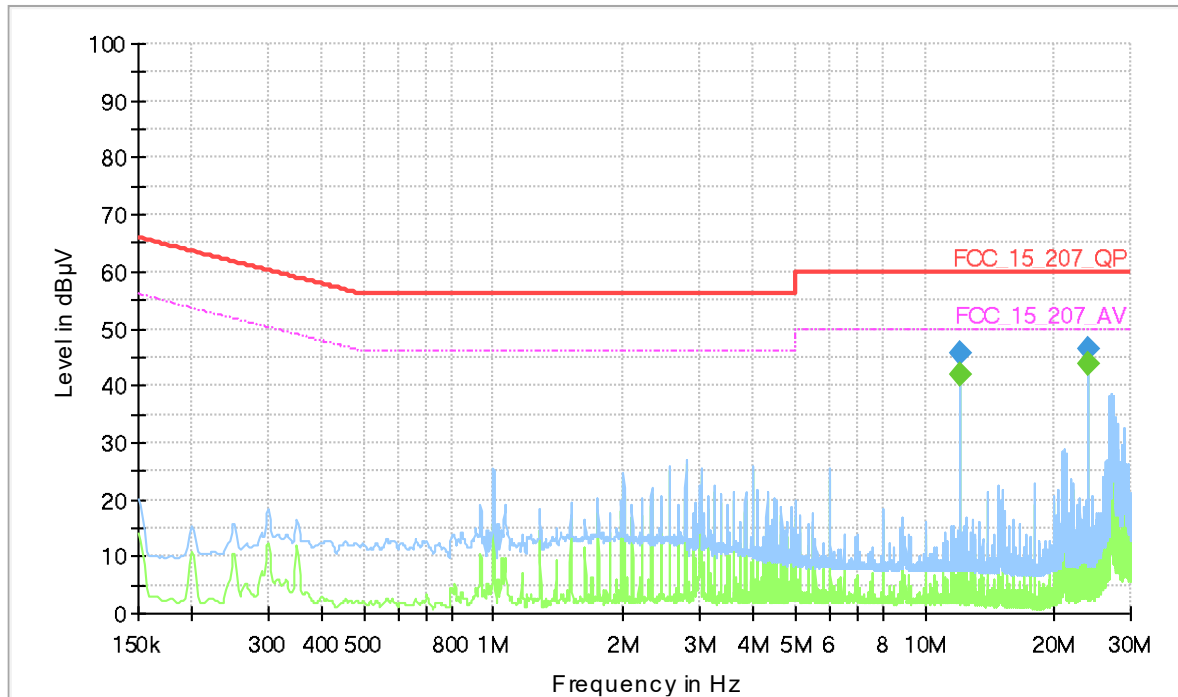

### Final Result

Frequency (MHz)	QuasiPeak (dBµV)	CAverage (dBµV)	Limit (dBµV)	Margin (dB)	Meas. Time	Bandwidth (kHz)	Line	PE	Corr. (dB)
12.005250	---	41.97	50.00	8.03	1000.0	9.000	N	GND	10.7
12.005250	45.69	---	60.00	14.31	1000.0	9.000	N	GND	10.7
24.009000	46.33	---	60.00	13.67	1000.0	9.000	N	FLO	11.2
24.009000	---	43.69	50.00	6.31	1000.0	9.000	N	FLO	11.2

BT GFSK TX on 2441 MHz

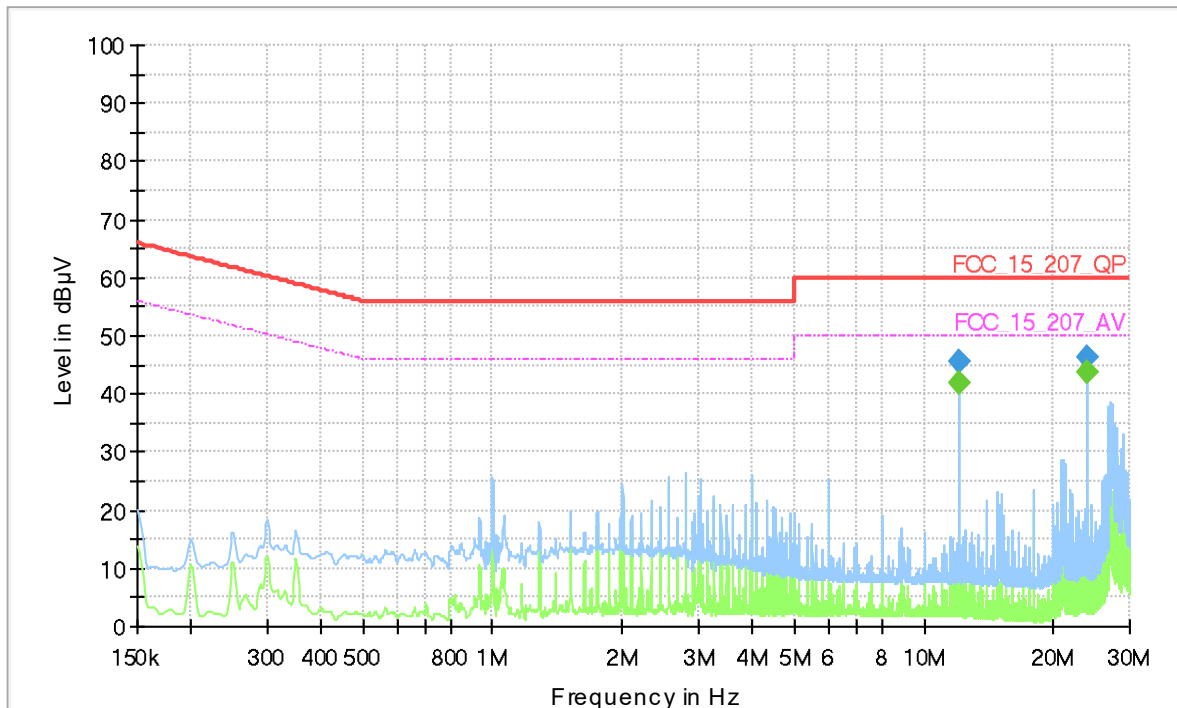

### Final Result

Frequency (MHz)	QuasiPeak (dBµV)	CAverage (dBµV)	Limit (dBµV)	Margin (dB)	Meas. Time	Bandwidth (kHz)	Line	PE	Corr. (dB)
12.005250	---	42.01	50.00	7.99	1000.0	9.000	N	GND	10.7
12.005250	45.70	---	60.00	14.30	1000.0	9.000	N	GND	10.7
24.009000	46.35	---	60.00	13.65	1000.0	9.000	N	FLO	11.2
24.009000	---	43.91	50.00	6.09	1000.0	9.000	N	FLO	11.2

WLAN mode b TX on 2412 MHz

### 5.1.5 TEST EQUIPMENT USED

- Conducted Emissions FCC

## 5.2 OCCUPIED BANDWIDTH (6 DB)

Standard **FCC Part 15 Subpart C**

**The test was performed according to:**  
ANSI C63.10 11.8.1

### 5.2.1 TEST DESCRIPTION

The Equipment Under Test (EUT) was set up to perform the occupied bandwidth measurements.

The reference level is the level of the highest amplitude signal observed from the transmitter at either the fundamental frequency or first-order modulation products in all typical modes of operation, including the unmodulated carrier, even if atypical.

The results recorded were measured with the modulation which produce the worst-case (smallest) emission bandwidth.

The EUT was connected to the test system as described in the block diagram below. The complete attenuation of the measurement path is known and considered.

Analyser settings:

- Resolution Bandwidth (RBW): 100 kHz
- Video Bandwidth (VBW): 300 kHz
- Span: Two times nominal bandwidth
- Trace: Maxhold
- Sweeps: Till stable (min. 500, max. 15000)
- Sweeptime: Auto
- Detector: Peak

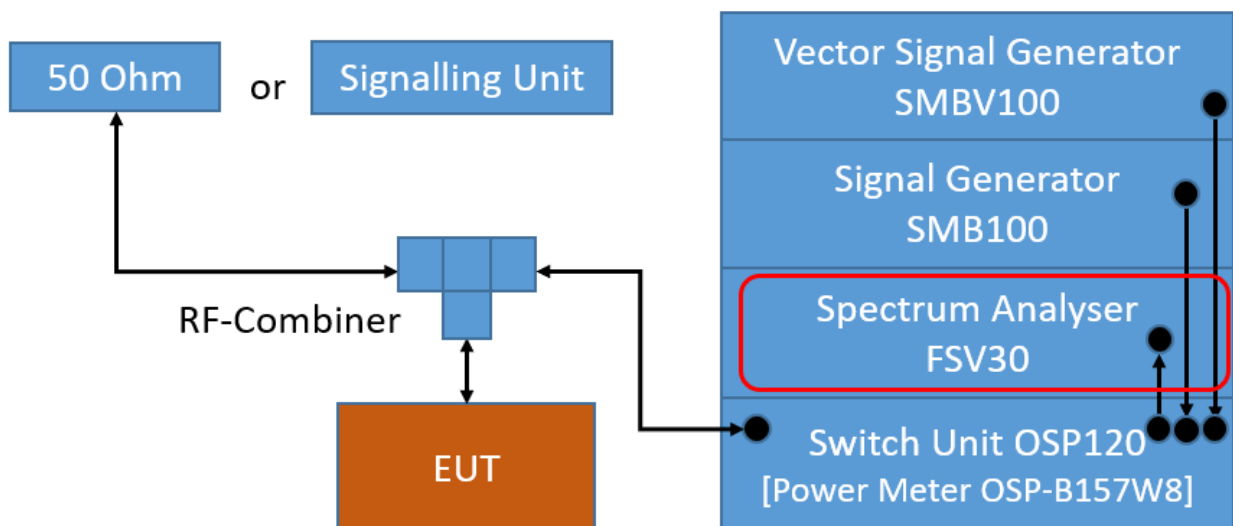

TS8997; Channel Bandwidth

## 5.2.2 TEST REQUIREMENTS / LIMITS

FCC Part 15, Subpart C, §15.247 (a) (2)

Systems using digital modulation techniques may operate in the 902-928 MHz and 2400-2483.5 MHz bands. The minimum 6 dB bandwidth shall be at least 500 kHz.

## 5.2.3 TEST PROTOCOL

Ambient temperature: 23-25 °C  
 Air Pressure: 990-1024 hPa  
 Humidity: 30-40%  
 BT Classic GFSK

Band / Mode	Channel No.	Frequency [MHz]	6 dB Bandwidth [MHz]	Limit [MHz]	Margin to Limit [MHz]
2.4 GHz ISM	0	2402	0.535	0.5	0.035
	39	2441	0.535	0.5	0.035
	78	2480	0.535	0.5	0.035

BT Classic Pi/4 DQPSK

Band / Mode	Channel No.	Frequency [MHz]	6 dB Bandwidth [MHz]	Limit [MHz]	Margin to Limit [MHz]
2.4 GHz ISM	0	2402	1.109	0.5	0.609
	39	2441	1.109	0.5	0.609
	78	2480	1.109	0.5	0.609

BT Classic 8DPSK

Band	Channel No.	Frequency [MHz]	6 dB Bandwidth [MHz]	Limit [MHz]	Margin to Limit [MHz]
2.4 GHz ISM	0	2402	1.109	0.5	0.609
	39	2441	1.109	0.5	0.609
	78	2480	1.109	0.5	0.609

BT LE 1 Mbit/s

Band / Mode	Channel No.	Frequency [MHz]	6 dB Bandwidth [MHz]	Limit [MHz]	Margin to Limit [MHz]
2.4 GHz ISM	0	2402	0.792	0.5	0.292
	19	2440	0.776	0.5	0.276
	39	2480	0.776	0.5	0.276

BT LE 2 Mbit/s

Band / Mode	Channel No.	Frequency [MHz]	6 dB Bandwidth [MHz]	Limit [MHz]	Margin to Limit [MHz]
2.4 GHz ISM	0	2402	1.416	0.5	0.916
	19	2440	1.416	0.5	0.916
	39	2480	1.493	0.5	0.993

WLAN b-Mode; 20 MHz; 1 Mbit/s

Band	Channel No.	Frequency [MHz]	6 dB Bandwidth [MHz]	Limit [MHz]	Margin to Limit [MHz]
2.4 GHz ISM	1	2412	9.2	0.5	8.7
	6	2437	9.2	0.5	8.7
	11	2462	9.2	0.5	8.7

WLAN g-Mode; 20 MHz; 6 Mbit/s

Band	Channel No.	Frequency [MHz]	6 dB Bandwidth [MHz]	Limit [MHz]	Margin to Limit [MHz]
2.4 GHz ISM	1	2412	16.5	0.5	16.0
	6	2437	16.5	0.5	16.0
	11	2462	16.5	0.5	16.0

WLAN n-Mode; 20 MHz; MCS0

Band	Channel No.	Frequency [MHz]	6 dB Bandwidth [MHz]	Limit [MHz]	Margin to Limit [MHz]
2.4 GHz ISM	1	2412	17.7	0.5	17.2
	6	2437	16.5	0.5	16.0
	11	2462	16.5	0.5	16.0

WLAN n-Mode; 40 MHz; MCS0

Band	Channel No.	Frequency [MHz]	6 dB Bandwidth [MHz]	Limit [MHz]	Margin to Limit [MHz]
2.4 GHz ISM	3	2422	35.9	0.5	35.4
	6	2437	35.9	0.5	35.4
	9	2452	35.9	0.5	35.4

Remark: Please see next sub-clause for the measurement plot.

#### 5.2.4 MEASUREMENT PLOT (EXAMPLE PLOT, SHOWING WORST CASE, IF APPLICABLE)

Radio Technology = Bluetooth BDR, Operating Frequency = mid (S01\_161\_AD01)

##### 6 dB Bandwidth

DUT Frequency (MHz)	Bandwidth (MHz)	Limit Min (MHz)	Limit Max (MHz)	Band Edge Left (MHz)	Band Edge Right (MHz)	Max Level (dBm)	Result
2441.000000	0.534654	0.500000	---	2440.742574	2441.277228	6.4	PASS

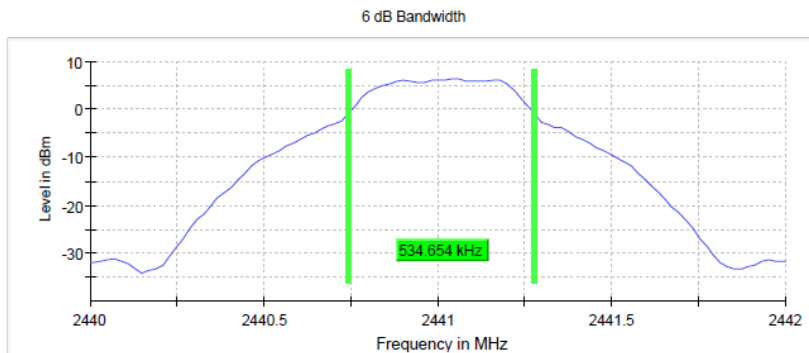

Setting	Instrument Value
Start Frequency	2.44000 GHz
Stop Frequency	2.44200 GHz
Span	2.000 MHz
RBW	100.000 kHz
VBW	300.000 kHz
SweepPoints	101
Sweptime	41.830 $\mu$ s
Reference Level	10.000 dBm
Attenuation	20.000 dB
Detector	MaxPeak
SweepCount	100
Filter	3 dB
Trace Mode	Max Hold
SweepType	FFT
Preamp	off
Stablemode	Trace
Stablevalue	0.50 dB
Run	12 / max. 150
Stable	5 / 5
Max Stable Difference	0.09 dB

Radio Technology = Bluetooth EDR 2, Operating Frequency = mid  
(S01\_161\_AD01)

**6 dB Bandwidth**

DUT Frequency (MHz)	Bandwidth (MHz)	Limit Min (MHz)	Limit Max (MHz)	Band Edge Left (MHz)	Band Edge Right (MHz)	Max Level (dBm)	Result
2441.000000	1.108910	0.500000	---	2440.465347	2441.574257	2.9	PASS

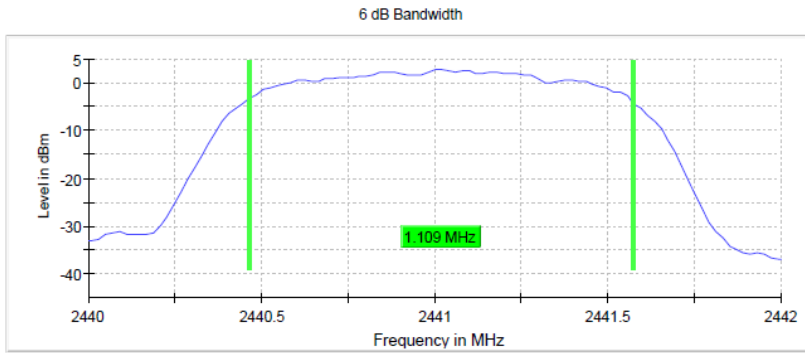

Setting	Instrument Value
Start Frequency	2.44000 GHz
Stop Frequency	2.44200 GHz
Span	2.000 MHz
RBW	100.000 kHz
VBW	300.000 kHz
SweepPoints	101
Sweeptime	41.830 $\mu$ s
Reference Level	10.000 dBm
Attenuation	20.000 dB
Detector	MaxPeak
SweepCount	100
Filter	3 dB
Trace Mode	Max Hold
SweepType	FFT
Preamp	off
Stablemode	Trace
Stablevalue	0.50 dB
Run	24 / max. 150
Stable	5 / 5
Max Stable Difference	0.04 dB

Radio Technology = Bluetooth EDR 3, Operating Frequency = mid  
(S01\_161\_AD01)

**6 dB Bandwidth**

DUT Frequency (MHz)	Bandwidth (MHz)	Limit Min (MHz)	Limit Max (MHz)	Band Edge Left (MHz)	Band Edge Right (MHz)	Max Level (dBm)	Result
2441.000000	1.089108	0.500000	---	2440.465347	2441.554455	2.9	PASS

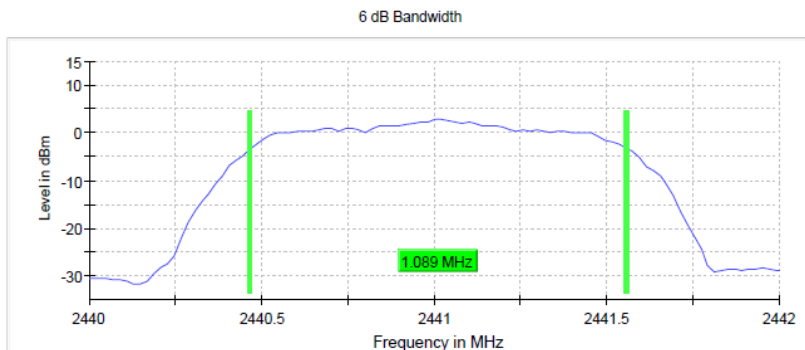

Setting	Instrument Value
Start Frequency	2.44000 GHz
Stop Frequency	2.44200 GHz
Span	2.000 MHz
RBW	100.000 kHz
VBW	300.000 kHz
SweepPoints	101
Sweeptime	41.830 $\mu$ s
Reference Level	10.000 dBm
Attenuation	20.000 dB
Detector	MaxPeak
SweepCount	100
Filter	3 dB
Trace Mode	Max Hold
SweepType	FFT
Preamp	off
Stablemode	Trace
Stablevalue	0.50 dB
Run	12 / max. 150
Stable	5 / 5
Max Stable Difference	0.04 dB



Radio Technology = Bluetooth LE 1 Mbps, Operating Frequency = mid  
(S01\_161\_AD01)

**6 dB Bandwidth**

DUT Frequency (MHz)	Bandwidth (MHz)	Limit Min (MHz)	Limit Max (MHz)	Band Edge Left (MHz)	Band Edge Right (MHz)	Max Level (dBm)	Result
2440.000000	0.776238	0.500000	---	2439.619802	2440.396040	6.3	PASS

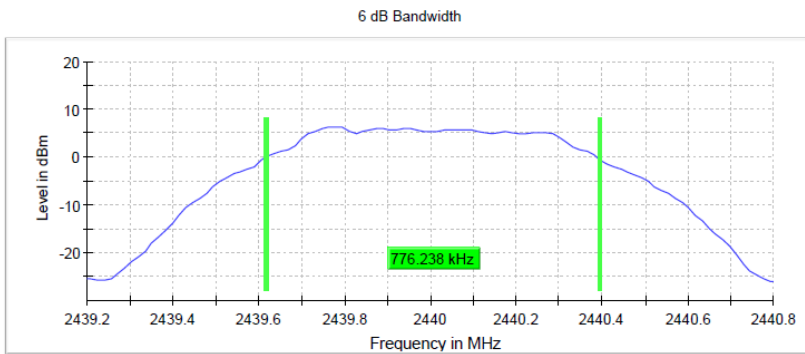

Setting	Instrument Value
Start Frequency	2.43920 GHz
Stop Frequency	2.44080 GHz
Span	1.600 MHz
RBW	100.000 kHz
VBW	300.000 kHz
SweepPoints	101
Sweeptime	41.920 $\mu$ s
Reference Level	0.000 dBm
Attenuation	10.000 dB
Detector	MaxPeak
SweepCount	100
Filter	3 dB
Trace Mode	Max Hold
SweepType	FFT
Preamp	off
Stablemode	Trace
Stablevalue	0.50 dB
Run	16 / max. 150
Stable	5 / 5
Max Stable Difference	0.09 dB

Radio Technology = Bluetooth LE 2 Mbps, Operating Frequency = mid  
(S01\_161\_AD01)

**6 dB Bandwidth**

DUT Frequency (MHz)	Bandwidth (MHz)	Limit Min (MHz)	Limit Max (MHz)	Band Edge Left (MHz)	Band Edge Right (MHz)	Max Level (dBm)	Result
2440.000000	1.415842	0.500000	---	2439.304950	2440.720792	4.4	PASS

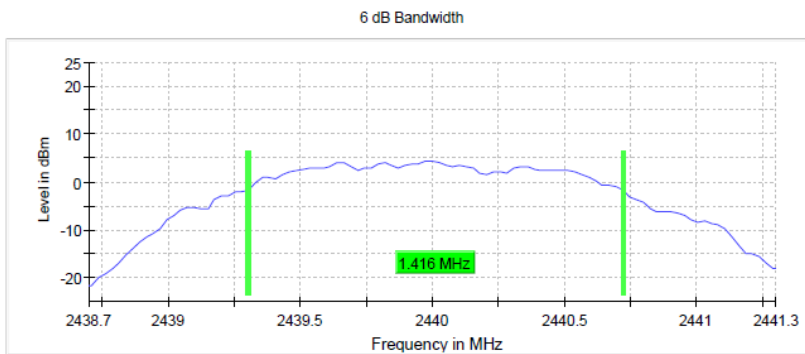

Setting	Instrument Value
Start Frequency	2.43870 GHz
Stop Frequency	2.44130 GHz
Span	2.600 MHz
RBW	100.000 kHz
VBW	300.000 kHz
SweepPoints	101
Sweeptime	41.890 $\mu$ s
Reference Level	0.000 dBm
Attenuation	10.000 dB
Detector	MaxPeak
SweepCount	100
Filter	3 dB
Trace Mode	Max Hold
SweepType	FFT
Preamp	off
Stablemode	Trace
Stablevalue	0.50 dB
Run	13 / max. 150
Stable	5 / 5
Max Stable Difference	0.03 dB

Radio Technology = WLAN b, Operating Frequency = mid  
(S01\_161\_AC01)

**6 dB Bandwidth**

DUT Frequency (MHz)	Bandwidth (MHz)	Limit Min (MHz)	Limit Max (MHz)	Band Edge Left (MHz)	Band Edge Right (MHz)	Max Level (dBm)	Result
2437.000000	9.150000	0.500000	---	2432.425000	2441.575000	9.0	PASS

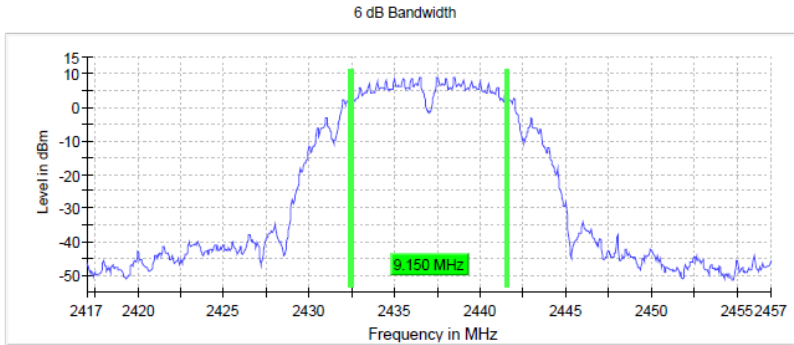

Setting	Instrument Value
Start Frequency	2.41700 GHz
Stop Frequency	2.45700 GHz
Span	40.000 MHz
RBW	100.000 kHz
VBW	300.000 kHz
SweepPoints	800
SweepTime	1.040 ms
Reference Level	0.000 dBm
Attenuation	10.000 dB
Detector	MaxPeak
SweepCount	100
Filter	3 dB
Trace Mode	Max Hold
SweepType	Sweep
Preamp	off
Stablemode	Trace
Stablevalue	0.50 dB
Run	15 / max. 150
Stable	5 / 5
Max Stable Difference	0.23 dB

Radio Technology = WLAN g, Operating Frequency = mid  
(S01\_161\_AC01)

**6 dB Bandwidth**

DUT Frequency (MHz)	Bandwidth (MHz)	Limit Min (MHz)	Limit Max (MHz)	Band Edge Left (MHz)	Band Edge Right (MHz)	Max Level (dBm)	Result
2437.000000	16.450000	0.500000	---	2428.775000	2445.225000	7.0	PASS

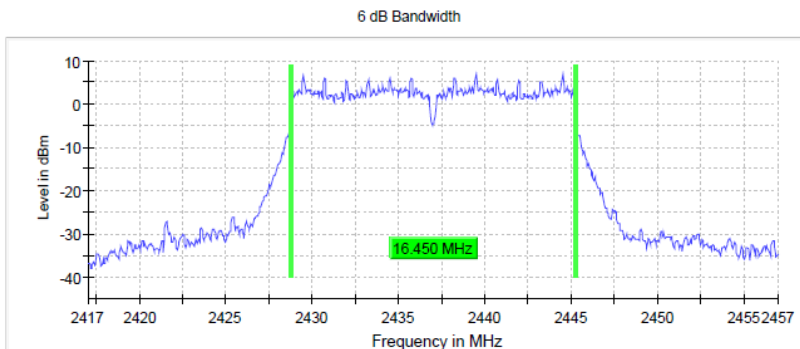

Setting	Instrument Value
Start Frequency	2.41700 GHz
Stop Frequency	2.45700 GHz
Span	40.000 MHz
RBW	100.000 kHz
VBW	300.000 kHz
SweepPoints	800
SweepTime	1.040 ms
Reference Level	10.000 dBm
Attenuation	20.000 dB
Detector	MaxPeak
SweepCount	100
Filter	3 dB
Trace Mode	Max Hold
SweepType	Sweep
Preamp	off
Stablemode	Trace
Stablevalue	0.50 dB
Run	29 / max. 150
Stable	5 / 5
Max Stable Difference	0.25 dB

Radio Technology = WLAN n 20 MHz, Operating Frequency = mid  
(S01\_161\_AC01)

**6 dB Bandwidth**

DUT Frequency (MHz)	Bandwidth (MHz)	Limit Min (MHz)	Limit Max (MHz)	Band Edge Left (MHz)	Band Edge Right (MHz)	Max Level (dBm)	Result
2437.000000	16.450000	0.500000	---	2428.775000	2445.225000	5.1	PASS

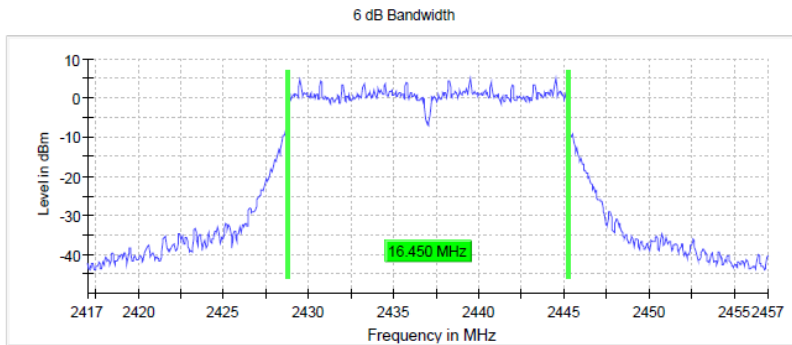

Setting	Instrument Value
Start Frequency	2.41700 GHz
Stop Frequency	2.45700 GHz
Span	40.000 MHz
RBW	100.000 kHz
VBW	300.000 kHz
SweepPoints	800
Sweeptime	1.040 ms
Reference Level	0.000 dBm
Attenuation	10.000 dB
Detector	MaxPeak
SweepCount	100
Filter	3 dB
Trace Mode	Max Hold
Sweeptype	Sweep
Preamp	off
Stablemode	Trace
Stablevalue	0.50 dB
Run	31 / max. 150
Stable	5 / 5
Max Stable Difference	0.38 dB

Radio Technology = WLAN n 40 MHz, Operating Frequency = mid  
(S01\_161\_AC01)

**6 dB Bandwidth**

DUT Frequency (MHz)	Bandwidth (MHz)	Limit Min (MHz)	Limit Max (MHz)	Band Edge Left (MHz)	Band Edge Right (MHz)	Max Level (dBm)	Result
2437.000000	35.900000	0.500000	---	2419.025000	2454.925000	2.4	PASS

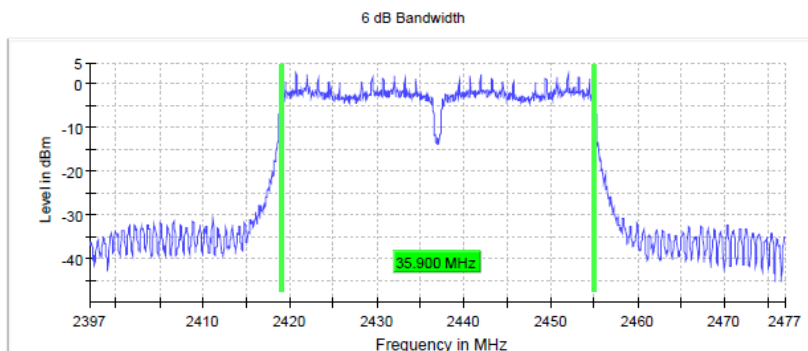

Setting	Instrument Value
Start Frequency	2.39700 GHz
Stop Frequency	2.47700 GHz
Span	80.000 MHz
RBW	100.000 kHz
VBW	300.000 kHz
SweepPoints	1600
Sweeptime	1.600 ms
Reference Level	0.000 dBm
Attenuation	10.000 dB
Detector	MaxPeak
SweepCount	100
Filter	3 dB
Trace Mode	Max Hold
Sweeptype	Sweep
Preamp	off
Stablemode	Trace
Stablevalue	0.50 dB
Run	58 / max. 150
Stable	5 / 5
Max Stable Difference	0.17 dB

**5.2.5 TEST EQUIPMENT USED**

- R&S TS8997

### 5.3 OCCUPIED BANDWIDTH (99%)

Standard **FCC Part 15 Subpart C**

**The test was performed according to:**  
ANSI C63.10 6.9.3

#### 5.3.1 TEST DESCRIPTION

The Equipment Under Test (EUT) was set up to perform the occupied bandwidth measurements.

The reference level is the level of the highest amplitude signal observed from the transmitter at either the fundamental frequency or first-order modulation products in all typical modes of operation, including the unmodulated carrier, even if atypical.

The EUT was connected to the test system as described in the block diagram below. The complete attenuation of the measurement path is known and considered.

Analyser settings:

- Resolution Bandwidth (RBW): 1 to 5 % of the OBW
- Video Bandwidth (VBW):  $\geq 3$  times the RBW
- Span: 1.5 to 5 times the OBW
- Trace: Maxhold
- Sweeps: Till stable (min. 500, max. 75000)
- Sweep time: Auto
- Detector: Peak

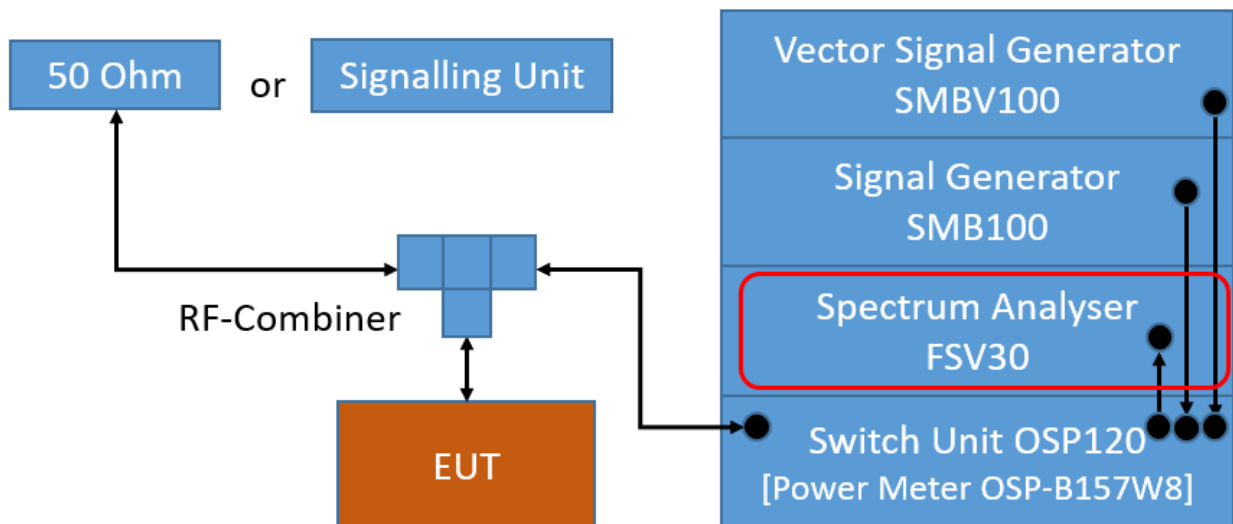

TS8997; Channel Bandwidth

#### 5.3.2 TEST REQUIREMENTS / LIMITS

No applicable limit.

### 5.3.3 TEST PROTOCOL

Ambient temperature: 23-25 °C  
 Air Pressure: 990-1024 hPa  
 Humidity: 30-40%  
 BT GFSK

Band	Channel No.	Frequency [MHz]	99 % Bandwidth [MHz]
2.4 GHz ISM	0	2402	0.855
	39	2441	0.855
	78	2480	0.855

BT n/4 DQPSK

Band	Channel No.	Frequency [MHz]	99 % Bandwidth [MHz]
2.4 GHz ISM	0	2402	1.170
	39	2441	1.170
	78	2480	1.170

BT 8-DPSK

Band	Channel No.	Frequency [MHz]	99 % Bandwidth [MHz]
2.4 GHz ISM	0	2402	1.175
	39	2441	1.175
	78	2480	1.175

BT LE 1 Mbit/s

Band	Channel No.	Frequency [MHz]	99 % Bandwidth [MHz]
2.4 GHz ISM	0	2402	1.030
	19	2440	1.030
	39	2480	1.030

BT LE 2 Mbit/s

Band	Channel No.	Frequency [MHz]	99 % Bandwidth [MHz]
2.4 GHz ISM	0	2402	2.040
	19	2440	2.040
	39	2480	2.040

WLAN b-Mode; 20 MHz; 1 Mbit/s

Band	Channel No.	Frequency [MHz]	99 % Bandwidth [MHz]
2.4 GHz ISM	1	2412	11.9
	6	2437	12.0
	11	2462	12.0

WLAN g-Mode; 20 MHz; 6 Mbit/s

Band	Channel No.	Frequency [MHz]	99 % Bandwidth [MHz]
2.4 GHz ISM	1	2412	16.7
	6	2437	16.7
	11	2462	16.7

WLAN n-Mode; 20 MHz; MCS0

Band	Channel No.	Frequency [MHz]	99 % Bandwidth [MHz]
2.4 GHz ISM	1	2412	17.7
	6	2437	16.7
	11	2462	16.7

WLAN n-Mode; 40 MHz; MCS0

Band	Channel No.	Frequency [MHz]	99 % Bandwidth [MHz]
2.4 GHz ISM	3	2422	36.3
	6	2437	36.5
	9	2452	36.3

Remark: Please see next sub-clause for the measurement plot.

### 5.3.4 MEASUREMENT PLOT (EXAMPLE PLOT, SHOWING WORST CASE, IF APPLICABLE)

Radio Technology = Bluetooth BDR, Operating Frequency = mid  
(S01\_161\_AD01)

#### 99 % Bandwidth

DUT Frequency (MHz)	Bandwidth (MHz)	Limit Min (MHz)	Limit Max (MHz)	Band Edge Left (MHz)	Band Edge Right (MHz)	Result
2441.000000	0.855000	---	---	2440.582500	2441.437500	PASS

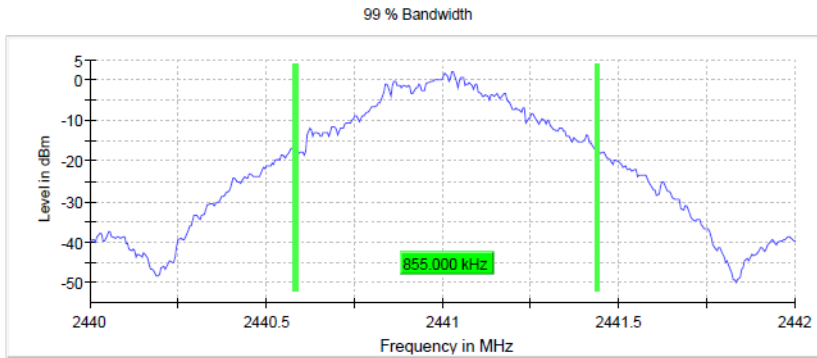

Setting	Instrument Value
Start Frequency	2.44000 GHz
Stop Frequency	2.44200 GHz
Span	2.000 MHz
RBW	10.000 kHz
VBW	30.000 kHz
SweepPoints	400
SweepTime	419.000 $\mu$ s
Reference Level	10.000 dBm
Attenuation	20.000 dB
Detector	MaxPeak
SweepCount	500
Filter	3 dB
Trace Mode	Max Hold
SweepType	FFT
Preamp	off
Stablemode	Trace
Stablevalue	0.30 dB
Run	7 / max. 150
Stable	3 / 3
Max Stable Difference	0.04 dB

Radio Technology = Bluetooth EDR 2, Operating Frequency = high  
(S01\_161\_AD01)

#### 99 % Bandwidth

DUT Frequency (MHz)	Bandwidth (MHz)	Limit Min (MHz)	Limit Max (MHz)	Band Edge Left (MHz)	Band Edge Right (MHz)	Result
2480.000000	1.170000	---	---	2479.427500	2480.597500	PASS

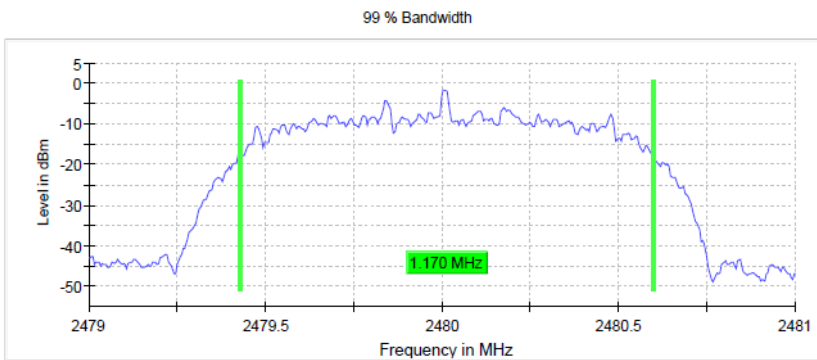

Setting	Instrument Value
Start Frequency	2.47900 GHz
Stop Frequency	2.48100 GHz
Span	2.000 MHz
RBW	10.000 kHz
VBW	30.000 kHz
SweepPoints	400
SweepTime	419.000 $\mu$ s
Reference Level	10.000 dBm
Attenuation	20.000 dB
Detector	MaxPeak
SweepCount	500
Filter	3 dB
Trace Mode	Max Hold
SweepType	FFT
Preamp	off
Stablemode	Trace
Stablevalue	0.30 dB
Run	7 / max. 150
Stable	3 / 3
Max Stable Difference	0.15 dB

Radio Technology = Bluetooth EDR 3, Operating Frequency = mid  
(S01\_161\_AD01)

**99 % Bandwidth**

DUT Frequency (MHz)	Bandwidth (MHz)	Limit Min (MHz)	Limit Max (MHz)	Band Edge Left (MHz)	Band Edge Right (MHz)	Result
2441.000000	1.175000	---	---	2440.427500	2441.602500	PASS

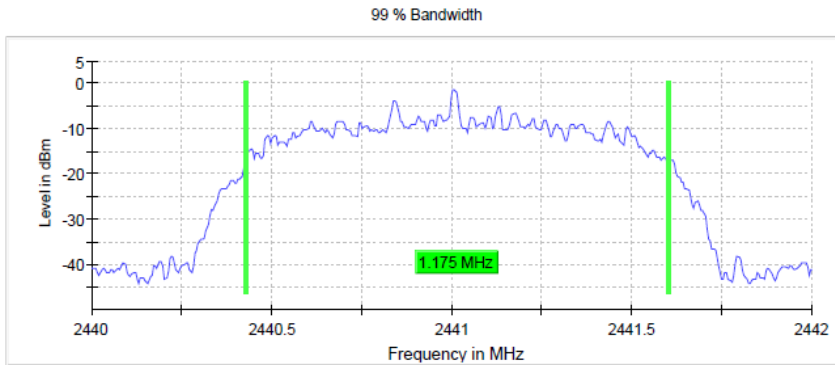

Setting	Instrument Value
Start Frequency	2.440000 GHz
Stop Frequency	2.442000 GHz
Span	2.000 MHz
RBW	10.000 kHz
VBW	30.000 kHz
SweepPoints	400
Sweeptime	419.000 $\mu$ s
Reference Level	10.000 dBm
Attenuation	20.000 dB
Detector	MaxPeak
SweepCount	500
Filter	3 dB
Trace Mode	Max Hold
SweepType	FFT
Preamp	off
Stablemode	Trace
Stablevalue	0.30 dB
Run	6 / max. 150
Stable	3 / 3
Max Stable Difference	0.05 dB

Radio Technology = Bluetooth LE 1 Mbps, Operating Frequency = mid  
(S01\_161\_AD01)

**99 % Bandwidth**

DUT Frequency (MHz)	Bandwidth (MHz)	Limit Min (MHz)	Limit Max (MHz)	Band Edge Left (MHz)	Band Edge Right (MHz)	Result
2440.000000	1.030000	---	---	2439.505000	2440.535000	PASS

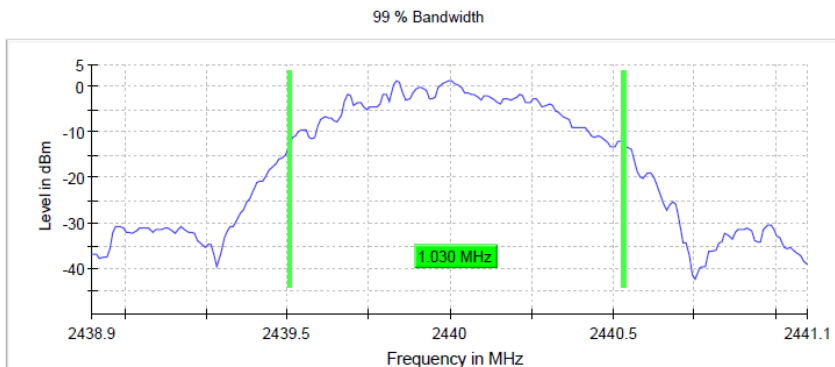

Setting	Instrument Value
Start Frequency	2.43890 GHz
Stop Frequency	2.44110 GHz
Span	2.200 MHz
RBW	20.000 kHz
VBW	100.000 kHz
SweepPoints	220
Sweeptime	210.000 $\mu$ s
Reference Level	0.000 dBm
Attenuation	10.000 dB
Detector	MaxPeak
SweepCount	100
Filter	3 dB
Trace Mode	Max Hold
SweepType	FFT
Preamp	off
Stablemode	Trace
Stablevalue	0.30 dB
Run	6 / max. 150
Stable	3 / 3
Max Stable Difference	0.07 dB

Radio Technology = Bluetooth LE 2 Mbps, Operating Frequency = high  
(S01\_161\_AD01)

**99 % Bandwidth**

DUT Frequency (MHz)	Bandwidth (MHz)	Limit Min (MHz)	Limit Max (MHz)	Band Edge Left (MHz)	Band Edge Right (MHz)	Result
2480.000000	2.040000	---	---	2479.017500	2481.057500	PASS

Setting	Instrument Value
Start Frequency	2.47790 GHz
Stop Frequency	2.48210 GHz
Span	4.200 MHz
RBW	30.000 kHz
VBW	100.000 kHz
SweepPoints	280
Sweeptime	140.000 $\mu$ s
Reference Level	0.000 dBm
Attenuation	10.000 dB
Detector	MaxPeak
SweepCount	100
Filter	3 dB
Trace Mode	Max Hold
SweepType	FFT
Preamp	off
Stablemode	Trace
Stablevalue	0.30 dB
Run	8 / max. 150
Stable	3 / 3
Max Stable Difference	0.22 dB

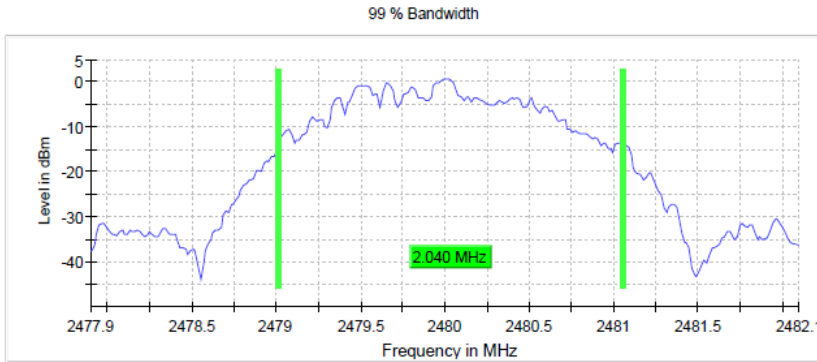

Radio Technology = WLAN b, Operating Frequency = mid  
(S01\_161\_AC01)

**99 % Bandwidth**

DUT Frequency (MHz)	Bandwidth (MHz)	Limit Min (MHz)	Limit Max (MHz)	Band Edge Left (MHz)	Band Edge Right (MHz)	Result
2437.000000	12.000000	---	---	2430.950000	2442.950000	PASS

Setting	Instrument Value
Start Frequency	2.41700 GHz
Stop Frequency	2.45700 GHz
Span	40.000 MHz
RBW	200.000 kHz
VBW	1.000 MHz
SweepPoints	400
Sweeptime	1.000 ms
Reference Level	0.000 dBm
Attenuation	10.000 dB
Detector	MaxPeak
SweepCount	100
Filter	3 dB
Trace Mode	Max Hold
SweepType	Sweep
Preamp	off
Stablemode	Trace
Stablevalue	0.30 dB
Run	13 / max. 150
Stable	3 / 3
Max Stable Difference	0.20 dB

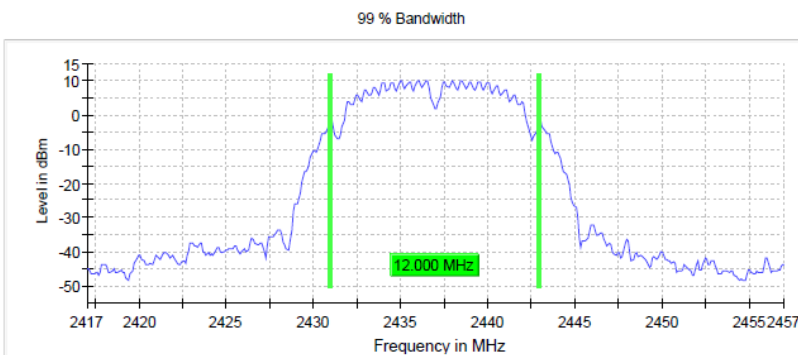



Radio Technology = WLAN g, Operating Frequency = mid  
(S01\_161\_AC01)

99 % Bandwidth

DUT Frequency (MHz)	Bandwidth (MHz)	Limit Min (MHz)	Limit Max (MHz)	Band Edge Left (MHz)	Band Edge Right (MHz)	Result
2437.000000	16.700000	---	---	2428.650000	2445.350000	PASS

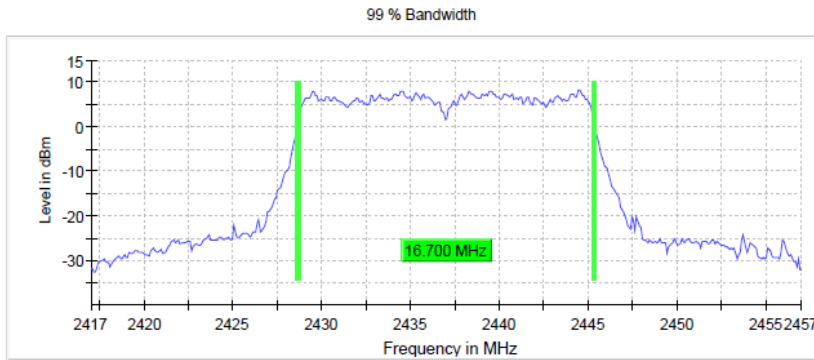

Setting	Instrument Value
Start Frequency	2.41700 GHz
Stop Frequency	2.45700 GHz
Span	40.000 MHz
RBW	200.000 kHz
VBW	1.000 MHz
SweepPoints	400
Sweeptime	1.000 ms
Reference Level	10.000 dBm
Attenuation	20.000 dB
Detector	MaxPeak
SweepCount	100
Filter	3 dB
Trace Mode	Max Hold
SweepType	Sweep
Preamp	off
Stablemode	Trace
Stablevalue	0.30 dB
Run	44 / max. 150
Stable	3 / 3
Max Stable Difference	0.13 dB

Radio Technology = WLAN n 20 MHz, Operating Frequency = low  
(S01\_161\_AC01)

99 % Bandwidth

DUT Frequency (MHz)	Bandwidth (MHz)	Limit Min (MHz)	Limit Max (MHz)	Band Edge Left (MHz)	Band Edge Right (MHz)	Result
2412.000000	17.700000	---	---	2403.150000	2420.850000	PASS

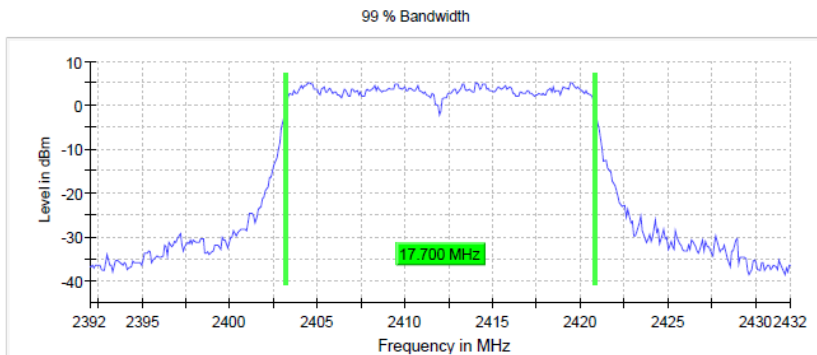

Setting	Instrument Value
Start Frequency	2.39200 GHz
Stop Frequency	2.43200 GHz
Span	40.000 MHz
RBW	200.000 kHz
VBW	1.000 MHz
SweepPoints	400
Sweeptime	1.000 ms
Reference Level	10.000 dBm
Attenuation	20.000 dB
Detector	MaxPeak
SweepCount	100
Filter	3 dB
Trace Mode	Max Hold
SweepType	Sweep
Preamp	off
Stablemode	Trace
Stablevalue	0.30 dB
Run	48 / max. 150
Stable	3 / 3
Max Stable Difference	0.29 dB

Radio Technology = WLAN n 40 MHz, Operating Frequency = mid  
(S01\_161\_AC01)

**99 % Bandwidth**

DUT Frequency (MHz)	Bandwidth (MHz)	Limit Min (MHz)	Limit Max (MHz)	Band Edge Left (MHz)	Band Edge Right (MHz)	Result
2437.000000	36.500000	--	--	2418.625000	2455.125000	PASS

Setting	Instrument Value
Start Frequency	2.39700 GHz
Stop Frequency	2.47700 GHz
Span	80.000 MHz
RBW	500.000 kHz
VBW	2.000 MHz
SweepPoints	320
Sweptime	1.000 ms
Reference Level	10.000 dBm
Attenuation	20.000 dB
Detector	MaxPeak
SweepCount	100
Filter	3 dB
Trace Mode	Max Hold
Sweeptype	Sweep
Preamp	off
Stablemode	Trace
Stablevalue	0.30 dB
Run	59 / max. 150
Stable	3 / 3
Max Stable Difference	0.10 dB

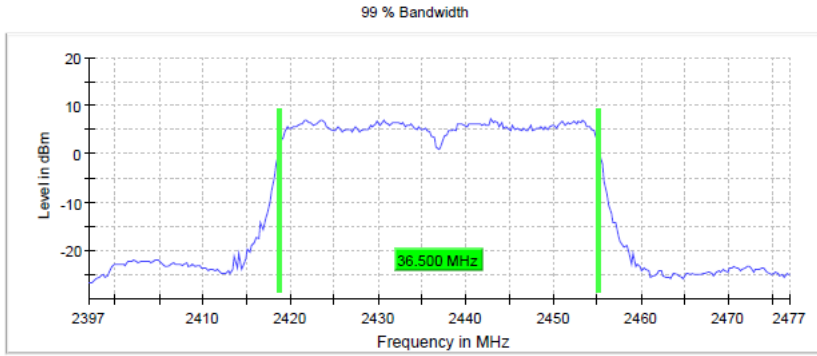

**5.3.5 TEST EQUIPMENT USED**

- R&S TS8997

## 5.4 PEAK POWER OUTPUT

Standard **FCC Part 15 Subpart C**

**The test was performed according to:**

ANSI C63.10 11.9.1.1, 11.9.2.3.2

### 5.4.1 TEST DESCRIPTION

DTS EQUIPMENT:

The Equipment Under Test (EUT) was set up to perform the output power measurements. The results recorded were measured with the modulation which produces the worst-case (highest) output power.

Maximum peak conducted output power (e.g. Bluetooth Low Energy):

The EUT was connected to the test system as described in the block diagram below. The complete attenuation of the measurement path is known and considered. The reference level of the spectrum analyser was set higher than the output power of the EUT.

Analyser settings:

- Resolution Bandwidth (RBW):  $\geq$  DTS bandwidth
- Video Bandwidth (VBW):  $\geq$  3 times RBW or maximum of analyzer
- Span:  $\geq$  3 times RBW
- Trace: Maxhold
- Sweeps: Till stable (min. 300, max. 15000)
- Sweeptime: Auto
- Detector: Peak

Maximum conducted average output power (e.g. WLAN):

The EUT was connected to the test system as described in the block diagram below. The complete attenuation of the measurement path is known and considered. Measurement is performed using the gated RF average power meter integrated in the OSP 120 module OSP-B157W8 with signal bandwidth  $>300$  MHz.

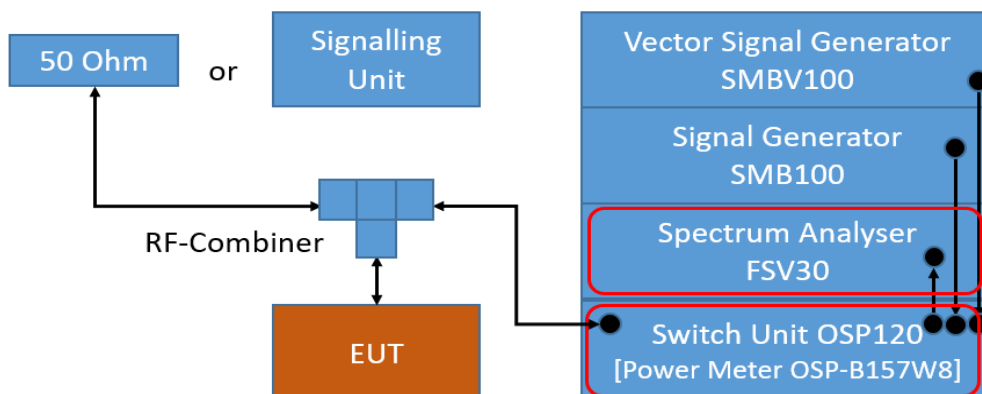

TS8997; Output Power

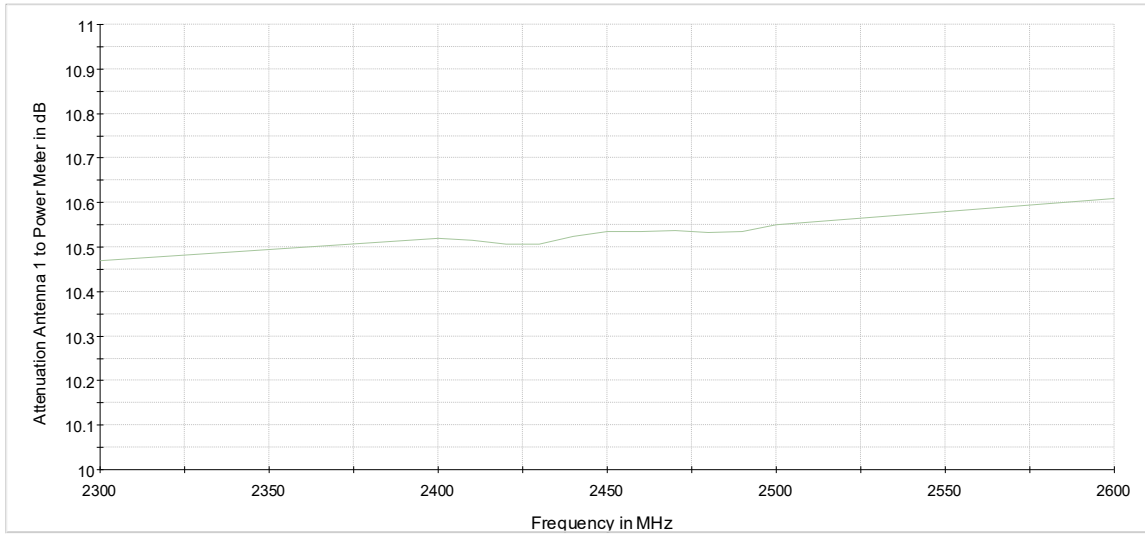

Attenuation of the measurement path to Power Meter

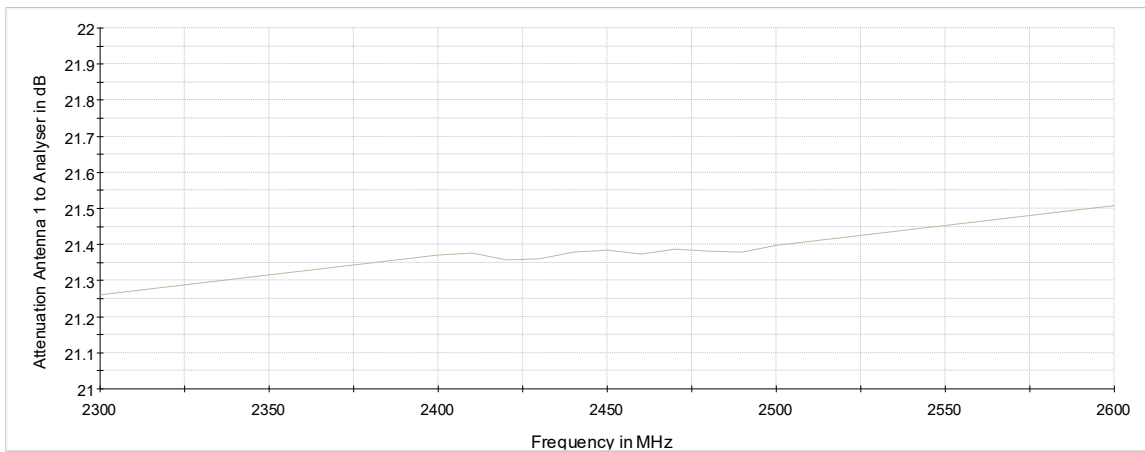

Attenuation of the measurement path to Analyser

## 5.4.2 TEST REQUIREMENTS / LIMITS

### **DTS devices:**

FCC Part 15, Subpart C, §15.247 (b) (3)

For systems using digital modulation techniques in the 902-928 MHz, 2400-2483.5 MHz and 5725-5850 MHz bands: 1 watt.

==> Maximum conducted peak output power: 30 dBm (excluding antenna gain, if antennas with directional gains that do not exceed 6 dBi are used).

### **Frequency Hopping Systems:**

FCC Part 15, Subpart C, §15.247 (b) (1)

For frequency hopping systems operating in the 2400-2483.5 MHz band employing at least 75 non-overlapping hopping channels, and all frequency hopping systems in the 5725-5850 MHz band: 1 watt. For all other frequency hopping systems in the 2400-2483.5 MHz band: 0.125 watts.

FCC Part 15, Subpart C, §15.247 (b) (2)

For frequency hopping systems operating in the 902-928 MHz band: 1 watt for systems employing at least 50 hopping channels; and, 0.25 watts for systems employing less than 50 hopping channels, but at least 25 hopping channels, as permitted under paragraph (a)(1)(i) of this section.

Used conversion factor: Limit (dBm) = 10 log (Limit (W)/1mW)

### 5.4.3 TEST PROTOCOL

Ambient temperature: 23-25 °C  
 Air Pressure: 990-1024 hPa  
 Humidity: 30-40%  
 BT GFSK

Band	Channel No.	Frequency [MHz]	Peak Power [dBm]	Limit [dBm]	Margin to Limit [dB]	E.I.R.P [dBm]
2.4 GHz ISM	0	2402	7.6	30.0	22.4	9.6
	39	2441	7.2	30.0	22.8	9.2
	78	2480	7.1	30.0	22.9	9.1

BT π/4 DQPSK

Band	Channel No.	Frequency [MHz]	Peak Power [dBm]	Limit [dBm]	Margin to Limit [dB]	E.I.R.P [dBm]
2.4 GHz ISM	0	2402	6.6	30.0	23.4	8.6
	39	2441	6.5	30.0	23.5	8.5
	78	2480	6.3	30.0	23.7	8.3

BT 8-DPSK

Band	Channel No.	Frequency [MHz]	Peak Power [dBm]	Limit [dBm]	Margin to Limit [dB]	E.I.R.P [dBm]
2.4 GHz ISM	0	2402	6.9	30.0	23.1	8.9
	39	2441	6.7	30.0	23.3	8.7
	78	2480	6.6	30.0	23.4	8.6

BT LE 1 Mbit/s

Band	Channel No.	Frequency [MHz]	Peak Power [dBm]	Limit [dBm]	Margin to Limit [dB]	E.I.R.P [dBm]
2.4 GHz ISM	0	2402	8.1	30.0	21.9	10.1
	19	2440	7.9	30.0	22.1	9.9
	39	2480	7.7	30.0	22.3	9.7

BT LE 2 Mbit/s

Band	Channel No.	Frequency [MHz]	Peak Power [dBm]	Limit [dBm]	Margin to Limit [dB]	E.I.R.P [dBm]
2.4 GHz ISM	0	2402	8.1	30.0	21.9	10.1
	19	2440	7.9	30.0	22.1	9.9
	39	2480	7.7	30.0	22.3	9.7

WLAN b-Mode; 20 MHz; 1 Mbit/s

Band	Channel No.	Frequency [MHz]	Maximum Average Power [dBm]	Limit [dBm]	Margin to Limit [dB]	E.I.R.P [dBm]
2.4 GHz ISM	1	2412	18.4	30.0	11.6	20.4
	6	2437	18.4	30.0	11.6	20.4
	11	2462	18.4	30.0	11.6	20.4

WLAN g-Mode; 20 MHz; 6 Mbit/s

Band	Channel No.	Frequency [MHz]	Maximum Average Power [dBm]	Limit [dBm]	Margin to Limit [dB]	E.I.R.P [dBm]
2.4 GHz ISM	1	2412	16.1	30.0	13.9	18.1
	6	2437	18.1	30.0	11.9	20.1
	11	2462	16.1	30.0	13.9	18.1

WLAN n-Mode; 20 MHz; MCS0

Band	Channel No.	Frequency [MHz]	Maximum Average Power [dBm]	Limit [dBm]	Margin to Limit [dB]	E.I.R.P [dBm]
2.4 GHz ISM	1	2412	15.3	30.0	14.7	17.3
	6	2437	16.1	30.0	13.9	18.1
	11	2462	15.1	30.0	14.9	17.1

WLAN n-Mode; 40 MHz; MCS0

Band	Channel No.	Frequency [MHz]	Maximum Average Power [dBm]	Limit [dBm]	Margin to Limit [dB]	E.I.R.P [dBm]
2.4 GHz ISM	3	2422	14.2	30.0	15.8	16.2
	6	2437	16.2	30.0	13.8	18.2
	9	2452	15.2	30.0	14.8	17.2

Remark: Please see next sub-clause for the measurement plots.

No plots are provided for WLAN since a power meter was used for measurement.

#### 5.4.4 MEASUREMENT PLOT (EXAMPLE PLOT, SHOWING WORST CASE, IF APPLICABLE)

Radio Technology = Bluetooth BDR, Operating Frequency = low, Measurement method = conducted  
(S01\_161\_AD01)

##### Result

DUT Frequency (MHz)	Peak Power (dBm)	Limit Max (dBm)	Result
2402.000000	7.6	21.0	PASS

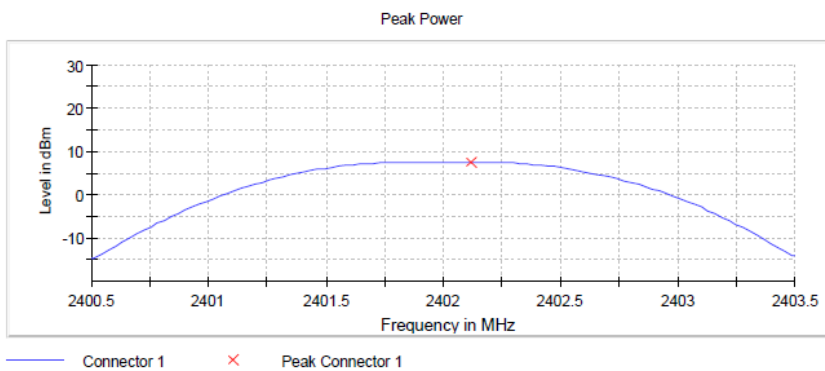

Setting	Instrument Value
Start Frequency	2.40050 GHz
Stop Frequency	2.40350 GHz
Span	3.000 MHz
RBW	1.000 MHz
VBW	3.000 MHz
SweepPoints	101
SweepTime	4.210 $\mu$ s
Reference Level	20.000 dBm
Attenuation	30.000 dB
Detector	MaxPeak
SweepCount	100
Filter	3 dB
Trace Mode	Max Hold
SweepType	FFT
Preamp	off
Stablemode	Trace
Stablevalue	0.50 dB
Run	4 / max. 150
Stable	3 / 3
Max Stable Difference	0.00 dB

Radio Technology = Bluetooth EDR 2, Operating Frequency = low, Measurement method = conducted  
(S01\_161\_AD01)

##### Result

DUT Frequency (MHz)	Peak Power (dBm)	Limit Max (dBm)	Result
2402.000000	6.6	21.0	PASS

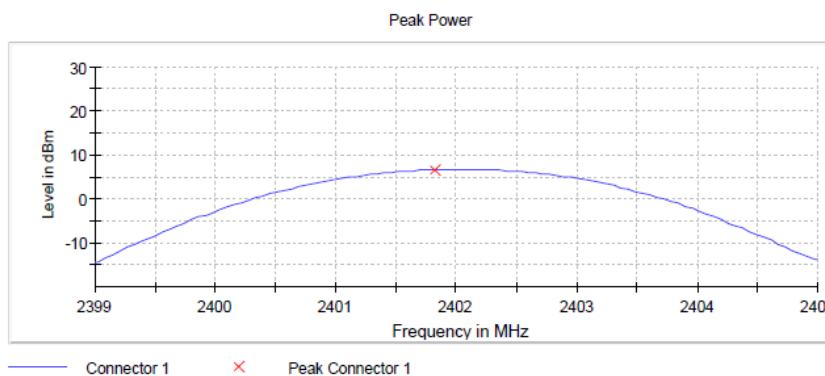

Setting	Instrument Value
Start Frequency	2.39900 GHz
Stop Frequency	2.40500 GHz
Span	6.000 MHz
RBW	2.000 MHz
VBW	10.000 MHz
SweepPoints	101
SweepTime	1.000 ms
Reference Level	20.000 dBm
Attenuation	30.000 dB
Detector	MaxPeak
SweepCount	100
Filter	3 dB
Trace Mode	Max Hold
SweepType	Sweep
Preamp	off
Stablemode	Trace
Stablevalue	0.50 dB
Run	4 / max. 150
Stable	3 / 3
Max Stable Difference	0.10 dB



Radio Technology = Bluetooth EDR 3, Operating Frequency = low, Measurement method = conducted (S01\_161\_AD01)

**Result**

DUT Frequency (MHz)	Peak Power (dBm)	Limit Max (dBm)	Result
2402.000000	6.9	21.0	PASS

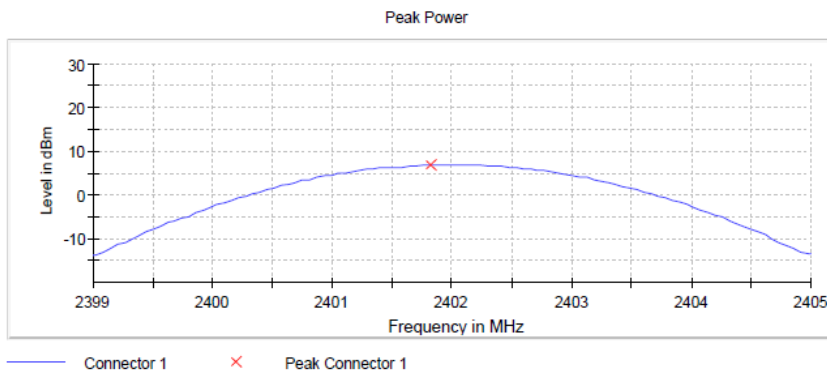

Setting	Instrument Value
Start Frequency	2.39900 GHz
Stop Frequency	2.40500 GHz
Span	6.000 MHz
RBW	2.000 MHz
VBW	10.000 MHz
SweepPoints	101
Sweeptime	1.000 ms
Reference Level	20.000 dBm
Attenuation	30.000 dB
Detector	MaxPeak
SweepCount	100
Filter	3 dB
Trace Mode	Max Hold
SweepType	Sweep
Preamp	off
Stablemode	Trace
Stablevalue	0.50 dB
Run	4 / max. 150
Stable	3 / 3
Max Stable Difference	0.19 dB

Radio Technology = Bluetooth LE 1 Mbps, Operating Frequency = low, Measurement method = conducted (S01\_161\_AD01)

**Result**

DUT Frequency (MHz)	Peak Power (dBm)	Limit Max (dBm)	Result
2402.000000	8.1	30.0	PASS

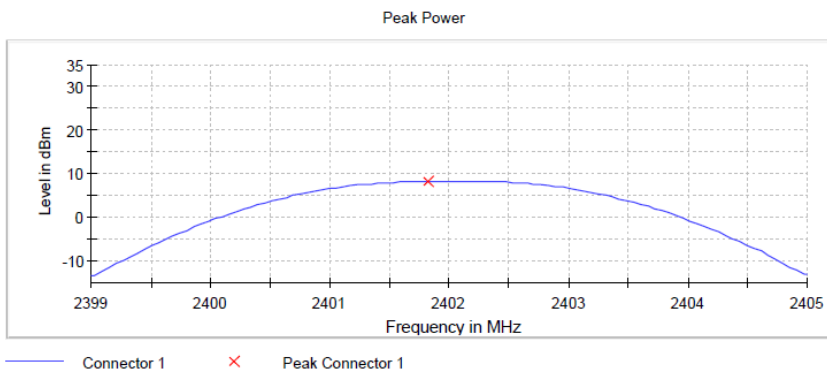

Setting	Instrument Value
Start Frequency	2.39900 GHz
Stop Frequency	2.40500 GHz
Span	6.000 MHz
RBW	2.000 MHz
VBW	10.000 MHz
SweepPoints	101
Sweeptime	1.000 ms
Reference Level	10.000 dBm
Attenuation	20.000 dB
Detector	MaxPeak
SweepCount	100
Filter	3 dB
Trace Mode	Max Hold
SweepType	Sweep
Preamp	off
Stablemode	Trace
Stablevalue	0.50 dB
Run	4 / max. 150
Stable	3 / 3
Max Stable Difference	0.03 dB

Radio Technology = Bluetooth LE 2 Mbps, Operating Frequency = low, Measurement method = conducted  
(S01\_161\_AD01)

**Result**

DUT Frequency (MHz)	Peak Power (dBm)	Limit Max (dBm)	Result
2402.000000	8.1	30.0	PASS

Setting	Instrument Value
Start Frequency	2.39750 GHz
Stop Frequency	2.40650 GHz
Span	9.000 MHz
RBW	3.000 MHz
VBW	10.000 MHz
SweepPoints	101
SweepTime	1.000 ms
Reference Level	10.000 dBm
Attenuation	20.000 dB
Detector	MaxPeak
SweepCount	100
Filter	3 dB
Trace Mode	Max Hold
SweepType	Sweep
Preamp	off
Stablemode	Trace
Stablevalue	0.50 dB
Run	4 / max. 150
Stable	3 / 3
Max Stable Difference	0.03 dB

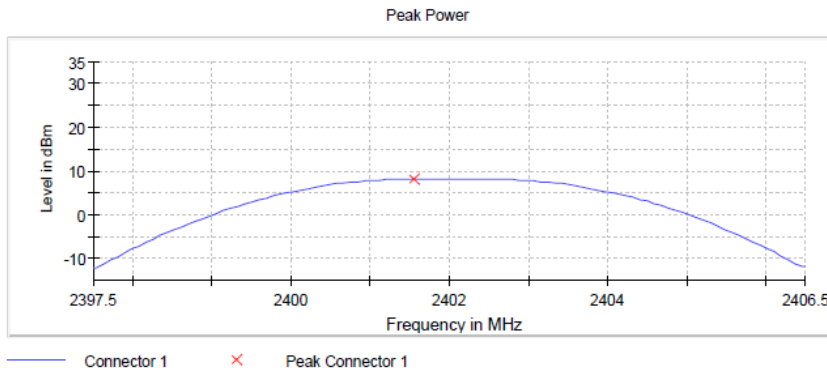

**5.4.5 TEST EQUIPMENT USED**

- R&S TS8997

## 5.5 SPURIOUS RF CONDUCTED EMISSIONS

Standard **FCC Part 15 Subpart C**

**The test was performed according to:**  
ANSI C63.10 11.11

### 5.5.1 TEST DESCRIPTION

The Equipment Under Test (EUT) was set up to perform the spurious emissions measurements.

The EUT was connected to the test system as described in the block diagram below. The complete attenuation of the measurement path is known and considered.

Analyser settings:

- Frequency range: 30 – 26000 MHz
- Resolution Bandwidth (RBW): 100 kHz
- Video Bandwidth (VBW): 300 kHz
- Trace: Maxhold
- Sweeps: Till Stable (max. 120)
- Sweep Time: Auto
- Detector: Peak

The reference value for the measurement of the spurious RF conducted emissions is determined during the test "band edge compliance conducted". This value is used to calculate the 20 dBc or 30 dBc limit.

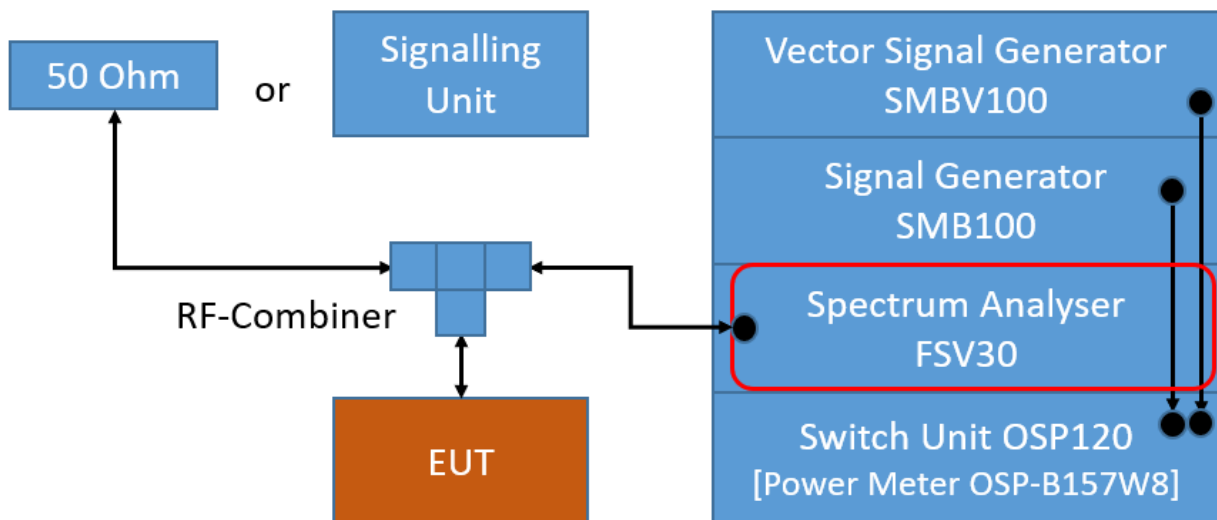

TS8997; Spurious RF Conducted Emissions

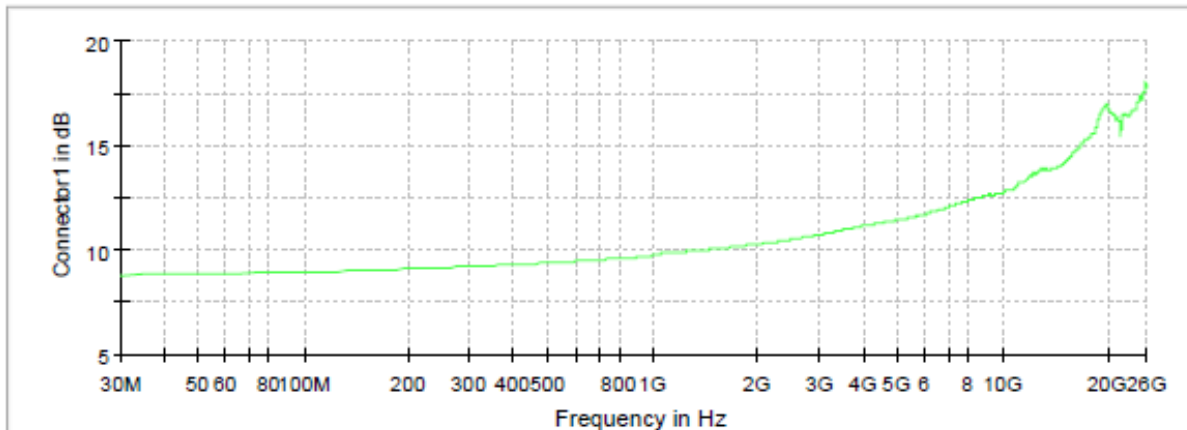

Connector1

Attenuation of the measurement part

## 5.5.2 TEST REQUIREMENTS / LIMITS

FCC Part 15, Subpart C, §15.247 (c)

In any 100 kHz bandwidth outside the frequency band in which the spread spectrum intentional radiator is operating, the radio frequency power that is produced by the intentional radiator shall be at least 20 dB below that in the 100 kHz bandwidth within the band that contains the highest level of the desired power, based on either an RF conducted or a radiated measurement, provided the transmitter demonstrates compliance with the peak conducted power limits. If the transmitter complies with the conducted power limits based on the use of RMS averaging over a time interval, as permitted under paragraph (b)(3) of this section, the attenuation required under this paragraph shall be 30 dB instead of 20 dB.

### 5.5.3 TEST PROTOCOL

Ambient temperature: 23-25 °C  
 Air Pressure: 990-1024 hPa  
 Humidity: 30-40%  
 BT GFSK

Channel No	Channel Center Freq. [MHz]	Spurious Freq. [MHz]	Spurious Level [dBm]	Detector	RBW [kHz]	Ref. Level [dBm]	Limit [dBm]	Margin to Limit [dB]
0	2402	4807.2	-51.7	PEAK	100	6.9	-13.1	38.6
39	2441	4887.1	-54.1	PEAK	100	6.5	-13.5	40.6
78	2480	2488.5	-55.6	PEAK	100	6.7	-13.3	42.3

BT n/4 DQPSK

Channel No	Channel Center Freq. [MHz]	Spurious Freq. [MHz]	Spurious Level [dBm]	Detector	RBW [kHz]	Ref. Level [dBm]	Limit [dBm]	Margin to Limit [dB]
0	2402	2395.0	-50.9	PEAK	100	2.7	-17.3	33.6
39	2441	4877.1	-61.3	PEAK	100	3.3	-16.7	44.6
78	2480	2488.5	-55.9	PEAK	100	2.0	-18.0	37.9

BT 8-DPSK

Channel No	Channel Center Freq. [MHz]	Spurious Freq. [MHz]	Spurious Level [dBm]	Detector	RBW [kHz]	Ref. Level [dBm]	Limit [dBm]	Margin to Limit [dB]
0	2402	2395.0	-47.3	PEAK	100	4.6	-15.4	31.9
39	2441	4877.1	-57.9	PEAK	100	2.1	-17.9	40.0
78	2480	2488.5	-54.7	PEAK	100	2.4	-17.6	37.1

BT LE 1 Mbit/s

Channel No	Channel Center Freq. [MHz]	Spurious Freq. [MHz]	Spurious Level [dBm]	Detector	RBW [kHz]	Ref. Level [dBm]	Limit [dBm]	Margin to Limit [dB]
0	2402	4807.2	-51.6	PEAK	100	6.8	-13.2	38.4
19	2440	4877.1	-53.6	PEAK	100	7.5	-12.5	41.1
39	2480	2488.5	-53.3	PEAK	100	7.7	-12.3	41.0

BT LE 2 Mbit/s

Channel No	Channel Center Freq. [MHz]	Spurious Freq. [MHz]	Spurious Level [dBm]	Detector	RBW [kHz]	Ref. Level [dBm]	Limit [dBm]	Margin to Limit [dB]
0	2402	2395.0	-28.8	PEAK	100	7.0	-13.0	15.8
19	2440	4877.1	-56.0	PEAK	100	7.4	-12.6	43.4
39	2480	2488.5	-52.9	PEAK	100	7.5	-12.5	40.4

WLAN b-Mode; 20 MHz; 1 Mbit/s

Channel No	Channel Center Freq. [MHz]	Spurious Freq. [MHz]	Spurious Level [dBm]	Detector	RBW [kHz]	Ref. Level [dBm]	Limit [dBm]	Margin to Limit [dB]
1	2412	2395.0	-35.9	PEAK	100	8.5	-21.5	14.4
6	2437	1628.3	-45.0	PEAK	100	7.7	-22.3	22.7
11	2462	25025.6	-40.9	PEAK	100	8.0	-22.0	18.9

WLAN g-Mode; 20 MHz; 6 Mbit/s

Channel No	Channel Center Freq. [MHz]	Spurious Freq. [MHz]	Spurious Level [dBm]	Detector	RBW [kHz]	Ref. Level [dBm]	Limit [dBm]	Margin to Limit [dB]
1	2412	2395.0	-38.9	PEAK	100	1.5	-28.5	10.4
6	2437	2395.0	-43.1	PEAK	100	3.5	-26.5	16.6
11	2462	24915.6	-40.2	PEAK	100	1.4	-28.6	11.6

WLAN n-Mode; 20 MHz; MCS0

Channel No	Channel Center Freq. [MHz]	Spurious Freq. [MHz]	Spurious Level [dBm]	Detector	RBW [kHz]	Ref. Level [dBm]	Limit [dBm]	Margin to Limit [dB]
1	2412	2495.0	-34.3	PEAK	100	0.3	-29.7	4.6
6	2437	2395.0	-34.3	PEAK	100	0.0	-30.0	4.3
11	2462	25205.5	-40.1	PEAK	100	0.5	-29.5	10.6

WLAN n-Mode; 40 MHz; MCS0

Channel No	Channel Center Freq. [MHz]	Spurious Freq. [MHz]	Spurious Level [dBm]	Detector	RBW [kHz]	Ref. Level [dBm]	Limit [dBm]	Margin to Limit [dB]
3	2422	2385.1	-40.3	PEAK	100	0.2	-29.8	10.5
6	2437	2395.0	-31.3	PEAK	100	2.3	-27.7	3.6
9	2452	2498.5	-38.2	PEAK	100	1.4	-28.6	9.6

Remark: Please see next sub-clause for the measurement plot.

#### 5.5.4 MEASUREMENT PLOT (EXAMPLE PLOT, SHOWING WORST CASE, IF APPLICABLE)

Radio Technology = Bluetooth BDR, Operating Frequency = low (S01\_161\_AD01)

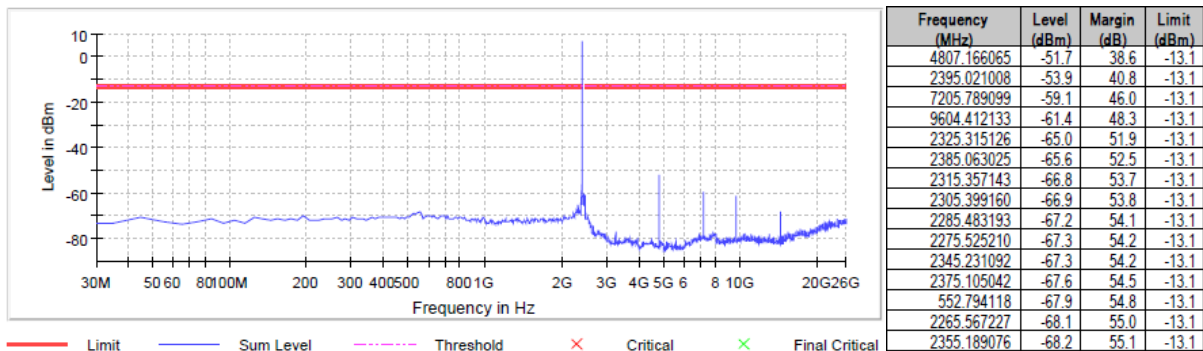

Radio Technology = Bluetooth BDR, Operating Frequency = mid  
(S01\_161\_AD01)

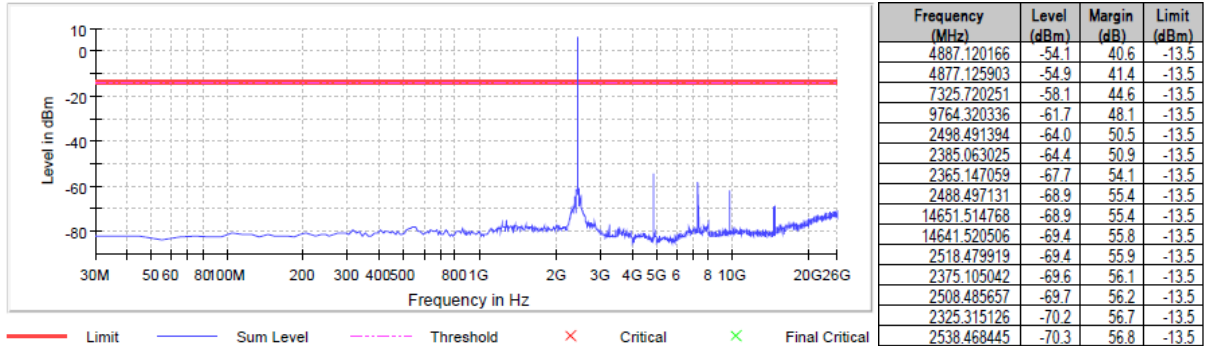

Radio Technology = Bluetooth BDR, Operating Frequency = high  
(S01\_161\_AD01)

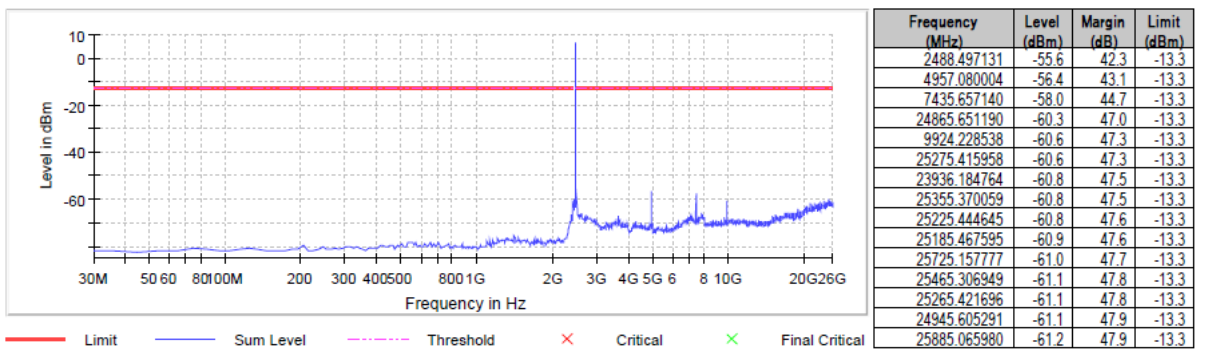

Radio Technology = Bluetooth EDR 2, Operating Frequency = low  
(S01\_161\_AD01)

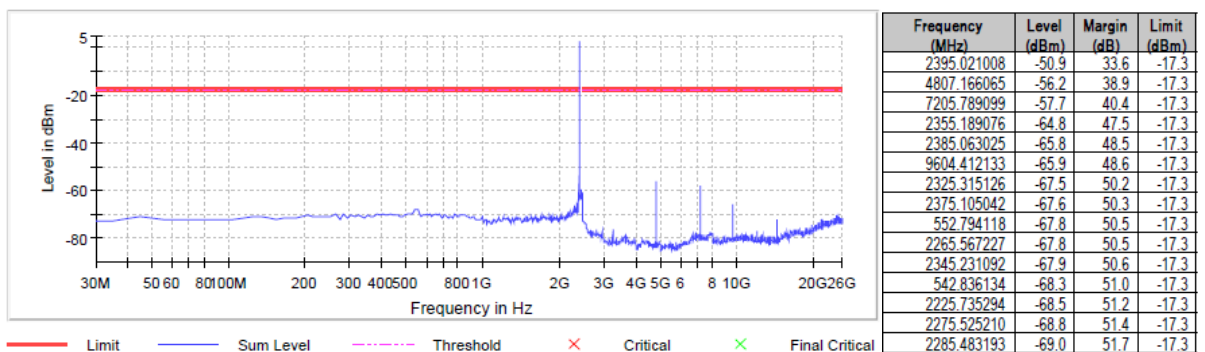

Radio Technology = Bluetooth EDR 2, Operating Frequency = mid  
(S01\_161\_AD01)

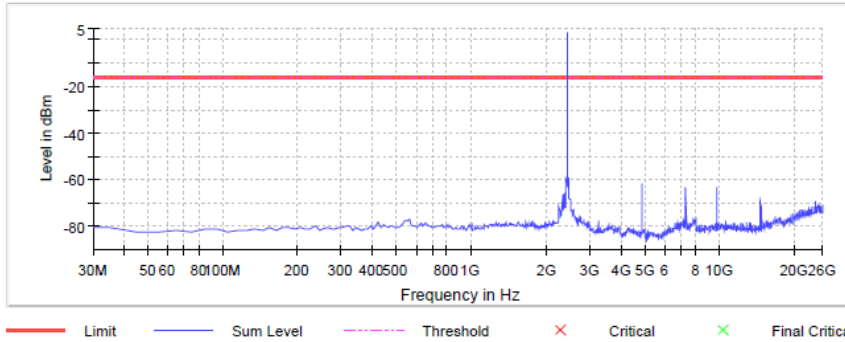

Frequency (MHz)	Level (dBm)	Margin (dB)	Limit (dBm)
4887.120166	-61.3	44.6	-16.7
4877.125903	-61.9	45.3	-16.7
9764.320336	-63.2	46.6	-16.7
7325.720251	-63.3	46.7	-16.7
2385.063025	-65.6	49.0	-16.7
2335.273109	-66.3	49.6	-16.7
2488.497131	-68.2	51.5	-16.7
2498.491394	-68.7	52.0	-16.7
14641.520506	-69.2	52.5	-16.7
24335.955270	-69.4	52.8	-16.7
25915.048768	-71.0	54.3	-16.7
25295.404484	-71.0	54.4	-16.7
24905.628241	-71.1	54.5	-16.7
24995.576604	-71.1	54.5	-16.7
24775.702826	-71.3	54.6	-16.7

Radio Technology = Bluetooth EDR 2, Operating Frequency = high  
(S01\_161\_AD01)

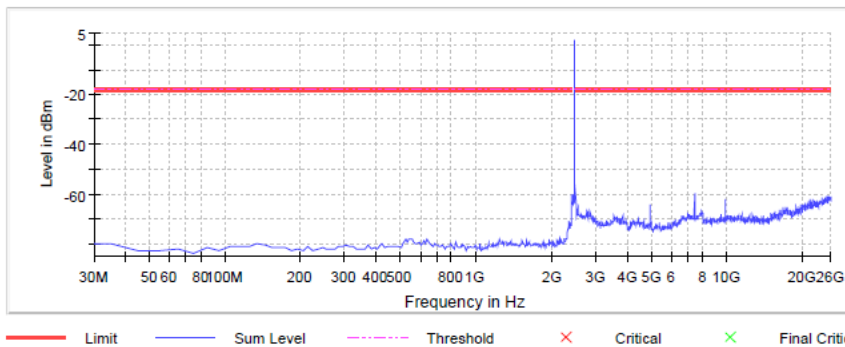

Frequency (MHz)	Level (dBm)	Margin (dB)	Limit (dBm)
2488.497131	-55.9	37.9	-18.0
7435.657140	-59.9	41.9	-18.0
25295.404484	-60.7	42.8	-18.0
25585.238100	-60.9	43.0	-18.0
25055.542180	-61.0	43.0	-18.0
25275.415958	-61.0	43.0	-18.0
25045.547918	-61.1	43.1	-18.0
24905.628241	-61.2	43.2	-18.0
25625.215151	-61.3	43.3	-18.0
25165.479069	-61.3	43.3	-18.0
25745.146303	-61.3	43.3	-18.0
25345.375797	-61.3	43.4	-18.0
25635.209414	-61.4	43.4	-18.0
24495.863472	-61.4	43.4	-18.0
25835.094666	-61.4	43.5	-18.0

Radio Technology = Bluetooth EDR 3, Operating Frequency = low  
(S01\_161\_AD01)

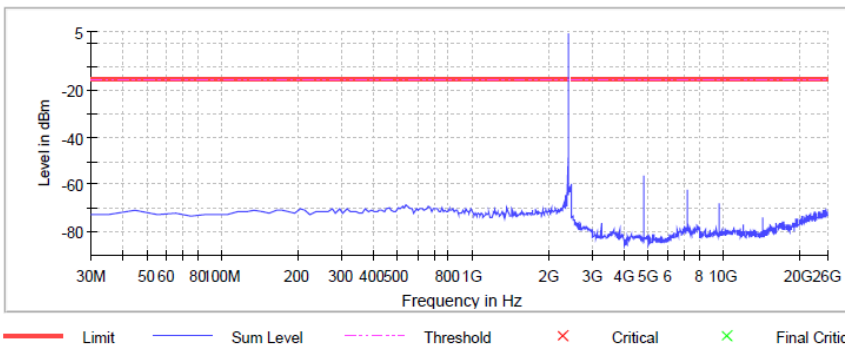

Frequency (MHz)	Level (dBm)	Margin (dB)	Limit (dBm)
2395.021008	-47.3	32.0	-15.4
4807.166065	-56.3	40.9	-15.4
7205.789099	-61.8	46.5	-15.4
2355.189076	-64.5	49.2	-15.4
2385.063025	-65.8	50.4	-15.4
9604.412133	-67.9	52.5	-15.4
2345.231092	-67.9	52.5	-15.4
2295.441176	-67.9	52.6	-15.4
542.836134	-68.6	53.2	-15.4
2325.315126	-69.2	53.8	-15.4
522.920168	-69.3	53.9	-15.4
662.331933	-69.4	54.1	-15.4
2375.105042	-69.4	54.1	-15.4
2365.147059	-69.5	54.2	-15.4
532.878151	-69.5	54.2	-15.4



Radio Technology = Bluetooth EDR 3, Operating Frequency = mid  
(S01\_161\_AD01)

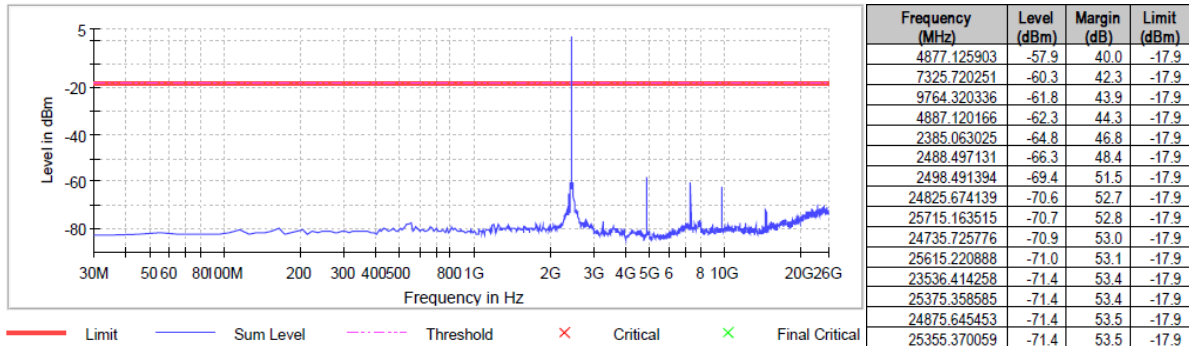

Radio Technology = Bluetooth EDR 3, Operating Frequency = high  
(S01\_161\_AD01)

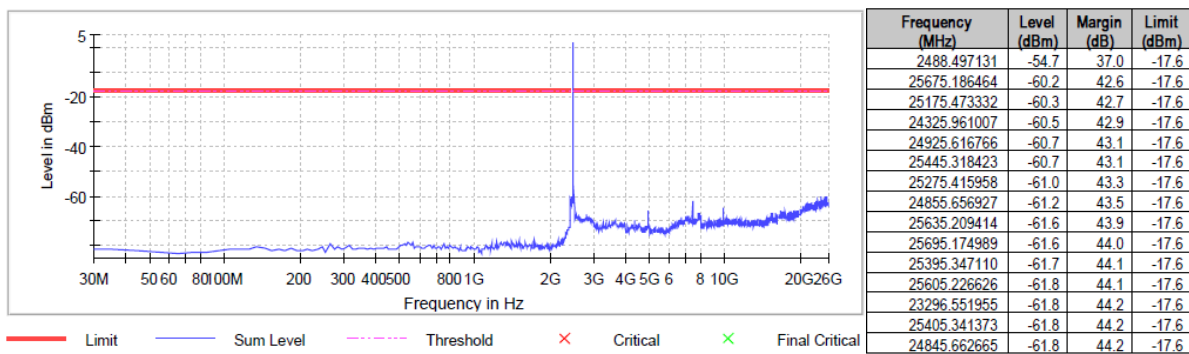

Radio Technology = Bluetooth LE 1 Mbps, Operating Frequency = low  
(S01\_161\_AD01)

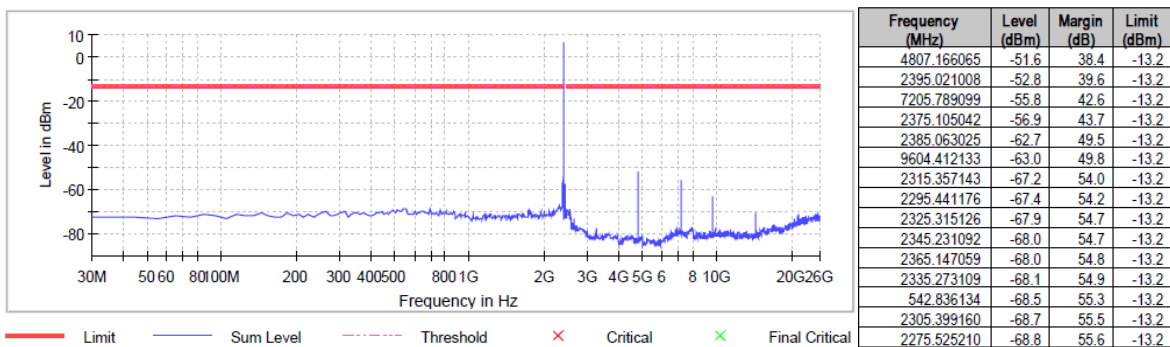

Radio Technology = Bluetooth LE 1 Mbps, Operating Frequency = mid  
(S01\_161\_AD01)

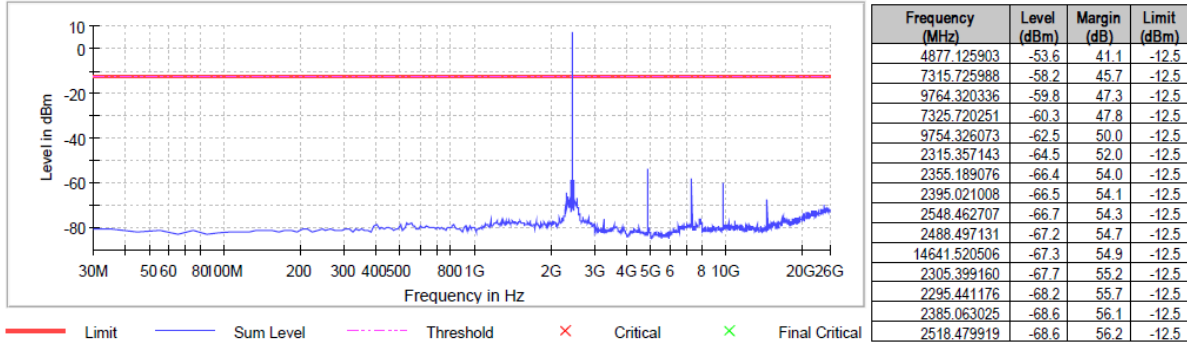

Radio Technology = Bluetooth LE 1 Mbps, Operating Frequency = high  
(S01\_161\_AD01)

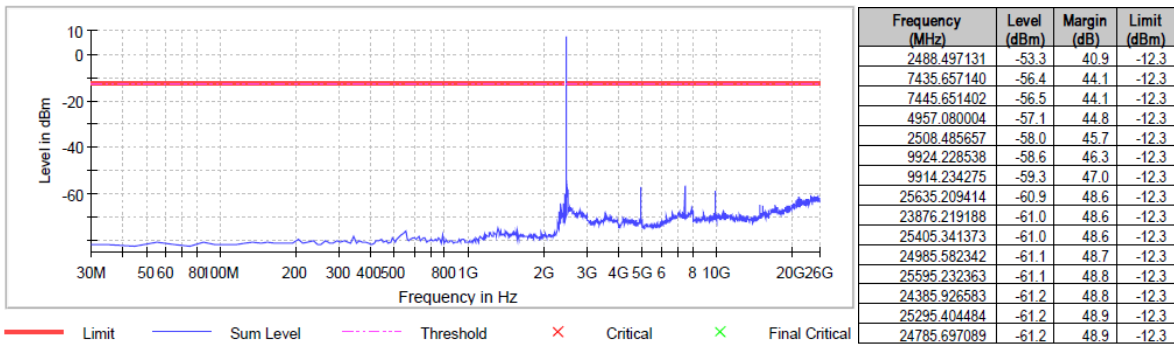

Radio Technology = Bluetooth LE 2 Mbps, Operating Frequency = low  
(S01\_161\_AD01)

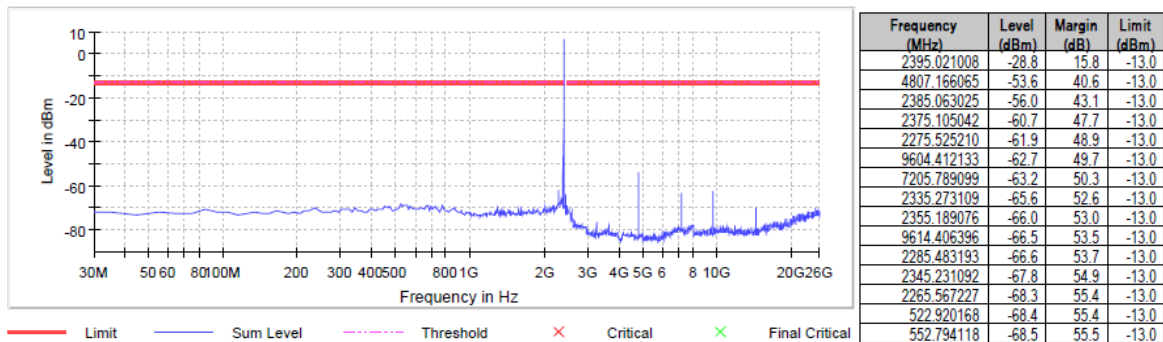

Radio Technology = Bluetooth LE 2 Mbps, Operating Frequency = mid  
(S01\_161\_AD01)

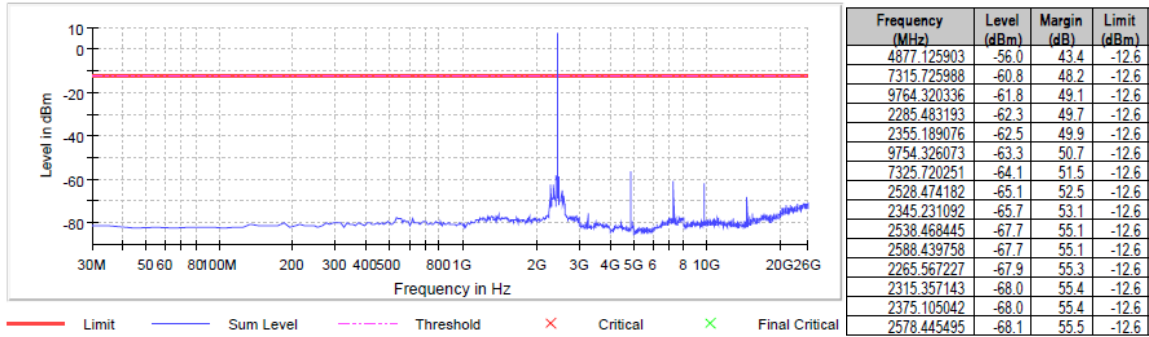

Radio Technology = Bluetooth LE 2 Mbps, Operating Frequency = high  
(S01\_161\_AD01)

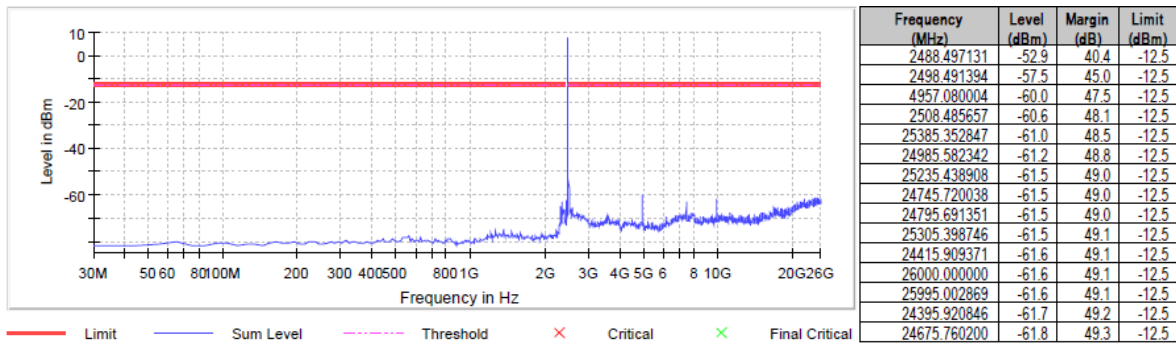

Radio Technology = WLAN b, Operating Frequency = low  
(S01\_161\_AD01)

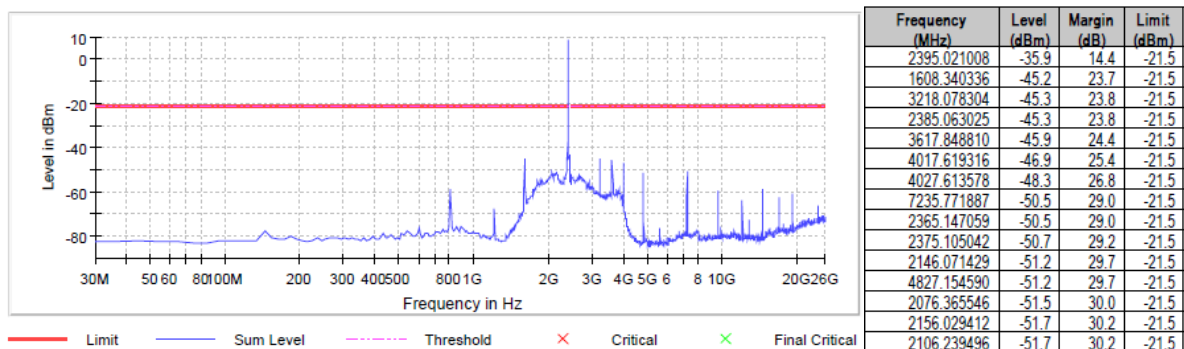

Radio Technology = WLAN b, Operating Frequency = mid  
(S01\_161\_AD01)

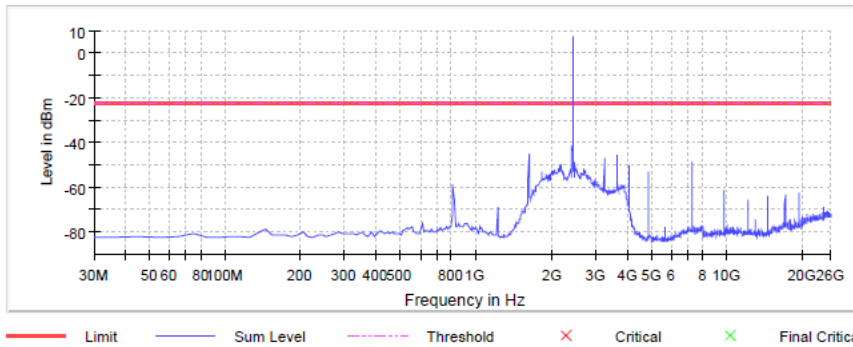

Frequency (MHz)	Level (dBm)	Margin (dB)	Limit (dBm)
1628.256303	-45.0	22.7	-22.3
3657.825861	-45.6	23.4	-22.3
3248.061092	-47.2	24.9	-22.3
7305.731725	-48.4	26.2	-22.3
7315.725988	-48.9	26.7	-22.3
2175.945378	-49.8	27.5	-22.3
4057.596366	-49.8	27.6	-22.3
4067.590629	-50.4	28.2	-22.3
2165.987395	-50.6	28.4	-22.3
2488.497131	-51.1	28.8	-22.3
2395.021008	-51.1	28.8	-22.3
2146.071429	-51.3	29.0	-22.3
2136.113445	-51.6	29.3	-22.3
2518.479919	-52.0	29.7	-22.3
2185.903361	-52.2	29.9	-22.3

Radio Technology = WLAN b, Operating Frequency = high  
(S01\_161\_AD01)

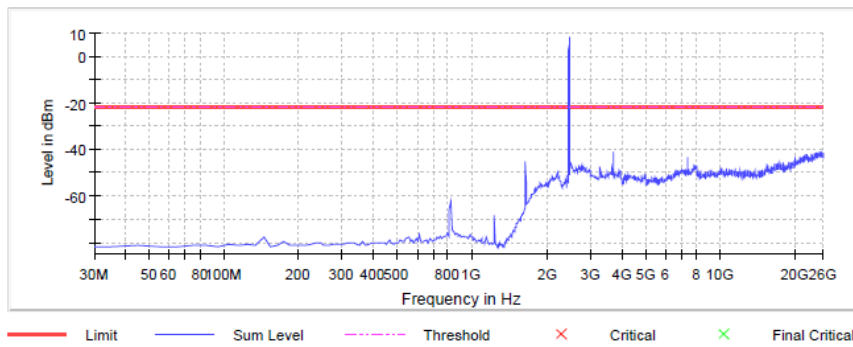

Frequency (MHz)	Level (dBm)	Margin (dB)	Limit (dBm)
25025.559392	-40.9	18.9	-22.0
25375.358585	-40.9	18.9	-22.0
25405.341373	-41.0	19.0	-22.0
3697.802911	-41.1	19.1	-22.0
25275.415958	-41.2	19.1	-22.0
25145.490544	-41.2	19.2	-22.0
24855.656927	-41.2	19.2	-22.0
24875.645453	-41.3	19.3	-22.0
25785.123353	-41.3	19.3	-22.0
24975.588079	-41.3	19.3	-22.0
25965.020081	-41.4	19.4	-22.0
25365.364322	-41.4	19.4	-22.0
25585.238100	-41.5	19.4	-22.0
25475.301211	-41.5	19.5	-22.0
23986.156077	-41.5	19.5	-22.0

Radio Technology = WLAN g, Operating Frequency = low  
(S01\_161\_AD01)

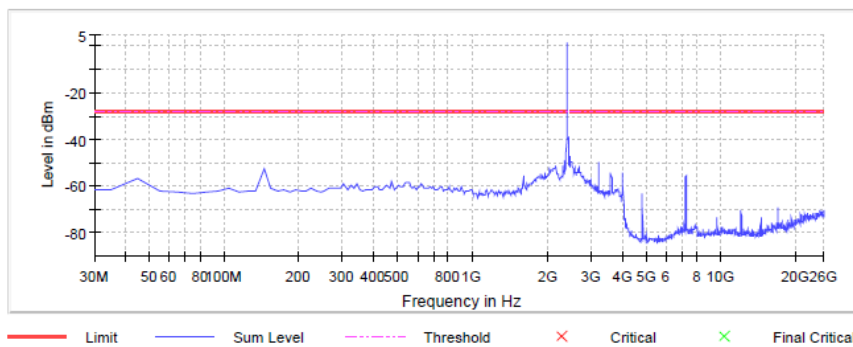

Frequency (MHz)	Level (dBm)	Margin (dB)	Limit (dBm)
2395.021008	-38.9	10.4	-28.5
2385.063025	-46.0	17.5	-28.5
2345.231092	-49.1	20.5	-28.5
2488.497131	-49.4	20.9	-28.5
3218.078304	-49.8	21.2	-28.5
2498.491394	-49.8	21.3	-28.5
2375.105042	-51.1	22.6	-28.5
2508.485657	-51.2	22.7	-28.5
2165.987395	-51.3	22.8	-28.5
2305.399160	-51.3	22.8	-28.5
2518.479919	-51.4	22.8	-28.5
2156.029412	-52.0	23.5	-28.5
2678.388122	-52.0	23.5	-28.5
2036.533613	-52.1	23.6	-28.5
2146.071429	-52.3	23.8	-28.5

Radio Technology = WLAN g, Operating Frequency = mid  
(S01\_161\_AD01)

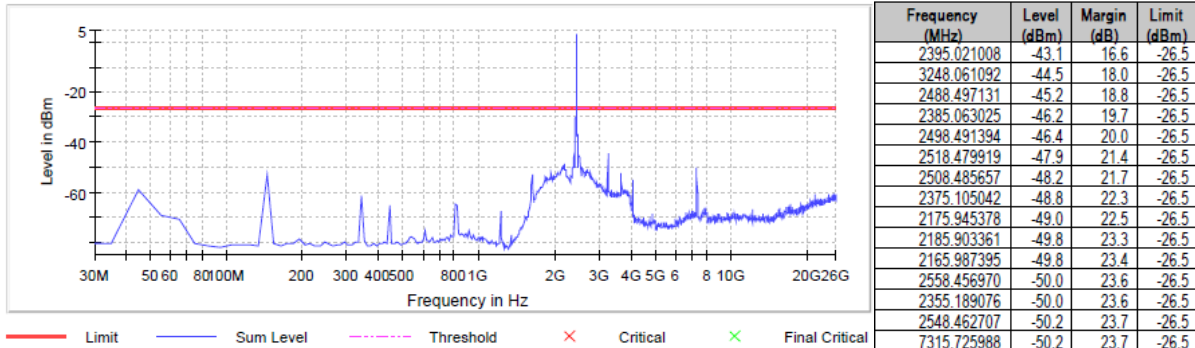

Radio Technology = WLAN g, Operating Frequency = high  
(S01\_161\_AD01)

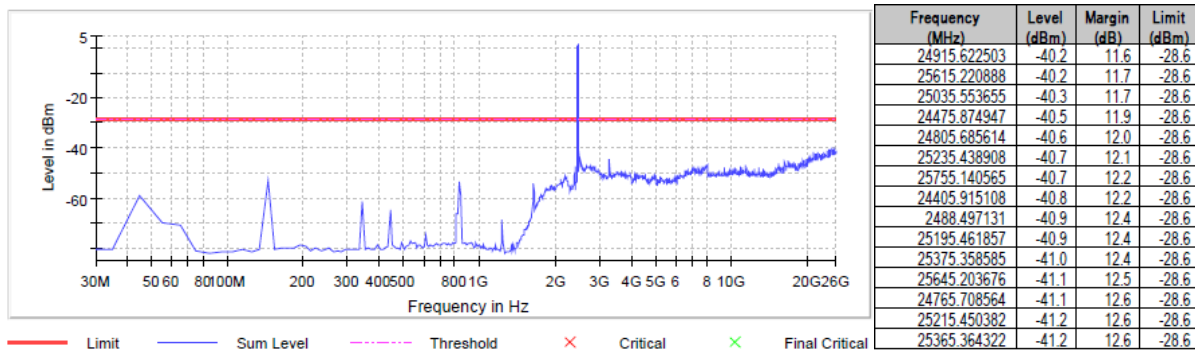

Radio Technology = WLAN n 20 MHz, Operating Frequency = low  
(S01\_161\_AD01)

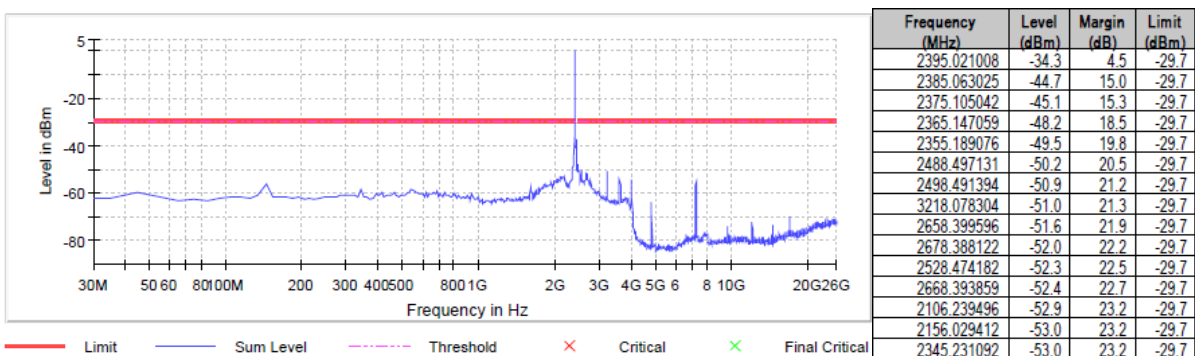



Radio Technology = WLAN n 20 MHz, Operating Frequency = mid  
(S01\_161\_AD01)

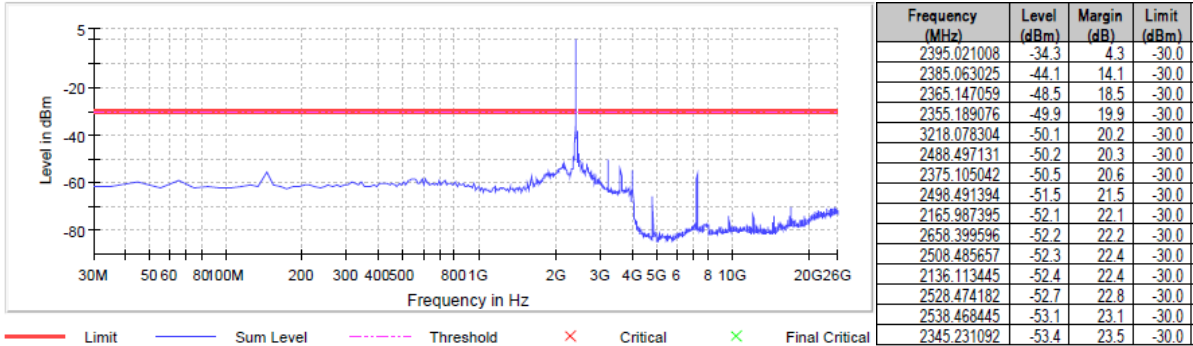

Radio Technology = WLAN n 20 MHz, Operating Frequency = high  
(S01\_161\_AD01)

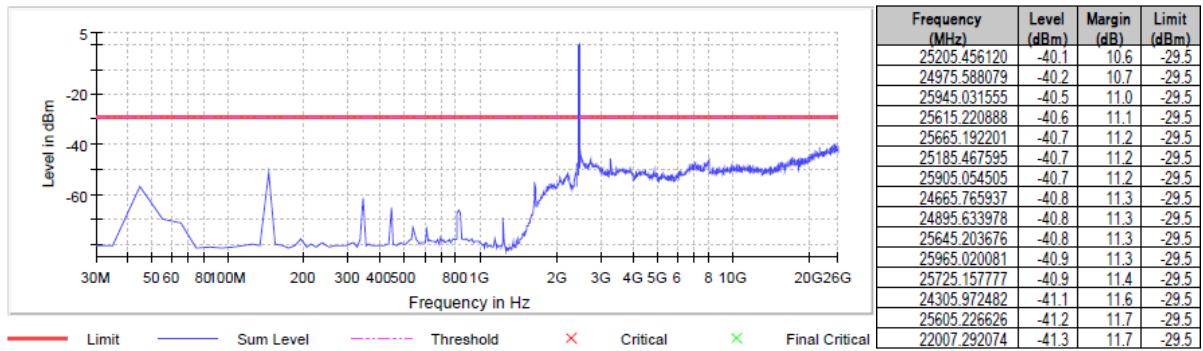

Radio Technology = WLAN n 40 MHz, Operating Frequency = low  
(S01\_161\_AD01)

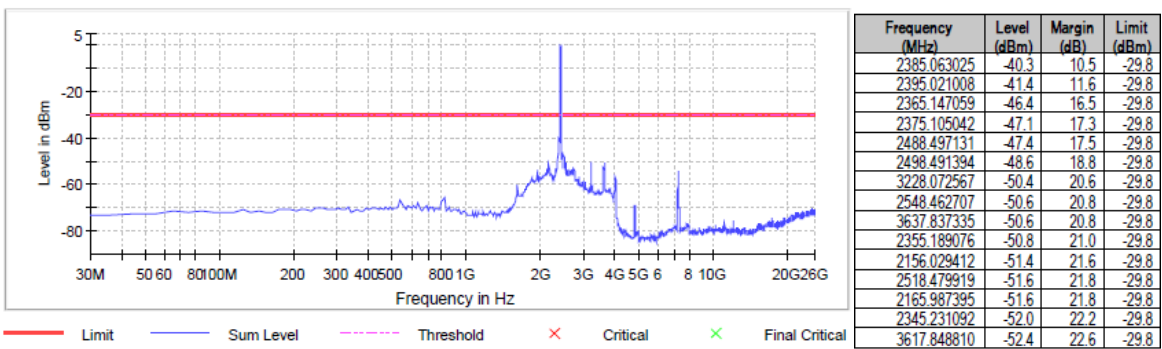

Radio Technology = WLAN n 40 MHz, Operating Frequency = mid  
(S01\_161\_AD01)

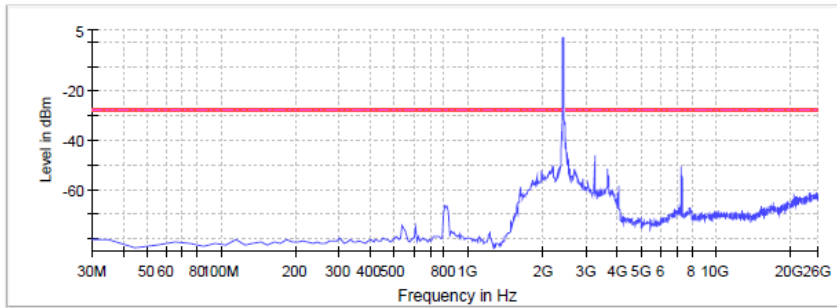

Frequency (MHz)	Level (dBm)	Margin (dB)	Limit (dBm)
2395.021008	-31.3	3.6	-27.7
2488.497131	-38.7	11.0	-27.7
2385.063025	-44.8	17.1	-27.7
2508.485657	-45.3	17.6	-27.7
3248.061092	-46.3	18.6	-27.7
2518.479919	-46.6	18.9	-27.7
2375.105042	-48.6	20.9	-27.7
2528.474182	-48.6	20.9	-27.7
2538.468445	-49.4	21.7	-27.7
2195.861345	-50.1	22.4	-27.7
2365.147059	-50.2	22.5	-27.7
2498.491394	-50.3	22.6	-27.7
2215.777311	-50.5	22.8	-27.7
7315.725988	-50.5	22.8	-27.7
2548.462707	-51.6	23.9	-27.7

Radio Technology = WLAN n 40 MHz, Operating Frequency = high  
(S01\_161\_AD01)

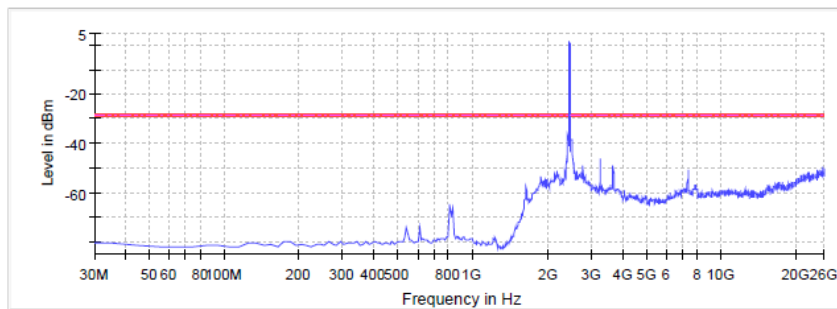

Frequency (MHz)	Level (dBm)	Margin (dB)	Limit (dBm)
2498.491394	-38.2	9.6	-28.6
2488.497131	-38.6	10.0	-28.6
2508.485657	-40.6	12.0	-28.6
2395.021008	-44.1	15.5	-28.6
2518.479919	-44.5	15.9	-28.6
3268.049618	-46.2	17.5	-28.6
2548.462707	-47.8	19.2	-28.6
2385.063025	-48.9	20.3	-28.6
2778.330748	-49.1	20.4	-28.6
3667.820123	-49.3	20.7	-28.6
25605.226626	-49.4	20.8	-28.6
2528.474182	-49.6	21.0	-28.6
2558.456970	-50.3	21.7	-28.6
25975.014343	-50.4	21.8	-28.6
25505.283999	-50.4	21.8	-28.6

### 5.5.5 TEST EQUIPMENT USED

- R&S TS8997

## 5.6 TRANSMITTER SPURIOUS RADIATED EMISSIONS

Standard **FCC Part 15 Subpart C**

**The test was performed according to:**  
ANSI C63.10

### 5.6.1 TEST DESCRIPTION

#### **Radiated Measurement with 50 Ohm termination at antenna ports**

The test set-up was made in accordance to the general provisions of ANSI C63.10 in a typical installation configuration. The measurements were performed according the following sub-chapters of ANSI C63.10:

- < 30 MHz: Chapter 6.4
- 30 MHz – 1 GHz: Chapter 6.5
- > 1 GHz: Chapter 6.6 (procedure according 6.6.5 used)

The measurement procedure is implemented into the EMI test software EMC32 from R&S. Exploratory tests are performed at 3 orthogonal axes to determine the worst-case orientation of a body-worn or handheld EUT. The final test on all kind of EUTs is also performed at 3 axes. A pre-check is performed while the EUT is powered.

#### **Below 1 GHz:**

The Equipment Under Test (EUT) was set up on a non-conductive table in the semi-anechoic chamber. The influence of the EUT support table that is used between 30–1000 MHz was evaluated.

#### **1. Measurement up to 30 MHz**

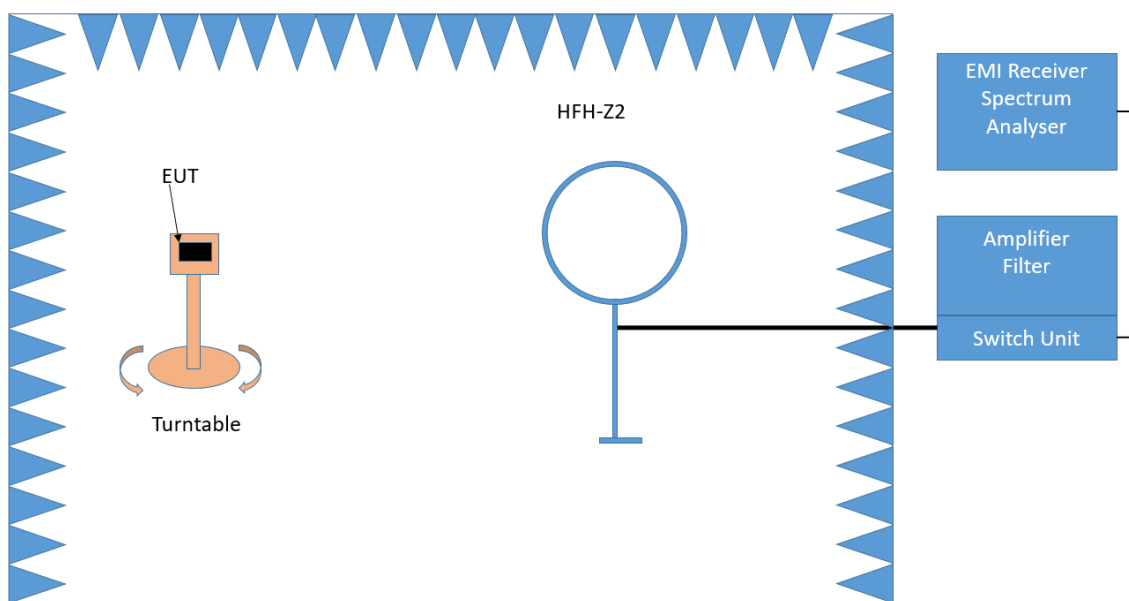

Test Setup; Spurious Emission Radiated (SAC), 9 kHz – 30 MHz

The Loop antenna HFH2-Z2 is used.



**Step 1:** pre measurement

- Anechoic chamber
- Antenna distance: 3 m
- Antenna height: 1 m
- Detector: Peak-Maxhold
- Frequency range: 0.009 - 0.15 MHz and 0.15 - 30 MHz
- Frequency steps: 0.05 kHz and 2.25 kHz
- IF-Bandwidth: 0.2 kHz and 9 kHz
- Measuring time / Frequency step: 100 ms (FFT-based)

Intention of this step is, to determine the radiated EMI-profile of the EUT. Afterwards the relevant emissions for the final measurement are identified.

**Step 2:** final measurement

For the relevant emissions determined in step 1, an additional measurement with the following settings will be performed. Intention of this step is to find the maximum emission level.

- Detector: Quasi-Peak (9 kHz - 150 kHz, Peak / Average 150 kHz- 30 MHz)
- Frequency range: 0.009 - 30 MHz
- Frequency steps: measurement at frequencies detected in step 1
- IF-Bandwidth: 0.2 - 10 kHz
- Measuring time / Frequency step: 1 s

**2. Measurement above 30 MHz and up to 1 GHz**

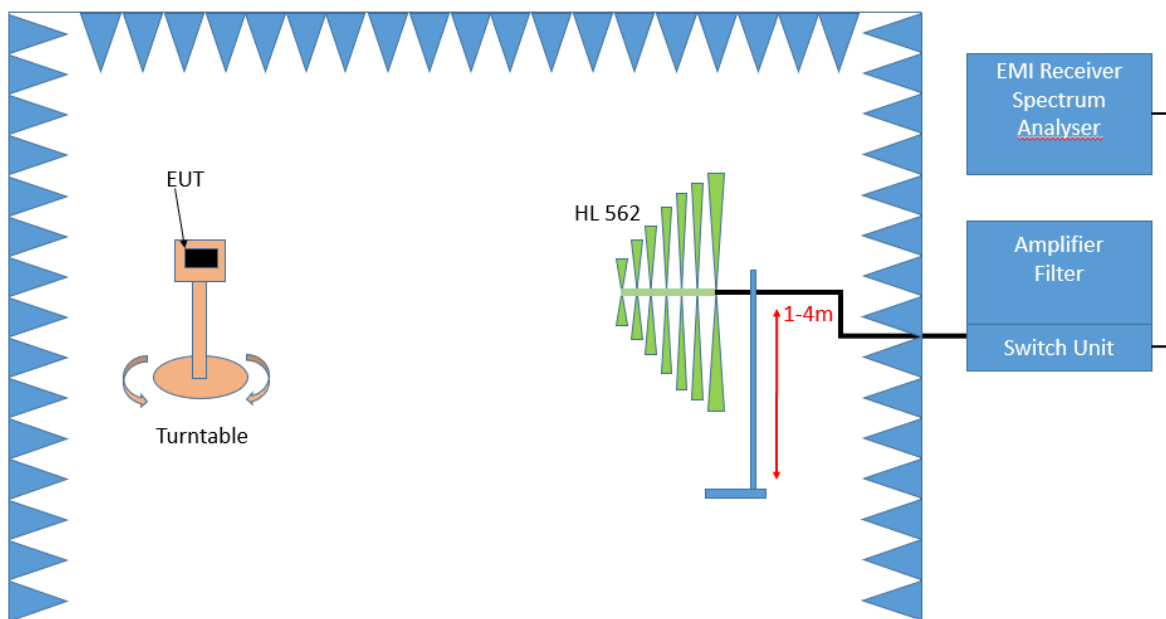

Test Setup; Spurious Emission Radiated (SAC), 30 MHz- 1GHz

**Step 1:** Preliminary scan

This is a preliminary test to identify the highest amplitudes relative to the limit.

Settings for step 1:

- Antenna distance: 3 m
- Detector: Peak-Maxhold / Quasipeak (FFT-based)
- Frequency range: 30 - 1000 MHz
- Frequency steps: 30 kHz
- IF-Bandwidth: 120 kHz
- Measuring time / Frequency step: 100 ms

- Turntable angle range:  $-180^{\circ}$  to  $90^{\circ}$
- Turntable step size:  $90^{\circ}$
- Height variation range: 1 – 4 m
- Height variation step size: 1.5 m
- Polarisation: Horizontal + Vertical

Intention of this step is, to determine the radiated EMI-profile of the EUT. Afterwards the relevant emissions for the final measurement are identified.

### **Step 2:** Adjustment measurement

In this step the accuracy of the turntable azimuth and antenna height will be improved. This is necessary to find out the maximum value of every frequency.

For each frequency, which was determined the turntable azimuth and antenna height will be adjusted. The turntable azimuth will slowly vary by  $\pm 45^{\circ}$  around this value. During this action, the value of emission is continuously measured. The turntable azimuth at the highest emission will be recorded and adjusted. In this position, the antenna height will also slowly vary by  $\pm 100$  cm around the antenna height determined. During this action, the value of emission is also continuously measured. The antenna height of the highest emission will also be recorded and adjusted.

- Detector: Peak – Maxhold
- Measured frequencies: in step 1 determined frequencies
- IF – Bandwidth: 120 kHz
- Measuring time: 100 ms
- Turntable angle range:  $360^{\circ}$
- Height variation range: 1 – 4 m
- Antenna Polarisation: max. value determined in step 1

### **Step 3:** Final measurement with QP detector

With the settings determined in step 2, the final measurement will be performed:

EMI receiver settings for step 3:

- Detector: Quasi-Peak ( $< 1$  GHz)
- Measured frequencies: in step 1 determined frequencies
- IF – Bandwidth: 120 kHz
- Measuring time: 1 s

After the measurement a plot will be generated which contains a diagram with the results of the preliminary scan and a chart with the frequencies and values of the results of the final measurement.

### Above 1 GHz:

The Equipment Under Test (EUT) was set up on a non-conductive support (tilt device) at 1.5 m height in the fully-anechoic chamber.

All steps were performed with one height (1.5 m) of the receiving antenna only.

### 3. Measurement above 1 GHz

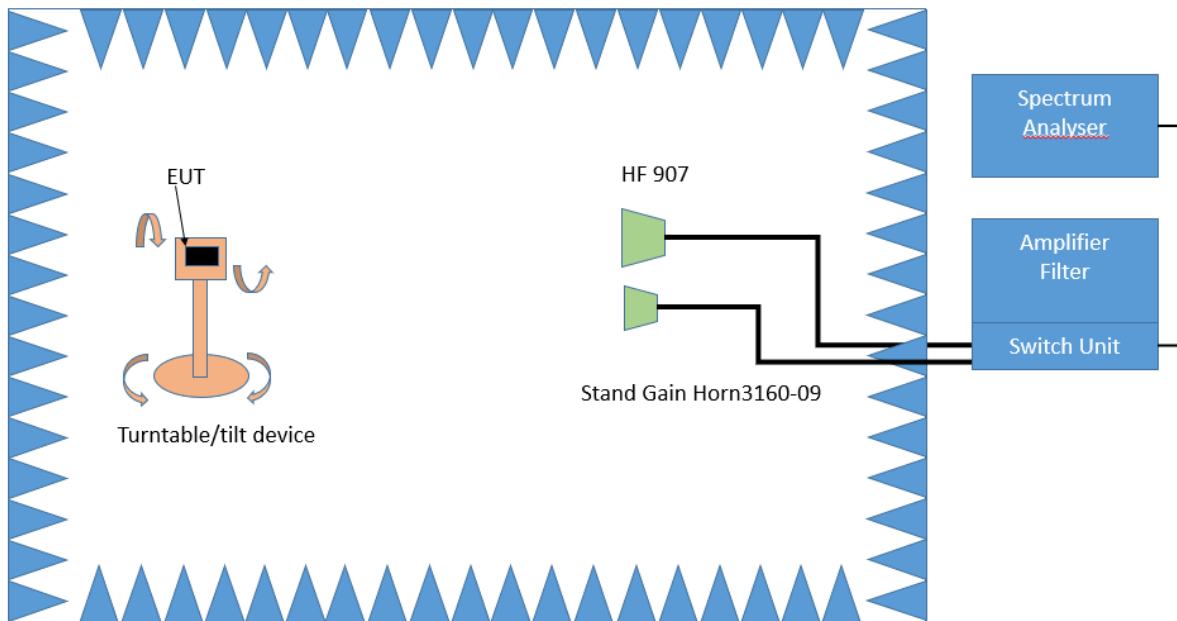

Test Setup; Spurious Emission Radiated (FAC), 1 GHz-26.5 GHz

#### Step 1:

The EUT is turned during the preliminary measurement across the elevation axis, with a step size of 90 °.

The turn table step size (azimuth angle) for the preliminary measurement is 45 °.

Spectrum analyser settings:

- Detector: Peak, Average
- RBW = 1 MHz
- VBW = 3 MHz

#### Step 2:

The turn table azimuth will slowly vary by  $\pm 22.5^\circ$ .

The elevation angle will slowly vary by  $\pm 45^\circ$

Spectrum analyser settings:

- Detector: Peak

#### Step 3:

Spectrum analyser settings for step 3:

- Detector: Peak / CISPR Average
- Measured frequencies: in step 1 determined frequencies
- RBW = 1 MHz
- VBW = 3 MHz
- Measuring time: 1 s

## Conducted Measurements at antenna ports

The Equipment Under Test (EUT) was set up to perform the spurious emissions measurements.

The EUT was connected to the test system as described in the block diagram below. The complete attenuation of the measurement path is known and considered.

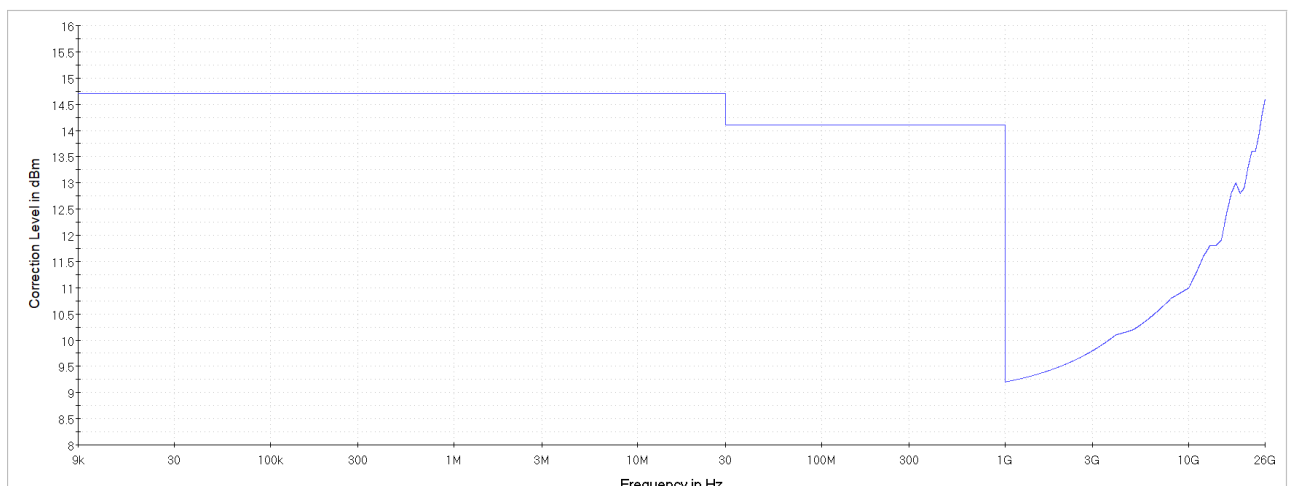
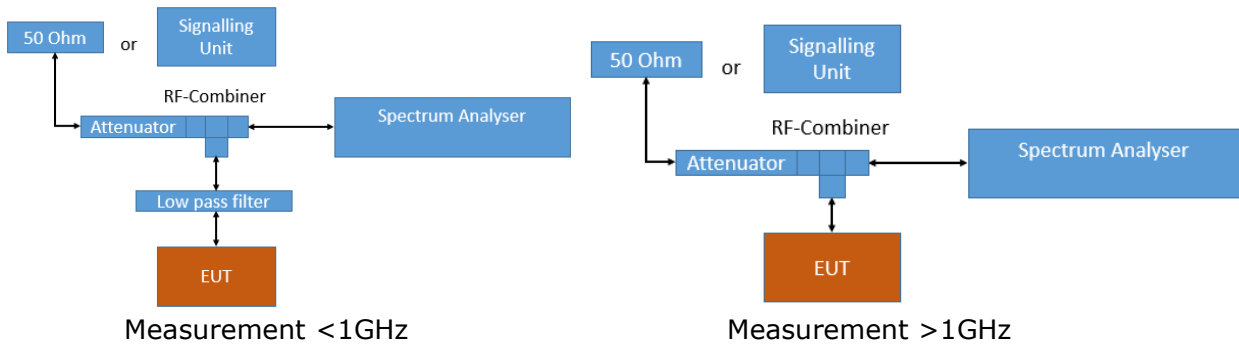

### Analyser settings:

- Frequency range: 0.009 – 30 MHz
  - Resolution Bandwidth (RBW): 10 kHz
  - Video Bandwidth (VBW): 30 kHz
  - Trace: Maxhold
  - Sweeps: till stable
  - Sweep Time: coupled
  - Detector: Peak
- 
- Frequency range: 30 – 1000 MHz
  - Resolution Bandwidth (RBW): 100 kHz
  - Video Bandwidth (VBW): 300 kHz
  - Trace: Maxhold
  - Sweeps: till stable
  - Sweep Time: coupled
  - Detector: Peak

- Frequency range: 1000 – 26000 MHz
- Resolution Bandwidth (RBW): 1000 kHz
- Video Bandwidth (VBW): 3000 kHz
- Trace: Maxhold, Average Power
- Sweeps: 500
- Sweep Time: coupled
- Detector: Peak, RMS

For the conducted emissions in restricted bands the Value is measured in dBm and then converted to dB $\mu$ V/m as given in KDB 558074:

1. Measure the conducted output power in dBm.
2. Add the maximum antenna gain in dBi. (Included in measurement result by offset)
3. Add the appropriate ground reflection factor (included in measurement result by transducer factor)
  - 6 dB for frequencies  $\leq$  30 MHz;
  - 4.7 dB for frequencies between 30 MHz and 1000 MHz, inclusive; and
  - 0 dB for frequencies  $>$  1000 MHz).
4. Convert the resultant EIRP level to an equivalent electric field strength level using the following relationship:  
$$E = \text{EIRP} - 20 \log D + 104.8$$
Where E is the electric field strength in dB $\mu$ V/m,  
EIRP is the equivalent isotropically radiated power in dBm  
D is the specified measurement distance in m

Value [dB $\mu$ V/m] = Measured value [dBm] (including gain and ground reflection factor) – 20 log D + 104.8

## 5.6.2 TEST REQUIREMENTS / LIMITS

FCC Part 15, Subpart C, §15.247 (d)

... In addition, radiated emissions which fall in the restricted bands, as defined in Section 15.205(a), must also comply with the radiated emission limits specified in Section 15.209(a) (see Section 15.205(c)).

FCC Part 15, Subpart C, §15.209, Radiated Emission Limits

Frequency in MHz	Limit ( $\mu\text{V}/\text{m}$ )	Measurement distance (m)	Limits ( $\text{dB}\mu\text{V}/\text{m}$ )
0.009 – 0.49	2400/F(kHz)@300m	3	(48.5 – 13.8)@300m
0.49 – 1.705	24000/F(kHz)@30m	3	(33.8 – 23.0)@30m
1.705 – 30	30@30m	3	29.5@30m

The measured values are corrected with an inverse linear distance extrapolation factor (40 dB/decade) according FCC 15.31 (2).

Frequency in MHz	Limit ( $\mu\text{V}/\text{m}$ )	Measurement distance (m)	Limits ( $\text{dB}\mu\text{V}/\text{m}$ )
30 – 88	100@3m	3	40.0@3m
88 – 216	150@3m	3	43.5@3m
216 – 960	200@3m	3	46.0@3m
960 - 26000	500@3m	3	54.0@3m
26000 - 40000	500@3m	1	54.0@3m

The measured values above 26 GHz are corrected with an inverse linear distance extrapolation factor (20 dB/decade).

§15.35(b) ..., there is also a limit on the radio frequency emissions, as measured using instrumentation with a peak detector function, corresponding to 20 dB above the maximum permitted average limit....

Used conversion factor:  $\text{Limit (dB}\mu\text{V}/\text{m)} = 20 \log (\text{Limit } (\mu\text{V}/\text{m})/1\mu\text{V}/\text{m})$

### 5.6.3 TEST PROTOCOL

Ambient temperature: 23 - 27 °C  
 Air Pressure: 977 - 1019 hPa  
 Humidity: 30 - 35 %  
 BT GFSK  
 Applied duty cycle correction (AV): 0.1 dB

Measurement Method	Ch. Center Freq. [MHz]	Spurious Freq. [MHz]	Spurious Level [dBµV/m]	Detector	RBW [kHz]	Limit [dBµV/m]	Margin to Limit [dB]	Limit Type
Radiated	2402	4803.7	40.1	AV	1000	54.0	13.9	RB
Radiated	2402	4803.7	53.5	PEAK	1000	74.0	20.5	RB
Conducted	2402	4803.8	48.3	PEAK	1000	74.0	25.7	RB
Conducted	2402	4804.1	43.9	AV	1000	54.0	10.1	RB
Radiated	2441	4882.0	39.9	AV	1000	54.0	14.1	RB
Radiated	2441	4881.3	53.7	PEAK	1000	74.0	20.3	RB
Radiated	2441	7323.0	56.0	PEAK	1000	74.0	18.0	RB
Radiated	2441	7323.0	42.4	AV	1000	54.0	11.6	RB
Conducted	2441	4882.1	47.0	PEAK	1000	74.0	27.0	RB
Conducted	2441	4882.1	41.6	AV	1000	54.0	12.4	RB
Radiated	2480	4960.0	51.5	PEAK	1000	74.0	22.5	RB
Radiated	2480	4960.0	44.9	AV	1000	54.0	9.1	RB
Conducted	2480	4960.1	46.9	PEAK	1000	74.0	27.1	RB
Conducted	2480	4960.1	39.6	AV	1000	54.0	14.4	RB

BT n/4 DQPSK  
 Applied duty cycle correction (AV): 0.2 dB

Measurement Method	Ch. Center Freq. [MHz]	Spurious Freq. [MHz]	Spurious Level [dBµV/m]	Detector	RBW [kHz]	Limit [dBµV/m]	Margin to Limit [dB]	Limit Type
Conducted	2402	4804.3	47.2	PEAK	1000	74.0	26.8	RB
Conducted	2402	4803.8	39.6	AV	1000	54.0	14.4	RB
Conducted	2441	4881.6	46.3	PEAK	1000	74.0	27.7	RB
Conducted	2441	4882.3	37.6	AV	1000	54.0	16.4	RB
Conducted	2480	4959.8	46.4	PEAK	1000	74.0	27.6	RB
Conducted	2480	4960.1	36.5	AV	1000	54.0	17.5	RB

BT 8-DPSK  
 Applied duty cycle correction (AV): 0.3 dB

Measurement Method	Ch. Center Freq. [MHz]	Spurious Freq. [MHz]	Spurious Level [dBµV/m]	Detector	RBW [kHz]	Limit [dBµV/m]	Margin to Limit [dB]	Limit Type
Conducted	2402	4804.1	47.1	PEAK	1000	74.0	26.9	RB
Conducted	2402	4804.1	39.7	AV	1000	54.0	14.3	RB
Conducted	2441	4882.8	45.7	PEAK	1000	74.0	28.3	RB
Conducted	2441	4882.1	38.1	AV	1000	54.0	15.9	RB
Conducted	2480	4960.1	45.5	PEAK	1000	74.0	28.5	RB
Conducted	2480	4960.3	36.6	AV	1000	54.0	17.4	RB

BT LE 1 Mbit/s  
Applied duty cycle correction (AV): 1.4 dB

Measurement Method	Ch. Center Freq. [MHz]	Spurious Freq. [MHz]	Spurious Level [dBµV/m]	Detector	RBW [kHz]	Limit [dBµV/m]	Margin to Limit [dB]	Limit Type
Conducted	2402	4804.1	48.9	PEAK	1000	74.0	25.1	RB
Conducted	2402	4804.1	42.9	AV	1000	54.0	11.1	RB
Conducted	2440	4880.3	47.6	PEAK	1000	74.0	26.4	RB
Conducted	2440	4880.3	41.8	AV	1000	54.0	12.2	RB
Conducted	2480	4960.3	47.0	PEAK	1000	74.0	27.1	RB
Conducted	2480	4960.3	39.9	AV	1000	54.0	14.2	RB

BT LE 2 Mbit/s  
Applied duty cycle correction (AV): 7.4 dB

Measurement Method	Ch. Center Freq. [MHz]	Spurious Freq. [MHz]	Spurious Level [dBµV/m]	Detector	RBW [kHz]	Limit [dBµV/m]	Margin to Limit [dB]	Limit Type
Conducted	2402	4803.3	48.3	PEAK	1000	74.0	25.7	RB
Conducted	2402	4803.1	45.6	AV	1000	54.0	8.5	RB
Conducted	2440	4879.3	47.2	PEAK	1000	74.0	26.8	RB
Conducted	2440	4879.3	44.6	AV	1000	54.0	9.4	RB
Conducted	2480	4959.3	46.8	PEAK	1000	74.0	27.2	RB
Conducted	2480	4959.1	43.7	AV	1000	54.0	10.3	RB

WLAN b-Mode; 20 MHz; 1 Mbit/s  
Applied duty cycle correction (AV): 0 dB

Measurement Method	Ch. Center Freq. [MHz]	Spurious Freq. [MHz]	Spurious Level [dBµV/m]	Detector	RBW [kHz]	Limit [dBµV/m]	Margin to Limit [dB]	Limit Type
Radiated	2412	12061.8	55.7	PEAK	1000	74.0	18.3	RB
Radiated	2412	12061.8	47.7	AV	1000	54.0	6.3	RB
Conducted	2412	148.7	33.8	PEAK	120	43.5	9.7	RB
Conducted	2412	742.7	32.0	PEAK	120	46.0	14.0	RB
Conducted	2412	805.7	41.6	PEAK	120	46.0	4.4	RB
Conducted	2412	1608.1	53.4	PEAK	1000	74.0	20.6	RB
Conducted	2412	1608.1	49.7	AV	1000	54.0	4.3	RB
Conducted	2412	3618.6	55.9	PEAK	1000	74.0	18.1	RB
Conducted	2412	3618.1	49.1	AV	1000	54.0	4.9	RB
Conducted	2412	4018.8	55.7	PEAK	1000	74.0	18.3	RB
Conducted	2412	4018.6	50.4	AV	1000	54.0	3.6	RB
Conducted	2437	148.7	32.3	PEAK	120	43.5	11.2	RB
Conducted	2437	742.7	32.0	PEAK	120	46.0	14.0	RB
Conducted	2437	811.5	40.4	PEAK	120	46.0	5.6	RB
Conducted	2437	1624.6	53.5	PEAK	1000	74.0	20.5	RB
Conducted	2437	1624.6	49.4	AV	1000	54.0	4.6	RB
Conducted	2437	3655.9	57.8	PEAK	1000	74.0	16.2	RB
Conducted	2437	3655.6	49.1	AV	1000	54.0	4.9	RB
Conducted	2437	7312.3	55.9	PEAK	1000	74.0	18.1	RB
Conducted	2437	7312.3	49.1	AV	1000	54.0	4.9	RB
Radiated	2462	12311.2	56.6	PEAK	1000	74.0	17.4	RB
Radiated	2462	12311.2	49.5	AV	1000	54.0	4.5	RB
Conducted	2462	148.7	32.4	PEAK	120	43.5	11.1	RB
Conducted	2462	742.7	32.5	PEAK	120	46.0	13.5	RB
Conducted	2462	812.2	37.6	PEAK	120	46.0	8.4	RB
Conducted	2462	1641.6	53.1	PEAK	1000	74.0	20.9	RB
Conducted	2462	1641.4	48.9	AV	1000	54.0	5.1	RB
Conducted	2462	3693.1	58.2	PEAK	1000	74.0	15.8	RB
Conducted	2462	3693.1	49.3	AV	1000	54.0	4.7	RB
Conducted	2462	7387.6	57.2	PEAK	1000	74.0	16.8	RB
Conducted	2462	7387.8	50.8	AV	1000	54.0	3.2	RB



WLAN g-Mode; 20 MHz; 6 Mbit/s  
Applied duty cycle correction (AV): 0.1 dB

Measurement Method	Ch. Center Freq. [MHz]	Spurious Freq. [MHz]	Spurious Level [dBµV/m]	Detector	RBW [kHz]	Limit [dBµV/m]	Margin to Limit [dB]	Limit Type
Conducted	2412	1614.1	50.1	PEAK	1000	74.0	23.9	RB
Conducted	2412	1608.1	39.2	AV	1000	54.0	14.8	RB
Conducted	2412	3621.9	54.7	PEAK	1000	74.0	19.3	RB
Conducted	2412	3618.1	42.0	AV	1000	54.0	12.0	RB
Conducted	2412	4017.3	53.2	PEAK	1000	74.0	20.8	RB
Conducted	2412	4018.6	42.2	AV	1000	54.0	11.8	RB
Conducted	2437	1624.6	51.7	PEAK	1000	74.0	22.3	RB
Conducted	2437	1624.6	42.5	AV	1000	54.0	11.5	RB
Conducted	2437	3653.9	57.5	PEAK	1000	74.0	16.5	RB
Conducted	2437	3655.6	43.2	AV	1000	54.0	10.8	RB
Conducted	2437	4064.6	51.1	PEAK	1000	74.0	22.9	RB
Conducted	2437	4059.8	40.7	AV	1000	54.0	13.3	RB
Conducted	2437	7316.8	56.1	PEAK	1000	74.0	17.9	RB
Conducted	2437	7313.6	44.6	AV	1000	54.0	9.4	RB

WLAN n-Mode; 20 MHz; MCS 0  
Applied duty cycle correction (AV): 0.1 dB

Measurement Method	Ch. Center Freq. [MHz]	Spurious Freq. [MHz]	Spurious Level [dBµV/m]	Detector	RBW [kHz]	Limit [dBµV/m]	Margin to Limit [dB]	Limit Type
Conducted	2412	1608.1	47.6	PEAK	1000	74.0	26.5	RB
Conducted	2412	1608.1	38.2	AV	1000	54.0	15.8	RB
Conducted	2412	3616.1	54.7	PEAK	1000	74.0	19.3	RB
Conducted	2412	3618.1	41.0	AV	1000	54.0	13.0	RB
Conducted	2412	4017.3	50.6	PEAK	1000	74.0	23.4	RB
Conducted	2412	4018.6	41.1	AV	1000	54.0	12.9	RB
Conducted	2437	1624.6	49.3	PEAK	1000	74.0	24.7	RB
Conducted	2437	1624.6	39.9	AV	1000	54.0	14.1	RB
Conducted	2437	3657.6	56.4	PEAK	1000	74.0	17.6	RB
Conducted	2437	3655.6	42.0	AV	1000	54.0	12.0	RB
Conducted	2437	4058.3	50.2	PEAK	1000	74.0	23.8	RB
Conducted	2437	4059.8	39.2	AV	1000	54.0	14.8	RB
Conducted	2437	7305.8	55.5	PEAK	1000	74.0	18.5	RB
Conducted	2437	7312.1	43.1	AV	1000	54.0	10.9	RB

WLAN n-Mode; 40 MHz; MCS 0  
Applied duty cycle correction (AV): 0.1 dB

Measurement Method	Ch. Center Freq. [MHz]	Spurious Freq. [MHz]	Spurious Level [dBµV/m]	Detector	RBW [kHz]	Limit [dBµV/m]	Margin to Limit [dB]	Limit Type
Conducted	2437	1624.9	48.0	PEAK	1000	74.0	26.0	RB
Conducted	2437	1624.6	38.8	AV	1000	54.0	15.2	RB
Conducted	2437	3660.4	53.2	PEAK	1000	74.0	20.8	RB
Conducted	2437	3655.6	40.2	AV	1000	54.0	13.8	RB
Conducted	2437	4044.3	48.4	PEAK	1000	74.0	25.6	RB
Conducted	2437	4045.6	37.6	AV	1000	54.0	16.4	RB
Conducted	2437	7296.8	52.2	PEAK	1000	74.0	21.8	RB
Conducted	2437	7308.3	41.3	AV	1000	54.0	12.7	RB

Remark: Please see next sub-clause for the measurement plot.

### 5.6.4 MEASUREMENT PLOT (EXAMPLE PLOT, SHOWING WORST CASE, IF APPLICABLE)

Radio Technology = Bluetooth BDR, Operating Frequency = low, Measurement range = 9 kHz - 30 MHz  
(S01\_161\_AA01)

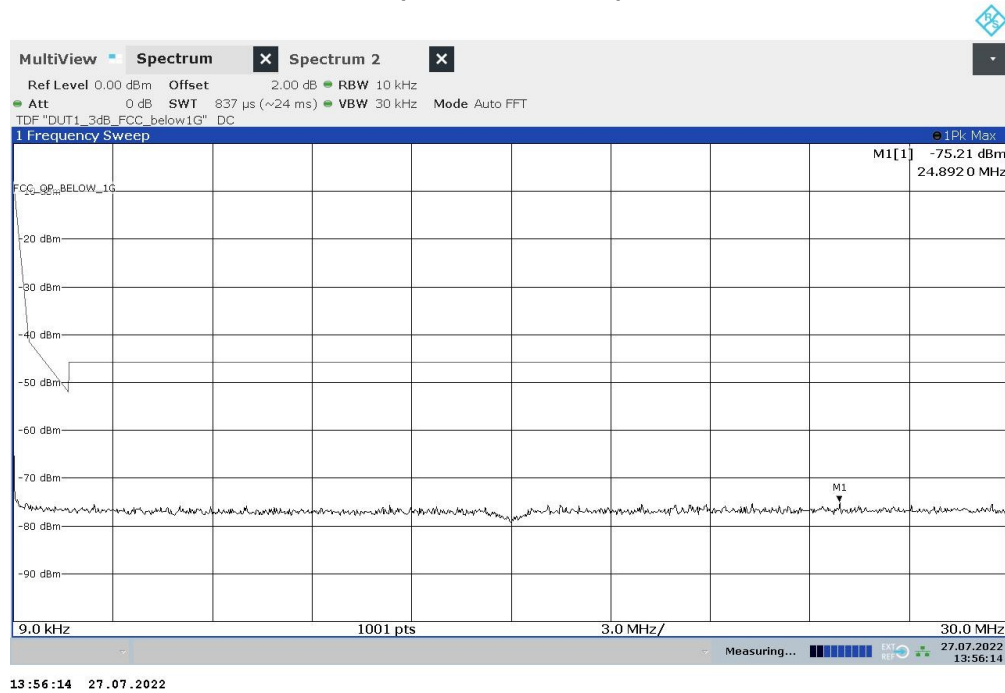

Radio Technology = Bluetooth BDR, Operating Frequency = mid, Measurement range = 9 kHz - 30 MHz  
(S01\_161\_AA01)

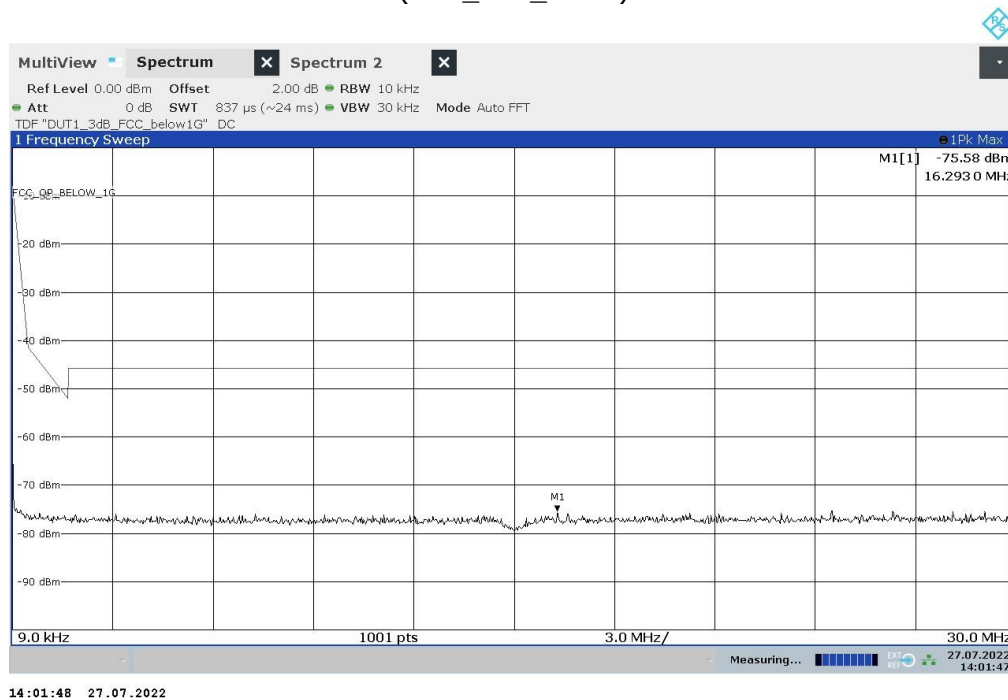

Radio Technology = Bluetooth BDR, Operating Frequency = mid, Measurement range = 9 kHz - 30 MHz  
(S02\_161\_AB01)

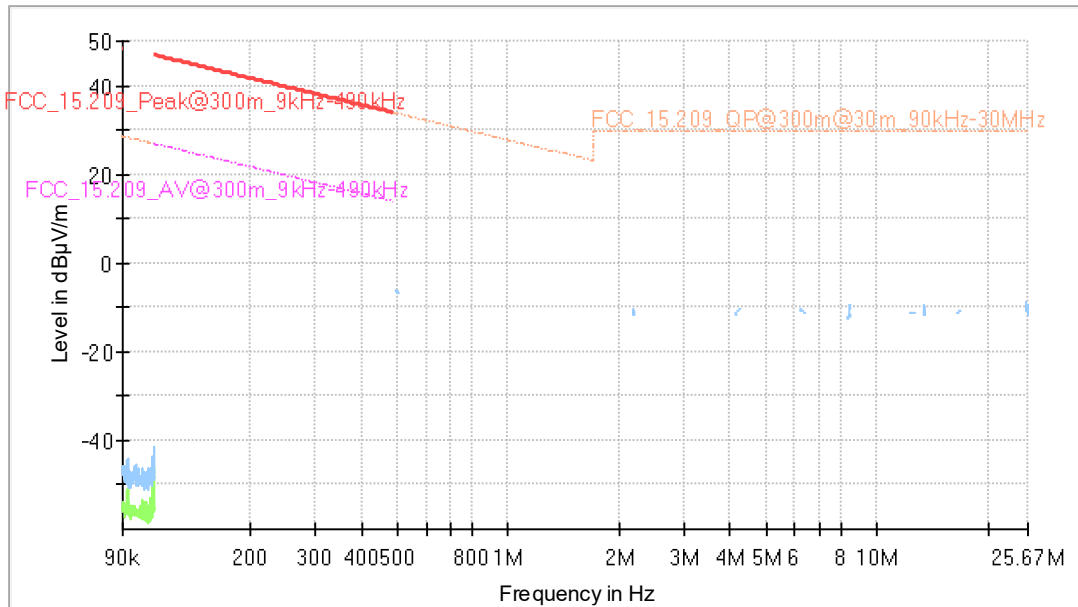

### Final Result

Frequency (MHz)	MaxPeak (dBµV/m)	QuasiPeak (dBµV/m)	Limit (dBµV/m)	Margin (dB)	Meas. Time (ms)	Bandwidth (kHz)	Height (cm)	Azimuth (deg)	Corr. (dB/m)
---	---	---	---	---	---	---	---	---	---

Radio Technology = Bluetooth BDR, Operating Frequency = high, Measurement range = 9 kHz - 30 MHz  
(S01\_161\_AA01)

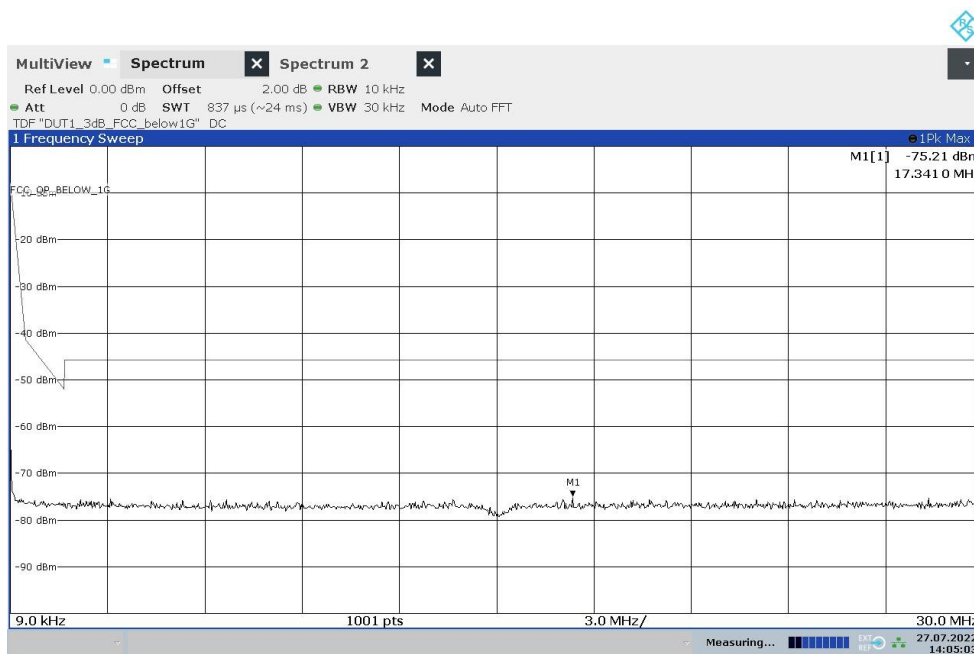

14:05:03 27.07.2022

Radio Technology = WLAN b, Operating Frequency = low, Measurement range = 9 kHz - 30 MHz  
(S01\_161\_AD01)

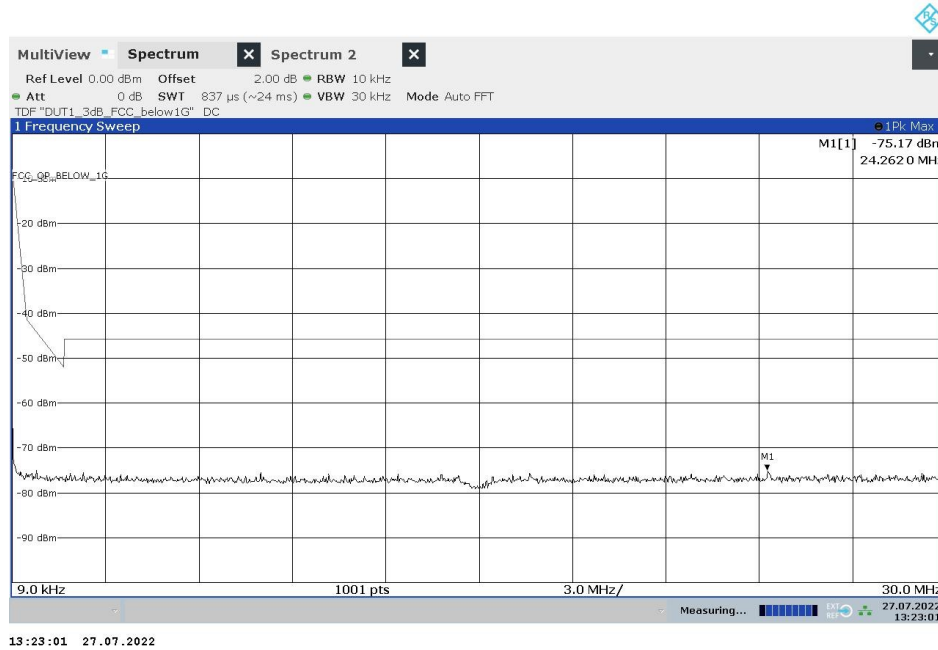

Radio Technology = WLAN b, Operating Frequency = mid, Measurement range = 9 kHz - 30 MHz  
(S01\_161\_AD01)

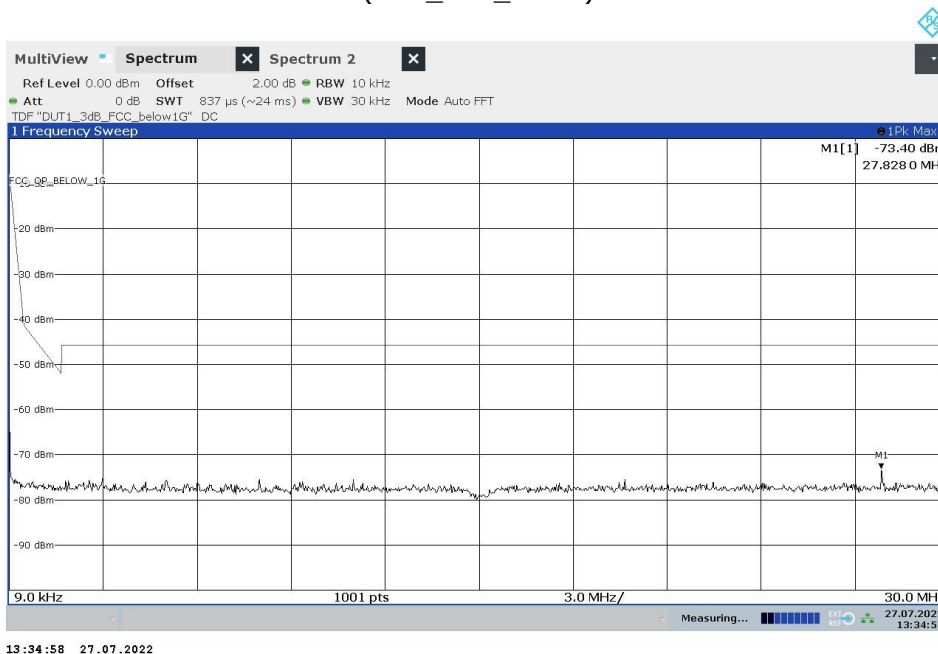

Radio Technology = WLAN b, Operating Frequency = mid, Measurement range = 9 kHz - 30 MHz  
 (S02\_161\_AB01)

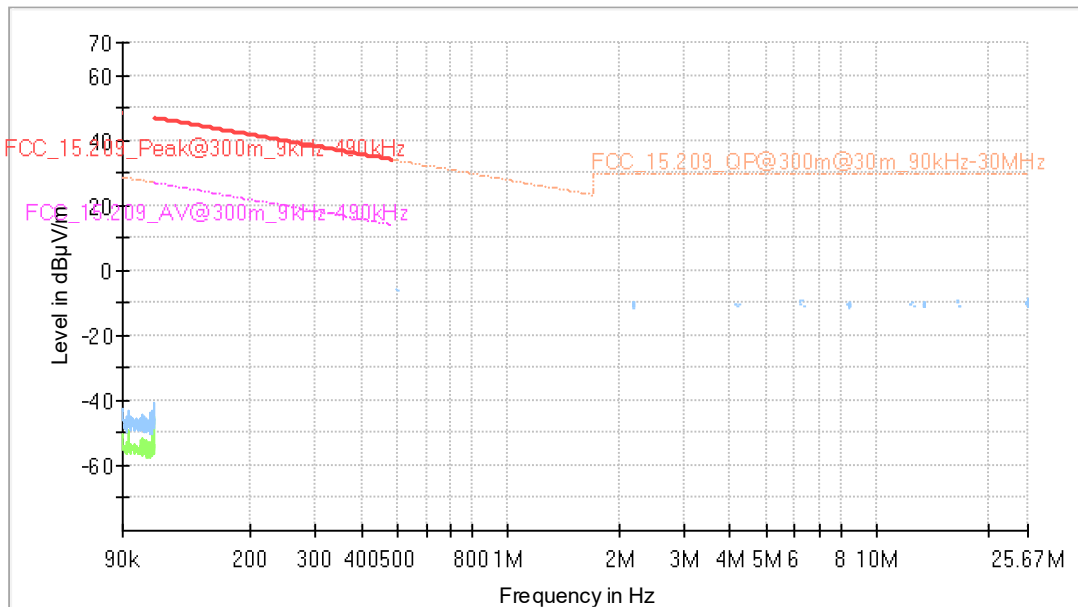

### Final Result

Frequency (MHz)	MaxPeak (dBµV/m)	QuasiPeak (dBµV/m)	Limit (dBµV/m)	Margin (dB)	Meas. Time (ms)	Bandwidth (kHz)	Height (cm)	Azimuth (deg)	Corr. (dB/m)
---	---	---	---	---	---	---	---	---	---

Radio Technology = WLAN b, Operating Frequency = high, Measurement range = 9 kHz - 30 MHz  
 (S01\_161\_AD01)

