

FCC Measurement/Technical Report on

LISA-U201

FCC ID: XPYLISAU201

IC: 8595A-LISAU201

Test Report Reference: MDE_UBLOX_1918_FCC02

Test Laboratory:

7layers GmbH
Borsigstrasse 11
40880 Ratingen
Germany



Note:

The following test results relate only to the devices specified in this document. This report shall not be reproduced in parts without the written approval of the test laboratory.

7layers GmbH
Borsigstraße 11
40880 Ratingen, Germany
T +49 (0) 2102 749 0
F +49 (0) 2102 749 350

Geschäftsführer/
Managing Directors:
Frank Spiller
Bernhard Retka
Alexandre Norré-Oudard

Registergericht/registered:
Düsseldorf HRB 75554
USt-Id.-Nr./VAT-No. DE203159652
Steuer-Nr./TAX-No. 147/5869/0385

*a Bureau Veritas
Group Company*
www.7layers.com

Table of Contents

1	Applied Standards and Test Summary	3
1.1	Applied Standards	3
1.2	FCC-IC Correlation Table	5
1.3	Measurement Summary / Signatures	7
2	Revision History	9
3	Administrative Data	10
3.1	Testing Laboratory	10
3.2	Project Data	10
3.3	Applicant Data	10
3.4	Manufacturer Data	10
4	Test object Data	11
4.1	General EUT Description	11
4.2	EUT Main components	11
4.3	Ancillary Equipment	11
4.4	Auxiliary Equipment	12
4.5	EUT Setups	12
4.6	Operating Modes	12
4.7	Product labelling	13
5	Test Results	14
5.1	RF Output power	14
5.2	Field strength of spurious radiation	16
5.3	Band edge compliance	22
5.4	RF Output power	25
5.5	Field strength of spurious radiation	28
5.6	Band edge compliance	34
6	Antenna Factors, Cable Loss and Sample Calculations	42
6.1	LISN R&S ESH3-Z5 (150 kHz – 30 MHz)	42
6.2	Antenna R&S HFH2-Z2 (9 kHz – 30 MHz)	43
6.3	Antenna R&S HL562 (30 MHz – 1 GHz)	44
6.4	Antenna R&S HF907 (1 GHz – 18 GHz)	45
6.5	Antenna EMCO 3160-09 (18 GHz – 26.5 GHz)	46
6.6	Antenna EMCO 3160-10 (26.5 GHz – 40 GHz)	47
7	Measurement Uncertainties	48
8	Photo Report	49

1 APPLIED STANDARDS AND TEST SUMMARY

1.1 APPLIED STANDARDS

Type of Authorization

Certification for a cellular mobile device.

Applicable FCC Rules

Prepared in accordance with the requirements of FCC Rules and Regulations as listed in 47 CFR Ch.1 Parts 2 and 24, (10/1/18 Edition). The following subparts are applicable to the results in this test report.

Part 2, Subpart J - Equipment Authorization Procedures, Certification

Part 24, Subpart E - Broadband PCS

§ 24.232 - Power and antenna height limits

§ 24.235 - Frequency stability

§ 24.238 - Emission limitations for Broadband PCS equipment

The tests were selected and performed with reference to:

- FCC Public Notice 971168 applying "Measurement guidance for certification of licensed digital transmitters" 971168 D01 v03r01, 2018-04-09
- ANSI C63.26: 2015

Type of Authorization

Certification for a cellular mobile device.

Applicable FCC Rules

Prepared in accordance with the requirements of FCC Rules and Regulations as listed in 47 CFR Ch.1 Parts 2 and 22, (10/1/18 Edition). The following subparts are applicable to the results in this test report.

Part 2, Subpart J - Equipment Authorization Procedures, Certification

Part 22, Subpart H - Cellular Radiotelephone Service

§ 22.905 - Channels for cellular service

§ 22.913 - Effective radiated power limits

§ 22.917 - Emission limitations for cellular equipment

The tests were selected and performed with reference to:

- FCC Public Notice 971168 applying "Measurement guidance for certification of licensed digital transmitters" 971168 D01 v03r01, 2018-04-09
- ANSI C63.26: 2015

Summary Test Results:

The EUT complied with all performed tests as listed in chapter 1.3 Measurement Summary / Signatures.

1.2 FCC-IC CORRELATION TABLE

**Correlation of measurement requirements for
Cellular Mobile Devices
from
FCC and ISED Canada**

Measurement	FCC reference	ISED reference
RF Output Power	§ 2.1046 § 24.232	RSS-GEN Issue 5, 6.12 RSS-133 Issue 6, 6.4
Peak-Average-Ratio	§ 24.232	RSS 133 Issue 6: 6.4
Emission and Occupied bandwidth	§ 2.1049	RSS-GEN Issue 5, 6.7
Spurious Emission at Antenna Terminals	§ 2.1051 § 24.238	RSS-GEN Issue 5, 6.13 RSS-133 Issue 6, 6.5
Band Edge Compliance	§ 2.1051 § 24.238	RSS-GEN Issue 5, 6.13 RSS-133 Issue 6, 6.5
Frequency stability	§ 2.1055 § 24.235	RSS-GEN Issue 5, 6.11 RSS-133 Issue 6: 6.3
Field strength of spurious radiation	§ 2.1053 § 24.236	RSS-GEN Issue 5, 6.13 RSS-133 Issue 6: 6.5

**Correlation of measurement requirements for
Cellular Mobile Devices
from
FCC and ISED Canada**

Measurement	FCC reference	ISED reference
RF Output Power	§ 2.1046 § 22.913	RSS-GEN Issue 5, 6.12 RSS-132 Issue 3, 5.4
Peak-Average-Ratio	-	RSS 132 Issue 3: 5.4
Emission and Occupied bandwidth	§ 2.1049	RSS-GEN Issue 5, 6.7
Spurious Emission at Antenna Terminals	§ 2.1051 § 22.917	RSS-GEN Issue 5, 6.13 RSS-132 Issue 3, 5.5
Band Edge Compliance	§ 2.1051 § 22.917	RSS-GEN Issue 5, 6.13 RSS-132 Issue 3, 5.5
Frequency stability	§ 2.1055 § 22.355	RSS-GEN Issue 5, 6.11 RSS-132 Issue 3: 5.3
Field strength of spurious radiation	§ 2.1053 § 22.917	RSS-GEN Issue 5, 6.13 RSS-132 Issue 3: 5.5

1.3 MEASUREMENT SUMMARY / SIGNATURES

47 CFR CHAPTER I FCC PART 22 § 2.1046 § 22.913 Subpart H

RF Output power

The measurement was performed according to ANSI C63.26: 2015

Final Result

OP-Mode	Setup	Date	FCC	IC
Technology, Radio Technology, Test, Operating Frequency, ChBW, Measurement method				
GSM, GSM 850 EDGE, mid channel, 0.2 MHz, conducted	ac01	2019-08-07	Passed	Passed
GSM, GSM 850, mid channel, 0.2 MHz, conducted	ac01	2019-08-07	Passed	Passed
UTRA, FDD V HSDPA, Subtest 1, mid channel, 5 MHz, conducted	ac01	2019-08-07	Passed	Passed
UTRA, FDD V HSDPA, Subtest 2, mid channel, 5 MHz, conducted	ac01	2019-08-07	Passed	Passed
UTRA, FDD V HSDPA, Subtest 3, mid channel, 5 MHz, conducted	ac01	2019-08-07	Passed	Passed
UTRA, FDD V HSDPA, Subtest 4, mid channel, 5 MHz, conducted	ac01	2019-08-07	Passed	Passed
UTRA, FDD V HSUPA, Subtest 1, mid channel, 5 MHz, conducted	ac01	2019-08-07	Passed	Passed
UTRA, FDD V HSUPA, Subtest 2, mid channel, 5 MHz, conducted	ac01	2019-08-07	Passed	Passed
UTRA, FDD V HSUPA, Subtest 3, mid channel, 5 MHz, conducted	ac01	2019-08-07	Passed	Passed
UTRA, FDD V HSUPA, Subtest 4, mid channel, 5 MHz, conducted	ac01	2019-08-07	Passed	Passed
UTRA, FDD V HSUPA, Subtest 5, mid channel, 5 MHz, conducted	ac01	2019-08-07	Passed	Passed
UTRA, FDD V, none, mid channel, 5 MHz, conducted	ac01	2019-08-07	Passed	Passed

47 CFR CHAPTER I FCC PART 22 § 2.1053 § 22.917 Subpart H

Field strength of spurious radiation

The measurement was performed according to ANSI C63.26: 2015

Final Result

OP-Mode	Setup	Date	FCC	IC
Technology, Radio Technology, Operating Frequency, ChBW, Measurement method				
GSM, GSM 850 EDGE, mid channel, 0.2 MHz, radiated	ac01	2019-07-30	Passed	Passed

47 CFR CHAPTER I FCC PART 22 § 2.1051 § 22.917 Subpart H

Band edge compliance

The measurement was performed according to ANSI C63.26: 2015

Final Result

OP-Mode	Setup	Date	FCC	IC
Technology, Radio Technology, Operating Frequency, ChBW, Measurement method				
GSM, GSM 850 EDGE, high channel, 0.2 MHz, conducted	ac01	2019-08-07	Passed	Passed
GSM, GSM 850 EDGE, low channel, 0.2 MHz, conducted	ac01	2019-08-07	Passed	Passed
GSM, GSM 850, high channel, 0.2 MHz, conducted	ac01	2019-08-07	Passed	Passed
GSM, GSM 850, low channel, 0.2 MHz, conducted	ac01	2019-08-07	Passed	Passed
UTRA, FDD V HSDPA, Subtest 1, high channel, 5 MHz, conducted	ac01	2019-08-07	Passed	Passed
UTRA, FDD V HSDPA, Subtest 1, low channel, 5 MHz, conducted	ac01	2019-08-07	Passed	Passed
UTRA, FDD V HSUPA, Subtest 1, high channel, 5 MHz, conducted	ac01	2019-08-07	Passed	Passed
UTRA, FDD V HSUPA, Subtest 1, low channel, 5 MHz, conducted	ac01	2019-08-07	Passed	Passed
UTRA, FDD V, none, high channel, 5 MHz, conducted	ac01	2019-08-07	Passed	Passed
UTRA, FDD V, none, low channel, 5 MHz, conducted	ac01	2019-08-07	Passed	Passed

47 CFR CHAPTER I FCC PART 24

§ 2.1046 § 24.232

Subpart E

RF Output power

The measurement was performed according to ANSI C63.26: 2015

Final Result

OP-Mode	Setup	Date	FCC	IC
Technology, Radio Technology, Test, Operating Frequency, ChBW, Measurement method				
GSM, GSM 1900 EDGE, mid channel, 0.2 MHz, conducted	ac01	2019-08-07	Passed	Passed
GSM, GSM 1900, mid channel, 0.2 MHz, conducted	ac01	2019-08-07	Passed	Passed
UTRA, FDD II HSDPA, Subtest 1, mid channel, 5 MHz, conducted	ac01	2019-08-07	Passed	Passed
UTRA, FDD II HSDPA, Subtest 2, mid channel, 5 MHz, conducted	ac01	2019-08-07	Passed	Passed
UTRA, FDD II HSDPA, Subtest 3, mid channel, 5 MHz, conducted	ac01	2019-08-07	Passed	Passed
UTRA, FDD II HSDPA, Subtest 4, mid channel, 5 MHz, conducted	ac01	2019-08-07	Passed	Passed
UTRA, FDD II HSUPA, Subtest 1, mid channel, 5 MHz, conducted	ac01	2019-08-07	Passed	Passed
UTRA, FDD II HSUPA, Subtest 2, mid channel, 5 MHz, conducted	ac01	2019-08-07	Passed	Passed
UTRA, FDD II HSUPA, Subtest 3, mid channel, 5 MHz, conducted	ac01	2019-08-07	Passed	Passed
UTRA, FDD II HSUPA, Subtest 4, mid channel, 5 MHz, conducted	ac01	2019-08-07	Passed	Passed
UTRA, FDD II HSUPA, Subtest 5, mid channel, 5 MHz, conducted	ac01	2019-08-07	Passed	Passed
UTRA, FDD II, none, mid channel, 5 MHz, conducted	ac01	2019-08-07	Passed	Passed

47 CFR CHAPTER I FCC PART 24

§ 2.1053 § 24.236

Subpart E

Field strength of spurious radiation

The measurement was performed according to ANSI C63.26: 2015

Final Result

OP-Mode	Setup	Date	FCC	IC
Technology, Radio Technology, Operating Frequency, ChBW, Measurement method				
GSM, GSM 1900 EDGE, mid channel, 0.2 MHz, radiated	ac01	2019-07-30	Passed	Passed

47 CFR CHAPTER I FCC PART 24

§ 2.1051 § 24.238

Subpart E

Band edge compliance

The measurement was performed according to ANSI C63.26: 2015

Final Result

OP-Mode	Setup	Date	FCC	IC
Technology, Radio Technology, Operating Frequency, ChBW, Measurement method				
GSM, GSM 1900 EDGE, high channel, 0.2 MHz, conducted	ac01	2019-08-07	Passed	Passed
GSM, GSM 1900 EDGE, low channel, 0.2 MHz, conducted	ac01	2019-08-07	Passed	Passed
GSM, GSM 1900, high channel, 0.2 MHz, conducted	ac01	2019-08-07	Passed	Passed
GSM, GSM 1900, low channel, 0.2 MHz, conducted	ac01	2019-08-07	Passed	Passed

N/A: Not applicable

N/P: Not performed

2 REVISION HISTORY

Report version control			
Version	Release date	Change Description	Version validity
initial	2019-08-14	--	valid
--	--	--	--

COMMENT:

On applicants demand not all applicable tests were performed.



(responsible for accreditation scope)
Dipl.-Ing. Daniel Gall

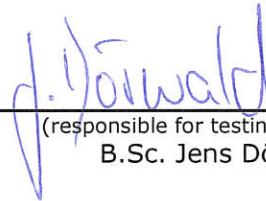

(responsible for testing and report)
B.Sc. Jens Dörwald



7 layers GmbH, Borsigstr. 11
40880 Ratingen, Germany
Phone +49 (0)2102 749 0

3 ADMINISTRATIVE DATA

3.1 TESTING LABORATORY

Company Name: 7layers GmbH
Address: Borsigstr. 11
40880 Ratingen
Germany

The test facility is accredited by the following accreditation organisation:

Laboratory accreditation no: DAKKS D-PL-12140-01-00
FCC Designation Number: DE0015
FCC Test Firm Registration: 929146
ISED CAB Identifier DE0007; ISED#: 3699A

Responsible for accreditation scope: Dipl.-Ing. Daniel Gall

Report Template Version: 2019-06-18

3.2 PROJECT DATA

Responsible for testing and report: B.Sc. Jens Dörwald
Employees who performed the tests: documented internally at 7Layers
Date of Report: 2019-08-14
Testing Period: 2019-07-30 to 2019-08-07

3.3 APPLICANT DATA

Company Name: u-blox AG
Address: Zürcherstrasse 68
8800 Thalwil
Switzerland

Contact Person: Mr. Giulio Comar

3.4 MANUFACTURER DATA

Company Name: please see Applicant Data
Address:
Contact Person:

4 TEST OBJECT DATA

4.1 GENERAL EUT DESCRIPTION

Kind of Device product description	2G & 3G Module
Product name	LISA-U201
Type	-
Declared EUT data by the supplier	
General product description	The EUT is 2G & 3G module. It supports the relevant bands for FCC Approval. GSM850 / GSM1900 / FDD II / FDD V
Voltage Level	3.8 V
Voltage Type	DC

The main components of the EUT are listed and described in chapter 3.2 EUT Main components.

4.2 EUT MAIN COMPONENTS

Sample Name	Sample Code	Description
DE1015114	ac01	radiated & conducted sample
Sample Parameter	Value	
Serial No.	358874100011408	
HW Version	214C00	
SW Version	23.41	
Comment	-	

NOTE: The short description is used to simplify the identification of the EUT in this test report.

4.3 ANCILLARY EQUIPMENT

For the purposes of this test report, ancillary equipment is defined as equipment which is used in conjunction with the EUT to provide operational and control features to the EUT. It is necessary to configure the system in a typical fashion, as a customer would normally use it. But nevertheless Ancillary Equipment can influence the test results.

Device	Details (Manufacturer, Type Model, OUT Code)	Description
-	-	-

4.4 AUXILIARY EQUIPMENT

For the purposes of this test report, auxiliary equipment is defined as equipment which is used temporarily to enable operational and control features especially used for the tests of the EUT which is not used during normal operation or equipment that is used during the tests in combination with the EUT but is not subject of this test report. It is necessary to configure the system in a typical fashion, as a customer would normally use it. But nevertheless Auxiliary Equipment can influence the test results.

Device	Details (Manufacturer, Type Model, HW, SW, S/N)	Description
-	-	-

4.5 EUT SETUPS

This chapter describes the combination of EUTs and equipment used for testing. The rationale for selecting the EUTs, ancillary and auxiliary equipment and interconnecting cables, is to test a representative configuration meeting the requirements of the referenced standards.

Setup	Combination of EUTs	Description and Rationale
ac01	DE1015114ac01	radiated & conducted sample

4.6 OPERATING MODES

This chapter describes the operating modes of the EUTs used for testing.

4.6.1 TEST CHANNELS

GSM 850	LOW	MID	HIGH
Channel	128	190	251
Frequency [MHz]	824.2	836.6	848.8

FDD V / HSDPA FDD V / HSUPA FDD V	LOW	MID	HIGH
Channel	4132	4183	4233
Frequency [MHz]	826.4	836.6	846.6

GSM 1900	LOW	MID	HIGH
Channel	512	661	810
Frequency [MHz]	1850.2	1880	1909.8

FDD II / HSDPA FDD II / HSUPA FDD II	LOW	MID	HIGH
Channel	9262	9400	9538
Frequency [MHz]	1852.4	1880	1907.6

4.7 PRODUCT LABELLING

4.7.1 FCC ID LABEL

Please refer to the documentation of the applicant.

4.7.2 LOCATION OF THE LABEL ON THE EUT

Please refer to the documentation of the applicant.

5 TEST RESULTS

5.1 RF OUTPUT POWER

Standard **FCC PART 22 Subpart H**

The test was performed according to:
ANSI C63.26: 2015

5.1.1 TEST DESCRIPTION

This test case is intended to demonstrate compliance to the applicable RF Output power test case per § 2.1046 and RSS-GEN 6.12. The limit and the requirements come from the applicable rule part and ISED RSS-Standard for the operating band of the cellular device.

The EUT was connected to the test setup according to the following diagram:

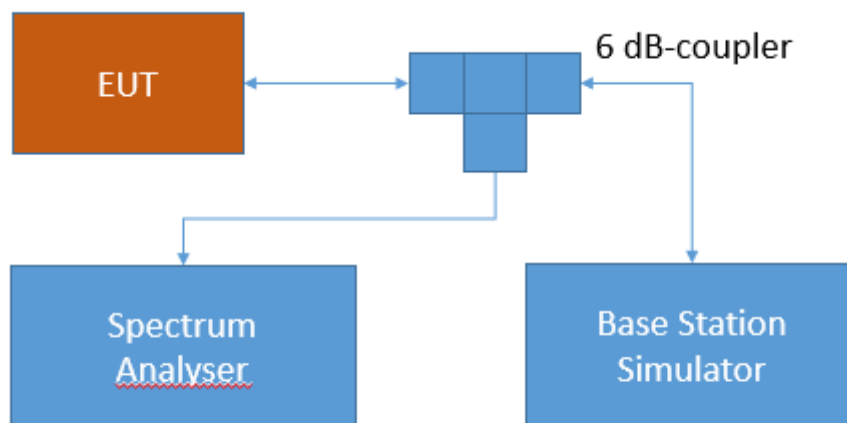

Test Setup FCC Part 22/24/27/90 Cellular;
RF Output power

The attenuation of the measuring and stimulus path are known for each measured frequency and are considered.

The Spectrum Analyzer settings can be directly found in the measurement diagrams.

5.1.2 TEST REQUIREMENTS / LIMITS

FCC Part 22, § 22.913

(a) *Maximum ERP.* The ERP of transmitters in the Cellular Radiotelephone Service must not exceed the limits in this section.

(5) The ERP of mobile transmitters and auxiliary test transmitters must not exceed 7 watts.

RSS-132; 5.4 Transmitter Output Power and Equivalent Isotropically Radiated Power

The transmitter output power shall be measured in terms of average power. The equivalent isotropically radiated power (e.i.r.p.) for mobile equipment shall not exceed 11.5 watts.

5.1.3 TEST PROTOCOL

Temperature 25 °C
Humidity 38 %

Radio Technology	Channel	Bandwidth [MHz]	Peak Cond. Power [dBm]	Average Cond. Power [dBm]	RMS Cond. Power [dBm]	FCC EIRP Limit [W]	IC EIRP Limit [W]	Max. Antenna Gain FCC [dBi]	Max. Antenna Gain IC [dBi]
GSM 850	mid	0.2	33.56	33.28	33.26	11.5	11.5	7.04	7.04
GSM 850 EDGE	mid	0.2	33.65	29.56	29.7	11.5	11.5	6.95	6.95
FDD V	mid	5	29.93	24.05	24.21	11.5	11.5	16.39	16.39
FDD V HSDPA Subtest 1	mid	5	29.67	24.13	24.49	11.5	11.5	16.11	16.11
FDD V HSDPA Subtest 2	mid	5	29.67	23.39	23.99	11.5	11.5	16.61	16.61
FDD V HSDPA Subtest 3	mid	5	30.02	23.04	23.74	11.5	11.5	16.86	16.86
FDD V HSDPA Subtest 4	mid	5	29.21	22.75	23.62	11.5	11.5	16.98	16.98
FDD V HSUPA Subtest 1	mid	5	30.19	23.33	23.81	11.5	11.5	16.79	16.79
FDD V HSUPA Subtest 2	mid	5	29.21	21.15	21.75	11.5	11.5	18.85	18.85
FDD V HSUPA Subtest 3	mid	5	30.4	22.33	22.95	11.5	11.5	17.65	17.65
FDD V HSUPA Subtest 4	mid	5	26.78	18.29	19.34	11.5	11.5	21.26	21.26
FDD V HSUPA Subtest 5	mid	5	29.93	23.24	23.67	11.5	11.5	16.93	16.93

Remark: Please see next sub-clause for the measurement plot.

5.1.4 MEASUREMENT PLOT (SHOWING THE HIGHEST VALUE, "WORST CASE")

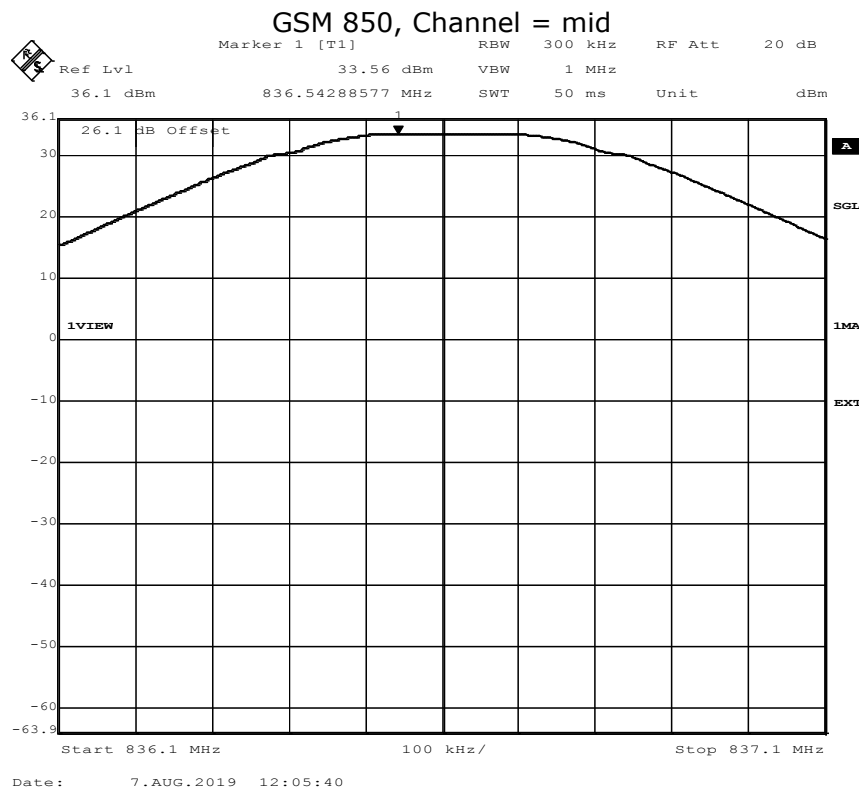

5.1.5 TEST EQUIPMENT USED

- Radio Lab

5.2 FIELD STRENGTH OF SPURIOUS RADIATION

Standard **FCC PART 22 Subpart H**

The test was performed according to:
ANSI C63.26: 2015

5.2.1 TEST DESCRIPTION

This test case is intended to demonstrate compliance to the applicable radiated spurious emission measurements per § 2.1053 and RSS-GEN 6.13. The limit and requirements come from the applicable rule part and ISED RSS-Standard for the operating band of the cellular device.

The EUT was connected to the test setup according to the following diagram:

Frequency Range: 30 MHz – 1 GHz:

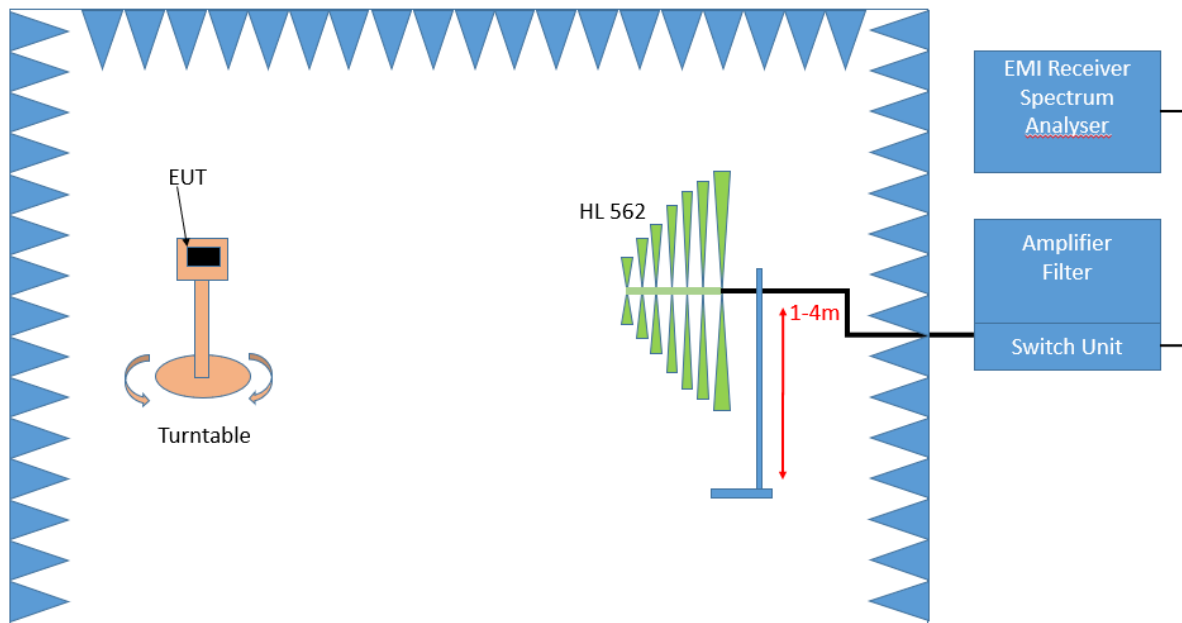

Test Setup; Spurious Emission Radiated (SAC), 30 MHz- 1GHz

Frequency Range: 1 GHz – 26.5 GHz

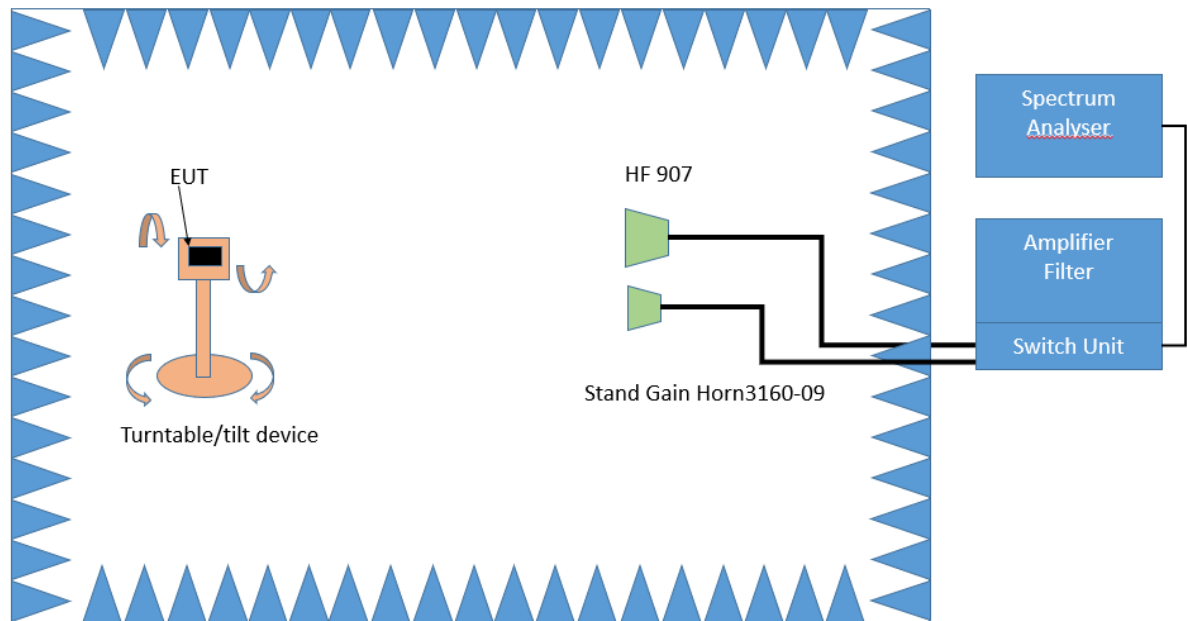

Test Setup; Spurious Emission Radiated (FAC), 1 GHz-26.5 GHz

The test set-up was made in accordance to the general provisions of ANSI C63.26 in a typical installation configuration. The Equipment Under Test (EUT) was set up on a non-conductive table 1.0 x 2.0 m² in the semi-anechoic chamber. The influence of the EUT support table that is used between 30–1000 MHz was evaluated.

The measurement procedure is implemented into the EMI test software EMC32 from R&S. Exploratory tests are performed at 3 orthogonal axes to determine the worst-case orientation of a body-worn or handheld EUT. The final test on all kind of EUTs is also performed at 3 axes. A pre-check is performed while the EUT is powered from a DC power source.

1. Measurement above 30 MHz and up to 1 GHz

Step 1: Preliminary scan

This is a preliminary test to identify the highest amplitudes relative to the limit.

Settings for step 1:

- Antenna distance: 3 m
- Detector: Peak
- RBW: 100 kHz
- VBW: 300 kHz
- Sweep time: coupled
- Turntable angle range: -180° to 90°
- Turntable step size: 90°
- Height variation range: 1 – 3 m
- Height variation step size: 2 m
- Polarisation: Horizontal + Vertical

Intention of this step is, to determine the radiated EMI-profile of the EUT. Afterwards the relevant emissions for the final measurement are identified.

Step 2: Adjustment measurement

In this step the accuracy of the turntable azimuth and antenna height will be improved. This is necessary to find out the maximum value of every frequency.

For each frequency, which was determined the turntable azimuth and antenna height will be adjusted. The turntable azimuth will slowly vary by $\pm 45^{\circ}$ around this value. During this action,

the value of emission is continuously measured. The turntable azimuth at the highest emission will be recorded and adjusted. In this position, the antenna height will also slowly vary by ± 100 cm around the antenna height determined. During this action, the value of emission is also continuously measured. The antenna height of the highest emission will also be recorded and adjusted.

- Detector: Peak
- Measured frequencies: in step 1 determined frequencies
- RBW: 100 kHz
- VBW: 300 kHz
- Sweep time: coupled
- Turntable angle range: $\pm 45^\circ$ around the determined value
- Height variation range: ± 100 cm around the determined value
- Antenna Polarisation: max. value determined in step 1

Step 3: Final measurement with RMS detector

With the settings determined in step 3, the final measurement will be performed:

EMI receiver settings for step 4:

- Detector: RMQ
- Measured frequencies: in step 1 determined frequencies
- RBW: 100 kHz
- VBW: 300 kHz
- Sweep time: 1 s

After the measurement a plot will be generated which contains a diagram with the results of the preliminary scan and a chart with the frequencies and values of the results of the final measurement.

3. Measurement above 1 GHz

The following modifications apply to the measurement procedure for the frequency range above 1 GHz:

Step 1:

The Equipment Under Test (EUT) was set up on a non-conductive support (tilt device) at 1.5 m height in the fully-anechoic chamber.

All steps were performed with one height (1.5 m) of the receiving antenna only.

The EUT is turned during the preliminary measurement across the elevation axis, with a step size of 90° .

The turn table step size (azimuth angle) for the preliminary measurement is 45° .

- Antenna distance: 3 m
- Detector: Peak
- RBW: 1 MHz
- VBW: 3 MHz
- Sweep time: coupled
- Turntable angle range: -180° to 90°
- Turntable step size: 90°
- Polarisation: Horizontal + Vertical

Step 2:

Due to the fact, that in this frequency range the test is performed in a fully anechoic room, the height scan of the receiving antenna instep 2 is omitted. Instead of this, a maximum search with a step size $\pm 45^\circ$ for the elevation axis is performed.

The turn table azimuth will slowly vary by $\pm 22.5^\circ$.

The elevation angle will slowly vary by $\pm 45^\circ$

EMI receiver settings (for all steps):

- Detector: Peak,
- RBW: 1 MHz

- VBW: 3 MHz
- Sweep time: coupled

Step 3:

Spectrum analyser settings for step 3:

- Detector: RMS
- Measured frequencies: in step 1 determined frequencies
- RBW: 1 MHz
- VBW: 3 MHz
- Sweep Time: 1 s

5.2.2 TEST REQUIREMENTS / LIMITS

FCC Part 2.1053; Measurement required: Field strength of spurious radiation:

Measurements shall be made to detect spurious emissions that may be radiated directly from the cabinet, control circuits, power leads, or intermediate circuit elements under normal conditions of installation and operation. Curves or equivalent data shall be supplied showing the magnitude of each harmonic and other spurious emission. For this test, single sideband, independent sideband, and controlled carrier transmitters shall be modulated under the conditions specified in paragraph (c) of §2.1049, as appropriate.

Part 22, Subpart H – Cellular Radiotelephone Service

§ 22.917 – Emission limitations for cellular equipment

(a) *Out of band emissions.* The power of any emission outside of the authorized operating frequency ranges must be attenuated below the transmitting power (P) by a factor of at least $43 + 10 \log(P)$ dB.

RSS-132; 5.5 Transmitter Unwanted Emissions

Mobile and base station equipment shall comply with the limits in (i) and (ii) below.

1. In the first 1.0 MHz band immediately outside and adjacent to each of the sub-bands specified in Section 5.1, the power of emissions per any 1% of the occupied bandwidth shall be attenuated (in dB) below the transmitter output power P (dBW) by at least $43 + 10 \log_{10} p$ (watts).
2. After the first 1.0 MHz immediately outside and adjacent to each of the sub-bands, the power of emissions in any 100 kHz bandwidth shall be attenuated (in dB) below the transmitter output power P (dBW) by at least $43 + 10 \log_{10} p$ (watts). If the measurement is performed using 1% of the occupied bandwidth, power integration over 100 kHz is required.

5.2.3 TEST PROTOCOL

Temperature 26 - 32 °C
Humidity 40 - 41 %

Radio Technology	CH	Detector	Trace	Resolution Bandwidth / kHz	Frequency / MHz	Peak Value / dBm	Limit / dBm	Margin to Limit / dB
GSM 850	mid	rms	maxhold	-	-	-	-13	>20
EDGE 850	mid	rms	maxhold	-	-	-	-13	>20
UTRA FDD V	mid	rms	maxhold	-	-	-	-13	>20
UTRA FDD V HSDPA	mid	rms	maxhold	-	-	-	-13	>20
UTRA FDD V HSUPA	mid	rms	maxhold	-	-	-	-13	>20

Remark: Please see next sub-clause for the measurement plot.

5.2.4 MEASUREMENT PLOT (SHOWING THE HIGHEST VALUE, "WORST CASE") GSM 850, Channel = mid

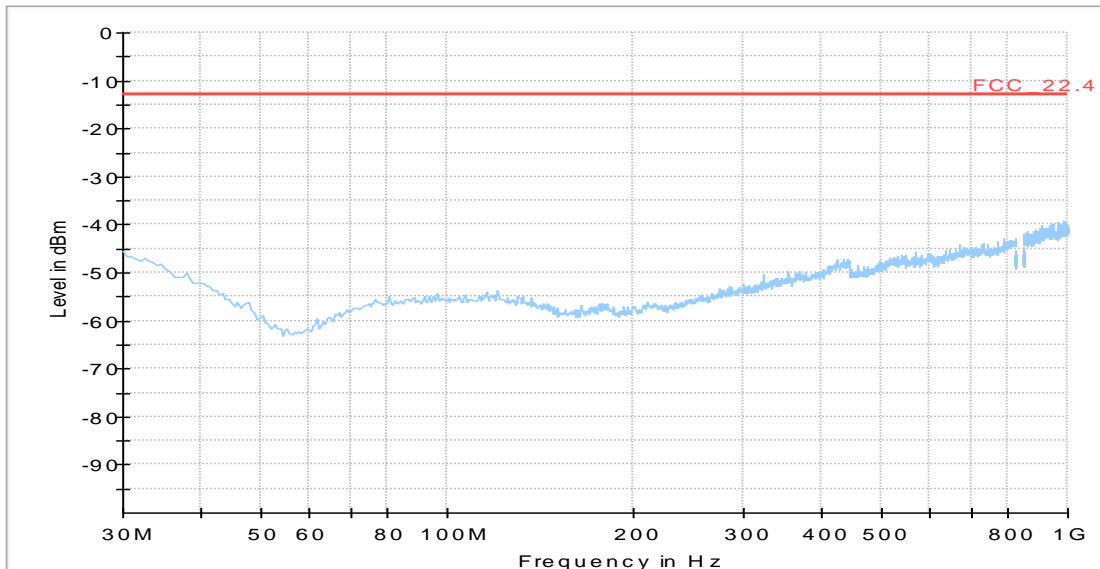

— Preview Result 1-PK+ * Critical_Freqs PK+
— FCC_22.4 ◆ Final_Result RMS

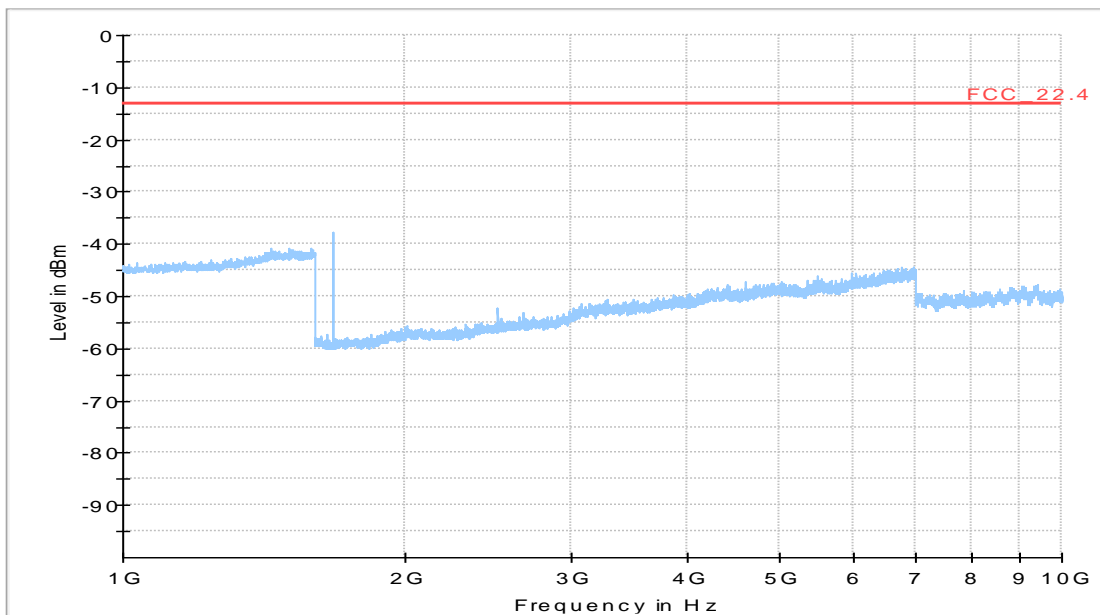

5.2.5 TEST EQUIPMENT USED

Radiated Emissions

5.3 BAND EDGE COMPLIANCE

Standard **FCC PART 22 Subpart H**

The test was performed according to:
ANSI C63.26: 2015

5.3.1 TEST DESCRIPTION

This test case is intended to demonstrate compliance to the applicable conducted spurious emission test case per § 2.1051 and RSS-GEN 6.13. The limit comes from the applicable rule part and ISSED RSS-Standard for the operating band of the cellular device.

The EUT was connected to the test setup according to the following diagram:

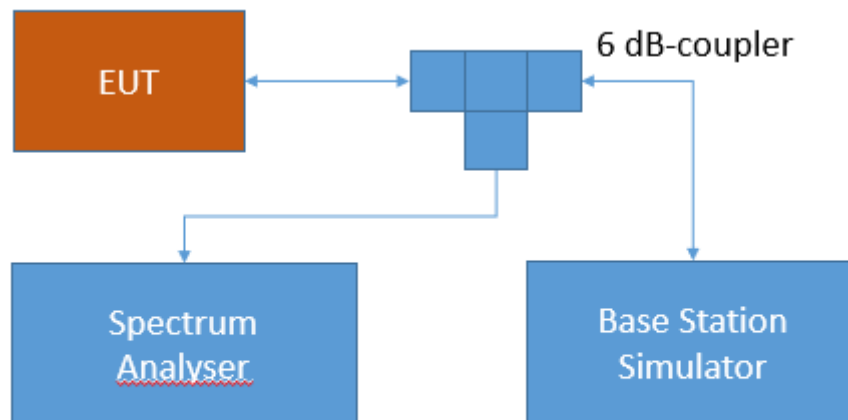

Test Setup FCC Part 22/24/27/90 Cellular;
Band edge compliance

The attenuation of the measuring and stimulus path are known for each measured frequency and are considered.

The Spectrum Analyzer settings can be directly found in the measurement diagrams.

5.3.2 TEST REQUIREMENTS / LIMITS

FCC Part 2.1051; Measurement required: Spurious emissions at antenna terminal:

The radio frequency voltage or powers generated within the equipment and appearing on a spurious frequency shall be checked at the equipment output terminals when properly loaded with a suitable artificial antenna. Curves or equivalent data shall show the magnitude of each harmonic and other spurious emission that can be detected when the equipment is operated

under the conditions specified in §2.1049 as appropriate. The magnitude of spurious emissions which are attenuated more than 20 dB below the permissible value need not be specified.

Part 22, Subpart H – Cellular Radiotelephone Service

§22 917 – Emission limitations for cellular equipment

(a) *Out of band emissions.* The power of any emission outside of the authorized operating frequency ranges must be attenuated below the transmitting power (P) by a factor of at least $43 + 10 \log(P)$ dB.

RSS-132; 5.5 Transmitter Unwanted Emissions

Mobile and base station equipment shall comply with the limits in (i) and (ii) below.

1. In the first 1.0 MHz band immediately outside and adjacent to each of the sub-bands specified in Section 5.1, the power of emissions per any 1% of the occupied bandwidth shall be attenuated (in dB) below the transmitter output power P (dBW) by at least $43 + 10 \log_{10}p$ (watts).
2. After the first 1.0 MHz immediately outside and adjacent to each of the sub-bands, the power of emissions in any 100 kHz bandwidth shall be attenuated (in dB) below the transmitter output power P (dBW) by at least $43 + 10 \log_{10} p$ (watts). If the measurement is performed using 1% of the occupied bandwidth, power integration over 100 kHz is required.

5.3.3 TEST PROTOCOL

Temperature 25 °C
Humidity 38 %

Radio Technology	Channel	Bandwidth [MHz]	Peak [dBm]	Average [dBm]	RMS [dBm]	Limit [dBm]	Margin to Limit [dB]
GSM 850	low	0.2	-16.67	-35.94	-28.10	-13	3.67
GSM 850	high	0.2	-16.76	-38.64	-29.1	-13	3.76
GSM 850 EDGE	low	0.2	-27.58	-47.42	-37.88	-13	14.58
GSM 850 EDGE	high	0.2	-24.94	-47.42	-39.47	-13	11.94
FDD V	low	5	-17.5	-26.6	-26.21	-13	13.21
FDD V	high	5	-15.96	-25.49	-24.98	-13	11.98
FDD V HSDPA Subtest 1	low	5	-19.99	-29.92	-28.1	-13	15.1
FDD V HSDPA Subtest 1	high	5	-17.81	-29.1	-27.42	-13	14.42
FDD V HSUPA Subtest 1	low	5	-24.78	-34.36	-33.44	-13	20.44
FDD V HSUPA Subtest 1	high	5	-23.03	-33.02	-32.62	-13	19.62

Remark: Please see next sub-clause for the measurement plot.

5.3.4 MEASUREMENT PLOT (SHOWING THE HIGHEST VALUE, "WORST CASE")

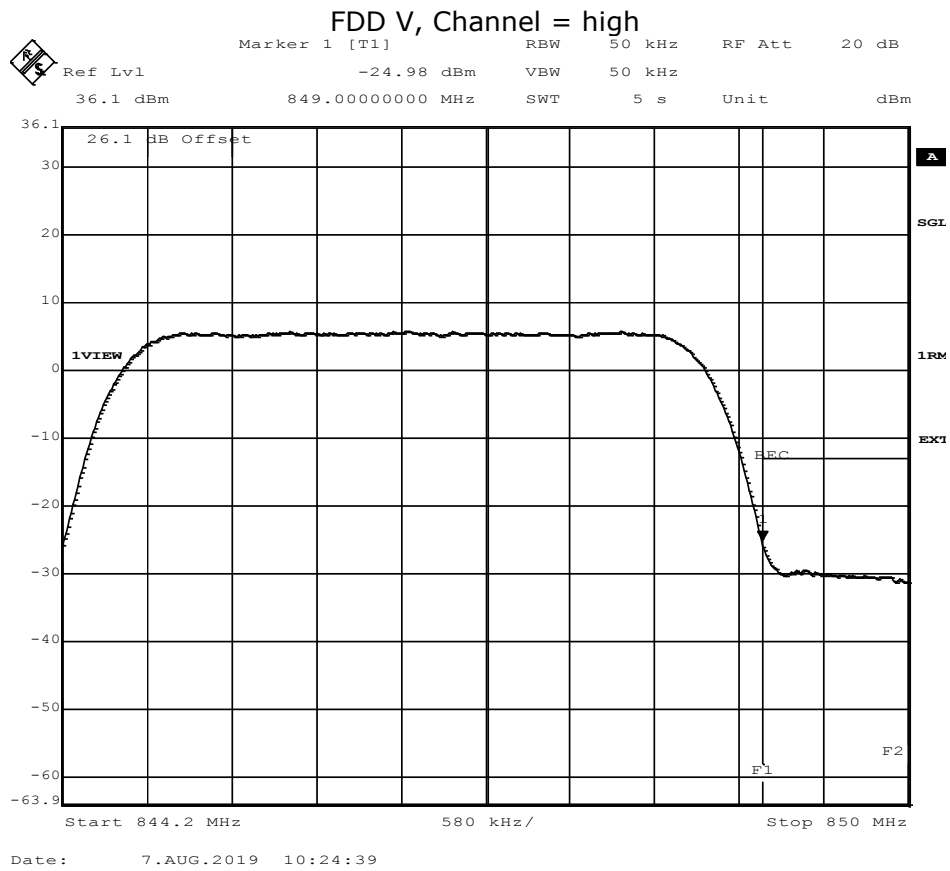

5.3.5 TEST EQUIPMENT USED

- Radio Lab

5.4 RF OUTPUT POWER

Standard **FCC PART 24 Subpart E**

The test was performed according to:
ANSI C63.26: 2015

5.4.1 TEST DESCRIPTION

This test case is intended to demonstrate compliance to the applicable RF Output power test case per § 2.1046 and RSS-GEN 6.12. The limit and the requirements come from the applicable rule part and ISED RSS-Standard for the operating band of the cellular device.

The EUT was connected to the test setup according to the following diagram:

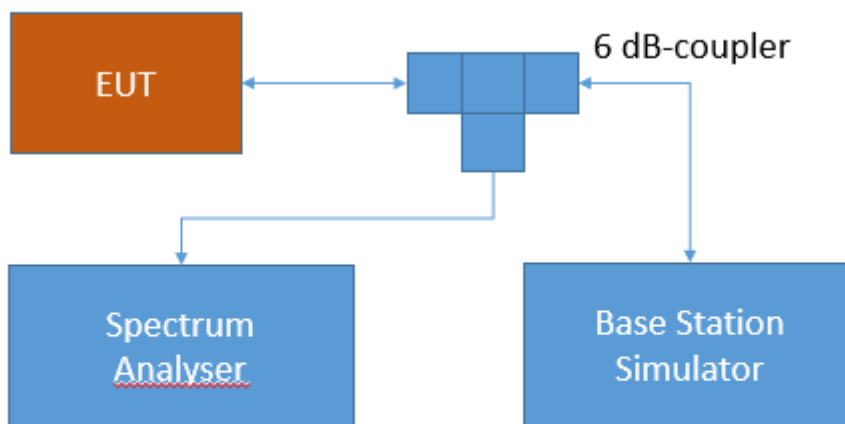

Test Setup FCC Part 22/24/27/90 Cellular;
RF Output power

The attenuation of the measuring and stimulus path are known for each measured frequency and are considered.

The Spectrum Analyzer settings can be directly found in the measurement diagrams.

5.4.2 TEST REQUIREMENTS / LIMITS

FCC Part 24, § 24.232

(c) Mobile and portable stations are limited to 2 watts EIRP and the equipment must employ a means for limiting power to the minimum necessary for successful communications.

RSS-133; 6.4 Transmitter Output Power and Equivalent Isotropically Radiated Power

The equivalent isotropically radiated power (e.i.r.p.) for transmitters shall not exceed the limits given in SRSP-510.

SRSP-510; 5.1.2 Radiated Power and Antenna Height Limits – Mobile Stations

Mobile stations and hand-held portables are limited to 2 watts maximum e.i.r.p. The equipment shall employ means to limit the power to the minimum necessary for successful communication.

5.4.3 TEST PROTOCOL

Temperature 25 °C
Humidity 38 %

Radio Technology	Channel	Band-width [MHz]	Peak Conducted Power [dBm]	Average Conducted Power [dBm]	RMS Conducted Power [dBm]	FCC/IC EIRP Limit [W]	Maximum Antenna Gain FCC [dBi]	Maximum Antenna Gain IC [dBi]
GSM 1900	mid	0.2	30.7	30.58	30.57	2	2.3	2.3
GSM 1900 EDGE	mid	0.2	29.85	28.74	28.82	2	3.15	3.15
FDD II	mid	5	29.05	24.01	24.19	2	8.81	8.81
FDD II HSDPA Subtest 1	mid	5	28.93	23.92	24.21	2	8.79	8.79
FDD II HSDPA Subtest 2	mid	5	29.3	23.29	23.77	2	9.23	9.23
FDD II HSDPA Subtest 3	mid	5	28.81	22.89	23.61	2	9.39	9.39
FDD II HSDPA Subtest 4	mid	5	29.05	22.71	23.3	2	9.7	9.7
FDD II HSUPA Subtest 1	mid	5	30.01	23.14	23.58	2	9.42	9.42
FDD II HSUPA Subtest 2	mid	5	28.43	21.09	21.63	2	11.37	11.37
FDD II HSUPA Subtest 3	mid	5	30.31	22.31	22.81	2	10.19	10.19
FDD II HSUPA Subtest 4	mid	5	27.91	19.14	20.13	2	12.87	12.87
FDD II HSUPA Subtest 5	mid	5	29.71	23.56	23.79	2	9.21	9.21

Remark: Please see next sub-clause for the measurement plot.

5.4.4 MEASUREMENT PLOT (SHOWING THE HIGHEST VALUE, "WORST CASE")

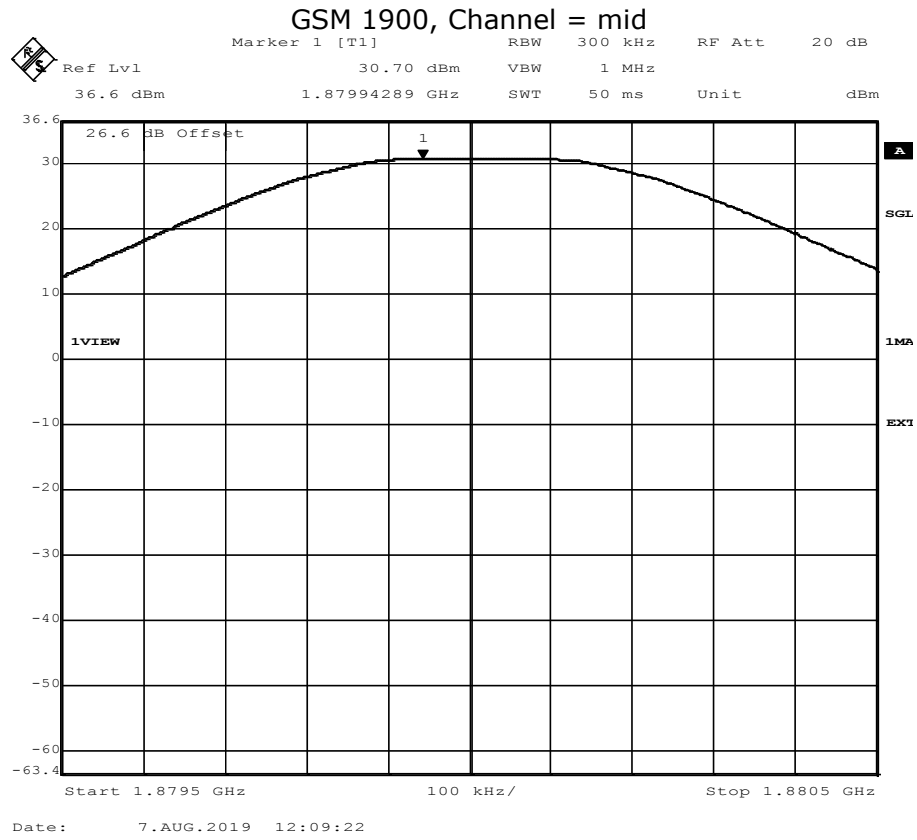

5.4.5 TEST EQUIPMENT USED

- Radio Lab

5.5 FIELD STRENGTH OF SPURIOUS RADIATION

Standard **FCC PART 24 Subpart E**

The test was performed according to:
ANSI C63.26: 2015

5.5.1 TEST DESCRIPTION

This test case is intended to demonstrate compliance to the applicable radiated spurious emission measurements per § 2.1053 and RSS-GEN 6.13. The limit and requirements come from the applicable rule part and ISED RSS-Standard for the operating band of the cellular device.

The EUT was connected to the test setup according to the following diagram:

Frequency Range: 30 MHz – 1 GHz:

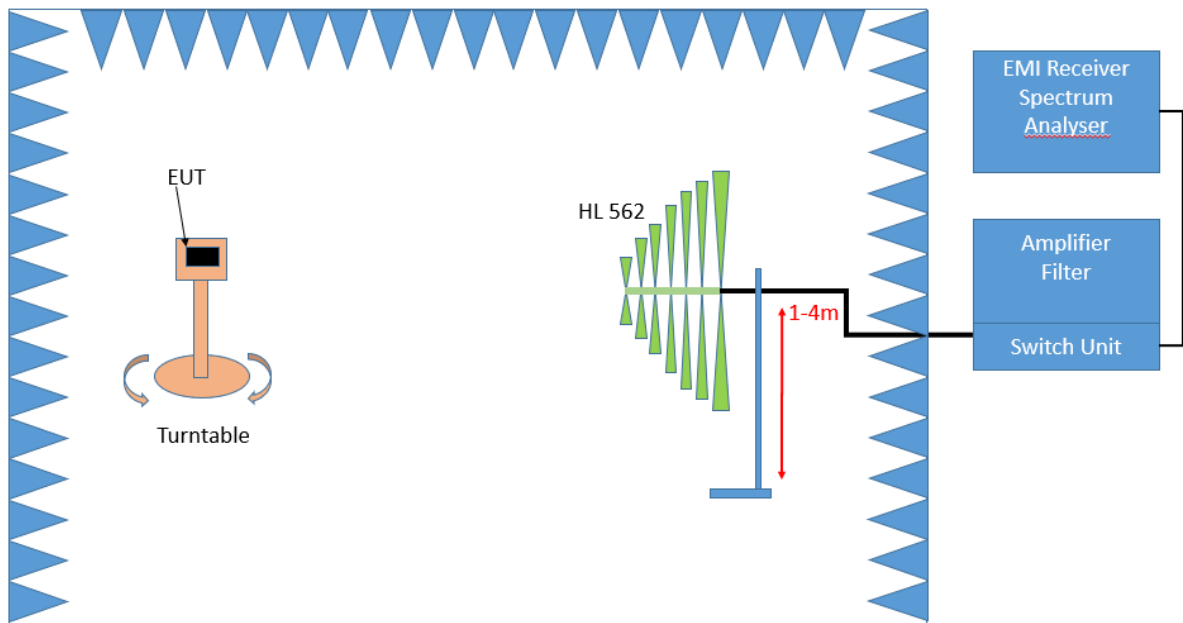

Test Setup; Spurious Emission Radiated (SAC), 30 MHz- 1GHz

Frequency Range: 1 GHz – 26.5 GHz

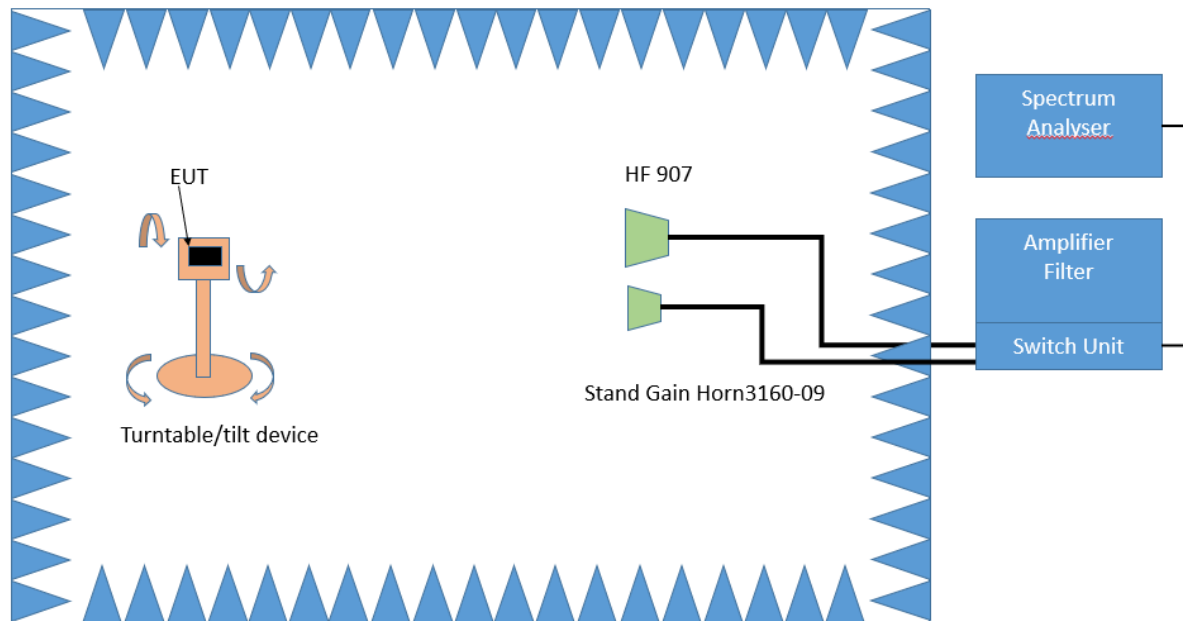

Test Setup; Spurious Emission Radiated (FAC), 1 GHz-26.5 GHz

The test set-up was made in accordance to the general provisions of ANSI C63.26 in a typical installation configuration. The Equipment Under Test (EUT) was set up on a non-conductive table 1.0 x 2.0 m² in the semi-anechoic chamber. The influence of the EUT support table that is used between 30–1000 MHz was evaluated.

The measurement procedure is implemented into the EMI test software EMC32 from R&S. Exploratory tests are performed at 3 orthogonal axes to determine the worst-case orientation of a body-worn or handheld EUT. The final test on all kind of EUTs is also performed at 3 axes. A pre-check is performed while the EUT is powered from a DC power source.

1. Measurement above 30 MHz and up to 1 GHz

Step 1: Preliminary scan

This is a preliminary test to identify the highest amplitudes relative to the limit.

Settings for step 1:

- Antenna distance: 3 m
- Detector: Peak
- RBW: 100 kHz
- VBW: 300 kHz
- Sweep time: coupled
- Turntable angle range: -180° to 90°
- Turntable step size: 90°
- Height variation range: 1 – 3 m
- Height variation step size: 2 m
- Polarisation: Horizontal + Vertical

Intention of this step is, to determine the radiated EMI-profile of the EUT. Afterwards the relevant emissions for the final measurement are identified.

Step 2: Adjustment measurement

In this step the accuracy of the turntable azimuth and antenna height will be improved. This is necessary to find out the maximum value of every frequency.

For each frequency, which was determined the turntable azimuth and antenna height will be adjusted. The turntable azimuth will slowly vary by $\pm 45^{\circ}$ around this value. During this action, the value of emission is continuously measured. The turntable azimuth at the highest emission

will be recorded and adjusted. In this position, the antenna height will also slowly vary by ± 100 cm around the antenna height determined. During this action, the value of emission is also continuously measured. The antenna height of the highest emission will also be recorded and adjusted.

- Detector: Peak
- Measured frequencies: in step 1 determined frequencies
- RBW: 100 kHz
- VBW: 300 kHz
- Sweep time: coupled
- Turntable angle range: $\pm 45^\circ$ around the determined value
- Height variation range: ± 100 cm around the determined value
- Antenna Polarisation: max. value determined in step 1

Step 3: Final measurement with RMS detector

With the settings determined in step 3, the final measurement will be performed:

EMI receiver settings for step 4:

- Detector: RMQ
- Measured frequencies: in step 1 determined frequencies
- RBW: 100 kHz
- VBW: 300 kHz
- Sweep time: 1 s

After the measurement a plot will be generated which contains a diagram with the results of the preliminary scan and a chart with the frequencies and values of the results of the final measurement.

3. Measurement above 1 GHz

The following modifications apply to the measurement procedure for the frequency range above 1 GHz:

Step 1:

The Equipment Under Test (EUT) was set up on a non-conductive support (tilt device) at 1.5 m height in the fully-anechoic chamber.

All steps were performed with one height (1.5 m) of the receiving antenna only.

The EUT is turned during the preliminary measurement across the elevation axis, with a step size of 90° .

The turn table step size (azimuth angle) for the preliminary measurement is 45° .

- Antenna distance: 3 m
- Detector: Peak
- RBW: 1 MHz
- VBW: 3 MHz
- Sweep time: coupled
- Turntable angle range: -180° to 90°
- Turntable step size: 90°
- Polarisation: Horizontal + Vertical

Step 2:

Due to the fact, that in this frequency range the test is performed in a fully anechoic room, the height scan of the receiving antenna instep 2 is omitted. Instead of this, a maximum search with a step size $\pm 45^\circ$ for the elevation axis is performed.

The turn table azimuth will slowly vary by $\pm 22.5^\circ$.

The elevation angle will slowly vary by $\pm 45^\circ$

EMI receiver settings (for all steps):

- Detector: Peak,
- RBW: 1 MHz
- VBW: 3 MHz

- Sweep time: coupled

Step 3:

Spectrum analyser settings for step 3:

- Detector: RMS
- Measured frequencies: in step 1 determined frequencies
- RBW: 1 MHz
- VBW: 3 MHz
- Sweep Time: 1 s

5.5.2 TEST REQUIREMENTS / LIMITS

FCC Part 2.1053; Measurement required: Field strength of spurious radiation:

Measurements shall be made to detect spurious emissions that may be radiated directly from the cabinet, control circuits, power leads, or intermediate circuit elements under normal conditions of installation and operation. Curves or equivalent data shall be supplied showing the magnitude of each harmonic and other spurious emission. For this test, single sideband, independent sideband, and controlled carrier transmitters shall be modulated under the conditions specified in paragraph (c) of §2.1049, as appropriate.

Part 24, Subpart E – Broadband PCS

§ 24.238 – Emission limitations for Broadband PCS equipment

- a) Out of band emissions. The power of any emission outside of the authorized operating frequency ranges must be attenuated below the transmitting power (P) by a factor of at least $43 + 10 \log(P)$ dB.
- b) Measurement procedure. Compliance with these rules is based on the use of measurement instrumentation employing a resolution bandwidth of 1 MHz or greater. However, in the 1 MHz bands immediately outside and adjacent to the frequency block a resolution bandwidth of at least one percent of the emission bandwidth of the fundamental emission of the transmitter may be employed. A narrower resolution bandwidth is permitted in all cases to improve measurement accuracy provided the measured power is integrated over the full required measurement bandwidth (i.e. 1 MHz or 1 percent of emission bandwidth, as specified). The emission bandwidth is defined as the width of the signal between two points, one below the carrier center frequency and one above the carrier center frequency, outside of which all emissions are attenuated at least 26 dB below the transmitter power.

RSS-133; 6.5 Transmitter Unwanted Emissions

Mobile and base station equipment shall comply with the limits in (1) and (2) below.

1. In the 1.0 MHz bands immediately outside and adjacent to the equipment's operating frequency block, the emission power per any 1% of the emission bandwidth shall be attenuated (in dB) below the transmitter output power P (dBW) by at least $43 + 10 \log_{10}P$ (watts).
2. After the first 1.0 MHz, the emission power in any 1 MHz bandwidth shall be attenuated (in dB) below the transmitter output power P (dBW) by at least $43 + 10 \log_{10}P$ (watts). If the measurement is performed using 1% of the emission bandwidth, power integration over 1.0 MHz is required.

5.5.3 TEST PROTOCOL

Temperature 26 - 32 °C
Humidity 40 - 41 %

Radio Technology	CH	Detector	Trace	Resolution Bandwidth / kHz	Frequency / MHz	Peak Value / dBm	Limit / dBm	Margin to Limit / dB
GSM 1900	mid	rms	maxhold	-	-	-	-13	>20
EDGE 1900	mid	rms	maxhold	-	-	-	-13	>20
UTRA FDD II	mid	rms	maxhold	-	-	-	-13	>20
UTRA FDD II HSDPA	mid	rms	maxhold	-	-	-	-13	>20
UTRA FDD II HSUPA	mid	rms	maxhold	-	-	-	-13	>20

Remark: Please see next sub-clause for the measurement plot.

5.5.4 MEASUREMENT PLOT (SHOWING THE HIGHEST VALUE, "WORST CASE") GSM 1900, Channel = mid

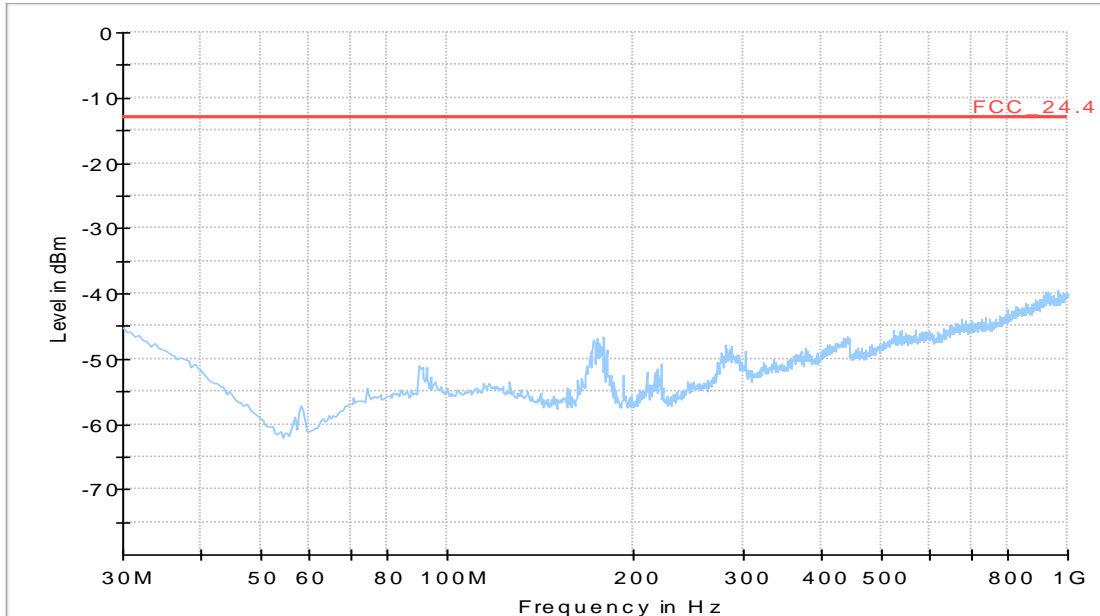

— Preview Result 1-PK+ * Critical_Freqs PK+
— FCC_24.4 ◆ Final_Result RMS

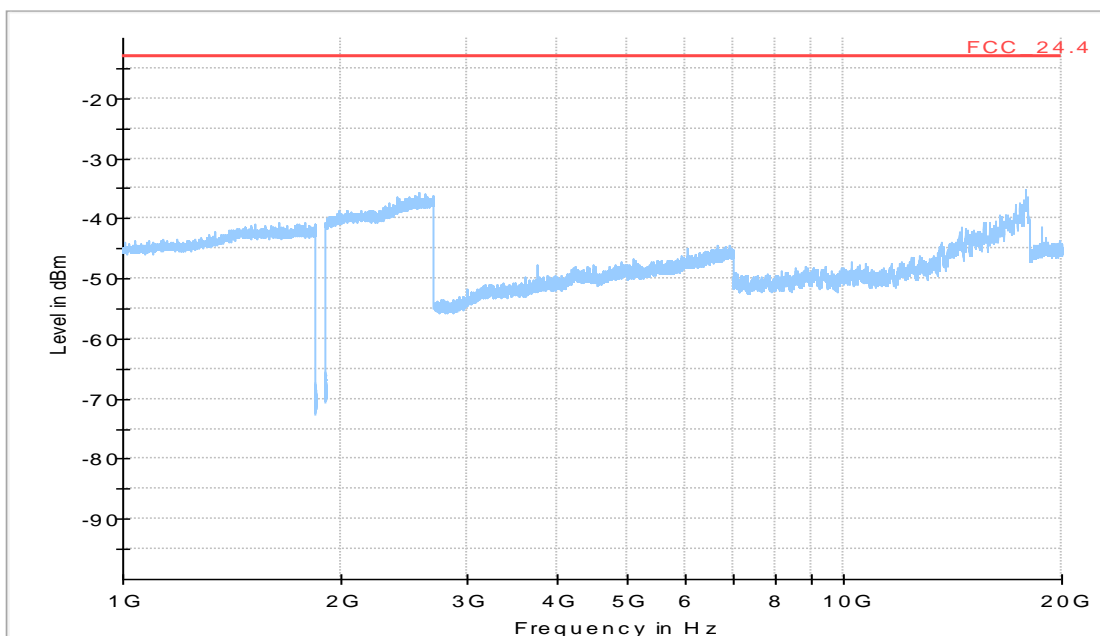

5.5.5 TEST EQUIPMENT USED

- Radiated Emissions

5.6 BAND EDGE COMPLIANCE

Standard **FCC PART 24 Subpart E**

The test was performed according to:
ANSI C63.26: 2015

5.6.1 TEST DESCRIPTION

This test case is intended to demonstrate compliance to the applicable conducted spurious emission test case per § 2.1051 and RSS-GEN 6.13. The limit comes from the applicable rule part and ISSED RSS-Standard for the operating band of the cellular device.

The EUT was connected to the test setup according to the following diagram:

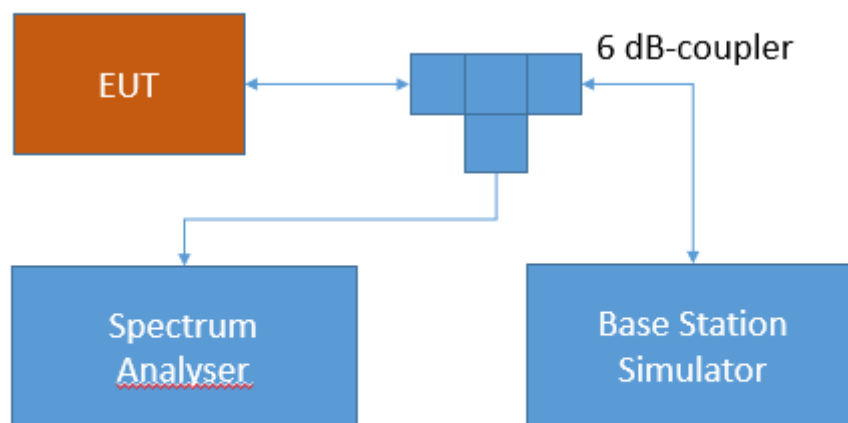

Test Setup FCC Part 22/24/27/90 Cellular;
Band edge compliance

The attenuation of the measuring and stimulus path are known for each measured frequency and are considered.

The Spectrum Analyzer settings can be directly found in the measurement diagrams.

5.6.2 TEST REQUIREMENTS / LIMITS

FCC Part 2.1051; Measurement required: Spurious emissions at antenna terminal:

The radio frequency voltage or powers generated within the equipment and appearing on a spurious frequency shall be checked at the equipment output terminals when properly loaded with a suitable artificial antenna. Curves or equivalent data shall show the magnitude of each harmonic and other spurious emission that can be detected when the equipment is operated

under the conditions specified in §2.1049 as appropriate. The magnitude of spurious emissions which are attenuated more than 20 dB below the permissible value need not be specified.

Part 24, Subpart E – Broadband PCS

§24.238 – Emission limitations for Broadband PCS equipment

- a) Out of band emissions. The power of any emission outside of the authorized operating frequency ranges must be attenuated below the transmitting power (P) by a factor of at least $43 + 10 \log(P)$ dB.
- b) Measurement procedure. Compliance with these rules is based on the use of measurement instrumentation employing a resolution bandwidth of 1 MHz or greater. However, in the 1 MHz bands immediately outside and adjacent to the frequency block a resolution bandwidth of at least one percent of the emission bandwidth of the fundamental emission of the transmitter may be employed. A narrower resolution bandwidth is permitted in all cases to improve measurement accuracy provided the measured power is integrated over the full required measurement bandwidth (i.e. 1 MHz or 1 percent of emission bandwidth, as specified). The emission bandwidth is defined as the width of the signal between two points, one below the carrier center frequency and one above the carrier center frequency, outside of which all emissions are attenuated at least 26 dB below the transmitter power.

RSS-133; 6.5 Transmitter Unwanted Emissions

Mobile and base station equipment shall comply with the limits in (1) and (2) below.

- 1. In the 1.0 MHz bands immediately outside and adjacent to the equipment’s operating frequency block, the emission power per any 1% of the emission bandwidth shall be attenuated (in dB) below the transmitter output power P (dBW) by at least $43 + 10 \log_{10}P$ (watts).
- 2. After the first 1.0 MHz, the emission power in any 1 MHz bandwidth shall be attenuated (in dB) below the transmitter output power P (dBW) by at least $43 + 10 \log_{10}P$ (watts). If the measurement is performed using 1% of the emission bandwidth, power integration over 1.0 MHz is required.

5.6.3 TEST PROTOCOL

Temperature 25 °C
Humidity 38 %

Radio Technology	Channel	Bandwidth [MHz]	Peak [dBm]	Average [dBm]	RMS [dBm]	Limit /dBm	Margin to Limit /dB
GSM 1900	low	0.2	-28	-49.42	-42.06	-13	15.00
GSM 1900	high	0.2	-28.98	-52.94	-39.88	-13	15.98
GSM 1900 EDGE	low	0.2	-35.52	-52.94	-42.06	-13	22.52
GSM 1900 EDGE	high	0.2	-27.97	-52.94	-42.06	-13	14.97
FDD II	low	5	-19.88	-28.86	-28.08	-13	15.08
FDD II	high	5	-17.8	-28.6	-27.6	-13	14.6
FDD II HSDPA Subtest 1	low	5	-20.92	-31.01	-30.02	-13	17.02
FDD II HSDPA Subtest 1	high	5	-17.65	-28.86	-28.6	-13	15.6
FDD II HSUPA Subtest 1	low	5	-22.47	-32.12	-31.36	-13	18.36
FDD II HSUPA Subtest 1	high	5	-17.43	-30.02	-29.14	-13	16.14

Remark: Please see next sub-clause for the measurement plot.

5.6.4 MEASUREMENT PLOT (SHOWING THE HIGHEST VALUE, "WORST CASE")

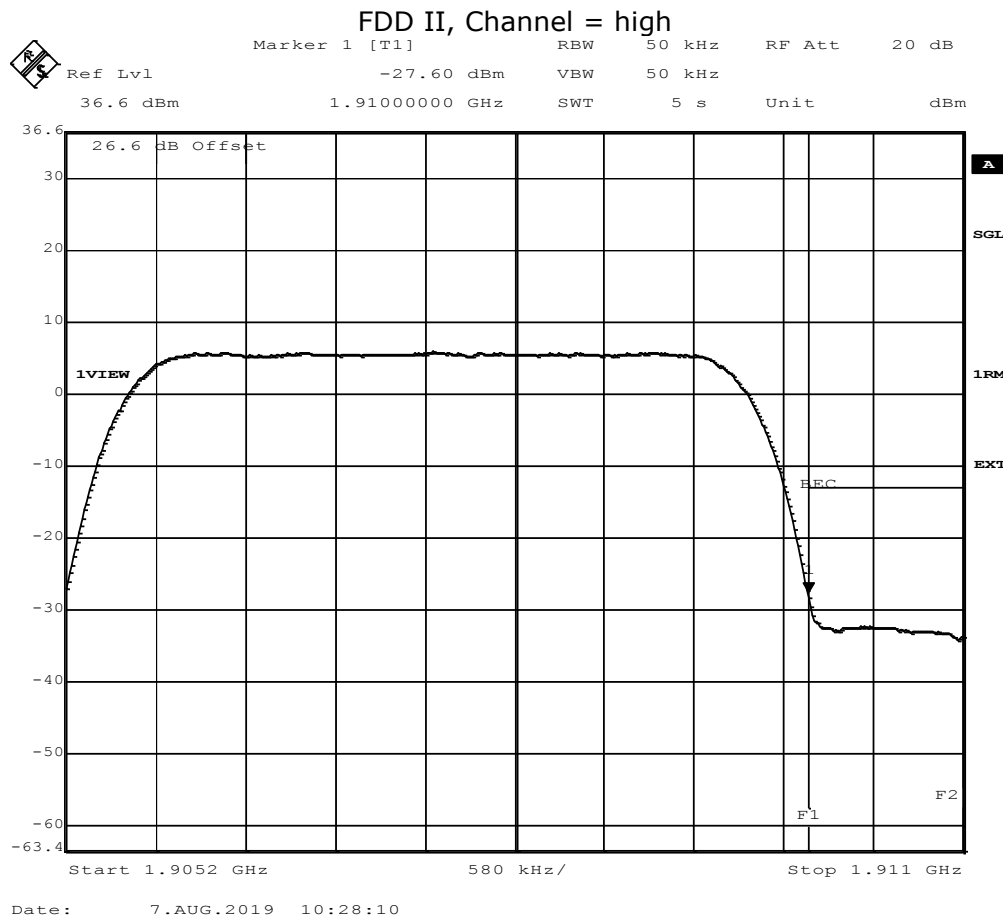

5.6.5 TEST EQUIPMENT USED

- Radio Lab

Test Equipment

- 1 Radiated Emissions
Lab to perform radiated emission tests

Ref.No.	Device Name	Description	Manufacturer	Serial Number	Last Calibration	Calibration Due
1.1	NRV-Z1	Sensor Head A	Rohde & Schwarz GmbH & Co. KG	827753/005		
1.2	MFS	Rubidium Frequency Normal MFS	Datum GmbH	002	2018-10	2020-10
1.3	Opus10 TPR (8253.00)	ThermoAirpressure Datalogger 13 (Environ)	Lufft Mess- und Regeltechnik GmbH	13936	2019-05	2021-05
1.4	ESW44	EMI Receiver / Spectrum Analyzer	Rohde & Schwarz GmbH & Co. KG	101603	2018-05	2019-11
1.5	Anechoic Chamber	10.58 x 6.38 x 6.00 m ³	Frankonia	none	2018-06	2020-06
1.6	FS-Z60	Harmonic Mixer 40 - 60 GHz	Rohde & Schwarz Messgerätebau GmbH	100178	2016-12	2019-12
1.7	FS-Z220	Harmonic Mixer 140 - 220 GHz	Rohde & Schwarz Messgerätebau GmbH	101005	2017-03	2020-03
1.8	SGH-05	Standard Gain / Pyramidal Horn Antenna (140 - 220 GHz)	RPG-Radiometer Physics GmbH	075		
1.9	HL 562	Ultralog new biconicals	Rohde & Schwarz	830547/003	2018-07	2021-07
1.10	AMF-7D00101800-30-10P-R	Broadband Amplifier 100 MHz - 18 GHz	Miteq			
1.11	5HC2700/12750-1.5-KK	High Pass Filter	Trilithic	9942012		
1.12	ASP 1.2/1.8-10 kg	Antenna Mast	Maturo GmbH	-		
1.13	Fully Anechoic Room	8.80m x 4.60m x 4.05m (l x w x h)	Albatross Projects	P26971-647-001-PRB	2018-06	2020-06
1.14	Fluke 177	Digital Multimeter 03 (Multimeter)	Fluke Europe B.V.	86670383	2018-04	2020-04
1.15	WRD1920/1980-5/22-5EESD	Tunable Band Reject Filter	Wainwright Instruments GmbH	11		
1.16	TDS 784C	Digital Oscilloscope [SA2] (Aux)	Tektronix	B021311		
1.17	foRS232 Unit 2	Fibre optic link RS232	PONTIS Messtechnik GmbH	4031516037		
1.18	PONTIS Con4101	PONTIS Camera Controller		6061510370		
1.19	NRVD	Power Meter	Rohde & Schwarz GmbH & Co. KG	828110/016		

Ref.No.	Device Name	Description	Manufacturer	Serial Number	Last Calibration	Calibration Due
1.20	OLS-1 R	Fibre optic link USB 1.1	Ingenieurbüro Scheiba	018		
1.21	HF 906	Double-ridged horn	Rohde & Schwarz	357357/002	2018-09	2021-09
1.22	JS4-18002600-32-5P	Broadband Amplifier 18 GHz - 26 GHz	Miteq	849785		
1.23	FSW 43	Spectrum Analyzer	Rohde & Schwarz	103779	2019-02	2021-02
1.24	3160-09	Standard Gain / Pyramidal Horn Antenna 26.5 GHz	EMCO Elektronik GmbH	00083069		
1.25	foRS232 Unit 1	Fibre optic link RS232	PONTIS Messtechnik GmbH	4021516036		
1.26	FSP3	Spectrum Analyzer	Rohde & Schwarz GmbH & Co. KG	836722/011		
1.27	SGH-19	Standard Gain / Pyramidal Horn Antenna (40 - 60 GHz)	RPG-Radiometer Physics GmbH	093		
1.28	WHKX 7.0/18G-8SS	High Pass Filter	Wainwright Instruments GmbH	09		
1.29	4HC1600/12750-1.5-KK	High Pass Filter	Trilithic	9942011		
1.30	foUSB-M Converter 2	Fibre optic link USB 2.0	PONTIS Messtechnik GmbH	4471520061		
1.31	WRCD1879.8-0.2/40-10EE	Notch Filter Ultra Stable	Wainwright Instruments GmbH	16		
1.32	Chroma 6404	AC Source	Chroma ATE INC.	64040001304		
1.33	JS4-00102600-42-5A	Broadband Amplifier 30 MHz - 26 GHz	Miteq	619368		
1.34	TT 1.5 WI	Turn Table	Maturo GmbH	-		
1.35	HL 562 Ultralog	Log.-per. Antenna	Rohde & Schwarz	100609	2019-05	2022-05
1.36	HF 906	Double-ridged horn	Rohde & Schwarz	357357/001	2018-03	2021-03
1.37	foCAN (v 4.0)	Fibre optic link CAN	Audiovo GmbH (PONTIS EMC)	492 1607 014		
1.38	FS-Z325	Harmonic Mixer 220 - 325 GHz	Rohde & Schwarz Messgerätebau GmbH	101006	2017-03	2020-03
1.39	3160-10	Standard Gain / Pyramidal Horn Antenna 40 GHz	EMCO Elektronik GmbH	00086675		
1.40	SGH-08	Standard Gain / Pyramidal Horn Antenna (90 - 140 GHz)	RPG-Radiometer Physics GmbH	064		
1.41	A8455-4	4 Way Power Divider (SMA)		-		
1.42	SGH-12	Standard Gain / Pyramidal HornAntenna (60 - 90 GHz)	RPG-Radiometer Physics GmbH	326		

Ref.No.	Device Name	Description	Manufacturer	Serial Number	Last Calibration	Calibration Due
1.43	Air compressor	Anechoic Chamber; 8.8m x 4.6 m x 4.05 m	JUN-AIR Deutschland GmbH	612582		
1.44	foEthernet_M	Fibre optic link Ethernet / Gb- LAN	PONTIS Messtechnik GmbH	4841516023		
1.45	5HC3500/18000 -1.2-KK	High Pass Filter	Trilithic	200035008		
1.46	FS-Z140	Harmonic Mixer 90 -140 GHz	Rohde & Schwarz Messgerätebau GmbH	101007	2017-02	2020-02
1.47	OLS-1 M	Fibre optic link USB 1.1	Ingenieurbüro Scheiba	018		
1.48	HFH2-Z2	Loop Antenna	Rohde & Schwarz	829324/006	2018-01	2021-01
1.49	Voltcraft M- 3860M	Digital Multimeter 01 (Multimeter)	Conrad	IJ096055		
1.50	Opus10 THI (8152.00)	ThermoHygro Datalogger 12 (Environ)	Lufft Mess- und Regeltechnik GmbH	12482	2019-06	2021-06
1.51	ESR 7	EMI Receiver / Spectrum Analyzer	Rohde & Schwarz	101424	2019-01	2020-01
1.52	foEthernet_M	Fibre optic link Ethernet / Gb- LAN	PONTIS Messtechnik GmbH	4841516022		
1.53	JS4-00101800- 35-5P	Broadband Amplifier 30 MHz - 18 GHz	Miteq	896037		
1.54	AS 620 P	Antenna mast	HD GmbH	620/37		
1.55	6005D (30 V / 5 A)	Laboratory Power Supply 120 V 60 Hz	Peaktech	81062045		
1.56	Tilt device Matureo (Rohacell)	Antrieb TD1.5- 10kg	Matureo GmbH	TD1.5- 10kg/024/37907 09		
1.57	SGH-03	Standard Gain / Pyramidal Horn Antenna (220 - 325 GHz)	RPG-Radiometer Physics GmbH	060		
1.58	FS-Z90	Harmonic Mixer 60 - 90 GHz	Rohde & Schwarz Messgerätebau GmbH	101686	2017-03	2020-03
1.59	ESIB 26	Spectrum Analyzer	Rohde & Schwarz	830482/004	2018-01	2020-01
1.60	foCAN (v 4.0)	Fibre optic link CAN	Audiovo GmbH (PONTIS EMC)	492 1607 013		
1.61	PAS 2.5 - 10 kg	Antenna Mast	Matureo GmbH	-		
1.62	AFS42- 00101800-25-S- 42	Broadband Amplifier 25 MHz - 18 GHz	Miteq	2035324		
1.63	WRCA800/960- 0.2/40-6EEK	Tunable Notch Filter	Wainwright Instruments GmbH	20		
1.64	AM 4.0	Antenna mast	Matureo GmbH	AM4.0/180/1192 0513		

Ref.No.	Device Name	Description	Manufacturer	Serial Number	Last Calibration	Calibration Due
1.65	HF 907	Double-ridged horn	Rohde & Schwarz	102444	2018-07	2021-07
1.66	E4408B	Spectrum Analyser (9 kHz to 26.5 GHz)	Agilent Technologies Deutschland GmbH	MY45103714		

2 Radio Lab
Conducted Radio Test Lab

Ref.No.	Device Name	Description	Manufacturer	Serial Number	Last Calibration	Calibration Due
2.1	SMB100A	Signal Generator 9 kHz - 6 GHz	Rohde & Schwarz	107695	2017-07	2020-07
2.2	SMBV100A	Vector Signal Generator 9 kHz - 6 GHz (GNSS / Broadcast Signalling Unit)	Rohde & Schwarz GmbH & Co. KG	260001	2018-01	2021-01
2.3	FSV30	Signal Analyzer 10 Hz - 30 GHz	Rohde & Schwarz	103005	2018-04	2020-04
2.4	Fluke 177	Digital Multimeter 03 (Multimeter)	Fluke Europe B.V.	86670383	2018-04	2020-04
2.5	WRD1920/1980-5/22-5EESD	Tunable Band Reject Filter	Wainwright Instruments GmbH	11		
2.6	foRS232 Unit 2	Fibre optic link RS232	PONTIS Messtechnik GmbH	4031516037		
2.7	OLS-1 R	Fibre optic link USB 1.1	Ingenieurbüro Scheiba	018		
2.8	foRS232 Unit 1	Fibre optic link RS232	PONTIS Messtechnik GmbH	4021516036		
2.9	foUSB-M Converter 2	Fibre optic link USB 2.0	PONTIS Messtechnik GmbH	4471520061		
2.10	WRCD1879.8-0.2/40-10EE	Notch Filter Ultra Stable	Wainwright Instruments GmbH	16		
2.11	FSIQ26	Signal Analyser 20 Hz to 26.5 GHz	Rohde & Schwarz GmbH & Co. KG	840061/005	2019-06	2021-06
2.12	Chroma 6404	AC Source	Chroma ATE INC.	64040001304		
2.13	foCAN (v 4.0)	Fibre optic link CAN	Audiovo GmbH (PONTIS EMC)	492 1607 014		
2.14	Temperature Chamber VT 4002	Temperature Chamber Vötsch 03	Vötsch	58566002150010	2018-04	2020-04
2.15	WA1515	Broadband Power Divider SMA	Weinschel Associates	A855		
2.16	A8455-4	4 Way Power Divider (SMA)		-		
2.17	foEthernet_M	Fibre optic link Ethernet / Gb-LAN	PONTIS Messtechnik GmbH	4841516023		

Ref.No.	Device Name	Description	Manufacturer	Serial Number	Last Calibration	Calibration Due
2.18	OLS-1 M	Fibre optic link USB 1.1	Ingenieurbüro Scheiba	018		
2.19	foEthernet_M	Fibre optic link Ethernet / Gb- LAN	PONTIS Messtechnik GmbH	4841516022		
2.20	SMBV100A	Vector Signal Generator 9 kHz - 6 GHz	Rohde & Schwarz	259291	2016-10	2019-10
2.21	foCAN (v 4.0)	Fibre optic link CAN	Audivo GmbH (PONTIS EMC)	492 1607 013		
2.22	WRCA800/960- 0.2/40-6EEK	Tunable Notch Filter	Wainwright Instruments GmbH	20		
2.23	E4408B	Spectrum Analyser (9 kHz to 26.5 GHz)	Agilent Technologies Deutschland GmbH	MY45103714		

The calibration interval is the time interval between "Last Calibration" and "Calibration Due"

6 ANTENNA FACTORS, CABLE LOSS AND SAMPLE CALCULATIONS

This chapter contains the antenna factors with their corresponding path loss of the used measurement path for all antennas as well as the insertion loss of the LISN.

6.1 LISN R&S ESH3-Z5 (150 KHZ – 30 MHZ)

Frequency MHz	Corr. dB	LISN insertion loss ESH3- Z5 dB	cable loss (incl. 10 dB atten- uator) dB
0.15	10.1	0.1	10.0
5	10.3	0.1	10.2
7	10.5	0.2	10.3
10	10.5	0.2	10.3
12	10.7	0.3	10.4
14	10.7	0.3	10.4
16	10.8	0.4	10.4
18	10.9	0.4	10.5
20	10.9	0.4	10.5
22	11.1	0.5	10.6
24	11.1	0.5	10.6
26	11.2	0.5	10.7
28	11.2	0.5	10.7
30	11.3	0.5	10.8

Sample calculation

$$U_{\text{LISN}} (\text{dB } \mu\text{V}) = U (\text{dB } \mu\text{V}) + \text{Corr. (dB)}$$

U = Receiver reading

LISN Insertion loss = Voltage Division Factor of LISN

Corr. = sum of single correction factors of used LISN, cables, switch units (if used)

Linear interpolation will be used for frequencies in between the values in the table.

6.2 ANTENNA R&S HFH2-Z2 (9 KHZ – 30 MHZ)

Frequency MHz	AF HFH-Z2) dB (1/m)	Corr. dB	cable loss 1 (inside chamber) dB	cable loss 2 (outside chamber) dB	cable loss 3 (switch unit) dB	cable loss 4 (to receiver) dB	distance corr. (-40 dB/ decade) dB	d _{Limit} (meas. distance (limit) m	d _{used} (meas. distance (used) m
0.009	20.50	-79.6	0.1	0.1	0.1	0.1	-80	300	3
0.01	20.45	-79.6	0.1	0.1	0.1	0.1	-80	300	3
0.015	20.37	-79.6	0.1	0.1	0.1	0.1	-80	300	3
0.02	20.36	-79.6	0.1	0.1	0.1	0.1	-80	300	3
0.025	20.38	-79.6	0.1	0.1	0.1	0.1	-80	300	3
0.03	20.32	-79.6	0.1	0.1	0.1	0.1	-80	300	3
0.05	20.35	-79.6	0.1	0.1	0.1	0.1	-80	300	3
0.08	20.30	-79.6	0.1	0.1	0.1	0.1	-80	300	3
0.1	20.20	-79.6	0.1	0.1	0.1	0.1	-80	300	3
0.2	20.17	-79.6	0.1	0.1	0.1	0.1	-80	300	3
0.3	20.14	-79.6	0.1	0.1	0.1	0.1	-80	300	3
0.49	20.12	-79.6	0.1	0.1	0.1	0.1	-80	300	3
0.490001	20.12	-39.6	0.1	0.1	0.1	0.1	-40	30	3
0.5	20.11	-39.6	0.1	0.1	0.1	0.1	-40	30	3
0.8	20.10	-39.6	0.1	0.1	0.1	0.1	-40	30	3
1	20.09	-39.6	0.1	0.1	0.1	0.1	-40	30	3
2	20.08	-39.6	0.1	0.1	0.1	0.1	-40	30	3
3	20.06	-39.6	0.1	0.1	0.1	0.1	-40	30	3
4	20.05	-39.5	0.2	0.1	0.1	0.1	-40	30	3
5	20.05	-39.5	0.2	0.1	0.1	0.1	-40	30	3
6	20.02	-39.5	0.2	0.1	0.1	0.1	-40	30	3
8	19.95	-39.5	0.2	0.1	0.1	0.1	-40	30	3
10	19.83	-39.4	0.2	0.1	0.2	0.1	-40	30	3
12	19.71	-39.4	0.2	0.1	0.2	0.1	-40	30	3
14	19.54	-39.4	0.2	0.1	0.2	0.1	-40	30	3
16	19.53	-39.3	0.3	0.1	0.2	0.1	-40	30	3
18	19.50	-39.3	0.3	0.1	0.2	0.1	-40	30	3
20	19.57	-39.3	0.3	0.1	0.2	0.1	-40	30	3
22	19.61	-39.3	0.3	0.1	0.2	0.1	-40	30	3
24	19.61	-39.3	0.3	0.1	0.2	0.1	-40	30	3
26	19.54	-39.3	0.3	0.1	0.2	0.1	-40	30	3
28	19.46	-39.2	0.3	0.1	0.3	0.1	-40	30	3
30	19.73	-39.1	0.4	0.1	0.3	0.1	-40	30	3

Sample calculation

$$E \text{ (dB } \mu\text{V/m)} = U \text{ (dB } \mu\text{V)} + AF \text{ (dB 1/m)} + Corr. \text{ (dB)}$$

U = Receiver reading

AF = Antenna factor

Corr. = sum of single correction factors of used cables, switch unit, distance correction, amplifier (if applicable)

distance correction = $-40 * \text{LOG} (d_{\text{Limit}} / d_{\text{used}})$

Linear interpolation will be used for frequencies in between the values in the table.

Table shows an extract of values

6.3 ANTENNA R&S HL562 (30 MHZ – 1 GHZ)

($d_{Limit} = 3\text{ m}$)

Frequency	AF R&S HL562	Corr.
MHz	dB (1/m)	dB
30	18.6	0.6
50	6.0	0.9
100	9.7	1.2
150	7.9	1.6
200	7.6	1.9
250	9.5	2.1
300	11.0	2.3
350	12.4	2.6
400	13.6	2.9
450	14.7	3.1
500	15.6	3.2
550	16.3	3.5
600	17.2	3.5
650	18.1	3.6
700	18.5	3.6
750	19.1	4.1
800	19.6	4.1
850	20.1	4.4
900	20.8	4.7
950	21.1	4.8
1000	21.6	4.9

cable loss 1 (inside chamber)	cable loss 2 (outside chamber)	cable loss 3 (switch unit)	cable loss 4 (to receiver)	distance corr. (-20 dB/ decade)	d_{Limit} (meas. distance (limit))	d_{used} (meas. distance (used))
dB	dB	dB	dB	dB	m	m
0.29	0.04	0.23	0.02	0.0	3	3
0.39	0.09	0.32	0.08	0.0	3	3
0.56	0.14	0.47	0.08	0.0	3	3
0.73	0.20	0.59	0.12	0.0	3	3
0.84	0.21	0.70	0.11	0.0	3	3
0.98	0.24	0.80	0.13	0.0	3	3
1.04	0.26	0.89	0.15	0.0	3	3
1.18	0.31	0.96	0.13	0.0	3	3
1.28	0.35	1.03	0.19	0.0	3	3
1.39	0.38	1.11	0.22	0.0	3	3
1.44	0.39	1.20	0.19	0.0	3	3
1.55	0.46	1.24	0.23	0.0	3	3
1.59	0.43	1.29	0.23	0.0	3	3
1.67	0.34	1.35	0.22	0.0	3	3
1.67	0.42	1.41	0.15	0.0	3	3
1.87	0.54	1.46	0.25	0.0	3	3
1.90	0.46	1.51	0.25	0.0	3	3
1.99	0.60	1.56	0.27	0.0	3	3
2.14	0.60	1.63	0.29	0.0	3	3
2.22	0.60	1.66	0.33	0.0	3	3
2.23	0.61	1.71	0.30	0.0	3	3

($d_{Limit} = 10\text{ m}$)

30	18.6	-9.9
50	6.0	-9.6
100	9.7	-9.2
150	7.9	-8.8
200	7.6	-8.6
250	9.5	-8.3
300	11.0	-8.1
350	12.4	-7.9
400	13.6	-7.6
450	14.7	-7.4
500	15.6	-7.2
550	16.3	-7.0
600	17.2	-6.9
650	18.1	-6.9
700	18.5	-6.8
750	19.1	-6.3
800	19.6	-6.3
850	20.1	-6.0
900	20.8	-5.8
950	21.1	-5.6
1000	21.6	-5.6

0.29	0.04	0.23	0.02	-10.5	10	3
0.39	0.09	0.32	0.08	-10.5	10	3
0.56	0.14	0.47	0.08	-10.5	10	3
0.73	0.20	0.59	0.12	-10.5	10	3
0.84	0.21	0.70	0.11	-10.5	10	3
0.98	0.24	0.80	0.13	-10.5	10	3
1.04	0.26	0.89	0.15	-10.5	10	3
1.18	0.31	0.96	0.13	-10.5	10	3
1.28	0.35	1.03	0.19	-10.5	10	3
1.39	0.38	1.11	0.22	-10.5	10	3
1.44	0.39	1.20	0.19	-10.5	10	3
1.55	0.46	1.24	0.23	-10.5	10	3
1.59	0.43	1.29	0.23	-10.5	10	3
1.67	0.34	1.35	0.22	-10.5	10	3
1.67	0.42	1.41	0.15	-10.5	10	3
1.87	0.54	1.46	0.25	-10.5	10	3
1.90	0.46	1.51	0.25	-10.5	10	3
1.99	0.60	1.56	0.27	-10.5	10	3
2.14	0.60	1.63	0.29	-10.5	10	3
2.22	0.60	1.66	0.33	-10.5	10	3
2.23	0.61	1.71	0.30	-10.5	10	3

Sample calculation

$$E \text{ (dB } \mu\text{V/m)} = U \text{ (dB } \mu\text{V)} + \text{AF (dB 1/m)} + \text{Corr. (dB)}$$

U = Receiver reading

AF = Antenna factor

Corr. = sum of single correction factors of used cables, switch unit, distance correction, amplifier (if applicable)

distance correction = $-20 * \text{LOG} (d_{Limit} / d_{used})$

Linear interpolation will be used for frequencies in between the values in the table.

Tables show an extract of values.

6.4 ANTENNA R&S HF907 (1 GHZ – 18 GHZ)

Frequency MHz	AF R&S HF907 dB (1/m)	Corr. dB
1000	24.4	-19.4
2000	28.5	-17.4
3000	31.0	-16.1
4000	33.1	-14.7
5000	34.4	-13.7
6000	34.7	-12.7
7000	35.6	-11.0

cable loss 1 (relay + cable inside chamber) dB	cable loss 2 (outside chamber) dB	cable loss 3 (switch unit, atten- uator & pre-amp) dB	cable loss 4 (to receiver) dB
0.99	0.31	-21.51	0.79
1.44	0.44	-20.63	1.38
1.87	0.53	-19.85	1.33
2.41	0.67	-19.13	1.31
2.78	0.86	-18.71	1.40
2.74	0.90	-17.83	1.47
2.82	0.86	-16.19	1.46

Frequency MHz	AF R&S HF907 dB (1/m)	Corr. dB
3000	31.0	-23.4
4000	33.1	-23.3
5000	34.4	-21.7
6000	34.7	-21.2
7000	35.6	-19.8

cable loss 1 (relay inside chamber) dB	cable loss 2 (inside chamber) dB	cable loss 3 (outside chamber) dB	cable loss 4 (switch unit, atten- uator & pre-amp) dB	cable loss 5 (to receiver) dB	used for FCC 15.247
0.47	1.87	0.53	-27.58	1.33	
0.56	2.41	0.67	-28.23	1.31	
0.61	2.78	0.86	-27.35	1.40	
0.58	2.74	0.90	-26.89	1.47	
0.66	2.82	0.86	-25.58	1.46	

Frequency MHz	AF R&S HF907 dB (1/m)	Corr. dB
7000	35.6	-57.3
8000	36.3	-56.3
9000	37.1	-55.3
10000	37.5	-56.2
11000	37.5	-55.3
12000	37.6	-53.7
13000	38.2	-53.5
14000	39.9	-56.3
15000	40.9	-54.1
16000	41.3	-54.1
17000	42.8	-54.4
18000	44.2	-54.7

cable loss 1 (relay inside chamber) dB	cable loss 2 (High Pass) dB	cable loss 3 (pre- amp) dB	cable loss 4 (inside chamber) dB	cable loss 5 (outside chamber) dB	cable loss 6 (to receiver) dB
0.56	1.28	-62.72	2.66	0.94	1.46
0.69	0.71	-61.49	2.84	1.00	1.53
0.68	0.65	-60.80	3.06	1.09	1.60
0.70	0.54	-61.91	3.28	1.20	1.67
0.80	0.61	-61.40	3.43	1.27	1.70
0.84	0.42	-59.70	3.53	1.26	1.73
0.83	0.44	-59.81	3.75	1.32	1.83
0.91	0.53	-63.03	3.91	1.40	1.77
0.98	0.54	-61.05	4.02	1.44	1.83
1.23	0.49	-61.51	4.17	1.51	1.85
1.36	0.76	-62.36	4.34	1.53	2.00
1.70	0.53	-62.88	4.41	1.55	1.91

Sample calculation

$E \text{ (dB } \mu\text{V/m)} = U \text{ (dB } \mu\text{V)} + \text{AF (dB 1/m)} + \text{Corr. (dB)}$
 U = Receiver reading
 AF = Antenna factor
 Corr. = sum of single correction factors of used cables, switch unit, distance correction, amplifier (if applicable)
 Linear interpolation will be used for frequencies in between the values in the table.
 Tables show an extract of values.

6.5 ANTENNA EMCO 3160-09 (18 GHZ – 26.5 GHZ)

Frequency MHz	AF EMCO 3160-09 dB (1/m)	Corr. dB
18000	40.2	-23.5
18500	40.2	-23.2
19000	40.2	-22.0
19500	40.3	-21.3
20000	40.3	-20.3
20500	40.3	-19.9
21000	40.3	-19.1
21500	40.3	-19.1
22000	40.3	-18.7
22500	40.4	-19.0
23000	40.4	-19.5
23500	40.4	-19.3
24000	40.4	-19.8
24500	40.4	-19.5
25000	40.4	-19.3
25500	40.5	-20.4
26000	40.5	-21.3
26500	40.5	-21.1

cable loss 1 (inside chamber) dB	cable loss 2 (pre- amp) dB	cable loss 3 (inside chamber) dB	cable loss 4 (switch unit) dB	cable loss 5 (to receiver) dB
0.72	-35.85	6.20	2.81	2.65
0.69	-35.71	6.46	2.76	2.59
0.76	-35.44	6.69	3.15	2.79
0.74	-35.07	7.04	3.11	2.91
0.72	-34.49	7.30	3.07	3.05
0.78	-34.46	7.48	3.12	3.15
0.87	-34.07	7.61	3.20	3.33
0.90	-33.96	7.47	3.28	3.19
0.89	-33.57	7.34	3.35	3.28
0.87	-33.66	7.06	3.75	2.94
0.88	-33.75	6.92	3.77	2.70
0.90	-33.35	6.99	3.52	2.66
0.88	-33.99	6.88	3.88	2.58
0.91	-33.89	7.01	3.93	2.51
0.88	-33.00	6.72	3.96	2.14
0.89	-34.07	6.90	3.66	2.22
0.86	-35.11	7.02	3.69	2.28
0.90	-35.20	7.15	3.91	2.36

Sample calculation

$$E \text{ (dB } \mu\text{V/m)} = U \text{ (dB } \mu\text{V)} + AF \text{ (dB 1/m)} + Corr. \text{ (dB)}$$

U = Receiver reading

AF = Antenna factor

Corr. = sum of single correction factors of used cables, switch unit, distance correction, amplifier (if applicable)

Linear interpolation will be used for frequencies in between the values in the table.

Table shows an extract of values.

6.6 ANTENNA EMCO 3160-10 (26.5 GHZ – 40 GHZ)

Frequency GHz	AF EMCO 3160-10 dB (1/m)	Corr. dB	cable loss 1 (inside chamber) dB	cable loss 2 (outside chamber) dB	cable loss 3 (switch unit) dB	cable loss 4 (to receiver) dB	distance corr. (-20 dB/ decade) dB	d _{Limit} (meas. distance (limit) m	d _{used} (meas. distance (used) m
26.5	43.4	-11.2	4.4				-9.5	3	1.0
27.0	43.4	-11.2	4.4				-9.5	3	1.0
28.0	43.4	-11.1	4.5				-9.5	3	1.0
29.0	43.5	-11.0	4.6				-9.5	3	1.0
30.0	43.5	-10.9	4.7				-9.5	3	1.0
31.0	43.5	-10.8	4.7				-9.5	3	1.0
32.0	43.5	-10.7	4.8				-9.5	3	1.0
33.0	43.6	-10.7	4.9				-9.5	3	1.0
34.0	43.6	-10.6	5.0				-9.5	3	1.0
35.0	43.6	-10.5	5.1				-9.5	3	1.0
36.0	43.6	-10.4	5.1				-9.5	3	1.0
37.0	43.7	-10.3	5.2				-9.5	3	1.0
38.0	43.7	-10.2	5.3				-9.5	3	1.0
39.0	43.7	-10.2	5.4				-9.5	3	1.0
40.0	43.8	-10.1	5.5				-9.5	3	1.0

Sample calculation

$$E \text{ (dB } \mu\text{V/m)} = U \text{ (dB } \mu\text{V)} + \text{AF (dB 1/m)} + \text{Corr. (dB)}$$

U = Receiver reading

AF = Antenna factor

Corr. = sum of single correction factors of used cables, switch unit, distance correction, amplifier (if applicable)

Linear interpolation will be used for frequencies in between the values in the table.

distance correction = $-20 * \text{LOG} (d_{\text{Limit}} / d_{\text{used}})$

Linear interpolation will be used for frequencies in between the values in the table.

Table shows an extract of values.

7 MEASUREMENT UNCERTAINTIES

Test Case(s)	Parameter	Uncertainty
- Field strength of spurious radiation	Field Strength	± 5.5 dB
- Emission and Occupied Bandwidth	Power Frequency	± 2.9 dB ± 11.2 kHz
- RF Output Power - Peak to Average Ratio	Power	± 2.2 dB
- Band Edge Compliance - Spurious Emissions at Antenna Terminal	Power Frequency	± 2.2 dB ± 11.2 kHz
- Frequency Stability	Frequency	± 25 Hz

The measurement uncertainties for all parameters are calculated with an expansion factor (coverage factor) $k = 1.96$. This means, that the true value is in the corresponding interval with a probability of 95 %.

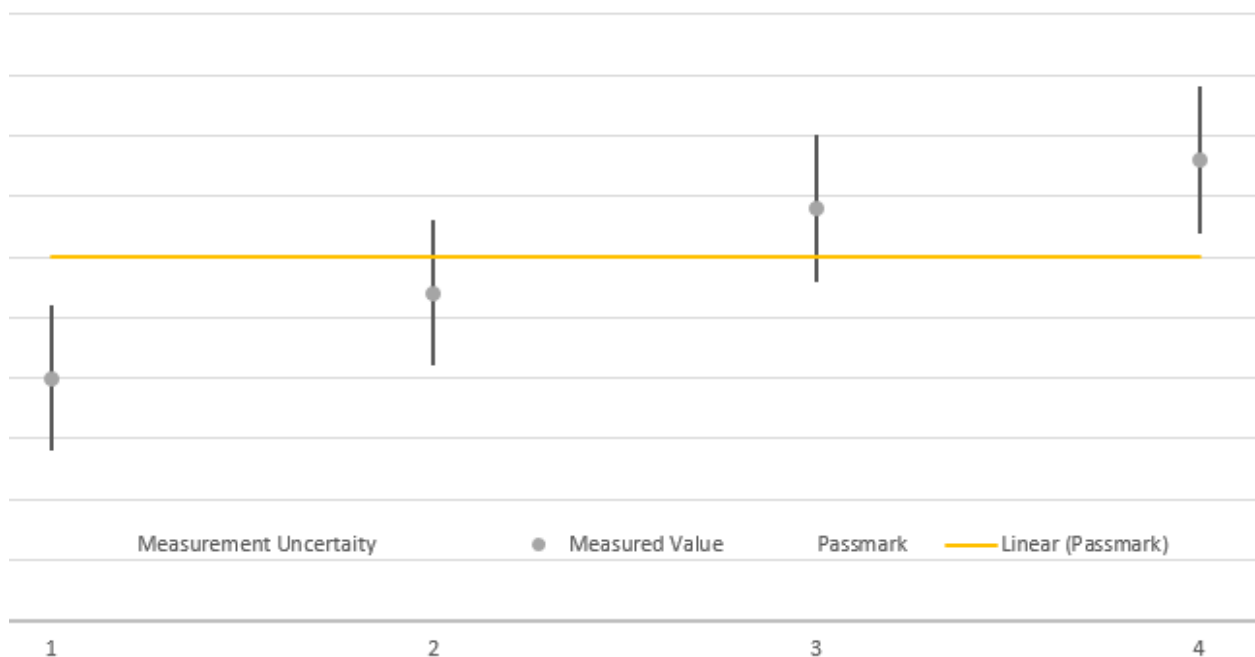

The verdicts in this test report are given according the above diagram:

Case	Measured Value	Uncertainty Range	Verdict
1	below pass mark	below pass mark	Passed
2	below pass mark	within pass mark	Passed
3	above pass mark	within pass mark	Failed
4	above pass mark	above pass mark	Failed

That means, the laboratory applies, as decision rule (see ISO/IEC 17025:2017), the so called shared risk principle.

8 PHOTO REPORT

Please see separate photo report.