





RF-Exposure  
(MPE) TEST REPORT  
No.: 2-20773166d/09

According to:  
**FCC Regulations**  
Part 2.1091  
**IC Regulations**  
RSS-102

for  
u-blox AG

Quad Band GSM/GPRS data and voice module LEON-G200  
FCC-ID: XPYLEONG200

Laboratory Accreditation and Listings			
 Deutscher Akkreditierungs Rat  DAT-P176/94-02	 FEDERAL COMMUNICATIONS COMMISSION U.S.A. Reg. No.: 99538 MRA US-EU 0003	 Industry Canada Reg. No.: 3462D-1 3462D-2	 Reg. No.: R-2665, R-2666 C-2914, T-339
accredited according to DIN EN ISO/IEC 17025			
<p><b>CETECOM GmbH</b>            Laboratory Radio Communications &amp; Electromagnetic Compatibility            Im Teelbruch 116 • 45219 Essen • Germany            Registered in Essen, Germany, Reg. No.: HRB Essen 8984            Tel.: + 49 (0) 20 54 / 95 19-954 • Fax: + 49 (0) 20 54 / 95 19-964            E-mail: info@cetecom.de • Internet: www.cetecom.com</p>			

## Table of contents

<b>1. SUMMARY OF TEST RESULTS.....</b>	<b>3</b>
1.1. TESTS OVERVIEW FCC Part 2.1091 and Kanada IC Standards (RSS) .....	3
<b>2. ADMINISTRATIVE DATA .....</b>	<b>4</b>
2.1. Identification of the testing laboratory.....	4
2.2. Test location .....	4
2.3. Organizational items .....	4
2.4. Applicant’s details .....	4
2.5. Manufacturer’s details .....	4
<b>3. EQUIPMENT UNDER TEST (EUT).....</b>	<b>5</b>
3.1. Additional declaration and description of main EUT .....	5
3.2. Configuration of cables used for testing .....	5
3.3. EUT: Type, S/N etc. and short descriptions used in this test report .....	6
3.4. Auxiliary Equipment (AE): Type, S/N etc. and short descriptions.....	6
3.5. EUT set-ups .....	7
3.6. EUT operating modes .....	7
3.7. Parameter Settings on mobile phone and base station CMU200 .....	8
<b>4. DESCRIPTION OF TEST SET-UP’S.....</b>	<b>9</b>
4.1. Test Set-up for conducted measurements .....	9
4.2. Test set-up for radiated measurements .....	10
<b>5. MEASUREMENTS RADIO FREQUENCY EXPOSURE EVALUATION: MOBILE EQUIPMENT, §2.1091 .....</b>	<b>11</b>
5.1. Measurement method.....	12
5.2. Results for fixed operations .....	13
5.3. Results for mobile operations: .....	15
<b>6. MEASUREMENT UNCERTAINTIES.....</b>	<b>16</b>
<b>7. INSTRUMENTS AND ANCILLARY.....</b>	<b>17</b>
7.1. Used equipment “CTC” .....	17

## Table of annex

Total pages

NONE

## 1. Summary of test results

The test results apply exclusively to the test samples as presented in chapter 3.1. The CETECOM GmbH does not assume responsibility for any conclusions and generalizations taken in conjunction with other specimens or samples of the type of the item presented to tests.

The presented GSM 850/900/1800/1900 Module can be build inside host applications and extends their capability by wireless GSM technology. Data transmission or voice application are possible field applications.

In order to verify the compliance, a representative configuration consisting of different auxiliary equipment was chosen. Embedded in this configuration, the GSM/GPRS Module can be tested.

The type of the presented test device is LEON-G200.

Following tests have been performed to show compliance with applicable FCC Part 2.1091 and FCC Part 1.1310 of the FCC CFR 47 Rules.

### 1.1. TESTS OVERVIEW FCC Part 2.1091 and Kanada IC Standards (RSS)

TEST CASES	PORT	REFERENCES & LIMITS			EUT set-up	EUT operating mode	Result
		FCC Standard	RSS Section	Limits			
<b>TX-Mode</b>							
RF POWER (conducted)	Antenna terminal (conducted)	§2.1046	--	N/A	2	2+4	Passed Remark 1
RF POWER (radiated)	Cabinet	§2.1046 §22.913(a)(2)  §24.232(c)	RSS-132: 4.4 SRSP-503: 5.1.3  RSS-133:6.4 SRSP-510: 5.1.2	GSM850: < 7 Watt ERP  GSM1900: < 2Watt (EIRP)	1	2+4	Passed Remark 1
Radio frequency Exposure EVALUATION (MPE)	Cabinet	§1.1310 §2.1091	RSS-102, Issue 2	FCC: §1.1310 Table 1, Limits for General Population IC: Chapter 4.2 RF-Limits	--	2+4	Passed

Remark: 1.) See separate test report B\_2\_20773166b/07 for measurements according Part 22/24



D. Franke  
Responsible for test section



GmbH  
Im Teelbruch 116  
45219 Essen  
Tel.: + 49 (0) 20 54 / 95 19 - 0  
Fax: + 49 (0) 20 54 / 95 19 - 997



Dipl. Ing. Christian Lorenz  
Responsible for test report

## 2. Administrative Data

### 2.1. Identification of the testing laboratory

Company name:	CETECOM GmbH
Address:	Im Teelbruch 116 45219 Essen - Kettwig Germany
Laboratory accreditations/Listings:	DAR-Registration No. DAT-P176/94-02 FCC-Registration No. 99538, MRA US-EU 0003 IC-Registration No. 3462D-1, 3462D-2 VCCI Registration No. R-2665,R-2666,C-2914,T-339
Responsible for testing laboratory:	Dipl.-Ing. W. Richter
Deputies:	D. Franke

### 2.2. Test location

#### 2.2.1. Test laboratory "CTC"

Company name:	see chapter 2.1. Identification of the testing laboratory
---------------	---

### 2.3. Organizational items

Order No.:	20773166
Responsible for test report and project leader:	Dipl.-Ing. C. Lorenz
Receipt of EUT:	2009-08-03
Date(s) of test:	2009-08-03 to 2009-08-16
Date of report:	2009-08-31
-----	
Version of template:	09.06 _All.Dotm

### 2.4. Applicant's details

Applicant's name:	u-blox AG
Address:	Zürcherstrasse 68  8800 Thalwil Switzerland
Contact person:	Mr. Andreas Thiel

### 2.5. Manufacturer's details

Manufacturer's name:	please see Applicant's details
Address:	please see Applicant's details

### 3. Equipment under test (EUT)

#### 3.1. Additional declaration and description of main EUT

Main function	Quad-Band GSM/GPRS voice and data module		
Type	LEON-G200		
GSM Frequency range	GSM 850: 824 – 849MHz (Uplink), 869-894MHz (Downlink) GSM1900: 1850-1910MHz (Uplink), 1930-1990MHz (Downlink)		
Type of modulation	GMSK		
Number of channels	GSM 850: 128 – 251, 125 channels GSM1900: 512 – 810, 300 channels		
EMISSION DESIGNATOR(S)	300KGXW (GSM)		
Antenna Type	<input type="checkbox"/> Integrated <input type="checkbox"/> External, no RF- connector <input checked="" type="checkbox"/> External, separate RF-connector	Frequency range: GSM 850: 824 – 894 MHz GSM 1900: 1710-1990 MHz	
Antenna Gain	Max.2 dBi (commercial antenna, stub version)		
MAX PEAK Output Power: GSM 850 Radiated	25.2 dBm		
GSM 1900	26.8 dBm		
MAX PEAK Output Power: GSM 850 Conducted	32.8 dBm		
GSM 1900	30.6 dBm		
FCC-ID	XPYLEONG200		
Canada certification number (IC)	8595A-LEONG200		
Installed option	<input checked="" type="checkbox"/> GSM900 and GSM1800 Bands <input checked="" type="checkbox"/> battery charging option		
Special EMI components	--		
Power supply	AC/DC power adapter to DC socket J213 of the mainboard DC voltage on port J215 of the mainboard in the range 3.5 to 4.2 Volt		
EUT sample type	<input type="checkbox"/> Production	<input checked="" type="checkbox"/> Pre-Production	<input type="checkbox"/> Engineering

#### 3.2. Configuration of cables used for testing

Cable number	Item	Type	S/N serial number	HW hardware status	Cable length
Cable 1	USB cable	MINI-SUB to USB	#1	--	1.83m

### 3.3. EUT: Type, S/N etc. and short descriptions used in this test report

Short description*)	EUT	Type	S/N serial number	HW hardware status	SW software status
EUT A	Quad Band GSM/GPRS data and voice module	LEON-G200	IMEI: 004402-09-002411-2	GB01.HW.HR.100001	GB01.SW.SR07.10.00
EUT B	Adapter Board	GB01	#1	GB01_HW_HS_102000	--
EUT C	Motherboard	N7MB3	SN 36	EN01_HW_HS_068C00	--
EUT D	Motherboard	N7MB3	SN 33	EN01_HW_HS_068C00	--
EUT E	Magnetic mount antenna	MAR-C3G-2F	CTC #1	2dBi gain	--

\*) EUT short description is used to simplify the identification of the EUT in this test report.

### 3.4. Auxiliary Equipment (AE): Type, S/N etc. and short descriptions

AE short description *)	Auxiliary Equipment	Type	S/N serial number	HW hardware status	SW software status
AE 1	AC to DC Adaptor	0055	--	Input: AC 100-240V 800mA, 50/60Hz Output: changeable	--
AE 2	Handset Votronic for LEON-G200	Type 2	#1	HH-SI-30.3/V2.0/0	--
AE 3	Notebook	Dell D610	PC CTC 4	--	Windows XP + Terminal program
AE 4	USB cable	Mini USB to USB	#1	1.83m	--

\*) AE short description is used to simplify the identification of the auxiliary equipment in this test report.

### 3.5.EUT set-ups

EUT set-up no. *)	Combination of EUT and AE	Remarks
Set. 1	EUT A + EUT B + EUT C + EUT E + AE 1 + AE 2 + (AE 3)	Tests used with mainboard with regulated external power supply 110V/60Hz, AE1. Used voltage input for tests: J213  Set-up used for radiated emission tests
Set. 2	EUT A + EUT B + EUT D + EUT E + AE 1 + AE 2 + AE 4 + (AE3)	Tests used with mainboard external power supplied in the range 3.5 to 4.2 Volt. Except for climatic tests on extreme voltage range a nominal voltage of 3.V was used. Used voltage input for tests: V <sub>BAT</sub>  Set-up used for conducted tests

\*) EUT set-up no. is used to simplify the identification of the EUT set-up in this test report.

### 3.6. EUT operating modes

EUT operating mode no. *)	Description of operating modes	Additional information
op. 1	<b>GSM 850</b> Idle mode BCCH 50	The mobile station is synchronized to the Broadcast Control Channel (BCCH) and listening to the Common Control Channel (CCCH). Periodic location update is disabled.
op. 2	<b>GSM 850</b> TCH mode TCH=128/192/251	A communication link is established between the mobile station and the test simulator. The transmitter is operated at its maximum rated output power: 33 dBm (power class 4; power control level 5). The input signal to the receiver is modulated with normal test modulation. The wanted RF input signal level to the receiver of the mobile station is set to a level to provide a stable communication link.
op. 3	<b>GSM 1900</b> Idle mode BCCH 651	The mobile station is synchronized to the Broadcast Control Channel (BCCH) and listening to the Common Control Channel (CCCH).
op. 4	<b>GSM 1900</b> TCH mode TCH=512/661/810	A communication link is established between the mobile station and the test simulator. The transmitter is operated at its maximum rated output power: 30 dBm (power class 1; power control level 0). The input signal to the receiver is modulated with normal test modulation. The wanted RF input signal level to the receiver of the mobile station is set to a level to provide a stable communication link

\*) EUT operating mode no. is used to simplify the test report.

### 3.7. Parameter Settings on mobile phone and base station CMU200

Following settings apply to the MS during the measurements in GSM/(E)GPRS-Mode only:

Parameter	Traffic Mode	Idle Mode
Traffic Channels mobile station (EUT)	GSM 850 TCH <sub>MS</sub> = 128/ 192 /251 GSM 1900 TCH <sub>MS</sub> = 512 / 681 / 810	--
maximum power level (PCL)	GSM 850: PCL = 5 (2 Watt) GSM 1900: PCL = 0 (1 Watt)	--
Modulation	GSM: GMSK-Modulation Scheme EDGE: 8-PSK Modulation Scheme	--
DTX	off	--
Bitstream	PRBS 2E9-1 (pseudo-random-sequence) – CCITT 0.153	
Timeslot	3	
Hopping	off	
Timeslot (slot mode)	GSM-Mode: single GPRS-Mode: maximum allowed uplink slots no. according MS class	
MS slot class	Class 10	
Maximum data transmission rate, single time slot	GSM: 17,6 kBit/s Slot EDGE: 59,2 kBit/s Slot	
Speech transcoding (Traffic Mode)	Full rate Version 1	
Mode	BCCH and TCH	
BCCH – base station (CMU,CMD)		GSM 850: 180 GSM 1900: 651
TCH – base station (CMD, CMU)	auto	
Power level TCH – base station (used timeslot level)	- 70 dBm	
Power level BCCH – base station (control channel level)	- 80 dBm	
External attenuation RF/AF-Input/Output	Accord. calibration prior to measurements	
Mobile Country Code	310	310
BS_AG_BLK_RES		0
Paging reorganisation		Off (0)
Signalling channel	Not applicable	SDCCH
Location Update		Auto
Cell access		Disabled (barred)

#### Settings for CMU (general)

Repetition	Continuous
Stop condition	None
Display mode	Max./Min
Statistic Count	1000 Bursts
Decoder	Standard

Additional settings on the base stations CMU200 for frequency stability measurements



## 4. DESCRIPTION OF TEST SET-UP'S

### 4.1. Test Set-up for conducted measurements

The EUT's RF-signal is coupled out by a suitable antenna coupling connector (1). The signal is first 10 dB attenuated (2) before it is 0° divided by a power divider (3). One of the signal path is connected to the communication base station (4), other branch is connected to the spectrum – analyzer (6). The specific attenuation losses for both signal paths/branches are determined prior to the measurement within a set-up calibration. These are then taken into account by correcting the measurement readings on the spectrum-analyzer.

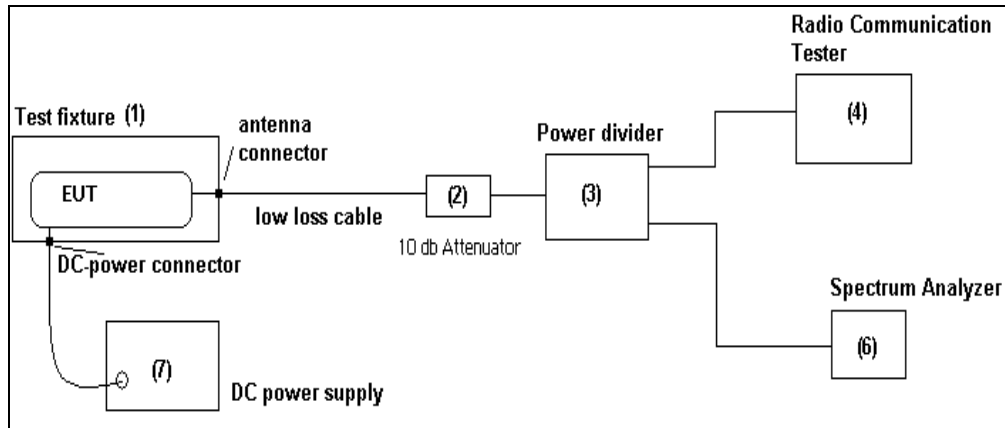

Schematic: Test set-up conducted

## 4.2. Test set-up for radiated measurements

The radiated emissions from the test device are measured first as exploratory measurement in a FCC recognized semi anechoic chamber (registration no. 99538) or fully anechoic chamber with the dimensions of 8.05m x 6.85m x 5.48m. Very critical frequencies within a defined range, can be re-checked on CETECOM's Open Area Test side, recognized by the FCC to be compliant with ANSI 63.4: 2001 according registration no. 99538.

The EUT and accessories are placed on a non-conducting tipping table of 0.8 meter height (semi-anechoic chamber) or 1.55m height (fully-anechoic chamber) which is situated in the middle of the turntable. The turntable can rotate the device under test 360 degree, the tipping table can rotate the device from laid to standing position. This way the device under test can be rotated in all three orthogonal planes in order to maximize the detected emissions. The turn- and tipping table are controlled by a controller unit. All positions manipulations are software controlled from a operator PC.

The measurements are performed for both receiving antenna polarisations: vertical and horizontal.

Up to 18GHz a measurement distance of 3 meters is used, above 18GHz the distance is 1meter. A biconical-logarithmic antenna up to 1 GHz and a horn antenna for frequencies above 1 GHz used. (see equipment list)

The EUT is powered either by a external DC-supply with nominal voltage or a AC/DC power supply as accessory. The communication signalling is performed from outside the chamber with a communication test simulator (CMU200 from Rohde&Schwarz) by airtlink.

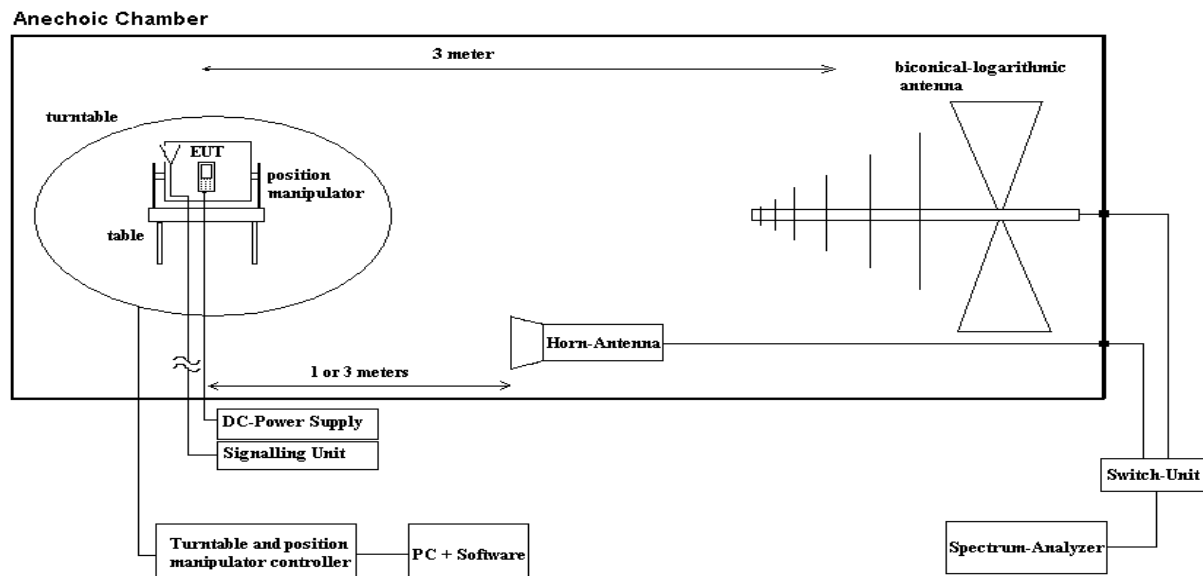

Schematic: radiated measurements test set-up

## 5. Measurements Radio Frequency Exposure Evaluation: Mobile equipment, §2.1091

### RESULTS (CONDUCTED)

#### References: §1.1310, § 2.1091

The criteria used for the evaluation of human exposure to radio frequency radiation is table 1 according §1.1310. As the GSM/GPRS Module equipment is authorized under Part 22 (Subpart H) and Part 24 of the FCC Rules, it is subject for evaluation of the RF exposure prior to equipment authorization.

§2.1091: Further information on evaluating compliance with these limits can be found in the FCC’s OST/OET Bulletin Number 65, ‘Evaluating Compliance with FCC-Specified Guidelines for Human Exposure to Radiofrequency Radiation.’

For purposes of these requirements mobile devices are defined by the FCC as transmitters designed to be used in other than fixed locations and to generally be used in such a way that a separation distance of at least 20 centimeters is normally maintained between radiating structures and the body of the user or nearby persons. These devices are normally evaluated for exposure potential with relation to the MPE limits given in Table 1 of Appendix A.

TABLE 1—LIMITS FOR MAXIMUM PERMISSIBLE EXPOSURE (MPE)—Continued

Frequency range (MHz)	Electric field strength (V/m)	Magnetic field strength (A/m)	Power density (mW/cm <sup>2</sup> )	Averaging time (minutes)
30–300 .....	61.4	0.163	1.0	6
300–1500 .....	.....	.....	f/300	6
1500–100,000 .....	.....	.....	5	6
<b>(B) Limits for General Population/Uncontrolled Exposure</b>				
0.3–1.34 .....	614	1.63	*(100)	30
1.34–30 .....	824/f	2.19/f	*(180/f <sup>2</sup> )	30
30–300 .....	27.5	0.073	0.2	30
300–1500 .....	.....	.....	f/1500	30
1500–100,000 .....	.....	.....	1.0	30

f = frequency in MHz

**Table 1: LIMITS FOR MAXIMUM PERMISSIBLE EXPOSURE (MPE)**

The used equation to predict the power density in the far-field of one single radiating antenna can be made by following equation:

$$S = \frac{EIRP}{4\pi R^2} = \frac{P * G}{4\pi R^2}$$

Abbreviations:

- S: Power density (unit: mW/cm<sup>2</sup>)
- P: Power Input to the antenna
- G: Gain of the antenna relative to an isotropic radiator, for further calculation assumed to be 0 dBi (Gain numeric=1)
- EIRP: Equivalent isotropically radiated power, determined within a separate measurement (unit: mW)

For given power density limit at a single frequency (accord. Table 1 Limits) the maximum antenna gain can be calculated:

$$G_{NUMERIC} = \frac{S * 4\pi R^2}{P}$$

## General Limits:

### §1.1307

Cellular Radiotelephone Service (subpart H of part 22)

Non-building-mounted antennas: height above ground level to lowest point of antenna < 10 m and total power of all channels > 1000 W ERP (1640 W EIRP)

### §1.1307

Personal Communications Services (part 24)

Broadband PCS (subpart E): non-building-mounted antennas: height above ground level to lowest point of antenna < 10 m and total power of all channels > 2000 W ERP (3280 W EIRP)

### §1.1310 LIMITS FOR MAXIMUM PERMISSIBLE EXPOSURE (MPE)

Table 1(B) Limits for General Population/Uncontrolled Exposure

300–1500 MHz:  $f/1500$  mW/cm<sup>2</sup>

1500–100,000 MHz: 1.0 mW/cm<sup>2</sup>

### §2.1091

Subject to routine evaluation is required when the device operate at frequencies of 1.5 GHz or below and their effective radiated power (ERP) is 1.5 watts or more, or if they operate at frequencies above 1.5 GHz and their ERP is 3 watts or more.

### §24.232

(a) Base stations are limited to 1640 watts peak equivalent isotropically radiated power (e.i.r.p.) with an antenna height up to 300 meters HAAT.

b) Mobile/portable stations are limited to 2 watts e.i.r.p. peak power, ...

### §22.913

(a) Maximum ERP. The effective radiated power (ERP) of base transmitters and cellular repeaters must not exceed 500 Watts. The ERP of mobile transmitters and auxiliary test transmitters must not exceed 7 Watts.

## 5.1. Measurement method

The RF-exposure values were derived from the measured conducted Peak Power with assumed antenna gain of 0dBi.

The peak power was checked on 3 frequencies (lowest/middle/highest) within each operable GSM-band. Please refer to chapter 4.1 for the measurement set-up and to corresponding test report according part 22/24.

Please find enclosed the calculation of each limit and the graphical representation for the frequency range 100 MHz to 2.5 GHz. Also the maximum admissible allowed antenna gain is calculated.

In practical not all available conducted power will be delivered to the antenna due to 50Ohm mismatch loss and interconnecting cables.

**For higher power gains of the antenna as calculated below, re-measuring the radiated power (ERP/EIRP) is necessary and the corresponding MPE values.**

For actual project a commercial available antenna stub with antenna gain of 2 dBi was used. Measuring the radiated erp/e.i.r.p power shows a highest value of 25.2 dBm in the critical 850MHz Band.

The corresponding values for the MPE value are far away from exceeding the allowed MPE-values. The second table and diagram show the results.

## 5.2. Results for fixed operations

General result for fixed GSM operations with assumed 0dBi antenna gain:

Band	Channel no.	Channel Frequency	Power-Values		MPE-Value	MPE-Limit	Margin to limit	maximum admissible Antenna gain at 20 cm distance (Unit: dBi)*
			(Unit:dBm)	(Unit: mWatt)	(Unit: mWatt/cm <sup>2</sup> )			

GSM 850	128	824,2	32,6	1819,70	0,3620	0,5495	0,1874	1,8120
	192	837	32,8	1905,46	0,3791	0,5580	0,1789	1,6789
	251	848,8	32,6	1819,70	0,3620	0,5659	0,2038	1,9397

GSM 1900	512	1850,2	30,6	1148,15	0,2284	1,0000	0,7716	6,4126
	661	1880	30,6	1148,15	0,2284	1,0000	0,7716	6,4126
	810	1808,8	30,2	1047,13	0,2083	1,0000	0,7917	6,8126

Remark: conducted power values can be found in test report B\_2\_20773166b/09.

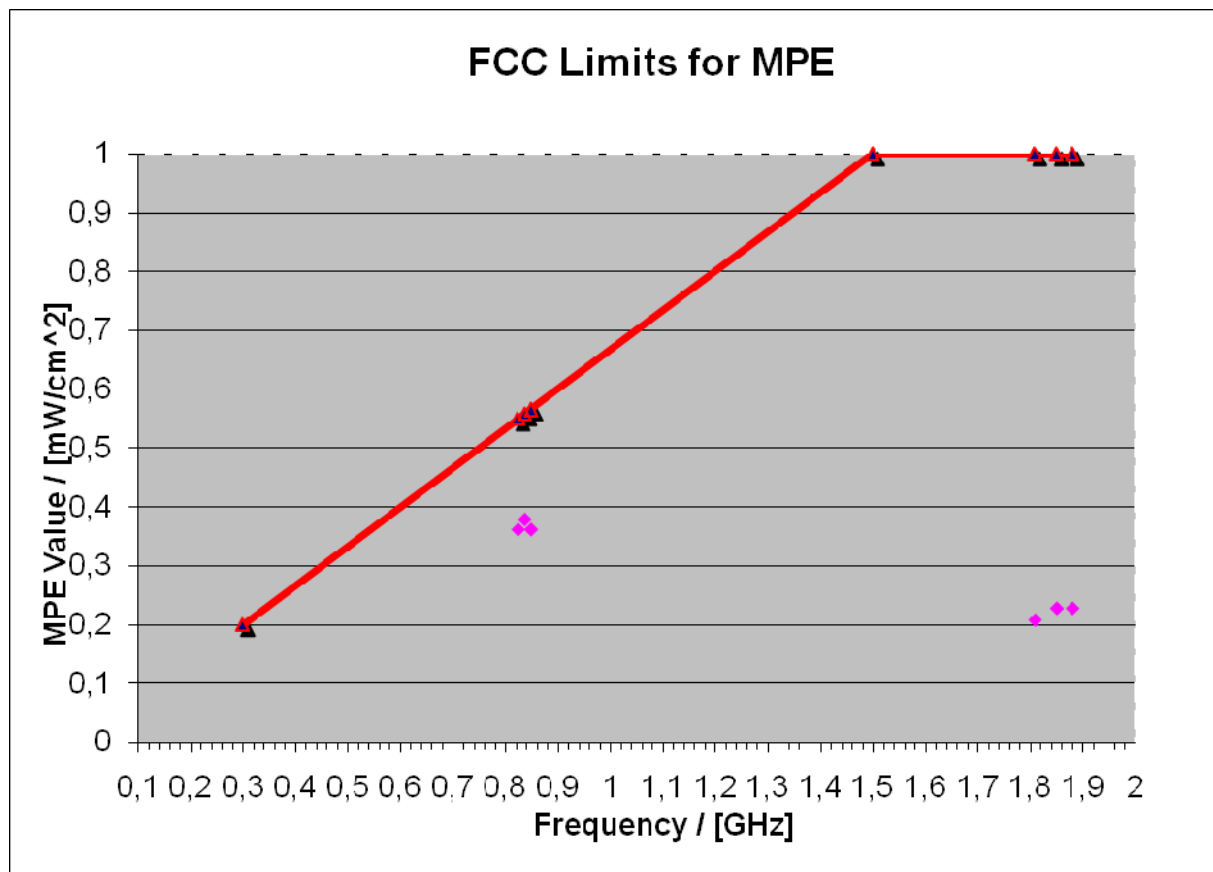

**Result for fixed GSM operations for radiated measurement set-up (stub antenna with 2 dBi gain) as used in test report B\_2\_20773166b/09**

Band	Channel no.	Channel Frequency	Power-Values		MPE-Value	MPE-Limit	Margin to limit
			(Unit: dBm)	(Unit: mWatt)	(Unit: mWatt/cm <sup>2</sup> )		
GSM 850	128	824,2	24,8	302,00	0,0601	0,5495	0,4894
	192	837	22,6	181,97	0,0362	0,5580	0,5218
	251	848,8	25,2	331,13	0,0659	0,5659	0,5000
GSM 1900	512	1850,2	26,8	478,63	0,0952	1,0000	0,9048
	661	1880	23,2	208,93	0,0416	1,0000	0,9584
	810	1808,8	24,2	263,03	0,0523	1,0000	0,9477

**Remark:** Radiated power values can be found in test report B\_2\_20773166b/09

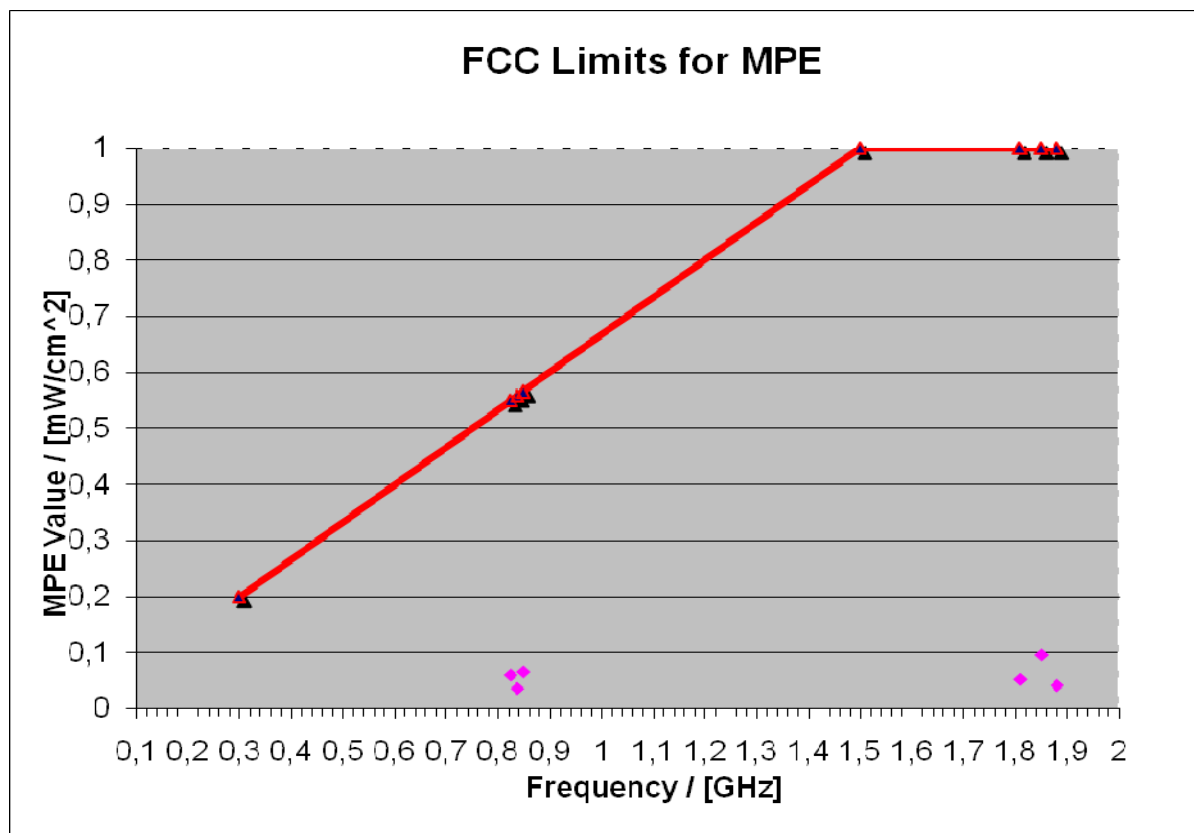

### 5.3. Results for mobile operations:

#### Prediction for Part 22 (max antenna gain for mobile operations)

Maximum conducted peak power: 32.8 dBm.

Highest admissible antenna gain for **850 MHz mobile operations (@20cm)** where no routine evaluation is required according § 2.1091 (c) for P= 1.5W ERP

$$G = 10 \log 1500mW [ERP] - 32.8 \text{ dBm} + 2.14 \text{ dB} = \underline{\underline{1.1 \text{ dBi}}}$$

#### Prediction for Part 24 (max antenna gain for mobile operations)

Maximum conducted peak power: 30.6 dBm.

Highest admissible antenna gain for **1900 MHz mobile operations (@20cm)** where no routine evaluation is required accord. §2.1091 (c) and §24.232 for P= 2W EIRP

$$G = 10 \log 2000mW [EIRP] - 30.6 \text{ dB} = \underline{\underline{2.41 \text{ dBi}}}$$

## 6. Measurement uncertainties

The reported uncertainties are calculated based on the standard uncertainty multiplied with the appropriate coverage factor **k**, such that a confidence level of approximately 95% is achieved.

For uncertainty determination, each component used in the concrete measurement set-up was taken in account and it's contribution to the overall uncertainty according it's statistical distribution calculated.

Following table shows expectable uncertainties for each measurement type performed.

Measurement	Frequency range	Calculated uncertainty based on a confidence level of 95%	Remarks:
RF-Power Output conducted	9 kHz .. 20 GHz	1.0 dB	--
RF-Power Output radiated	30 MHz .. 4 GHz	3.17 dB	Substitution method
Conducted RF-emissions on antenna ports	9 kHz .. 20 GHz	1.0 dB	--
Radiated RF-emissions enclosure	150 kHz .. 30 MHz	5.0 dB	Magnetic field
	30 MHz .. 1 GHz	4.2 dB	E-Field
	1 GHz .. 18GHz	4.8 dB	E-Field
	1 GHz .. 20 GHz	3.17 dB	Substitution method
Occupied bandwidth	9 kHz .. 4 GHz	0.1272 ppm (Delta Marker method)	Frequency error
		1 dB	Power
Emission bandwidth	9 kHz .. 4 GHz	0.1272 ppm (Delta Marker method)	Frequency error
		1 dB	Power
Frequency stability	9 kHz .. 20 GHz	0.0636 ppm	--
Conducted emissions on AC-mains port ( $U_{CISPR}$ )	9 kHz .. 150 kHz	4.0 dB	--
	150 kHz .. 30 MHz	3.6 dB	

**Table : measurement uncertainties, valid for conducted/radiated measurements**



## 7. Instruments and Ancillary

### 7.1. Used equipment "CTC"

The "Ref.-No" in the left column of the following tables allows the clear identification of the laboratory equipment.

#### 7.1.1. Test software and firmware of equipment

Ref.-No.	Equipment	Type	Serial-No.	Version of Firmware or Software during the test
001	emi test receiver	ESS	825132/017	Firm.= 1.21 , OTP=2.0, GRA=2.0
012	signal generator (EMS-cond.)	SMY 01	839069/027	Firm.= V 2.02
013	power meter (EMS cond.)	NRVD	839111/003	Firm.= V 1.51
017	Communication Tester	CMD 60 M	844365/014	Firmware = V 3.52 .22.01.99, DECT Firmware D2.87
053	audio analyzer	UPA3	860612/022	Firm. V 4.3
119	RT harmonics analyser/dig. flickermeter	B10	G60547	Firm.= V 3.1DHG
120	spectrum analyzer	FSEM 30	845538/011	Bios=2.1, Analyzer-Firmware= 3.30.3
140	signal generator	SMHU	831314/006	Firm.= 3.21
261	thermal power sensor	NRV-Z55	825083/0008	EPROM-Datum 02.12.04, SE EE 1 B
262	power meter	NRV-S	825770/0010	Firm.= 2.6
263	signal generator	SMP 04	826190/0007	Firm.=3.21
264	spectrum analyzer	FSEK 30	826939/005	Bios=2.1, Analyzer= 3.20
277	Vector-Networkanalyzer	ZVC	831363/0005	Bios= 3.3, Analyzer=3.52
295	Racal Digital Radio Test Set	6103	1572	UNIT Firmware= 4.04, SW-Main=4.04, SW-BBP=1.04,
298	Radio Communication Tester	CMU 200	832221/091	R&S Test Firmware =3.53 /3.54 (current Testsoftw. f.
323	Communication Tester	CMD 55	825878/0034	Firm.= 3.52 .22.01.99
331	climatic test chamber -40/+80 Grad	HC 4055	43146	TSI 1.53
335	System-CTC-EMS-Conducted	System EMS Conducted	-	EMS-K1 Immunity Test-Software 1.20SR10
340	Communication Tester	CMD 55	849709/037	Firm.= 3.52 .22.01.99
355	power meter	URV 5	891310/027	Firm.= 1.31
365	10V Insertion Unit 50 Ohm	URV5-Z2	100880	Eprom Data = 31.03.08
366	Ultra Compact Simulator	UCS 500 M4	V0531100594	Firm. UCS 500=001925/3.06a02, rc=ISMIEC 4.10
371	Bluetooth Tester	CBT32	100153	CBT V4.6.1 + SW-Option K55
377	emi test receiver	ESCS 30	100160	Firm.= 2.30, OTP= 02.01, GRA= 02.36
378	broadband RF field monitor	RadiSense III	03D00013SNO-08	Firm.= V.03D13
383	signal generator	SME 03	842 828 /034	Firm.= 4.61
389	digital multimeter	Keithley 2000	0583926	Firm. = A13 (Mainboard) A02 (Display)
392	Radio Communication Tester	MT8820A	6K00000788	Firm.= 4.50 #005, IPL=4.01#001, OS=4.02#001,
420	System CTC CTIA-OTA	System CTC CTIA-OTA	-	EMQuest EMQ-100 Ver. 1.05
436	Radio Communication Tester	CMU 200	103083	R&S Test Firmware Base=5.01, Mess-Software=
441	System CTC-SAR-EMI	System EMI field (SAR)	-	EMC 32 Version 8.20,
442	System CTC-SAR-EMS	System EMS field (SAR)	-	EMS-K1 Immunity-Software 1.20SR10
443	System CTC-FAR-EMI-Spuri	System CTC-FAR-EMI-	-	Spuri 6.4a und Spuri 7.0
444	System CTC FAR-EMS	System EMS-Field (FAR)	-	EMS-K1 Immunity-Software 1.20SR10
460	Radio Communication Tester	CMU 200	108901	R&S Test Firmware Base=5.01/Messsoftware=
489	emi test receiver	ESU40	1000-30	Firmware=4.33, Bios=V5.1-16-3, Specification=01.00
491	ESD Simulator dito	ESD dito	dito307022	V 2.30
524	Voltage Drop Simulator	VDS 200	0196-16	Software Nr. 000037 Version V4.20a01
526	Burst Generator	EFT 200 A	0496-06	Software Nr. 000034 Version V2.32
527	Micro Pulse Generator	MPG 200 B	0496-05	Software-Nr. 000030 Version V2.43
528	Load Dump Simulator	LD 200B	0496-06	Software-Nr. 000031 Version V2.35a01
547	Universal Radiocommunikation Tester	CMU 200	835390/014	R&S Test Firmware =V5.03 (current Testsoftw. f. all
551	System CTC Conducted Voltage	System Conducted Voltage	-	EMC 32 Version 8.20

7.1.2. Single instruments and test systems

Ref.-No.	Equipment	Type	Serial-No.	Manufacturer
001	emi test receiver	ESS	825132/017	Rohde & Schwarz
005	AC - LISN (50 Ohm/50µH, test site 1)	ESH2-Z5	861741/005	Rohde & Schwarz
007	DC - LISN (50 Ohm/5µH)	ESH3-Z6	892563/002	Rohde & Schwarz
009	power meter (EMS-radiated)	NRV	863056/017	Rohde & Schwarz
012	signal generator (EMS-cond.)	SMY 01	839069/027	Rohde & Schwarz
013	power meter (EMS cond.)	NRVD	839111/003	Rohde & Schwarz
014	insertion unit (EMS cond.)	URV5-Z2	838519/029	Rohde & Schwarz
015	insertion unit (EMS cond.)	URV5-Z4	838570/024	Rohde & Schwarz
016	line impedance simulating network	Op. 24-D	B6366	Spitzenberger+Spies
017	Communication Tester	CMD 60 M	844365/014	Rohde & Schwarz
020	horn antenna 18 GHz (Subst 1)	3115	9107-3699	EMCO
021	loop antenna (H-Field)	6502	9206-2770	EMCO
022	audio measurement amplifier	2636C	1537643	Brüel & Kjaer
030	loop antenna (H-field)	HFH-Z2	879604/026	Rohde & Schwarz
031	absorbing clamp	MDS-21	863325/015	Rohde & Schwarz
033	RF-current probe (100kHz-30MHz)	ESH2-Z1	879581/18	Rohde & Schwarz
048	bicon. - log. antenna (SAR)	3143	1108	EMCO
049	current clamp (injection)	F-120-2	48	FCC
050	3-ph coupling-decoupling-netw. (Burst)	CDN 300	176	Schaffner
051	VHF-current probe 20-300 MHz	ESV-Z1	872421	Rohde & Schwarz
052	notch filter DECT	WRCB 1887,82/1889,55SS	12	Wainwright Industries
053	audio analyzer	UPA3	860612/022	Rohde & Schwarz
057	relay-switch-unit (EMS system)	RSU	494440/002	Rohde & Schwarz
058	capacitive clamp (Burst)	IP 4	99	Hafely
059	ferrite tube	FGZ 40 X 15 E	4225	Lüthi
060	power amplifier (DC-2kHz)	PAS 5000	B6363	Spitzenberger+Spies
061	ferrite tube	FGZ 40 X 15 E	4250	Lüthi
063	log.-per. antenna (Subst 1)	3146	860941/007	EMCO
065	attenuator, (6 dB) 50 Ohm, 250W	AT 50-6-250	521057	BNOS Electronics
066	notch filter (WCDMA; FDD1)	WRCT 1900/2200-5/40-	5	Wainwright GmbH
067	coupling decoupling-network	CDN801-M2/M3	272	Lüthi
068	coupling decoupling-network	CDN 801-M5	95226	Lüthi
069	EM - clamp	EM101	9535159	Lüthi
070	ferrite tube	FTC101	4199	Lüthi
071	biconical antenna (Subst 1)	HUF-Z2	863.029/010	Rohde & Schwarz
072	coupling decoupling-network	CDN801-M2/M3	276	Lüthi
083	AC - power supply, 0-10 A	EAC/MT 27010	910502096	EURO TEST
084	AC - power supply, 0-5 A	ELABO-8-34214	-	ELABO
085	AC - power supply, 0-10 A	R250	-	Schunterm.&Benningh.
086	DC - power supply, 0 -10 A	LNG 50-10	-	Heinzinger Electronic
087	DC - power supply, 0 -5 A	EA-3013 S	-	Elektro Automatik
090	Helmholtz coil: 2x10 coils in series	-	-	RWTÜV
091	USB-LWL-Converter	OLS-1	007/2006	Ing. Büro Scheiba
094	artificial head (No.1)	4905	1566990	Brüel & Kjaer
098	Wireless Protocol Tester	PTW70Wlan	100093	Rohde&Schwarz
099	passive voltage probe	ESH2-Z3	299.7810.52	Rohde & Schwarz
100	passive voltage probe	Probe TK 9416	without	Schwarzbeck
110	USB-LWL-Converter	OLS-1	-	Extreme USB
119	RT harmonics analyser/dig. flickermeter	B10	G60547	BOCONSULT
120	spectrum analyzer	FSEM 30	845538/011	Rohde & Schwarz
121	notch filter GSM 1900	WRCB 1879,5/1880,5EE	15	Wainwright GmbH
122	notch filter GSM 1800	WRCB 1747/1748	12	Wainwright GmbH
123	biconical antenna (Subst 2)	HUF-Z2,	860941/007	Rohde & Schwarz
131	RF-Current Probe	F-52	19	FCC
132	log.-per. antenna (Subst 2)	HUF-Z3	860862/014	Rohde & Schwarz
133	horn antenna 18 GHz (Meas 1)	3115	9012-3629	EMCO
134	horn antenna 18 GHz (Subst 2)	3115	9005-3414	EMCO
136	adjustable dipole antenna (Dipole 1)	3121C-DB4	9105-0697	EMCO
140	signal generator	SMHU	831314/006	Rohde & Schwarz
142	attenuator (6 dB) 2 W, 8 GHz	DGL N	-	Radiall
248	attenuator	SMA 6dB 2W	-	Radiall
249	attenuator	SMA 10dB 10W	-	Radiall
252	attenuator	N 6dB 12W	-	Radiall
254	high pass GSM1800/1900/DECT	5HC 2600/12750-1,5KK	23042	Trilithic
256	attenuator	SMA 3dB 2W	-	Radiall
257	hybrid	4031C	04491	Narda
260	hybrid coupler	4032C	11342	Narda
261	thermal power sensor	NRV-Z55	825083/0008	Rohde & Schwarz
262	power meter	NRV-S	825770/0010	Rohde & Schwarz
263	signal generator	SMP 04	826190/0007	Rohde & Schwarz
264	spectrum analyzer	FSEK 30	826939/005	Rohde & Schwarz
265	peak power sensor	NRV-Z33, Model 04	840414/009	Rohde & Schwarz
266	peak power sensor	NRV-Z31, Model 04	843383/016	Rohde & Schwarz
267	notch filter GSM 850	WRCA 800/960-6EEK	9	Wainwright GmbH
268	AC/DC power supply	EA 3050-A	9823636	-
270	termination	1418 N	BB6935	Weinschel
271	termination	1418 N	BE6384	Weinschel
272	attenuator (20 dB) 50 W	Model 47	BF6239	Weinschel
273	attenuator, (10 dB) 100 W	Model 48	BF9229	Weinschel

Ref.-No.	Equipment	Type	Serial-No.	Manufacturer
274	attenuator (10 dB) 50 W	Model 47 (10 dB) 50 W	BG0321	Weinschel
275	DC-Block	Model 7003 (N)	C5129	Weinschel
276	DC-Block	Model 7006 (SMA)	C7061	Weinschel
277	Vector-Networkanalyzer	ZVC	831363/0005	Rohde & Schwarz
279	power divider	1515 (SMA)	LH855	Weinschel
284	coupling decoupling network	CDN 801-M1	1661	Lüthi
285	coupling decoupling network	CDN 801-S1	1642	Lüthi
287	pre-amplifier 25MHz - 4GHz	AMF-2D-100M4G-35-10P	379418	Miteq
289	bicon. - log. antenna (OATS)	CBL 6141	4107	Schaffner Chase
290	notch filter GSM 900	WRCA 901.9/903,1SS	3RR	Wainwright GmbH
291	high pass filter GSM 850/900	WHJ 2200-4EE	14	Wainwright GmbH
295	Racal Digital Radio Test Set	6103	1572	Racal
298	Radio Communication Tester	CMU 200	832221/091	Rohde & Schwarz
299	audio microphone	134	-	Brüel & Kjaer
300	AC LISN (50 Ohm/50µH, 1-phase)	ESH3-Z5	892 239/020	Rohde & Schwarz
301	attenuator (20 dB) 50W, 18GHz	47-20-33	AW0272	Lucas Weinschel
302	horn antenna 40 GHz (Meas 1)	BBHA9170	155	Schwarzbeck
303	horn antenna 40 GHz (Subst 1)	BBHA9170	156	Schwarzbeck
304	fix dipole antenna 1,6 GHz	EMCO 3125-307	9907-1001	ETS
305	fix dipole antenna 1.8-2,0 GHz	EMCO 3125-306	9907-1001	ETS
306	fix dipole antenna 2,45 GHz	EMCO 3125-308	9907-1001	ETS
307	fix dipole antenna 3 GHz	EMCO 3125-309	9907-1001	ETS
312	Switch unit	TS-RSP	1000147	R&S
317	1000 Hz calibrator 94 dB SPL	4230 94dB	1542286	Brüel & Kjaer
323	Communication Tester	CMD 55	825878/0034	Rohde & Schwarz
331	climatic test chamber -40/+80 Grad	HC 4055	43146	Heraeus Vötsch
335	System-CTC-EMS-Conducted	Svstem EMS Conducted	-	Rohde & Schwarz
340	Communication Tester	CMD 55	849709/037	Rohde & Schwarz
341	digital multimeter	Fluke 112	81650455	Fluke
342	digital multimeter	Voltcraft M-4660A	IB 255466	Voltcraft
344	adaptor 150/50 Ohm	150/50	-	Krohne
345	adaptor 150/50 Ohm	150/50	-	Krohne
347	laboratory site	radio lab.	-	-
348	laboratory site	EMI conducted	-	-
349	car battery 12 V	car battery 12 V	without	-
350	car battery 12 V	car battery 12 V	without	-
354	DC - power supply 40A	NGPE 40/40	448	Rohde & Schwarz
355	power meter	URV 5	891310/027	Rohde & Schwarz
356	power sensor	NRV-Z1	882322/014	Rohde & Schwarz
357	power sensor	NRV-Z1	861761/002	Rohde & Schwarz
362	TOSM Calibration Kit 50 Ohm	ZV-Z21/ZV-Z11	without	Rohde&Schwarz
365	10V Insertion Unit 50 Ohm	URV5-Z2	100880	Rohde & Schwarz
366	Ultra Compact Simulator	UCS 500 M4	V0531100594	EM-Test
367	audio measurement amplifier	2636	316832/001	Brüel & Kjaer
369	insertion unit (SAR-EMS, Ch. A)	URV5-Z2	100301	Rohde & Schwarz
370	insertion unit (SAR-EMS, Ch. B)	URV5-Z2	100302	Rohde & Schwarz
371	Bluetooth Tester	CBT32	100153	R&S
373	V-Network 5µH/50 Ohm	ESH3-Z6	100535	Rohde & Schwarz
374	power amplifier 0,8-3 GHz	60S1G3	306528	Amplifier Research
375	directional coupler	DC7144M1	306498	Amplifier Research
376	horn antenna 6 GHz	BBHA9120 E	BBHA 9120 E 179	Schwarzbeck
377	emi test receiver	ESCS 30	100160	Rohde & Schwarz
378	broadband RF field monitor	RadiSense III	03D00013SNO-08	DARE B.V.
383	signal generator	SME 03	842 828 /034	Rohde & Schwarz
386	coupling decoupling network	CDN USB/p	19397	Schaffner
387	coupling decoupling network	CDN L-801 M2	2051	Lüthi
388	coupling decoupling network	CDN L-801 T2	1929	Lüthi
389	digital multimeter	Keithley 2000	0583926	Keithley
390	Industry Acoustic System	MO 2000 Set	2127100123	Sennheiser
392	Radio Communication Tester	MT8820A	6K00000788	Anritsu
394	power amplifier 80-1000 MHz	BLWA 0810-250/200	045610	Bonn-Elektronik
399	Sound Calibrator	Sound Calibrator 4231	2665101	Brüel & Kjaer
400	ferrite tube (>15 dB, EN 55022)	FTC 40 X 15 E	5559	Lüthi
401	ferrite tube (>15 dB, EN 55022)	FTC 40 X 15 E	5560	Lüthi
411	Test Cable Kit N 50 Ohm (male)	ZV-Z11	100200	R&S / Rosenberger
414	Circularly polarized com. Antenna	3102	00033734	EMCO
415	Antenna Position Controller	2090	00035634	ETS-Lindgren
416	MAPS Positioner (light duty)	2010	-	ETS-Lindgren
429	MAPS-Positionier (medium duty)	2015	-	ETS-Lindgren
430	Thermo-Hygrometer	H270	54476	Dostmann electronic
431	Model 7405	Near-Field Probe Set	9305-2457	EMCO
432	pre-amplifier 100MHz-26GHz	JS4-00102600-38-5P	1030896	Miteq USA
436	Radio Communication Tester	CMU 200	103083	Rohde & Schwarz
439	UltraLog-Antenna	HL 562	100248	Rohde + Schwarz
440	CDN for Datacable	CDN-UTP	CDN-UTP 029	EMC Partner AG,
441	System CTC-SAR-EMI	System EMI field (SAR)	-	ETS
443	System CTC-FAR-EMI-Spuri	System CTC-FAR-EMI-	-	ETS-Lindgren/Cetecom
454	Oscilloscope	HM 205-3	9210 P 29661	Hameg
455	Oscilloscope	HP 54602B	US 350 336 45	Hawlett Packard
456	DC-Power supply 0-5A	EA 3013 S	207810	Elektro Automatik
457	DC-Power supply, 0-5A	EA-3013 S	9624680	Elektro Automatik
459	DC -power supply 0-5 A , 0-32 V	EA-PS 2032-50	910722	Elektro Automatik
460	Radio Communication Tester	CMU 200	108901	Rohde & Schwarz
462	AF-Generator	MX-2020	-	Conrad
463	Universal source	HP3245A	2831A03472	Agilent

Ref.-No.	Equipment	Type	Serial-No.	Manufacturer
464	Thermo-Hygro-Monitor	WS-9400	without	Europe Supplies Ltd.
465	Thermo-Hygro-Monitor	WS-9400	without	Europe Supplies Ltd.
466	digital multimeter	Fluke 112	89210157	Fluke USA
467	digital multimeter	Fluke 112	89680306	Fluke USA
468	digital multimeter	Fluke 112	90090455	Fluke USA
470	Thermo-Hygro-Monitor	WS-9400	-	distr. by Conrad
477	ReRadiating GPS-System	AS-47	-	Automotive Cons. Fink
482	filtermatrix	FilterMatrix SAR 1	-	CETECOM (Brl)
484	pre-amplifier 2,5 - 18 GHz	AMP-5D-02501800-25-	1244554	Miteq
487	NSA-Verification of CTC-SAR-EMI	System EMI field (SAR)	-	ETS
489	emi test receiver	ESU40	1000-30	Rohde & Schwarz
490	high pass 2.65 GHz>18GHz	6HC 2650/18000-3-KK	200709138	Trilithic
491	ESD Simulator dito	ESD dito	dito307022	EM-Test
494	power supply (GPIB)	Agilent 66332A	US 37474017	Agilent
498	Power Supply	NGPE 40/40	402	Rohde & Schwarz
500	industry Acoustic System	MO 2000 Set	100048	Sennheiser
502	band reject filter	WRCG 1709/1786-	SN 9	Wainwright
503	band reject filter	WRCG 824/849-814/859-	SN 5	Wainwright
517	relais switc matrix	HF Relais Box Keithley	SE 04	-
522	electronical load	EL 9000	-	ELV
523	Digitalmultimeter	L4411A	MY46000154	Agilent
524	Voltage Drop Simulator	VDS 200	0196-16	EM Test
525	Koppelnetzwerk	CNA 200	1196-01	EM Test
526	Burst Generator	EFT 200 A	0496-06	EM Test
527	Micro Pulse Generator	MPG 200 B	0496-05	EM Test
528	Load Dump Simulator	LD 200B	0496-06	EM Test
529	6 dB Broadband resistive power divider	Model 1515	LH 855	Weinschel
530	10 dB Broadband resistive power divider	R 416110000	LOT 9828	-
531	H-field system	Lackman System	without	Lackmann
541	Impedance Stabilization Network	ISN T8-Cat6	26373	Teseq Berlin
547	Universal Radiocommunikation Tester	CMU 200	835390/014	Rohde & Schwarz
548	Digital-Barometer	GBP 2300	without	Greisinger GmbH
551	System CTC Conducted Voltage	Svstem Conducted Voltage	-	-