

**BT LE 2 Mbit/s**

Channel No.	Channel Center Frequency [MHz]	Band Edge Freq. [MHz]	Spurious Level [dBm]	Detector	RBW [kHz]	Ref. Level [dBm]	Limit [dBm]	Margin to Limit [dB]
0	2402	2400.0	-22.1	PEAK	100	7.6	-12.4	9.7
39	2480	2483.5	-50.0	PEAK	100	7.7	-12.3	37.7

Remark: Please see next sub-clause for the measurement plot.

**5.7.4 MEASUREMENT PLOT (EXAMPLE PLOT, SHOWING WORST CASE, IF APPLICABLE)**

Radio Technology = Bluetooth BDR, Operating Frequency = low, Band Edge = low (S01\_354\_AA01)

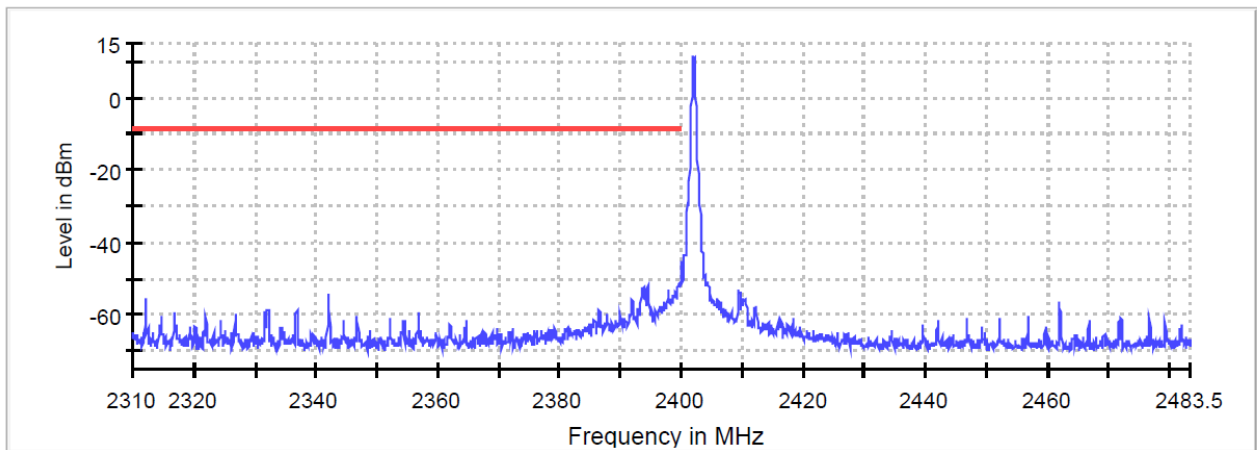

— Limit      — Sum Level      × Fail

Radio Technology = Bluetooth BDR, Operating Frequency = high, Band Edge = high (S01\_354\_AA01)

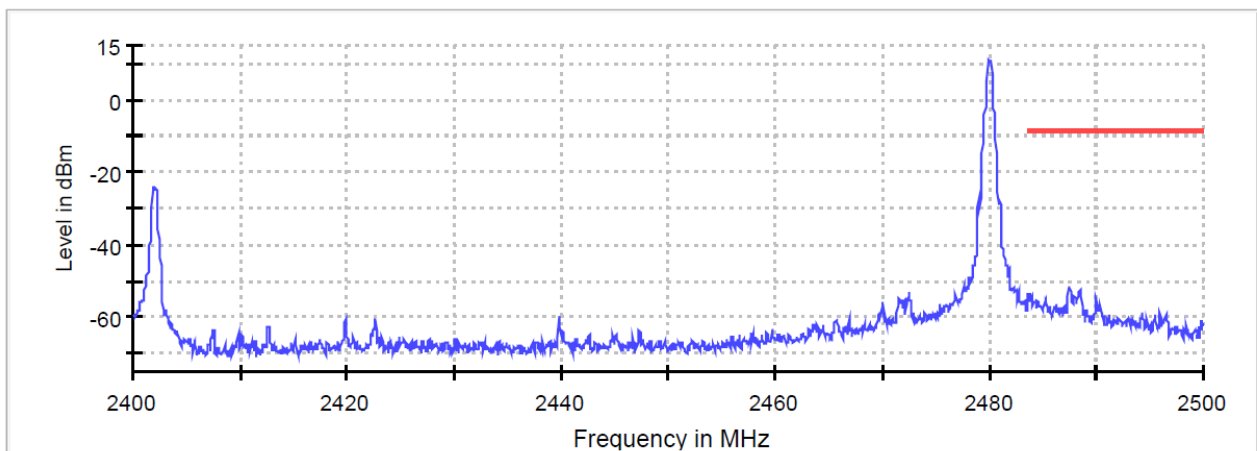

— Limit      — Sum Level      × Fail

Radio Technology = Bluetooth BDR, Operating Frequency = hopping, Band Edge = low  
(S01\_354\_AA01)

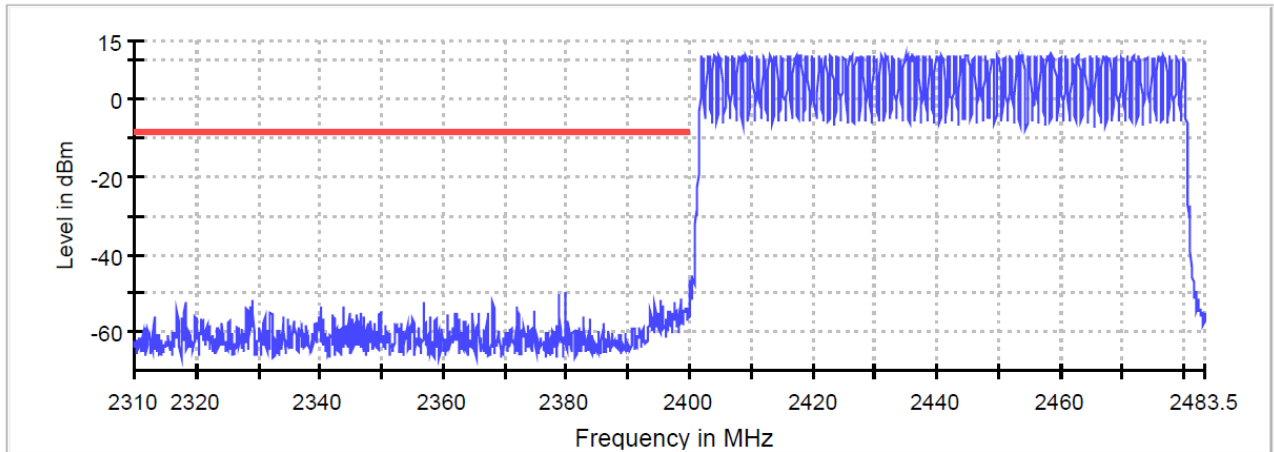

Radio Technology = Bluetooth BDR, Operating Frequency = hopping, Band Edge = high  
(S01\_354\_AA01)

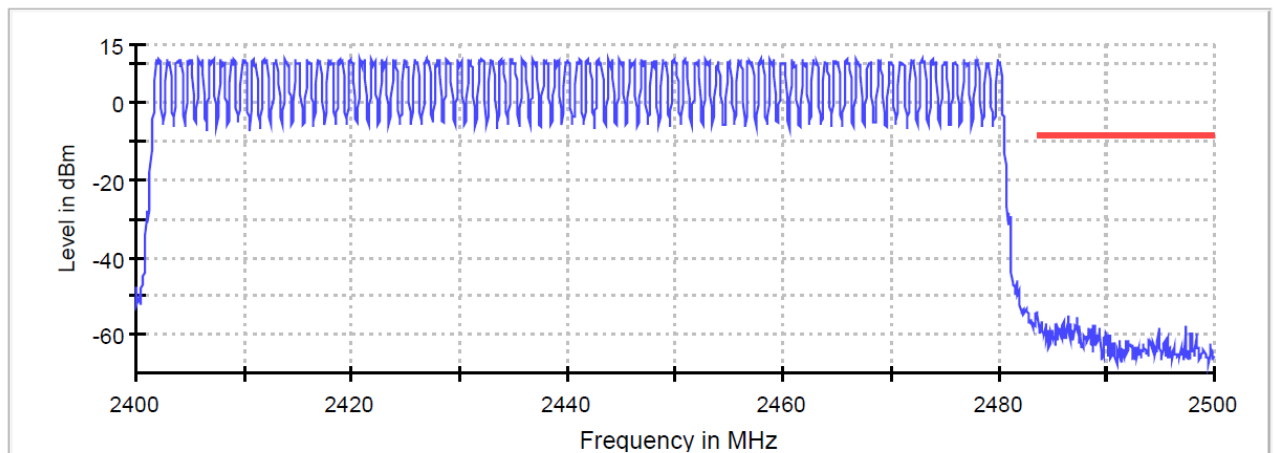

Radio Technology = Bluetooth EDR 2, Operating Frequency = low, Band Edge = low  
(S01\_354\_AA01)

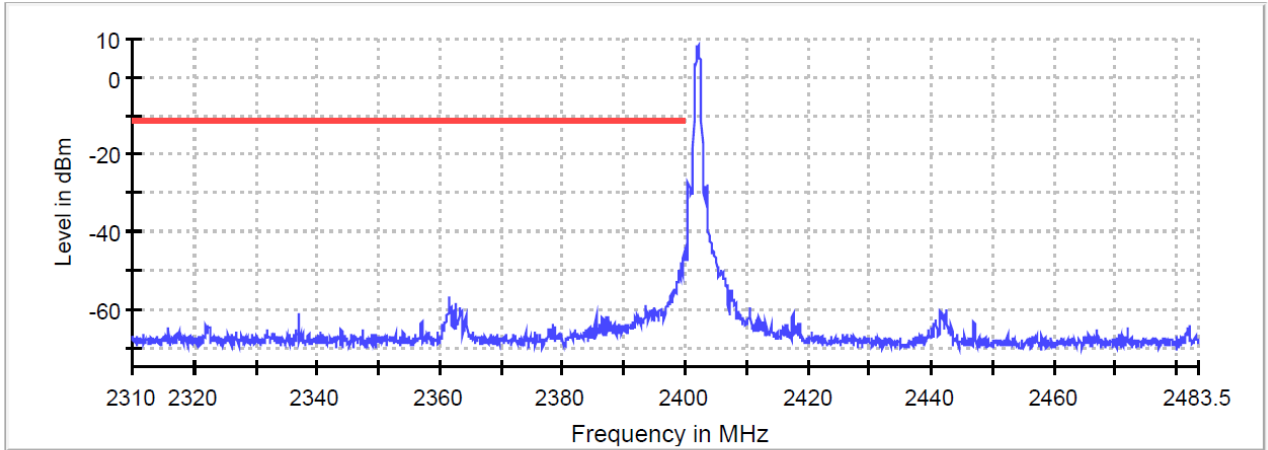

— Limit    — Sum Level    × Fail

Radio Technology = Bluetooth EDR 2, Operating Frequency = high, Band Edge = high  
(S01\_354\_AA01)

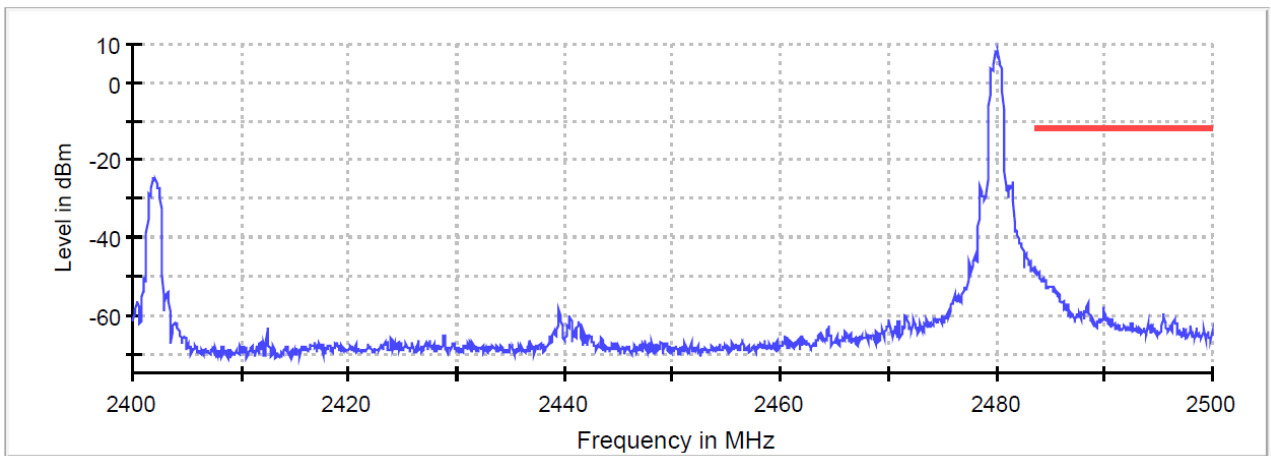

— Limit    — Sum Level    × Fail

Radio Technology = Bluetooth EDR 2, Operating Frequency = hopping, Band Edge = low (S01\_354\_AA01)

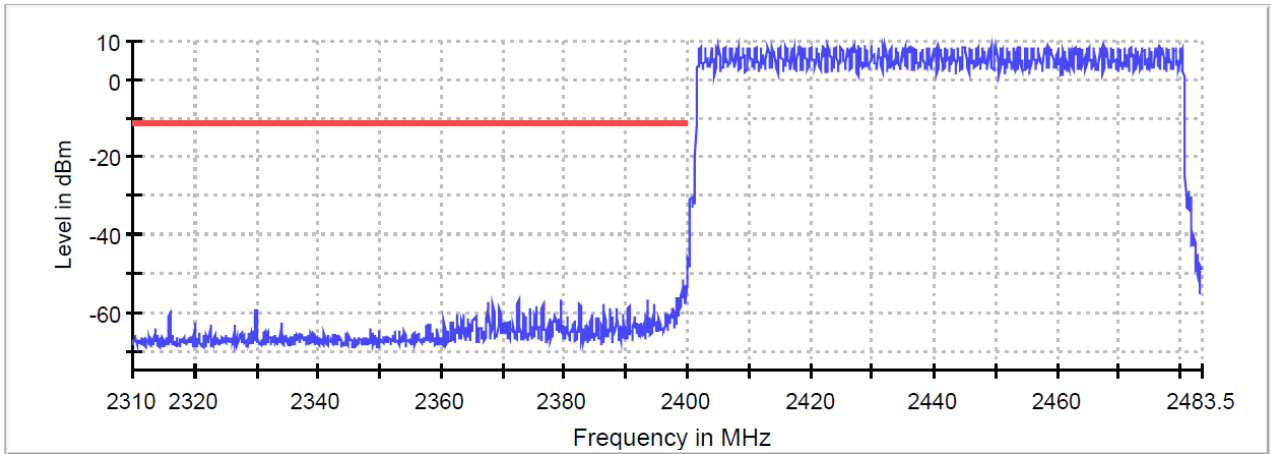

— Limit    — Sum Level    × Fail

Radio Technology = Bluetooth EDR 2, Operating Frequency = hopping, Band Edge = high (S01\_354\_AA01)

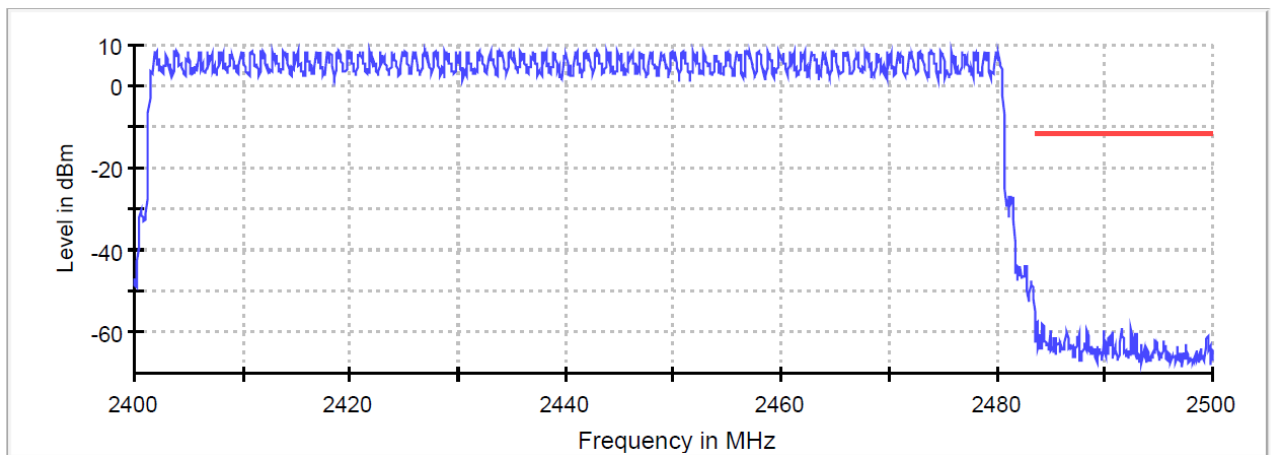

— Limit    — Sum Level    × Fail

Radio Technology = Bluetooth EDR 3, Operating Frequency = low, Band Edge = low  
(S01\_354\_AA01)

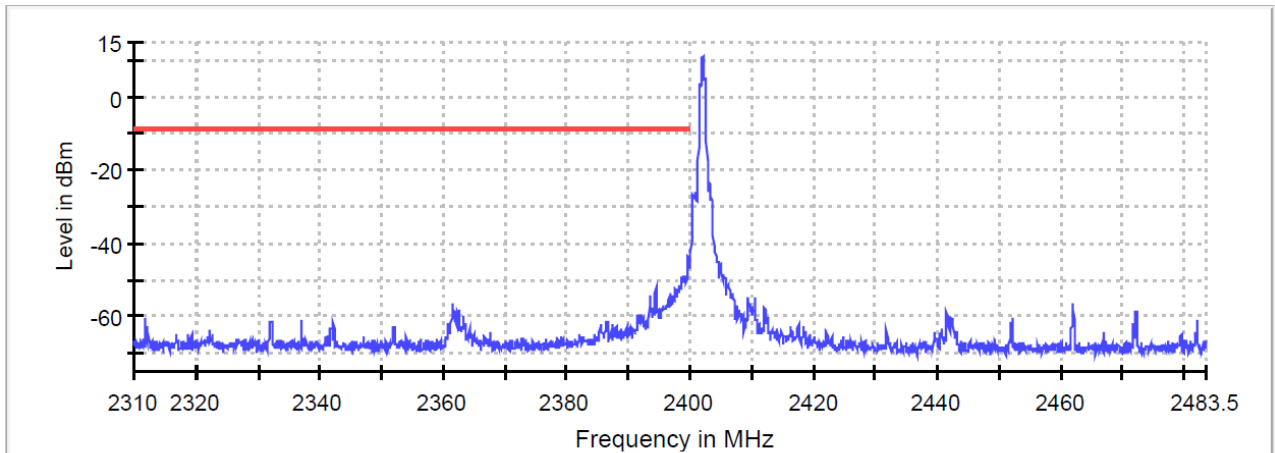

— Limit    — Sum Level    × Fail

Radio Technology = Bluetooth EDR 3, Operating Frequency = high, Band Edge = high  
(S01\_354\_AA01)

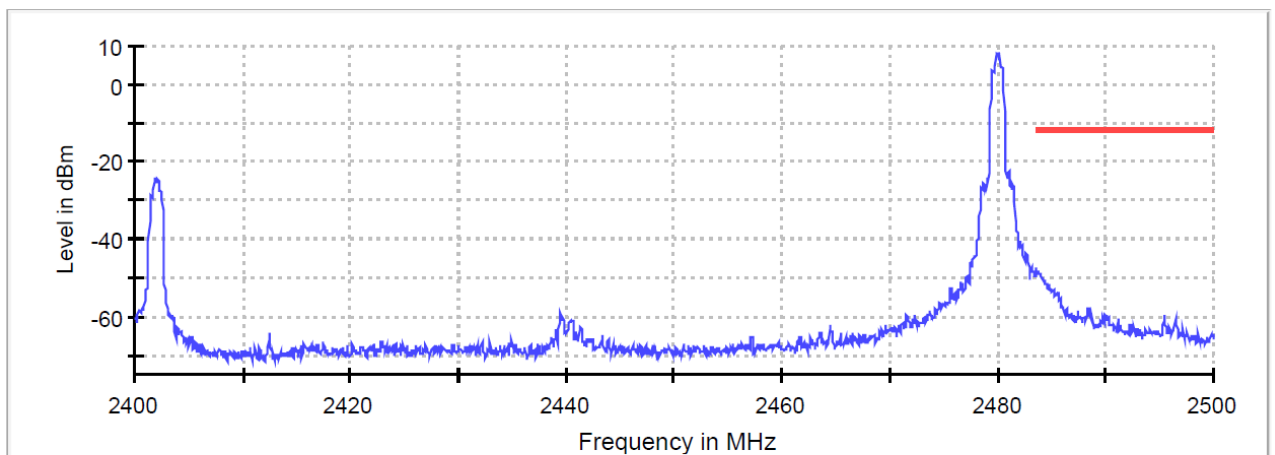

— Limit    — Sum Level    × Fail

Radio Technology = Bluetooth EDR 3, Operating Frequency = hopping, Band Edge = low (S01\_354\_AA01)

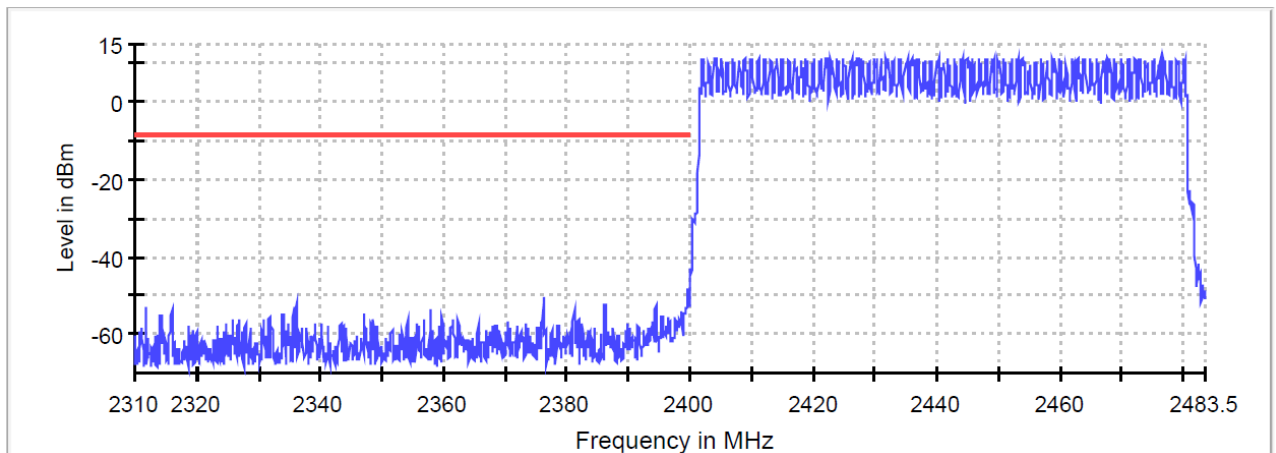

Radio Technology = Bluetooth EDR 3, Operating Frequency = hopping, Band Edge = high (S01\_354\_AA01)

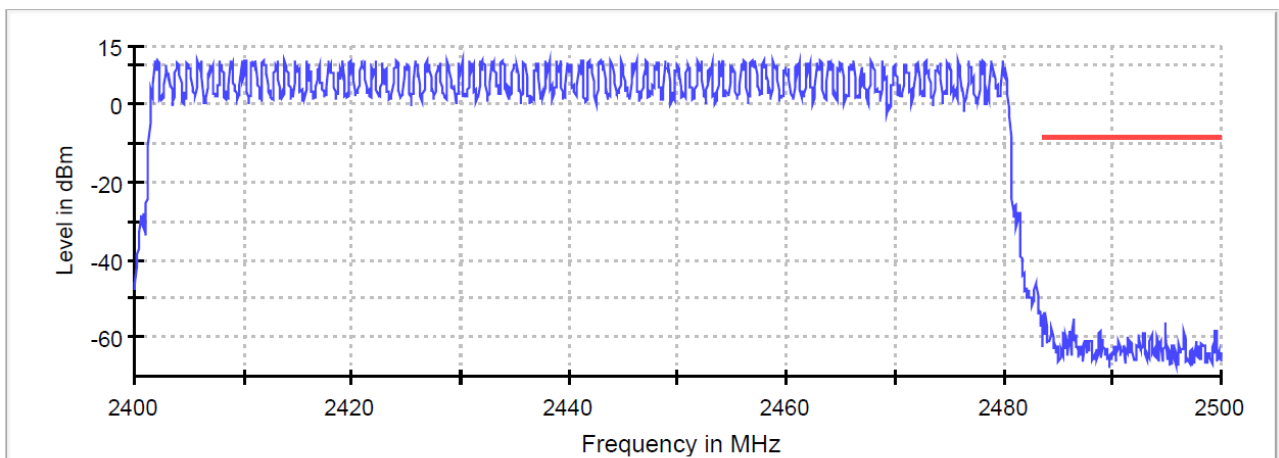

Radio Technology = Bluetooth LE 1 Mbps, Operating Frequency = low, Band Edge = low  
(S01\_354\_AA01)

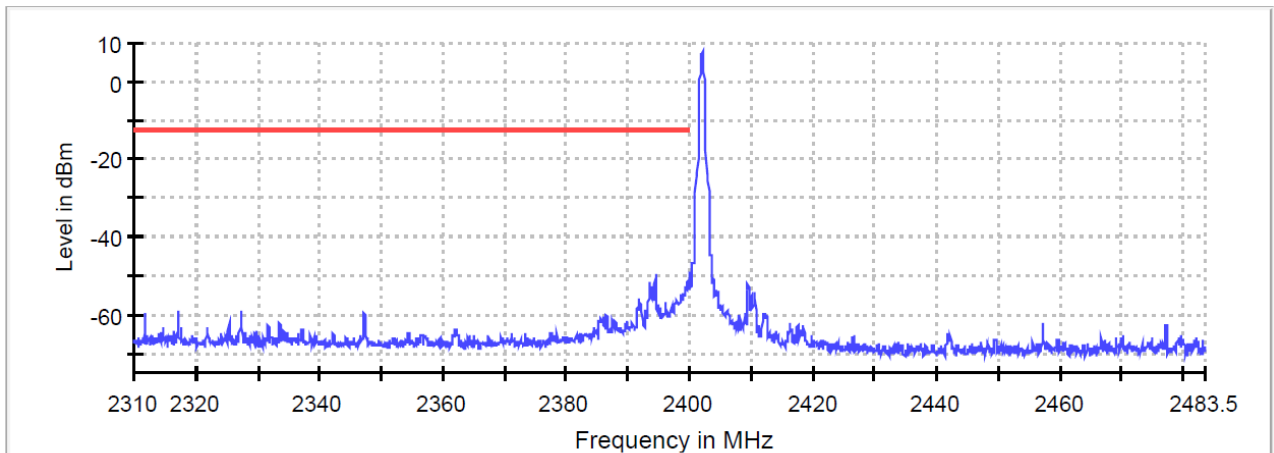

— Limit    — Sum Level    × Fail

Radio Technology = Bluetooth LE 1 Mbps, Operating Frequency = high, Band Edge = high  
(S01\_354\_AA01)

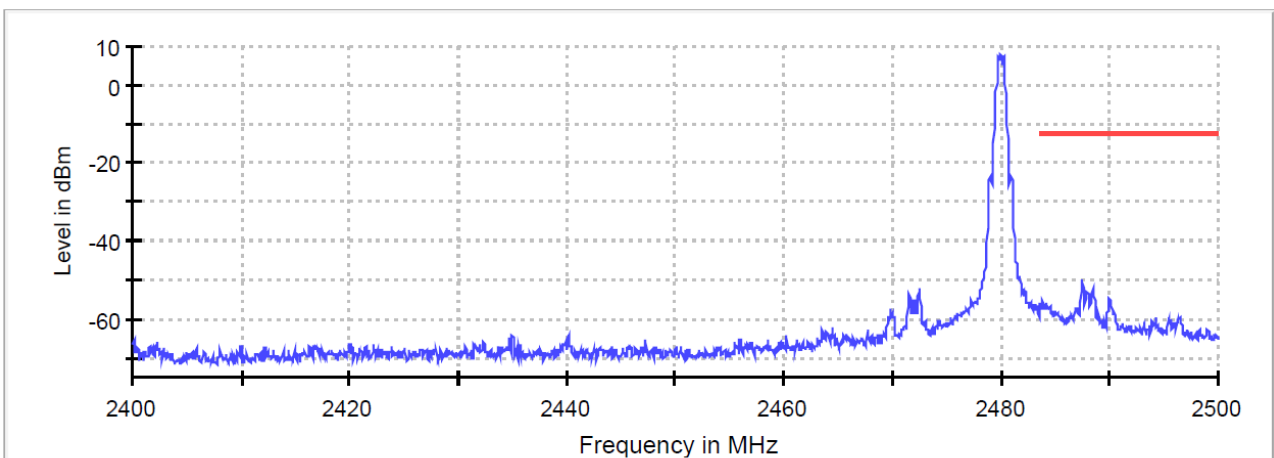

— Limit    — Sum Level    × Fail

Radio Technology = Bluetooth LE 2 Mbps, Operating Frequency = low, Band Edge = low (S01\_354\_AA01)

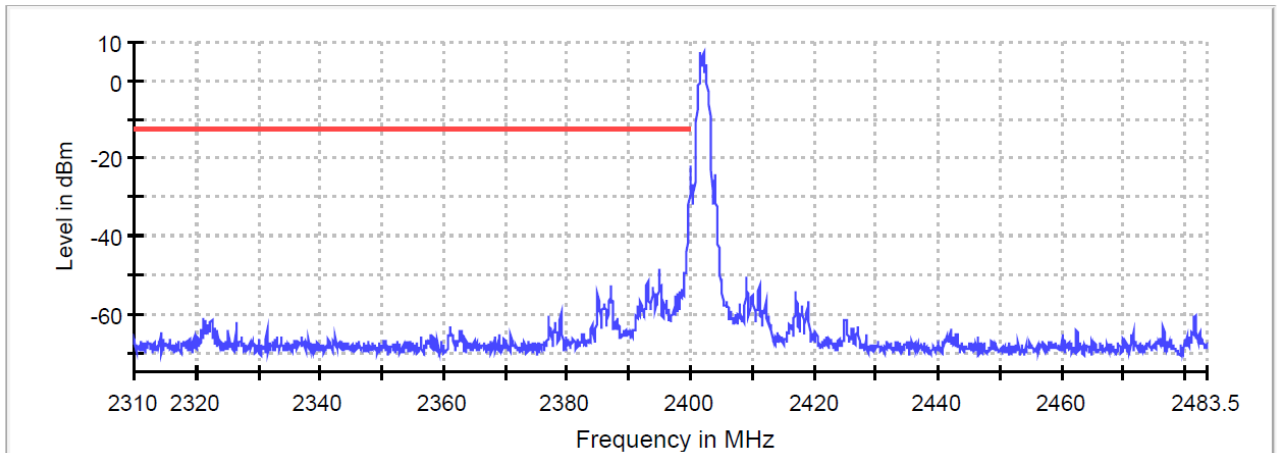

— Limit    — Sum Level    × Fail

Radio Technology = Bluetooth LE 2 Mbps, Operating Frequency = high, Band Edge = high (S01\_354\_AA01)

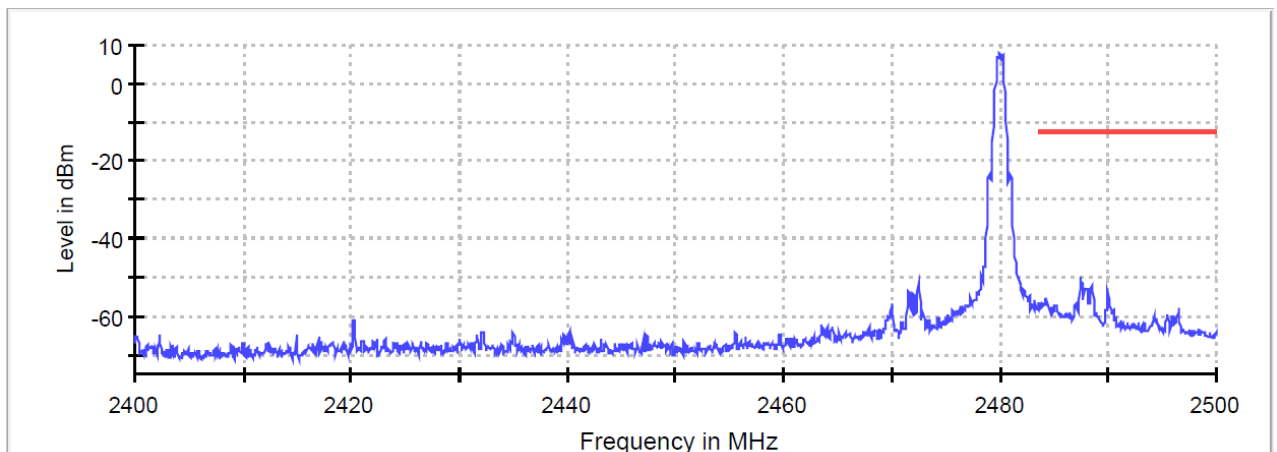

— Limit    — Sum Level    × Fail

### 5.7.5 TEST EQUIPMENT USED

- R&S TS8997



## 5.8 BAND EDGE COMPLIANCE RADIATED

Standard **FCC Part 15 Subpart C**

**The test was performed according to:**  
ANSI C63.10

### 5.8.1 TEST DESCRIPTION

#### Radiated Measurement with 50 Ohm termination at antenna ports

The test set-up was made in accordance to the general provisions of ANSI C63.10 in a typical installation configuration. The measurements were performed according the following sub-chapter of ANSI C63.10:

- Chapter 6.10.5

The Equipment Under Test (EUT) was set up on a non-conductive support (tilt device) at 1.5 m height in the fully-anechoic chamber.

All steps were performed with one height (1.5 m) of the receiving antenna only (procedure according ANSI C63.10, chapter 6.6.5).

#### 3. Measurement above 1 GHz

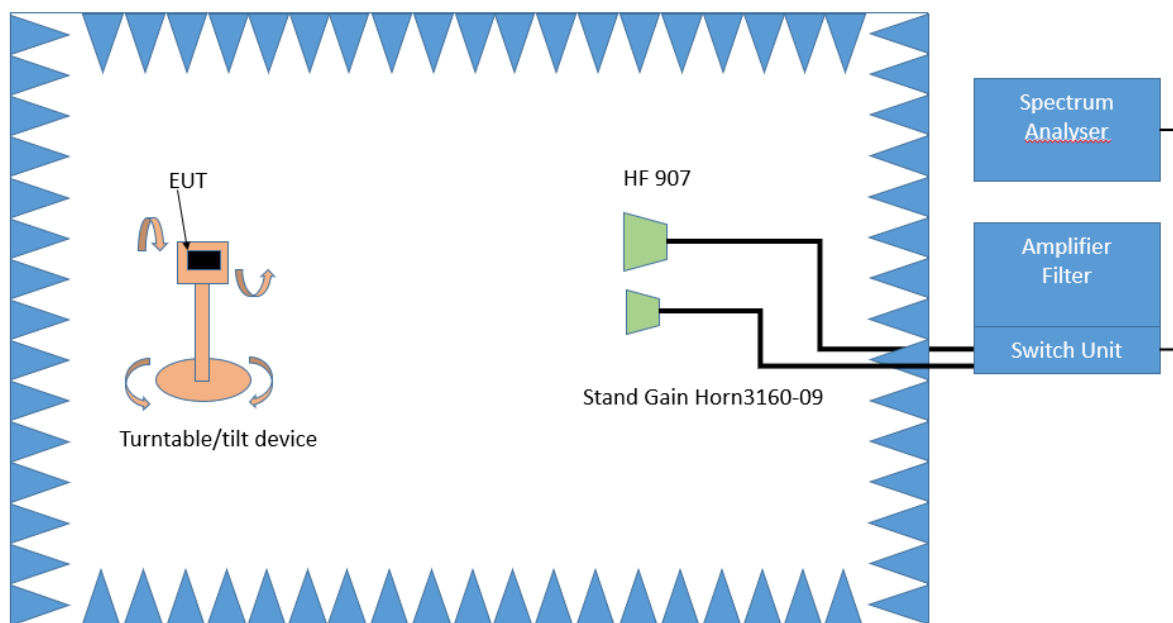

Test Setup; Spurious Emission Radiated (FAC), 1 GHz-26.5 GHz

#### Step 1:

The EUT is turned during the preliminary measurement across the elevation axis, with a step size of 90 °.

The turn table step size (azimuth angle) for the preliminary measurement is 45 °.

Spectrum analyser settings:

- Detector: Peak, Average
- RBW = 1 MHz
- VBW = 3 MHz

#### Step 2:

The turn table azimuth will slowly vary by  $\pm 22.5^\circ$ .  
 The elevation angle will slowly vary by  $\pm 45^\circ$   
 Spectrum analyser settings:  
 - Detector: Peak

**Step 3:**

Spectrum analyser settings for step 3:  
 - Detector: Peak / CISPR Average  
 - Measured frequencies: in step 1 determined frequencies  
 - RBW = 1 MHz  
 - VBW = 3 MHz  
 - Measuring time: 1 s

**Conducted Measurements at antenna ports**

The Equipment Under Test (EUT) was set up to perform the spurious emissions measurements.

The EUT was connected to the test system as described in the block diagram below. The complete attenuation of the measurement path is known and considered.

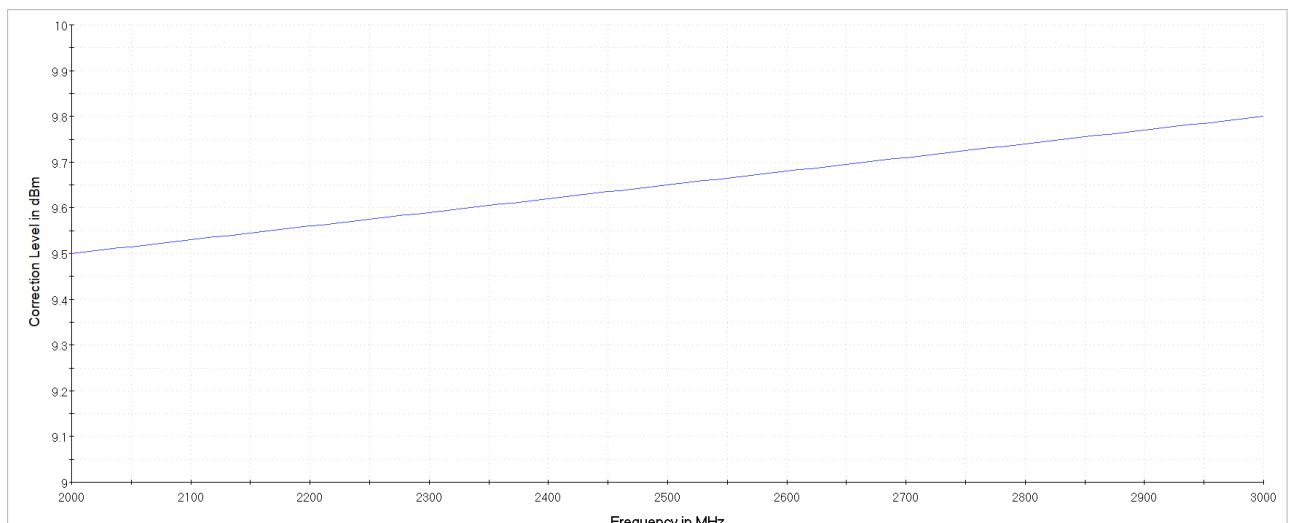
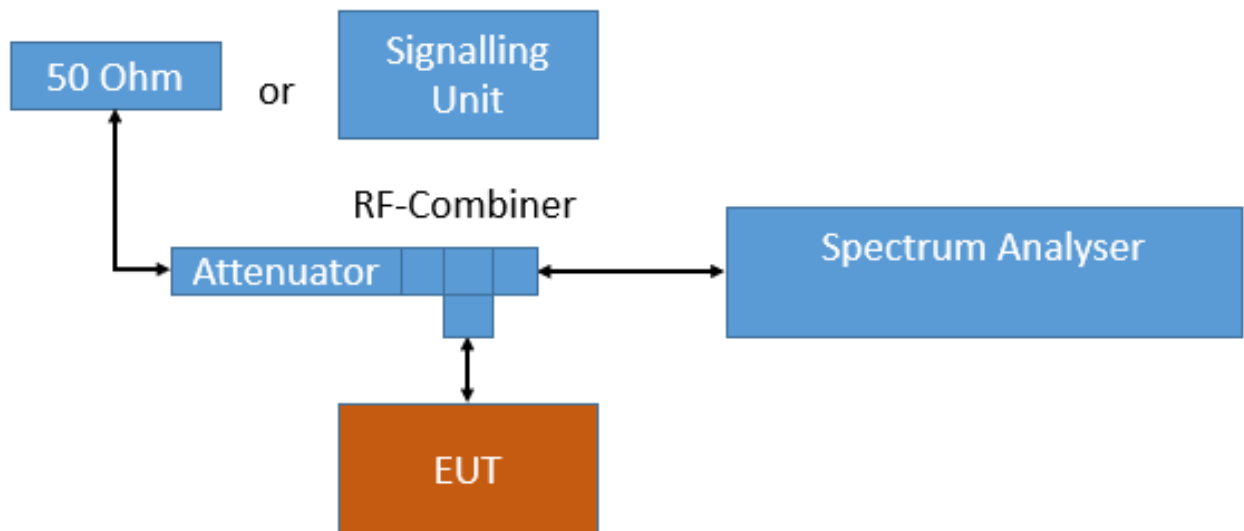

#### Analyser settings:

- Frequency range: 2350 – 2500 MHz
- Resolution Bandwidth (RBW): 1000 kHz
- Video Bandwidth (VBW): 3000 kHz
- Trace: Maxhold, Average Power
- Sweeps: 10000
- Sweep Time: coupled
- Detector: Peak, RMS

For the conducted emissions in restricted bands the Value is measured in dBm and then converted to dB $\mu$ V/m as given in KDB 558074:

1. Measure the conducted output power in dBm.
2. Add the maximum antenna gain in dBi. (Included in measurement result by offset)
3. Add the appropriate ground reflection factor (0 for measured range)
  - 6 dB for frequencies  $\leq$  30 MHz;
  - 4.7 dB for frequencies between 30 MHz and 1000 MHz, inclusive; and
  - 0 dB for frequencies  $>$  1000 MHz).
4. Convert the resultant EIRP level to an equivalent electric field strength level using the following relationship:
 
$$E = \text{EIRP} - 20 \log D + 104.8$$
 Where E is the electric field strength in dB $\mu$ V/m,  
 EIRP is the equivalent isotropically radiated power in dBm  
 D is the specified measurement distance in m

Value [dB $\mu$ V/m] = Measured value [dBm] (including gain and ground reflection factor) – 20 log D + 104.8

### 5.8.2 TEST REQUIREMENTS / LIMITS

For band edges connected to a restricted band, the limits are specified in Section 15.209(a)

FCC Part 15, Subpart C, §15.209, Radiated Emission Limits

Frequency in MHz	Limit ( $\mu$ V/m)	Measurement distance (m)	Limits (dB $\mu$ V/m)
0.009 – 0.49	2400/F(kHz)@300m	3	(48.5 – 13.8)@300m
0.49 – 1.705	24000/F(kHz)@30m	3	(33.8 – 23.0)@30m
1.705 – 30	30@30m	3	29.5@30m

The measured values are corrected with an inverse linear distance extrapolation factor (40 dB/decade) according FCC 15.31 (2).

Frequency in MHz	Limit ( $\mu$ V/m)	Measurement distance (m)	Limits (dB $\mu$ V/m)
30 – 88	100@3m	3	40.0@3m
88 – 216	150@3m	3	43.5@3m
216 – 960	200@3m	3	46.0@3m
960 – 26000	500@3m	3	54.0@3m
26000 – 40000	500@3m	1	54.0@3m

The measured values above 26 GHz are corrected with an inverse linear distance extrapolation factor (20 dB/decade).

§15.35(b) ..., there is also a limit on the radio frequency emissions, as measured using instrumentation with a peak detector function, corresponding to 20 dB above the maximum permitted average limit....

Used conversion factor:  $\text{Limit (dB}\mu\text{V/m)} = 20 \log (\text{Limit } (\mu\text{V/m})/1\mu\text{V/m})$

### 5.8.3 TEST PROTOCOL

Ambient temperature: 24 -30 °C  
 Air Pressure: 990 - 1020 hPa  
 Humidity: 30 -40 %

BT GFSK (1-DH5)

Applied duty cycle correction (AV): 2.3 dB

Variant / Test Method	Ch. Center Freq. [MHz]	Band Edge Freq. [MHz]	Spurious Level [dBμV/m]	Detector	RBW [kHz]	Limit [dBμV/m]	Margin to Limit [dB]
354 / Radiated	2480	2483.5	51.3	PEAK	1000	74	22.7
354 / Radiated	2480	2483.5	37.5	AV	1000	54	16.5
354 / Conducted	2402	2390	46.1	PEAK	1000	74	27.9
354 / Conducted	2402	2390	37.6	AV	1000	54	16.4
354 / Conducted	2480	2483.5	51.8	PEAK	1000	74	22.2
354 / Conducted	2480	2483.5	41.0	AV	1000	54	13.0

BT π/4 DQPSK (2-DH5)

Applied duty cycle correction (AV): 2.3 dB

Variant / Test Method	Ch. Center Freq. [MHz]	Band Edge Freq. [MHz]	Spurious Level [dBμV/m]	Detector	RBW [kHz]	Limit [dBμV/m]	Margin to Limit [dB]
354 / Conducted	2402	2390	49.9	PEAK	1000	74	24.1
354 / Conducted	2402	2390	37.0	AV	1000	54	17.0
354 / Conducted	2480	2483.5	68.3	PEAK	1000	74	5.7
354 / Conducted	2480	2483.5	42.6	AV	1000	54	11.4

BT 8-DPSK (3-DH5)

Applied duty cycle correction (AV): 2.3 dB

Variant / Test Method	Ch. Center Freq. [MHz]	Band Edge Freq. [MHz]	Spurious Level [dBμV/m]	Detector	RBW [kHz]	Limit [dBμV/m]	Margin to Limit [dB]
354 / Conducted	2402	2390	48.0	PEAK	1000	74	26.0
354 / Conducted	2402	2390	37.0	AV	1000	54	17.0
354 / Conducted	2480	2483.5	68.2	PEAK	1000	74	5.8
354 / Conducted	2480	2483.5	43.1	AV	1000	54	10.9

BT LE 1 Mbit/s

Applied duty cycle correction (AV): 4.2 dB

Variant / Test Method	Ch. Center Freq. [MHz]	Band Edge Freq. [MHz]	Spurious Level [dBμV/m]	Detector	RBW [kHz]	Limit [dBμV/m]	Margin to Limit [dB]
354 / Radiated	2480	2483.5	48.3	PEAK	1000	74	25.7
354 / Radiated	2480	2483.5	39.4	AV	1000	54	14.6
354 / Conducted	2402	2390	46.7	PEAK	1000	74	27.3
354 / Conducted	2402	2390	39.5	AV	1000	54	14.5
354 / Conducted	2480	2483.5	53.0	PEAK	1000	74	21.0
354 / Conducted	2480	2483.5	40.5	AV	1000	54	13.5

BT LE 2 Mbit/s

Applied duty cycle correction (AV): 9.7 dB

Variant / Test Method	Ch. Center Freq. [MHz]	Band Edge Freq. [MHz]	Spurious Level [dBμV/m]	Detector	RBW [kHz]	Limit [dBμV/m]	Margin to Limit [dB]
354 / Conducted	2402	2390	46.4	PEAK	1000	74	27.6
354 / Conducted	2402	2390	44.5	AV	1000	54	9.5
354 / Conducted	2480	2483.5	52.6	PEAK	1000	74	21.4
354 / Conducted	2480	2483.5	46.1	AV	1000	54	7.9

WLAN b-Mode; 20 MHz; 1 Mbit/s

Applied duty cycle correction (AV): 0 dB

Variant / Test Method	Ch. Center Freq. [MHz]	Band Edge Freq. [MHz]	Spurious Level [dBμV/m]	Detector	RBW [kHz]	Limit [dBμV/m]	Margin to Limit [dB]
354 / Radiated	2480	2483.5	48.2	PEAK	1000	74	25.8
354 / Radiated	2480	2483.5	34.8	AV	1000	54	19.2
354 / Conducted	2412	2390	57.2	PEAK	1000	74	16.8
354 / Conducted	2412	2390	50.7	AV	1000	54	3.3
354 / Conducted	2417	2390	57.6	PEAK	1000	74	16.4
354 / Conducted	2417	2390	51.1	AV	1000	54	2.9
354 / Conducted	2457	2483.5	58.1	PEAK	1000	74	15.9
354 / Conducted	2457	2483.5	52.4	AV	1000	54	1.6
354 / Conducted	2462	2483.5	55.1	PEAK	1000	74	18.9
354 / Conducted	2462	2483.5	48.9	AV	1000	54	5.1

WLAN g-Mode; 20 MHz; 6 Mbit/s  
Applied duty cycle correction (AV): 0 dB

Variant / Test Method	Ch. Center Freq. [MHz]	Band Edge Freq. [MHz]	Spurious Level [dB $\mu$ V/m]	Detector	RBW [kHz]	Limit [dB $\mu$ V/m]	Margin to Limit [dB]
354 / Radiated	2480	2483.5	47.7	PEAK	1000	74	26.3
354 / Radiated	2480	2483.5	34.7	AV	1000	54	19.3
354 / Conducted	2462	2483.5	68.0	PEAK	1000	74	6.0
354 / Conducted	2462	2483.5	46.8	AV	1000	54	7.2

WLAN n-Mode; 20 MHz; MCS0  
Applied duty cycle correction (AV): 0 dB

Variant / Test Method	Ch. Center Freq. [MHz]	Band Edge Freq. [MHz]	Spurious Level [dB $\mu$ V/m]	Detector	RBW [kHz]	Limit [dB $\mu$ V/m]	Margin to Limit [dB]
354 / Radiated	2480	2483.5	47.5	PEAK	1000	74	26.5
354 / Radiated	2480	2483.5	34.7	AV	1000	54	19.3
354 / Conducted	2462	2483.5	63.5	PEAK	1000	74	10.5
354 / Conducted	2462	2483.5	47.1	AV	1000	54	6.9

WLAN n-Mode; 40 MHz; MCS0  
Applied duty cycle correction (AV): 0 dB

Variant / Test Method	Ch. Center Freq. [MHz]	Band Edge Freq. [MHz]	Spurious Level [dB $\mu$ V/m]	Detector	RBW [kHz]	Limit [dB $\mu$ V/m]	Margin to Limit [dB]
354 / Radiated	2480	2483.5	48.1	PEAK	1000	74	25.9
354 / Radiated	2480	2483.5	34.7	AV	1000	54	19.3
354 / Conducted	2462	2483.5	59.3	PEAK	1000	74	14.7
354 / Conducted	2462	2483.5	47.8	AV	1000	54	6.2

WLAN ax-Mode; 20 MHz; MCS0  
Applied duty cycle correction (AV): 0.1 dB

Variant / Test Method	Ch. Center Freq. [MHz]	Band Edge Freq. [MHz]	Spurious Level [dB $\mu$ V/m]	Detector	RBW [kHz]	Limit [dB $\mu$ V/m]	Margin to Limit [dB]
354 / Conducted	2462	2483.5	64.9	PEAK	1000	74	9.1
354 / Conducted	2462	2483.5	46.6	AV	1000	54	7.4

WLAN ax-Mode; 40 MHz; MCS0  
 Applied duty cycle correction (AV): 0.1 dB

Variant / Test Method	Ch. Center Freq. [MHz]	Band Edge Freq. [MHz]	Spurious Level [dB $\mu$ V/m]	Detector	RBW [kHz]	Limit [dB $\mu$ V/m]	Margin to Limit [dB]
354 / Conducted	2462	2483.5	65.4	PEAK	1000	74	8.6
354 / Conducted	2462	2483.5	48.4	AV	1000	54	5.6

Remark: Please see next sub-clause for the measurement plot.

### 5.8.4 MEASUREMENT PLOTS

Radio Technology = Bluetooth BDR, Operating Frequency = high, Band Edge = high  
 (S02\_354\_AB01)

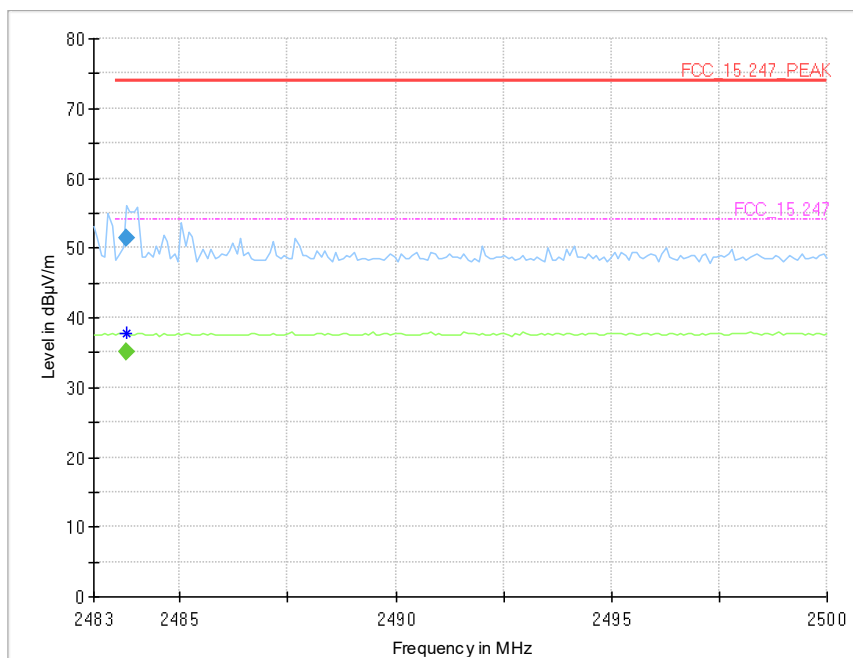

Frequency (MHz)	MaxPeak (dB $\mu$ V/m)	CAverage (dB $\mu$ V/m)	Limit (dB $\mu$ V/m)	Margin (dB)	Meas. Time (ms)	Bandwidth (kHz)	Height (cm)	Pol	Azimuth (deg)	Elevation (deg)	Corr. (dB/m)
2483.765	---	35.2	54.00	18.82	1000.0	1000.000	150.0	V	-63.0	-15.0	5.3
2483.765	51.3	---	74.00	22.66	1000.0	1000.000	150.0	V	-63.0	-15.0	5.3

Radio Technology = Bluetooth BDR, Operating Frequency = high, Band Edge = high  
(S01\_354\_AA01)

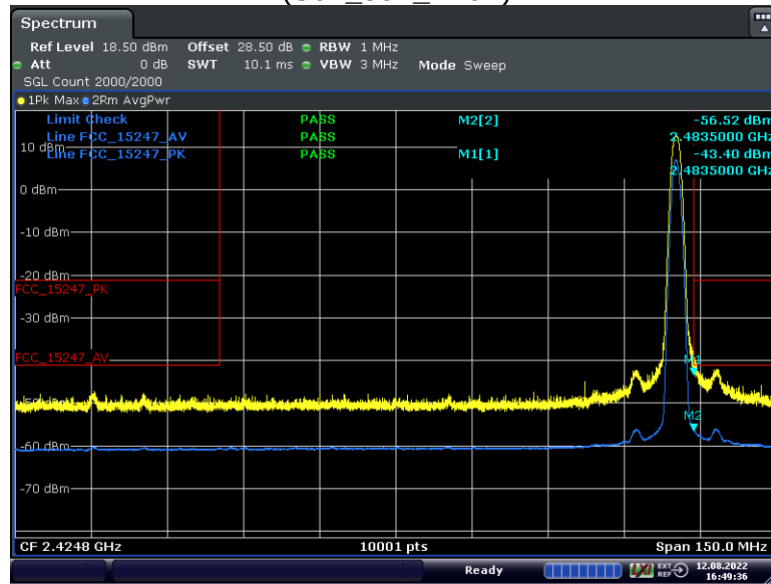

Date: 12.AUG.2022 16:49:36

Radio Technology = Bluetooth EDR 2, Operating Frequency = high, Band Edge = high  
(S01\_354\_AA01)

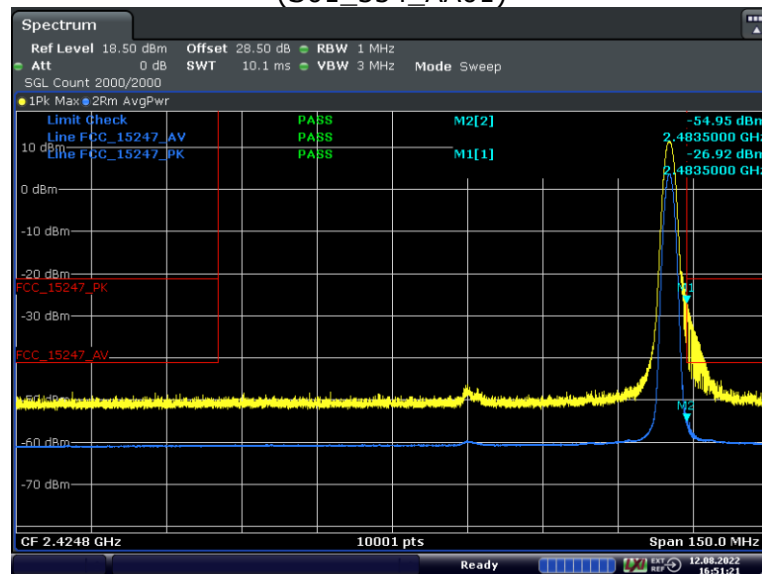

Date: 12.AUG.2022 16:51:22



Radio Technology = Bluetooth EDR 3, Operating Frequency = high, Band Edge = high  
(S01\_354\_AA01)

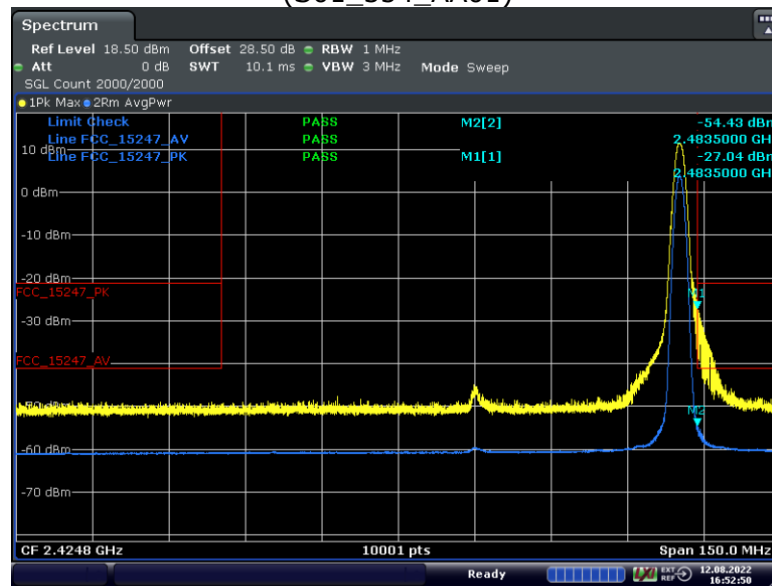

Date: 12.AUG.2022 16:52:51

Radio Technology = Bluetooth LE 1 Mbps, Operating Frequency = high, Band Edge = high  
(S02\_354\_AB01)

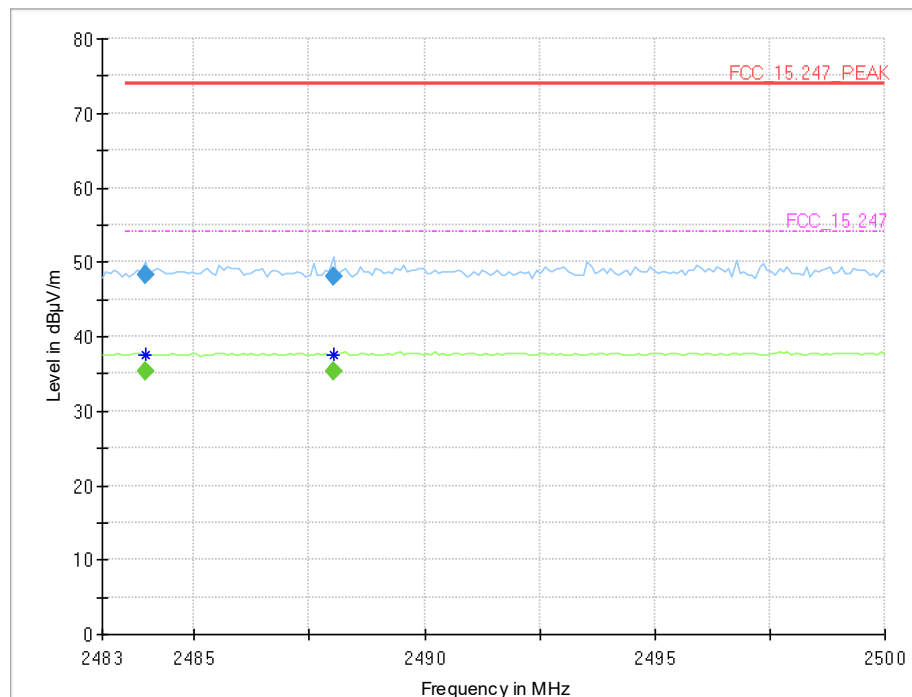

Frequency (MHz)	MaxPeak (dBµV/m)	CAverage (dBµV/m)	Limit (dBµV/m)	Margin (dB)	Meas. Time (ms)	Bandwidth (kHz)	Height (cm)	Pol	Azimuth (deg)	Elevation (deg)	Corr. (dB/m)
2483.935	---	35.2	54.00	18.78	1000.0	1000.000	150.0	V	-143.0	105.0	5.3
2483.935	48.3	---	74.00	25.66	1000.0	1000.000	150.0	V	-143.0	105.0	5.3
2488.015	---	35.3	54.00	18.73	1000.0	1000.000	150.0	V	-177.0	-6.0	5.3
2488.015	48.0	---	74.00	25.98	1000.0	1000.000	150.0	V	-177.0	-6.0	5.3

Radio Technology = Bluetooth LE 1 Mbps, Operating Frequency = high, Band Edge = high  
(S01\_354\_AA01)

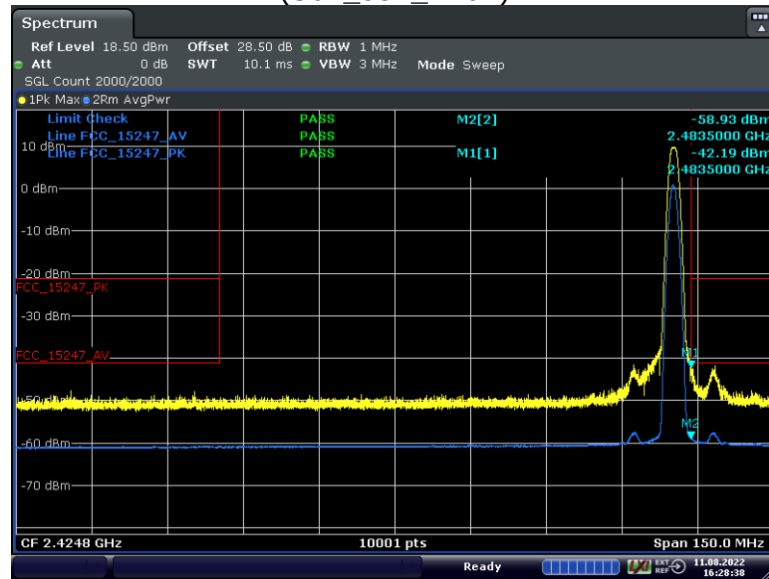

Date: 11.AUG.2022 16:28:38

Radio Technology = Bluetooth LE 2 Mbps, Operating Frequency = high, Band Edge = high  
(S01\_354\_AA01)

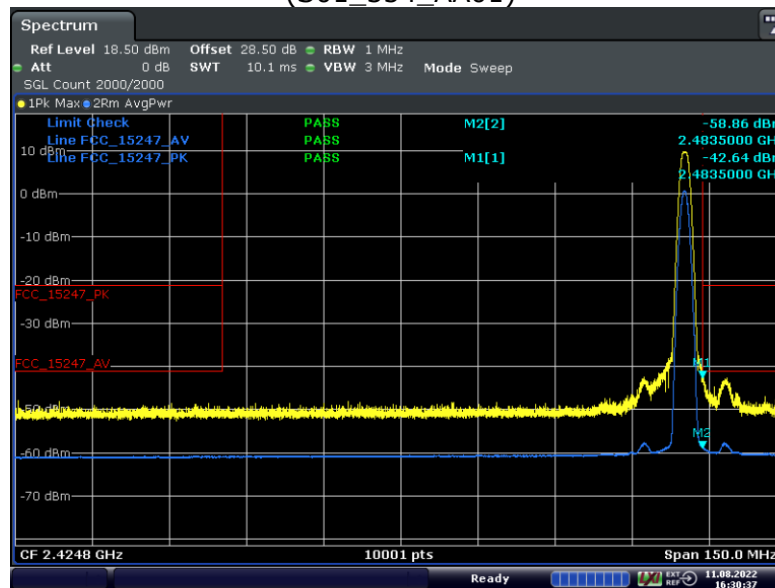

Date: 11.AUG.2022 16:30:37

Radio Technology = WLAN b, Operating Frequency = high, Band Edge = high  
(S02\_354\_AB01)

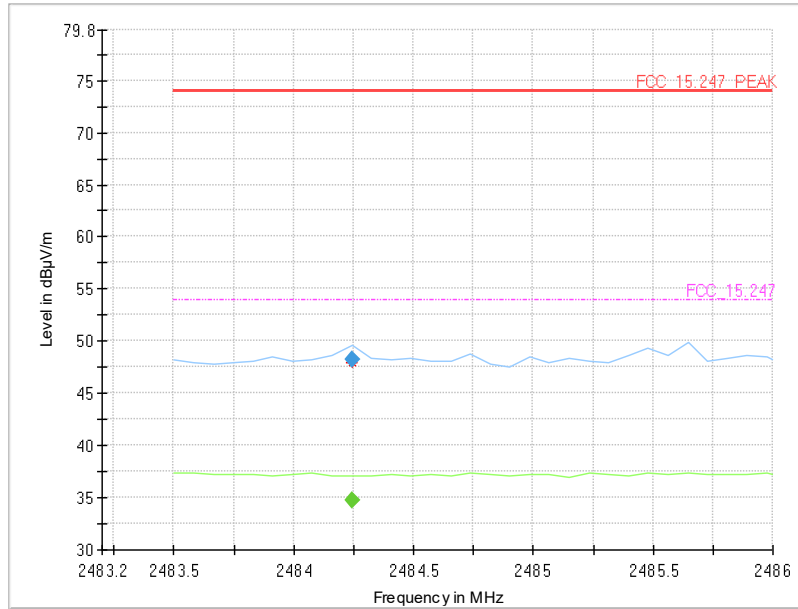

Frequency (MHz)	MaxPeak (dBµV/m)	CAverage (dBµV/m)	Limit (dBµV/m)	Margin (dB)	Meas. Time (ms)	Bandwidth (kHz)	Height (cm)	Pol	Azimuth (deg)	Elevation (deg)	Corr. (dB/m)
2484.243	---	34.8	54.00	19.22	1000.0	1000.000	150.0	H	28.0	-6.0	5.3
2484.243	48.2	---	74.00	25.79	1000.0	1000.000	150.0	H	28.0	-6.0	5.3

Radio Technology = WLAN b, Operating Frequency = high, Band Edge = high  
(S01\_354\_AA01)  
2nd highest Channel, high BE



Date: 11.AUG.2022 16:11:33

### Highest Channel, high BE

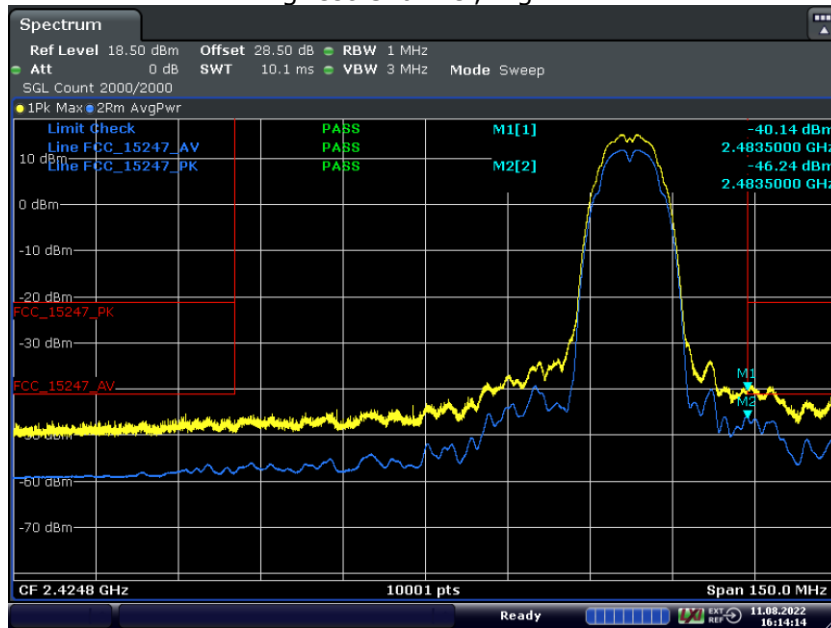

Date: 11.AUG.2022 16:14:14

Radio Technology = WLAN g, Operating Frequency = high, Band Edge = high (S02\_354\_AB01)

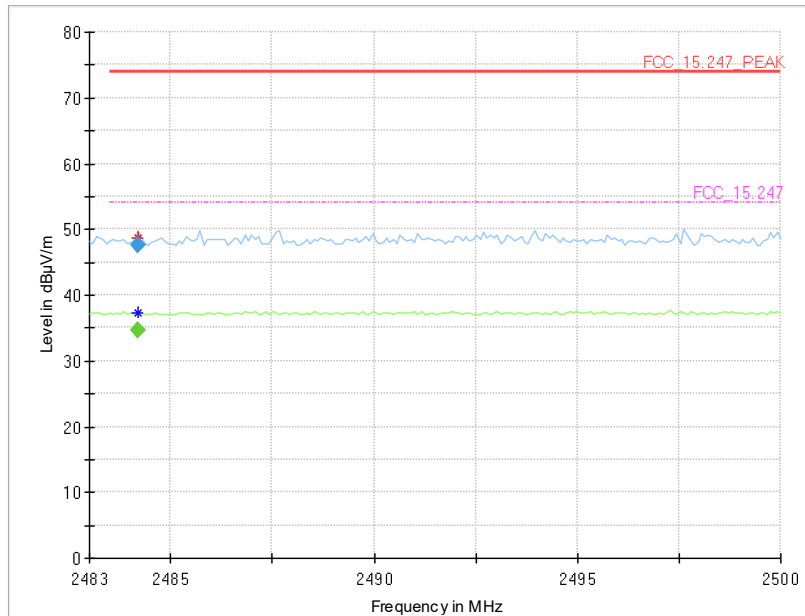

Frequency (MHz)	MaxPeak (dBµV/m)	CAverage (dBµV/m)	Limit (dBµV/m)	Margin (dB)	Meas. Time (ms)	Bandwidth (kHz)	Height (cm)	Pol	Azimuth (deg)	Elevation (deg)	Corr. (dB/m)
2484.190	---	34.7	54.00	19.26	1000.0	1000.000	150.0	H	119.0	-10.0	5.3
2484.190	47.7	---	74.00	26.29	1000.0	1000.000	150.0	H	119.0	-10.0	5.3

Radio Technology = WLAN g, Operating Frequency = high, Band Edge = high (S01\_354\_AB01)

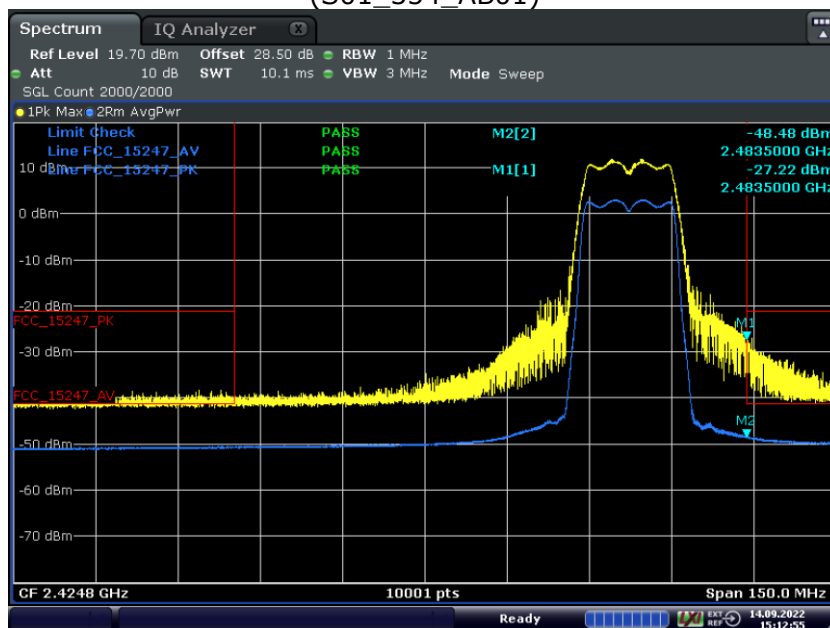

Date: 14.SEP.2022 15:12:56

Radio Technology = WLAN n 20 MHz, Operating Frequency = high, Band Edge = high (S02\_354\_AB01)

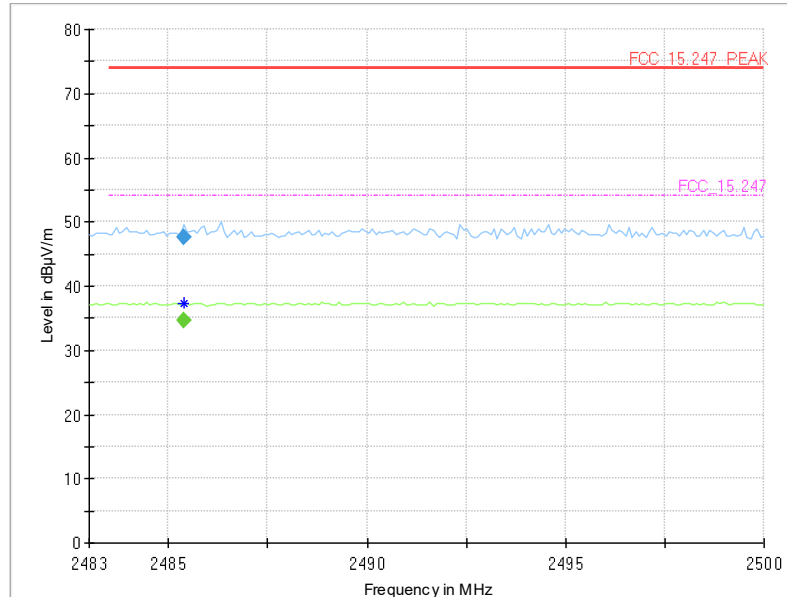

Frequency (MHz)	MaxPeak (dBµV/m)	CAverage (dBµV/m)	Limit (dBµV/m)	Margin (dB)	Meas. Time (ms)	Bandwidth (kHz)	Height (cm)	Pol	Azimuth (deg)	Elevation (deg)	Corr. (dB/m)
2485.380	---	34.7	54.00	19.28	1000.0	1000.000	150.0	H	96.0	-2.0	5.3
2485.380	47.5	---	74.00	26.48	1000.0	1000.000	150.0	H	96.0	-2.0	5.3

Radio Technology = WLAN n 20 MHz, Operating Frequency = high, Band Edge = high (S01\_354\_AB01)

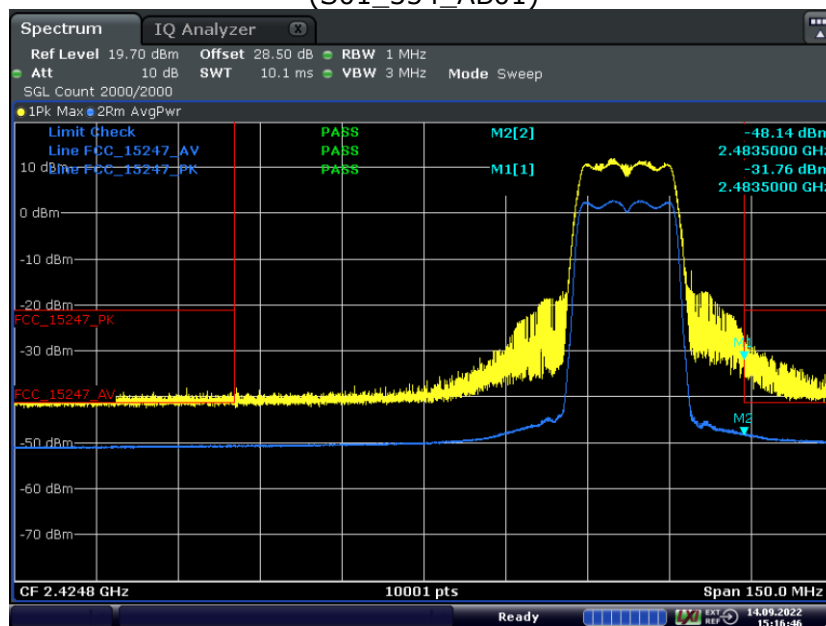

Date: 14.SEP.2022 15:16:46

Radio Technology = WLAN n 40 MHz, Operating Frequency = high, Band Edge = high  
(S02\_354\_AB01)

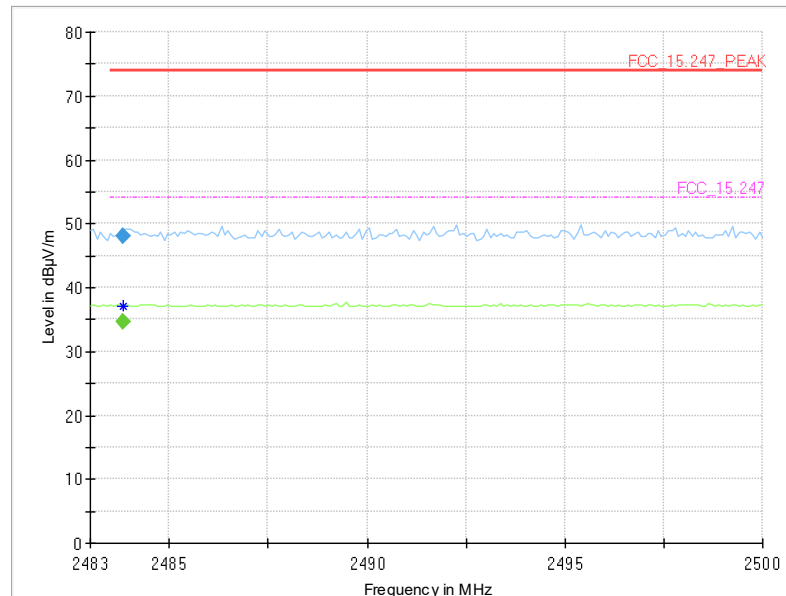

Frequency (MHz)	MaxPeak (dBµV/m)	CAverage (dBµV/m)	Limit (dBµV/m)	Margin (dB)	Meas. Time (ms)	Bandwidth (kHz)	Height (cm)	Pol	Azimuth (deg)	Elevation (deg)	Corr. (dB/m)
2483.850	---	34.7	54.00	19.28	1000.0	1000.000	150.0	V	-173.0	8.0	5.3
2483.850	48.1	---	74.00	25.85	1000.0	1000.000	150.0	V	-173.0	8.0	5.3

Radio Technology = WLAN n 40 MHz, Operating Frequency = high, Band Edge = high  
(S01\_354\_AB01)

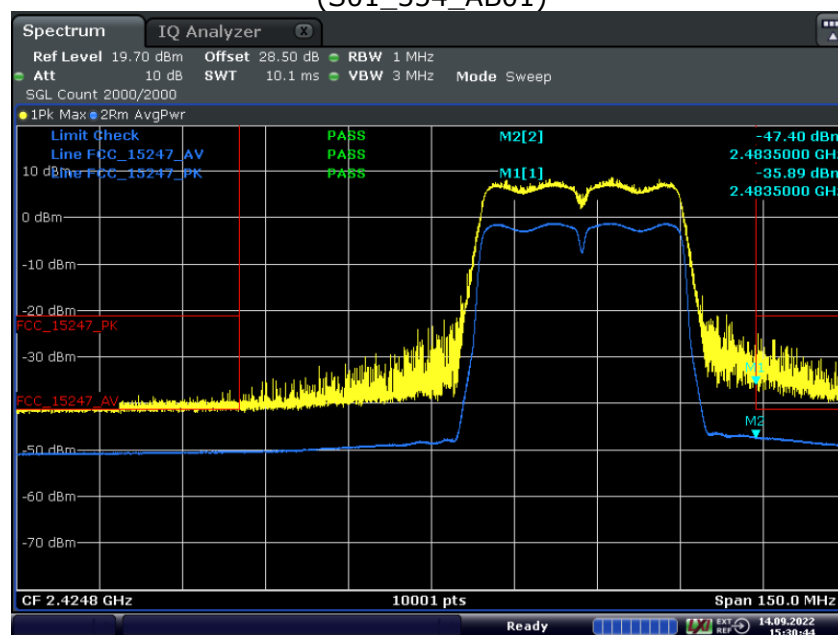

Date: 14.SEP.2022 15:30:44

Radio Technology = WLAN ax 20 MHz, Operating Frequency = high, Band Edge = high  
(S01\_354\_AB01)

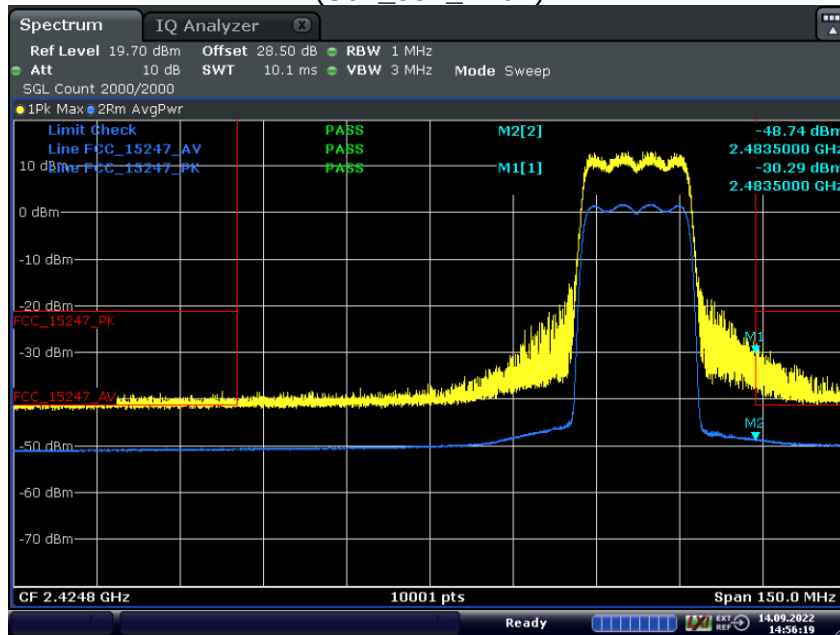

Radio Technology = WLAN ax 40 MHz, Operating Frequency = high, Band Edge = high  
(S01\_354\_AB01)

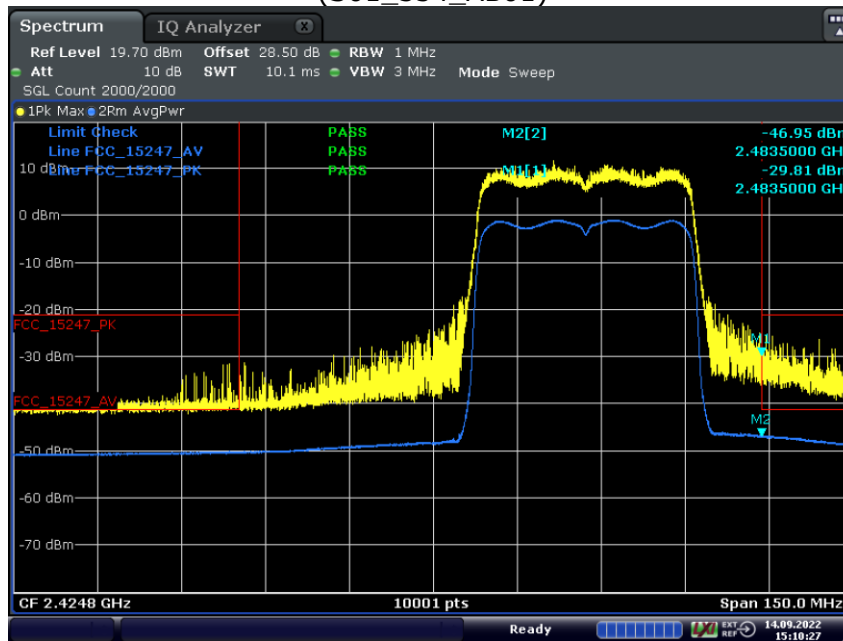

### 5.8.5 TEST EQUIPMENT USED

- Radiated Emissions FAR 2.4 GHz FCC
- Radiated Emissions
- R&S TS8997



## 5.9 POWER DENSITY

Standard **FCC Part 15 Subpart C**

**The test was performed according to:**  
ANSI C63.10

### 5.9.1 TEST DESCRIPTION

The Equipment Under Test (EUT) was set up in a shielded room to perform the Power Density measurements.

The results recorded were measured with the modulation which produces the worst-case (highest) power density.

The EUT was connected to the test system as described in the block diagram below. The complete attenuation of the measurement path is known and considered.

Maximum Peak Power Spectral Density (e.g. Bluetooth low energy):

Analyser settings:

- Resolution Bandwidth (RBW): 100 kHz, 10 kHz or 3 kHz
- Video Bandwidth (VBW):  $\geq 3$  times RBW
- Trace: Maxhold
- Sweeps: Till stable (min. 200, max. 15000)
- Sweeptime: Auto
- Detector: Peak

Maximum Average Power Spectral Density (e.g. WLAN):

Analyser settings:

- Resolution Bandwidth (RBW): 100 kHz, 10 kHz or 3 kHz
- Video Bandwidth (VBW):  $\geq 3$  times RBW
- Sweep Points:  $\geq 2$  times span / RBW
- Trace: Maxhold
- Sweeps: Till stable (max. 150)
- Sweeptime:  $\leq$  Number of Sweep Points x minimum transmission duration
- Detector: RMS

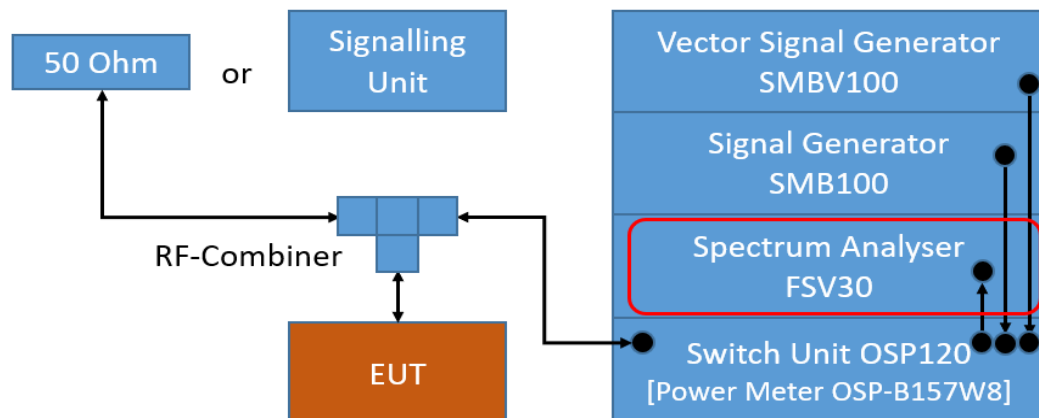

TS8997; Power Spectral Density

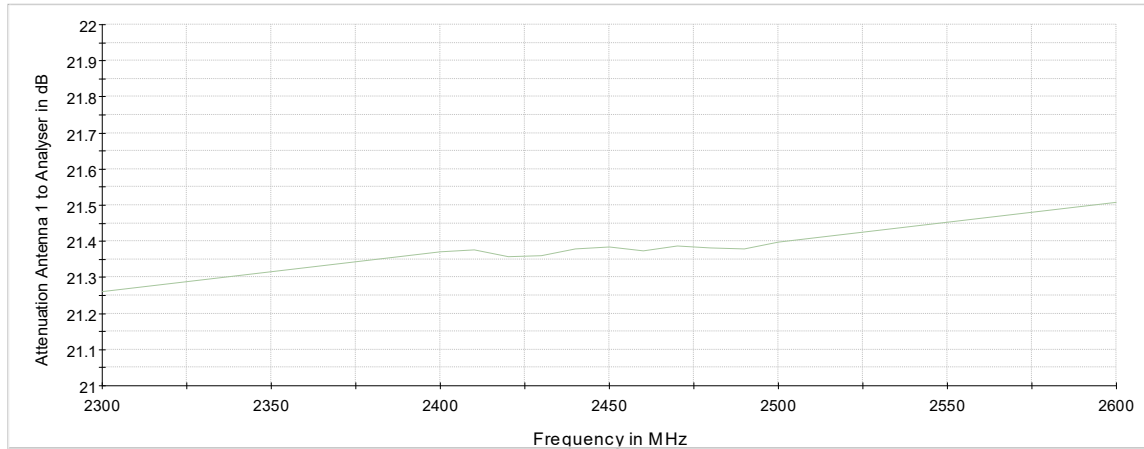

Attenuation of the measurement path

### 5.9.2 TEST REQUIREMENTS / LIMITS

FCC Part 15, Subpart C, §15.247 (e)

For digitally modulated systems, the peak power spectral density conducted from the intentional radiator to the antenna shall not be greater than 8 dBm in any 3 kHz band during any time interval of continuous transmission.

...

The same method of determining the conducted output power shall be used to determine the power spectral density.

FCC Part 15, Subpart C, §15.247 (f)

(f) For the purposes of this section, hybrid systems are those that employ a combination of both frequency hopping and digital modulation techniques.

...

The power spectral density conducted from the intentional radiator to the antenna due to the digital modulation operation of the hybrid system, with the frequency hopping operation turned off, shall not be greater than 8 dBm in any 3 kHz band during any time interval of continuous transmission

### 5.9.3 TEST PROTOCOL

Ambient temperature: 30 °C  
 Air Pressure: 1005 hPa  
 Humidity: 28 %

#### BT LE 1 Mbit/s

Variant	Channel No.	Frequency [MHz]	Power Density [dBm / RBW]	RBW [kHz]	Limit [dBm/3kHz]	Margin to Limit [dB]
354-00	0	2402	-1.6	10.0	8.0	9.6
354-00	19	2440	-1.6	10.0	8.0	9.6
354-00	39	2480	-1.8	10.0	8.0	9.8

#### BT LE 2 Mbit/s

Variant	Channel No.	Frequency [MHz]	Power Density [dBm / RBW]	RBW [kHz]	Limit [dBm/3kHz]	Margin to Limit [dB]
354-00	0	2402	-4.9	10.0	8.0	12.9
354-00	19	2440	-4.9	10.0	8.0	12.9
354-00	39	2480	-5.5	10.0	8.0	13.5

Remark: Please see next sub-clause for the measurement plot.  
 WLAN SISO results of antenna A given in table above.

### 5.9.4 MEASUREMENT PLOT (EXAMPLE PLOT, SHOWING WORST CASE, IF APPLICABLE)

Radio Technology = Bluetooth LE 1 Mbps, Operating Frequency = low  
 (S01\_354\_AA01)

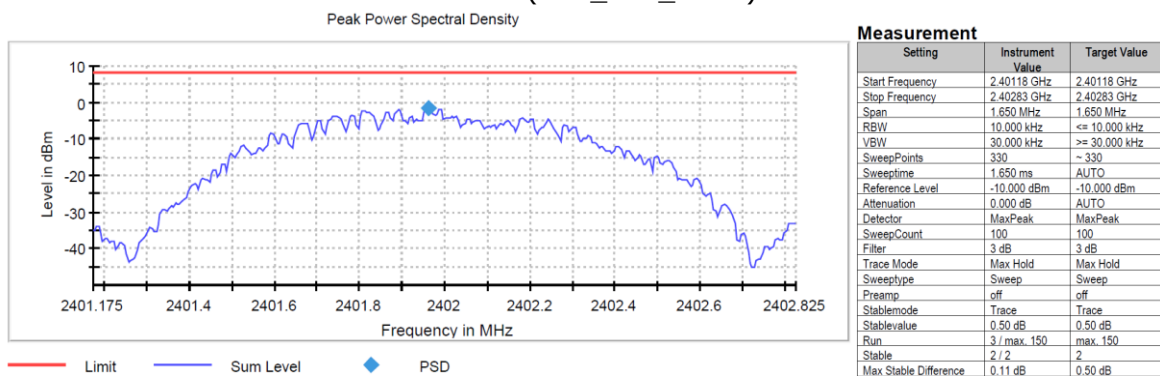

Radio Technology = Bluetooth LE 2 Mbps, Operating Frequency = low  
(S01\_354\_AA01)

Peak Power Spectral Density

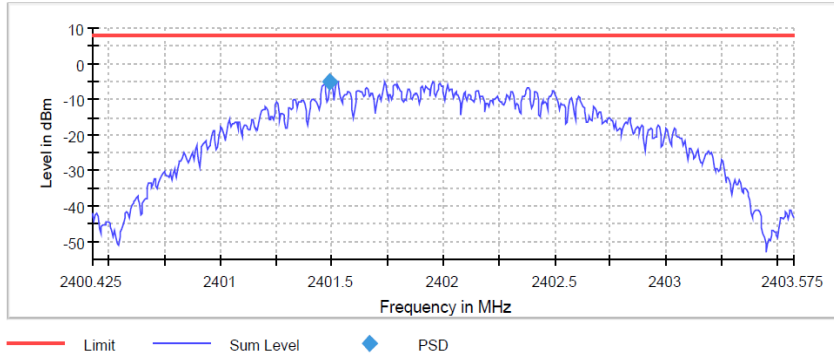

Measurement

Setting	Instrument Value	Target Value
Start Frequency	2.40043 GHz	2.40043 GHz
Stop Frequency	2.40358 GHz	2.40358 GHz
Span	3.150 MHz	3.150 MHz
RBW	10.000 kHz	<= 10.000 kHz
VBW	30.000 kHz	>= 30.000 kHz
SweepPoints	630	- 630
SweepTime	3.150 ms	AUTO
Reference Level	-10.000 dBm	-10.000 dBm
Attenuation	0.000 dB	AUTO
Detector	MaxPeak	MaxPeak
SweepCount	100	100
Filter	3 dB	3 dB
Trace Mode	Max Hold	Max Hold
SweepType	Sweep	Sweep
Preamp	off	off
Stablemode	Trace	Trace
Stablevalue	0.50 dB	0.50 dB
Run	4 / max. 150	max. 150
Stable	2 / 2	2
Max Stable Difference	0.12 dB	0.50 dB

5.9.5 TEST EQUIPMENT USED

- R&S TS8997

## 6 TEST EQUIPMENT

- 1 Conducted Emissions FCC  
Conducted Emissions AC Mains for FCC standards

Ref.No.	Device Name	Description	Manufacturer	Serial Number	Last Calibration	Calibration Due
1.1	MFS	Rubidium Frequency Normal MFS	Datum GmbH	002	2021-11	2022-11
1.2	Opus10 TPR (8253.00)	T/P Logger 13	Lufft Mess- und Regeltechnik GmbH	13936	2021-10	2023-10
1.3	Chroma 6404	AC Source	Chroma ATE INC.	64040001304		
1.4	Shielded Room 02	Shielded Room 4m x 3m	Frankonia Germany EMC Solution GmbH	-		
1.5	ESH3-Z5	Two-Line V-Network (EUT)	Rohde & Schwarz GmbH & Co. KG	829996/002	2021-08	2023-08
1.6	ESR 7	EMI Receiver / Spectrum Analyzer	Rohde & Schwarz	101424	2021-01	2023-01
1.7	Opus10 THI (8152.00)	T/H Logger 02	Lufft Mess- und Regeltechnik GmbH	7489	2021-10	2023-10

- 2 R&S TS8997  
2.4 and 5 GHz Bands Conducted Test Lab

Ref.No.	Device Name	Description	Manufacturer	Serial Number	Last Calibration	Calibration Due
2.1	MFS	Rubidium Frequency Normal MFS	Datum GmbH	002	2021-11	2022-11
2.2	Opus10 TPR (8253.00)	T/P Logger 13	Lufft Mess- und Regeltechnik GmbH	13936	2021-10	2023-10
2.3	SMB100A	Signal Generator 9 kHz - 6 GHz	Rohde & Schwarz	107695	2021-06	2024-06
2.4	NGSM 32/10	Power Supply	Rohde & Schwarz GmbH & Co. KG	3456	2022-01	2024-01
2.5	FSW43	Signal analyser	Rohde & Schwarz GmbH & Co. KG	102013	2021-06	2023-06
2.6	Opus10 THI (8152.00)	T/H Logger 14	Lufft Mess- und Regeltechnik GmbH	13993	2021-08	2023-08
2.7	SMBV100A	Vector Signal Generator 9 kHz - 6 GHz	Rohde & Schwarz	259291	2019-11	2022-11
2.8	OSP120	Contains Power Meter and Switching Unit OSP-B157W8	Rohde & Schwarz	101158	2021-08	2024-08
2.9	CMX500	Radio Communication Tester New Radio 5G	Rohde & Schwarz GmbH & Co. KG	101305-LP	2020-04	2023-04

3 Radiated Emissions FAR 2.4 GHz FCC  
 Radiated emission tests for 2.4 GHz ISM devices in a fully anechoic room

Ref.No.	Device Name	Description	Manufacturer	Serial Number	Last Calibration	Calibration Due
3.1	Opus10 TPR (8253.00)	T/P Logger 13	Lufft Mess- und Regeltechnik GmbH	13936	2021-10	2023-10
3.2	AMF-7D00101800-30-10P-R	Broadband Amplifier 100 MHz - 18 GHz	Miteq			
3.3	Anechoic Chamber 03	FAR, 8.80m x 4.60m x 4.05m (l x w x h)	Albatross Projects	P26971-647-001-PRB	2021-04	2023-04
3.4	Fluke 177	Digital Multimeter 03 (Multimeter)	Fluke Europe B.V.	86670383	2022-06	2024-06
3.5	JS4-18002600-32-5P	Broadband Amplifier 18 GHz - 26 GHz	Miteq	849785		
3.6	FSW 43	Spectrum Analyzer	Rohde & Schwarz	103779	2021-06	2023-06
3.7	EP 1200/B, NA/B1	AC Source, Amplifier with integrated variable Oscillator	Spitzenberger & Spies GmbH & Co. KG	B6278		
3.8	3160-09	Standard Gain / Pyramidal Horn Antenna 26.5 GHz	EMCO Elektronik GmbH	00083069		
3.9	WHKX 7.0/18G-8SS	High Pass Filter	Wainwright Instruments GmbH	09		
3.10	TT 1.5 WI	Turn Table	Maturo GmbH	-		
3.11	5HC3500/18000-1.2-KK	High Pass Filter	Trilithic	200035008		
3.12	Opus 20 THI (8120.00)	ThermoHygro Datalogger	Lufft Mess- und Regeltechnik GmbH	115.0318.0802.033	2020-10	2022-10
3.13	TD1.5-10kg	EUT Tilt Device (Rohacell)	Maturo GmbH	TD1.5-10kg/024/3790709		
3.14	PAS 2.5 - 10 kg	Antenna Mast	Maturo GmbH	-		
3.15	AFS42-00101800-25-S-42	Broadband Amplifier 25 MHz - 18 GHz	Miteq	2035324		
3.16	HF 907	Double-ridged horn	Rohde & Schwarz	102444	2021-09	2024-09

4 Radiated Emissions SAC H-Field  
 Radiated emission tests in the H-Field in a semi anechoic room

Ref.No.	Device Name	Description	Manufacturer	Serial Number	Last Calibration	Calibration Due
4.1	Opus10 TPR (8253.00)	T/P Logger 13	Lufft Mess- und Regeltechnik GmbH	13936	2021-10	2023-10
4.2	ESW44	EMI Receiver / Spectrum Analyzer	Rohde & Schwarz GmbH & Co. KG	101603	2022-01	2024-01

Ref.No.	Device Name	Description	Manufacturer	Serial Number	Last Calibration	Calibration Due
4.3	Anechoic Chamber 01	SAC/FAR, 10.58 m x 6.38 m x 6.00 m	Frankonia	none		
4.4	Opus10 THI (8152.00)	T/H Logger 10	Lufft Mess- und Regeltechnik GmbH	12488	2021-08	2023-08
4.5	EP 1200/B, NA/B1	AC Source, Amplifier with integrated variable Oscillator	Spitzenberger & Spies GmbH & Co. KG	B6278		
4.6	DS 420S	Turn Table 2 m diameter	HD GmbH	420/573/99		
4.7	HFH2-Z2	Loop Antenna + 3 Axis Tripod	Rohde & Schwarz GmbH & Co. KG	829324/006	2021-01	2024-01

5 Radiated Emissions SAC up to 1 GHz  
 Radiated emission tests up to 1 GHz in a semi anechoic room

Ref.No.	Device Name	Description	Manufacturer	Serial Number	Last Calibration	Calibration Due
5.1	Opus10 TPR (8253.00)	T/P Logger 13	Lufft Mess- und Regeltechnik GmbH	13936	2021-10	2023-10
5.2	ESW44	EMI Receiver / Spectrum Analyzer	Rohde & Schwarz GmbH & Co. KG	101603	2022-01	2024-01
5.3	Anechoic Chamber 01	SAC/FAR, 10.58 m x 6.38 m x 6.00 m	Frankonia	none		
5.4	HL 562 ULTRALOG	Biconical-log-per antenna (30 MHz - 3 GHz) with HL 562E biconicals	Rohde & Schwarz GmbH & Co. KG	830547/003	2021-09	2024-09
5.5	Opus10 THI (8152.00)	T/H Logger 10	Lufft Mess- und Regeltechnik GmbH	12488	2021-08	2023-08
5.6	EP 1200/B, NA/B1	AC Source, Amplifier with integrated variable Oscillator	Spitzenberger & Spies GmbH & Co. KG	B6278		
5.7	DS 420S	Turn Table 2 m diameter	HD GmbH	420/573/99		
5.8	AM 4.0	Antenna Mast 4 m	Maturo GmbH	AM4.0/180/11920513		

The calibration interval is the time interval between "Last Calibration" and "Calibration Due"

## 7 ANTENNA FACTORS, CABLE LOSS AND SAMPLE CALCULATIONS

This chapter contains the antenna factors with their corresponding path loss of the used measurement path for all antennas as well as the insertion loss of the LISN.

### 7.1 LISN R&S ESH3-Z5 (150 KHZ – 30 MHZ)

Frequency MHz	Corr. dB	LISN insertion loss ESH3- Z5 dB	cable loss (incl. 10 dB atten- uator) dB
0.15	10.1	0.1	10.0
5	10.3	0.1	10.2
7	10.5	0.2	10.3
10	10.5	0.2	10.3
12	10.7	0.3	10.4
14	10.7	0.3	10.4
16	10.8	0.4	10.4
18	10.9	0.4	10.5
20	10.9	0.4	10.5
22	11.1	0.5	10.6
24	11.1	0.5	10.6
26	11.2	0.5	10.7
28	11.2	0.5	10.7
30	11.3	0.5	10.8

#### Sample calculation

$$U_{\text{LISN}} \text{ (dB } \mu\text{V)} = U \text{ (dB } \mu\text{V)} + \text{Corr. (dB)}$$

U = Receiver reading

LISN Insertion loss = Voltage Division Factor of LISN

Corr. = sum of single correction factors of used LISN, cables, switch units (if used)

Linear interpolation will be used for frequencies in between the values in the table.



## 7.2 ANTENNA R&S HFH2-Z2 (9 KHZ – 30 MHZ)

Frequency MHz	AF HFH-Z2) dB (1/m)	Corr. dB	cable loss 1 (inside chamber) dB	cable loss 2 (outside chamber) dB	cable loss 3 (switch unit) dB	cable loss 4 (to receiver) dB	distance corr. (-40 dB/ decade) dB	d <sub>Limit</sub> (meas. distance (limit) m	d <sub>used</sub> (meas. distance (used) m
0.009	20.50	-79.6	0.1	0.1	0.1	0.1	-80	300	3
0.01	20.45	-79.6	0.1	0.1	0.1	0.1	-80	300	3
0.015	20.37	-79.6	0.1	0.1	0.1	0.1	-80	300	3
0.02	20.36	-79.6	0.1	0.1	0.1	0.1	-80	300	3
0.025	20.38	-79.6	0.1	0.1	0.1	0.1	-80	300	3
0.03	20.32	-79.6	0.1	0.1	0.1	0.1	-80	300	3
0.05	20.35	-79.6	0.1	0.1	0.1	0.1	-80	300	3
0.08	20.30	-79.6	0.1	0.1	0.1	0.1	-80	300	3
0.1	20.20	-79.6	0.1	0.1	0.1	0.1	-80	300	3
0.2	20.17	-79.6	0.1	0.1	0.1	0.1	-80	300	3
0.3	20.14	-79.6	0.1	0.1	0.1	0.1	-80	300	3
0.49	20.12	-79.6	0.1	0.1	0.1	0.1	-80	300	3
0.490001	20.12	-39.6	0.1	0.1	0.1	0.1	-40	30	3
0.5	20.11	-39.6	0.1	0.1	0.1	0.1	-40	30	3
0.8	20.10	-39.6	0.1	0.1	0.1	0.1	-40	30	3
1	20.09	-39.6	0.1	0.1	0.1	0.1	-40	30	3
2	20.08	-39.6	0.1	0.1	0.1	0.1	-40	30	3
3	20.06	-39.6	0.1	0.1	0.1	0.1	-40	30	3
4	20.05	-39.5	0.2	0.1	0.1	0.1	-40	30	3
5	20.05	-39.5	0.2	0.1	0.1	0.1	-40	30	3
6	20.02	-39.5	0.2	0.1	0.1	0.1	-40	30	3
8	19.95	-39.5	0.2	0.1	0.1	0.1	-40	30	3
10	19.83	-39.4	0.2	0.1	0.2	0.1	-40	30	3
12	19.71	-39.4	0.2	0.1	0.2	0.1	-40	30	3
14	19.54	-39.4	0.2	0.1	0.2	0.1	-40	30	3
16	19.53	-39.3	0.3	0.1	0.2	0.1	-40	30	3
18	19.50	-39.3	0.3	0.1	0.2	0.1	-40	30	3
20	19.57	-39.3	0.3	0.1	0.2	0.1	-40	30	3
22	19.61	-39.3	0.3	0.1	0.2	0.1	-40	30	3
24	19.61	-39.3	0.3	0.1	0.2	0.1	-40	30	3
26	19.54	-39.3	0.3	0.1	0.2	0.1	-40	30	3
28	19.46	-39.2	0.3	0.1	0.3	0.1	-40	30	3
30	19.73	-39.1	0.4	0.1	0.3	0.1	-40	30	3

### Sample calculation

$$E \text{ (dB } \mu\text{V/m)} = U \text{ (dB } \mu\text{V)} + AF \text{ (dB 1/m)} + Corr. \text{ (dB)}$$

U = Receiver reading

AF = Antenna factor

Corr. = sum of single correction factors of used cables, switch unit, distance correction, amplifier (if applicable)

distance correction =  $-40 * \text{LOG} (d_{\text{Limit}} / d_{\text{used}})$

Linear interpolation will be used for frequencies in between the values in the table.

Table shows an extract of values

### 7.3 ANTENNA R&S HL562 (30 MHZ – 1 GHZ)

( $d_{Limit} = 3\text{ m}$ )

Frequency	AF R&S HL562	Corr.
MHz	dB (1/m)	dB
30	18.6	0.6
50	6.0	0.9
100	9.7	1.2
150	7.9	1.6
200	7.6	1.9
250	9.5	2.1
300	11.0	2.3
350	12.4	2.6
400	13.6	2.9
450	14.7	3.1
500	15.6	3.2
550	16.3	3.5
600	17.2	3.5
650	18.1	3.6
700	18.5	3.6
750	19.1	4.1
800	19.6	4.1
850	20.1	4.4
900	20.8	4.7
950	21.1	4.8
1000	21.6	4.9

cable loss 1 (inside chamber)	cable loss 2 (outside chamber)	cable loss 3 (switch unit)	cable loss 4 (to receiver)	distance corr. (-20 dB/decade)	$d_{Limit}$ (meas. distance (limit))	$d_{used}$ (meas. distance (used))
dB	dB	dB	dB	dB	m	m
0.29	0.04	0.23	0.02	0.0	3	3
0.39	0.09	0.32	0.08	0.0	3	3
0.56	0.14	0.47	0.08	0.0	3	3
0.73	0.20	0.59	0.12	0.0	3	3
0.84	0.21	0.70	0.11	0.0	3	3
0.98	0.24	0.80	0.13	0.0	3	3
1.04	0.26	0.89	0.15	0.0	3	3
1.18	0.31	0.96	0.13	0.0	3	3
1.28	0.35	1.03	0.19	0.0	3	3
1.39	0.38	1.11	0.22	0.0	3	3
1.44	0.39	1.20	0.19	0.0	3	3
1.55	0.46	1.24	0.23	0.0	3	3
1.59	0.43	1.29	0.23	0.0	3	3
1.67	0.34	1.35	0.22	0.0	3	3
1.67	0.42	1.41	0.15	0.0	3	3
1.87	0.54	1.46	0.25	0.0	3	3
1.90	0.46	1.51	0.25	0.0	3	3
1.99	0.60	1.56	0.27	0.0	3	3
2.14	0.60	1.63	0.29	0.0	3	3
2.22	0.60	1.66	0.33	0.0	3	3
2.23	0.61	1.71	0.30	0.0	3	3

( $d_{Limit} = 10\text{ m}$ )

30	18.6	-9.9
50	6.0	-9.6
100	9.7	-9.2
150	7.9	-8.8
200	7.6	-8.6
250	9.5	-8.3
300	11.0	-8.1
350	12.4	-7.9
400	13.6	-7.6
450	14.7	-7.4
500	15.6	-7.2
550	16.3	-7.0
600	17.2	-6.9
650	18.1	-6.9
700	18.5	-6.8
750	19.1	-6.3
800	19.6	-6.3
850	20.1	-6.0
900	20.8	-5.8
950	21.1	-5.6
1000	21.6	-5.6

0.29	0.04	0.23	0.02	-10.5	10	3
0.39	0.09	0.32	0.08	-10.5	10	3
0.56	0.14	0.47	0.08	-10.5	10	3
0.73	0.20	0.59	0.12	-10.5	10	3
0.84	0.21	0.70	0.11	-10.5	10	3
0.98	0.24	0.80	0.13	-10.5	10	3
1.04	0.26	0.89	0.15	-10.5	10	3
1.18	0.31	0.96	0.13	-10.5	10	3
1.28	0.35	1.03	0.19	-10.5	10	3
1.39	0.38	1.11	0.22	-10.5	10	3
1.44	0.39	1.20	0.19	-10.5	10	3
1.55	0.46	1.24	0.23	-10.5	10	3
1.59	0.43	1.29	0.23	-10.5	10	3
1.67	0.34	1.35	0.22	-10.5	10	3
1.67	0.42	1.41	0.15	-10.5	10	3
1.87	0.54	1.46	0.25	-10.5	10	3
1.90	0.46	1.51	0.25	-10.5	10	3
1.99	0.60	1.56	0.27	-10.5	10	3
2.14	0.60	1.63	0.29	-10.5	10	3
2.22	0.60	1.66	0.33	-10.5	10	3
2.23	0.61	1.71	0.30	-10.5	10	3

#### Sample calculation

$$E \text{ (dB } \mu\text{V/m)} = U \text{ (dB } \mu\text{V)} + \text{AF (dB 1/m)} + \text{Corr. (dB)}$$

U = Receiver reading

AF = Antenna factor

Corr. = sum of single correction factors of used cables, switch unit, distance correction, amplifier (if applicable)

distance correction =  $-20 * \text{LOG} (d_{Limit} / d_{used})$

Linear interpolation will be used for frequencies in between the values in the table.

Tables show an extract of values.

### 7.4 ANTENNA R&S HF907 (1 GHZ – 18 GHZ)

Frequency	AF R&S HF907	Corr.
MHz	dB (1/m)	dB
1000	24.4	-19.4
2000	28.5	-17.4
3000	31.0	-16.1
4000	33.1	-14.7
5000	34.4	-13.7
6000	34.7	-12.7
7000	35.6	-11.0

cable loss 1 (relay + cable inside chamber)	cable loss 2 (outside chamber)	cable loss 3 (switch unit, attenuator & pre-amp)	cable loss 4 (to receiver)		
dB	dB	dB	dB		
0.99	0.31	-21.51	0.79		
1.44	0.44	-20.63	1.38		
1.87	0.53	-19.85	1.33		
2.41	0.67	-19.13	1.31		
2.78	0.86	-18.71	1.40		
2.74	0.90	-17.83	1.47		
2.82	0.86	-16.19	1.46		

Frequency	AF R&S HF907	Corr.
MHz	dB (1/m)	dB
3000	31.0	-23.4
4000	33.1	-23.3
5000	34.4	-21.7
6000	34.7	-21.2
7000	35.6	-19.8

cable loss 1 (relay inside chamber)	cable loss 2 (inside chamber)	cable loss 3 (outside chamber)	cable loss 4 (switch unit, attenuator & pre-amp)	cable loss 5 (to receiver)	used for FCC 15.247
dB	dB	dB	dB	dB	
0.47	1.87	0.53	-27.58	1.33	
0.56	2.41	0.67	-28.23	1.31	
0.61	2.78	0.86	-27.35	1.40	
0.58	2.74	0.90	-26.89	1.47	
0.66	2.82	0.86	-25.58	1.46	

Frequency	AF R&S HF907	Corr.
MHz	dB (1/m)	dB
7000	35.6	-57.3
8000	36.3	-56.3
9000	37.1	-55.3
10000	37.5	-56.2
11000	37.5	-55.3
12000	37.6	-53.7
13000	38.2	-53.5
14000	39.9	-56.3
15000	40.9	-54.1
16000	41.3	-54.1
17000	42.8	-54.4
18000	44.2	-54.7

cable loss 1 (relay inside chamber)	cable loss 2 (High Pass)	cable loss 3 (pre-amp)	cable loss 4 (inside chamber)	cable loss 5 (outside chamber)	cable loss 6 (to receiver)
dB	dB	dB	dB	dB	dB
0.56	1.28	-62.72	2.66	0.94	1.46
0.69	0.71	-61.49	2.84	1.00	1.53
0.68	0.65	-60.80	3.06	1.09	1.60
0.70	0.54	-61.91	3.28	1.20	1.67
0.80	0.61	-61.40	3.43	1.27	1.70
0.84	0.42	-59.70	3.53	1.26	1.73
0.83	0.44	-59.81	3.75	1.32	1.83
0.91	0.53	-63.03	3.91	1.40	1.77
0.98	0.54	-61.05	4.02	1.44	1.83
1.23	0.49	-61.51	4.17	1.51	1.85
1.36	0.76	-62.36	4.34	1.53	2.00
1.70	0.53	-62.88	4.41	1.55	1.91

#### Sample calculation

$E \text{ (dB } \mu\text{V/m)} = U \text{ (dB } \mu\text{V)} + AF \text{ (dB 1/m)} + Corr. \text{ (dB)}$   
 U = Receiver reading  
 AF = Antenna factor  
 Corr. = sum of single correction factors of used cables, switch unit, distance correction, amplifier (if applicable)  
 Linear interpolation will be used for frequencies in between the values in the table.  
 Tables show an extract of values.

### 7.5 ANTENNA EMCO 3160-09 (18 GHZ – 26.5 GHZ)

Frequency MHz	AF EMCO 3160-09 dB (1/m)	Corr. dB	cable loss 1 (inside chamber) dB	cable loss 2 (pre- amp) dB	cable loss 3 (inside chamber) dB	cable loss 4 (switch unit) dB	cable loss 5 (to receiver) dB
18000	40.2	-23.5	0.72	-35.85	6.20	2.81	2.65
18500	40.2	-23.2	0.69	-35.71	6.46	2.76	2.59
19000	40.2	-22.0	0.76	-35.44	6.69	3.15	2.79
19500	40.3	-21.3	0.74	-35.07	7.04	3.11	2.91
20000	40.3	-20.3	0.72	-34.49	7.30	3.07	3.05
20500	40.3	-19.9	0.78	-34.46	7.48	3.12	3.15
21000	40.3	-19.1	0.87	-34.07	7.61	3.20	3.33
21500	40.3	-19.1	0.90	-33.96	7.47	3.28	3.19
22000	40.3	-18.7	0.89	-33.57	7.34	3.35	3.28
22500	40.4	-19.0	0.87	-33.66	7.06	3.75	2.94
23000	40.4	-19.5	0.88	-33.75	6.92	3.77	2.70
23500	40.4	-19.3	0.90	-33.35	6.99	3.52	2.66
24000	40.4	-19.8	0.88	-33.99	6.88	3.88	2.58
24500	40.4	-19.5	0.91	-33.89	7.01	3.93	2.51
25000	40.4	-19.3	0.88	-33.00	6.72	3.96	2.14
25500	40.5	-20.4	0.89	-34.07	6.90	3.66	2.22
26000	40.5	-21.3	0.86	-35.11	7.02	3.69	2.28
26500	40.5	-21.1	0.90	-35.20	7.15	3.91	2.36

#### Sample calculation

$$E \text{ (dB } \mu\text{V/m)} = U \text{ (dB } \mu\text{V)} + AF \text{ (dB 1/m)} + Corr. \text{ (dB)}$$

U = Receiver reading

AF = Antenna factor

Corr. = sum of single correction factors of used cables, switch unit, distance correction, amplifier (if applicable)

Linear interpolation will be used for frequencies in between the values in the table.

Table shows an extract of values.

## 7.6 ANTENNA EMCO 3160-10 (26.5 GHZ – 40 GHZ)

Frequency GHz	AF EMCO 3160-10 dB (1/m)	Corr. dB	cable loss 1 (inside chamber) dB	cable loss 2 (outside chamber) dB	cable loss 3 (switch unit) dB	cable loss 4 (to receiver) dB	distance corr. (-20 dB/ decade) dB	d <sub>Limit</sub> (meas. distance (limit) m	d <sub>used</sub> (meas. distance (used) m
26.5	43.4	-11.2	4.4				-9.5	3	1.0
27.0	43.4	-11.2	4.4				-9.5	3	1.0
28.0	43.4	-11.1	4.5				-9.5	3	1.0
29.0	43.5	-11.0	4.6				-9.5	3	1.0
30.0	43.5	-10.9	4.7				-9.5	3	1.0
31.0	43.5	-10.8	4.7				-9.5	3	1.0
32.0	43.5	-10.7	4.8				-9.5	3	1.0
33.0	43.6	-10.7	4.9				-9.5	3	1.0
34.0	43.6	-10.6	5.0				-9.5	3	1.0
35.0	43.6	-10.5	5.1				-9.5	3	1.0
36.0	43.6	-10.4	5.1				-9.5	3	1.0
37.0	43.7	-10.3	5.2				-9.5	3	1.0
38.0	43.7	-10.2	5.3				-9.5	3	1.0
39.0	43.7	-10.2	5.4				-9.5	3	1.0
40.0	43.8	-10.1	5.5				-9.5	3	1.0

### Sample calculation

$$E \text{ (dB } \mu\text{V/m)} = U \text{ (dB } \mu\text{V)} + \text{AF (dB 1/m)} + \text{Corr. (dB)}$$

U = Receiver reading

AF = Antenna factor

Corr. = sum of single correction factors of used cables, switch unit, distance correction, amplifier (if applicable)

Linear interpolation will be used for frequencies in between the values in the table.

$$\text{distance correction} = -20 * \text{LOG} (d_{\text{Limit}} / d_{\text{used}})$$

Linear interpolation will be used for frequencies in between the values in the table.

Table shows an extract of values.



## 9 PHOTO REPORT

Please see separate photo report.