

FCC Measurement/Technical Report on

WLAN and Bluetooth module

JODY-W354

FCC ID: XPYJODYW374

IC: 8595A-JODYW374

Test Report Reference: MDE_UBLOX_2220_FCC_01

Test Laboratory:

7layers GmbH
Borsigstrasse 11
40880 Ratingen
Germany



Deutsche
Akkreditierungsstelle
D-PL-12140-01-01
D-PL-12140-01-02
D-PL-12140-01-03

Note:

The following test results relate only to the devices specified in this document. This report shall not be reproduced in parts without the written approval of the test laboratory.

7layers GmbH

Borsigstraße 11
40880 Ratingen, Germany
T +49 (0) 2102 749 0
F +49 (0) 2102 749 350

Geschäftsführer/
Managing Directors:
Sebastian Doose
Stefan Kischka
Bernhard Retka

Registergericht/registered:
Düsseldorf HRB 75554
USt-Id.-Nr./VAT-No. DE203159652
Steuer-Nr./TAX-No. 147/5869/0385

*a Bureau Veritas
Group Company*

www.7layers.com

Table of Contents

1	Applied Standards and Test Summary	3
1.1	Applied Standards	3
1.2	FCC-IC Correlation Table	4
1.3	Measurement Summary	5
2	Revision History / Signatures	12
3	Administrative Data	13
3.1	Testing Laboratory	13
3.2	Project Data	13
3.3	Applicant Data	13
3.4	Manufacturer Data	14
4	Test object Data	15
4.1	General EUT Description	15
4.2	EUT Main components	16
4.3	Ancillary Equipment	16
4.4	Auxiliary Equipment	17
4.5	EUT Setups	17
4.6	Operating Modes / Test Channels	18
4.7	Product labelling	21
5	Test Results	22
5.1	Conducted Emissions at AC Mains	22
5.2	Occupied Bandwidth (6 dB)	26
5.3	Occupied Bandwidth (99%)	29
5.4	Peak Power Output	33
5.5	Spurious RF Conducted Emissions	40
5.6	Transmitter Spurious Radiated Emissions	49
5.7	Band Edge Compliance Conducted	68
5.8	Band Edge Compliance Radiated	79
5.9	Power Density	95
6	Test Equipment	99
7	Antenna Factors, Cable Loss and Sample Calculations	102
7.1	LISN R&S ESH3-Z5 (150 kHz – 30 MHz)	102
7.2	Antenna R&S HFH2-Z2 (9 kHz – 30 MHz)	103
7.3	Antenna R&S HL562 (30 MHz – 1 GHz)	104
7.4	Antenna R&S HF907 (1 GHz – 18 GHz)	105
7.5	Antenna EMCO 3160-09 (18 GHz – 26.5 GHz)	106
7.6	Antenna EMCO 3160-10 (26.5 GHz – 40 GHz)	107
8	Measurement Uncertainties	108
9	Photo Report	109

1 APPLIED STANDARDS AND TEST SUMMARY

1.1 APPLIED STANDARDS

Type of Authorization

Certification for an Intentional Radiator.

Applicable FCC Rules

Prepared in accordance with the requirements of FCC Rules and Regulations as listed in 47 CFR Ch.1 Parts 2 and 15 (10-1-21 Edition). The following subparts are applicable to the results in this test report.

Part 2, Subpart J - Equipment Authorization Procedures, Certification

Part 15, Subpart C – Intentional Radiators

§ 15.201 Equipment authorization requirement

§ 15.207 Conducted limits

§ 15.209 Radiated emission limits; general requirements

§ 15.247 Operation within the bands 902-928 MHz, 2400-2483.5 MHz

Note:

The tests were selected and performed with reference to the FCC Public Notice "Guidance for Compliance Measurements on Digital Transmission System, Frequency Hopping Spread Spectrum System, and Hybrid System Devices Operating under Section 15.247 of the FCC Rules, 558074 D01 15.247 Meas Guidance v05r02, 2019-04-02". ANSI C63.10-2013 is applied.

1.2 FCC-IC CORRELATION TABLE

Correlation of measurement requirements for DTS (e.g. WLAN 2.4 GHz, BT LE) equipment from FCC and IC

DTS equipment

Measurement	FCC reference	IC reference
Conducted emissions on AC Mains	§ 15.207	RSS-Gen Issue 5: 8.8
Occupied bandwidth	§ 15.247 (a) (2)	RSS-247 Issue 2: 5.2 (a)
Peak conducted output power	§ 15.247 (b) (3), (4)	RSS-247 Issue 2: 5.4 (d)
Transmitter spurious RF conducted emissions	§ 15.247 (d)	RSS-Gen Issue 5: 6.13 / 8.9/8.10; RSS-247 Issue 2: 5.5
Transmitter spurious radiated emissions	§ 15.247 (d); § 15.209 (a)	RSS-Gen Issue 5: 6.13 / 8.9/8.10; RSS-247 Issue 2: 5.5
Band edge compliance	§ 15.247 (d)	RSS-247 Issue 2: 5.5
Power density	§ 15.247 (e)	RSS-247 Issue 2: 5.2 (b)
Antenna requirement	§ 15.203 / 15.204	RSS-Gen Issue 5: 8.3
Receiver spurious emissions	-	-

1.3 MEASUREMENT SUMMARY

47 CFR CHAPTER I FCC PART 15 § 15.207
Subpart C §15.247

Conducted Emissions at AC Mains

The measurement was performed according to ANSI C63.10 6.2

Final Result

OP-Mode	Setup	Date	FCC	IC
Operating mode, Connection to AC mains				
worst case, via ancillary/auxiliary equipment	S03_354_AB01	2022-09-16	Passed	Passed
worst case, via ancillary/auxiliary equipment	S03_354_AB01	2022-09-16	Passed	Passed

47 CFR CHAPTER I FCC PART 15 § 15.247 (a) (2)
Subpart C §15.247

Occupied Bandwidth (6 dB)

The measurement was performed according to ANSI C63.10 11.8.1

Final Result

OP-Mode	Setup	Date	FCC	IC
Radio Technology, Operating Frequency				
Bluetooth LE 1 Mbps, high	S01_354_AA01	2022-07-29	Passed	Passed
Bluetooth LE 1 Mbps, low	S01_354_AA01	2022-07-29	Passed	Passed
Bluetooth LE 1 Mbps, mid	S01_354_AA01	2022-07-29	Passed	Passed
Bluetooth LE 2 Mbps, high	S01_354_AA01	2022-09-19	Passed	Passed
Bluetooth LE 2 Mbps, low	S01_354_AA01	2022-07-29	Passed	Passed
Bluetooth LE 2 Mbps, mid	S01_354_AA01	2022-07-29	Passed	Passed

47 CFR CHAPTER I FCC PART 15 IC RSS-Gen & IC TRC-43; Ch. 6.7 & Ch. 8
Subpart C §15.247

Occupied Bandwidth (99%)

The measurement was performed according to ANSI C63.10 6.9.3

Final Result

OP-Mode	Setup	Date	FCC	IC
Radio Technology, Operating Frequency				
Bluetooth BDR, high	S01_354_AA01	2022-07-29	N/A	Performed
Bluetooth BDR, low	S01_354_AA01	2022-07-29	N/A	Performed
Bluetooth BDR, mid	S01_354_AA01	2022-07-29	N/A	Performed
Bluetooth EDR 2, high	S01_354_AA01	2022-07-29	N/A	Performed
Bluetooth EDR 2, low	S01_354_AA01	2022-07-29	N/A	Performed
Bluetooth EDR 2, mid	S01_354_AA01	2022-07-29	N/A	Performed
Bluetooth EDR 3, high	S01_354_AA01	2022-07-29	N/A	Performed
Bluetooth EDR 3, low	S01_354_AA01	2022-07-29	N/A	Performed
Bluetooth EDR 3, mid	S01_354_AA01	2022-07-29	N/A	Performed
Bluetooth LE 1 Mbps, high	S01_354_AA01	2022-07-29	N/A	Performed
Bluetooth LE 1 Mbps, low	S01_354_AA01	2022-07-29	N/A	Performed
Bluetooth LE 1 Mbps, mid	S01_354_AA01	2022-07-29	N/A	Performed
Bluetooth LE 2 Mbps, high	S01_354_AA01	2022-09-19	N/A	Performed
Bluetooth LE 2 Mbps, low	S01_354_AA01	2022-07-29	N/A	Performed
Bluetooth LE 2 Mbps, mid	S01_354_AA01	2022-07-29	N/A	Performed

47 CFR CHAPTER I FCC PART 15
Subpart C §15.247

§ 15.247 (b) (3)

Peak Power Output

The measurement was performed according to ANSI C63.10
11.9.1.1, 11.9.2.3.2

Final Result

OP-Mode	Setup	Date	FCC	IC
Radio Technology, Operating Frequency, Measurement method				
Bluetooth BDR, high, conducted	S01_354_AA01	2022-07-29	Passed	Passed
Bluetooth BDR, low, conducted	S01_354_AA01	2022-07-29	Passed	Passed
Bluetooth BDR, mid, conducted	S01_354_AA01	2022-07-29	Passed	Passed
Bluetooth EDR 2, high, conducted	S01_354_AA01	2022-07-29	Passed	Passed
Bluetooth EDR 2, low, conducted	S01_354_AA01	2022-07-29	Passed	Passed
Bluetooth EDR 2, mid, conducted	S01_354_AA01	2022-07-29	Passed	Passed
Bluetooth EDR 3, high, conducted	S01_354_AA01	2022-07-29	Passed	Passed
Bluetooth EDR 3, low, conducted	S01_354_AA01	2022-07-29	Passed	Passed
Bluetooth EDR 3, mid, conducted	S01_354_AA01	2022-07-29	Passed	Passed
Bluetooth LE 1 Mbps, high, conducted	S01_354_AA01	2022-07-29	Passed	Passed
Bluetooth LE 1 Mbps, low, conducted	S01_354_AA01	2022-07-29	Passed	Passed
Bluetooth LE 1 Mbps, mid, conducted	S01_354_AA01	2022-07-29	Passed	Passed
Bluetooth LE 2 Mbps, high, conducted	S01_354_AA01	2022-09-19	Passed	Passed
Bluetooth LE 2 Mbps, low, conducted	S01_354_AA01	2022-07-29	Passed	Passed
Bluetooth LE 2 Mbps, mid, conducted	S01_354_AA01	2022-07-29	Passed	Passed
WLAN ax 20 MHz, high, conducted	S01_354_AB01	2022-08-15	Passed	Passed
WLAN ax 20 MHz, low, conducted	S01_354_AB01	2022-08-15	Passed	Passed
WLAN ax 20 MHz, mid, conducted	S01_354_AB01	2022-08-15	Passed	Passed
WLAN ax 40 MHz, high, conducted	S01_354_AB01	2022-08-15	Passed	Passed
WLAN ax 40 MHz, low, conducted	S01_354_AB01	2022-08-15	Passed	Passed
WLAN ax 40 MHz, mid, conducted	S01_354_AB01	2022-08-15	Passed	Passed
WLAN b, high, conducted	S01_354_AB01	2022-08-15	Passed	Passed
WLAN b, low, conducted	S01_354_AB01	2022-08-15	Passed	Passed
WLAN b, mid, conducted	S01_354_AB01	2022-08-15	Passed	Passed
WLAN g, high, conducted	S01_354_AB01	2022-08-15	Passed	Passed
WLAN g, low, conducted	S01_354_AB01	2022-08-15	Passed	Passed
WLAN g, mid, conducted	S01_354_AB01	2022-08-15	Passed	Passed
WLAN n 20 MHz, high, conducted	S01_354_AB01	2022-08-15	Passed	Passed
WLAN n 20 MHz, low, conducted	S01_354_AB01	2022-08-15	Passed	Passed
WLAN n 20 MHz, mid, conducted	S01_354_AB01	2022-08-15	Passed	Passed
WLAN n 40 MHz, high, conducted	S01_354_AB01	2022-08-15	Passed	Passed
WLAN n 40 MHz, low, conducted	S01_354_AB01	2022-08-15	Passed	Passed
WLAN n 40 MHz, mid, conducted	S01_354_AB01	2022-08-15	Passed	Passed

47 CFR CHAPTER I FCC PART 15
Subpart C §15.247

§ 15.247 (d)

Spurious RF Conducted Emissions

The measurement was performed according to ANSI C63.10 11.11

Final Result

OP-Mode	Setup	Date	FCC	IC
Radio Technology, Operating Frequency				
Bluetooth BDR, high	S01_354_AA01	2022-07-29	Passed	Passed
Bluetooth BDR, low	S01_354_AA01	2022-07-29	Passed	Passed
Bluetooth BDR, mid	S01_354_AA01	2022-07-29	Passed	Passed
Bluetooth EDR 2, high	S01_354_AA01	2022-07-29	Passed	Passed
Bluetooth EDR 2, low	S01_354_AA01	2022-07-29	Passed	Passed
Bluetooth EDR 2, mid	S01_354_AA01	2022-07-29	Passed	Passed
Bluetooth EDR 3, high	S01_354_AA01	2022-07-29	Passed	Passed
Bluetooth EDR 3, low	S01_354_AA01	2022-07-29	Passed	Passed
Bluetooth EDR 3, mid	S01_354_AA01	2022-07-29	Passed	Passed
Bluetooth LE 1 Mbps, high	S01_354_AA01	2022-07-29	Passed	Passed
Bluetooth LE 1 Mbps, low	S01_354_AA01	2022-07-29	Passed	Passed
Bluetooth LE 1 Mbps, mid	S01_354_AA01	2022-07-29	Passed	Passed
Bluetooth LE 2 Mbps, high	S01_354_AA01	2022-07-29	Passed	Passed
Bluetooth LE 2 Mbps, low	S01_354_AA01	2022-07-29	Passed	Passed
Bluetooth LE 2 Mbps, mid	S01_354_AA01	2022-07-29	Passed	Passed

47 CFR CHAPTER I FCC PART 15
Subpart C §15.247

§ 15.247 (d)

Transmitter Spurious Radiated Emissions

The measurement was performed according to ANSI C63.10
6.4, 6.5, 6.6.5

Final Result

OP-Mode	Setup	Date	FCC	IC
Radio Technology, Operating Frequency, Measurement range				
Bluetooth BDR, high, 1 GHz - 26 GHz Remark: Measurement Method: Conducted	S01_354_AA01	2022-08-15	Passed	Passed
Bluetooth BDR, high, 30 MHz - 1 GHz Remark: Measurement Method: Conducted	S01_354_AB01	2022-09-14	Passed	Passed
Bluetooth BDR, high, 30 MHz - 1 GHz Remark: Measurement Method: Radiated	S02_354_AB01	2022-07-28	Passed	Passed
Bluetooth BDR, low, 1 GHz - 26 GHz Remark: Measurement Method: Conducted	S01_354_AA01	2022-08-15	Passed	Passed
Bluetooth BDR, low, 30 MHz - 1 GHz Remark: Measurement Method: Conducted	S01_354_AB01	2022-09-14	Passed	Passed
Bluetooth BDR, low, 30 MHz - 1 GHz Remark: Measurement Method: Radiated	S02_354_AB01	2022-07-28	Passed	Passed
Bluetooth BDR, mid, 1 GHz - 26 GHz Remark: Measurement Method: Conducted	S01_354_AA01	2022-08-15	Passed	Passed
Bluetooth BDR, mid, 30 MHz - 1 GHz Remark: Measurement Method: Conducted	S01_354_AB01	2022-09-14	Passed	Passed
Bluetooth BDR, mid, 30 MHz - 1 GHz Remark: Measurement Method: Radiated	S02_354_AB01	2022-07-28	Passed	Passed
Bluetooth BDR, low, 9 kHz - 30 MHz Remark: Measurement Method: Conducted	S01_354_AA01	2022-08-15	Passed	Passed

47 CFR CHAPTER I FCC PART 15
Subpart C §15.247

§ 15.247 (d)

Transmitter Spurious Radiated Emissions

The measurement was performed according to ANSI C63.10
6.4, 6.5, 6.6.5

Final Result

OP-Mode	Setup	Date	FCC	IC
Radio Technology, Operating Frequency, Measurement range				
Bluetooth BDR, mid, 9 kHz - 30 MHz Remark: Measurement Method: Conducted	S01_354_AA01	2022-08-15	Passed	Passed
Bluetooth BDR, high, 9 kHz - 30 MHz Remark: Measurement Method: Conducted	S01_354_AA01	2022-08-15	Passed	Passed
Bluetooth BDR, mid, 9 kHz - 30 MHz Remark: Measurement Method: Radiated	S02_354_AB01	2022-07-28	Passed	Passed
Bluetooth EDR 2, high, 1 GHz - 26 GHz Remark: Measurement Method: Conducted	S01_354_AA01	2022-08-15	Passed	Passed
Bluetooth EDR 2, low, 1 GHz - 26 GHz Remark: Measurement Method: Conducted	S01_354_AA01	2022-08-15	Passed	Passed
Bluetooth EDR 2, mid, 1 GHz - 26 GHz Remark: Measurement Method: Conducted	S01_354_AA01	2022-08-15	Passed	Passed
Bluetooth EDR 3, high, 1 GHz - 26 GHz Remark: Measurement Method: Conducted	S01_354_AA01	2022-08-15	Passed	Passed
Bluetooth EDR 3, low, 1 GHz - 26 GHz Remark: Measurement Method: Conducted	S01_354_AA01	2022-08-15	Passed	Passed
Bluetooth EDR 3, mid, 1 GHz - 26 GHz Remark: Measurement Method: Conducted	S01_354_AA01	2022-08-15	Passed	Passed
Bluetooth LE 1 Mbps, high, 1 GHz - 26 GHz Remark: Measurement Method: Conducted	S01_354_AA01	2022-08-15	Passed	Passed
Bluetooth LE 1 Mbps, high, 30 MHz - 1 GHz Remark: Measurement Method: Conducted	S01_354_AB01	2022-09-14	Passed	Passed
Bluetooth LE 1 Mbps, low, 1 GHz - 26 GHz Remark: Measurement Method: Conducted	S01_354_AA01	2022-08-15	Passed	Passed
Bluetooth LE 1 Mbps, low, 30 MHz - 1 GHz Remark: Measurement Method: Conducted	S01_354_AB01	2022-09-14	Passed	Passed
Bluetooth LE 1 Mbps, mid, 1 GHz - 26 GHz Remark: Measurement Method: Conducted	S01_354_AA01	2022-08-15	Passed	Passed
Bluetooth LE 1 Mbps, mid, 30 MHz - 1 GHz Remark: Measurement Method: Conducted	S01_354_AB01	2022-09-14	Passed	Passed
Bluetooth LE 1 Mbps, mid, 9 kHz - 30 MHz Remark: Measurement Method: Conducted	S01_354_AA01	2022-08-15	Passed	Passed
Bluetooth LE 2 Mbps, high, 1 GHz - 26 GHz Remark: Measurement Method: Conducted	S01_354_AA01	2022-08-15	Passed	Passed
Bluetooth LE 2 Mbps, high, 30 MHz - 1 GHz Remark: Measurement Method: Conducted	S01_354_AB01	2022-09-14	Passed	Passed
Bluetooth LE 2 Mbps, low, 1 GHz - 26 GHz Remark: Measurement Method: Conducted	S01_354_AA01	2022-08-15	Passed	Passed
Bluetooth LE 2 Mbps, low, 30 MHz - 1 GHz Remark: Measurement Method: Conducted	S01_354_AB01	2022-09-14	Passed	Passed
Bluetooth LE 2 Mbps, mid, 1 GHz - 26 GHz Remark: Measurement Method: Conducted	S01_354_AA01	2022-08-15	Passed	Passed
Bluetooth LE 2 Mbps, mid, 30 MHz - 1 GHz Remark: Measurement Method: Conducted	S01_354_AB01	2022-09-14	Passed	Passed
Bluetooth LE 2 Mbps, mid, 9 kHz - 30 MHz Remark: Measurement Method: Conducted	S01_354_AA01	2022-08-15	Passed	Passed

47 CFR CHAPTER I FCC PART 15
Subpart C §15.247

§ 15.247 (d)

Transmitter Spurious Radiated Emissions

The measurement was performed according to ANSI C63.10
6.4, 6.5, 6.6.5

Final Result

OP-Mode	Setup	Date	FCC	IC
Radio Technology, Operating Frequency, Measurement range				
WLAN b, high, 1 GHz - 26 GHz Remark: Measurement Method: Conducted	S01_354_AA01	2022-08-15	Passed	Passed
WLAN b, high, 30 MHz - 1 GHz Remark: Measurement Method: Conducted	S01_354_AA01	2022-09-19	Passed	Passed
WLAN b, high, 30 MHz - 1 GHz Remark: Measurement Method: Radiated	S02_354_AB01	2022-07-28	Passed	Passed
WLAN b, low, 1 GHz - 26 GHz Remark: Measurement Method: Conducted	S01_354_AA01	2022-08-15	Passed	Passed
WLAN b, low, 30 MHz - 1 GHz Remark: Measurement Method: Conducted	S01_354_AA01	2022-09-19	Passed	Passed
WLAN b, low, 30 MHz - 1 GHz Remark: Measurement Method: Radiated	S02_354_AB01	2022-07-28	Passed	Passed
WLAN b, mid, 1 GHz - 26 GHz Remark: Measurement Method: Conducted	S01_354_AA01	2022-08-15	Passed	Passed
WLAN b, mid, 30 MHz - 1 GHz Remark: Measurement Method: Conducted	S01_354_AA01	2022-09-19	Passed	Passed
WLAN b, mid, 30 MHz - 1 GHz Remark: Measurement Method: Radiated	S02_354_AB01	2022-07-28	Passed	Passed
WLAN b, mid, 9 kHz - 30 MHz Remark: Measurement Method: Conducted	S01_354_AA01	2022-08-15	Passed	Passed
WLAN b, mid, 9 kHz - 30 MHz Remark: Measurement Method: Radiated	S02_354_AB01	2022-07-28	Passed	Passed

47 CFR CHAPTER I FCC PART 15
Subpart C §15.247

§ 15.247 (d)

Band Edge Compliance Conducted

The measurement was performed according to ANSI C63.10 11.11

Final Result

OP-Mode	Setup	Date	FCC	IC
Radio Technology, Operating Frequency, Band Edge				
Bluetooth BDR, high, high	S01_354_AB01	2022-07-29	Passed	Passed
Bluetooth BDR, hopping, high	S01_354_AB01	2022-07-29	Passed	Passed
Bluetooth BDR, hopping, low	S01_354_AB01	2022-07-29	Passed	Passed
Bluetooth BDR, low, low	S01_354_AB01	2022-07-29	Passed	Passed
Bluetooth EDR 2, high, high	S01_354_AB01	2022-07-29	Passed	Passed
Bluetooth EDR 2, hopping, high	S01_354_AB01	2022-07-29	Passed	Passed
Bluetooth EDR 2, hopping, low	S01_354_AB01	2022-07-29	Passed	Passed
Bluetooth EDR 2, low, low	S01_354_AB01	2022-07-29	Passed	Passed
Bluetooth EDR 3, high, high	S01_354_AB01	2022-07-29	Passed	Passed
Bluetooth EDR 3, hopping, high	S01_354_AB01	2022-07-29	Passed	Passed
Bluetooth EDR 3, hopping, low	S01_354_AB01	2022-07-29	Passed	Passed
Bluetooth EDR 3, low, low	S01_354_AB01	2022-07-29	Passed	Passed
Bluetooth LE 1 Mbps, high, high	S01_354_AB01	2022-07-29	Passed	Passed
Bluetooth LE 1 Mbps, low, low	S01_354_AB01	2022-07-29	Passed	Passed

47 CFR CHAPTER I FCC PART 15
Subpart C §15.247

§ 15.247 (d)

Band Edge Compliance Conducted

The measurement was performed according to ANSI C63.10 11.11

Final Result

OP-Mode Radio Technology, Operating Frequency, Band Edge	Setup	Date	FCC	IC
Bluetooth LE 2 Mbps, high, high	S01_354_AB01	2022-07-29	Passed	Passed
Bluetooth LE 2 Mbps, low, low	S01_354_AB01	2022-07-29	Passed	Passed

47 CFR CHAPTER I FCC PART 15
Subpart C §15.247

§ 15.247 (d)

Band Edge Compliance Radiated

The measurement was performed according to ANSI C63.10 6.6.5

Final Result

OP-Mode Radio Technology, Operating Frequency, Band Edge	Setup	Date	FCC	IC
Bluetooth BDR, high, high Remark: Measurement Method: Radiated	S02_354_AB01	2022-08-11	Passed	Passed
Bluetooth BDR, high, high Remark: Measurement Method: Conducted	S01_354_AA01	2022-08-12	Passed	Passed
Bluetooth BDR, low, low Remark: Measurement Method: Conducted	S01_354_AA01	2022-08-12	Passed	Passed
Bluetooth EDR 2, high, high Remark: Measurement Method: Conducted	S01_354_AA01	2022-08-12	Passed	Passed
Bluetooth EDR 2, low, low Remark: Measurement Method: Conducted	S01_354_AA01	2022-08-12	Passed	Passed
Bluetooth EDR 3, high, high Remark: Measurement Method: Conducted	S01_354_AA01	2022-08-12	Passed	Passed
Bluetooth EDR 3, low, low Remark: Measurement Method: Conducted	S01_354_AA01	2022-08-12	Passed	Passed
Bluetooth LE 1 Mbps, high, high Remark: Measurement Method: Radiated	S02_354_AB01	2022-08-11	Passed	Passed
Bluetooth LE 1 Mbps, high, high Remark: Measurement Method: Conducted	S01_354_AA01	2022-08-11	Passed	Passed
Bluetooth LE 1 Mbps, low, low Remark: Measurement Method: Conducted	S01_354_AA01	2022-08-11	Passed	Passed
Bluetooth LE 2 Mbps, high, high Remark: Measurement Method: Conducted	S01_354_AA01	2022-08-11	Passed	Passed
Bluetooth LE 2 Mbps, low, low Remark: Measurement Method: Conducted	S01_354_AA01	2022-08-11	Passed	Passed
WLAN ax 20 MHz, high, high Remark: Measurement Method: Conducted	S01_354_AB01	2022-09-14	Passed	Passed
WLAN ax 20 MHz, low, low Remark: Measurement Method: Conducted	S01_354_AB01	2022-09-14	Passed	Passed
WLAN ax 40 MHz, high, high Remark: Measurement Method: Conducted	S01_354_AB01	2022-09-14	Passed	Passed
WLAN b, high, high Remark: Measurement Method: Radiated	S02_354_AB01	2022-07-27	Passed	Passed

47 CFR CHAPTER I FCC PART 15
Subpart C §15.247

§ 15.247 (d)

Band Edge Compliance Radiated

The measurement was performed according to ANSI C63.10 6.6.5

Final Result

OP-Mode	Setup	Date	FCC	IC
Radio Technology, Operating Frequency, Band Edge				
WLAN b, high, high Remark: Measurement Method: Conducted	S01_354_AA01	2022-08-11	Passed	Passed
WLAN b, low, low Remark: Measurement Method: Conducted	S01_354_AA01	2022-08-11	Passed	Passed
WLAN g, high, high Remark: Measurement Method: Radiated	S02_354_AB01	2022-08-05	Passed	Passed
WLAN g, high, high Remark: Measurement Method: Conducted	S01_354_AB01	2022-09-14	Passed	Passed
WLAN n 20 MHz, high, high Remark: Measurement Method: Radiated	S02_354_AB01	2022-08-05	Passed	Passed
WLAN n 20 MHz, high, high Remark: Measurement Method: Conducted	S01_354_AB01	2022-09-14	Passed	Passed
WLAN n 40 MHz, high, high Remark: Measurement Method: Radiated	S02_354_AB01	2022-08-05	Passed	Passed
WLAN n 40 MHz, high, high Remark: Measurement Method: Conducted	S01_354_AB01	2022-09-14	Passed	Passed

47 CFR CHAPTER I FCC PART 15
Subpart C §15.247

§ 15.247 (e)

Power Density

The measurement was performed according to ANSI C63.10 11.10.2, 11.10.7

Final Result

OP-Mode	Setup	Date	FCC	IC
Radio Technology, Operating Frequency				
Bluetooth LE 1 Mbps, high	S01_354_AA01	2022-07-29	Passed	Passed
Bluetooth LE 1 Mbps, low	S01_354_AA01	2022-07-29	Passed	Passed
Bluetooth LE 1 Mbps, mid	S01_354_AA01	2022-07-29	Passed	Passed
Bluetooth LE 2 Mbps, high	S01_354_AA01	2022-07-29	Passed	Passed
Bluetooth LE 2 Mbps, low	S01_354_AA01	2022-07-29	Passed	Passed
Bluetooth LE 2 Mbps, mid	S01_354_AA01	2022-07-29	Passed	Passed

N/A: Not applicable
N/P: Not performed

2 REVISION HISTORY / SIGNATURES

Report version control			
Version	Release date	Change Description	Version validity
initial	2022-11-22	--	valid
--	--	--	--

COMMENT: On demand of the applicant BT Classic was tested as DTS device.
 According to the applicant the WLAN part of the JODY-W377 is identical to the
 WLAN part of the JODY-W377 and the Bluetooth part is identical to JODY-W374.
 Due to this not all tests have been performed for JODY-W354.
 Report Reference JODY-W374/W377: MDE_UBLOX_2030_FCC_01



(responsible for accreditation scope)
 Dipl.-Ing. Daniel Gall



(responsible for testing and report)
 B.Sc. Jens Dörwald



7 layers GmbH, Borsigstr. 11
 40880 Ratingen, Germany
 Phone +49 (0)2102 749 0

3 ADMINISTRATIVE DATA

3.1 TESTING LABORATORY

Company Name: 7layers GmbH
Address: Borsigstr. 11
40880 Ratingen
Germany

The test facility is accredited by the following accreditation organisation:

Laboratory accreditation no: DAKKS D-PL-12140-01-01 | -02 | -03
FCC Designation Number: DE0015
FCC Test Firm Registration: 929146
ISED CAB Identifier DE0007; ISED#: 3699A

Responsible for accreditation scope: Dipl.-Ing. Daniel Gall

Report Template Version: 2021-09-09

3.2 PROJECT DATA

Responsible for testing and report: B.Sc. Jens Dörwald
Employees who performed the tests: documented internally at 7Layers
Date of Report: 2022-11-22
Testing Period: 2022-07-27 to 2022-09-19

3.3 APPLICANT DATA

Company Name: u-blox AG
Address: Zürcherstrasse 68
8800 Thalwil
Switzerland
Contact Person: Filip Kruzela

3.4 MANUFACTURER DATA

Company Name: please see Applicant Data

Address:

Contact Person:

4 TEST OBJECT DATA

4.1 GENERAL EUT DESCRIPTION

Kind of Device product description	Host-based module with WLAN and Bluetooth technology.																																																																																																																																														
Product name	JODY-W3																																																																																																																																														
Type	JODY-W354-00A																																																																																																																																														
Declared EUT data by the supplier																																																																																																																																															
Voltage Type	DC																																																																																																																																														
Voltage Level	1.8 V + 3.3 V																																																																																																																																														
Antenna / Gain	External / 2 dBi (No antennas were provided for the tests, radiated measurements were performed with 50 Ohm terminations)																																																																																																																																														
Tested Modulation Type	BT Classic: GFSK (BDR), Pi/4 DQPSK (EDR 2), 8DPSK (EDR 3) BT LE: GFSK WLANb: DSSS WLANg/n/ax: OFDM																																																																																																																																														
Specific product description for the EUT	The EUT is a Bluetooth and WLAN module. Supported technologies are Bluetooth Classic, Bluetooth Low Energy and WLAN b, g, n, ax 20 and 40 MHz bandwidth. ax Mode MU-OFDMA is supported.																																																																																																																																														
EUT ports (connected cables during testing):	Enclosure Data DC Antenna The EUT is a module with solder pads for surface mounting, so no cables were connected to the EUT itself.																																																																																																																																														
Tested datarates	BT Classic: 1 (BDR), 2 (EDR 2) and 3 Mbps (EDR 3) BT LE: 1 and 2 Mbps WLAN b: 1 Mbps, g: 6 Mbps, n: MCS 0 SISO / MSC8 MIMO, ax: MSC 0																																																																																																																																														
Special software used for testing	Labtool 2.0.0.85-17.80.200.p204 on computer board provided by applicant.																																																																																																																																														
Used output power	BT Classic: max. power in BT Device Under Test Mode BT LE: 10 dBm WLAN: <table border="1" data-bbox="539 1753 1449 2033"> <thead> <tr> <th colspan="2"></th> <th colspan="10">2.4-GHz</th> </tr> <tr> <th>Mode</th> <th>Ch.1</th> <th>Ch.2</th> <th>Ch.3</th> <th>Ch.4</th> <th>Ch.5</th> <th>Ch.6</th> <th>Ch.7</th> <th>Ch.8</th> <th>Ch.9</th> <th>Ch.10</th> <th>Ch.11</th> </tr> </thead> <tbody> <tr> <td>b</td> <td>19</td> <td colspan="10">21</td> </tr> <tr> <td>q</td> <td>14</td> <td>16</td> <td>17</td> <td colspan="4">18</td> <td>17</td> <td>15</td> <td>13</td> </tr> <tr> <td>n20</td> <td>14</td> <td>15</td> <td>16</td> <td colspan="4">17</td> <td>16</td> <td>14</td> <td>13</td> </tr> <tr> <td>n20-MIMO</td> <td>13</td> <td>14</td> <td colspan="8">15</td> <td>13</td> <td>12</td> </tr> <tr> <td>n40</td> <td>N/A</td> <td>N/A</td> <td colspan="6">13</td> <td>12</td> <td>N/A</td> <td>N/A</td> </tr> <tr> <td>n40-MIMO</td> <td>N/A</td> <td>N/A</td> <td colspan="6">12</td> <td>11</td> <td>N/A</td> <td>N/A</td> </tr> <tr> <td>ax20</td> <td>13</td> <td>15</td> <td>15</td> <td>16</td> <td colspan="3">17</td> <td>16</td> <td>14</td> <td>12</td> </tr> <tr> <td>ax20-MIMO</td> <td>12</td> <td>13</td> <td>14</td> <td>15</td> <td colspan="4">16</td> <td>14</td> <td>13</td> <td>11</td> </tr> <tr> <td>ax40</td> <td>N/A</td> <td>N/A</td> <td colspan="4">13</td> <td colspan="3">12</td> <td>N/A</td> <td>N/A</td> </tr> <tr> <td>ax40-MIMO</td> <td>N/A</td> <td>N/A</td> <td colspan="4">12</td> <td colspan="3">11</td> <td>N/A</td> <td>N/A</td> </tr> </tbody> </table>			2.4-GHz										Mode	Ch.1	Ch.2	Ch.3	Ch.4	Ch.5	Ch.6	Ch.7	Ch.8	Ch.9	Ch.10	Ch.11	b	19	21										q	14	16	17	18				17	15	13	n20	14	15	16	17				16	14	13	n20-MIMO	13	14	15								13	12	n40	N/A	N/A	13						12	N/A	N/A	n40-MIMO	N/A	N/A	12						11	N/A	N/A	ax20	13	15	15	16	17			16	14	12	ax20-MIMO	12	13	14	15	16				14	13	11	ax40	N/A	N/A	13				12			N/A	N/A	ax40-MIMO	N/A	N/A	12				11			N/A	N/A
		2.4-GHz																																																																																																																																													
Mode	Ch.1	Ch.2	Ch.3	Ch.4	Ch.5	Ch.6	Ch.7	Ch.8	Ch.9	Ch.10	Ch.11																																																																																																																																				
b	19	21																																																																																																																																													
q	14	16	17	18				17	15	13																																																																																																																																					
n20	14	15	16	17				16	14	13																																																																																																																																					
n20-MIMO	13	14	15								13	12																																																																																																																																			
n40	N/A	N/A	13						12	N/A	N/A																																																																																																																																				
n40-MIMO	N/A	N/A	12						11	N/A	N/A																																																																																																																																				
ax20	13	15	15	16	17			16	14	12																																																																																																																																					
ax20-MIMO	12	13	14	15	16				14	13	11																																																																																																																																				
ax40	N/A	N/A	13				12			N/A	N/A																																																																																																																																				
ax40-MIMO	N/A	N/A	12				11			N/A	N/A																																																																																																																																				

4.2 EUT MAIN COMPONENTS

Sample Name	Sample Code	Description
EUT 354 aa01	DE1015166aa01	JODY-W354 Sample
Sample Parameter	Value	
Serial No.	AH36009C38105580500	
HW Version	05	
SW Version	FW: 2.0.0.86-17.80.200.p207	
Comment	-	

Sample Name	Sample Code	Description
EUT 354 ab01	DE1015166ab01	JODY-W354 Sample
Sample Parameter	Value	
Serial No.	AH36009C38102B40500	
HW Version	05	
SW Version	FW: 2.0.0.86-17.80.200.p207	
Comment	-	

NOTE: The short description is used to simplify the identification of the EUT in this test report.

4.3 ANCILLARY EQUIPMENT

For the purposes of this test report, ancillary equipment is defined as equipment which is used in conjunction with the EUT to provide operational and control features to the EUT. It is necessary to configure the system in a typical fashion, as a customer would normally use it. But nevertheless Ancillary Equipment can influence the test results.

Device	Details (Manufacturer, Type Model, OUT Code)	Description
-	-	-

4.4 AUXILIARY EQUIPMENT

For the purposes of this test report, auxiliary equipment is defined as equipment which is used temporarily to enable operational and control features especially used for the tests of the EUT which is not used during normal operation or equipment that is used during the tests in combination with the EUT but is not subject of this test report. It is necessary to configure the system in a typical fashion, as a customer would normally use it. But nevertheless Auxiliary Equipment can influence the test results.

Device	Details (Manufacturer, Type Model, HW, SW, S/N)	Description
AUX2	UBLOX, JODY-Carrier Board, REV C, - , 10000001898798019001	Supply and Port connector board
AUX21	Toradex, Ixora, V 1.2, apalis-tk1-mainline_2022-01-12, Kernel: 4.14.90, -	Board Computer for setting modes
AUX4	UBLOX, JODY-Carrier Board, REV C, - , 10000001898798014001	Supply and Port connector board
ACDC1	Agilent, E3631A, -, -, MY40018563	120 V 60 Hz AC laboratory power supply

4.5 EUT SETUPS

This chapter describes the combination of EUTs and equipment used for testing. The rationale for selecting the EUTs, ancillary and auxiliary equipment and interconnecting cables, is to test a representative configuration meeting the requirements of the referenced standards.

Setup	Combination of EUTs	Description and Rationale
S03_354_AB01	EUT 354 ab01, AUX4, ACDC1	AC Conducted Setup
S01_354_AA01	EUT 354 aa01, AUX2, AUX21	Conducted Setup
S02_354_AB01	EUT 354 ab01, AUX4,	Radiated Setup
S01_354_AB01	EUT 354 ab01, AUX4, AUX21	Conducted Setup

4.6 OPERATING MODES / TEST CHANNELS

This chapter describes the operating modes of the EUTs used for testing.

WLAN

20 MHz Test Channels:
Channel:
Frequency [MHz]

2.4 GHz ISM 2400 - 2483.5 MHz		
low	mid	high
1	6	11
2412	2437	2462

40 MHz Test Channels:
Channel:
Frequency [MHz]

low	mid	high
3	6	9
2422	2437	2452

BT Test Channels:
Channel:
Frequency [MHz]

2.4 GHz ISM 2400 - 2483.5 MHz		
low	mid	high
0	39	78
2402	2441	2480

BT LE Test Channels:
Channel:
Frequency [MHz]

2.4 GHz ISM 2400 - 2483.5 MHz		
low	mid	high
0	19	39
2402	2440	2480

Duty Cycle:

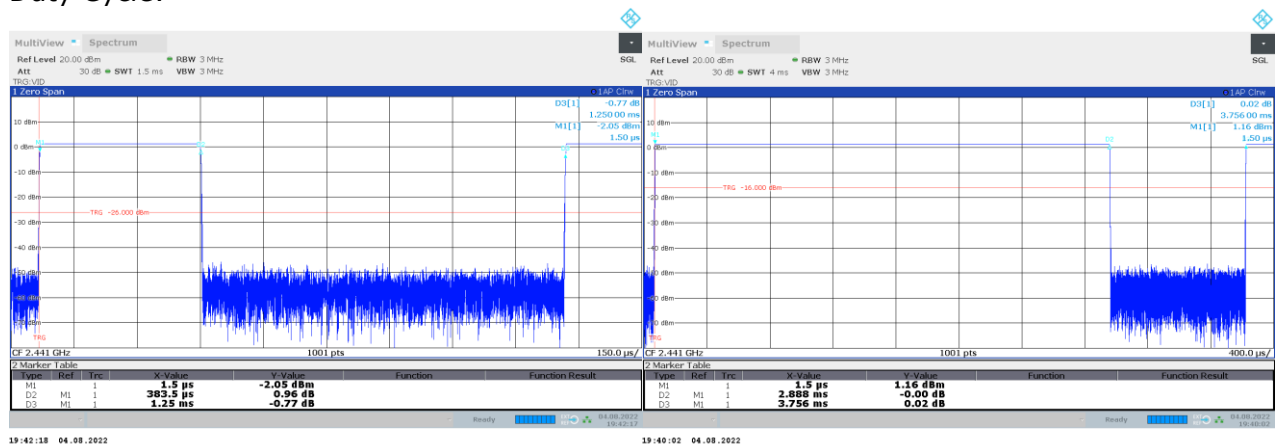

BT Classic x-DH1 packets

BT Classic x-DH5 packets

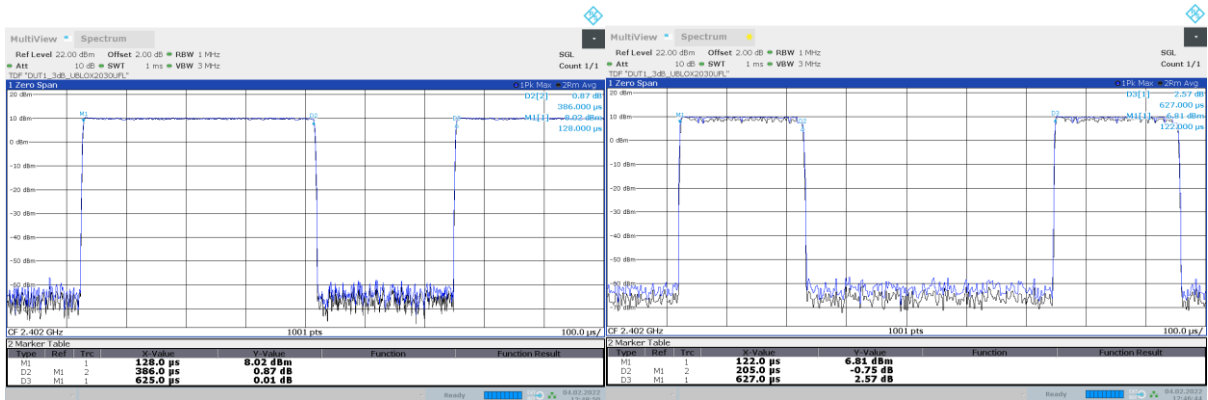

BT LE 1 Mbps

BT LE 2 Mbps

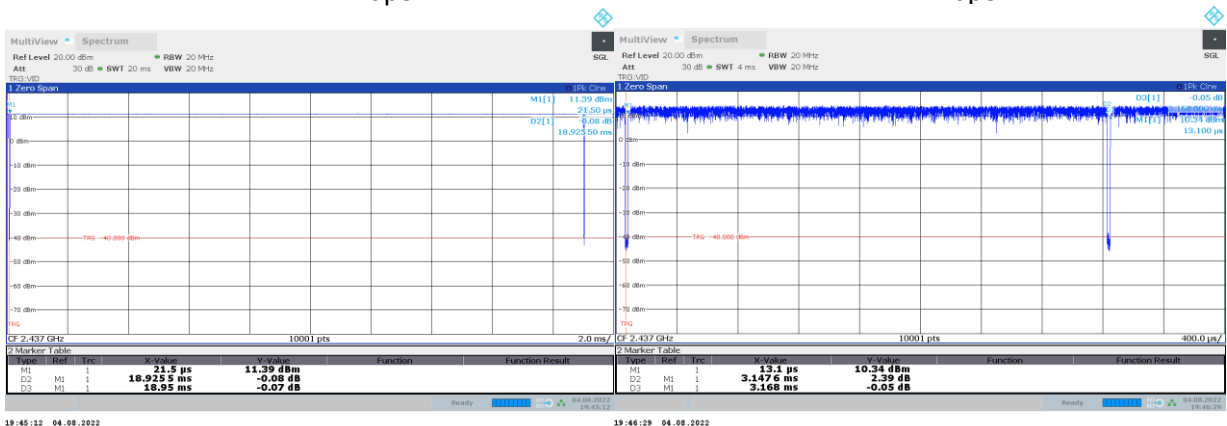

WLAN b 1Mbps

WLAN g 6 Mbps

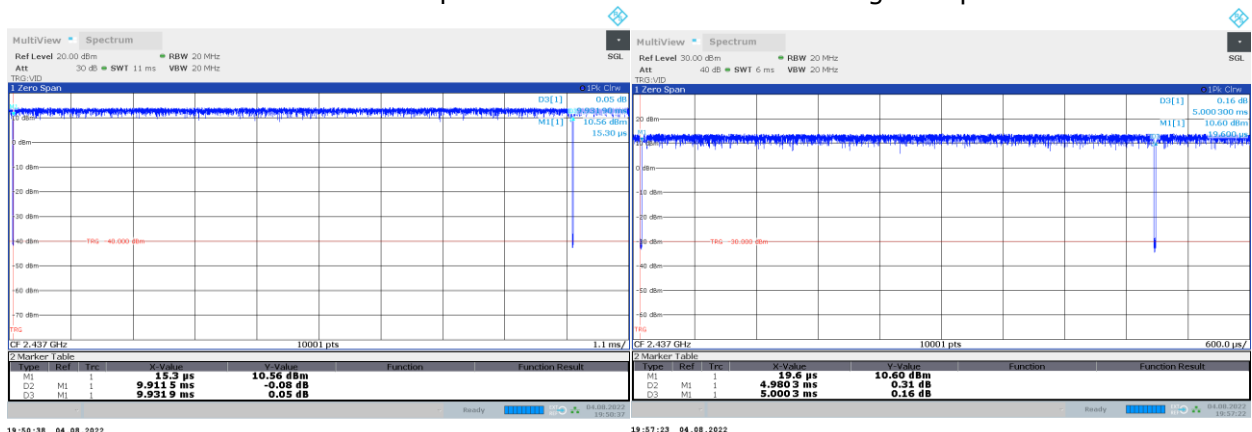

WLAN n20 MCS 0 (SISO)

WLAN n20 MCS 8 (MIMO)

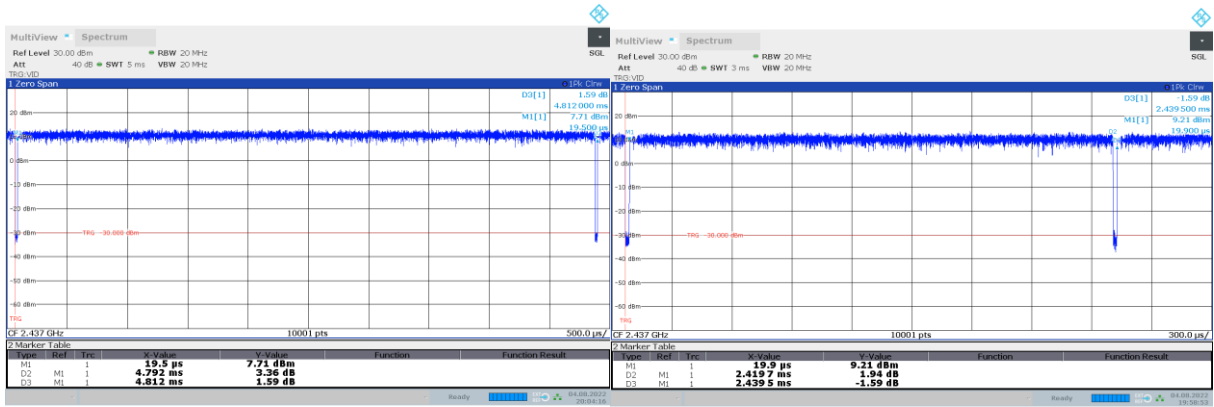

WLAN n40 MCS 0 (SISO)

WLAN n40 MCS 8 (MIMO)

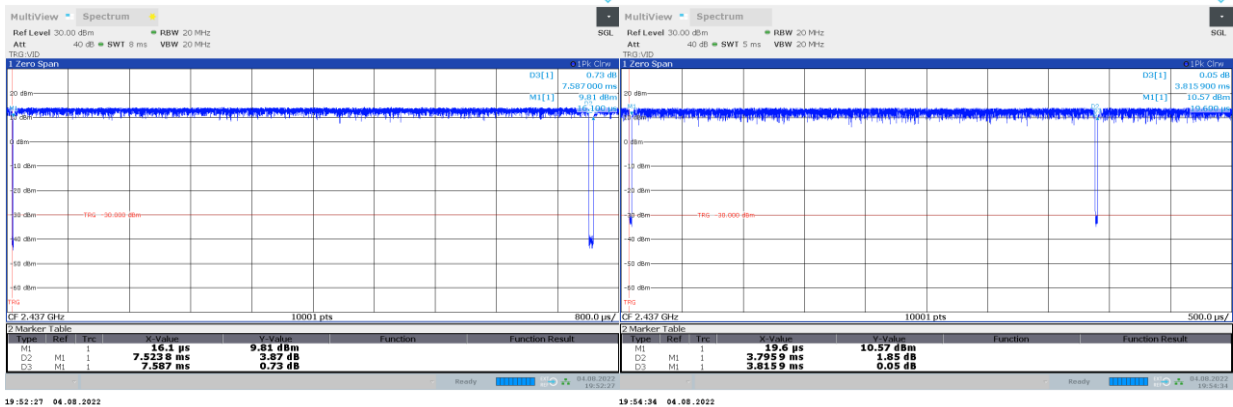

WLAN ax20 MCS 0 (SISO)

WLAN ax20 MCS 0 (MIMO)

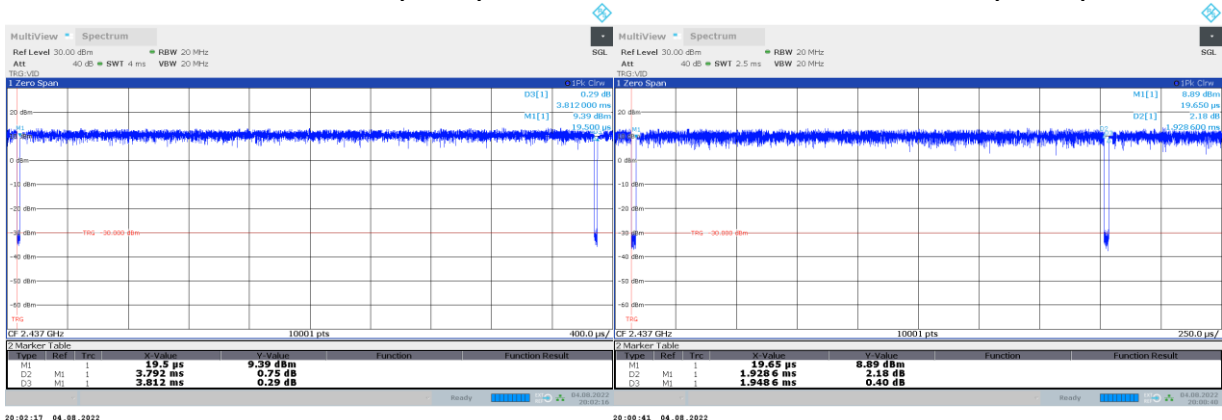

WLAN ax40 MCS 0 (SISO)

WLAN ax40 MCS 0 (MIMO)

Mode	Duty Cycle	Resulting Correction AV spurious emissions [dB]
BT Classic (x-DH1)	30.6	10.3
BT Classic (x-DH5)	76.9	2.3
BT LE 1 Mbps	61.8	4.2
BT LE 2 Mbps	32.7	9.7
WLAN b-Mode; 20 MHz; 1 Mbit/s	99.9	0.0
WLAN g-Mode; 20 MHz; 6 Mbit/s	99.4	0.1
WLAN n-Mode; 20 MHz; MCS0	99.8	0.0
WLAN n-Mode; 40 MHz; MCS0	99.6	0.0
WLAN n-Mode; 20 MHz; MCS0; MIMO	99.6	0.0
WLAN n-Mode; 40 MHz; MCS0; MIMO	99.2	0.1
WLAN ax-Mode; 20 MHz; MCS0	99.2	0.1
WLAN ax-Mode; 40 MHz; MCS0	99.5	0.0
WLAN ax-Mode; 20 MHz; MCS0; MIMO	99.5	0.0
WLAN ax-Mode; 40 MHz; MCS0; MIMO	99.0	0.1

4.7 PRODUCT LABELLING

4.7.1 FCC ID LABEL

Please refer to the documentation of the applicant.

4.7.2 LOCATION OF THE LABEL ON THE EUT

Please refer to the documentation of the applicant.

5 TEST RESULTS

5.1 CONDUCTED EMISSIONS AT AC MAINS

Standard **FCC Part 15 Subpart C**

The test was performed according to:
ANSI C63.10 6.2

5.1.1 TEST DESCRIPTION

The test set-up was made in accordance to the general provisions of ANSI C 63.10. The Equipment Under Test (EUT) was setup in a shielded room to perform the conducted emissions measurements in a typical installation configuration. The EUT was powered from 50 μ H || 50 Ohm Line Impedance Stabilization Network (LISN). The LISN's unused connections were terminated with 50 Ohm loads.

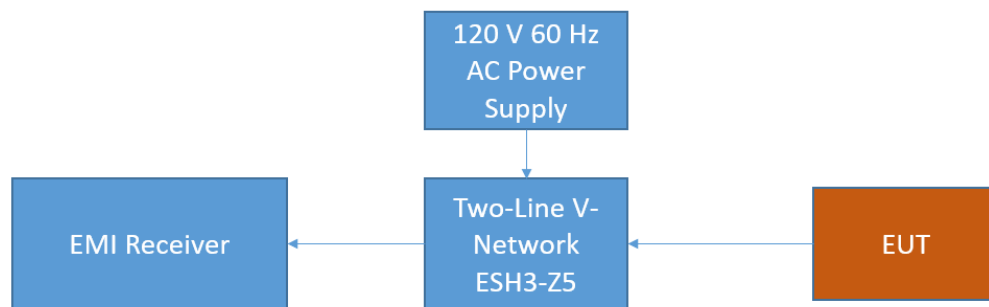

FCC Conducted Emissions on AC

The measurement procedure consists of two steps. It is implemented into the EMI test software EMC-32 from R&S.

Step 1: Preliminary scan

Intention of this step is, to determine the conducted EMI-profile of the EUT.

EMI receiver settings:

- Detector: Peak – Maxhold & Average
- Frequency range: 150 kHz – 30 MHz
- Frequency steps: 2.5 kHz
- IF-Bandwidth: 9 kHz
- Measuring time / Frequency step: 100 ms (FFT-based)
- Measurement on phase + neutral lines of the power cords

On basis of this preliminary scan the highest amplitudes and the corresponding frequencies relative to the limit are identified. Emissions above the limit and emissions which are in the 10 dB range below the limit are considered.

Step 2: Final measurement

Intention of this step is, to determine the highest emissions with the settings defined in the test specification for the frequencies identified in step 1.

EMI receiver settings:

- Detector: Quasi-Peak & (CISPR) Average

- IF Bandwidth: 9 kHz
- Measuring time: 1 s / frequency

At each frequency determined in step 1, four measurements are performed in the following combinations:

- 1) Neutral lead - reference ground (PE grounded)
- 2) Phase lead - reference ground (PE grounded)
- 3) Neutral lead - reference ground (PE floating)
- 4) Phase lead - reference ground (PE floating)

The highest value is reported.

5.1.2 TEST REQUIREMENTS / LIMITS

FCC Part 15, Subpart C, §15.207

Frequency (MHz)	QP Limits (dB μ V)	AV Limits (dB μ V)
0.15 - 0.5	66 - 56	56 - 46
0.5 - 5	56	46
5 - 30	60	50

Used conversion factor: Limit (dB μ V) = 20 log (Limit (μ V)/1 μ V).

5.1.3 TEST PROTOCOL

Temperature: 25 °C
 Air Pressure: 1001 hPa
 Humidity: 45 %

BTTEST 1-DH5 CH39

Power line	PE	Frequency [MHz]	Measured value QP [dB μ V]	Measured value AV [dB μ V]	Limit [dB μ V]	Margin [dB]
N	GND	12.005	---	39.23	50	10.77
N	GND	12.005	43.05	---	60	16.95
L1	GND	20.830	40.33	---	60	19.67
N	GND	21.183	40.41	---	60	19.59
N	GND	24.009	---	44.36	50	5.64
N	GND	24.009	49.35	---	60	10.65

WLAN 2.4 B-Mode CH6 1Mbps

Power line	PE	Frequency [MHz]	Measured value QP [dB μ V]	Measured value AV [dB μ V]	Limit [dB μ V]	Margin [dB]
N	GND	12.005	---	39.26	50	10.74
N	GND	12.005	43.06	---	60	16.94
N	GND	24.009	---	44.09	50	5.91
N	GND	24.009	49.09	---	60	10.91

Remark: Please see next sub-clause for the measurement plot.

5.1.4 MEASUREMENT PLOTS

Operating mode = worst case, Connection to AC mains = via ancillary/auxiliary equipment (S03_354_AB01)

Common Information

Test Description:	Conducted Emissions
Test Standard:	FCC §15.207, ANSI C63.10
EUT / Setup Code:	DE1015166ab01
Operating Conditions:	BTTEST 1-DH5 CH39
Legend:	Trace: blue = QP, green = CISPR AV; Star: red or blue = critical frequency; Rhombus: blue = final QP, green = final CISPR AV
Tested Port / used LISN:	AC mains => 1st LISN ESH3-Z5
Termination of other ports:	N/A

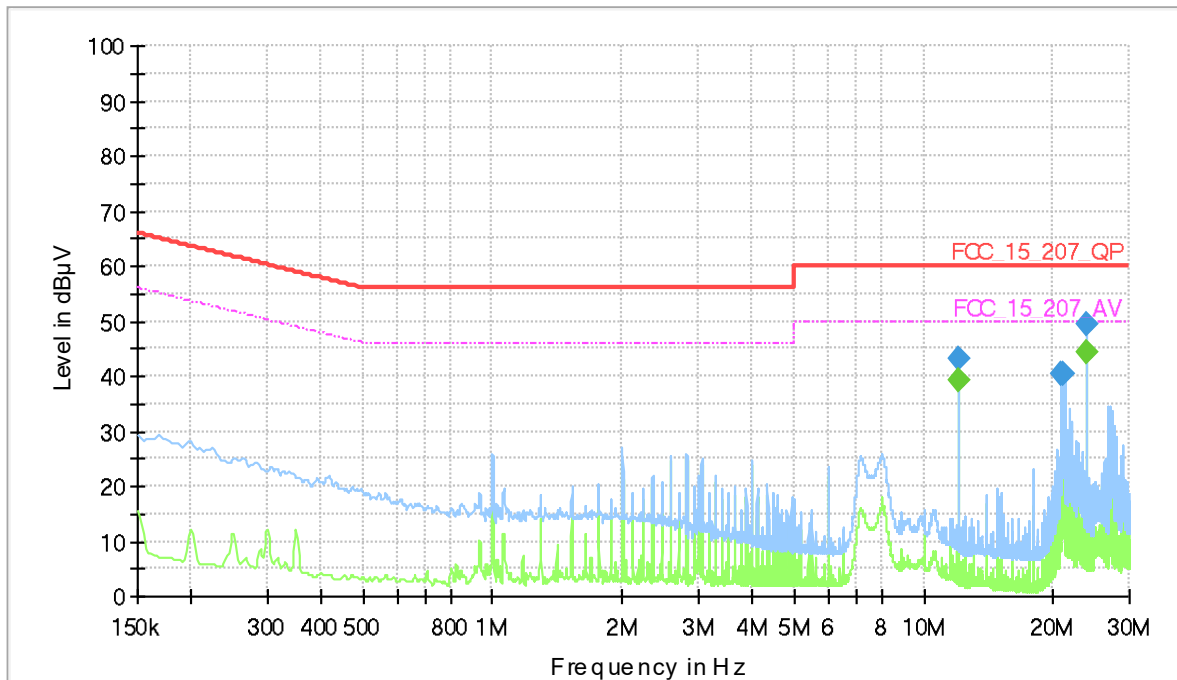

Final Result

Frequency (MHz)	QuasiPeak (dBµV)	CAverage (dBµV)	Limit (dBµV)	Margin (dB)	Meas. Time	Bandwidth (kHz)	Line	PE	Corr. (dB)
12.005250	---	39.23	50.00	10.77	1000.0	9.000	N	GND	10.7
12.005250	43.05	---	60.00	16.95	1000.0	9.000	N	GND	10.7
20.829750	40.33	---	60.00	19.67	1000.0	9.000	L1	GND	11.1
21.183000	40.41	---	60.00	19.59	1000.0	9.000	N	GND	11.1
24.009000	---	44.36	50.00	5.64	1000.0	9.000	N	GND	11.2
24.009000	49.35	---	60.00	10.65	1000.0	9.000	N	GND	11.2

Operating mode = worst case, Connection to AC mains = via ancillary/auxiliary equipment (S03_354_AB01)

Common Information

Test Description:	Conducted Emissions
Test Standard:	FCC §15.207, ANSI C63.10
EUT / Setup Code:	DE1015166ab01
Operating Conditions:	WLAN 2.4 B-Mode CH6 1Mbps
Legend:	Trace: blue = QP, green = CISPR AV; Star: red or blue = critical frequency; Rhombus: blue = final QP, green = final CISPR AV
Tested Port / used LISN:	AC mains => 1st LISN ESH3-Z5
Termination of other ports:	N/A

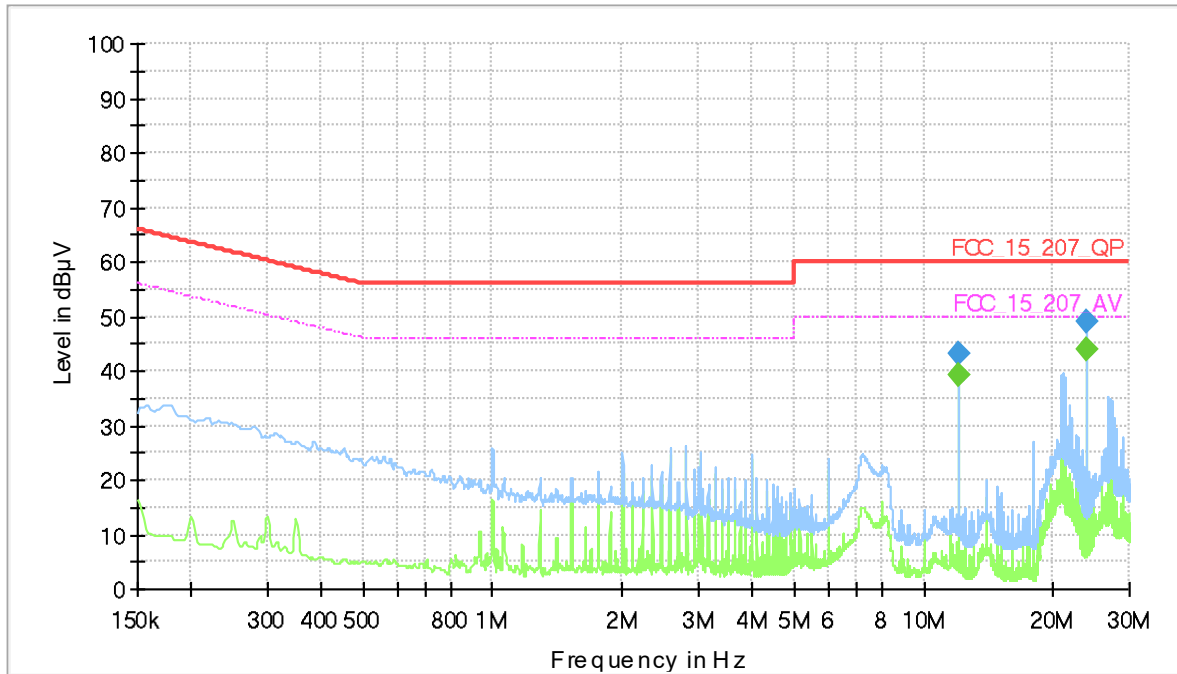

Final Result

Frequency (MHz)	QuasiPeak (dBµV)	CAverage (dBµV)	Limit (dBµV)	Margin (dB)	Meas. Time	Bandwidth (kHz)	Line	PE	Corr. (dB)
12.005250	---	39.26	50.00	10.74	1000.0	9.000	N	GND	10.7
12.005250	43.06	---	60.00	16.94	1000.0	9.000	N	GND	10.7
24.009000	---	44.09	50.00	5.91	1000.0	9.000	N	GND	11.2
24.009000	49.09	---	60.00	10.91	1000.0	9.000	N	GND	11.2

5.1.5 TEST EQUIPMENT USED

- Conducted Emissions FCC

5.2 OCCUPIED BANDWIDTH (6 DB)

Standard **FCC Part 15 Subpart C**

The test was performed according to:
ANSI C63.10 11.8.1

5.2.1 TEST DESCRIPTION

The Equipment Under Test (EUT) was set up to perform the occupied bandwidth measurements.

The reference level is the level of the highest amplitude signal observed from the transmitter at either the fundamental frequency or first-order modulation products in all typical modes of operation, including the unmodulated carrier, even if atypical.

The results recorded were measured with the modulation which produce the worst-case (smallest) emission bandwidth.

The EUT was connected to the test system as described in the block diagram below. The complete attenuation of the measurement path is known and considered.

Analyser settings:

- Resolution Bandwidth (RBW): 100 kHz
- Video Bandwidth (VBW): 300 kHz
- Span: Two times nominal bandwidth
- Trace: Maxhold
- Sweeps: Till stable (min. 500, max. 15000)
- Sweeptime: Auto
- Detector: Peak

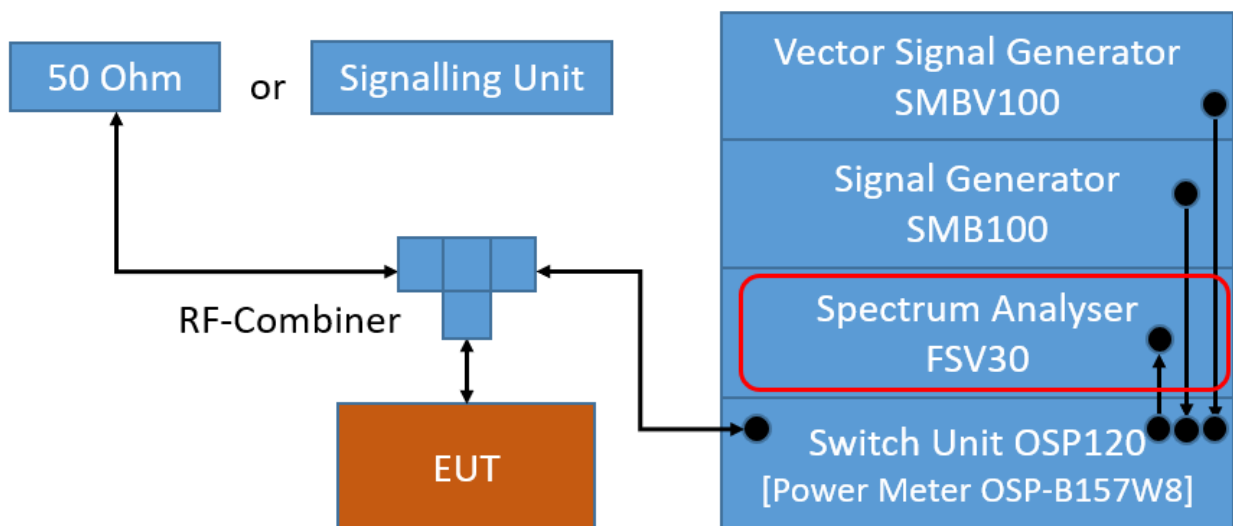

TS8997; Channel Bandwidth

5.2.2 TEST REQUIREMENTS / LIMITS

FCC Part 15, Subpart C, §15.247 (a) (2)

Systems using digital modulation techniques may operate in the 902-928 MHz and 2400-2483.5 MHz bands. The minimum 6 dB bandwidth shall be at least 500 kHz.

5.2.3 TEST PROTOCOL

Ambient temperature: 30 °C
 Air Pressure: 1005 hPa
 Humidity: 28 %

BT LE 1 Mbit/s

Variant	Channel No.	Frequency [MHz]	6 dB Bandwidth [MHz]	Limit [MHz]	Margin to Limit [MHz]
354-00	0	2402	0.792	0.5	0.292
354-00	19	2440	0.792	0.5	0.292
354-00	39	2480	0.792	0.5	0.292

BT LE 2 Mbit/s

Variant	Channel No.	Frequency [MHz]	6 dB Bandwidth [MHz]	Limit [MHz]	Margin to Limit [MHz]
354-00	0	2402	1.415	0.5	0.915
354-00	19	2440	1.467	0.5	0.967
354-00	39	2480	1.493	0.5	0.993

Remark: Please see next sub-clause for the measurement plot.

5.2.4 MEASUREMENT PLOTS (EXAMPLE PLOT, SHOWING WORST CASE, IF APPLICABLE)

Radio Technology = Bluetooth LE 1 Mbps, Operating Frequency = low (S01_354_AA01)

6 dB Bandwidth

DUT Frequency (MHz)	Bandwidth (MHz)	Limit Min (MHz)	Limit Max (MHz)	Band Edge Left (MHz)	Band Edge Right (MHz)	Max Level (dBm)	Result
2402.000000	0.792079	0.500000	---	2401.588119	2402.380198	6.5	PASS

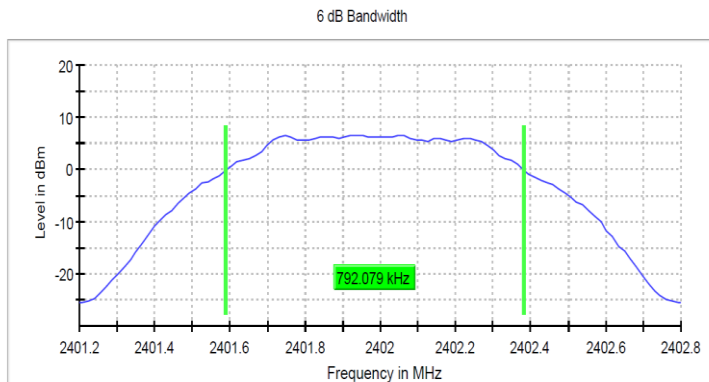

Measurement

Setting	Instrument Value
Start Frequency	2.40120 GHz
Stop Frequency	2.40280 GHz
Span	1.600 MHz
RBW	100.000 kHz
VBW	300.000 kHz
SweepPoints	101
Sweeptime	41.920 μ s
Reference Level	-10.000 dBm
Attenuation	0.000 dB
Detector	MaxPeak
SweepCount	100
Filter	3 dB
Trace Mode	Max Hold
Sweeptype	FFT
Preamp	off
Stablemode	Trace
Stablevalue	0.50 dB
Run	11 / max. 150
Stable	5 / 5
Max Stable Difference	0.22 dB

Radio Technology = Bluetooth LE 2 Mbps, Operating Frequency = low (S01_354_AA01)

6 dB Bandwidth

DUT Frequency (MHz)	Bandwidth (MHz)	Limit Min (MHz)	Limit Max (MHz)	Band Edge Left (MHz)	Band Edge Right (MHz)	Max Level (dBm)	Result
2402.000000	1.415842	0.500000	---	2401.279208	2402.695050	5.0	PASS

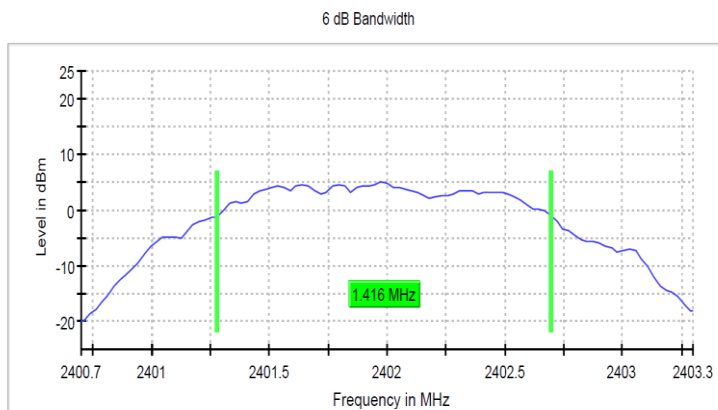

Measurement

Setting	Instrument Value
Start Frequency	2.40070 GHz
Stop Frequency	2.40330 GHz
Span	2.600 MHz
RBW	100.000 kHz
VBW	300.000 kHz
SweepPoints	101
Sweeptime	41.890 μ s
Reference Level	-10.000 dBm
Attenuation	0.000 dB
Detector	MaxPeak
SweepCount	100
Filter	3 dB
Trace Mode	Max Hold
Sweeptype	FFT
Preamp	off
Stablemode	Trace
Stablevalue	0.50 dB
Run	14 / max. 150
Stable	5 / 5
Max Stable Difference	0.04 dB

5.2.5 TEST EQUIPMENT USED

- R&S TS8997

5.3 OCCUPIED BANDWIDTH (99%)

Standard **FCC Part 15 Subpart C**

The test was performed according to:
ANSI C63.10 6.9.3

5.3.1 TEST DESCRIPTION

The Equipment Under Test (EUT) was set up to perform the occupied bandwidth measurements.

The reference level is the level of the highest amplitude signal observed from the transmitter at either the fundamental frequency or first-order modulation products in all typical modes of operation, including the unmodulated carrier, even if atypical.

The EUT was connected to the test system as described in the block diagram below. The complete attenuation of the measurement path is known and considered.

Analyser settings:

- Resolution Bandwidth (RBW): 1 to 5 % of the OBW
- Video Bandwidth (VBW): ≥ 3 times the RBW
- Span: 1.5 to 5 times the OBW
- Trace: Maxhold
- Sweeps: Till stable (min. 500, max. 75000)
- Sweep time: Auto
- Detector: Peak

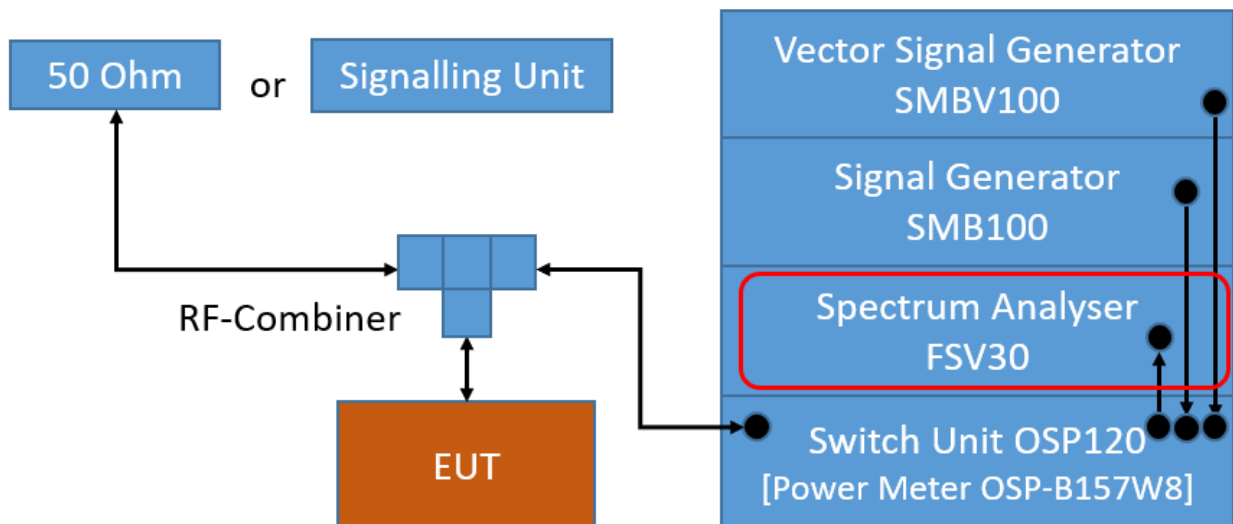

TS8997; Channel Bandwidth

5.3.2 TEST REQUIREMENTS / LIMITS

No applicable limit.

5.3.3 TEST PROTOCOL

Ambient temperature: 30 °C
 Air Pressure: 1005 hPa
 Humidity: 28 %

BT GFSK (1-DH1)

Variant	Channel No.	Frequency [MHz]	99 % Bandwidth [MHz]
354-00	0	2402	0.845
354-00	39	2441	0.845
354-00	78	2480	0.845

BT $\pi/4$ DQPSK (2-DH1)

Variant	Channel No.	Frequency [MHz]	99 % Bandwidth [MHz]
354-00	0	2402	1.155
354-00	39	2441	1.140
354-00	78	2480	1.140

BT 8-DPSK (3-DH1)

Variant	Channel No.	Frequency [MHz]	99 % Bandwidth [MHz]
354-00	0	2402	1.160
354-00	39	2441	1.115
354-00	78	2480	1.116

BT LE 1 Mbit/s

Variant	Channel No.	Frequency [MHz]	99 % Bandwidth [MHz]
354-00	0	2402	1.040
354-00	19	2440	1.040
354-00	39	2480	1.040

BT LE 2 Mbit/s

Variant	Channel No.	Frequency [MHz]	99 % Bandwidth [MHz]
354-00	0	2402	2.040
354-00	19	2440	2.040
354-00	39	2480	2.040

Remark: Please see next sub-clause for the measurement plot.

5.3.4 MEASUREMENT PLOT (EXAMPLE PLOT, SHOWING WORST CASE, IF APPLICABLE)

Radio Technology = Bluetooth BDR, Operating Frequency = mid (S01_354_AA01)

99 % Bandwidth

DUT Frequency (MHz)	Bandwidth (MHz)	Limit Min (MHz)	Limit Max (MHz)	Band Edge Left (MHz)	Band Edge Right (MHz)	Result
2441.000000	0.845000	---	---	2440.577500	2441.422500	PASS

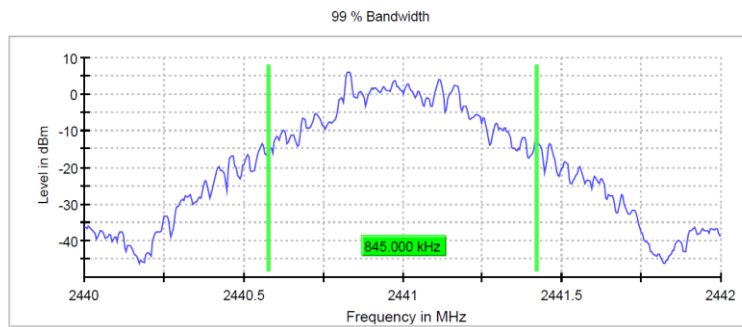

Measurement

Setting	Instrument Value
Start Frequency	2.44000 GHz
Stop Frequency	2.44200 GHz
Span	2.000 MHz
RBW	10.000 kHz
VBW	30.000 kHz
SweepPoints	400
SweepTime	419.000 μs
Reference Level	-10.000 dBm
Attenuation	0.000 dB
Detector	MaxPeak
SweepCount	500
Filter	3 dB
Trace Mode	Max Hold
SweepType	FFT
Preamp	off
Stablemode	Trace
Stablevalue	0.30 dB
Run	4 / max. 150
Stable	3 / 3
Max Stable Difference	0.10 dB

Radio Technology = Bluetooth EDR 2, Operating Frequency = mid (S01_354_AA01)

99 % Bandwidth

DUT Frequency (MHz)	Bandwidth (MHz)	Limit Min (MHz)	Limit Max (MHz)	Band Edge Left (MHz)	Band Edge Right (MHz)	Result
2441.000000	1.140000	---	---	2440.422500	2441.562500	PASS

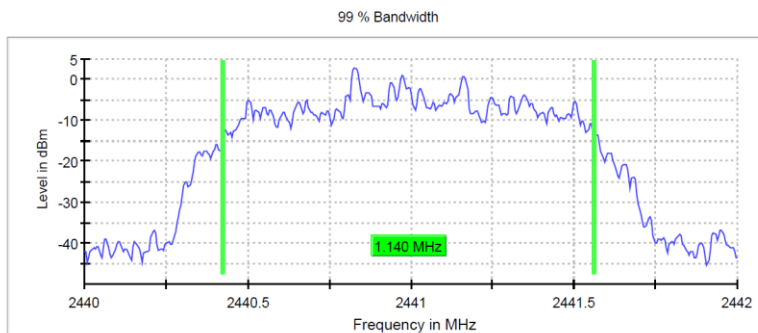

Measurement

Setting	Instrument Value
Start Frequency	2.44000 GHz
Stop Frequency	2.44200 GHz
Span	2.000 MHz
RBW	10.000 kHz
VBW	30.000 kHz
SweepPoints	400
SweepTime	419.000 μs
Reference Level	-10.000 dBm
Attenuation	0.000 dB
Detector	MaxPeak
SweepCount	500
Filter	3 dB
Trace Mode	Max Hold
SweepType	FFT
Preamp	off
Stablemode	Trace
Stablevalue	0.30 dB
Run	4 / max. 150
Stable	3 / 3
Max Stable Difference	0.09 dB

Radio Technology = Bluetooth EDR 3, Operating Frequency = mid
(S01_354_AA01)

99 % Bandwidth

DUT Frequency (MHz)	Bandwidth (MHz)	Limit Min (MHz)	Limit Max (MHz)	Band Edge Left (MHz)	Band Edge Right (MHz)	Result
2441.000000	1.155000	---	---	2440.427500	2441.582500	PASS

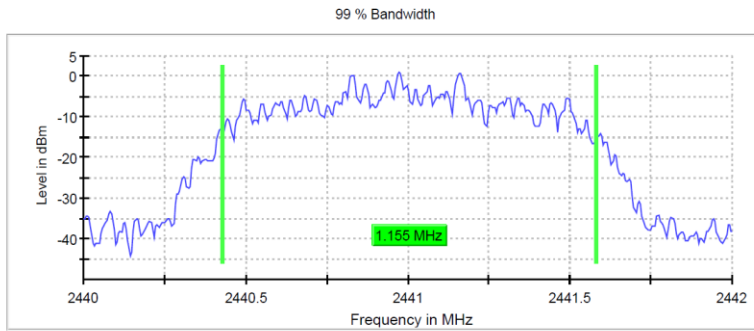

Measurement

Setting	Instrument Value
Start Frequency	2.44000 GHz
Stop Frequency	2.44200 GHz
Span	2.000 MHz
RBW	10.000 kHz
VBW	30.000 kHz
SweepPoints	400
SweepTime	419.000 μs
Reference Level	-10.000 dBm
Attenuation	0.000 dB
Detector	MaxPeak
SweepCount	500
Filter	3 dB
Trace Mode	Max Hold
SweepType	FFT
Preamp	off
Stablemode	Trace
Stablevalue	0.30 dB
Run	5 / max. 150
Stable	3 / 3
Max Stable Difference	0.12 dB

Radio Technology = Bluetooth LE 1 Mbps, Operating Frequency = mid
(S01_354_AA01)

99 % Bandwidth

DUT Frequency (MHz)	Bandwidth (MHz)	Limit Min (MHz)	Limit Max (MHz)	Band Edge Left (MHz)	Band Edge Right (MHz)	Result
2440.000000	1.040000	---	---	2439.485000	2440.525000	PASS

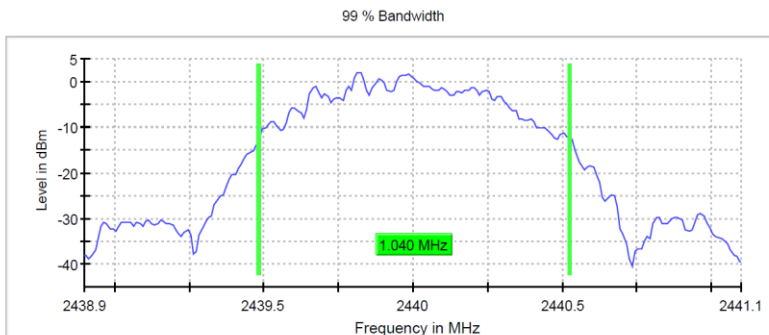

Measurement

Setting	Instrument Value
Start Frequency	2.43890 GHz
Stop Frequency	2.44110 GHz
Span	2.200 MHz
RBW	20.000 kHz
VBW	100.000 kHz
SweepPoints	220
SweepTime	210.000 μs
Reference Level	-10.000 dBm
Attenuation	0.000 dB
Detector	MaxPeak
SweepCount	100
Filter	3 dB
Trace Mode	Max Hold
SweepType	FFT
Preamp	off
Stablemode	Trace
Stablevalue	0.30 dB
Run	6 / max. 150
Stable	3 / 3
Max Stable Difference	0.16 dB

Radio Technology = Bluetooth LE 2 Mbps, Operating Frequency = high
(S01_354_AA01)

99 % Bandwidth

DUT Frequency (MHz)	Bandwidth (MHz)	Limit Min (MHz)	Limit Max (MHz)	Band Edge Left (MHz)	Band Edge Right (MHz)	Result
2480.000000	2.040000	---	---	2478.987500	2481.027500	PASS

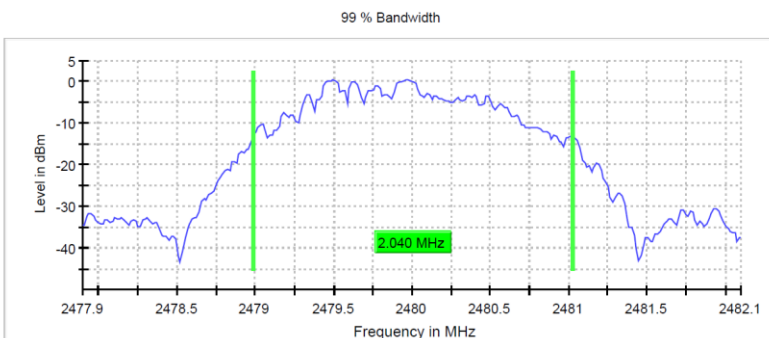

Measurement

Setting	Instrument Value
Start Frequency	2.47790 GHz
Stop Frequency	2.48210 GHz
Span	4.200 MHz
RBW	30.000 kHz
VBW	100.000 kHz
SweepPoints	280
SweepTime	140.000 μs
Reference Level	0.000 dBm
Attenuation	10.000 dB
Detector	MaxPeak
SweepCount	100
Filter	3 dB
Trace Mode	Max Hold
SweepType	FFT
Preamp	off
Stablemode	Trace
Stablevalue	0.30 dB
Run	9 / max. 150
Stable	3 / 3
Max Stable Difference	0.06 dB

5.3.5 TEST EQUIPMENT USED

- R&S TS8997

5.4 PEAK POWER OUTPUT

Standard **FCC Part 15 Subpart C**

The test was performed according to:

ANSI C63.10 11.9.1.1, 11.9.2.3.2

5.4.1 TEST DESCRIPTION

DTS EQUIPMENT:

The Equipment Under Test (EUT) was set up to perform the output power measurements. The results recorded were measured with the modulation which produces the worst-case (highest) output power.

Maximum peak conducted output power (e.g. Bluetooth Low Energy):

The EUT was connected to the test system as described in the block diagram below. The complete attenuation of the measurement path is known and considered.

The reference level of the spectrum analyser was set higher than the output power of the EUT.

Analyser settings:

- Resolution Bandwidth (RBW): \geq DTS bandwidth
- Video Bandwidth (VBW): \geq 3 times RBW or maximum of analyzer
- Span: \geq 3 times RBW
- Trace: Maxhold
- Sweeps: Till stable (min. 300, max. 15000)
- Sweeptime: Auto
- Detector: Peak

Maximum conducted average output power (e.g. WLAN):

The EUT was connected to the test system as described in the block diagram below. The complete attenuation of the measurement path is known and considered.

Measurement is performed using the gated RF average power meter integrated in the OSP 120 module OSP-B157W8 with signal bandwidth >300 MHz.

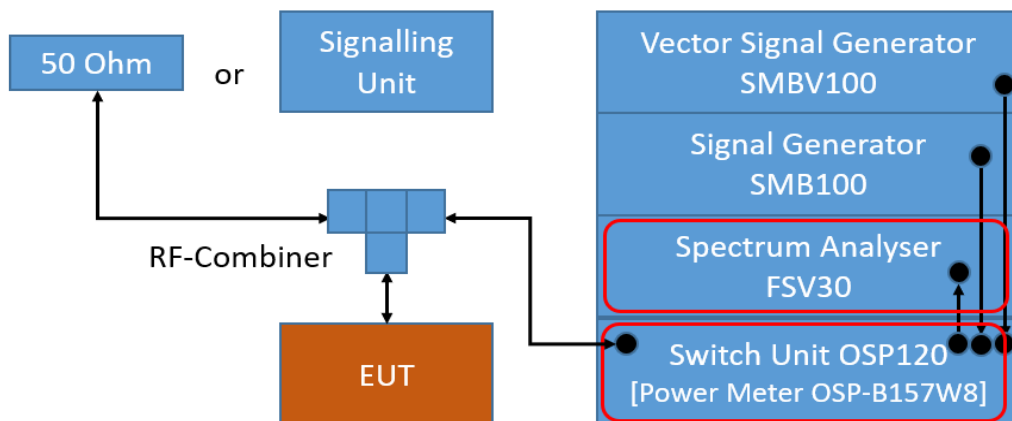

TS8997; Output Power

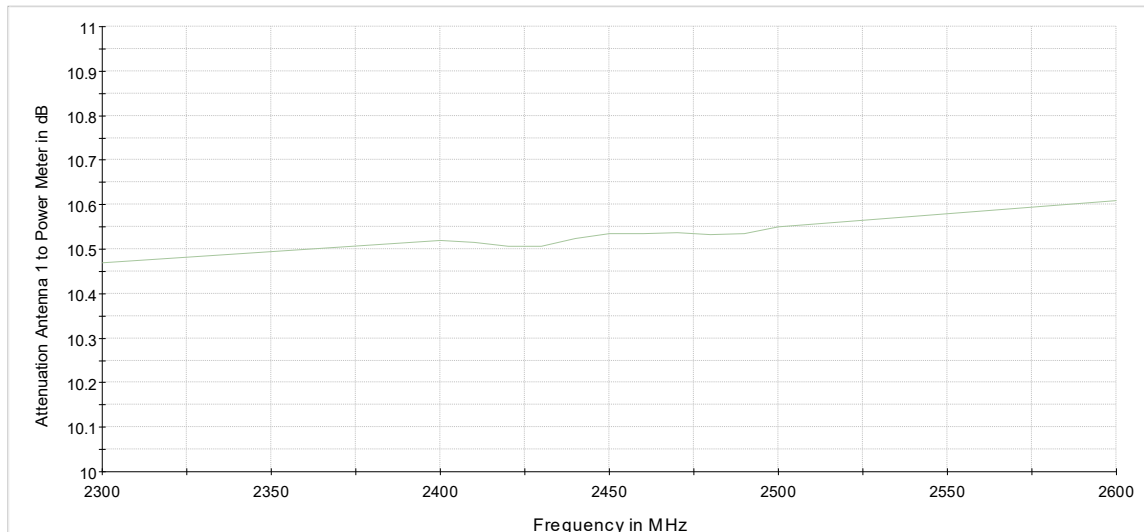

Attenuation of the measurement path to Power Meter

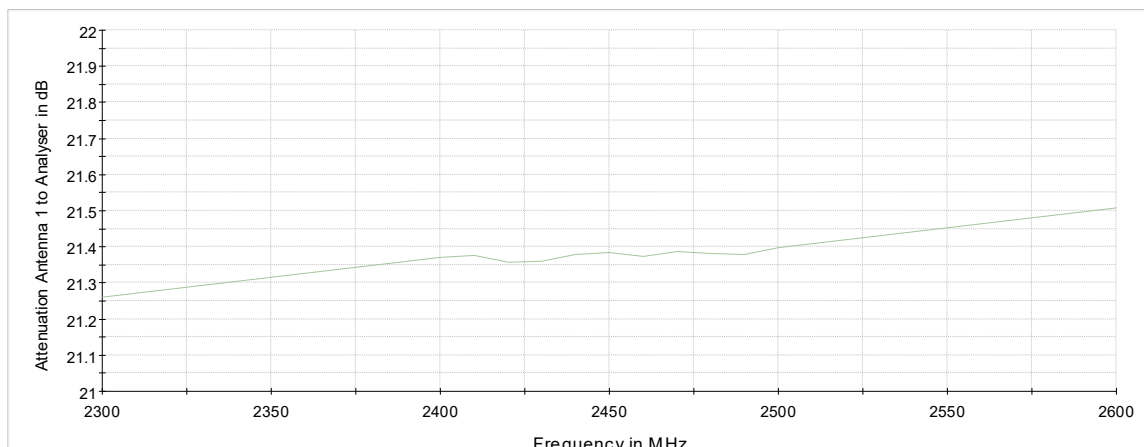

Attenuation of the measurement path to Analyser

5.4.2 TEST REQUIREMENTS / LIMITS

DTS devices:

FCC Part 15, Subpart C, §15.247 (b) (3)

For systems using digital modulation techniques in the 902-928 MHz, 2400-2483.5 MHz and 5725-5850 MHz bands: 1 watt.

==> Maximum conducted peak output power: 30 dBm (excluding antenna gain, if antennas with directional gains that do not exceed 6 dBi are used).

Frequency Hopping Systems:

FCC Part 15, Subpart C, §15.247 (b) (1)

For frequency hopping systems operating in the 2400-2483.5 MHz band employing at least 75 non-overlapping hopping channels, and all frequency hopping systems in the 5725-5850 MHz band: 1 watt. For all other frequency hopping systems in the 2400-2483.5 MHz band: 0.125 watts.

FCC Part 15, Subpart C, §15.247 (b) (2)

For frequency hopping systems operating in the 902-928 MHz band: 1 watt for systems employing at least 50 hopping channels; and, 0.25 watts for systems employing less than 50 hopping channels, but at least 25 hopping channels, as permitted under paragraph (a)(1)(i) of this section.

Used conversion factor: Limit (dBm) = 10 log (Limit (W)/1mW)

5.4.3 TEST PROTOCOL

Ambient temperature: 30 °C
 Air Pressure: 1005 hPa
 Humidity: 28 %

BT GFSK (1-DH1)

Variant	Channel No.	Frequency [MHz]	Peak Power [dBm]	Limit [dBm]	Margin to Limit [dB]	E.I.R.P [dBm]	Difference to W374 [dB]
354-00	0	2402	11.5	30.0	18.5	13.5	0.4
354-00	39	2441	11.4	30.0	18.6	13.4	0.4
354-00	78	2480	11.3	30.0	18.7	13.3	0.4

BT π/4 DQPSK (2-DH1)

Variant	Channel No.	Frequency [MHz]	Peak Power [dBm]	Limit [dBm]	Margin to Limit [dB]	E.I.R.P [dBm]	Difference to W374 [dB]
354-00	0	2402	10.6	30.0	19.4	12.6	0.3
354-00	39	2441	10.6	30.0	19.4	12.6	0.3
354-00	78	2480	10.4	30.0	19.6	12.4	0.3

BT 8-DPSK (3-DH1)

Variant	Channel No.	Frequency [MHz]	Peak Power [dBm]	Limit [dBm]	Margin to Limit [dB]	E.I.R.P [dBm]	Difference to W374 [dB]
354-00	0	2402	10.9	30.0	19.1	12.9	0.4
354-00	39	2441	10.9	30.0	19.1	12.9	-0.1
354-00	78	2480	10.7	30.0	19.3	12.7	0.4

BT LE 1 Mbit/s

Variant	Channel No.	Frequency [MHz]	Peak Power [dBm]	Limit [dBm]	Margin to Limit [dB]	E.I.R.P [dBm]	Difference to W374 [dB]
354-00	0	2402	8.4	30.0	21.6	10.4	0.4
354-00	19	2440	8.4	30.0	21.6	10.4	0.4
354-00	39	2480	8.3	30.0	21.7	10.3	0.4

BT LE 2 Mbit/s

Variant	Channel No.	Frequency [MHz]	Peak Power [dBm]	Limit [dBm]	Margin to Limit [dB]	E.I.R.P [dBm]	Difference to W374 [dB]
354-00	0	2402	8.4	30.0	21.6	10.4	0.4
354-00	19	2440	8.4	30.0	21.6	10.4	0.4
354-00	39	2480	7.9	30.0	21.1	9.9	0.0

WLAN b-Mode; 20 MHz; 1 Mbit/s

Variant	Channel No.	Frequency [MHz]	Maximum Average Power [dBm]	Limit [dBm]	Margin to Limit [dB]	E.I.R.P [dBm]	Difference to W374 [dB]
354-00	1	2412	18.8	30.0	11.2	20.8	0.2
354-00	6	2437	20.6	30.0	9.4	22.6	-0.7
354-00	11	2462	19.2	30.0	10.8	21.2	-0.4

WLAN g-Mode; 20 MHz; 6 Mbit/s

Variant	Channel No.	Frequency [MHz]	Maximum Average Power [dBm]	Limit [dBm]	Margin to Limit [dB]	E.I.R.P [dBm]	Difference to W374 [dB]
354-00	1	2412	14.4	30.0	15.6	16.4	-0.5
354-00	6	2437	18.9	30.0	11.1	20.9	0.0
354-00	11	2462	13.3	30.0	16.7	15.3	-0.8

WLAN n-Mode; 20 MHz; MCS0

Variant	Channel No.	Frequency [MHz]	Maximum Average Power [dBm]	Limit [dBm]	Margin to Limit [dB]	E.I.R.P [dBm]	Difference to W374 [dB]
354-00	1	2412	14.3	30.0	15.7	16.3	-0.5
354-00	6	2437	17.3	30.0	12.7	19.3	-0.2
354-00	11	2462	13.3	30.0	16.7	15.3	0.2

WLAN n-Mode; 40 MHz; MCS0

Variant	Channel No.	Frequency [MHz]	Maximum Average Power [dBm]	Limit [dBm]	Margin to Limit [dB]	E.I.R.P [dBm]	Difference to W374 [dB]
354-00	3	2422	13.0	30.0	17.1	15.0	-0.8
354-00	6	2437	13.7	30.0	16.3	15.7	-0.2
354-00	9	2452	12.9	30.0	17.1	14.9	0.3

WLAN ax-Mode; 20 MHz; MCS0

Variant	Channel No.	Frequency [MHz]	Maximum Average Power [dBm]	Limit [dBm]	Margin to Limit [dB]	E.I.R.P [dBm]	Difference to W374 [dB]
354-00	1	2412	13.6	30.0	16.4	15.6	-0.3
354-00	6	2437	17.9	30.0	12.1	19.9	-0.6
354-00	11	2462	13.0	30.0	17.0	15.0	-0.1

WLAN ax-Mode; 40 MHz; MCS0

Variant	Channel No.	Frequency [MHz]	Maximum Average Power [dBm]	Limit [dBm]	Margin to Limit [dB]	E.I.R.P [dBm]	Difference to W374 [dB]
354-00	3	2422	13.7	30.0	16.3	15.7	-0.4
354-00	6	2437	14.0	30.0	16.0	16.0	-0.2
354-00	9	2452	13.2	30.0	16.8	15.2	-0.1

Remark: Please see next sub-clause for the measurement plot.
No plots are given for WLAN (Power Meter measurement).

5.4.4 MEASUREMENT PLOT (EXAMPLE PLOT, SHOWING WORST CASE, IF APPLICABLE)

Radio Technology = Bluetooth BDR, Operating Frequency = low, Measurement method = conducted
(S01_354_AA01)

Result

DUT Frequency (MHz)	Peak Power (dBm)	Limit Max (dBm)	Result
2402.000000	11.5	21.0	PASS

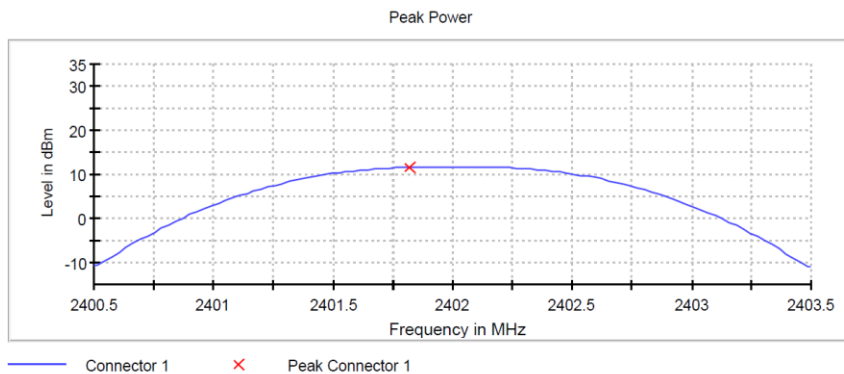

Measurement

Setting	Instrument Value
Start Frequency	2.40050 GHz
Stop Frequency	2.40350 GHz
Span	3.000 MHz
RBW	1.000 MHz
VBW	3.000 MHz
SweepPoints	101
Sweeptime	4.210 μs
Reference Level	0.000 dBm
Attenuation	10.000 dB
Detector	MaxPeak
SweepCount	100
Filter	3 dB
Trace Mode	Max Hold
SweepType	FFT
Preamp	off
Stablemode	Trace
Stablevalue	0.50 dB
Run	4 / max. 150
Stable	3 / 3
Max Stable Difference	0.04 dB

Radio Technology = Bluetooth EDR 2, Operating Frequency = mid, Measurement method = conducted (S01_354_AA01)

Result

DUT Frequency (MHz)	Peak Power (dBm)	Limit Max (dBm)	Result
2441.000000	10.6	21.0	PASS

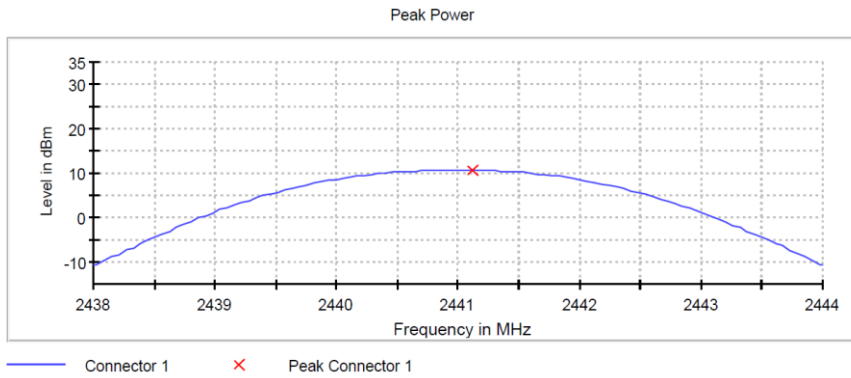

Measurement

Setting	Instrument Value
Start Frequency	2.43800 GHz
Stop Frequency	2.44400 GHz
Span	6.000 MHz
RBW	2.000 MHz
VBW	10.000 MHz
SweepPoints	101
SweepTime	1.000 ms
Reference Level	0.000 dBm
Attenuation	10.000 dB
Detector	MaxPeak
SweepCount	100
Filter	3 dB
Trace Mode	Max Hold
SweepType	Sweep
Preamp	off
Stablemode	Trace
Stablevalue	0.50 dB
Run	4 / max. 150
Stable	3 / 3
Max Stable Difference	0.09 dB

Radio Technology = Bluetooth EDR 3, Operating Frequency = mid, Measurement method = conducted (S01_354_AA01)

Result

DUT Frequency (MHz)	Peak Power (dBm)	Limit Max (dBm)	Result
2441.000000	10.9	21.0	PASS

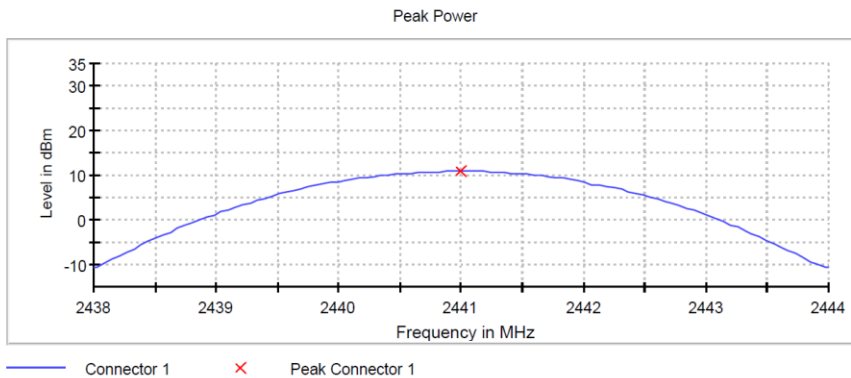

Measurement

Setting	Instrument Value
Start Frequency	2.43800 GHz
Stop Frequency	2.44400 GHz
Span	6.000 MHz
RBW	2.000 MHz
VBW	10.000 MHz
SweepPoints	101
SweepTime	1.000 ms
Reference Level	0.000 dBm
Attenuation	10.000 dB
Detector	MaxPeak
SweepCount	100
Filter	3 dB
Trace Mode	Max Hold
SweepType	Sweep
Preamp	off
Stablemode	Trace
Stablevalue	0.50 dB
Run	4 / max. 150
Stable	3 / 3
Max Stable Difference	0.17 dB

Radio Technology = Bluetooth LE 1 Mbps, Operating Frequency = mid, Measurement method = conducted
(S01_354_AA01)

Result

DUT Frequency (MHz)	Peak Power (dBm)	Limit Max (dBm)	Result
2440.000000	8.4	30.0	PASS

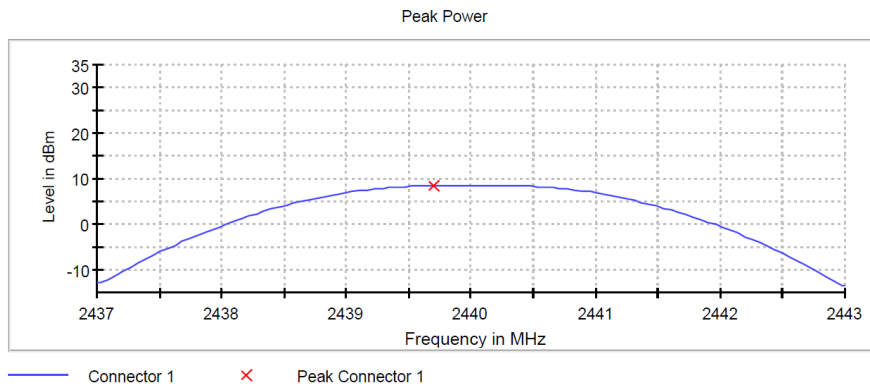

Measurement

Setting	Instrument Value
Start Frequency	2.43700 GHz
Stop Frequency	2.44300 GHz
Span	6.000 MHz
RBW	2.000 MHz
VBW	10.000 MHz
SweepPoints	101
Sweptime	1.000 ms
Reference Level	0.000 dBm
Attenuation	10.000 dB
Detector	MaxPeak
SweepCount	100
Filter	3 dB
Trace Mode	Max Hold
Sweeptype	Sweep
Preamp	off
Stablemode	Trace
Stablevalue	0.50 dB
Run	4 / max. 150
Stable	3 / 3
Max Stable Difference	0.02 dB

Radio Technology = Bluetooth LE 2 Mbps, Operating Frequency = mid, Measurement method = conducted
(S01_354_AA01)

Result

DUT Frequency (MHz)	Peak Power (dBm)	Limit Max (dBm)	Result
2440.000000	8.4	30.0	PASS

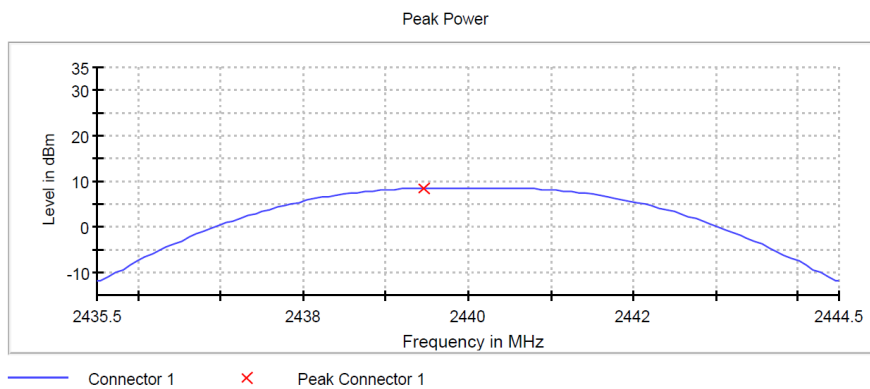

Measurement

Setting	Instrument Value
Start Frequency	2.43550 GHz
Stop Frequency	2.44450 GHz
Span	9.000 MHz
RBW	3.000 MHz
VBW	10.000 MHz
SweepPoints	101
Sweptime	1.000 ms
Reference Level	0.000 dBm
Attenuation	10.000 dB
Detector	MaxPeak
SweepCount	100
Filter	3 dB
Trace Mode	Max Hold
Sweeptype	Sweep
Preamp	off
Stablemode	Trace
Stablevalue	0.50 dB
Run	4 / max. 150
Stable	3 / 3
Max Stable Difference	0.02 dB

5.4.5 TEST EQUIPMENT USED

- R&S TS8997

5.5 SPURIOUS RF CONDUCTED EMISSIONS

Standard **FCC Part 15 Subpart C**

The test was performed according to:
ANSI C63.10 11.11

5.5.1 TEST DESCRIPTION

The Equipment Under Test (EUT) was set up to perform the spurious emissions measurements.

The EUT was connected to the test system as described in the block diagram below. The complete attenuation of the measurement path is known and considered.

Analyser settings:

- Frequency range: 30 – 26000 MHz
- Resolution Bandwidth (RBW): 100 kHz
- Video Bandwidth (VBW): 300 kHz
- Trace: Maxhold
- Sweeps: Till Stable (max. 120)
- Sweep Time: Auto
- Detector: Peak

The reference value for the measurement of the spurious RF conducted emissions is determined during the test "band edge compliance conducted". This value is used to calculate the 20 dBc or 30 dBc limit.

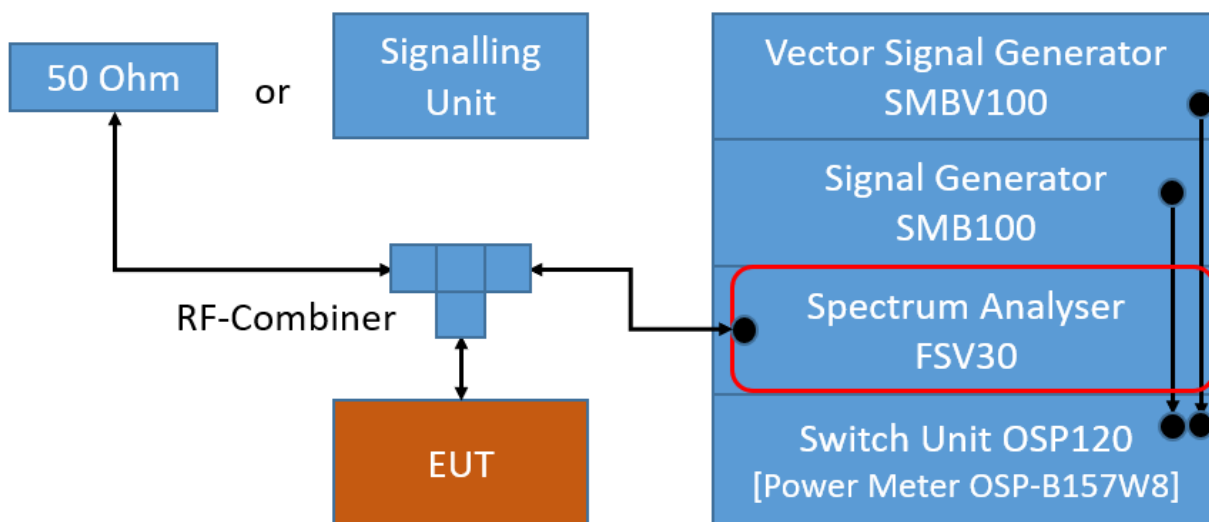

TS8997; Spurious RF Conducted Emissions

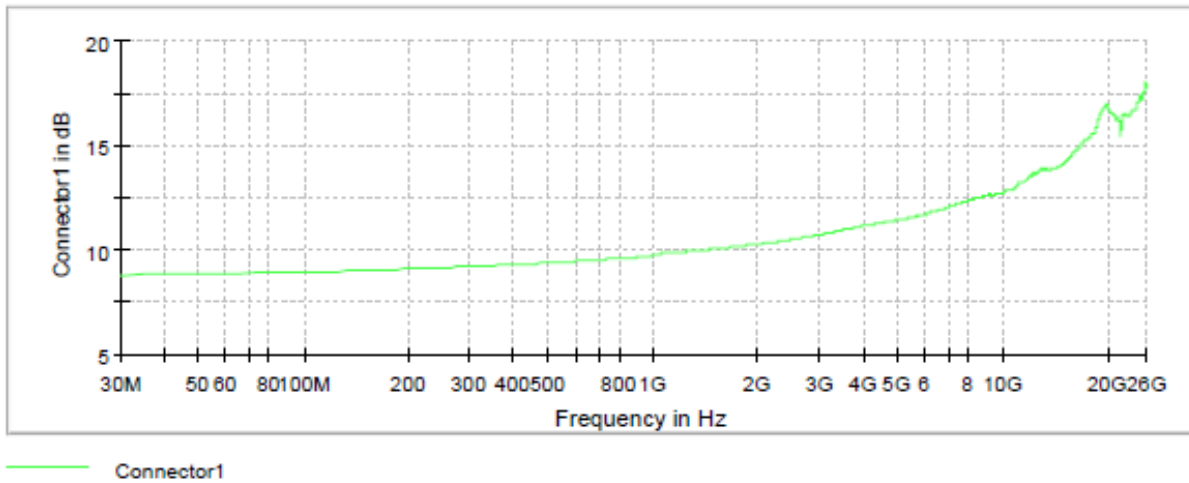

Attenuation of the measurement part

5.5.2 TEST REQUIREMENTS / LIMITS

FCC Part 15, Subpart C, §15.247 (c)

In any 100 kHz bandwidth outside the frequency band in which the spread spectrum intentional radiator is operating, the radio frequency power that is produced by the intentional radiator shall be at least 20 dB below that in the 100 kHz bandwidth within the band that contains the highest level of the desired power, based on either an RF conducted or a radiated measurement, provided the transmitter demonstrates compliance with the peak conducted power limits. If the transmitter complies with the conducted power limits based on the use of RMS averaging over a time interval, as permitted under paragraph (b)(3) of this section, the attenuation required under this paragraph shall be 30 dB instead of 20 dB.

5.5.3 TEST PROTOCOL

Ambient temperature: 30 °C
 Air Pressure: 1005 hPa
 Humidity: 28 %

BT GFSK (1-DH1)

Channel No	Channel Center Freq. [MHz]	Spurious Freq. [MHz]	Spurious Level [dBm]	Detector	RBW [kHz]	Ref. Level [dBm]	Limit [dBm]	Margin to Limit [dB]
0	2402	2395.0	-52.0	PEAK	100	9.6	-10.4	41.6
39	2441	2508.5	-56.6	PEAK	100	9.6	-10.4	46.2
78	2480	2488.5	-53.5	PEAK	100	9.8	-10.2	43.3

BT π/4 DQPSK (2-DH1)

Channel No	Channel Center Freq. [MHz]	Spurious Freq. [MHz]	Spurious Level [dBm]	Detector	RBW [kHz]	Ref. Level [dBm]	Limit [dBm]	Margin to Limit [dB]
0	2402	2395.0	-51.0	PEAK	100	6.1	-13.9	37.1
39	2441	2205.8	-62.1	PEAK	100	7.2	-12.8	49.3
78	2480	2488.5	-53.4	PEAK	100	7.3	-12.7	40.7

BT 8-DPSK (3-DH1)

Channel No	Channel Center Freq. [MHz]	Spurious Freq. [MHz]	Spurious Level [dBm]	Detector	RBW [kHz]	Ref. Level [dBm]	Limit [dBm]	Margin to Limit [dB]
0	2402	2395.0	-48.5	PEAK	100	7.9	-12.1	36.4
39	2441	2205.8	-63.1	PEAK	100	4.8	-15.2	47.9
78	2480	2488.5	-55.3	PEAK	100	6.1	-13.9	41.4

BT LE 1 Mbit/s

Channel No	Channel Center Freq. [MHz]	Spurious Freq. [MHz]	Spurious Level [dBm]	Detector	RBW [kHz]	Ref. Level [dBm]	Limit [dBm]	Margin to Limit [dB]
0	2402	2488.5	-50.0	PEAK	100	6.3	-13.7	36.3
19	2440	2488.5	-50.5	PEAK	100	7.5	-12.5	38.0
39	2480	2488.5	-51.2	PEAK	100	6.7	-13.3	37.9

BT LE 2 Mbit/s

Channel No	Channel Center Freq. [MHz]	Spurious Freq. [MHz]	Spurious Level [dBm]	Detector	RBW [kHz]	Ref. Level [dBm]	Limit [dBm]	Margin to Limit [dB]
0	2402	2395.0	-33.8	PEAK	100	4.4	-15.6	18.2
19	2440	2488.5	-60.4	PEAK	100	6.4	-13.6	46.8
39	2480	2488.5	-49.9	PEAK	100	4.2	-15.8	34.1

Remark: Please see next sub-clause for the measurement plot.

Note that the limit line in the plots is 10 dB too low, since they show 30 dBc limit line instead of 20 dBc limit line.

5.5.4 MEASUREMENT PLOT

Radio Technology = Bluetooth BDR, Operating Frequency = low
(S01_354_AA01)

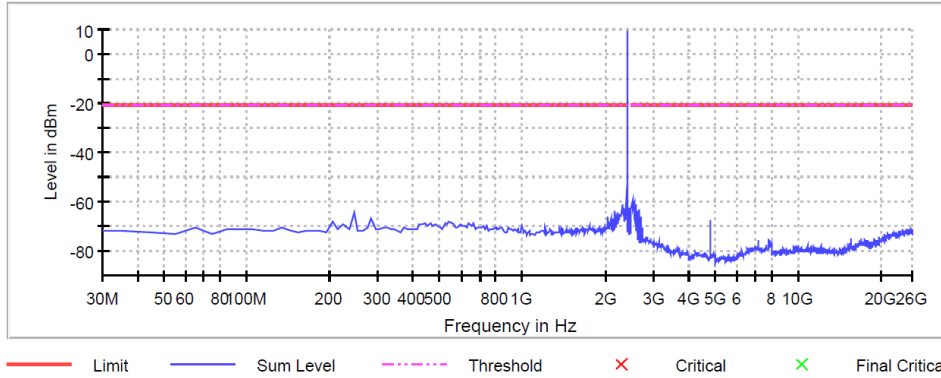

Frequency (MHz)	Level (dBm)	Margin (dB)	Limit (dBm)
2395.021008	-52.0	31.6	-20.4
2498.491394	-59.2	38.8	-20.4
2528.474182	-60.8	40.4	-20.4
2538.468445	-60.9	40.5	-20.4
2578.445495	-61.1	40.7	-20.4
2295.441176	-61.2	40.8	-20.4
2508.485657	-61.6	41.2	-20.4
2385.063025	-62.2	41.8	-20.4
2315.357143	-62.7	42.3	-20.4
2488.497131	-62.9	42.5	-20.4
2305.399160	-62.9	42.6	-20.4
2355.189076	-63.0	42.7	-20.4
2638.411071	-63.1	42.7	-20.4
2518.479919	-63.3	43.0	-20.4
2598.434020	-63.5	43.1	-20.4

Radio Technology = Bluetooth BDR, Operating Frequency = mid
(S01_354_AA01)

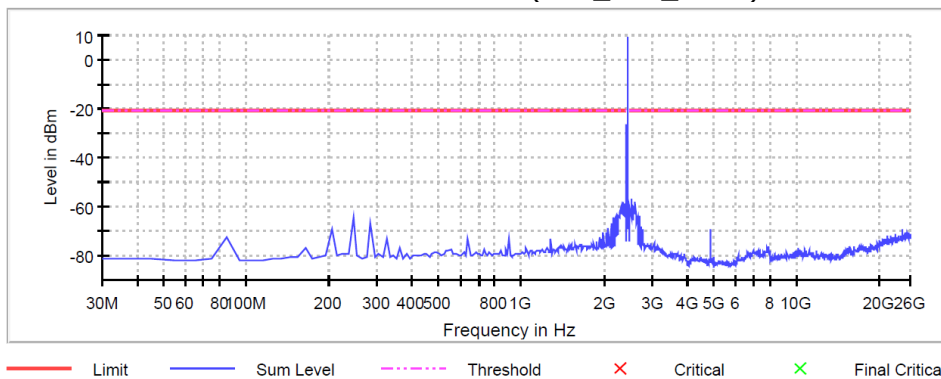

Frequency (MHz)	Level (dBm)	Margin (dB)	Limit (dBm)
2508.485657	-56.6	36.3	-20.4
2345.231092	-57.9	37.5	-20.4
2588.439758	-57.9	37.5	-20.4
2375.105042	-58.8	38.5	-20.4
2538.468445	-59.7	39.3	-20.4
2488.497131	-59.8	39.4	-20.4
2558.456970	-60.0	39.7	-20.4
2295.441176	-60.1	39.7	-20.4
2568.451232	-61.4	41.1	-20.4
2315.357143	-61.9	41.5	-20.4
2335.273109	-62.1	41.8	-20.4
2275.525210	-62.2	41.8	-20.4
2325.315126	-62.2	41.9	-20.4
2528.474182	-62.4	42.0	-20.4
2285.483193	-62.6	42.2	-20.4

Radio Technology = Bluetooth BDR, Operating Frequency = high
(S01_354_AA01)

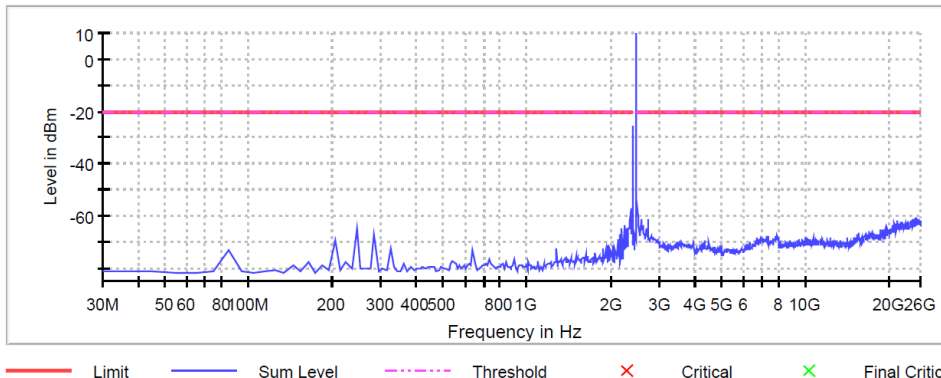

Frequency (MHz)	Level (dBm)	Margin (dB)	Limit (dBm)
2488.497131	-53.5	33.3	-20.2
2365.147059	-56.9	36.7	-20.2
24795.691351	-60.8	40.6	-20.2
24865.651190	-60.8	40.6	-20.2
2498.491394	-60.9	40.7	-20.2
2385.063025	-61.0	40.8	-20.2
25575.243838	-61.1	40.9	-20.2
24635.783149	-61.2	41.0	-20.2
25725.157777	-61.2	41.0	-20.2
2568.451232	-61.2	41.0	-20.2
25015.565130	-61.3	41.1	-20.2
2718.365172	-61.3	41.1	-20.2
24705.742988	-61.4	41.2	-20.2
24415.909371	-61.4	41.2	-20.2
25225.444645	-61.4	41.2	-20.2

Radio Technology = Bluetooth EDR 2, Operating Frequency = low
(S01_354_AA01)

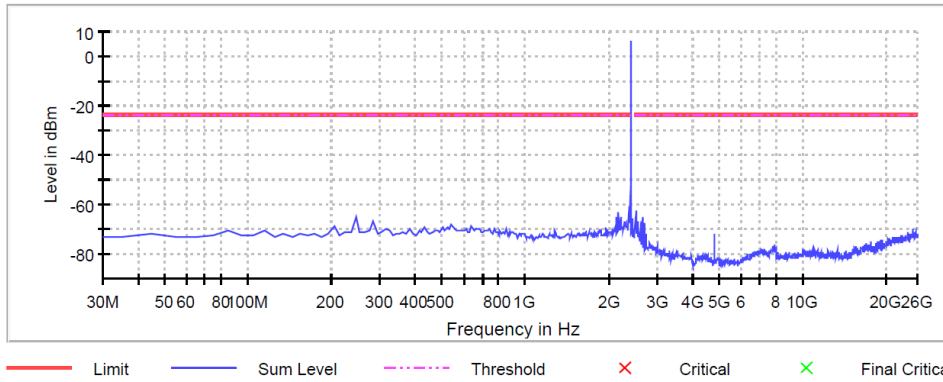

Frequency (MHz)	Level (dBm)	Margin (dB)	Limit (dBm)
2395.021008	-51.0	27.1	-23.9
2365.147059	-60.5	36.6	-23.9
2498.491394	-62.3	38.5	-23.9
2165.987395	-63.2	39.3	-23.9
2205.819328	-64.7	40.9	-23.9
2126.155462	-65.0	41.1	-23.9
2638.411071	-65.2	41.3	-23.9
244.096639	-65.2	41.3	-23.9
283.928571	-66.7	42.8	-23.9
2385.063025	-66.9	43.0	-23.9
2528.474182	-67.0	43.1	-23.9
2598.434020	-67.1	43.2	-23.9
2275.525210	-67.1	43.2	-23.9
2375.105042	-67.4	43.5	-23.9
2295.441176	-67.5	43.6	-23.9

Radio Technology = Bluetooth EDR 2, Operating Frequency = mid
(S01_354_AA01)

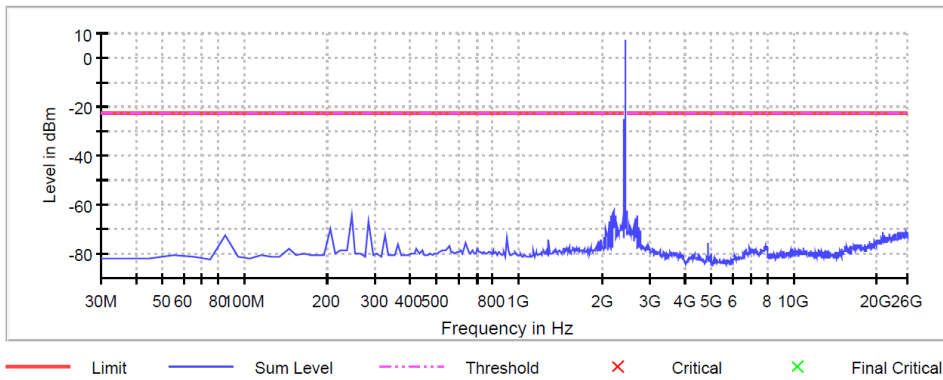

Frequency (MHz)	Level (dBm)	Margin (dB)	Limit (dBm)
2205.819328	-62.8	40.0	-22.8
2395.021008	-63.4	40.6	-22.8
2195.861345	-63.7	41.0	-22.8
2245.651261	-64.2	41.4	-22.8
2156.029412	-64.3	41.6	-22.8
244.096639	-64.5	41.7	-22.8
2678.388122	-64.5	41.8	-22.8
2165.987395	-64.9	42.1	-22.8
2638.411071	-65.5	42.7	-22.8
2215.777311	-66.2	43.5	-22.8
283.928571	-66.9	44.1	-22.8
2116.197479	-67.0	44.2	-22.8
2375.105042	-67.7	44.9	-22.8
2235.693277	-68.6	45.8	-22.8
2355.189076	-68.8	46.0	-22.8

Radio Technology = Bluetooth EDR 2, Operating Frequency = high
(S01_354_AA01)

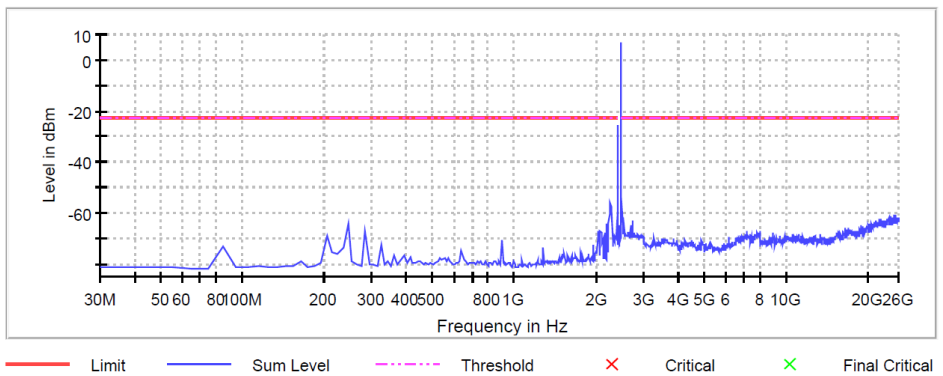

Frequency (MHz)	Level (dBm)	Margin (dB)	Limit (dBm)
2488.497131	-53.4	30.8	-22.7
2255.609244	-56.2	33.5	-22.7
2245.651261	-57.3	34.6	-22.7
2275.525210	-57.6	34.9	-22.7
2265.567227	-57.8	35.1	-22.7
2285.483193	-58.9	36.2	-22.7
2395.021008	-59.6	36.9	-22.7
2235.693277	-60.5	37.8	-22.7
25435.324161	-60.7	38.0	-22.7
24925.616766	-60.8	38.1	-22.7
24835.668402	-60.9	38.2	-22.7
25005.570867	-61.2	38.5	-22.7
25165.479069	-61.2	38.5	-22.7
24345.949533	-61.5	38.8	-22.7
25345.375797	-61.5	38.8	-22.7

Radio Technology = Bluetooth EDR 3, Operating Frequency = low
(S01_354_AA01)

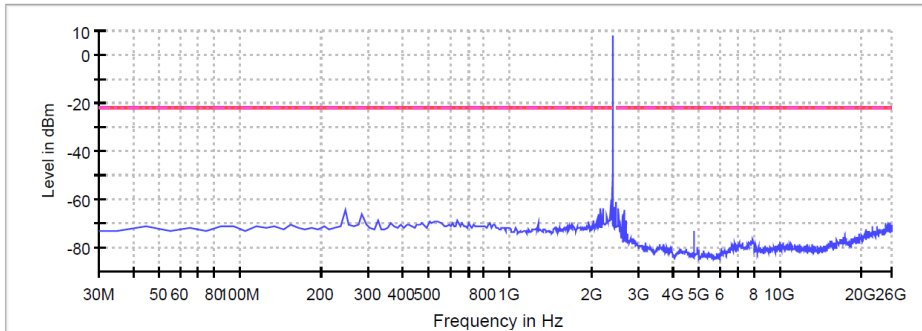

— Limit — Sum Level - - - Threshold × Critical × Final Critical

Frequency (MHz)	Level (dBm)	Margin (dB)	Limit (dBm)
2395.021008	-48.5	26.3	-22.1
2365.147059	-59.9	37.7	-22.1
2165.987395	-63.6	41.4	-22.1
2205.819328	-63.8	41.6	-22.1
2518.479919	-63.9	41.7	-22.1
244.096639	-64.1	42.0	-22.1
2638.411071	-64.5	42.4	-22.1
283.928571	-66.2	44.0	-22.1
2598.434020	-66.3	44.2	-22.1
2126.155462	-66.4	44.2	-22.1
2285.483193	-66.6	44.5	-22.1
2185.903361	-66.7	44.6	-22.1
2345.231092	-68.5	46.3	-22.1
2046.491597	-68.6	46.5	-22.1
2558.456970	-68.7	46.5	-22.1

Radio Technology = Bluetooth EDR 3, Operating Frequency = mid
(S01_354_AA01)

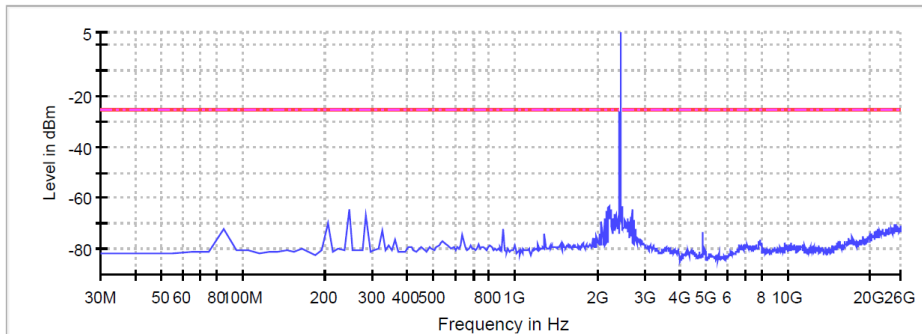

— Limit — Sum Level - - - Threshold × Critical × Final Critical

Frequency (MHz)	Level (dBm)	Margin (dB)	Limit (dBm)
2205.819328	-63.1	38.0	-25.2
2195.861345	-63.9	38.8	-25.2
2678.388122	-64.3	39.2	-25.2
2245.651261	-64.4	39.2	-25.2
244.096639	-64.4	39.2	-25.2
2156.029412	-65.0	39.8	-25.2
2165.987395	-65.1	40.0	-25.2
2395.021008	-65.4	40.3	-25.2
2305.399160	-66.1	41.0	-25.2
2335.273109	-66.8	41.7	-25.2
2215.777311	-66.9	41.7	-25.2
283.928571	-67.0	41.8	-25.2
2638.411071	-67.2	42.0	-25.2
2225.735294	-67.8	42.6	-25.2
2285.483193	-68.1	42.9	-25.2

Radio Technology = Bluetooth EDR 3, Operating Frequency = high
(S01_354_AA01)

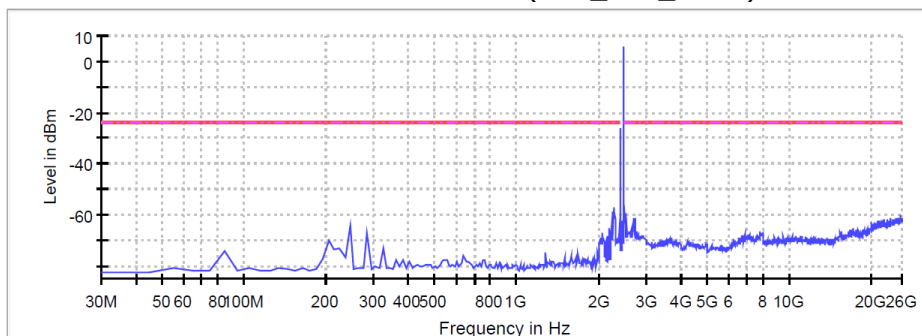

— Limit — Sum Level - - - Threshold × Critical × Final Critical

Frequency (MHz)	Level (dBm)	Margin (dB)	Limit (dBm)
2488.497131	-55.3	31.4	-23.9
2265.567227	-57.0	33.1	-23.9
2275.525210	-57.7	33.8	-23.9
2245.651261	-58.9	35.0	-23.9
2285.483193	-59.1	35.2	-23.9
2518.479919	-59.2	35.3	-23.9
25595.232363	-60.0	36.1	-23.9
2395.021008	-60.4	36.5	-23.9
2235.693277	-60.8	36.9	-23.9
25535.266787	-60.8	36.9	-23.9
24955.599554	-61.0	37.1	-23.9
2688.382384	-61.1	37.2	-23.9
25035.553655	-61.2	37.3	-23.9
25635.209414	-61.2	37.3	-23.9
25265.421696	-61.2	37.3	-23.9

Radio Technology = Bluetooth LE 1 Mbps, Operating Frequency = low
(S01_354_AA01)

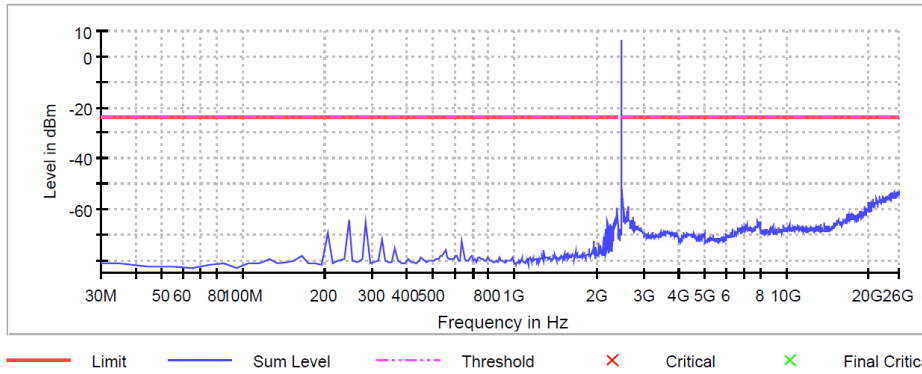

Frequency (MHz)	Level (dBm)	Margin (dB)	Limit (dBm)
2488.497131	-50.9	27.2	-23.7
25955.025818	-52.7	29.0	-23.7
24815.679877	-52.7	29.0	-23.7
25945.031555	-52.9	29.2	-23.7
25625.215151	-52.9	29.2	-23.7
25515.278262	-53.0	29.3	-23.7
25665.192201	-53.0	29.3	-23.7
25675.186464	-53.1	29.4	-23.7
25005.570867	-53.1	29.4	-23.7
25965.020081	-53.1	29.4	-23.7
26000.000000	-53.2	29.5	-23.7
25995.002869	-53.2	29.5	-23.7
25735.152040	-53.2	29.5	-23.7
25925.043030	-53.3	29.6	-23.7
25085.524968	-53.4	29.7	-23.7

Radio Technology = Bluetooth LE 1 Mbps, Operating Frequency = mid
(S01_354_AA01)

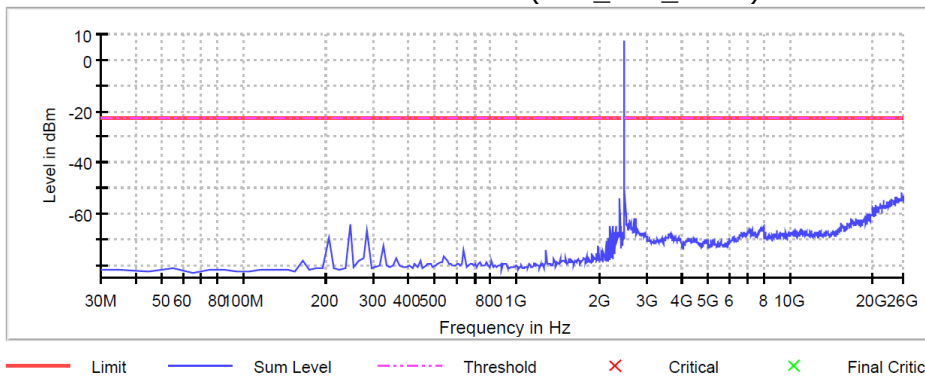

Frequency (MHz)	Level (dBm)	Margin (dB)	Limit (dBm)
2488.497131	-50.5	28.1	-22.5
25605.226626	-51.8	29.4	-22.5
25695.174989	-52.1	29.7	-22.5
25775.129091	-52.3	29.9	-22.5
25765.134828	-52.6	30.1	-22.5
25835.094666	-52.8	30.3	-22.5
25815.106141	-52.8	30.4	-22.5
25915.048768	-52.9	30.5	-22.5
25685.180727	-53.2	30.7	-22.5
24395.920846	-53.3	30.8	-22.5
25615.220888	-53.3	30.9	-22.5
25725.157777	-53.3	30.9	-22.5
25535.266787	-53.3	30.9	-22.5
25625.215151	-53.4	31.0	-22.5
25965.020081	-53.4	31.0	-22.5

Radio Technology = Bluetooth LE 1 Mbps, Operating Frequency = high
(S01_354_AA01)

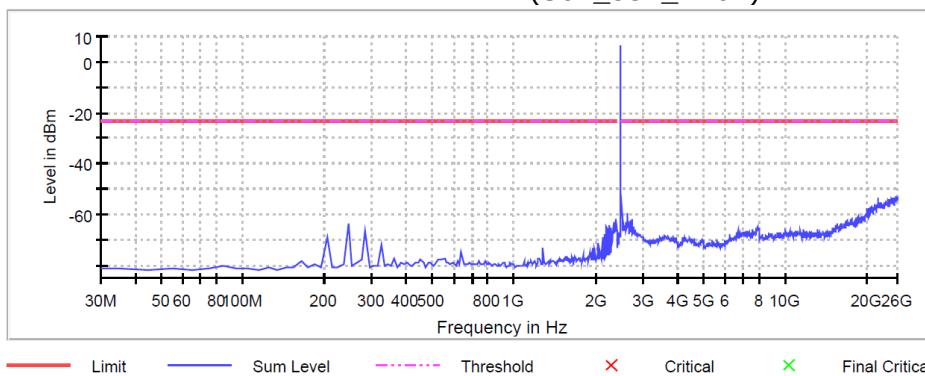

Frequency (MHz)	Level (dBm)	Margin (dB)	Limit (dBm)
2488.497131	-51.2	27.9	-23.3
25675.186464	-52.7	29.4	-23.3
25975.014343	-52.9	29.6	-23.3
25685.180727	-52.9	29.6	-23.3
26000.000000	-53.1	29.8	-23.3
25545.261050	-53.1	29.8	-23.3
25995.002869	-53.1	29.8	-23.3
25785.123353	-53.2	29.9	-23.3
25965.020081	-53.2	29.9	-23.3
25815.106141	-53.2	29.9	-23.3
25865.077454	-53.2	29.9	-23.3
25665.192201	-53.3	29.9	-23.3
25925.043030	-53.3	30.0	-23.3
25765.134828	-53.3	30.0	-23.3
25945.031555	-53.3	30.0	-23.3

Radio Technology = Bluetooth LE 2 Mbps, Operating Frequency = low
(S01_354_AA01)

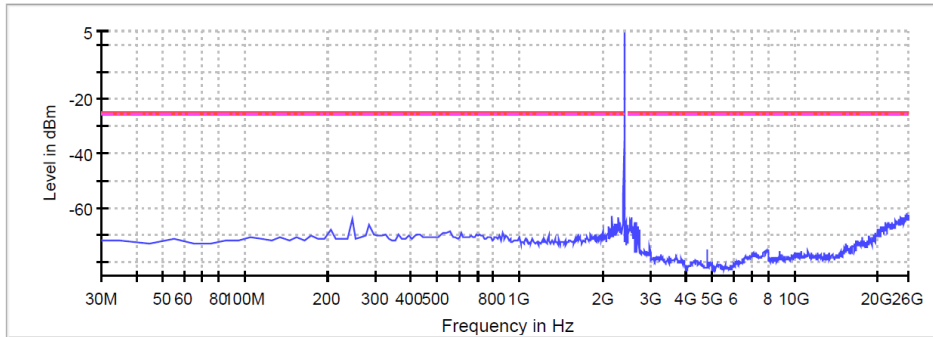

Frequency (MHz)	Level (dBm)	Margin (dB)	Limit (dBm)
2395.021008	-33.8	8.3	-25.6
2385.063025	-56.8	31.2	-25.6
2375.105042	-61.1	35.5	-25.6
25635.209414	-61.7	36.1	-25.6
26000.000000	-62.6	37.0	-25.6
25995.002869	-62.6	37.0	-25.6
25975.014343	-62.7	37.2	-25.6
25175.473332	-62.8	37.2	-25.6
25695.174989	-63.0	37.5	-25.6
25785.123353	-63.1	37.5	-25.6
2165.987395	-63.1	37.6	-25.6
25665.192201	-63.3	37.8	-25.6
25015.565130	-63.4	37.8	-25.6
25575.243838	-63.4	37.8	-25.6
24885.639715	-63.4	37.8	-25.6

— Limit — Sum Level - - - Threshold × Critical × Final Critical

Radio Technology = Bluetooth LE 2 Mbps, Operating Frequency = mid
(S01_354_AA01)

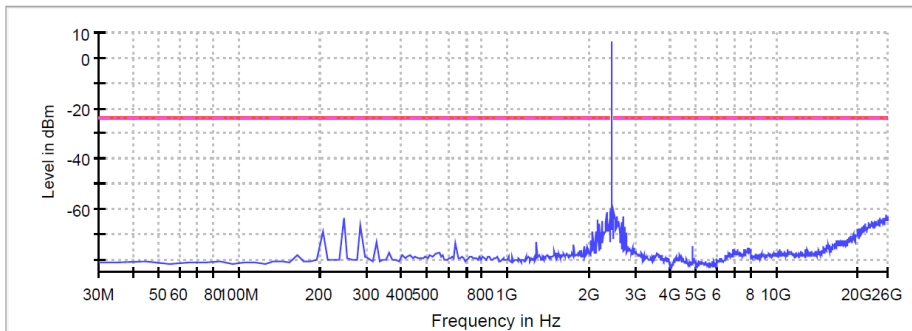

Frequency (MHz)	Level (dBm)	Margin (dB)	Limit (dBm)
2488.497131	-60.4	36.8	-23.6
2335.273109	-61.1	37.5	-23.6
25795.117616	-62.6	39.0	-23.6
25845.088929	-62.9	39.2	-23.6
25635.209414	-62.9	39.3	-23.6
2548.462707	-63.0	39.4	-23.6
2678.388122	-63.3	39.7	-23.6
25075.530705	-63.4	39.7	-23.6
25755.140565	-63.4	39.7	-23.6
25525.272524	-63.4	39.7	-23.6
24965.593816	-63.4	39.8	-23.6
24375.932320	-63.4	39.8	-23.6
25455.312686	-63.6	39.9	-23.6
25745.146303	-63.6	40.0	-23.6
2395.021008	-63.7	40.0	-23.6

— Limit — Sum Level - - - Threshold × Critical × Final Critical

Radio Technology = Bluetooth LE 2 Mbps, Operating Frequency = high
(S01_354_AA01)

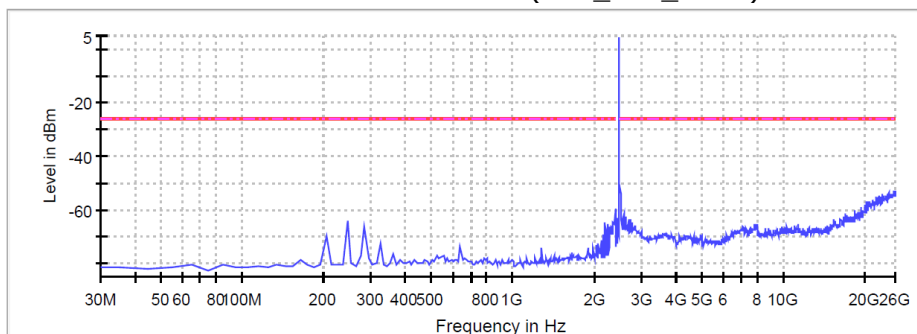

Frequency (MHz)	Level (dBm)	Margin (dB)	Limit (dBm)
2488.497131	-49.9	24.1	-25.8
25595.232363	-52.8	26.9	-25.8
25975.014343	-53.1	27.2	-25.8
25665.192201	-53.1	27.3	-25.8
25755.140565	-53.3	27.5	-25.8
25685.180727	-53.3	27.5	-25.8
26000.000000	-53.3	27.5	-25.8
25995.002869	-53.3	27.5	-25.8
25655.197939	-53.4	27.5	-25.8
25845.088929	-53.4	27.6	-25.8
24435.897896	-53.4	27.6	-25.8
25585.238100	-53.5	27.6	-25.8
25985.008606	-53.5	27.7	-25.8
25775.129091	-53.5	27.7	-25.8
25725.157777	-53.7	27.8	-25.8

— Limit — Sum Level - - - Threshold × Critical × Final Critical

5.5.5 TEST EQUIPMENT USED

- R&S TS8997

5.6 TRANSMITTER SPURIOUS RADIATED EMISSIONS

Standard **FCC Part 15 Subpart C**

The test was performed according to:
ANSI C63.10

5.6.1 TEST DESCRIPTION

Radiated Measurement with 50 Ohm termination at antenna ports

The test set-up was made in accordance to the general provisions of ANSI C63.10 in a typical installation configuration. The measurements were performed according the following sub-chapters of ANSI C63.10:

- < 30 MHz: Chapter 6.4
- 30 MHz – 1 GHz: Chapter 6.5
- > 1 GHz: Chapter 6.6 (procedure according 6.6.5 used)

The measurement procedure is implemented into the EMI test software EMC32 from R&S. Exploratory tests are performed at 3 orthogonal axes to determine the worst-case orientation of a body-worn or handheld EUT. The final test on all kind of EUTs is also performed at 3 axes. A pre-check is performed while the EUT is powered.

Below 1 GHz:

The Equipment Under Test (EUT) was set up on a non-conductive table in the semi-anechoic chamber. The influence of the EUT support table that is used between 30–1000 MHz was evaluated.

1. Measurement up to 30 MHz

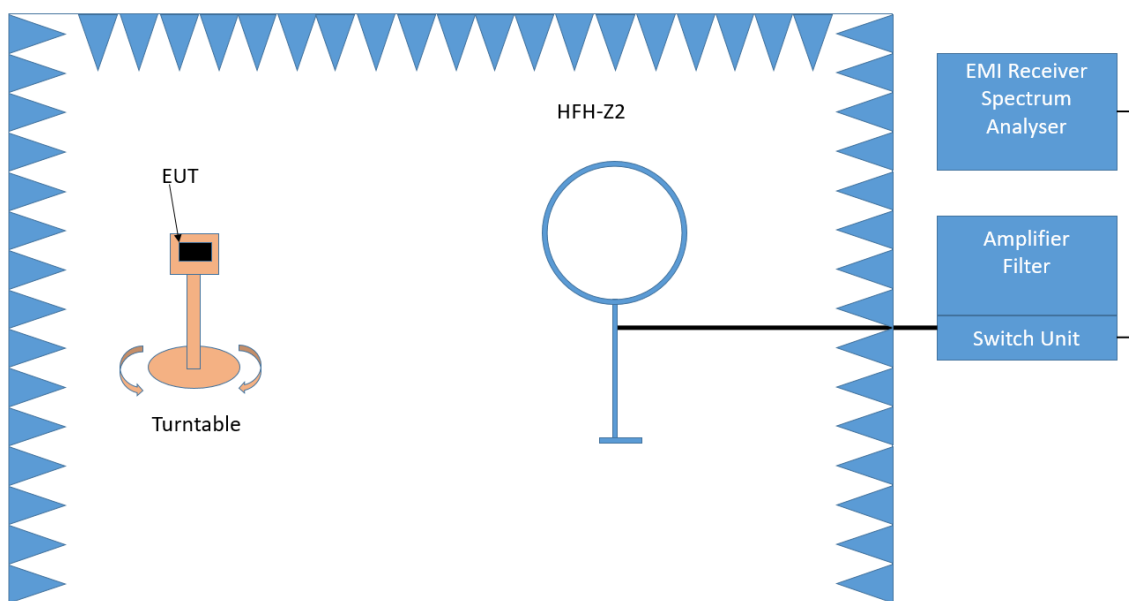

Test Setup; Spurious Emission Radiated (SAC), 9 kHz – 30 MHz

The Loop antenna HFH2-Z2 is used.

Step 1: pre measurement

- Anechoic chamber
- Antenna distance: 3 m
- Antenna height: 1 m
- Detector: Peak-Maxhold
- Frequency range: 0.009 - 0.15 MHz and 0.15 - 30 MHz
- Frequency steps: 0.05 kHz and 2.25 kHz
- IF-Bandwidth: 0.2 kHz and 9 kHz
- Measuring time / Frequency step: 100 ms (FFT-based)

Intention of this step is, to determine the radiated EMI-profile of the EUT. Afterwards the relevant emissions for the final measurement are identified.

Step 2: final measurement

For the relevant emissions determined in step 1, an additional measurement with the following settings will be performed. Intention of this step is to find the maximum emission level.

- Detector: Quasi-Peak (9 kHz - 150 kHz, Peak / Average 150 kHz- 30 MHz)
- Frequency range: 0.009 - 30 MHz
- Frequency steps: measurement at frequencies detected in step 1
- IF-Bandwidth: 0.2 - 10 kHz
- Measuring time / Frequency step: 1 s

2. Measurement above 30 MHz and up to 1 GHz

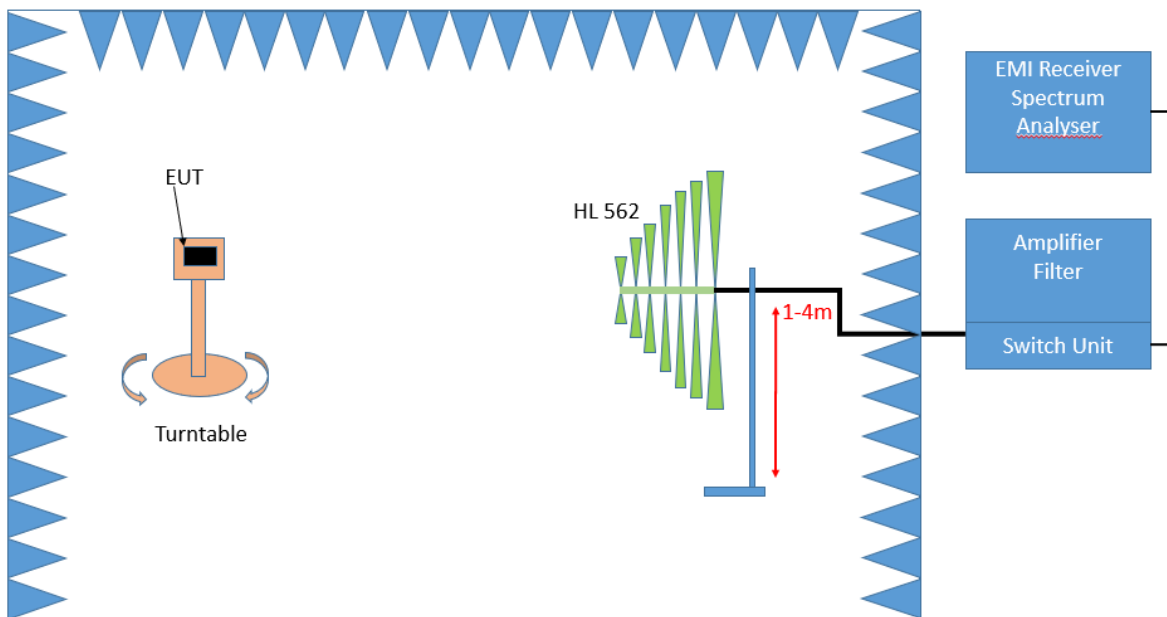

Test Setup; Spurious Emission Radiated (SAC), 30 MHz- 1GHz

Step 1: Preliminary scan

This is a preliminary test to identify the highest amplitudes relative to the limit.

Settings for step 1:

- Antenna distance: 3 m
- Detector: Peak-Maxhold / Quasipeak (FFT-based)
- Frequency range: 30 - 1000 MHz
- Frequency steps: 30 kHz
- IF-Bandwidth: 120 kHz
- Measuring time / Frequency step: 100 ms

- Turntable angle range: -180° to 90°
- Turntable step size: 90°
- Height variation range: 1 – 4 m
- Height variation step size: 1.5 m
- Polarisation: Horizontal + Vertical

Intention of this step is, to determine the radiated EMI-profile of the EUT. Afterwards the relevant emissions for the final measurement are identified.

Step 2: Adjustment measurement

In this step the accuracy of the turntable azimuth and antenna height will be improved. This is necessary to find out the maximum value of every frequency.

For each frequency, which was determined the turntable azimuth and antenna height will be adjusted. The turntable azimuth will slowly vary by $\pm 45^{\circ}$ around this value. During this action, the value of emission is continuously measured. The turntable azimuth at the highest emission will be recorded and adjusted. In this position, the antenna height will also slowly vary by ± 100 cm around the antenna height determined. During this action, the value of emission is also continuously measured. The antenna height of the highest emission will also be recorded and adjusted.

- Detector: Peak – Maxhold
- Measured frequencies: in step 1 determined frequencies
- IF – Bandwidth: 120 kHz
- Measuring time: 100 ms
- Turntable angle range: 360°
- Height variation range: 1 – 4 m
- Antenna Polarisation: max. value determined in step 1

Step 3: Final measurement with QP detector

With the settings determined in step 2, the final measurement will be performed:

EMI receiver settings for step 3:

- Detector: Quasi-Peak (< 1 GHz)
- Measured frequencies: in step 1 determined frequencies
- IF – Bandwidth: 120 kHz
- Measuring time: 1 s

After the measurement a plot will be generated which contains a diagram with the results of the preliminary scan and a chart with the frequencies and values of the results of the final measurement.

Above 1 GHz:

The Equipment Under Test (EUT) was set up on a non-conductive support (tilt device) at 1.5 m height in the fully-anechoic chamber.

All steps were performed with one height (1.5 m) of the receiving antenna only.

3. Measurement above 1 GHz

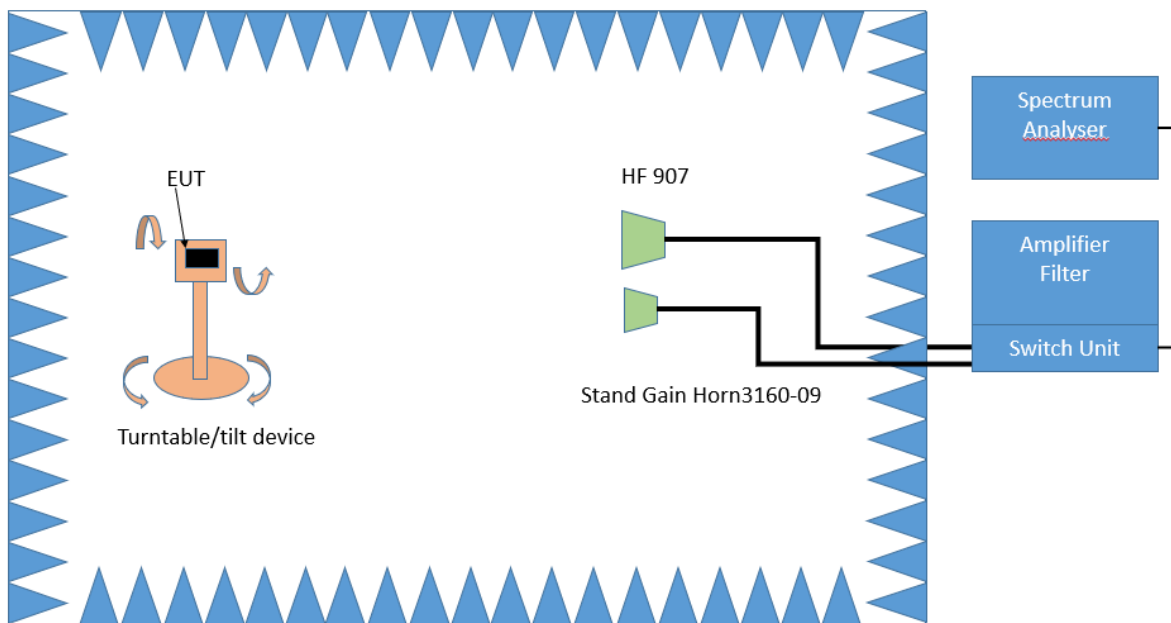

Test Setup; Spurious Emission Radiated (FAC), 1 GHz-26.5 GHz

Step 1:

The EUT is turned during the preliminary measurement across the elevation axis, with a step size of 90 °.

The turn table step size (azimuth angle) for the preliminary measurement is 45 °.

Spectrum analyser settings:

- Detector: Peak, Average
- RBW = 1 MHz
- VBW = 3 MHz

Step 2:

The turn table azimuth will slowly vary by $\pm 22.5^\circ$.

The elevation angle will slowly vary by $\pm 45^\circ$

Spectrum analyser settings:

- Detector: Peak

Step 3:

Spectrum analyser settings for step 3:

- Detector: Peak / CISPR Average
- Measured frequencies: in step 1 determined frequencies
- RBW = 1 MHz
- VBW = 3 MHz
- Measuring time: 1 s

Conducted Measurements at antenna ports

The Equipment Under Test (EUT) was set up to perform the spurious emissions measurements.

The EUT was connected to the test system as described in the block diagram below. The complete attenuation of the measurement path is known and considered.

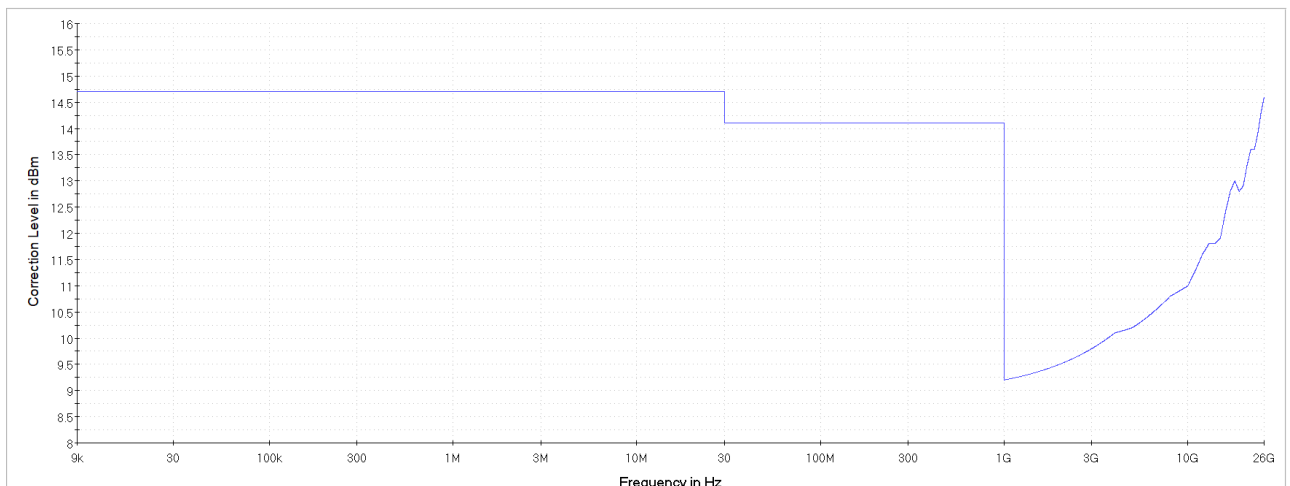
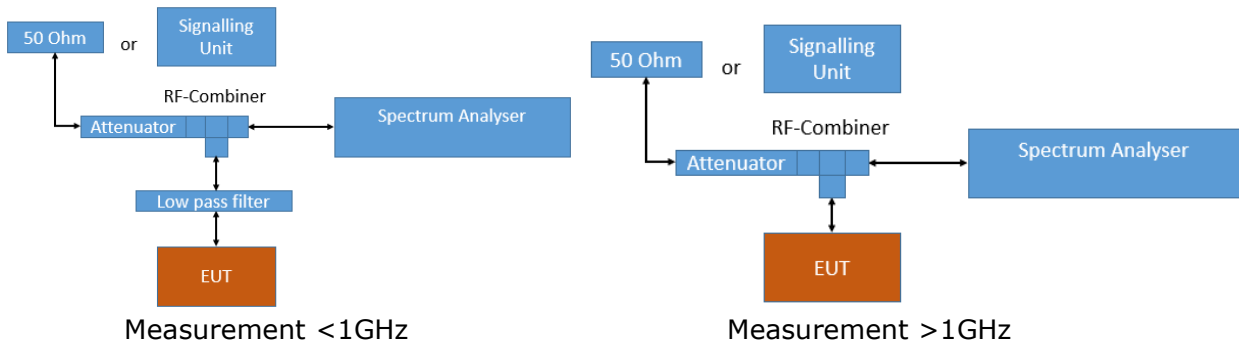

Analyser settings:

- Frequency range: 0.009 – 30 MHz
 - Resolution Bandwidth (RBW): 10 kHz
 - Video Bandwidth (VBW): 30 kHz
 - Trace: Maxhold
 - Sweeps: till stable
 - Sweep Time: coupled
 - Detector: Peak
-
- Frequency range: 30 – 1000 MHz
 - Resolution Bandwidth (RBW): 100 kHz
 - Video Bandwidth (VBW): 300 kHz
 - Trace: Maxhold
 - Sweeps: till stable
 - Sweep Time: coupled
 - Detector: Peak

- Frequency range: 1000 – 26000 MHz
- Resolution Bandwidth (RBW): 1000 kHz
- Video Bandwidth (VBW): 3000 kHz
- Trace: Maxhold, Average Power
- Sweeps: 500
- Sweep Time: coupled
- Detector: Peak, RMS

For the conducted emissions in restricted bands the Value is measured in dBm and then converted to dB μ V/m as given in KDB 558074:

1. Measure the conducted output power in dBm.
2. Add the maximum antenna gain in dBi. (Included in measurement result by offset)
3. Add the appropriate ground reflection factor (included in measurement result by transducer factor)
 - 6 dB for frequencies \leq 30 MHz;
 - 4.7 dB for frequencies between 30 MHz and 1000 MHz, inclusive; and
 - 0 dB for frequencies $>$ 1000 MHz).
4. Convert the resultant EIRP level to an equivalent electric field strength level using the following relationship:
 $E = \text{EIRP} - 20 \log D + 104.8$
Where E is the electric field strength in dB μ V/m,
EIRP is the equivalent isotropically radiated power in dBm
D is the specified measurement distance in m

Value [dB μ V/m] = Measured value [dBm] (including gain and ground reflection factor) – 20 log D + 104.8

5.6.2 TEST REQUIREMENTS / LIMITS

FCC Part 15, Subpart C, §15.247 (d)

... In addition, radiated emissions which fall in the restricted bands, as defined in Section 15.205(a), must also comply with the radiated emission limits specified in Section 15.209(a) (see Section 15.205(c)).

FCC Part 15, Subpart C, §15.209, Radiated Emission Limits

Frequency in MHz	Limit ($\mu\text{V}/\text{m}$)	Measurement distance (m)	Limits ($\text{dB}\mu\text{V}/\text{m}$)
0.009 – 0.49	2400/F(kHz)@300m	3	(48.5 – 13.8)@300m
0.49 – 1.705	24000/F(kHz)@30m	3	(33.8 – 23.0)@30m
1.705 – 30	30@30m	3	29.5@30m

The measured values are corrected with an inverse linear distance extrapolation factor (40 dB/decade) according FCC 15.31 (2).

Frequency in MHz	Limit ($\mu\text{V}/\text{m}$)	Measurement distance (m)	Limits ($\text{dB}\mu\text{V}/\text{m}$)
30 – 88	100@3m	3	40.0@3m
88 – 216	150@3m	3	43.5@3m
216 – 960	200@3m	3	46.0@3m
960 - 26000	500@3m	3	54.0@3m
26000 - 40000	500@3m	1	54.0@3m

The measured values above 26 GHz are corrected with an inverse linear distance extrapolation factor (20 dB/decade).

§15.35(b) ..., there is also a limit on the radio frequency emissions, as measured using instrumentation with a peak detector function, corresponding to 20 dB above the maximum permitted average limit....

Used conversion factor: $\text{Limit (dB}\mu\text{V}/\text{m)} = 20 \log (\text{Limit } (\mu\text{V}/\text{m})/1\mu\text{V}/\text{m})$

5.6.3 TEST PROTOCOL

Ambient temperature: 24 -30 °C
 Air Pressure: 990 - 1020 hPa
 Humidity: 30 -40 %

BT GFSK (1-DH5)

Applied duty cycle correction (AV): 2.3 dB

Variant / Test Method	Ch. Center Freq. [MHz]	Spurious Freq. [MHz]	Spurious Level [dBµV/m]	Detector	RBW [kHz]	Limit [dBµV/m]	Margin to Limit [dB]	Limit Type
354 / Conducted	2402	-	---	---	---	---	---	RB
354 / Conducted	2441	-	---	---	---	---	---	RB
354 / Radiated	2480	2484.16	37.4	AV	1000	54	16.6	RB
354 / Radiated	2480	2484.16	55.1	PEAK	1000	74	18.9	RB
354 / Radiated	2480	4959.71	55.1	PEAK	1000	74	18.9	RB
354 / Radiated	2480	4959.71	50.1	AV	1000	54	3.9	RB
354 / Radiated	2480	4960.04	55.5	PEAK	1000	74	18.5	RB
354 / Radiated	2480	4960.04	51.8	AV	1000	54	2.2	RB
354 / Conducted	2480	-	---	---	---	---	---	RB

BT π/4 DQPSK (2-DH5)

Applied duty cycle correction (AV): 2.3 dB

Variant / Test Method	Ch. Center Freq. [MHz]	Spurious Freq. [MHz]	Spurious Level [dBµV/m]	Detector	RBW [kHz]	Limit [dBµV/m]	Margin to Limit [dB]	Limit Type
354 / Conducted	2402	-	---	---	---	---	---	RB
354 / Conducted	2441	-	---	---	---	---	---	RB
354 / Conducted	2480	-	---	---	---	---	---	RB

BT 8-DPSK (3-DH5)

Applied duty cycle correction (AV): 2.3 dB

Variant / Test Method	Ch. Center Freq. [MHz]	Spurious Freq. [MHz]	Spurious Level [dBµV/m]	Detector	RBW [kHz]	Limit [dBµV/m]	Margin to Limit [dB]	Limit Type
354 / Conducted	2402	-	---	---	---	---	---	RB
354 / Conducted	2441	-	---	---	---	---	---	RB
354 / Conducted	2480	-	---	---	---	---	---	RB

BT LE 1Mbps

Applied duty cycle correction (AV): 4.2 dB

Variant / Test Method	Ch. Center Freq. [MHz]	Spurious Freq. [MHz]	Spurious Level [dB μ V/m]	Detector	RBW [kHz]	Limit [dB μ V/m]	Margin to Limit [dB]	Limit Type
354 / Conducted	2402	-	---	---	---	---	---	RB
354 / Conducted	2440	-	---	---	---	---	---	RB
354 / Conducted	2480	-	---	---	---	---	---	RB

BT LE 2Mbps

Applied duty cycle correction (AV): 9.7 dB

Variant / Test Method	Ch. Center Freq. [MHz]	Spurious Freq. [MHz]	Spurious Level [dB μ V/m]	Detector	RBW [kHz]	Limit [dB μ V/m]	Margin to Limit [dB]	Limit Type
354 / Conducted	2402	-	---	---	---	---	---	RB
354 / Conducted	2440	-	---	---	---	---	---	RB
354 / Conducted	2480	-	---	---	---	---	---	RB

WLAN b

Applied duty cycle correction (AV): 0 dB

Variant / Test Method	Ch. Center Freq. [MHz]	Spurious Freq. [MHz]	Spurious Level [dB μ V/m]	Detector	RBW [kHz]	Limit [dB μ V/m]	Margin to Limit [dB]	Limit Type
354 / Conducted	2412	-	---	---	---	---	---	RB
354 / Conducted	2437	-	---	---	---	---	---	RB
354 / Radiated	2462	2484.243	48.2	PEAK	1000	74	25.8	RB
354 / Radiated	2462	2484.243	34.8	AV	1000	54	19.2	RB
354 / Radiated	2462	19695.75	54.7	PEAK	1000	74	19.3	RB
354 / Radiated	2462	19695.75	48.8	AV	1000	54	5.2	RB
354 / Conducted	2462	-	---	---	---	---	---	RB

Remark: Please see next sub-clause for the measurement plot.

5.6.4 MEASUREMENT PLOT (EXAMPLE PLOT, SHOWING WORST CASE, IF APPLICABLE)

Radio Technology = Bluetooth BDR, Operating Frequency = low, Measurement range = 9 kHz - 30 MHz

(S01_354_AA01)

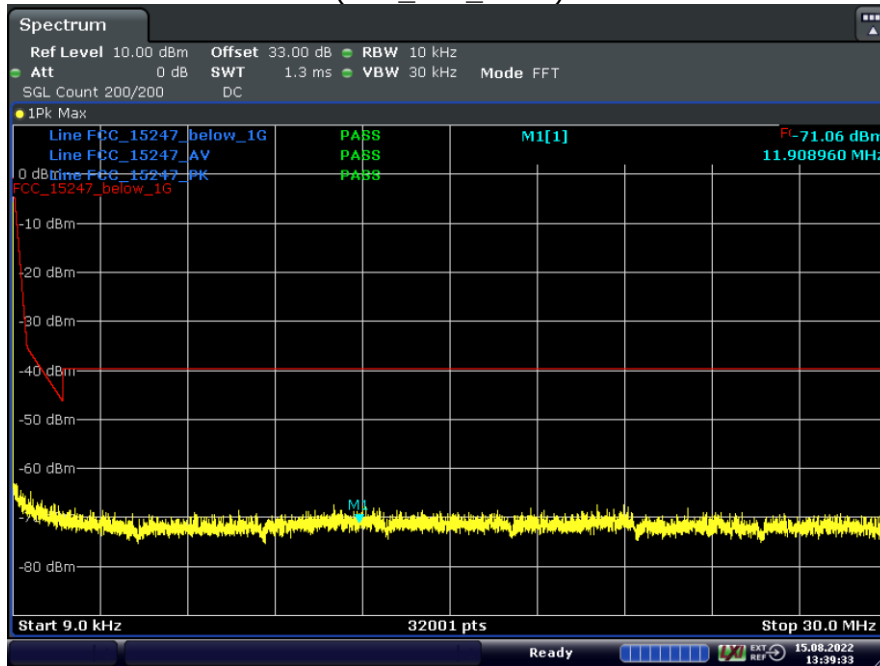

Date: 15.AUG.2022 13:39:34

Radio Technology = Bluetooth BDR, Operating Frequency = low, Measurement range = 30 MHz - 1 GHz

(S01_354_AB01)

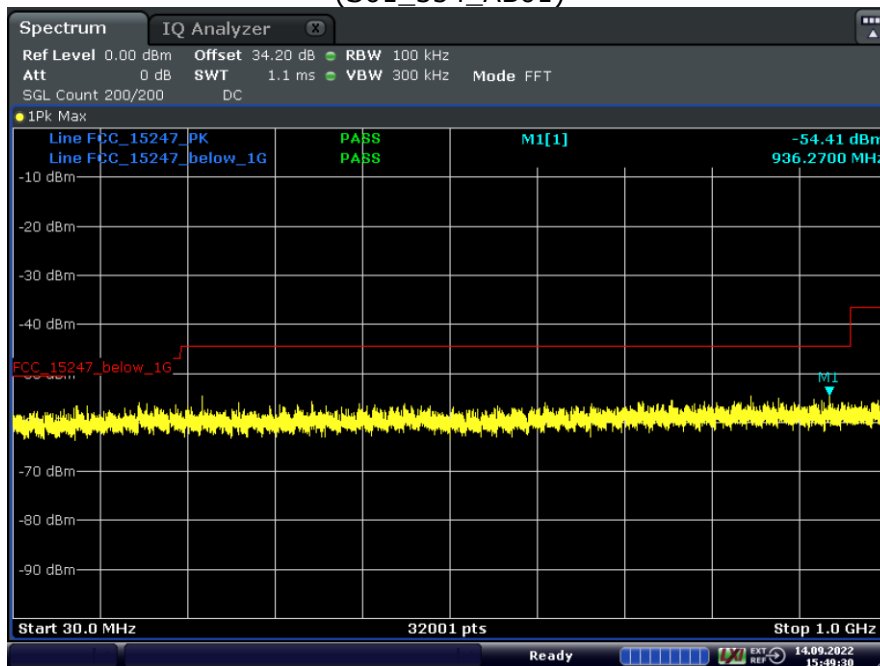

Date: 14.SEP.2022 15:49:30

Radio Technology = Bluetooth BDR, Operating Frequency = low, Measurement range = 1 GHz
 - 13 GHz
 (S01_354_AA01)

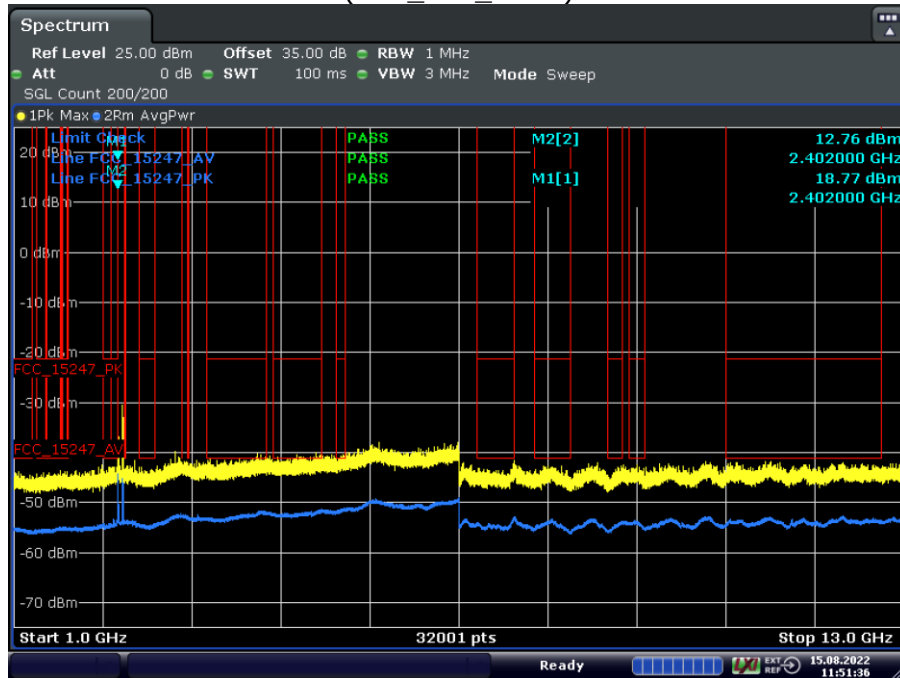

Date: 15.AUG.2022 11:51:37

Radio Technology = Bluetooth BDR, Operating Frequency = low, Measurement range = 13 GHz
 - 26 GHz
 (S01_354_AA01)

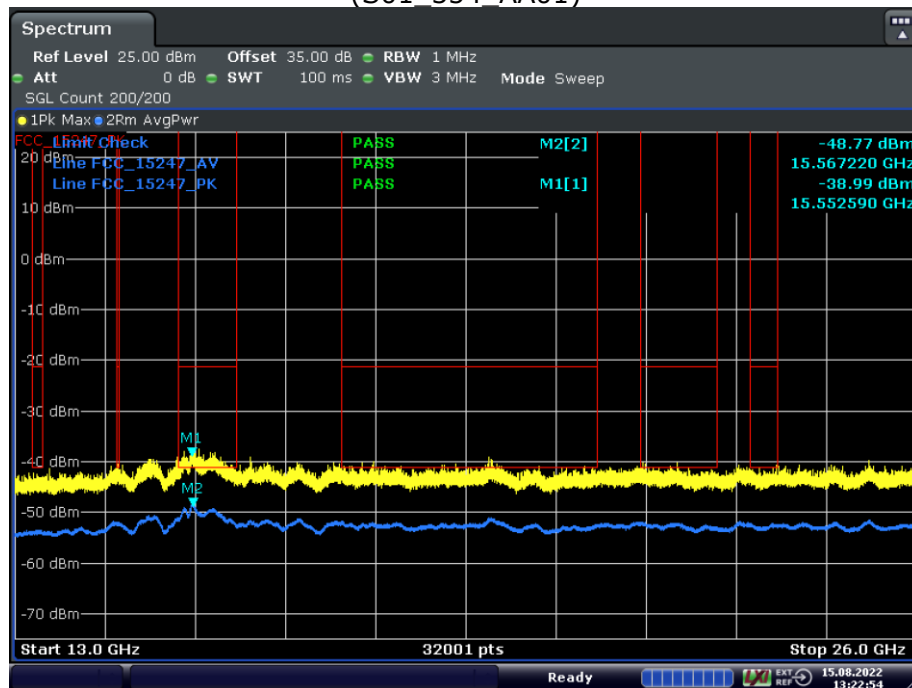

Date: 15.AUG.2022 13:22:55

Radio Technology = Bluetooth BDR, Operating Frequency = mid, Measurement range = 9 kHz - 30 MHz
(S02_354_AB01)

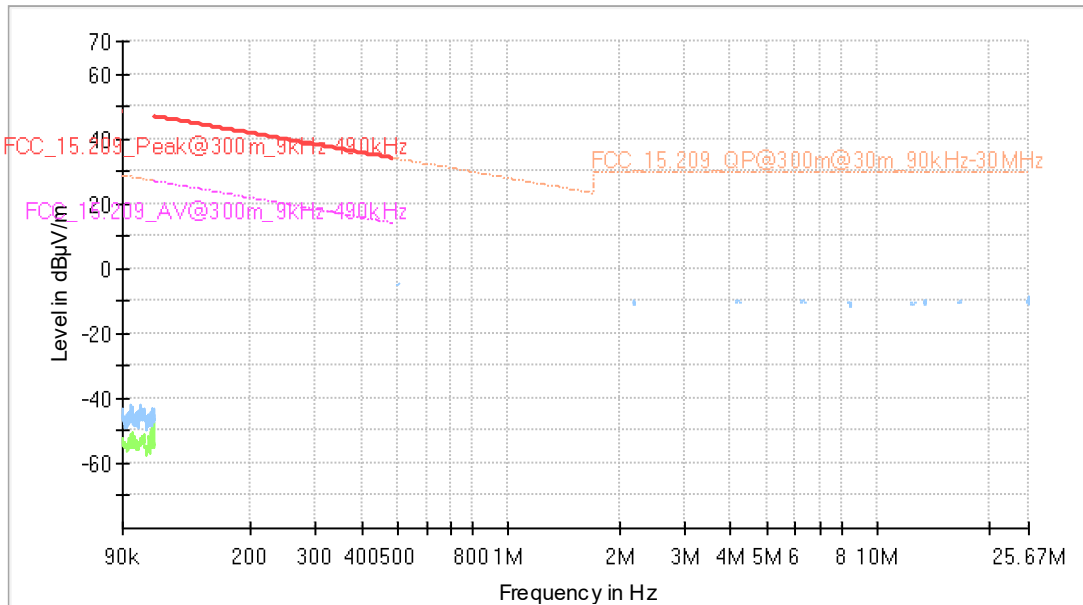

Radio Technology = Bluetooth BDR, Operating Frequency = high, Measurement range = 30 MHz - 1 GHz
(S02_354_AB01)

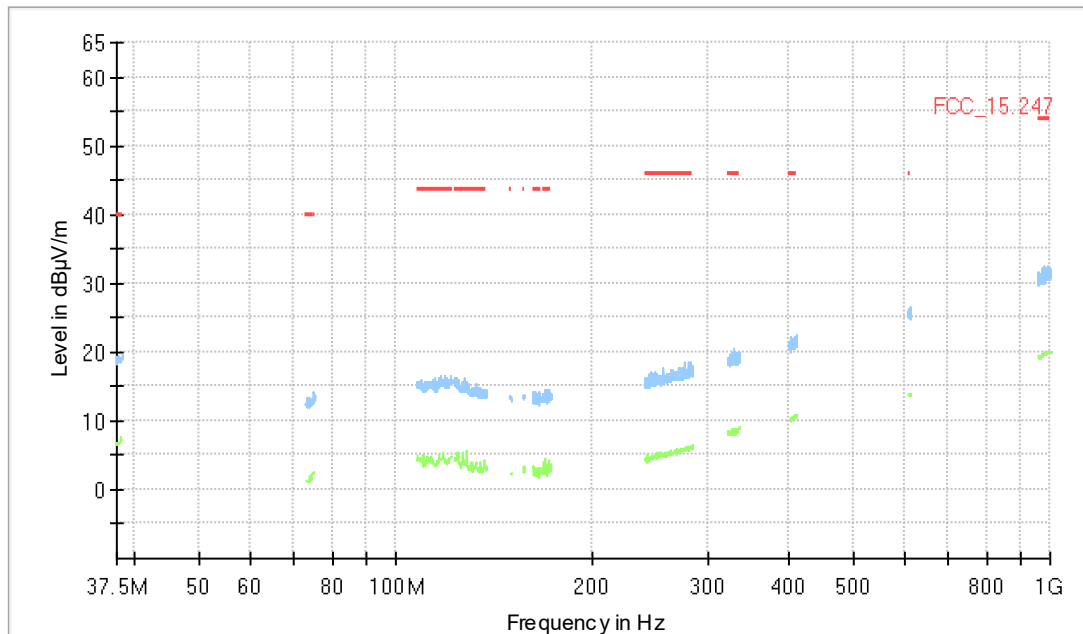

Radio Technology = Bluetooth BDR, Operating Frequency = high, Measurement range = 1 GHz
 - 26 GHz
 (S02_354_AB01)

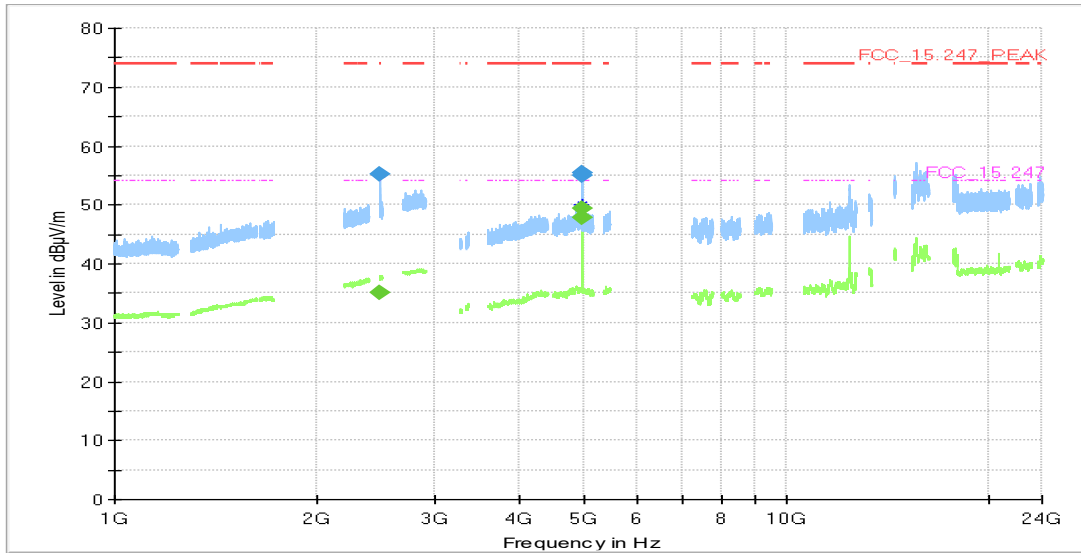

Frequency (MHz)	MaxPeak (dBµV/m)	CAverage (dBµV/m)	Limit (dBµV/m)	Margin (dB)	Meas. Time (ms)	Bandwidth (kHz)	Height (cm)	Pol	Azimuth (deg)	Elevation (deg)	Corr. (dB/m)
2484.160	---	35.1	54.00	18.86	1000.0	1000.000	150.0	V	-74.0	26.0	5.3
2484.160	55.1	---	74.00	18.90	1000.0	1000.000	150.0	V	-74.0	26.0	5.3
4959.713	55.1	---	74.00	18.93	1000.0	1000.000	150.0	H	4.0	107.0	4.4
4959.713	---	47.8	54.00	6.24	1000.0	1000.000	150.0	H	4.0	107.0	4.4
4960.038	55.5	---	74.00	18.50	1000.0	1000.000	150.0	H	13.0	98.0	4.4
4960.038	---	49.5	54.00	4.53	1000.0	1000.000	150.0	H	13.0	98.0	4.4

Radio Technology = Bluetooth LE 1 Mbps, Operating Frequency = low, Measurement range = 9 kHz - 30 MHz
(S01_354_AA01)

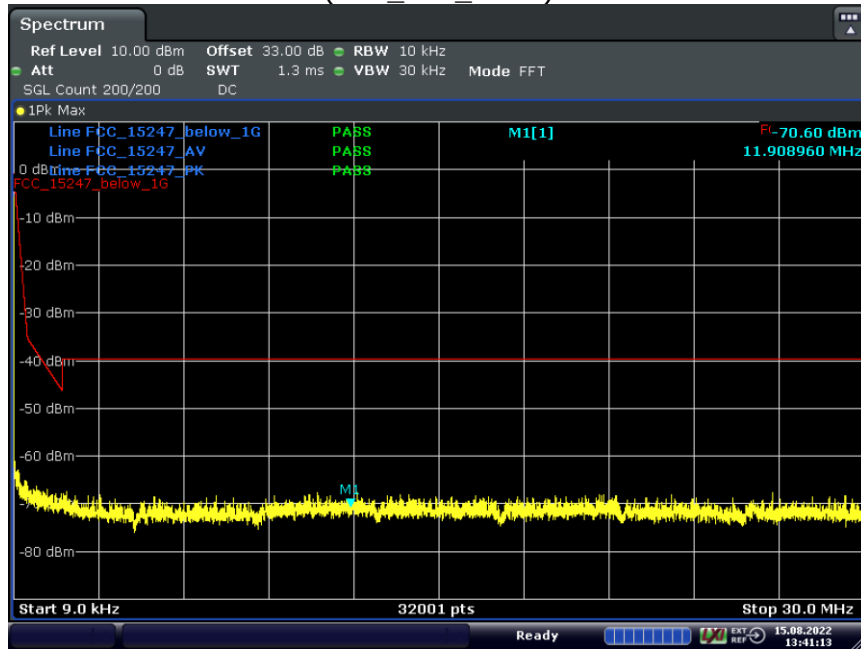

Date: 15.AUG.2022 13:41:13

Radio Technology = Bluetooth LE 1 Mbps, Operating Frequency = low, Measurement range = 30 MHz - 1 GHz
(S01_354_AB01)

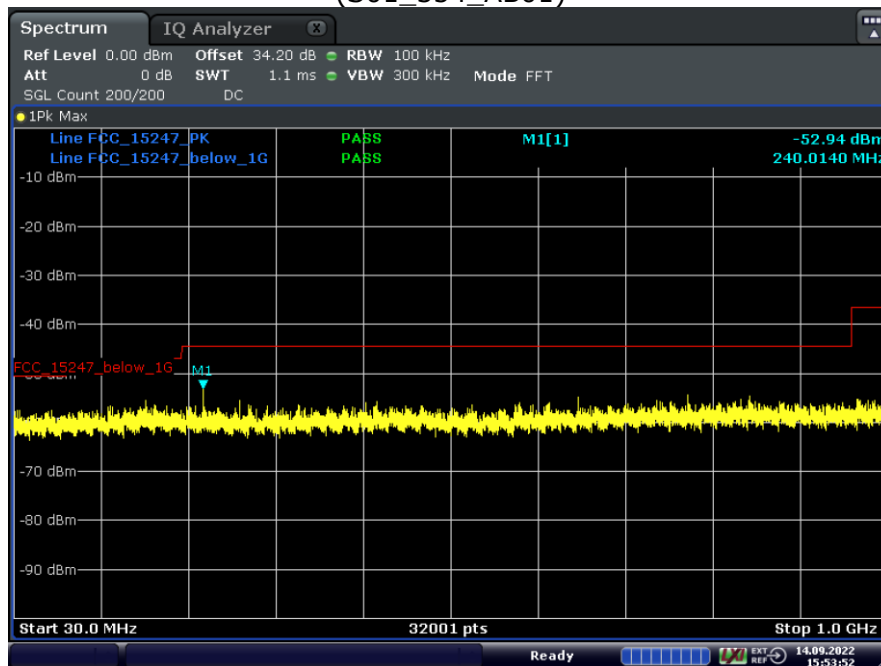

Date: 14.SEP.2022 15:53:53

Radio Technology = Bluetooth LE 1 Mbps, Operating Frequency = low, Measurement range = 1 GHz - 13 GHz
(S01_354_AA01)

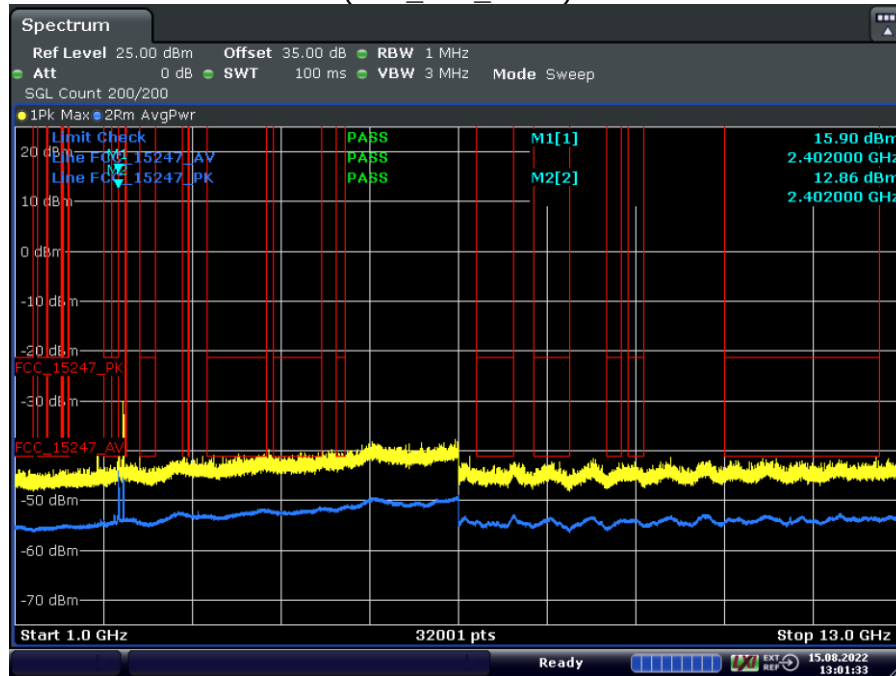

Date: 15.AUG.2022 13:01:33

Radio Technology = Bluetooth LE 1 Mbps, Operating Frequency = low, Measurement range = 13 GHz - 26 GHz
(S01_354_AA01)

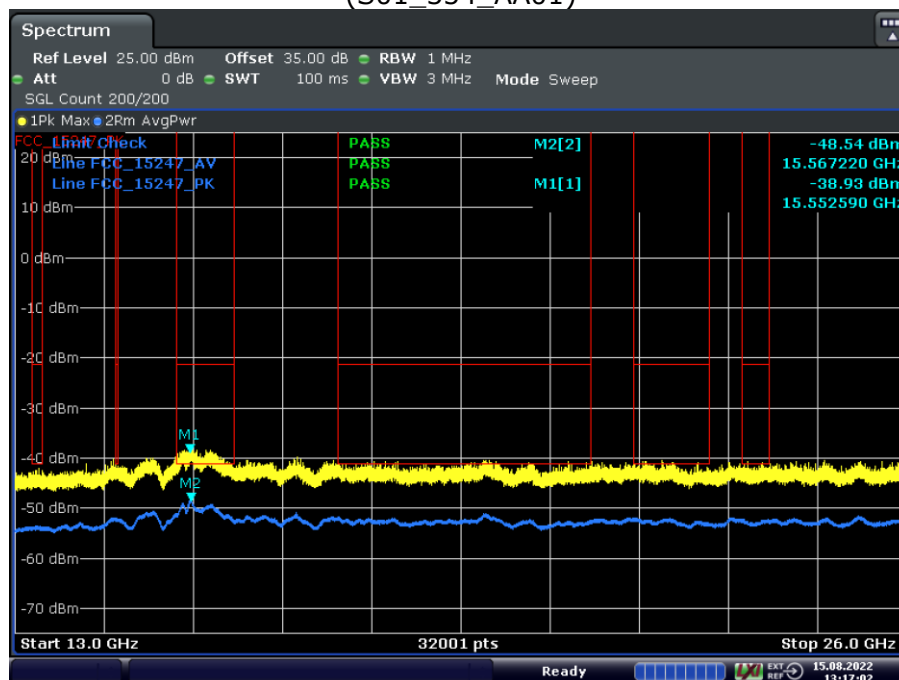

Date: 15.AUG.2022 13:17:03

Radio Technology = WLAN b, Operating Frequency = low, Measurement range = 9 kHz - 30 MHz
 (S01_354_AA01)

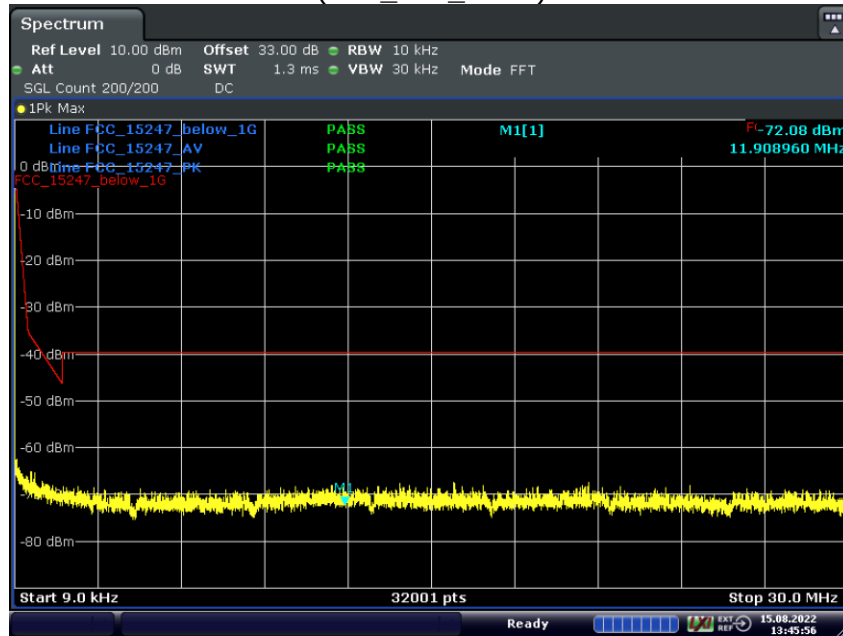

Date: 15.AUG.2022 13:45:56

Radio Technology = WLAN b, Operating Frequency = low, Measurement range = 30 MHz - 1 GHz
 (S01_354_AA01)

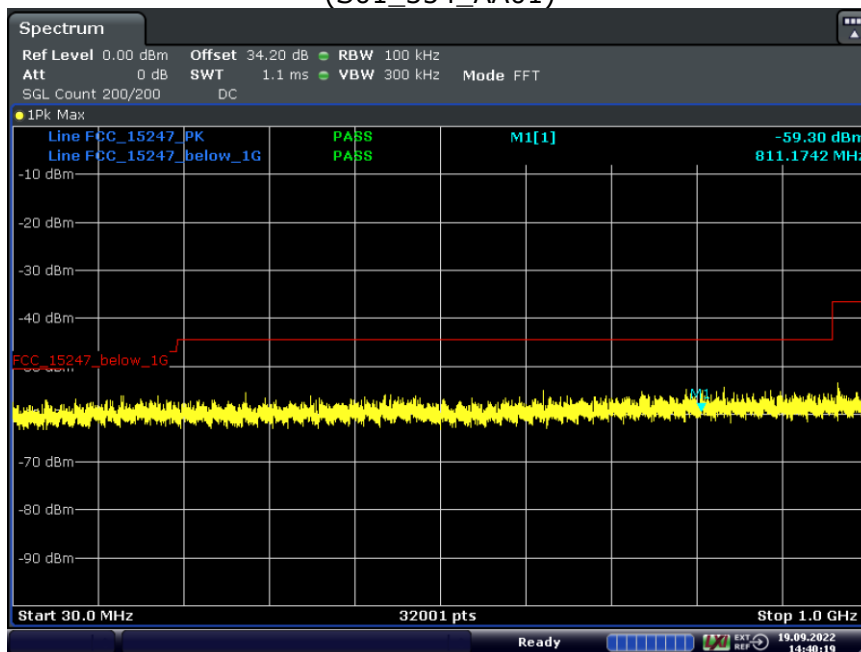

Date: 19.SEP.2022 14:40:19

Radio Technology = WLAN b, Operating Frequency = mid, Measurement range = 1 GHz - 13 GHz
 (S01_354_AA01)

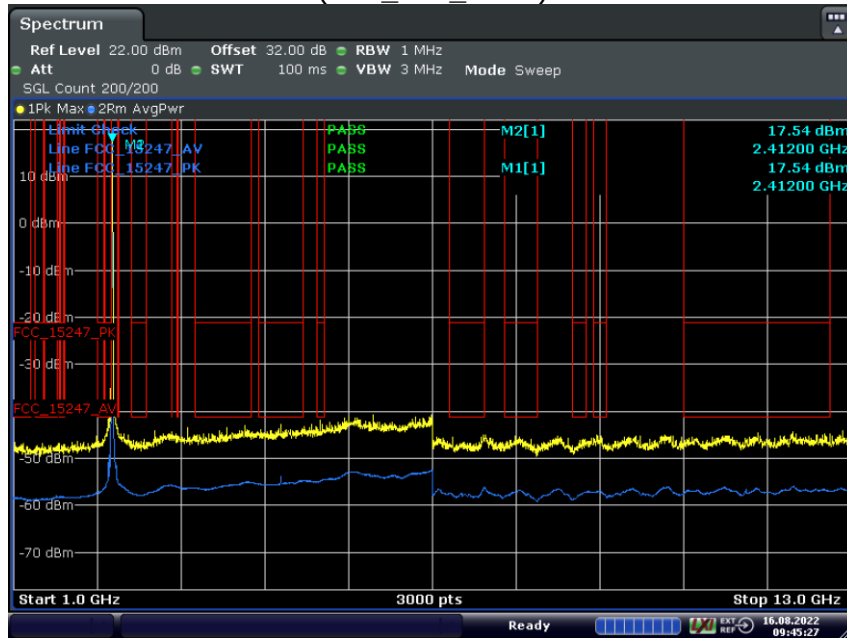

Radio Technology = WLAN b, Operating Frequency = mid, Measurement range = 13 GHz - 26 GHz
 (S01_354_AA01)

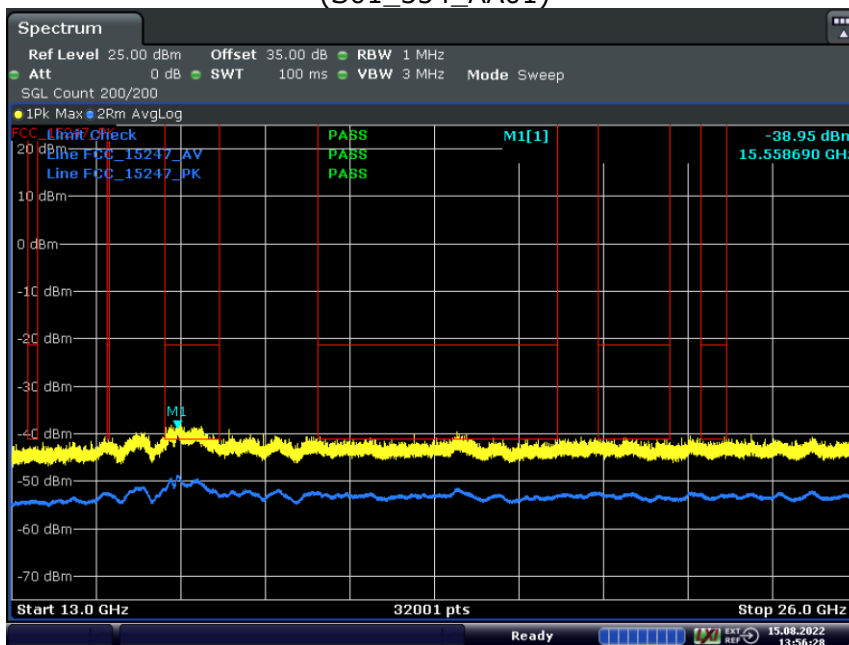

Radio Technology = Bluetooth BDR, Operating Frequency = low, Measurement range = 30 MHz - 1 GHz
 (S02_374_BA01)

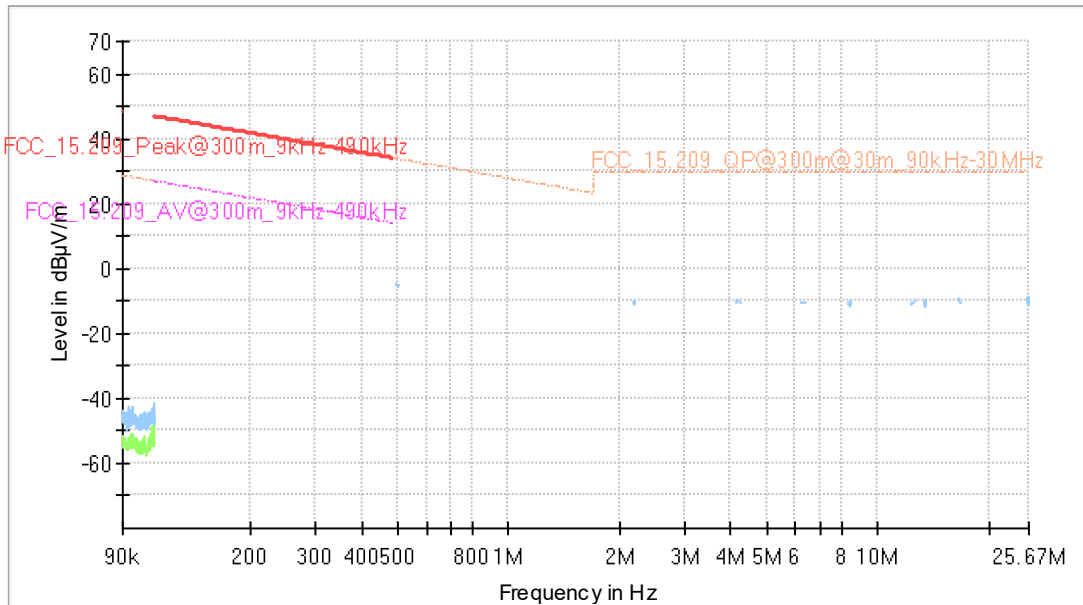

Radio Technology = Bluetooth BDR, Operating Frequency = high, Measurement range = 30 MHz - 1 GHz
 (S02_354_AB01)

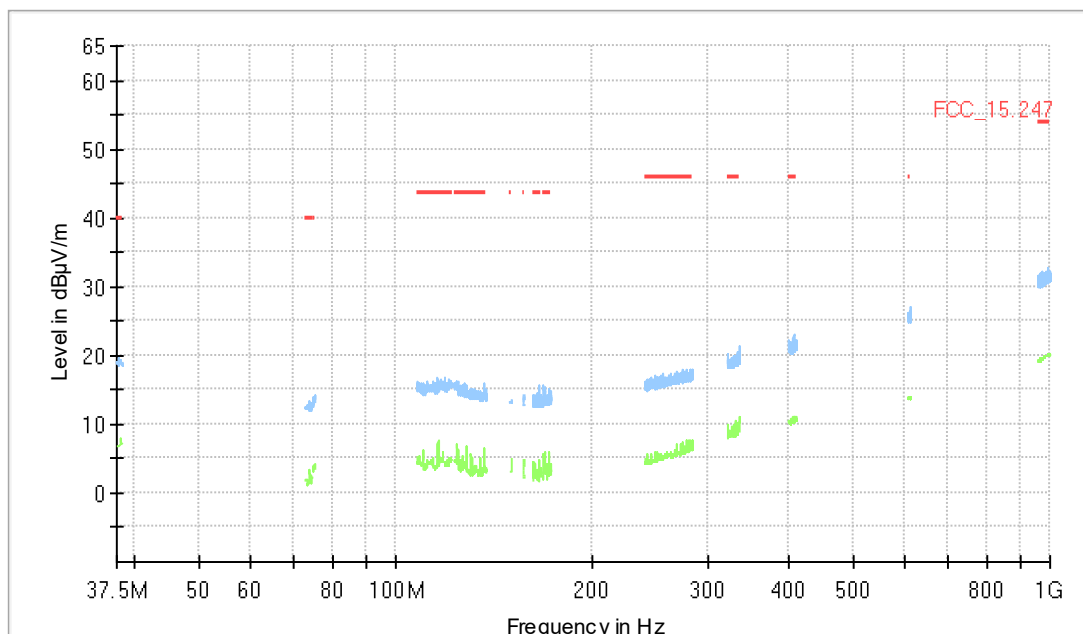

Radio Technology = Bluetooth BDR, Operating Frequency = high, Measurement range = 1 GHz
 - 26 GHz
 (S02_354_AB01)

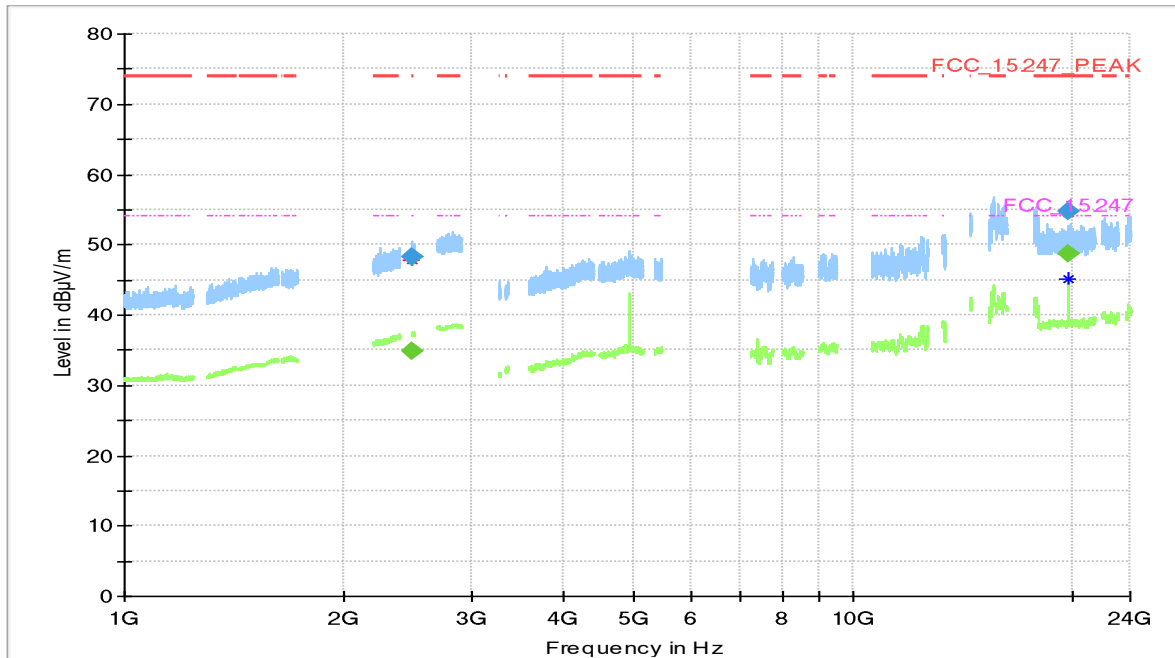

Frequency (MHz)	MaxPeak (dBµV/m)	CAverage (dBµV/m)	Limit (dBµV/m)	Margin (dB)	Meas. Time (ms)	Bandwidth (kHz)	Height (cm)	Pol	Azimuth (deg)	Elevation (deg)	Corr. (dB/m)
2484.243	48.2	---	74.00	25.79	1000.0	1000.000	150.0	H	28.0	-6.0	5.3
2484.243	---	34.8	54.00	19.22	1000.0	1000.000	150.0	H	28.0	-6.0	5.3
19695.750	54.7	---	74.00	19.29	1000.0	1000.000	150.0	V	19.0	105.0	17.4
19695.750	---	48.8	54.00	5.23	1000.0	1000.000	150.0	V	19.0	105.0	17.4

5.6.5 TEST EQUIPMENT USED

- Radiated Emissions FAR 2.4 GHz FCC
- Radiated Emissions SAC H-Field
- Radiated Emissions SAC up to 1 GHz
- R&S TS8997

5.7 BAND EDGE COMPLIANCE CONDUCTED

Standard **FCC Part 15 Subpart C**

The test was performed according to:
ANSI C63.10 11.11

5.7.1 TEST DESCRIPTION

For the conducted measurement, the Equipment Under Test (EUT) is placed in a shielded room. The reference power was measured in the test case "Spurious RF Conducted Emissions".

The EUT was connected to the test system as described in the block diagram below. The complete attenuation of the measurement path is known and considered.

Analyser settings:

- Lower Band Edge:
Measured range: 2310.0 MHz to 2483.5 MHz
Upper Band Edge
Measured range: 2400.0 MHz to 2500 MHz
- Detector: Peak
- Resolution Bandwidth (RBW): 100 kHz
- Video Bandwidth (VBW): 300 kHz
- Sweptime: Auto
- Sweeps: Till stable (min. 300, max. 15000)
- Trace: Maxhold

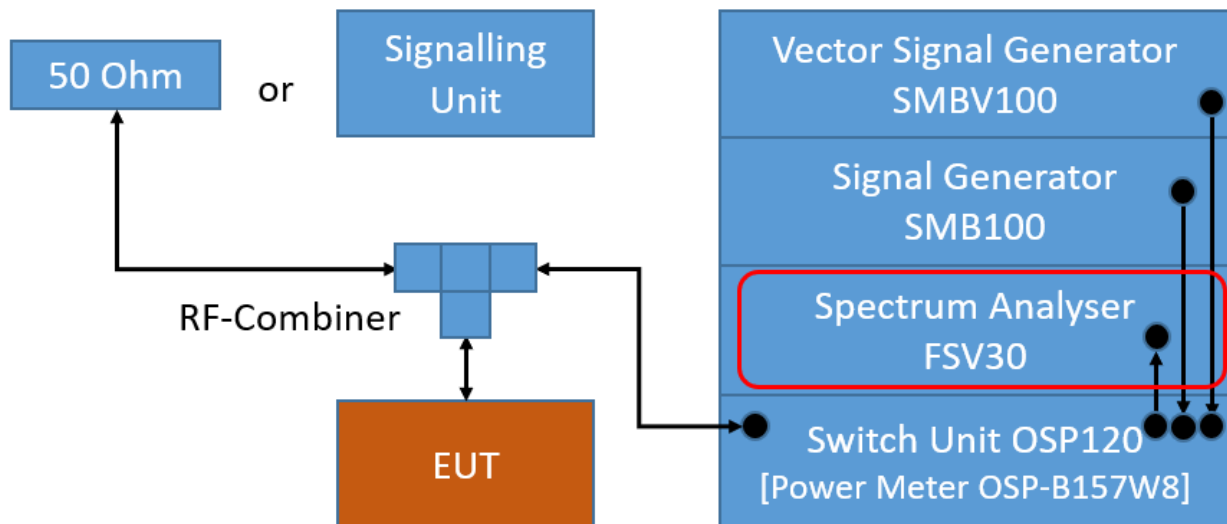

TS8997; Band Edge Conducted

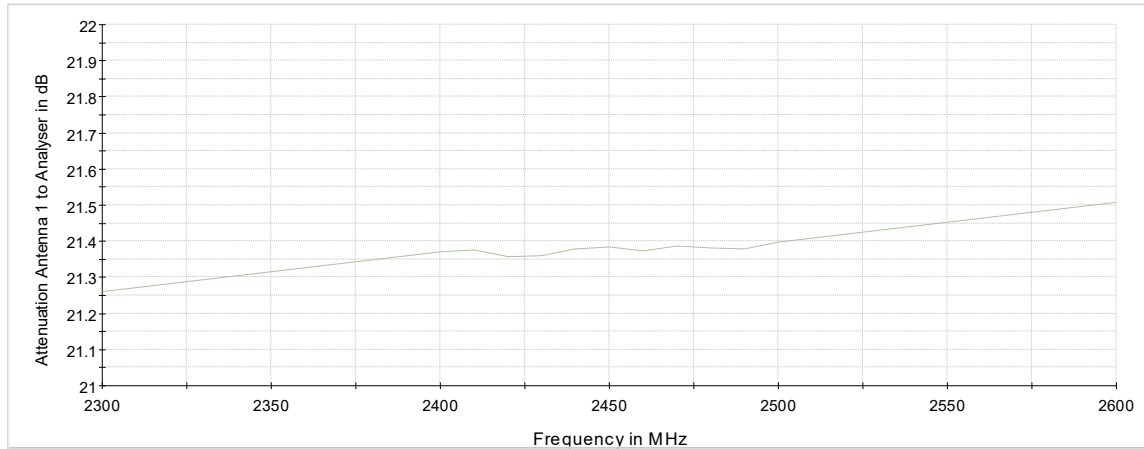

Attenuation of the measurement path

5.7.2 TEST REQUIREMENTS / LIMITS

FCC Part 15.247 (d)

“In any 100 kHz bandwidth outside the frequency band in which the spread spectrum or digitally modulated intentional radiator is operating, the radio frequency power that is produced by the intentional radiator shall be at least 20 dB below that in the 100 kHz bandwidth within the band that contains the highest level of the desired power, based on either an RF conducted or a radiated measurement, provided the transmitter demonstrates compliance with the peak conducted power limits. ...

If the transmitter complies with the conducted power limits based on the use of RMS averaging over a time interval, as permitted under paragraph (b)(3) of this section, the attenuation required under this paragraph shall be 30 dB instead of 20 dB. Attenuation below the general limits specified in Section 15.209(a) is not required. In addition, radiated emissions which fall in the restricted bands, as defined in Section 15.205(a), must also comply with the radiated emission limits specified in Section 15.209(a) (see Section 15.205(c)).”

For the conducted measurement the RF power at the band edge shall be “at least 20 dB below that in the 100 kHz bandwidth within the band that contains the highest level of the desired power...”

5.7.3 TEST PROTOCOL

Ambient temperature: 30 °C
 Air Pressure: 1005 hPa
 Humidity: 28 %

BT GFSK (1-DH5)

Channel No.	Channel Center Frequency [MHz]	Band Edge Freq. [MHz]	Spurious Level [dBm]	Detector	RBW [kHz]	Ref. Level [dBm]	Limit [dBm]	Margin to Limit [dB]
0	2402	2400.0	-45.2	PEAK	100	11.4	-8.6	36.6
78	2480	2483.5	-51.5	PEAK	100	11.3	-8.7	42.8
hopping	hopping	2400.0	-46.9	PEAK	100	11.5	-8.5	38.4
hopping	hopping	2483.5	-54.1	PEAK	100	11.4	-8.6	45.5

BT π/4 DQPSK (2-DH5)

Channel No.	Channel Center Frequency [MHz]	Band Edge Freq. [MHz]	Spurious Level [dBm]	Detector	RBW [kHz]	Ref. Level [dBm]	Limit [dBm]	Margin to Limit [dB]
0	2402	2400.0	-44.0	PEAK	100	8.5	-11.5	32.5
78	2480	2483.5	-47.4	PEAK	100	8.4	-11.6	35.8
hopping	hopping	2400.0	-49.9	PEAK	100	8.8	-11.2	38.7
hopping	hopping	2483.5	-57.6	PEAK	100	8.7	-11.3	46.3

BT 8-DPSK (3-DH5)

Channel No.	Channel Center Frequency [MHz]	Band Edge Freq. [MHz]	Spurious Level [dBm]	Detector	RBW [kHz]	Ref. Level [dBm]	Limit [dBm]	Margin to Limit [dB]
0	2402	2400.0	-42.0	PEAK	100	11.3	-8.7	33.3
78	2480	2483.5	-47.4	PEAK	100	8.4	-11.6	35.8
hopping	hopping	2400.0	-48.2	PEAK	100	11.4	-8.6	39.6
hopping	hopping	2483.5	-53.4	PEAK	100	11.4	-8.6	44.8

BT LE 1 Mbit/s

Channel No.	Channel Center Frequency [MHz]	Band Edge Freq. [MHz]	Spurious Level [dBm]	Detector	RBW [kHz]	Ref. Level [dBm]	Limit [dBm]	Margin to Limit [dB]
0	2402	2400.0	-48.8	PEAK	100	7.7	-12.3	36.5
39	2480	2483.5	-50.1	PEAK	100	7.6	-12.4	37.7