

Radio Technology = WLAN a, Operating Frequency = low, Measurement range = 1GHz - 26GHz, Subband = U-NII-2C (S02_377_AD01)

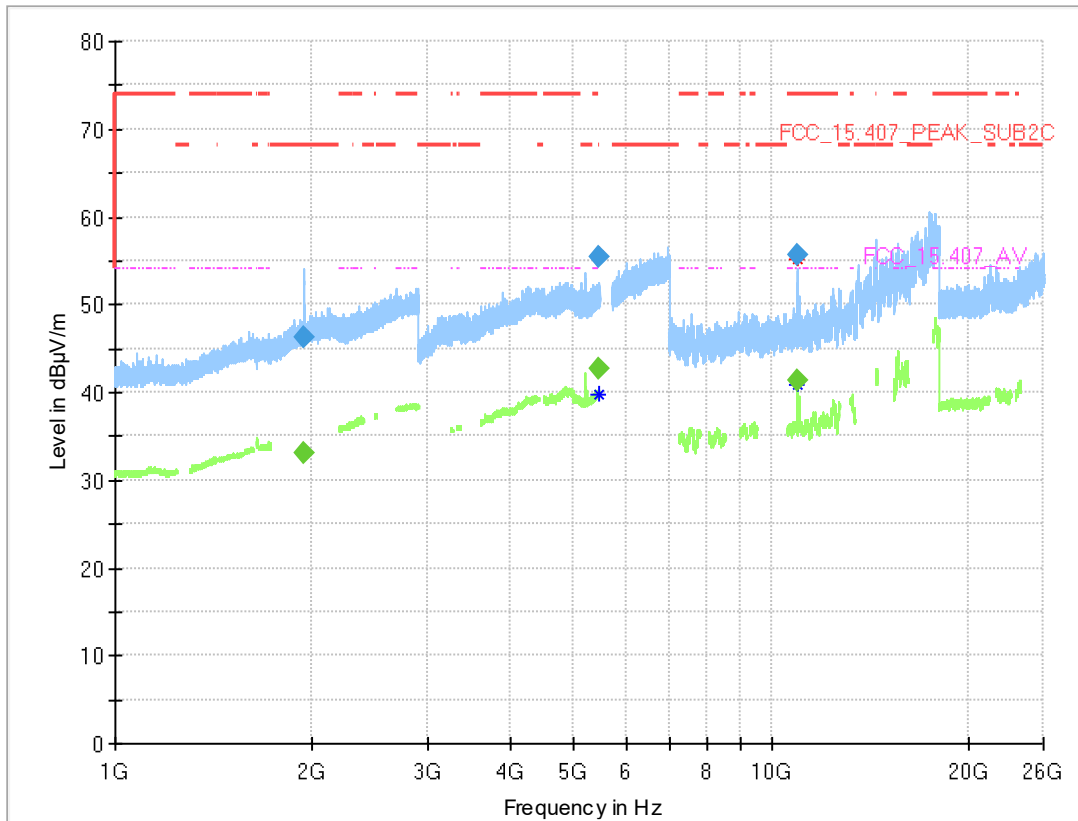

Final Result

Frequency (MHz)	MaxPeak (dBµV/m)	CAverage (dBµV/m)	Limit (dBµV/m)	Margin (dB)	Meas. Time (ms)	Bandwidth (kHz)	Height (cm)	Pol	Azimuth (deg)	Elevation (deg)	Corr. (dB/m)
1941.391	---	33.1	---	---	1000.0	1000.000	150.0	H	-191.0	15.0	3.7
1941.391	46.3	---	68.20	21.88	1000.0	1000.000	150.0	H	-191.0	15.0	3.7
5459.560	---	42.6	54.00	11.38	1000.0	1000.000	150.0	V	-85.0	105.0	14.5
5459.560	55.3	---	74.00	18.66	1000.0	1000.000	150.0	V	-85.0	105.0	14.5
11000.365	---	41.3	54.00	12.69	1000.0	1000.000	150.0	H	-34.0	83.0	-9.9
11000.365	55.6	---	74.00	18.44	1000.0	1000.000	150.0	H	-34.0	83.0	-9.9

Radio Technology = WLAN a, Operating Frequency = mid, Measurement range = 1GHz - 26GHz, Subband = U-NII-2C (S02_377_AD01)

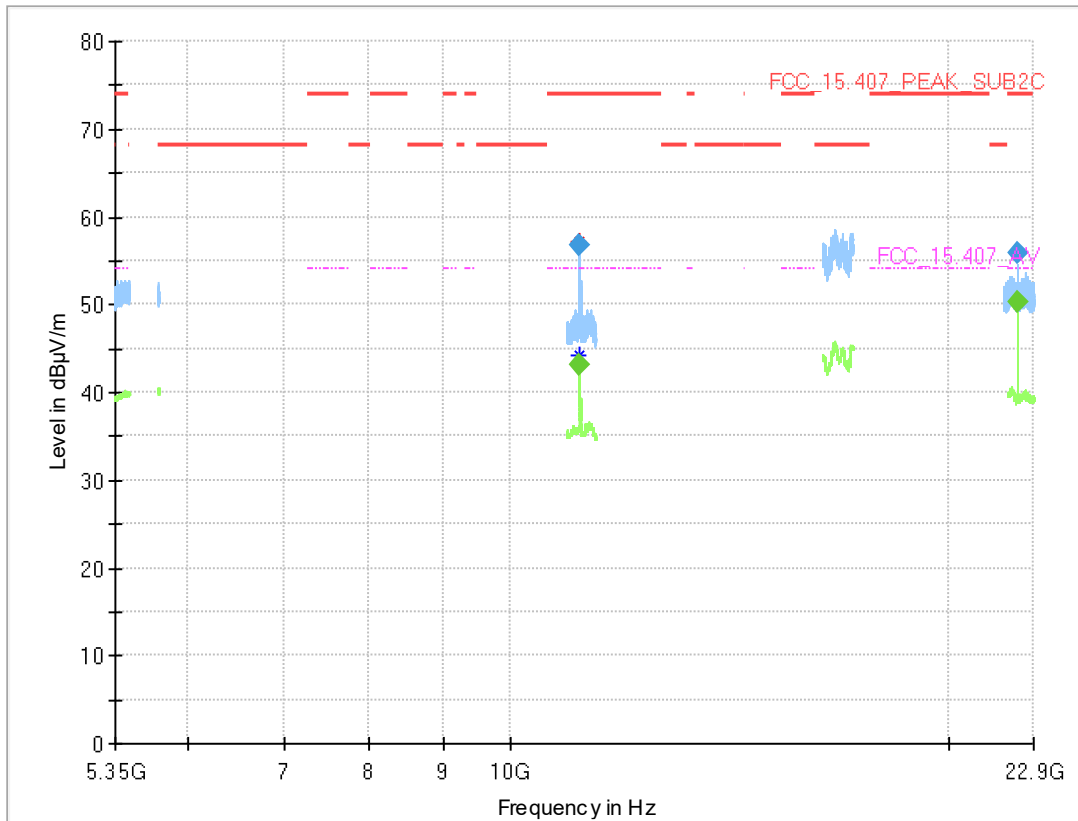

Final Result

Frequency (MHz)	MaxPeak (dBµV/m)	CAverage (dBµV/m)	Limit (dBµV/m)	Margin (dB)	Meas. Time (ms)	Bandwidth (kHz)	Height (cm)	Pol	Azimuth (deg)	Elevation (deg)	Corr. (dB/m)
11159.640	---	43.2	54.00	10.77	1000.0	1000.000	150.0	H	41.0	92.0	-10.1
11159.640	56.7	---	74.00	17.31	1000.0	1000.000	150.0	H	41.0	92.0	-10.1
22320.165	---	50.3	54.00	3.70	1000.0	1000.000	150.0	H	45.0	94.0	19.4
22320.165	55.8	---	74.00	18.24	1000.0	1000.000	150.0	H	45.0	94.0	19.4

Radio Technology = WLAN a, Operating Frequency = high, Measurement range = 1GHz - 26GHz, Subband = U-NII-2C (S02_377_AD01)

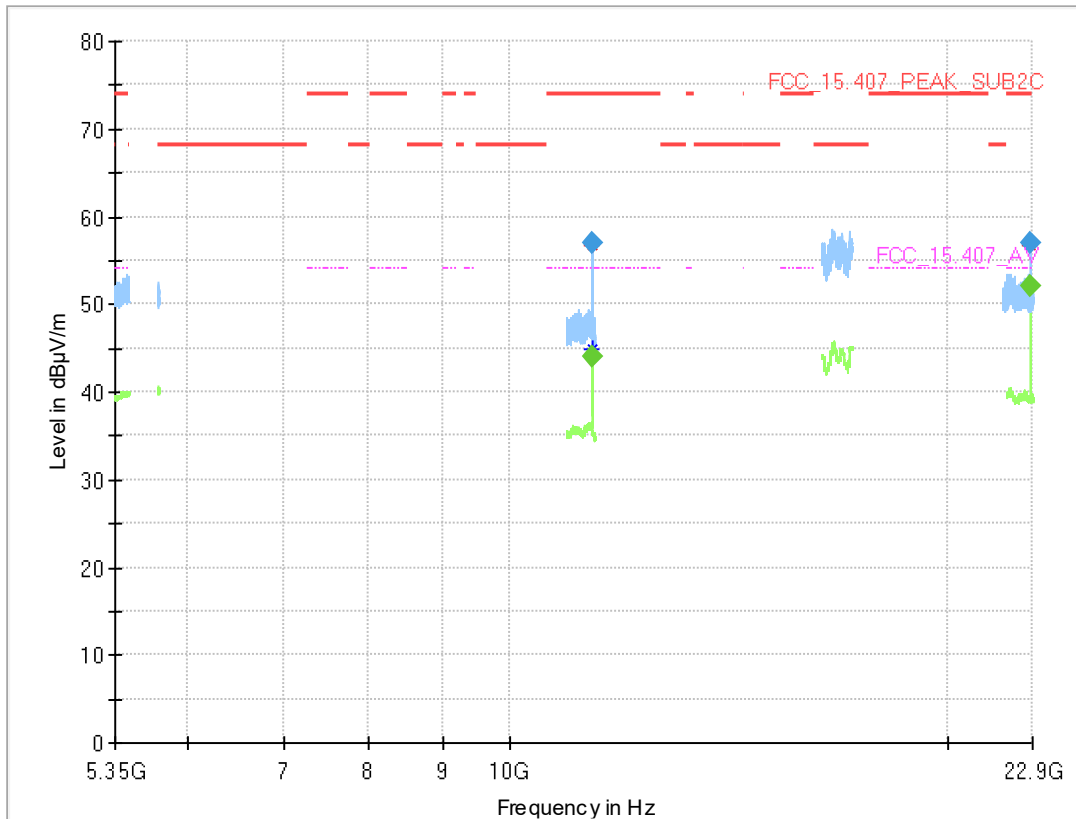

Final Result

Frequency (MHz)	MaxPeak (dBµV/m)	CAverage (dBµV/m)	Limit (dBµV/m)	Margin (dB)	Meas. Time (ms)	Bandwidth (kHz)	Height (cm)	Pol	Azimuth (deg)	Elevation (deg)	Corr. (dB/m)
11400.020	---	43.9	54.00	10.06	1000.0	1000.000	150.0	H	-1.0	105.0	-9.2
11400.020	57.0	---	74.00	16.98	1000.0	1000.000	150.0	H	-1.0	105.0	-9.2
22800.098	---	52.0	54.00	2.02	1000.0	1000.000	150.0	H	43.0	89.0	19.5
22800.098	57.0	---	74.00	16.97	1000.0	1000.000	150.0	H	43.0	89.0	19.5

Radio Technology = WLAN a, Operating Frequency = low, Measurement range = 1GHz - 26GHz, Subband = U-NII-3 (S02_377_AD01)

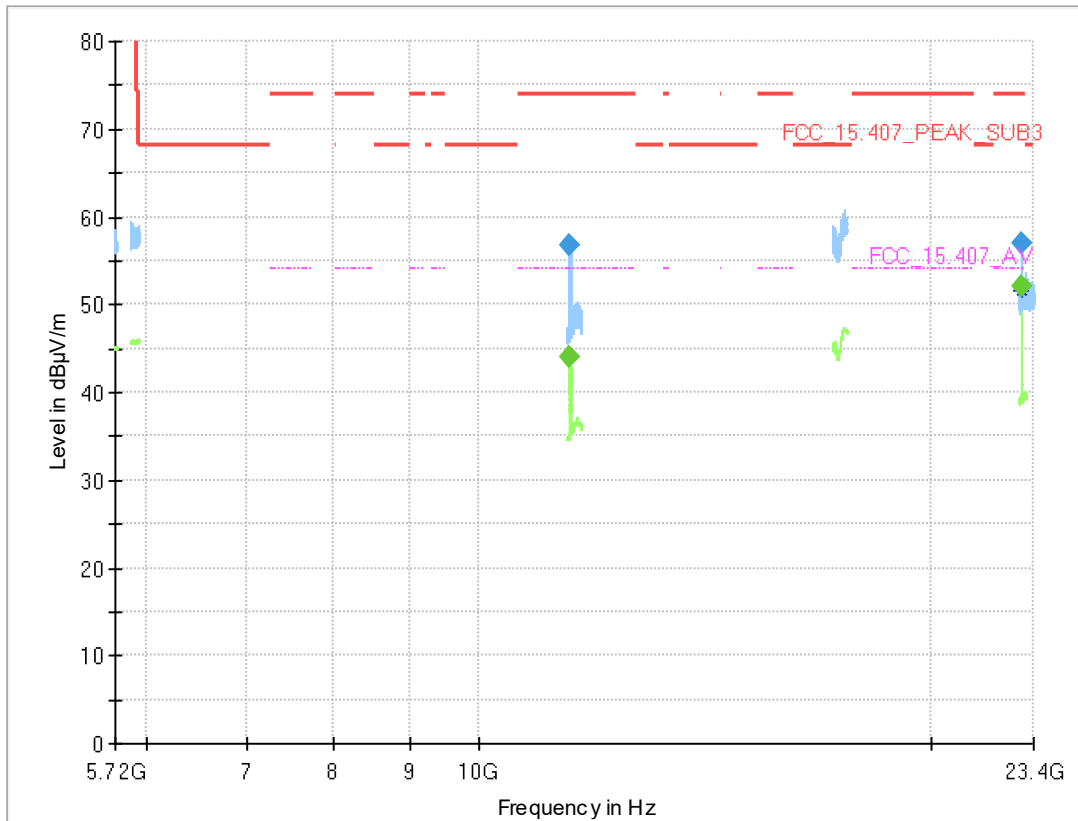

Final Result

Frequency (MHz)	MaxPeak (dBµV/m)	CAverage (dBµV/m)	Limit (dBµV/m)	Margin (dB)	Meas. Time (ms)	Bandwidth (kHz)	Height (cm)	Pol	Azimuth (deg)	Elevation (deg)	Corr. (dB/m)
11490.000	---	44.0	54.00	9.99	1000.0	1000.000	150.0	H	-10.0	105.0	-8.9
11490.000	56.8	---	74.00	17.20	1000.0	1000.000	150.0	H	-10.0	105.0	-8.9
22980.080	---	52.1	54.00	1.86	1000.0	1000.000	150.0	H	35.0	93.0	19.7
22980.080	57.0	---	74.00	17.04	1000.0	1000.000	150.0	H	35.0	93.0	19.7

Radio Technology = WLAN a, Operating Frequency = low, Measurement range = 1GHz - 26GHz, Subband = U-NII-1 (S01_377_AA01)

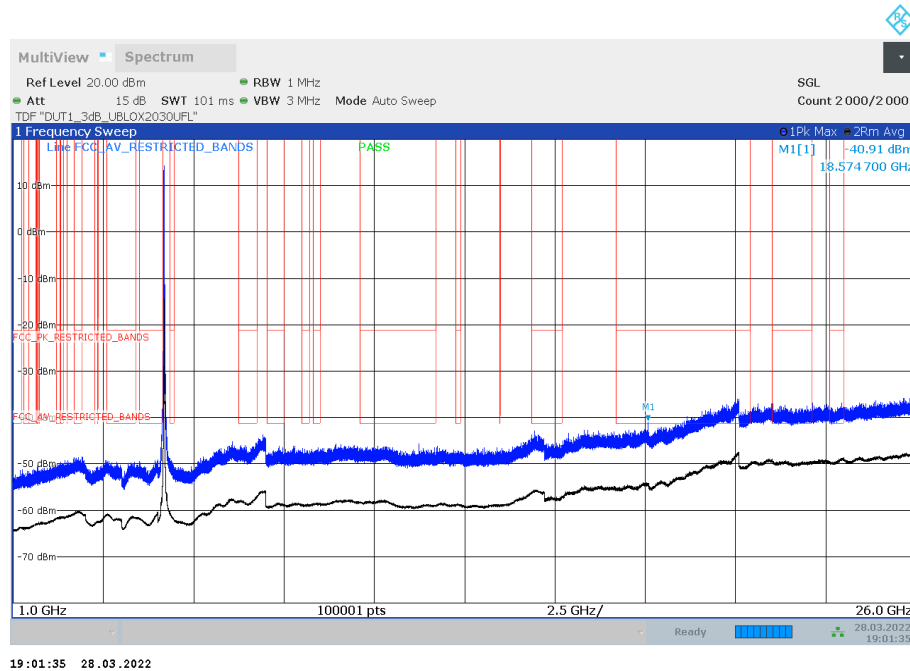

Radio Technology = WLAN a, Operating Frequency = mid, Measurement range = 1GHz - 26GHz, Subband = U-NII-1 (S01_377_AE01)

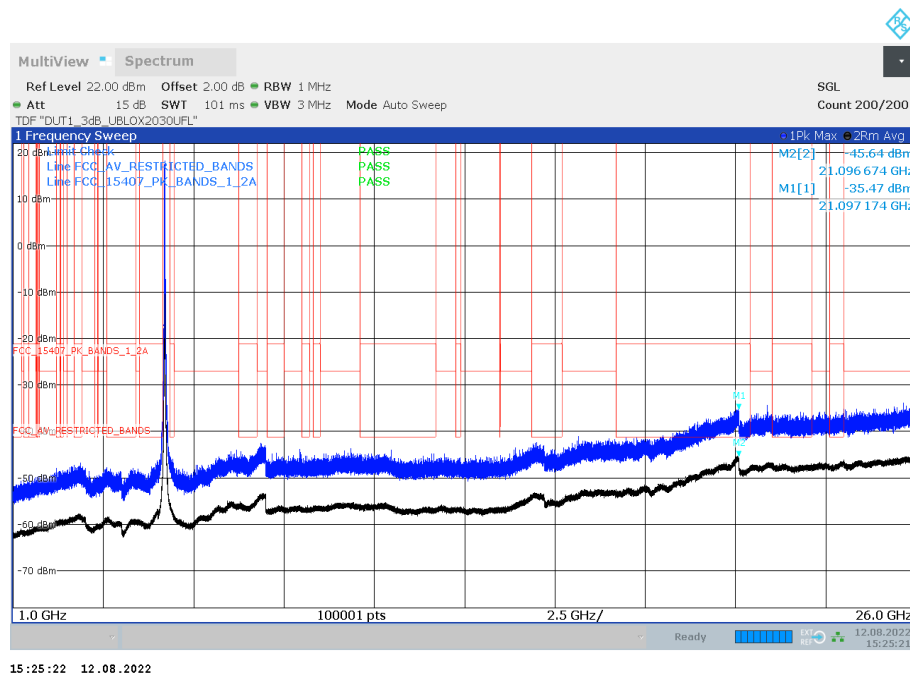

Radio Technology = WLAN a, Operating Frequency = high, Measurement range = 1GHz - 26GHz, Subband = U-NII-1 (S01_377_AE01)

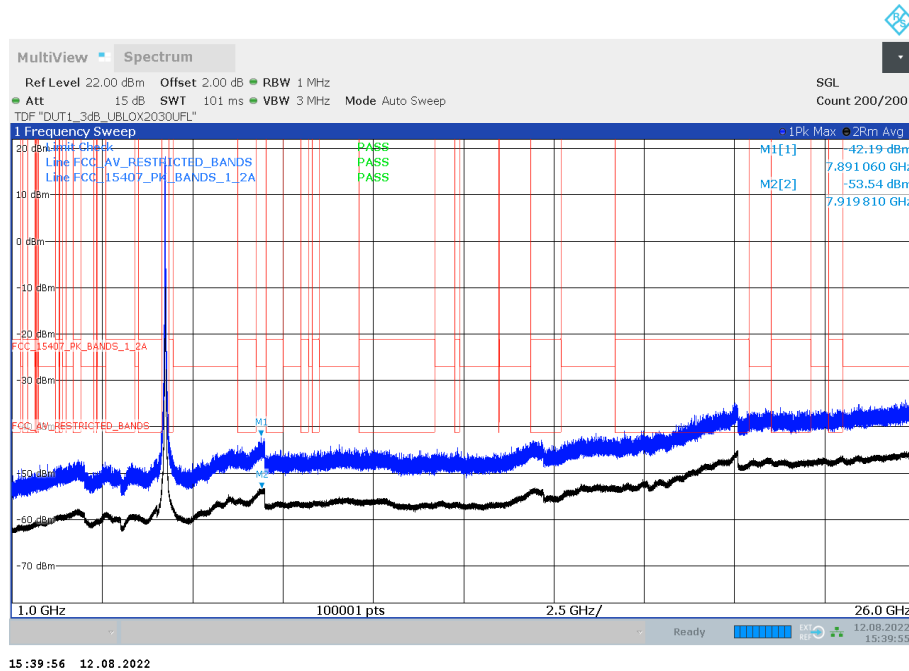

Radio Technology = WLAN a, Operating Frequency = low, Measurement range = 1GHz - 26GHz, Subband = U-NII-2A (S01_377_AE01)

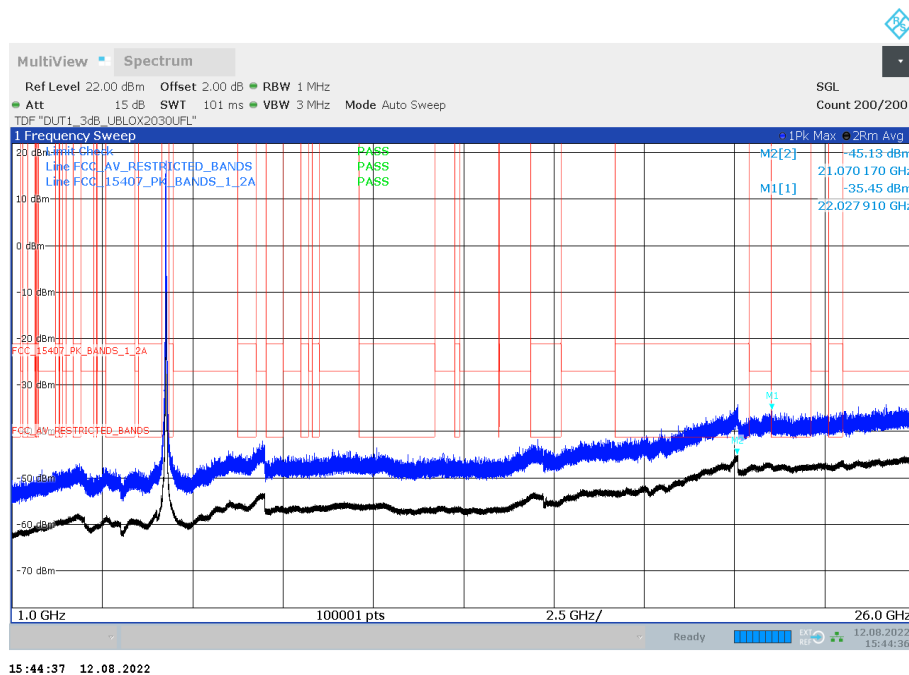

Radio Technology = WLAN a, Operating Frequency = mid, Measurement range = 1GHz - 26GHz, Subband = U-NII-2A (S01_377_AE01)

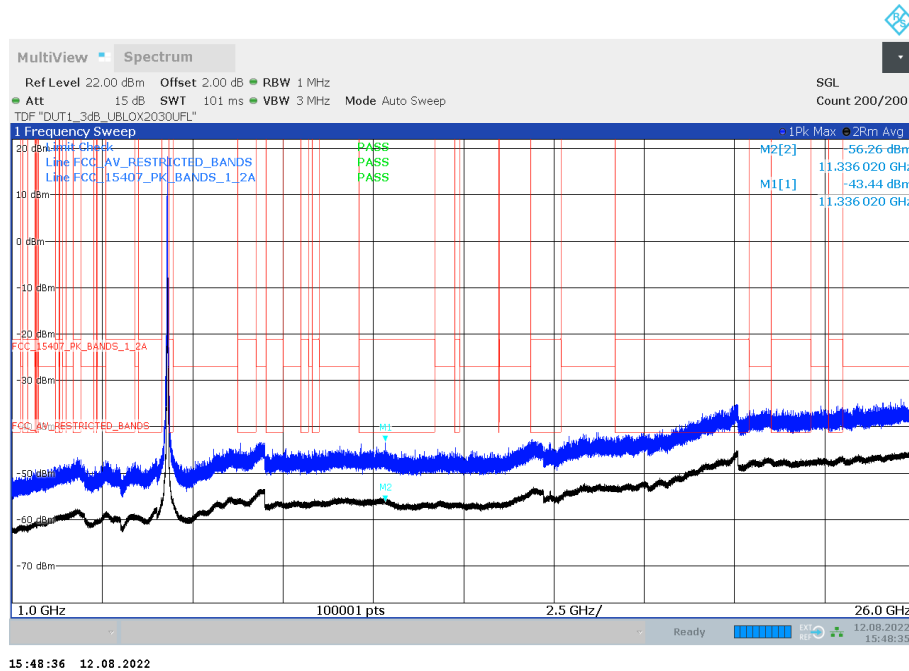

Radio Technology = WLAN a, Operating Frequency = high, Measurement range = 1GHz - 26GHz, Subband = U-NII-2A (S01_377_AE01)

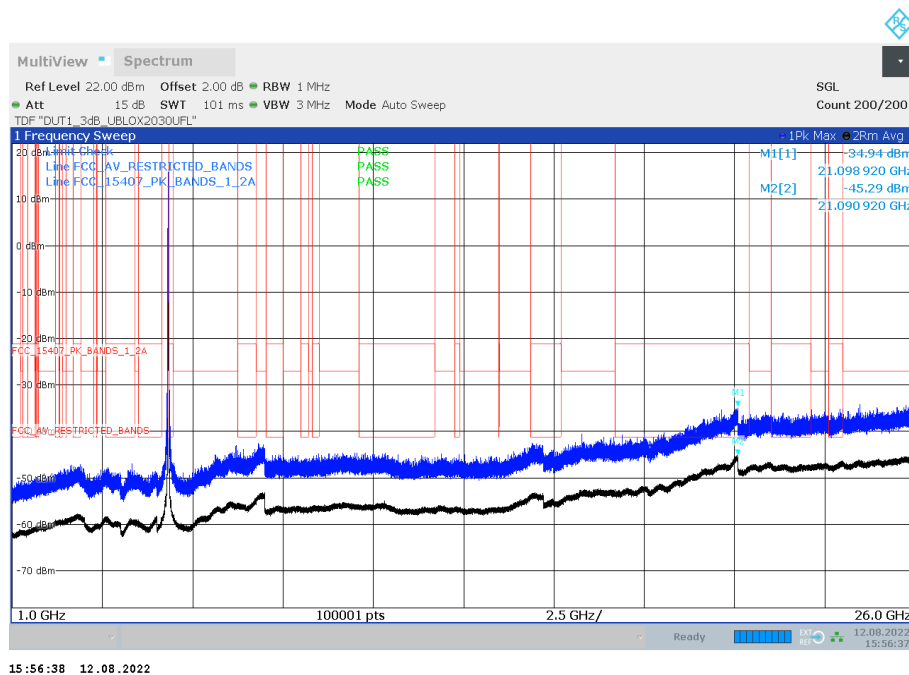

Radio Technology = WLAN a, Operating Frequency = low, Measurement range = 1GHz - 26GHz, Subband = U-NII-2C (S01_377_AE01)

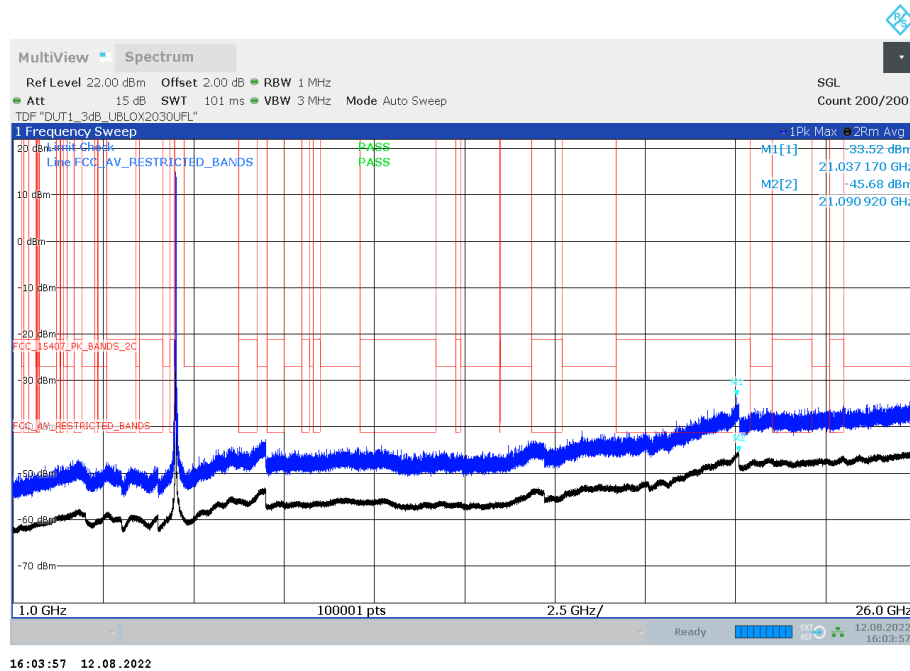

Radio Technology = WLAN a, Operating Frequency = mid, Measurement range = 1GHz - 26GHz, Subband = U-NII-2C (S01_377_AE01)

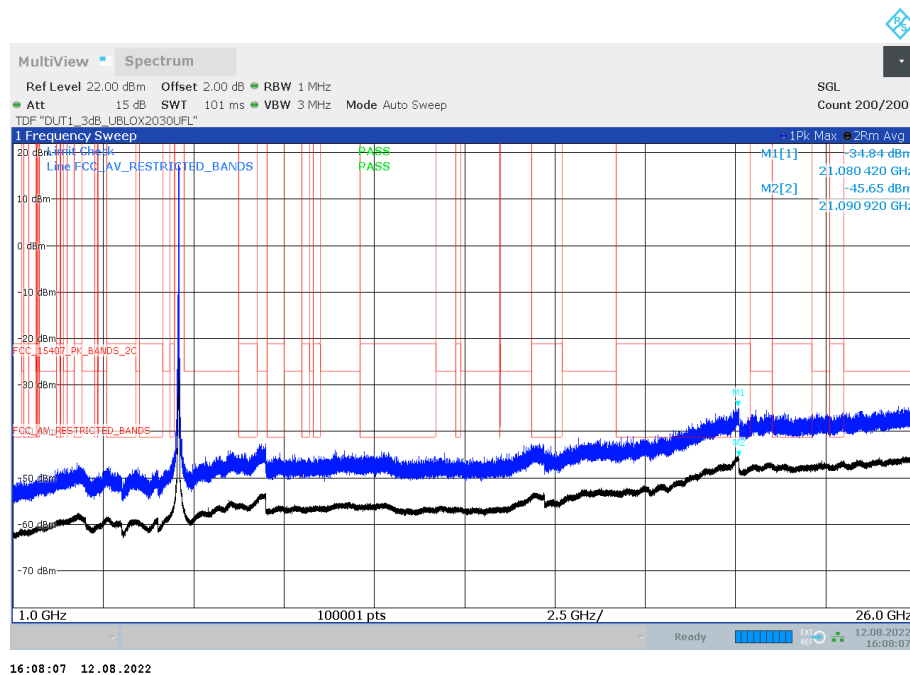

Radio Technology = WLAN a, Operating Frequency = high, Measurement range = 1GHz - 26GHz, Subband = U-NII-2C (S01_377_AE01)

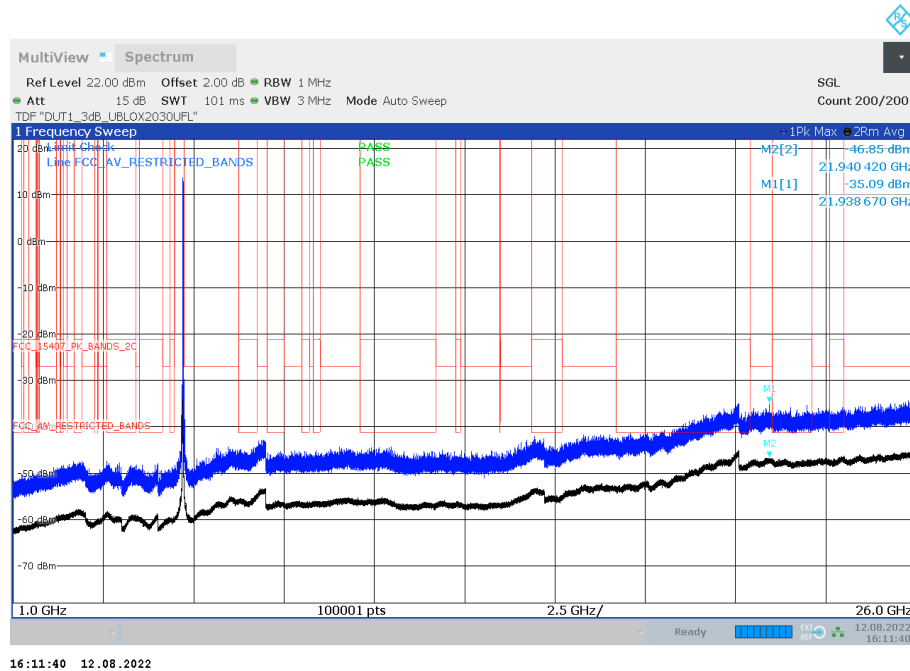

Radio Technology = WLAN a, Operating Frequency = low, Measurement range = 1GHz - 26GHz, Subband = U-NII-3 (S01_377_AE01)

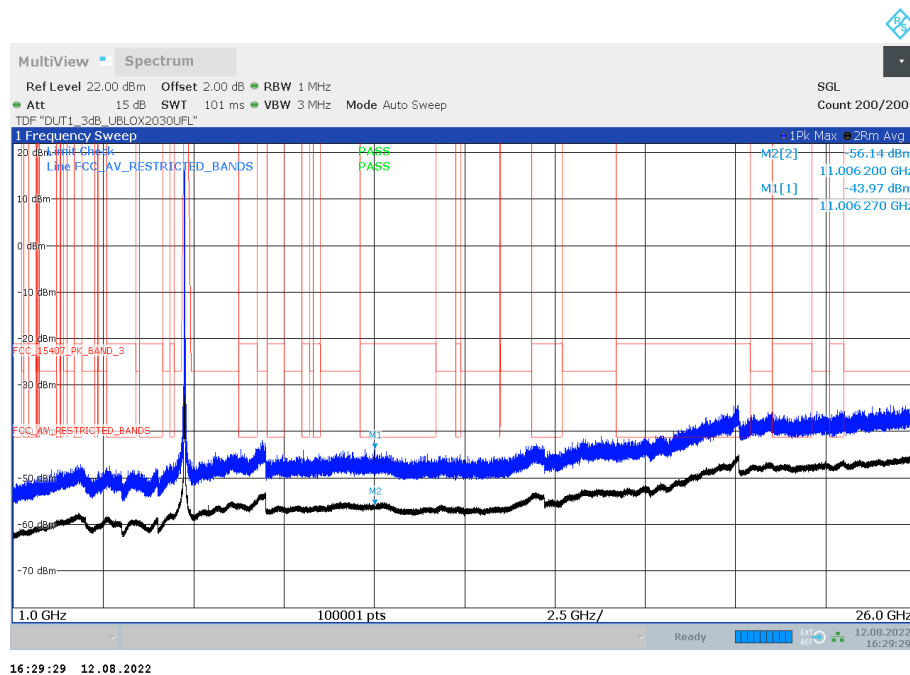

Radio Technology = WLAN a, Operating Frequency = mid, Measurement range = 1GHz - 26GHz, Subband = U-NII-3 (S01_377_AE01)

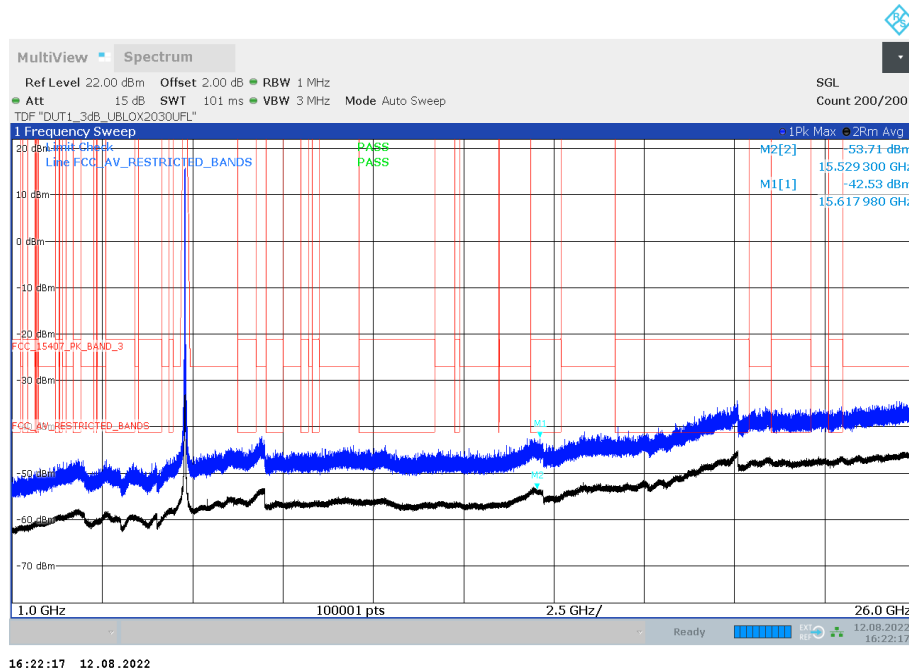

Radio Technology = WLAN a, Operating Frequency = high, Measurement range = 1GHz - 26GHz, Subband = U-NII-3 (S01_377_AE01)

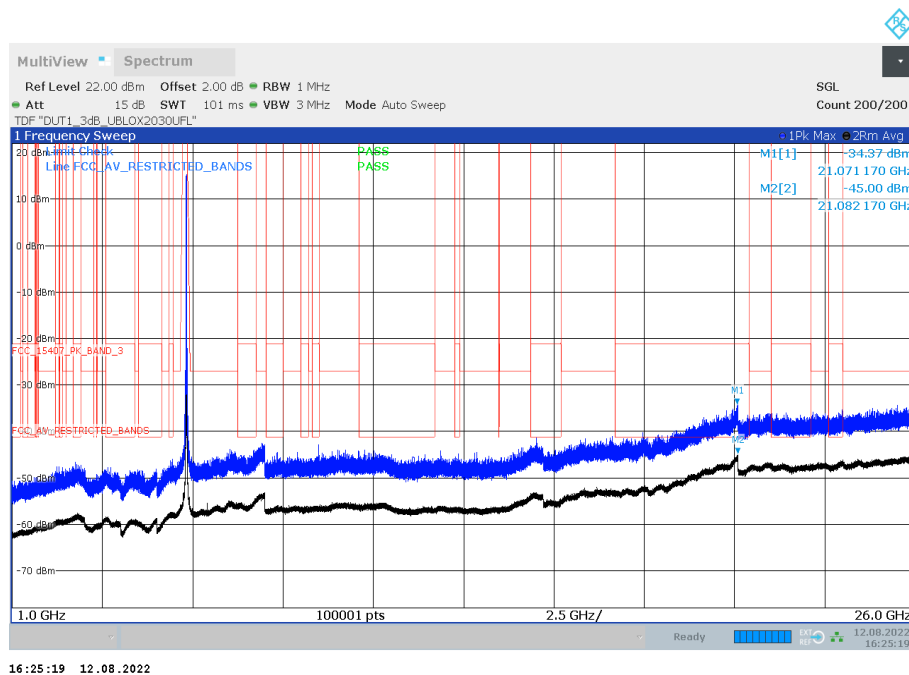

Radio Technology = WLAN a, Operating Frequency = mid, Measurement range = 30MHz - 1GHz, Subband = U-NII-1 (S01_377_AE01)

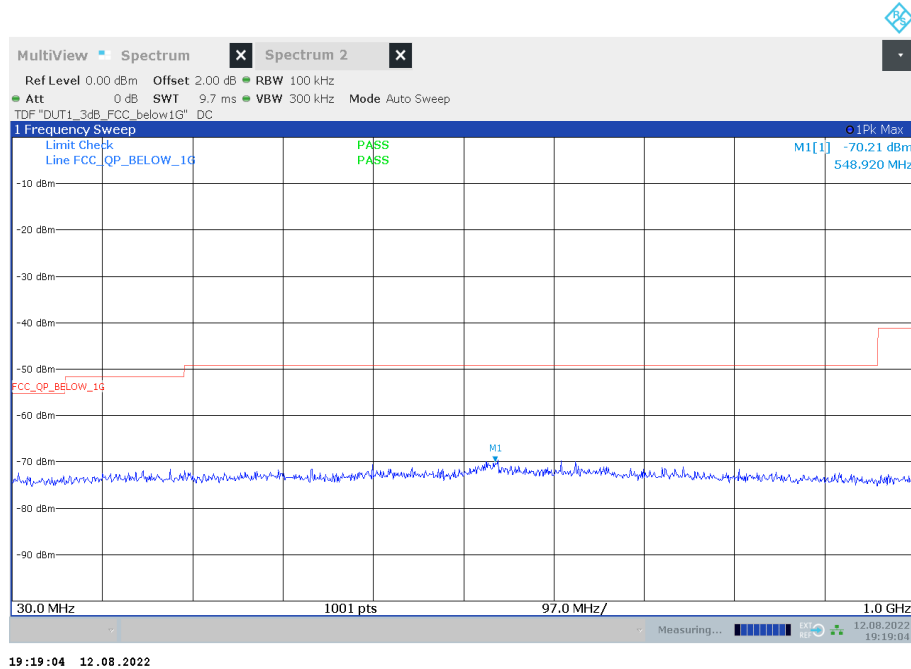

Radio Technology = WLAN a, Operating Frequency = mid, Measurement range = 30MHz - 1GHz, Subband = U-NII-3 (S01_377_AE01)

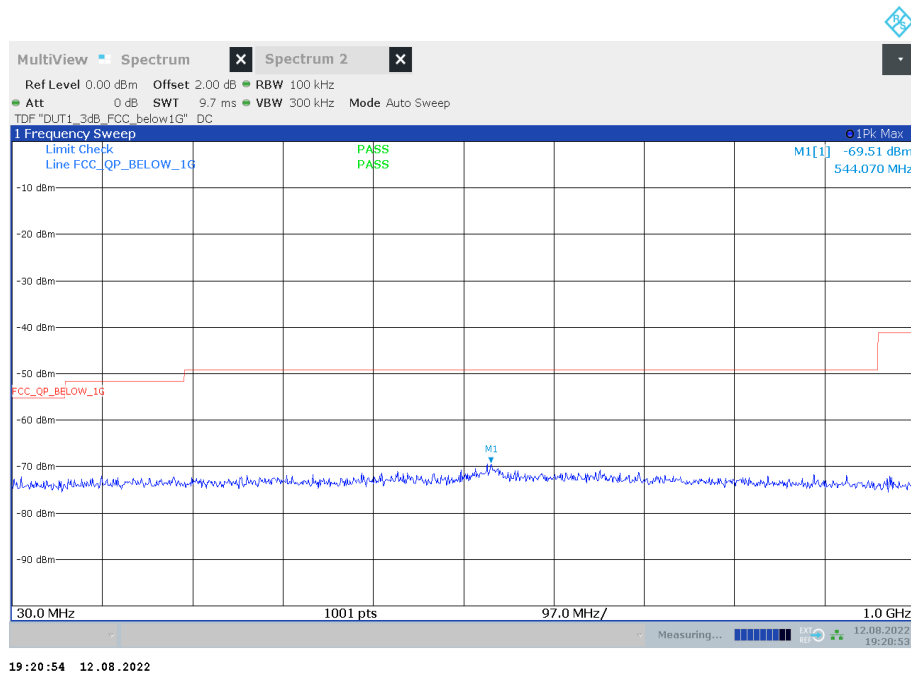

Radio Technology = WLAN n 20 MHz MIMO, Operating Frequency = mid, Measurement range = 1GHz - 26GHz, Subband = U-NII-1 (S01_377_AE01)

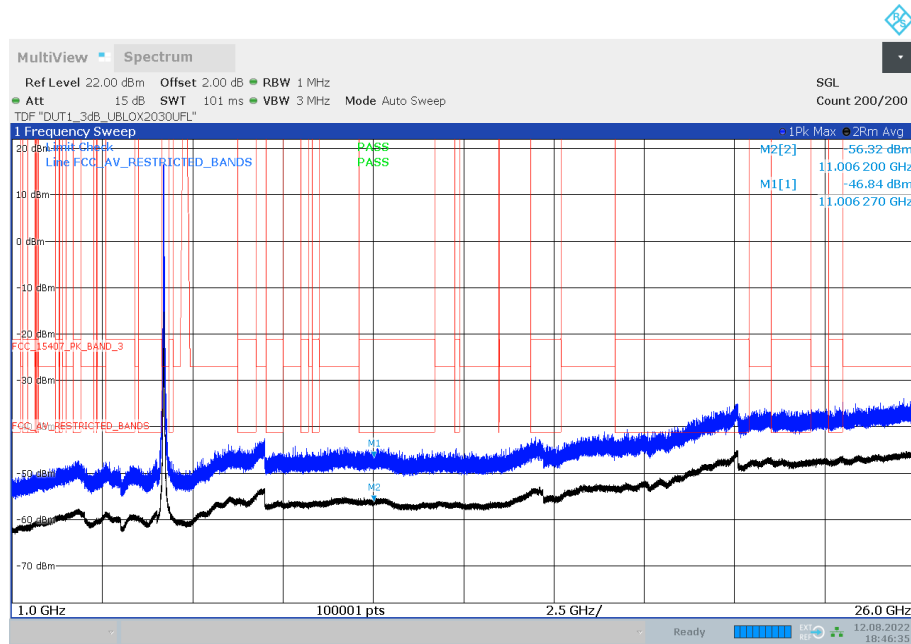

18:46:35 12.08.2022

Antenna A

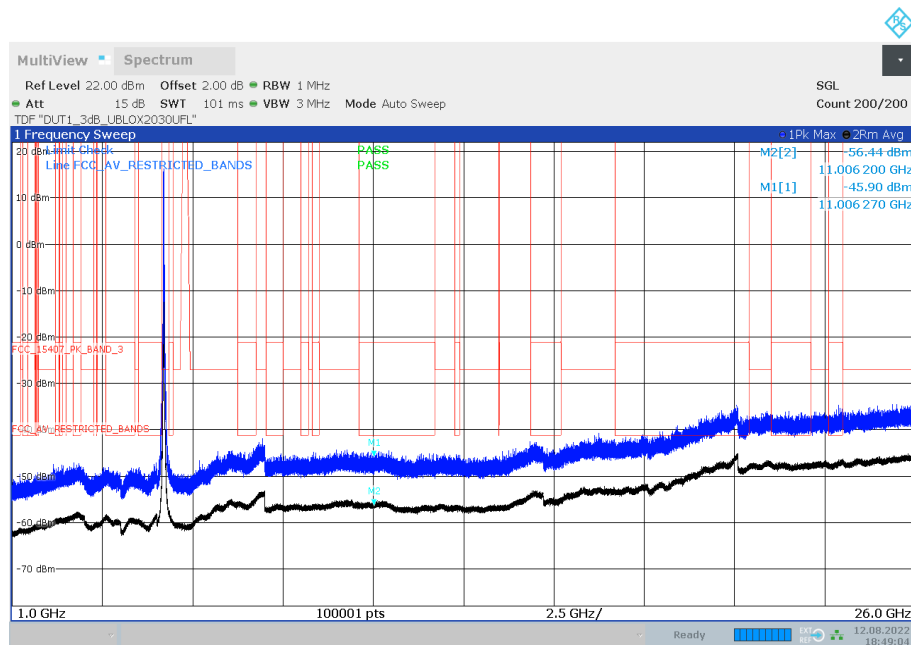

18:49:04 12.08.2022

Antenna B

Radio Technology = WLAN n 40 MHz MIMO, Operating Frequency = high, Measurement range = 1GHz - 26GHz, Subband = U-NII-1 (S01_377_AE01)

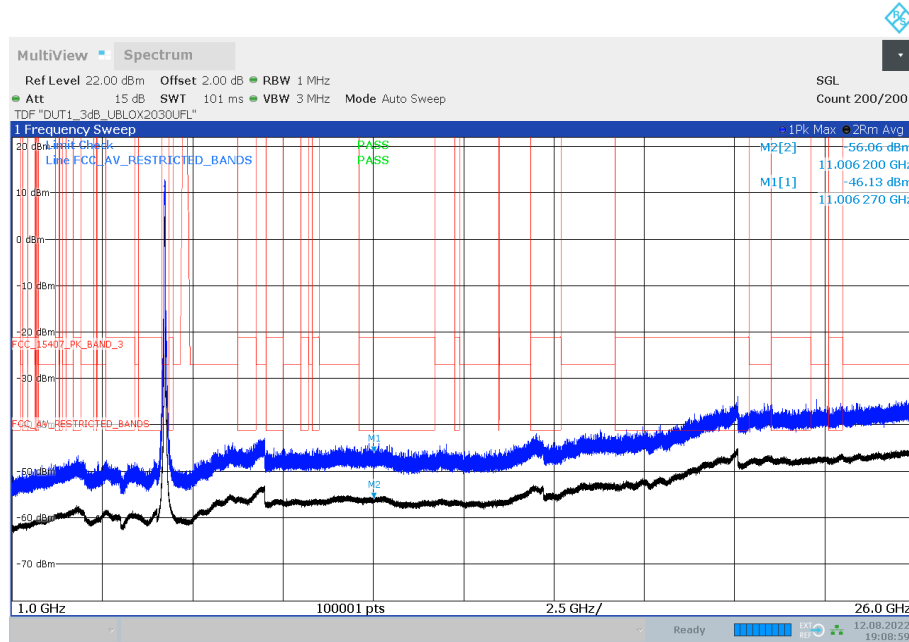

19:08:59 12.08.2022

Antenna A

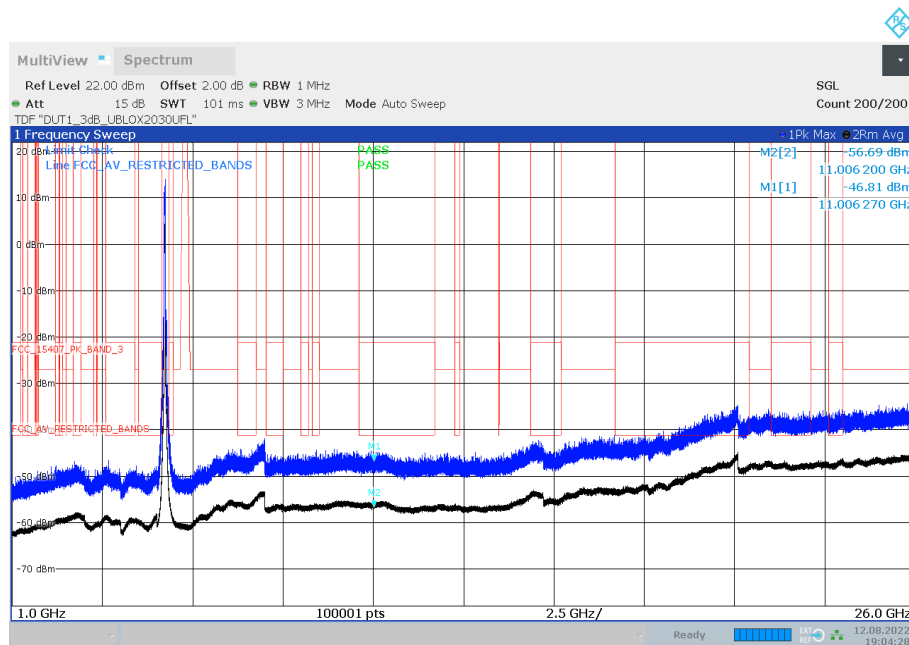

19:04:29 12.08.2022

Antenna B

Radio Technology = WLAN ac 20 MHz MIMO, Operating Frequency = mid, Measurement range = 1GHz - 26GHz, Subband = U-NII-1 (S01_377_AE01)

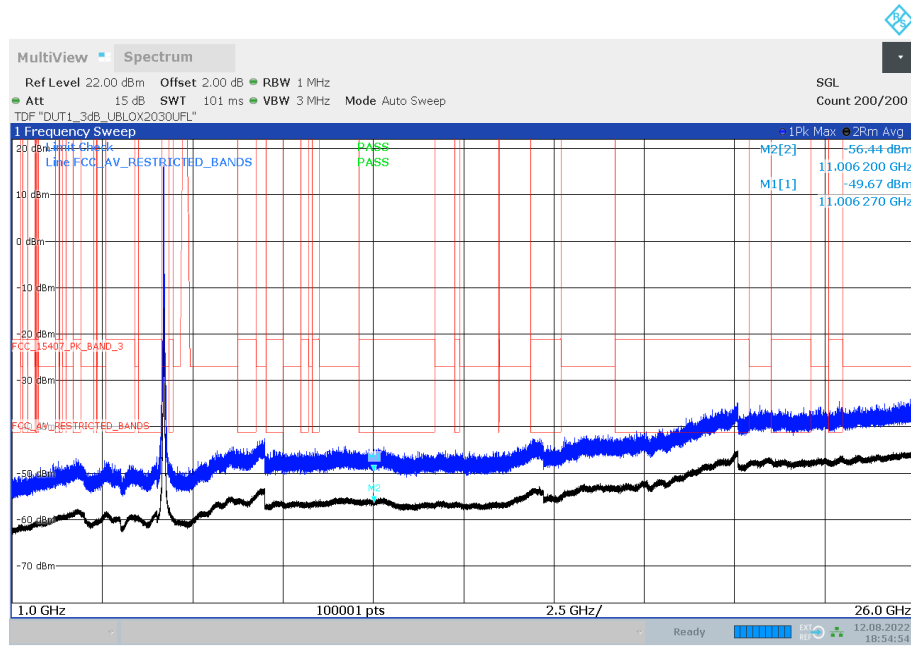

Antenna A

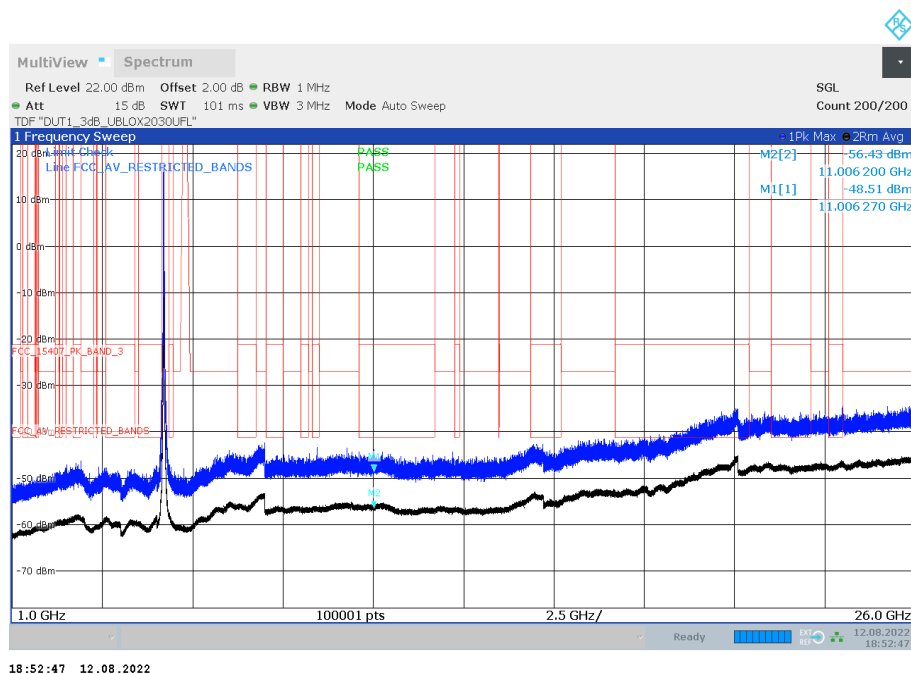

Antenna B

Radio Technology = WLAN ac 80 MHz MIMO, Operating Frequency = mid, Measurement range = 1GHz - 26GHz, Subband = U-NII-1 (S01_377_AE01)

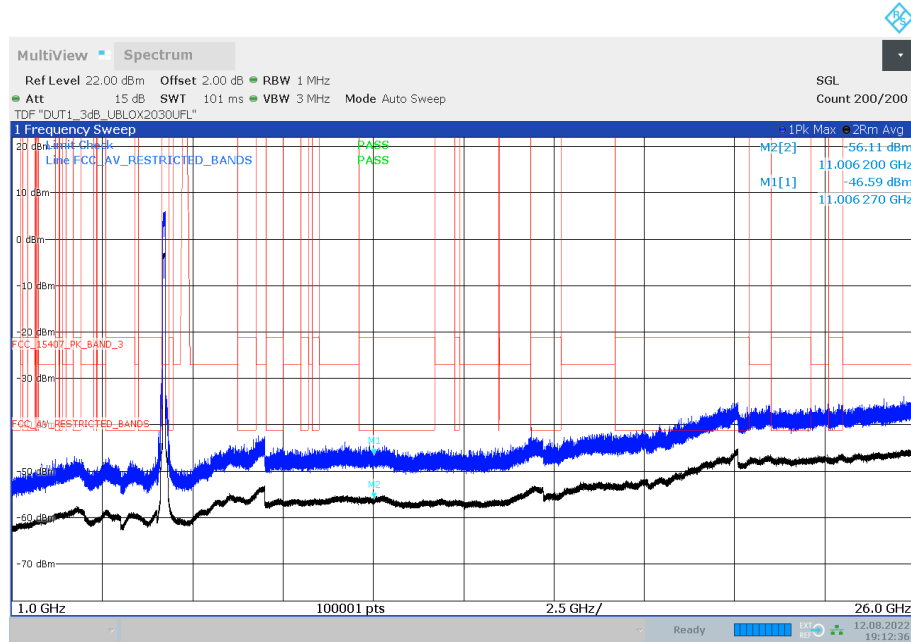

Antenna A

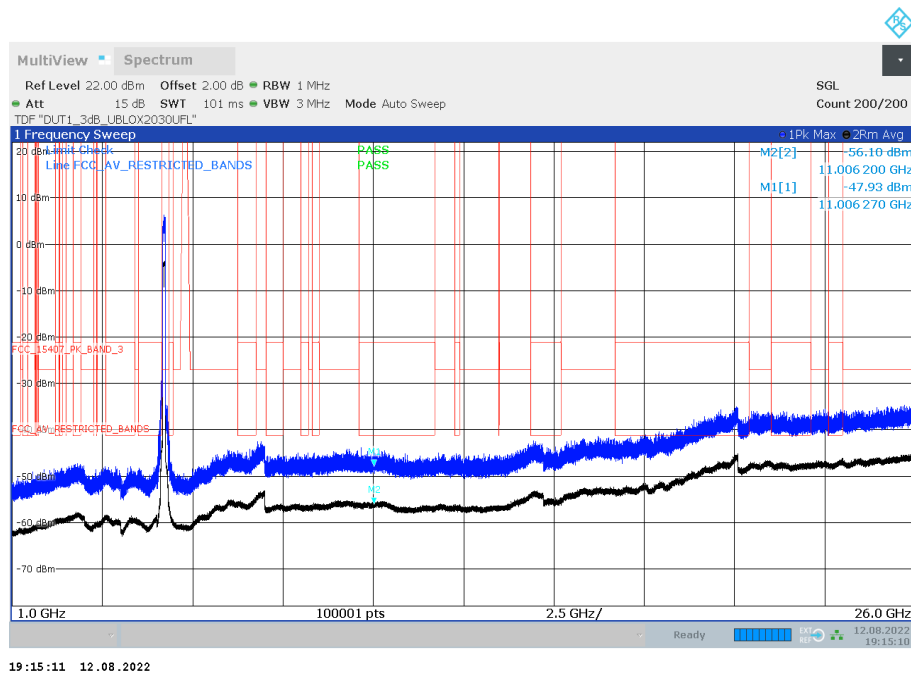

Antenna B

Radio Technology = WLAN a, Operating Frequency = mid, Measurement range = 9kHz - 30MHz, Subband = U-NII-3 (S01_374_BA01)

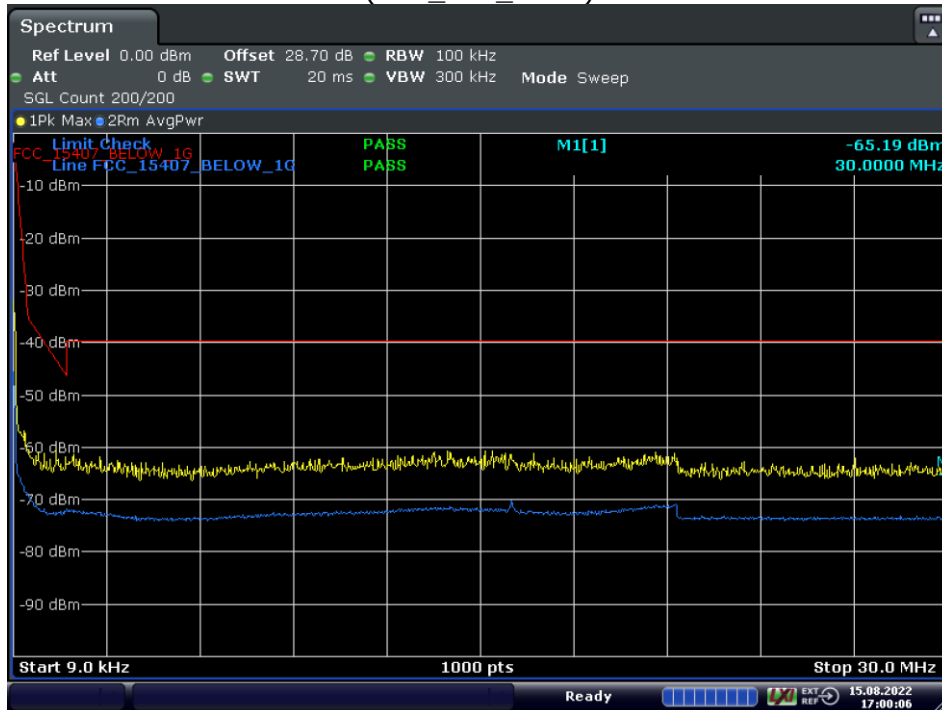

Radio Technology = WLAN a, Operating Frequency = high, Measurement range = 9kHz - 30MHz, Subband = U-NII-2C (S02_374_BB01)

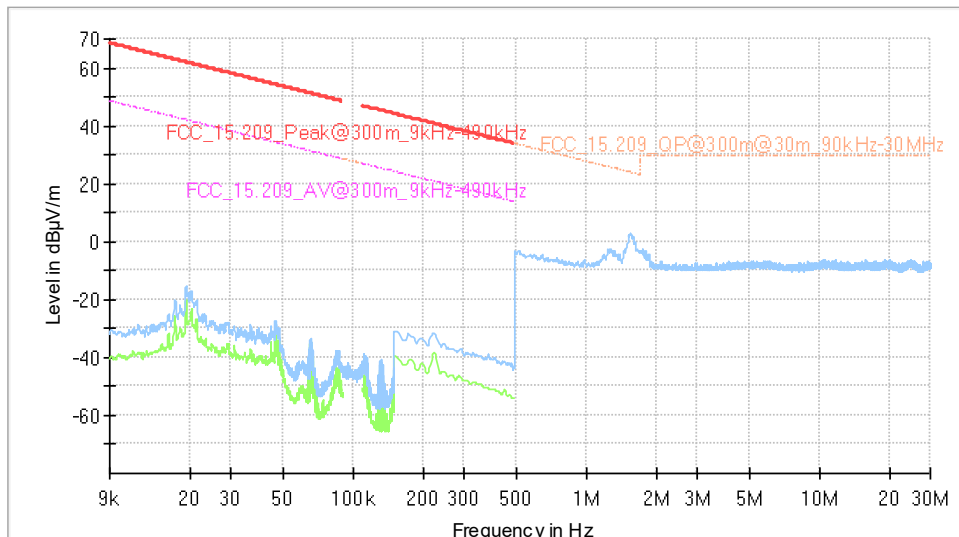

Final Result

Frequency (MHz)	MaxPeak (dBµV/m)	Average (dBµV/m)	Limit (dBµV/m)	Margin (dB)	Meas. Time (ms)	Bandwidth (kHz)	Height (cm)	Azimuth h (deg)	Corr. (dB/m)
---	---	---	---	---	---	---	---	---	---

Radio Technology = WLAN a, Operating Frequency = mid, Measurement range = 30MHz - 1GHz, Subband = U-NII-1 (S02_374_BA01)

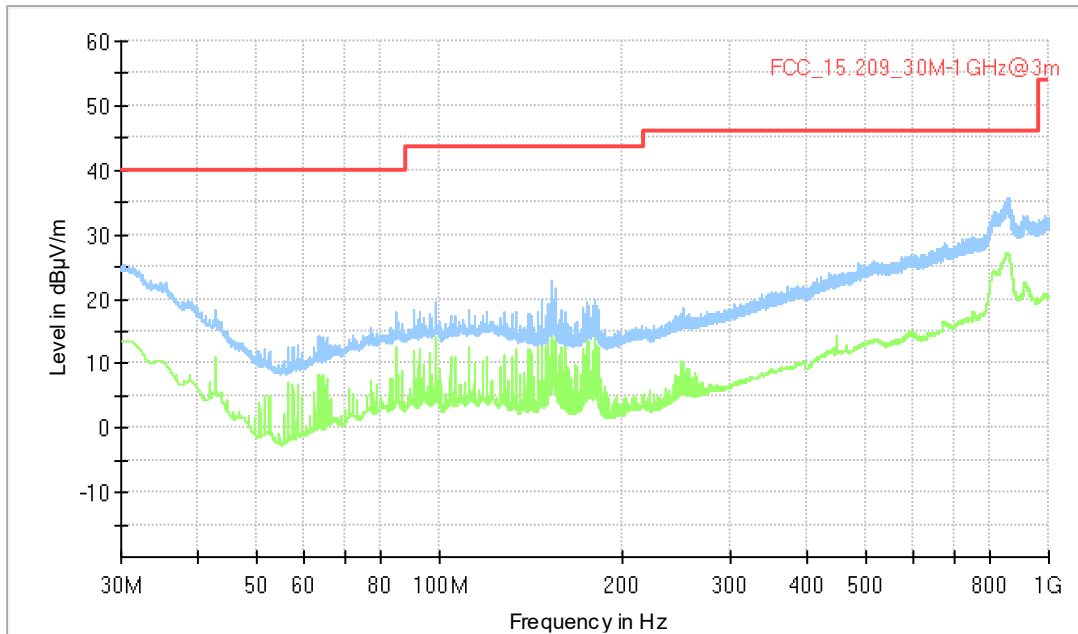

Final_Result

Frequency (MHz)	QuasiPeak (dBµV/m)	Limit (dBµV/m)	Margin (dB)	Meas. Time (ms)	Bandwidth (kHz)	Height (cm)	Pol	Azimuth (deg)	Corr. (dB/m)
---	---	---	---	---	---	---	---	---	---

Radio Technology = WLAN a, Operating Frequency = mid, Measurement range = 30MHz - 1GHz, Subband = U-NII-3 (S02_374_BA01)

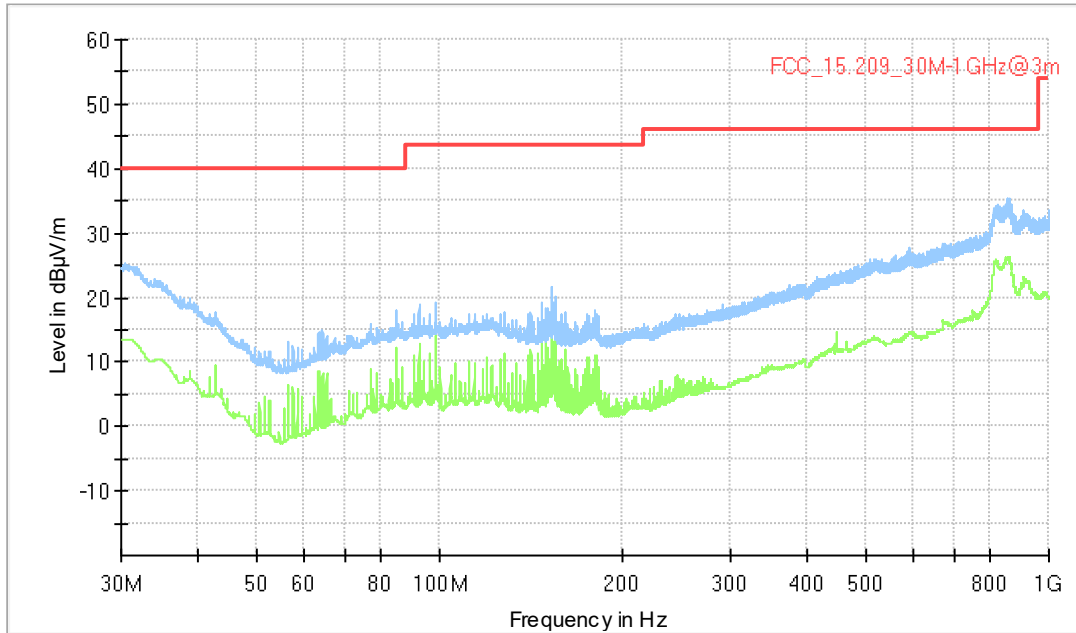

Final Result

Frequency (MHz)	QuasiPeak (dBµV/m)	Limit (dBµV/m)	Margin (dB)	Meas. Time (ms)	Bandwidth (kHz)	Height (cm)	Pol	Azimuth (deg)	Corr. (dB/m)
---	---	---	---	---	---	---	---	---	---

Radio Technology = WLAN a, Operating Frequency = mid, Measurement range = 30MHz - 1GHz, Subband = U-NII-1
(S01_374_BA01)

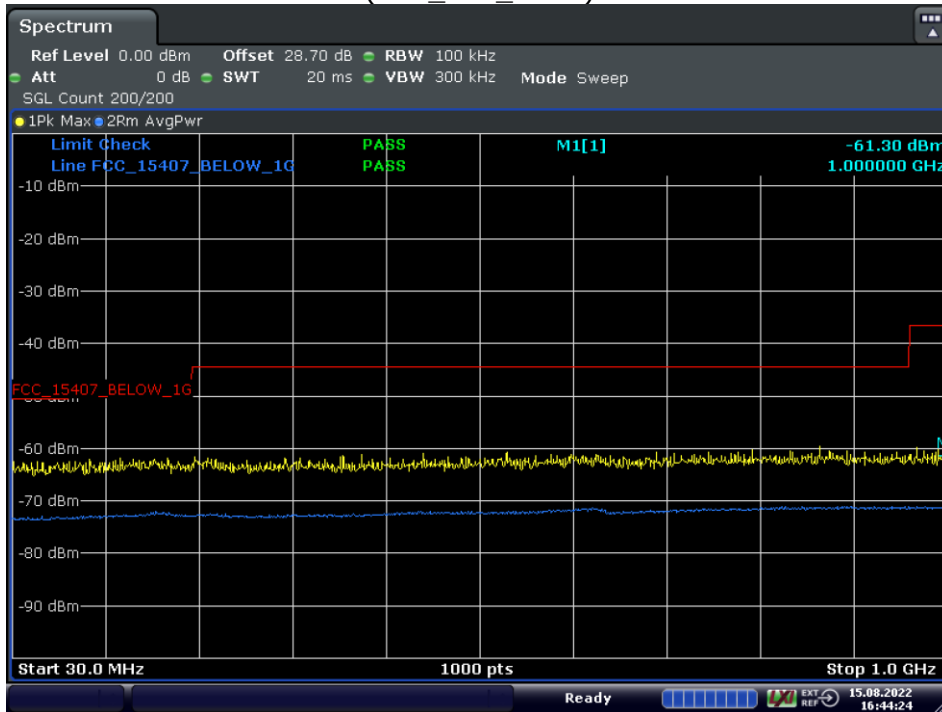

Date: 15.AUG.2022 16:44:25

Radio Technology = WLAN a, Operating Frequency = mid, Measurement range = 30MHz - 1GHz, Subband = U-NII-2A
(S01_374_BA01)

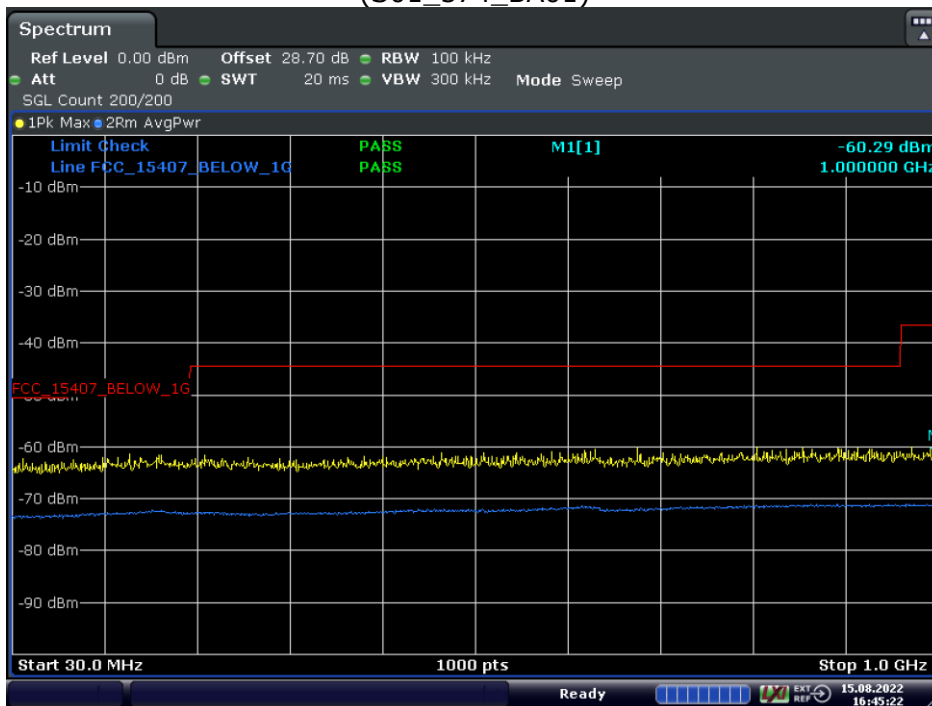

Date: 15.AUG.2022 16:45:23

Radio Technology = WLAN a, Operating Frequency = mid, Measurement range = 30MHz - 1GHz, Subband = U-NII-2C
(S01_374_BA01)

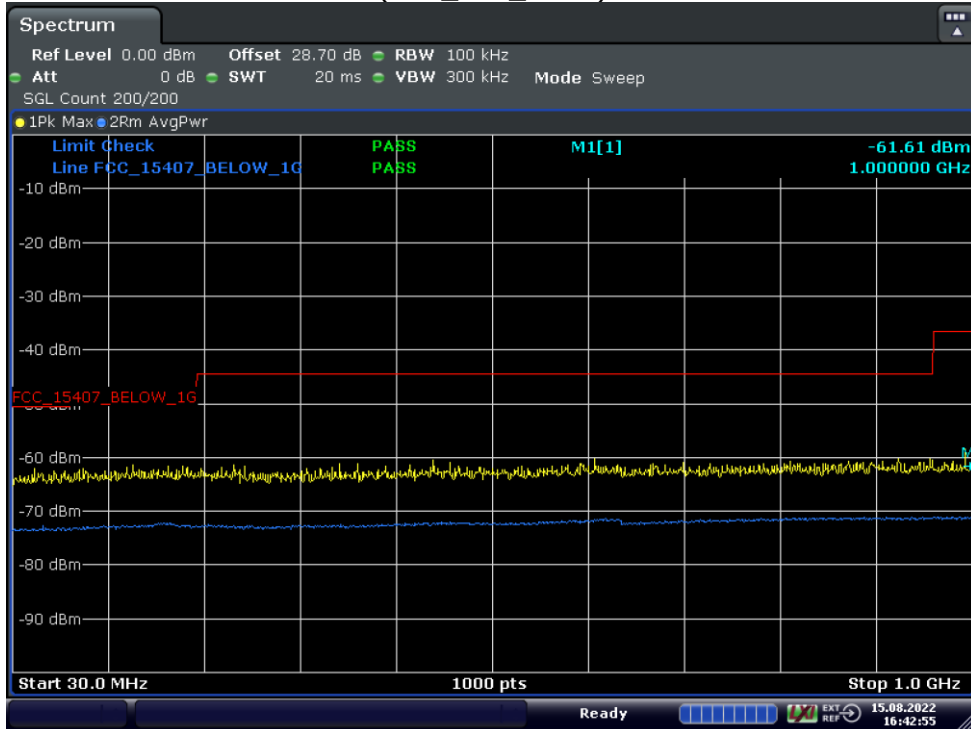

Date: 15.AUG.2022 16:42:56

Radio Technology = WLAN a, Operating Frequency = mid, Measurement range = 30MHz - 1GHz, Subband = U-NII-3
(S01_374_BA01)

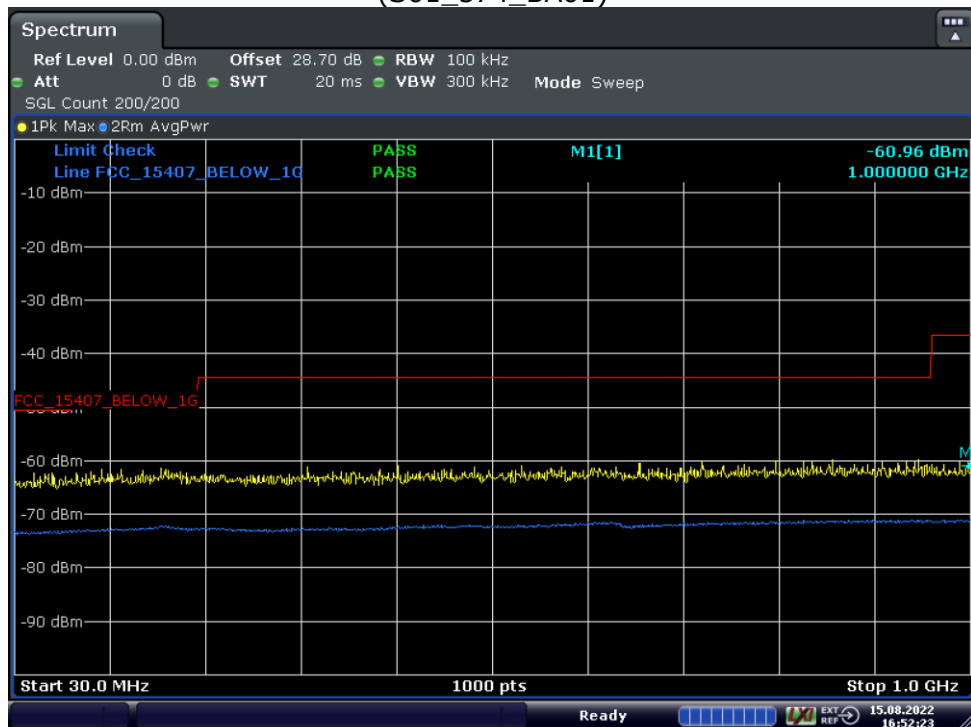

Date: 15.AUG.2022 16:52:23

Radio Technology = WLAN a, Operating Frequency = mid, Measurement range = 1GHz - 18GHz, Subband = U-NII-1
(S01_374_BA01)

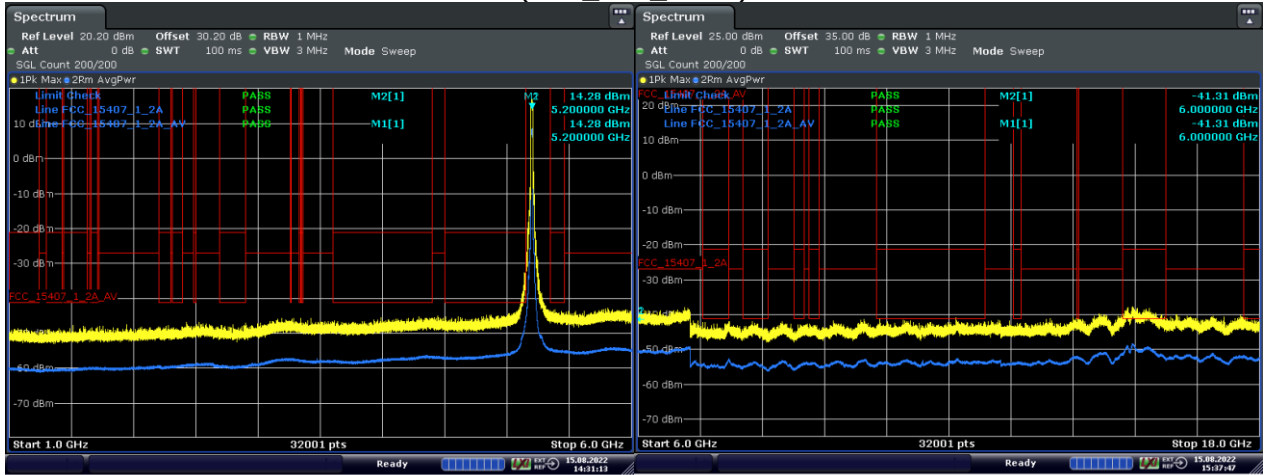

Date: 15.AUG.2022 14:31:13

Date: 15.AUG.2022 15:37:48

Radio Technology = WLAN a, Operating Frequency = mid, Measurement range = 1GHz - 18GHz, Subband = U-NII-2A
(S01_374_BA01)

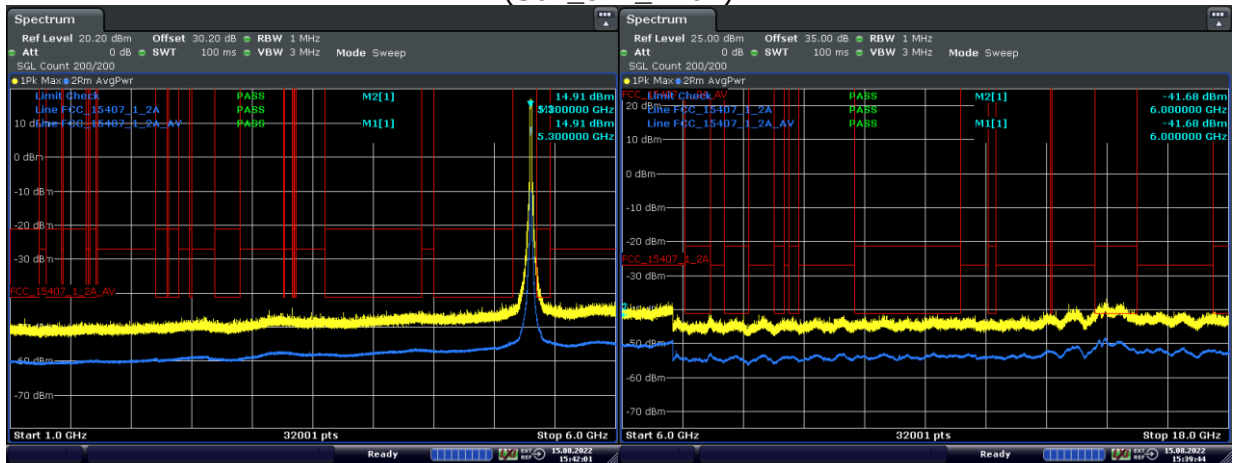

Date: 15.AUG.2022 15:42:02

Date: 15.AUG.2022 15:39:44

Radio Technology = WLAN a, Operating Frequency = mid, Measurement range = 1GHz - 18GHz, Subband = U-NII-2C
(S01_374_BA01)

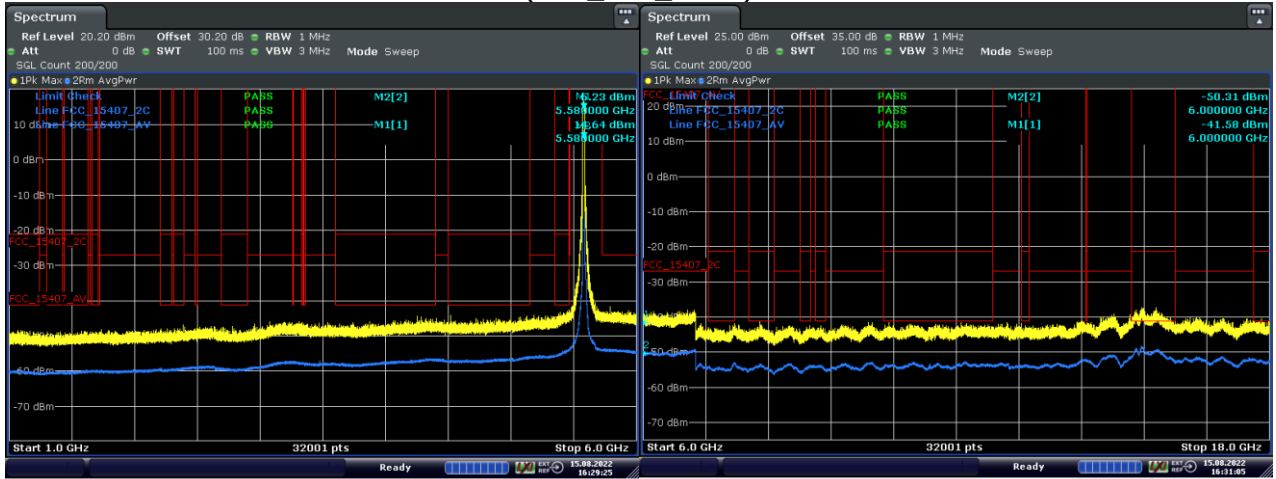

Date: 15.AUG.2022 16:29:25

Date: 15.AUG.2022 16:31:06

Radio Technology = WLAN a, Operating Frequency = mid, Measurement range = 1GHz - 18GHz, Subband = U-NII-3
(S01_374_BA01)



Date: 15.AUG.2022 16:20:16

Date: 15.AUG.2022 16:22:32

Radio Technology = WLAN a, Operating Frequency = low, Measurement range = 1GHz - 26GHz, Subband = U-NII-2A (S01_374_BA01)

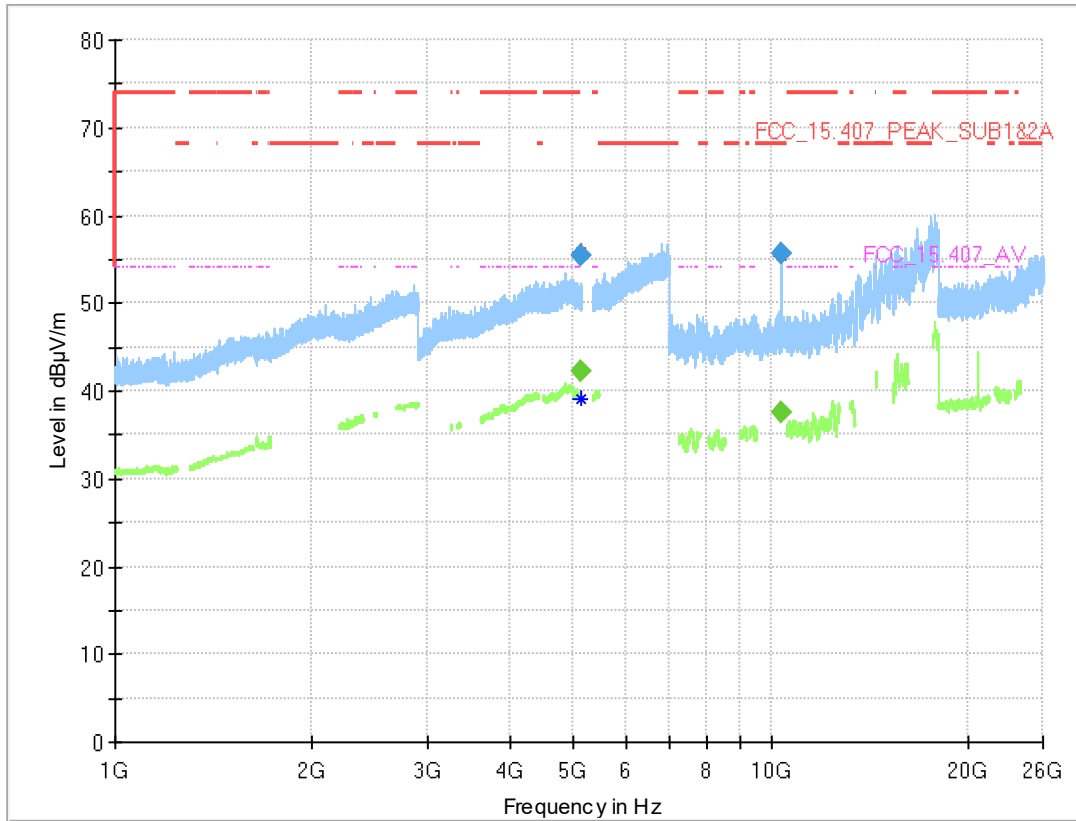

Final Result

Frequency (MHz)	MaxPeak (dBµV/m)	CAverage (dBµV/m)	Limit (dBµV/m)	Margin (dB)	Meas. Time (ms)	Bandwidth (kHz)	Height (cm)	Pol	Azimuth (deg)	Elevation (deg)	Corr. (dB/m)
5148.375	---	42.2	54.00	11.76	1000.0	1000.000	150.0	V	-178.0	79.0	13.5
5148.375	55.5	---	74.00	18.53	1000.0	1000.000	150.0	V	-178.0	79.0	13.5
10360.613	---	37.6	---	---	1000.0	1000.000	150.0	H	-45.0	88.0	-12.3
10360.613	55.6	---	68.20	12.60	1000.0	1000.000	150.0	H	-45.0	88.0	-12.3

5.7.5 TEST EQUIPMENT USED

- Radiated Emissions SAC H-Field
- Radiated Emissions FAR 5 GHz FCC
- Radiated Emissions SAC up to 1 GHz
- R&S TS8997
- Radio Lab

5.8 BAND EDGE

Standard **FCC Part 15 Subpart E**

The test was performed according to:
ANSI C63.10

5.8.1 TEST DESCRIPTION

Radiated Measurement with 50 Ohm termination at antenna ports

The test set-up was made in accordance to the general provisions of ANSI C63.10 in a typical installation configuration. The measurements were performed according the following sub-chapter of ANSI C63.10:

- Chapter 6.10.5

The Equipment Under Test (EUT) was set up on a non-conductive support (tilt device) at 1.5 m height in the fully-anechoic chamber.

All steps were performed with one height (1.5 m) of the receiving antenna only (procedure according ANSI C63.10, chapter 6.6.5).

3. Measurement above 1 GHz

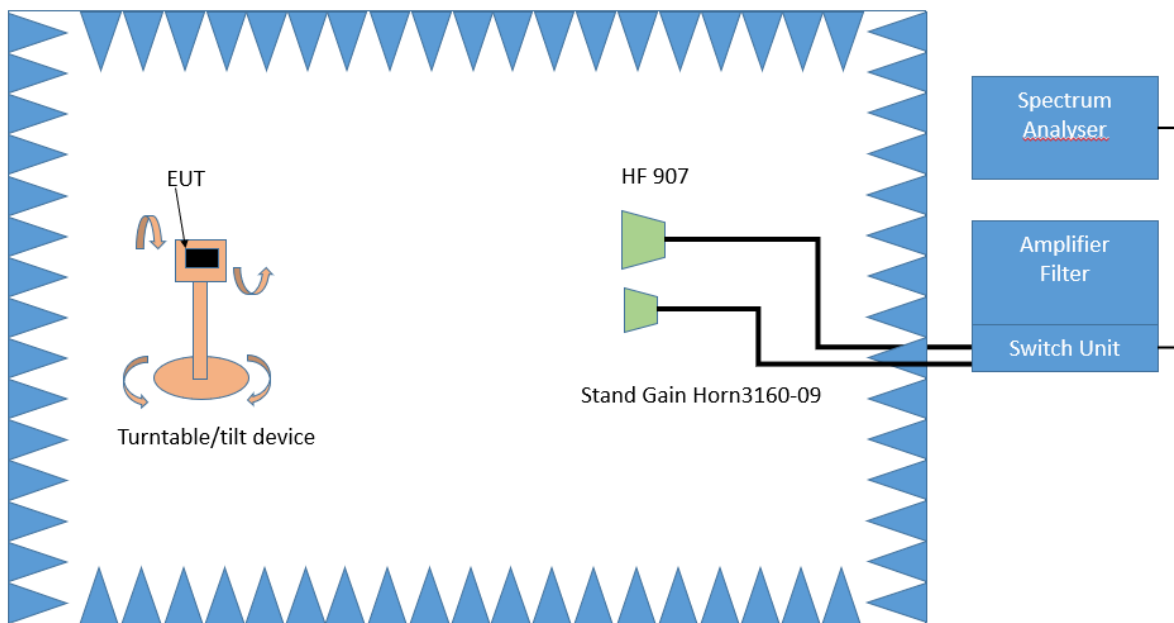

Test Setup; Spurious Emission Radiated (FAC), 1 GHz-26.5 GHz

Step 1:

The EUT is turned during the preliminary measurement across the elevation axis, with a step size of 90 °.

The turn table step size (azimuth angle) for the preliminary measurement is 45 °.

Spectrum analyser settings:

- Detector: Peak, Average
- RBW = 1 MHz
- VBW = 3 MHz

Step 2:

The turn table azimuth will slowly vary by $\pm 22.5^\circ$.

The elevation angle will slowly vary by $\pm 45^\circ$

Spectrum analyser settings:

- Detector: Peak

Step 3:

Spectrum analyser settings for step 3:

- Detector: Peak / CISPR Average
- Measured frequencies: in step 1 determined frequencies
- RBW = 1 MHz
- VBW = 3 MHz
- Measuring time: 1 s

Conducted Measurements at antenna ports

The Equipment Under Test (EUT) was set up to perform the spurious emissions measurements.

The EUT was connected to the test system as described in the block diagram below. The complete attenuation of the measurement path is known and considered.

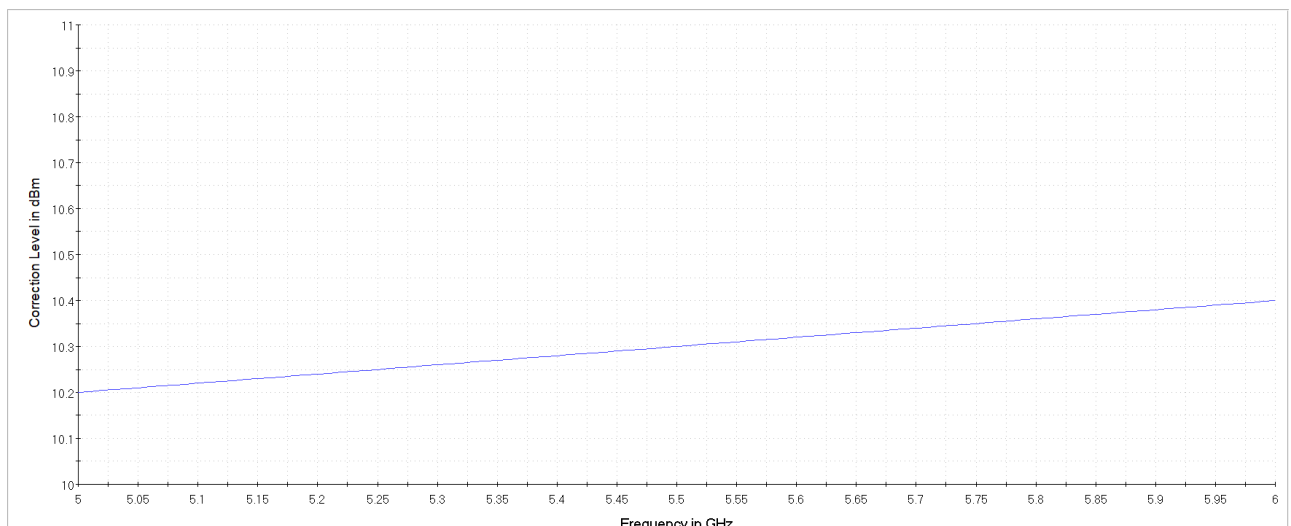
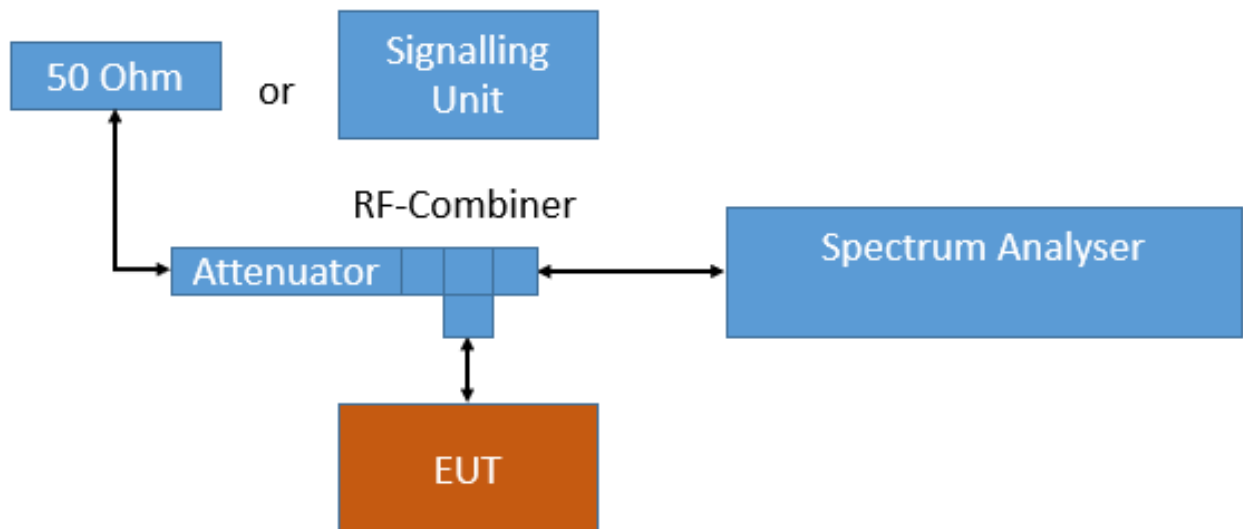

Analyser settings:

- Frequency range: 5100 – 5400 MHz (U-NII band 1/2A)
5430 – 5530 MHz (U-NII band 2C low BE)
5655 – 5755 MHz (U-NII band 2C high BE)
5611 – 5811 MHz (U-NII band 3 low BE)
5765 – 5965 MHz (U-NII band 3 high BE)
- Resolution Bandwidth (RBW): 1000 kHz
- Video Bandwidth (VBW): 3000 kHz
- Trace: Maxhold, Average Power
- Sweeps: 10000
- Sweep Time: coupled
- Detector: Peak, RMS

For the conducted emissions in restricted bands the Value is measured in dBm and then converted to dB μ V/m as given in KDB 558074:

1. Measure the conducted output power in dBm.
2. Add the maximum antenna gain in dBi. (Included in measurement result by offset)
3. Add the appropriate ground reflection factor (0 for measured range)
6 dB for frequencies \leq 30 MHz;
4.7 dB for frequencies between 30 MHz and 1000 MHz, inclusive; and
0 dB for frequencies $>$ 1000 MHz).
4. Convert the resultant EIRP level to an equivalent electric field strength level using the following relationship:
$$E = \text{EIRP} - 20 \log D + 104.8$$
Where E is the electric field strength in dB μ V/m,
EIRP is the equivalent isotropically radiated power in dBm
D is the specified measurement distance in m

Value [dB μ V/m] = Measured value [dBm] (including gain and ground reflection factor) – 20 log D + 104.8

5.8.2 TEST REQUIREMENTS / LIMITS

A) FCC

FCC Part 15 Subpart E, §15.407 (b)(1)

For transmitters operating in the 5150–5250 MHz band:

Limit: –27 dBm/MHz EIRP outside of the band 5150–5350 MHz.

FCC Part 15 Subpart E, §15.407 (b)(2)

For transmitters operating in the 5250–5350 MHz band:

Limit: –27 dBm/MHz EIRP outside of the band 5150–5350 MHz.

FCC Part 15 Subpart E, §15.407 (b)(3)

For transmitters operating in the 5470–5725 MHz band:

Limit: –27 dBm/MHz EIRP outside of the band 5470–5725 MHz.

FCC Part 15 Subpart E, §15.407 (b)(4)

For transmitters operating in the 5725–5850 MHz band:

Limit: –27 dBm/MHz at 75 MHz or more above or below the band edge
increasing linearly to 10 dBm/MHz at 25 MHz above or below the band edge
increasing linearly to 15.6 dBm/MHz at 5 MHz above or below the band edge
increasing linearly to 27 dBm/MHz at the band edge.

FCC Part 15 Subpart E, §15.407 (b) (5)

For transmitters operating within the 5.925-7.125 GHz band:

Limit: –27 dBm/MHz EIRP outside of the band 5.925-7.125 GHz.

FCC Part 15 Subpart E, §15.407 (b) (6)

For transmitters operating within the 5.925-7.125 GHz bands:

Power spectral density must be suppressed by 20 dB at 1 MHz outside of channel edge, by 28 dB at one channel bandwidth from the channel center, and by 40 dB at one- and one-half times the channel bandwidth away from channel center. At frequencies between one megahertz outside an unlicensed device's channel edge and one channel bandwidth from the center of the channel, the limits must be linearly interpolated between 20 dB and 28 dB suppression, and at frequencies between one and one- and one-half times an unlicensed device's channel bandwidth, the limits must be linearly interpolated between 28 dB and 40 dB suppression. Emissions removed from the channel center by more than one- and one-half times the channel bandwidth must be suppressed by at least 40 dB.

B) IC

Different frequency bands and limits apply, as compared to the FCC requirements.

RSS-247, 6.2.1.2, Emissions outside the band 5150-5250 MHz, indoor operation only:

Limit: –27 dBm/MHz EIRP outside of the band 5150–5250 MHz.

RSS-247, 6.2.2.2, Emissions outside the band 5250-5350 MHz:

Limit: –27 dBm/MHz EIRP outside of the band 5250–5350 MHz.

RSS-247, 6.2.3.2, Emissions outside the bands 5470-5600 MHz and 5650-5725 MHz:

Limit: –27 dBm/MHz EIRP outside of the band 5470–5725 MHz.

However, devices with bandwidth overlapping the band edge of 5725 MHz can meet the emission limit of -27 dBm/MHz e.i.r.p.at 5850 MHz instead of 5725 MHz.

Note: No operation is permitted for the frequency range 5600–5650 MHz.

RSS-247, 6.2.4.2, Emissions outside the band 5725-5850 MHz:

- a. 27 dBm/MHz at frequencies from the band edges decreasing linearly to 15.6 dBm/MHz at 5 MHz above or below the band edges;
- b. 15.6 dBm/MHz at 5 MHz above or below the band edges decreasing linearly to 10 dBm/MHz at 25 MHz above or below the band edges;
- c. 10 dBm/MHz at 25 MHz above or below the band edges decreasing linearly to -27 dBm/MHz at 75 MHz above or below the band edges; and
- d. -27 dBm/MHz at frequencies more than 75 MHz above or below the band edges.

C) FCC & IC

For band edges connected to a restricted band, the limits are specified in Section 15.209(a)

FCC Part 15, Subpart C, §15.209, Radiated Emission Limits

Frequency in MHz	Limit ($\mu\text{V}/\text{m}$)	Measurement distance (m)	Limits (dB $\mu\text{V}/\text{m}$)
0.009 - 0.49	2400/F(kHz)@300m	3	(48.5 - 13.8)@300m
0.49 - 1.705	24000/F(kHz)@30m	3	(33.8 - 23.0)@30m
1.705 - 30	30@30m	3	29.5@30m

The measured values are corrected with an inverse linear distance extrapolation factor (40 dB/decade) according FCC 15.31 (2).

Frequency in MHz	Limit ($\mu\text{V}/\text{m}$)	Measurement distance (m)	Limits (dB $\mu\text{V}/\text{m}$)
30 - 88	100@3m	3	40.0@3m
88 - 216	150@3m	3	43.5@3m
216 - 960	200@3m	3	46.0@3m
960 - 26000	500@3m	3	54.0@3m
26000 - 40000	500@3m	1	54.0@3m

The measured values above 26 GHz are corrected with an inverse linear distance extrapolation factor (20 dB/decade).

§15.35(b) ..., there is also a limit on the radio frequency emissions, as measured using instrumentation with a peak detector function, corresponding to 20 dB above the maximum permitted average limit....

Used conversion factor: $\text{Limit (dB}\mu\text{V}/\text{m)} = 20 \log (\text{Limit } (\mu\text{V}/\text{m})/1\mu\text{V}/\text{m})$

5.8.3 TEST PROTOCOL

Ambient temperature: 24–30 °C
 Air Pressure: 990–1026 hPa
 Humidity: 30–40 %
 WLAN a-Mode; 20 MHz; 6 Mbit/s
 Applied duty cycle correction (AV): 0 dB

Variant	Measurement Method	Ch. Center Freq. [MHz]	Band Edge Freq. [MHz]	Spurious Level [dBµV/m]	Detector	RBW [kHz]	Limit [dBµV/m]	Margin [dB]	Limit Type
377	Radiated	5180	5150.0	54.5	PEAK	1000	74.0	19.5	BE-RB
377	Radiated	5180	5150.0	41.9	AV	1000	54.0	12.1	BE-RB
377	Conducted	5180	5150.0	71.9	PEAK	1000	74.0	2.1	BE-RB
377	Conducted	5180	5150.0	52.0	AV	1000	54.0	2.0	BE-RB
377	Conducted	5200	5150.0	64.9	PEAK	1000	74.0	9.1	BE-RB
377	Conducted	5200	5150.0	49.1	AV	1000	54.0	4.9	BE-RB
377	Conducted	5300	5350.0	64.1	PEAK	1000	74.0	9.9	BE-RB
377	Conducted	5300	5350.0	46.6	AV	1000	54.0	7.4	BE-RB
377	Conducted	5320	5350.0	69.9	PEAK	1000	74.0	4.1	BE-RB
377	Conducted	5320	5350.0	50.2	AV	1000	54.0	3.8	BE-RB
377	Radiated	5320	5350.0	57.2	PEAK	1000	74.0	16.8	BE-RB
377	Radiated	5320	5350.0	42.9	AV	1000	54.0	11.1	BE-RB
377	Conducted	5500	5460.0	59.2	PEAK	1000	74.0	14.8	BE-RB
377	Conducted	5500	5460.0	41.4	AV	1000	54.0	12.6	BE-RB
377	Conducted	5500	5470.0	64.1	PEAK	1000	68.2	4.1	BE-UE
377	Radiated	5500	5460.0	55.3	PEAK	1000	74.0	18.7	BE-RB
377	Radiated	5500	5460.0	42.6	AV	1000	54.0	11.4	BE-RB
377	Radiated	5500	5470.0	55.3	PEAK	1000	68.2	12.9	BE-UE
377	Conducted	5520	5460.0	59.6	PEAK	1000	74.0	14.4	BE-RB
377	Conducted	5520	5460.0	42.8	AV	1000	54.0	11.2	BE-RB
377	Conducted	5520	5470.0	63.8	PEAK	1000	68.2	4.4	BE-UE
377	Conducted	5680	5725.0	60.6	PEAK	1000	68.2	7.6	BE-UE
377	Radiated	5700	5725.0	51.3	PEAK	1000	68.2	16.9	BE-UE
377	Conducted	5700	5725.0	65.1	PEAK	1000	68.2	3.1	BE-UE
377	Conducted	5745	5650.0	54.6	PEAK	1000	65.2	10.6	BE-UE
377	Conducted	5745	5725.0	93.0	PEAK	1000	122.2	29.2	BE-UE
377	Radiated	5745	5725.0	56.8	PEAK	1000	122.2	65.4	BE-UE
377	Conducted	5825	5850.0	85.4	PEAK	1000	122.2	36.8	BE-UE
377	Radiated	5825	5850.0	51.9	PEAK	1000	122.2	70.3	BE-UE
377	Conducted	5825	5925.0	52.0	PEAK	1000	65.2	13.2	BE-UE
374	Radiated	5180	5150.0	55.5	PEAK	1000	74.0	18.5	BE-RB
374	Radiated	5180	5150.0	42.2	AV	1000	54.0	11.8	BE-RB
374	Conducted	5180	5150.0	70.9	PEAK	1000	74.0	3.1	BE-RB
374	Conducted	5180	5150.0	53.2	AV	1000	54.0	0.8	BE-RB
374	Conducted	5200	5150.0	65.8	PEAK	1000	74.0	8.2	BE-RB
374	Conducted	5200	5150.0	49.2	AV	1000	54.0	4.8	BE-RB
374	Conducted	5300	5350.0	62.5	PEAK	1000	74.0	11.5	BE-RB
374	Conducted	5300	5350.0	46.7	AV	1000	54.0	7.3	BE-RB
374	Conducted	5320	5350.0	69.2	PEAK	1000	74.0	4.8	BE-RB
374	Conducted	5320	5350.0	51.2	AV	1000	54.0	2.8	BE-RB
374	Conducted	5500	5460.0	60.0	PEAK	1000	74.0	14.0	BE-RB
374	Conducted	5500	5460.0	42.3	AV	1000	54.0	11.7	BE-RB
374	Conducted	5500	5470.0	67.5	PEAK	1000	68.2	0.7	BE-UE
374	Conducted	5520	5460.0	61.5	PEAK	1000	74.0	12.5	BE-RB
374	Conducted	5520	5460.0	46.5	AV	1000	54.0	7.5	BE-RB
374	Conducted	5520	5470.0	64.8	PEAK	1000	68.2	3.4	BE-UE
377	Conducted	5680	5725.0	62.5	PEAK	1000	68.2	5.7	BE-UE
374	Conducted	5700	5725.0	65.1	PEAK	1000	68.2	3.1	BE-UE
374	Conducted	5745	5650.0	52.4	PEAK	1000	68.2	15.8	BE-UE
374	Conducted	5745	5725.0	77.7	PEAK	1000	122.2	44.5	BE-UE
374	Conducted	5825	5850.0	72.9	PEAK	1000	122.2	49.3	BE-UE
374	Conducted	5825	5925.0	51.5	PEAK	1000	68.2	16.7	BE-UE

WLAN ax-Mode; 20 MHz; MCS0; SISO
Applied duty cycle correction (AV): 0 dB

Variant	Measurement Method	Ch. Center Freq. [MHz]	Band Edge Freq. [MHz]	Spurious Level [dBµV/m]	Detector	RBW [kHz]	Limit [dBµV/m]	Margin [dB]	Limit Type
377	Conducted	5180	5150.0	72.2	PEAK	1000	74.0	1.8	BE-RB
377	Conducted	5180	5150.0	45.5	AV	1000	54.0	8.5	BE-RB
377	Conducted	5320	5350.0	70.6	PEAK	1000	74.0	3.4	BE-RB
377	Conducted	5320	5350.0	45.5	AV	1000	54.0	8.5	BE-RB
377	Conducted	5500	5460.0	55.8	PEAK	1000	74.0	18.2	BE-RB
377	Conducted	5500	5460.0	41.2	AV	1000	54.0	12.8	BE-RB
377	Conducted	5500	5470.0	62.0	PEAK	1000	68.2	6.2	BE-UE
377	Conducted	5700	5725.0	67.0	PEAK	1000	68.2	1.2	BE-UE

WLAN n-Mode; 20 MHz; MCS0; SISO
Applied duty cycle correction (AV): 0 dB

Variant	Measurement Method	Ch. Center Freq. [MHz]	Band Edge Freq. [MHz]	Spurious Level [dBµV/m]	Detector	RBW [kHz]	Limit [dBµV/m]	Margin [dB]	Limit Type
377	Conducted	5180	5150.0	71.3	PEAK	1000	74.0	2.7	BE-RB
377	Conducted	5180	5150.0	44.1	AV	1000	54.0	9.9	BE-RB
377	Conducted	5200	5150.0	64.9	PEAK	1000	74.0	9.1	BE-RB
377	Conducted	5200	5150.0	49.1	AV	1000	54.0	4.9	BE-RB
377	Conducted	5300	5350.0	64.3	PEAK	1000	74.0	9.7	BE-RB
377	Conducted	5300	5350.0	44.6	AV	1000	54.0	9.4	BE-RB
377	Conducted	5320	5350.0	68.7	PEAK	1000	74.0	5.3	BE-RB
377	Conducted	5320	5350.0	43.8	AV	1000	54.0	10.2	BE-RB
377	Conducted	5500	5460.0	57.4	PEAK	1000	74.0	16.6	BE-RB
377	Conducted	5500	5460.0	40.8	AV	1000	54.0	13.2	BE-RB
377	Conducted	5500	5470.0	62.3	PEAK	1000	68.2	5.9	BE-UE
377	Conducted	5700	5725.0	65.2	PEAK	1000	68.2	3.0	BE-UE

WLAN ax-Mode; 40 MHz; MCS0; SISO
Applied duty cycle correction (AV): 0 dB

Variant	Measurement Method	Ch. Center Freq. [MHz]	Band Edge Freq. [MHz]	Spurious Level [dBµV/m]	Detector	RBW [kHz]	Limit [dBµV/m]	Margin [dB]	Limit Type
377	Conducted	5190	5150.0	72.1	PEAK	1000	74.0	1.9	BE-RB
377	Conducted	5190	5150.0	49.9	AV	1000	54.0	4.1	BE-RB
377	Conducted	5310	5350.0	70.9	PEAK	1000	74.0	3.1	BE-RB
377	Conducted	5310	5350.0	47.2	AV	1000	54.0	6.8	BE-RB
377	Conducted	5510	5460.0	58.6	PEAK	1000	74.0	15.4	BE-RB
377	Conducted	5510	5460.0	42.2	AV	1000	54.0	11.8	BE-RB
377	Conducted	5510	5470.0	64.9	PEAK	1000	68.2	3.3	BE-UE

WLAN n-Mode; 40 MHz; MCS0; SISO
Applied duty cycle correction (AV): 0 dB

Variant	Measurement Method	Ch. Center Freq. [MHz]	Band Edge Freq. [MHz]	Spurious Level [dBµV/m]	Detector	RBW [kHz]	Limit [dBµV/m]	Margin [dB]	Limit Type
377	Conducted	5190	5150.0	71.6	PEAK	1000	74.0	2.4	BE-RB
377	Conducted	5190	5150.0	48.4	AV	1000	54.0	5.6	BE-RB
377	Conducted	5310	5350.0	71.2	PEAK	1000	74.0	2.8	BE-RB
377	Conducted	5310	5350.0	48.5	AV	1000	54.0	5.5	BE-RB
377	Conducted	5510	5460.0	60.7	PEAK	1000	74.0	13.3	BE-RB
377	Conducted	5510	5460.0	44.6	AV	1000	54.0	9.4	BE-RB
377	Conducted	5510	5470.0	65.8	PEAK	1000	68.2	2.4	BE-UE
377	Conducted	5670	5725.0	63.9	PEAK	1000	68.2	4.3	BE-UE

WLAN ax-Mode; 80 MHz; MCS0; SISO
 Applied duty cycle correction (AV): 0 dB

Variant	Measurement Method	Ch. Center Freq. [MHz]	Band Edge Freq. [MHz]	Spurious Level [dBµV/m]	Detector	RBW [kHz]	Limit [dBµV/m]	Margin [dB]	Limit Type
377	Conducted	5210	5150.0	71.5	PEAK	1000	74.0	2.5	BE-RB
377	Conducted	5210	5150.0	53.8	AV	1000	54.0	0.2	BE-RB
377	Conducted	5290	5350.0	66.7	PEAK	1000	74.0	7.3	BE-RB
377	Conducted	5290	5350.0	52.6	AV	1000	54.0	1.4	BE-RB
377	Conducted	5530	5460.0	64.1	PEAK	1000	74.0	9.9	BE-RB
377	Conducted	5530	5460.0	50.5	AV	1000	54.0	3.5	BE-RB
377	Conducted	5530	5470.0	65.1	PEAK	1000	68.2	3.1	BE-UE
374	Conducted	5775	5650.0	60.4	PEAK	1000	68.2	7.8	BE-UE
374	Conducted	5775	5725.0	69.1	PEAK	1000	122.2	53.1	BE-UE
374	Conducted	5775	5850.0	65.1	PEAK	1000	122.2	57.1	BE-UE
374	Conducted	5775	5925.0	59.6	PEAK	1000	68.2	8.6	BE-UE

WLAN ac-Mode; 20 MHz; MCS0; SISO
 Applied duty cycle correction (AV): 0 dB

Variant	Measurement Method	Ch. Center Freq. [MHz]	Band Edge Freq. [MHz]	Spurious Level [dBµV/m]	Detector	RBW [kHz]	Limit [dBµV/m]	Margin [dB]	Limit Type
377	Conducted	5180	5150.0	70.8	PEAK	1000	74.0	3.2	BE-RB
377	Conducted	5180	5150.0	44.2	AV	1000	54.0	9.8	BE-RB
377	Conducted	5300	5350.0	64.4	PEAK	1000	74.0	9.6	BE-RB
377	Conducted	5300	5350.0	44.4	AV	1000	54.0	9.6	BE-RB
377	Conducted	5320	5350.0	69.0	PEAK	1000	74.0	5.0	BE-RB
377	Conducted	5320	5350.0	43.9	AV	1000	54.0	10.1	BE-RB
377	Conducted	5500	5460.0	56.7	PEAK	1000	74.0	17.3	BE-RB
377	Conducted	5500	5460.0	40.8	AV	1000	54.0	13.2	BE-RB
377	Conducted	5500	5470.0	62.9	PEAK	1000	68.2	5.3	BE-UE
377	Conducted	5700	5725.0	65.5	PEAK	1000	68.2	2.7	BE-UE

WLAN ax-Mode; 20 MHz; MCS0; MIMO
 Applied duty cycle correction (AV): 0 dB

Variant	Measurement Method	Ch. Center Freq. [MHz]	Band Edge Freq. [MHz]	Spurious Level [dBµV/m]	Detector	RBW [kHz]	Limit [dBµV/m]	Margin [dB]	Limit Type
377	Conducted	5180	5150.0	72.3	PEAK	1000	74.0	1.7	BE-RB
377	Conducted	5180	5150.0	47.0	AV	1000	54.0	7.0	BE-RB
377	Conducted	5200	5150.0	64.1	PEAK	1000	74.0	9.9	BE-RB
377	Conducted	5200	5150.0	43.9	AV	1000	54.0	10.1	BE-RB
377	Conducted	5300	5350.0	65.7	PEAK	1000	74.0	8.3	BE-RB
377	Conducted	5300	5350.0	43.2	AV	1000	54.0	10.8	BE-RB
377	Conducted	5320	5350.0	72.9	PEAK	1000	74.0	1.1	BE-RB
377	Conducted	5320	5350.0	47.4	AV	1000	54.0	6.6	BE-RB
377	Conducted	5500	5460.0	59.0	PEAK	1000	74.0	15.0	BE-RB
377	Conducted	5500	5460.0	42.4	AV	1000	54.0	11.6	BE-RB
377	Conducted	5500	5470.0	64.6	PEAK	1000	68.2	3.6	BE-UE
377	Conducted	5520	5460.0	56.6	PEAK	1000	74.0	17.4	BE-RB
377	Conducted	5520	5460.0	41.2	AV	1000	54.0	12.8	BE-RB
377	Conducted	5520	5470.0	62.3	PEAK	1000	68.2	5.9	BE-UE
377	Conducted	5680	5725.0	61.0	PEAK	1000	68.2	7.2	BE-UE
377	Conducted	5700	5725.0	67.1	PEAK	1000	68.2	1.1	BE-UE

WLAN ac-Mode; 40 MHz; MCS0; SISO
Applied duty cycle correction (AV): 0 dB

Variant	Measurement Method	Ch. Center Freq. [MHz]	Band Edge Freq. [MHz]	Spurious Level [dBµV/m]	Detector	RBW [kHz]	Limit [dBµV/m]	Margin [dB]	Limit Type
377	Conducted	5190	5150.0	71.4	PEAK	1000	74.0	2.6	BE-RB
377	Conducted	5190	5150.0	48.7	AV	1000	54.0	5.3	BE-RB
377	Conducted	5310	5350.0	71.2	PEAK	1000	74.0	2.8	BE-RB
377	Conducted	5310	5350.0	48.4	AV	1000	54.0	5.6	BE-RB
377	Conducted	5510	5460.0	58.5	PEAK	1000	74.0	15.5	BE-RB
377	Conducted	5510	5460.0	43.0	AV	1000	54.0	11.0	BE-RB
377	Conducted	5510	5470.0	64.7	PEAK	1000	68.2	3.5	BE-UE

WLAN ax-Mode; 40 MHz; MCS0; MIMO
Applied duty cycle correction (AV): 0 dB

Variant	Measurement Method	Ch. Center Freq. [MHz]	Band Edge Freq. [MHz]	Spurious Level [dBµV/m]	Detector	RBW [kHz]	Limit [dBµV/m]	Margin [dB]	Limit Type
377	Conducted	5190	5150.0	68.5	PEAK	1000	74.0	5.5	BE-RB
377	Conducted	5190	5150.0	48.8	AV	1000	54.0	5.2	BE-RB
377	Conducted	5230	5150.0	68.2	PEAK	1000	74.0	5.8	BE-RB
377	Conducted	5230	5150.0	46.5	AV	1000	54.0	7.5	BE-RB
377	Conducted	5270	5350.0	64.2	PEAK	1000	74.0	9.8	BE-RB
377	Conducted	5270	5350.0	44.3	AV	1000	54.0	9.7	BE-RB
377	Conducted	5310	5350.0	67.1	PEAK	1000	74.0	6.9	BE-RB
377	Conducted	5310	5350.0	47.4	AV	1000	54.0	6.6	BE-RB
377	Conducted	5510	5460.0	60.5	PEAK	1000	74.0	13.5	BE-RB
377	Conducted	5510	5460.0	43.3	AV	1000	54.0	10.7	BE-RB
377	Conducted	5510	5470.0	65.7	PEAK	1000	68.2	2.5	BE-UE
377	Conducted	5550	5460.0	58.7	PEAK	1000	74.0	15.3	BE-RB
377	Conducted	5550	5460.0	42.0	AV	1000	54.0	12.0	BE-RB
377	Conducted	5550	5470.0	57.6	PEAK	1000	68.2	10.6	BE-UE
377	Conducted	5670	5725.0	67.1	PEAK	1000	68.2	1.1	BE-UE

WLAN ac-Mode; 80 MHz; MCS0; SISO
Applied duty cycle correction (AV): 0 dB

Variant	Measurement Method	Ch. Center Freq. [MHz]	Band Edge Freq. [MHz]	Spurious Level [dBµV/m]	Detector	RBW [kHz]	Limit [dBµV/m]	Margin [dB]	Limit Type
377	Conducted	5210	5150.0	69.4	PEAK	1000	74.0	4.6	BE-RB
377	Conducted	5210	5150.0	52.0	AV	1000	54.0	2.0	BE-RB
377	Conducted	5290	5350.0	66.1	PEAK	1000	74.0	7.9	BE-RB
377	Conducted	5290	5350.0	51.4	AV	1000	54.0	2.6	BE-RB
377	Conducted	5530	5460.0	61.3	PEAK	1000	74.0	12.7	BE-RB
377	Conducted	5530	5460.0	48.5	AV	1000	54.0	5.5	BE-RB
377	Conducted	5530	5470.0	64.6	PEAK	1000	68.2	3.6	BE-UE
374	Conducted	5775	5650.0	62.9	PEAK	1000	68.2	5.3	BE-UE
374	Conducted	5775	5725.0	72.8	PEAK	1000	122.2	49.4	BE-UE
374	Conducted	5775	5850.0	68.5	PEAK	1000	122.2	53.7	BE-UE
374	Conducted	5775	5925.0	57.1	PEAK	1000	68.2	11.1	BE-UE

WLAN ax-Mode; 80 MHz; MCS0; MIMO
 Applied duty cycle correction (AV): 0 dB

Variant	Measurement Method	Ch. Center Freq. [MHz]	Band Edge Freq. [MHz]	Spurious Level [dBµV/m]	Detector	RBW [kHz]	Limit [dBµV/m]	Margin [dB]	Limit Type
377	Conducted	5210	5150.0	71.0	PEAK	1000	74.0	3.0	BE-RB
377	Conducted	5210	5150.0	52.4	AV	1000	54.0	1.6	BE-RB
377	Conducted	5290	5350.0	67.4	PEAK	1000	74.0	6.6	BE-RB
377	Conducted	5290	5350.0	50.3	AV	1000	54.0	3.7	BE-RB
377	Conducted	5530	5460.0	67.4	PEAK	1000	74.0	6.6	BE-RB
377	Conducted	5530	5460.0	50.2	AV	1000	54.0	3.8	BE-RB
377	Conducted	5530	5470.0	66.5	PEAK	1000	68.2	1.7	BE-UE
377	Conducted	5775	5650.0	65.6	PEAK	1000	68.2	2.6	BE-UE
377	Conducted	5775	5725.0	72.5	PEAK	1000	122.2	49.7	BE-UE
377	Conducted	5775	5850.0	69.1	PEAK	1000	122.2	53.1	BE-UE
377	Conducted	5775	5925.0	59.7	PEAK	1000	68.2	8.5	BE-UE
374	Conducted	5775	5725.0	65.0	PEAK	1000	68.2	3.2	BE-UE
374	Conducted	5775	5725.0	72.3	PEAK	1000	122.2	49.9	BE-UE
374	Conducted	5775	5850.0	69.2	PEAK	1000	122.2	53.0	BE-UE
374	Conducted	5775	5850.0	59.6	PEAK	1000	68.2	8.6	BE-UE

WLAN n-Mode; 20 MHz; MCS8; MIMO
 Applied duty cycle correction (AV): 0 dB

U-NII-Subband	Measurement Method	Ch. Center Freq. [MHz]	Band Edge Freq. [MHz]	Spurious Level [dBµV/m]	Detector	RBW [kHz]	Limit [dBµV/m]	Margin [dB]	Limit Type
377	Conducted	5180	5150.0	72.3	PEAK	1000	74.0	1.7	BE-RB
377	Conducted	5180	5150.0	45.8	AV	1000	54.0	8.2	BE-RB
377	Conducted	5200	5150.0	67.2	PEAK	1000	74.0	6.8	BE-RB
377	Conducted	5200	5150.0	48.1	AV	1000	54.0	5.9	BE-RB
377	Conducted	5300	5350.0	66.6	PEAK	1000	74.0	7.4	BE-RB
377	Conducted	5300	5350.0	46.7	AV	1000	54.0	7.3	BE-RB
377	Conducted	5320	5350.0	70.2	PEAK	1000	74.0	3.8	BE-RB
377	Conducted	5320	5350.0	46.4	AV	1000	54.0	7.6	BE-RB
377	Conducted	5500	5460.0	60.8	PEAK	1000	74.0	13.2	BE-RB
377	Conducted	5500	5460.0	42.0	AV	1000	54.0	12.0	BE-RB
377	Conducted	5500	5470.0	64.8	PEAK	1000	68.2	3.4	BE-UE
377	Conducted	5500	5460.0	61.6	PEAK	1000	74.0	12.4	BE-RB
377	Conducted	5500	5460.0	42.5	AV	1000	54.0	11.5	BE-RB
377	Conducted	5500	5470.0	65.2	PEAK	1000	68.2	3.0	BE-UE
377	Conducted	5680	5725.0	62.4	PEAK	1000	68.2	5.8	BE-UE
377	Conducted	5700	5725.0	67.3	PEAK	1000	68.2	0.9	BE-UE
374	Conducted	5180	5150.0	72.5	PEAK	1000	74.0	1.5	BE-RB
374	Conducted	5180	5150.0	52.6	AV	1000	54.0	1.4	BE-RB
374	Conducted	5200	5150.0	66.3	PEAK	1000	74.0	7.7	BE-RB
374	Conducted	5200	5150.0	51.7	AV	1000	54.0	2.3	BE-RB
374	Conducted	5300	5350.0	68.7	PEAK	1000	74.0	5.3	BE-RB
374	Conducted	5300	5350.0	45.6	AV	1000	54.0	8.4	BE-RB
374	Conducted	5320	5350.0	72.6	PEAK	1000	74.0	1.4	BE-RB
374	Conducted	5320	5350.0	47.8	AV	1000	54.0	6.2	BE-RB
374	Conducted	5500	5460.0	60.7	PEAK	1000	74.0	13.3	BE-RB
374	Conducted	5500	5460.0	44.6	AV	1000	54.0	9.4	BE-RB
374	Conducted	5500	5470.0	62.6	PEAK	1000	68.2	5.6	BE-UE
374	Conducted	5520	5460.0	64.9	PEAK	1000	74.0	9.1	BE-RB
374	Conducted	5520	5460.0	47.6	AV	1000	54.0	6.4	BE-RB
374	Conducted	5520	5470.0	66.3	PEAK	1000	68.2	1.9	BE-UE
374	Conducted	5680	5725.0	68.1	PEAK	1000	68.2	0.1	BE-UE
374	Conducted	5700	5725.0	67.2	PEAK	1000	68.2	1.0	BE-UE

WLAN n-Mode; 40 MHz; MCS8; MIMO
 Applied duty cycle correction (AV): 0 dB

Variant	Measurement Method	Ch. Center Freq. [MHz]	Band Edge Freq. [MHz]	Spurious Level [dBµV/m]	Detector	RBW [kHz]	Limit [dBµV/m]	Margin [dB]	Limit Type
377	Conducted	5190	5150.0	72.2	PEAK	1000	74.0	1.8	BE-RB
377	Conducted	5190	5150.0	46.9	AV	1000	54.0	7.1	BE-RB
377	Conducted	5230	5150.0	70.8	PEAK	1000	74.0	3.2	BE-RB
377	Conducted	5230	5150.0	48.1	AV	1000	54.0	5.9	BE-RB
377	Conducted	5270	5350.0	65.2	PEAK	1000	74.0	8.8	BE-RB
377	Conducted	5270	5350.0	45.3	AV	1000	54.0	8.7	BE-RB
377	Conducted	5310	5350.0	71.6	PEAK	1000	74.0	2.4	BE-RB
377	Conducted	5310	5350.0	46.4	AV	1000	54.0	7.6	BE-RB
377	Conducted	5510	5460.0	60.6	PEAK	1000	74.0	13.4	BE-RB
377	Conducted	5510	5460.0	42.3	AV	1000	54.0	11.7	BE-RB
377	Conducted	5510	5470.0	66.3	PEAK	1000	68.2	1.9	BE-UE
377	Conducted	5510	5460.0	57.4	PEAK	1000	74.0	16.6	BE-RB
377	Conducted	5510	5460.0	42.7	AV	1000	54.0	11.3	BE-RB
377	Conducted	5510	5470.0	63.2	PEAK	1000	68.2	5.0	BE-UE
377	Conducted	5670	5725.0	67.6	PEAK	1000	68.2	0.6	BE-UE
377	Conducted	5755	5650.0	52.9	PEAK	1000	68.2	15.3	BE-UE
377	Conducted	5755	5725.0	75.4	PEAK	1000	122.2	46.8	BE-UE

WLAN ac-Mode; 20 MHz; MCS0; MIMO
 Applied duty cycle correction (AV): 0 dB

Variant	Measurement Method	Ch. Center Freq. [MHz]	Band Edge Freq. [MHz]	Spurious Level [dBµV/m]	Detector	RBW [kHz]	Limit [dBµV/m]	Margin [dB]	Limit Type
377	Conducted	5180	5150.0	71.2	PEAK	1000	74.0	2.8	BE-RB
377	Conducted	5180	5150.0	46.0	AV	1000	54.0	8.0	BE-RB
377	Conducted	5180	5150.0	66.9	PEAK	1000	74.0	7.1	BE-RB
377	Conducted	5180	5150.0	48.1	AV	1000	54.0	5.9	BE-RB
377	Conducted	5320	5350.0	65.4	PEAK	1000	74.0	8.6	BE-RB
377	Conducted	5320	5350.0	46.4	AV	1000	54.0	7.6	BE-RB
377	Conducted	5320	5350.0	70.9	PEAK	1000	74.0	3.1	BE-RB
377	Conducted	5320	5350.0	46.1	AV	1000	54.0	7.9	BE-RB
377	Conducted	5500	5460.0	59.9	PEAK	1000	74.0	14.1	BE-RB
377	Conducted	5500	5460.0	42.1	AV	1000	54.0	11.9	BE-RB
377	Conducted	5500	5470.0	64.8	PEAK	1000	68.2	3.4	BE-UE
377	Conducted	5520	5460.0	62.0	PEAK	1000	74.0	12.0	BE-RB
377	Conducted	5520	5460.0	42.4	AV	1000	54.0	11.6	BE-RB
377	Conducted	5520	5470.0	65.0	PEAK	1000	68.2	3.2	BE-UE
377	Conducted	5680	5725.0	62.6	PEAK	1000	68.2	5.6	BE-UE
377	Conducted	5700	5725.0	67.4	PEAK	1000	68.2	0.8	BE-UE

WLAN ac-Mode; 40 MHz; MCS0; MIMO
 Applied duty cycle correction (AV): 0 dB

Variant	Measurement Method	Ch. Center Freq. [MHz]	Band Edge Freq. [MHz]	Spurious Level [dBµV/m]	Detector	RBW [kHz]	Limit [dBµV/m]	Margin [dB]	Limit Type
377	Conducted	5190	5150.0	71.1	PEAK	1000	74.0	2.9	BE-RB
377	Conducted	5190	5150.0	47.7	AV	1000	54.0	6.3	BE-RB
377	Conducted	5230	5150.0	70.2	PEAK	1000	74.0	3.8	BE-RB
377	Conducted	5230	5150.0	48.0	AV	1000	54.0	6.0	BE-RB
377	Conducted	5270	5350.0	65.0	PEAK	1000	74.0	9.0	BE-RB
377	Conducted	5270	5350.0	45.3	AV	1000	54.0	8.7	BE-RB
377	Conducted	5310	5350.0	68.6	PEAK	1000	74.0	5.4	BE-RB
377	Conducted	5310	5350.0	47.0	AV	1000	54.0	7.0	BE-RB
377	Conducted	5510	5460.0	60.6	PEAK	1000	74.0	13.4	BE-RB
377	Conducted	5510	5460.0	42.3	AV	1000	54.0	11.7	BE-RB
377	Conducted	5510	5470.0	65.4	PEAK	1000	68.2	2.8	BE-UE
377	Conducted	5550	5460.0	56.7	PEAK	1000	74.0	17.3	BE-RB
377	Conducted	5550	5460.0	42.2	AV	1000	54.0	11.8	BE-RB
377	Conducted	5550	5470.0	59.8	PEAK	1000	68.2	8.4	BE-UE
377	Conducted	5670	5725.0	64.3	PEAK	1000	68.2	3.9	BE-UE
377	Conducted	5755	5650.0	52.1	PEAK	1000	68.2	16.1	BE-UE
377	Conducted	5755	5725.0	76.1	PEAK	1000	122.2	46.1	BE-UE

WLAN ac-Mode; 80 MHz; MCS0; MIMO
 Applied duty cycle correction (AV): 0 dB

Variant	Measurement Method	Ch. Center Freq. [MHz]	Band Edge Freq. [MHz]	Spurious Level [dBµV/m]	Detector	RBW [kHz]	Limit [dBµV/m]	Margin [dB]	Limit Type
377	Conducted	5210	5150.0	68.5	PEAK	1000	74.0	5.5	BE-RB
377	Conducted	5210	5150.0	51.7	AV	1000	54.0	2.3	BE-RB
377	Conducted	5290	5350.0	66.8	PEAK	1000	74.0	7.2	BE-RB
377	Conducted	5290	5350.0	50.3	AV	1000	54.0	3.7	BE-RB
377	Conducted	5530	5460.0	64.8	PEAK	1000	74.0	9.2	BE-RB
377	Conducted	5530	5460.0	49.2	AV	1000	54.0	4.8	BE-RB
377	Conducted	5530	5470.0	67.2	PEAK	1000	68.2	1.0	BE-UE
377	Conducted	5775	5650.0	67.1	PEAK	1000	68.2	1.1	BE-UE
377	Conducted	5775	5725.0	76.2	PEAK	1000	122.2	46.0	BE-UE
377	Conducted	5775	5850.0	69.8	PEAK	1000	122.2	52.4	BE-UE
377	Conducted	5775	5925.0	63.5	PEAK	1000	68.2	4.7	BE-UE
374	Conducted	5650	5725.0	67.5	PEAK	1000	68.2	0.7	BE-UE
374	Conducted	5775	5725.0	75.4	PEAK	1000	122.2	46.8	BE-UE
374	Conducted	5775	5850.0	70.4	PEAK	1000	122.2	51.8	BE-UE
374	Conducted	5775	5925.0	59.7	PEAK	1000	68.2	8.5	BE-UE

Remark: Please see next sub-clause for the measurement plot.

OFDMA with one active Resource Unit (worst case OFDMA):

WLAN ax-Mode; 20 MHz; MCS0; MIMO
Applied duty cycle correction (AV): 0 dB

Variant	Measurement Method	Ch. Center Freq. [MHz]	Band Edge Freq. [MHz]	Spurious Level [dBµV/m]	Detector	RBW [kHz]	Limit [dBµV/m]	Margin [dB]	Limit Type
377	Conducted	5180	5150.0	64.6	PEAK	1000	74.0	9.4	BE-RB
377	Conducted	5180	5150.0	43.2	AV	1000	54.0	10.8	BE-RB
377	Conducted	5320	5350.0	64.9	PEAK	1000	74.0	9.1	BE-RB
377	Conducted	5320	5350.0	43.1	AV	1000	54.0	10.9	BE-RB
377	Conducted	5500	5460.0	64.3	PEAK	1000	74.0	9.7	BE-RB
377	Conducted	5500	5460.0	43.4	AV	1000	54.0	10.6	BE-RB
377	Conducted	5500	5470.0	65.8	PEAK	1000	68.2	2.4	BE-UE
377	Conducted	5700	5725.0	67.7	PEAK	1000	68.2	0.5	BE-UE
377	Conducted	5745	5725.0	70.9	PEAK	1000	122.2	51.3	BE-UE
377	Conducted	5825	5850.0	65.1	PEAK	1000	122.2	57.1	BE-UE
374	Conducted	5700	5725.0	64.6	PEAK	1000	68.2	3.6	BE-UE

WLAN ax-Mode; 40 MHz; MCS0; MIMO
Applied duty cycle correction (AV): 0 dB

Variant	Measurement Method	Ch. Center Freq. [MHz]	Band Edge Freq. [MHz]	Spurious Level [dBµV/m]	Detector	RBW [kHz]	Limit [dBµV/m]	Margin [dB]	Limit Type
377	Conducted	5190	5150.0	67.9	PEAK	1000	74.0	6.1	BE-RB
377	Conducted	5190	5150.0	43.4	AV	1000	54.0	10.6	BE-RB
377	Conducted	5310	5350.0	69.9	PEAK	1000	74.0	4.1	BE-RB
377	Conducted	5310	5350.0	43.5	AV	1000	54.0	10.5	BE-RB
377	Conducted	5510	5460.0	63.1	PEAK	1000	74.0	10.9	BE-RB
377	Conducted	5510	5460.0	43.2	AV	1000	54.0	10.8	BE-RB
377	Conducted	5510	5470.0	67.2	PEAK	1000	68.2	1.0	BE-UE
377	Conducted	5670	5725.0	66.2	PEAK	1000	68.2	2.0	BE-UE
377	Conducted	5755	5725.0	72.6	PEAK	1000	122.2	49.6	BE-UE
377	Conducted	5795	5850.0	60.9	PEAK	1000	122.2	61.3	BE-UE
374	Conducted	5510	5460.0	63.3	PEAK	1000	74.0	10.7	BE-RB
374	Conducted	5510	5460.0	45.0	AV	1000	54.0	9.0	BE-RB
374	Conducted	5510	5470.0	67.6	PEAK	1000	68.2	0.6	BE-UE

WLAN ax-Mode; 80 MHz; MCS0; MIMO
Applied duty cycle correction (AV): 0 dB

Variant	Measurement Method	Ch. Center Freq. [MHz]	Band Edge Freq. [MHz]	Spurious Level [dBµV/m]	Detector	RBW [kHz]	Limit [dBµV/m]	Margin [dB]	Limit Type
377	Conducted	5210	5150.0	67.6	PEAK	1000	74.0	6.4	BE-RB
377	Conducted	5210	5150.0	43.4	AV	1000	54.0	10.6	BE-RB
377	Conducted	5290	5350.0	67.8	PEAK	1000	74.0	6.2	BE-RB
377	Conducted	5290	5350.0	43.5	AV	1000	54.0	10.5	BE-RB
377	Conducted	5530	5460.0	65.7	PEAK	1000	74.0	8.3	BE-RB
377	Conducted	5530	5460.0	43.6	AV	1000	54.0	10.4	BE-RB
377	Conducted	5530	5470.0	67.5	PEAK	1000	68.2	0.7	BE-UE
377	Conducted	5775	5650.0	55.3	PEAK	1000	68.2	12.9	BE-UE
377	Conducted	5775	5725.0	68.9	PEAK	1000	122.2	53.3	BE-UE
377	Conducted	5775	5850.0	61.5	PEAK	1000	122.2	60.7	BE-UE
377	Conducted	5775	5925.0	54.2	PEAK	1000	68.2	14.0	BE-UE
374	Conducted	5530	5460.0	64.9	PEAK	1000	74.0	9.1	BE-RB
374	Conducted	5530	5460.0	44.9	AV	1000	54.0	9.1	BE-RB
374	Conducted	5530	5470.0	67.1	PEAK	1000	68.2	1.1	BE-UE

Remark: Band Edge of Band 1 has been performed at 9 dBm power setting. Since that is worse case compared to the final output power, the test was not repeated with lower power. Lower Band Edge with setup S01_377_AE01 was performed at 8 dBm and not repeated at 7 dBm since it is worse case. Please see next sub-clause for the measurement plot.

5.8.4 MEASUREMENT PLOT (EXAMPLE PLOT, SHOWING WORST CASE, IF APPLICABLE)

Radio Technology = WLAN a, Operating Frequency = low, Subband = U-NII-3 (S01_377_AA01)

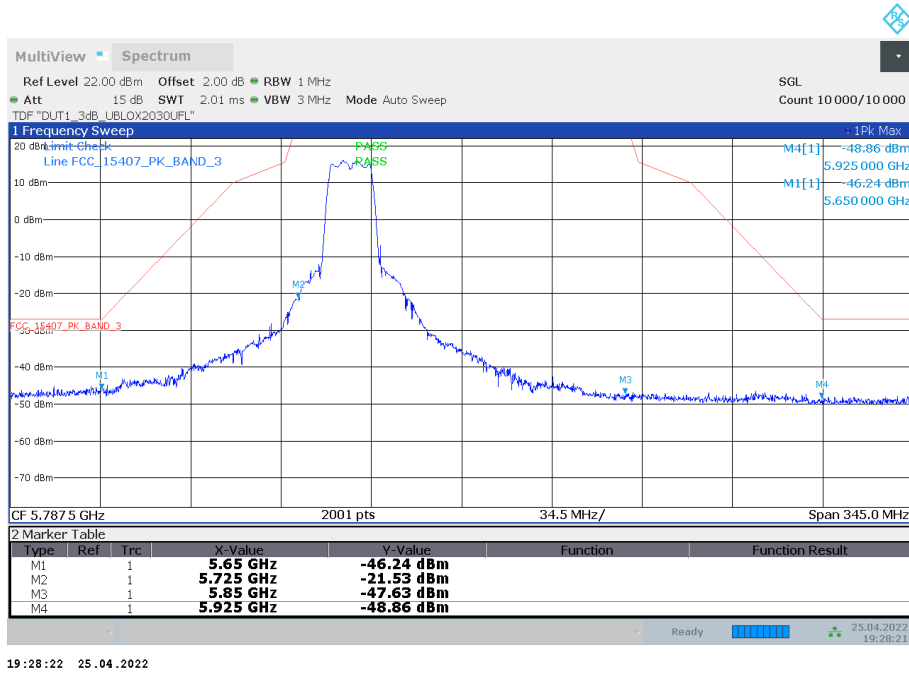

19:28:22 25.04.2022

Antenna A

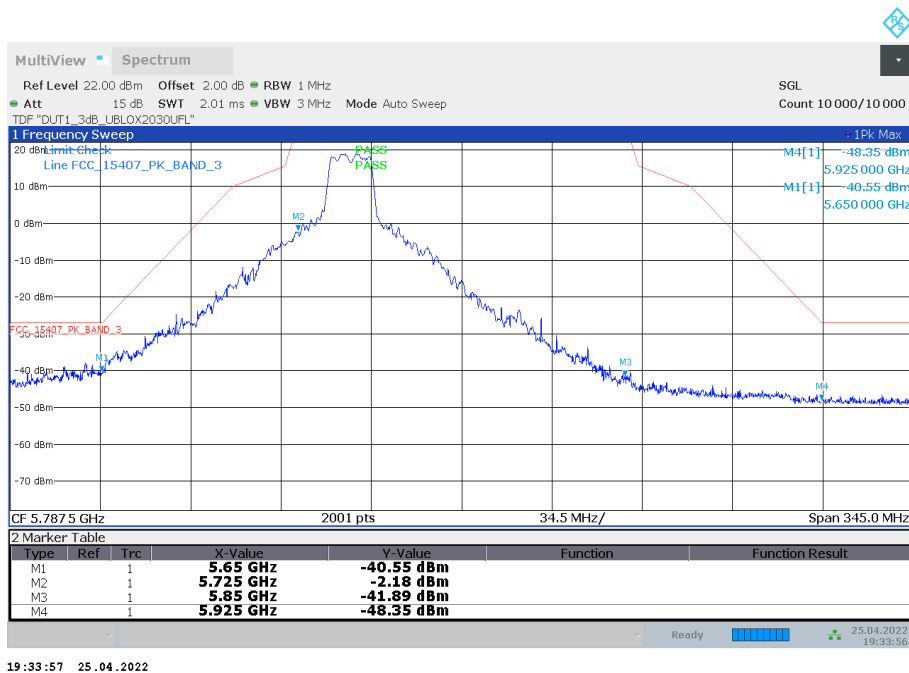

19:33:57 25.04.2022

Antenna B

Radio Technology = WLAN a, Operating Frequency = high, Subband = U-NII-3 (S01_377_AA01)

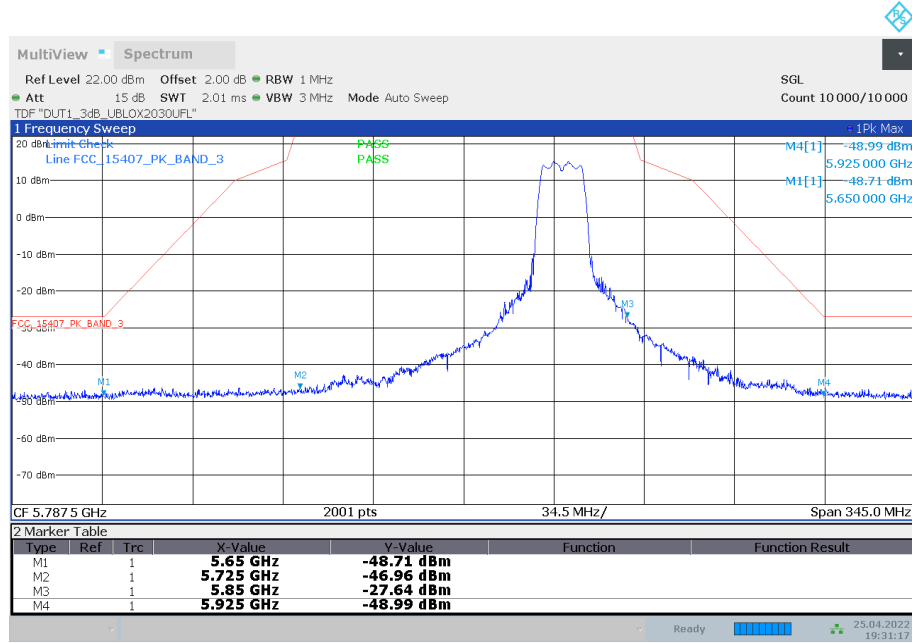

19:31:17 25.04.2022

Antenna A

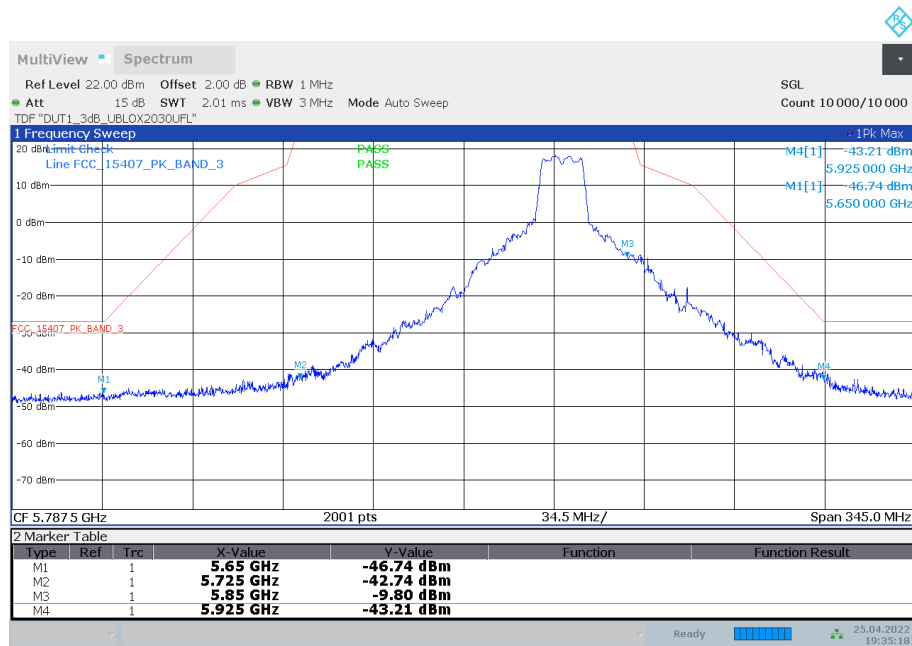

19:35:18 25.04.2022

Antenna B

Radio Technology = WLAN a, Operating Frequency = low, Subband = U-NII-2C
(S01_377_AA01)

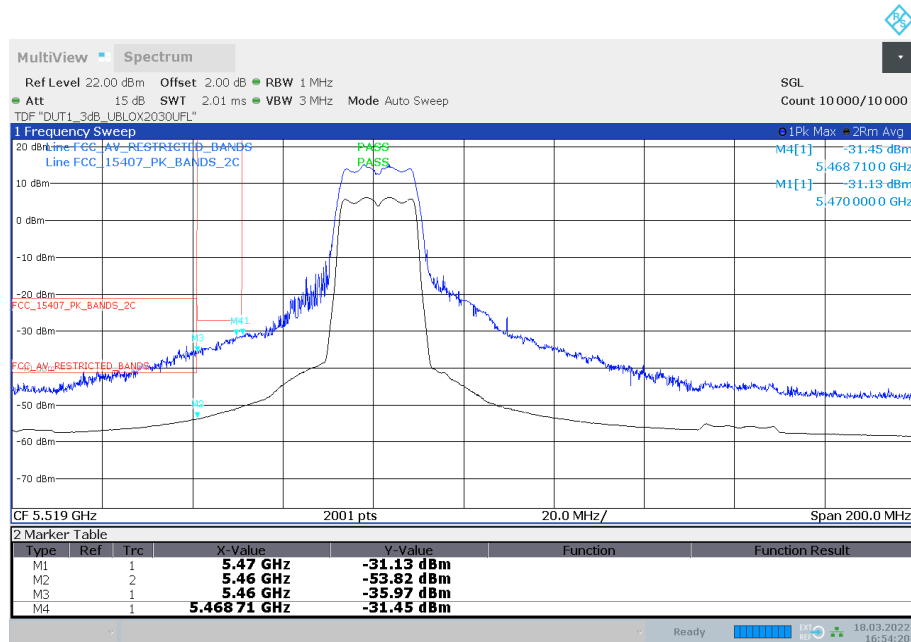

16:54:21 18.03.2022

Antenna A

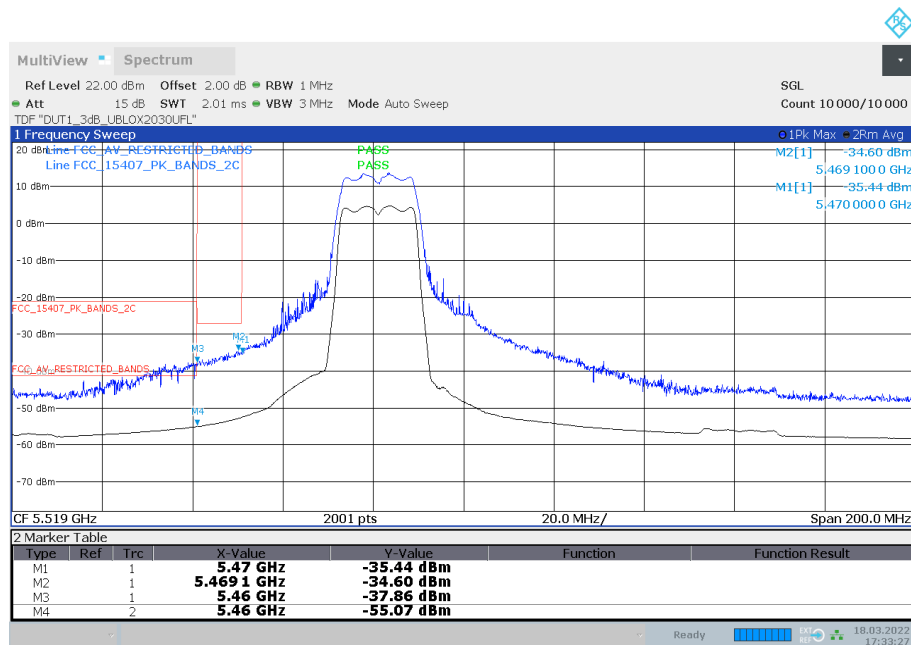

17:33:28 18.03.2022

Antenna B

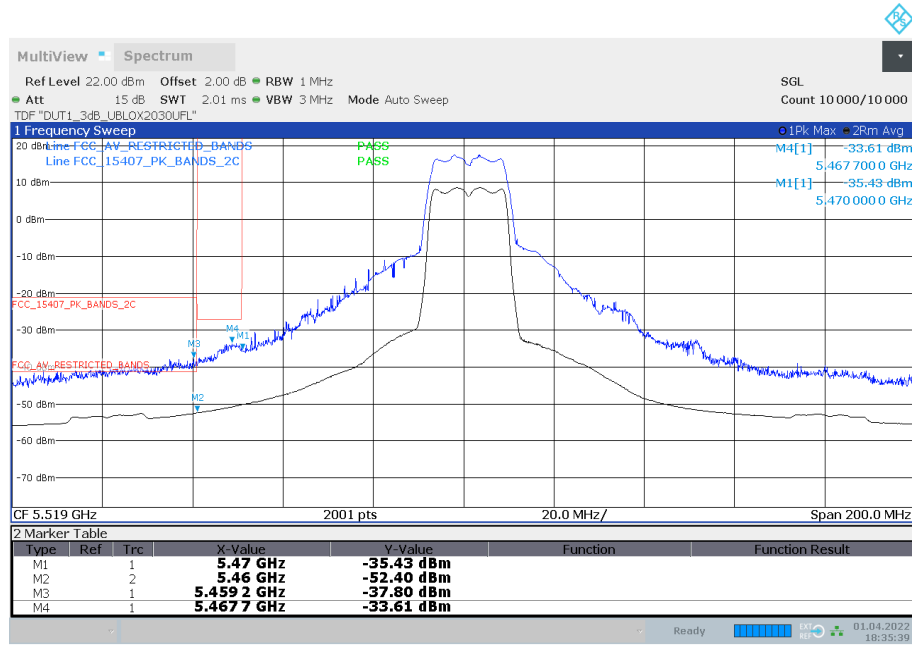

18:35:39 01.04.2022

Antenna A

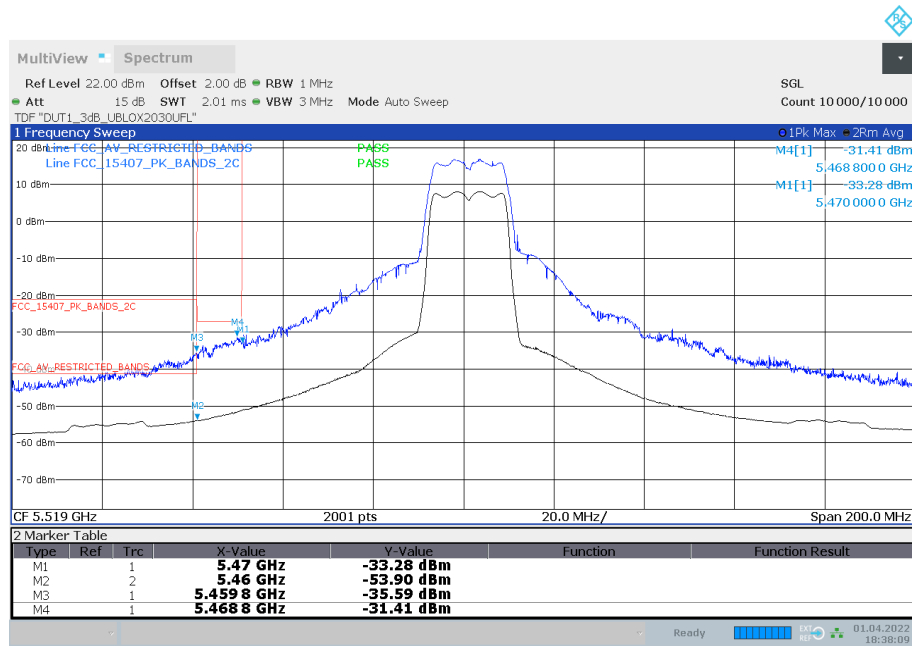

18:38:10 01.04.2022

Antenna B

Radio Technology = WLAN a, Operating Frequency = high, Subband = U-NII-2C
(S01_377_AA01)

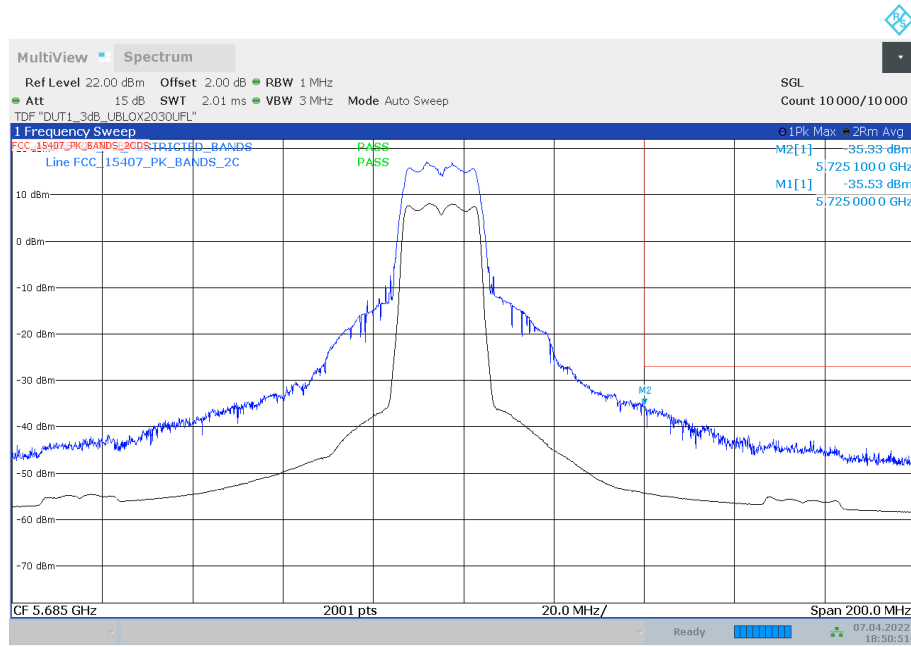

18:50:51 07.04.2022

Antenna A

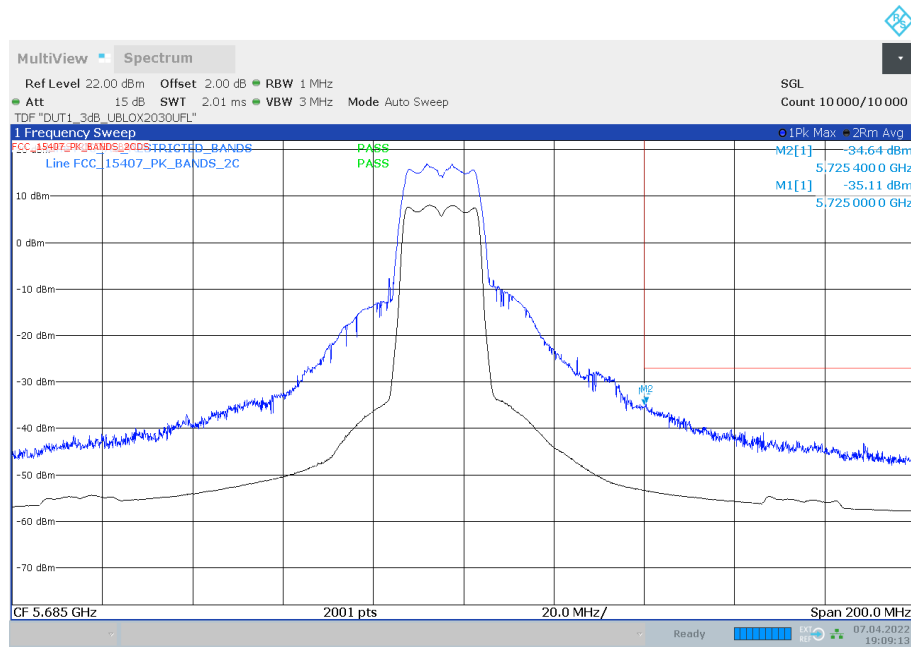

19:09:13 07.04.2022

Antenna B

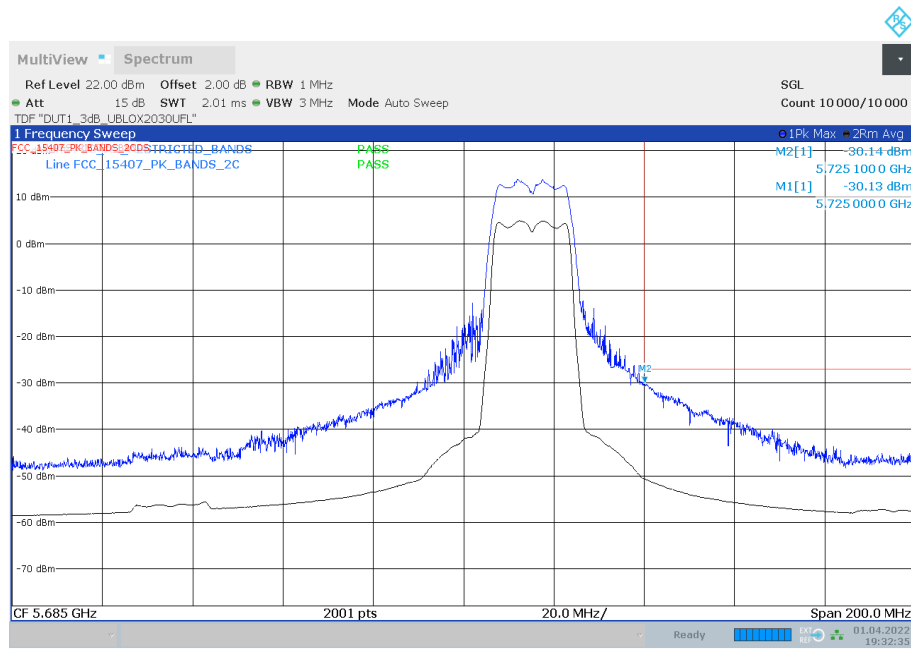

19:32:35 01.04.2022

Antenna A

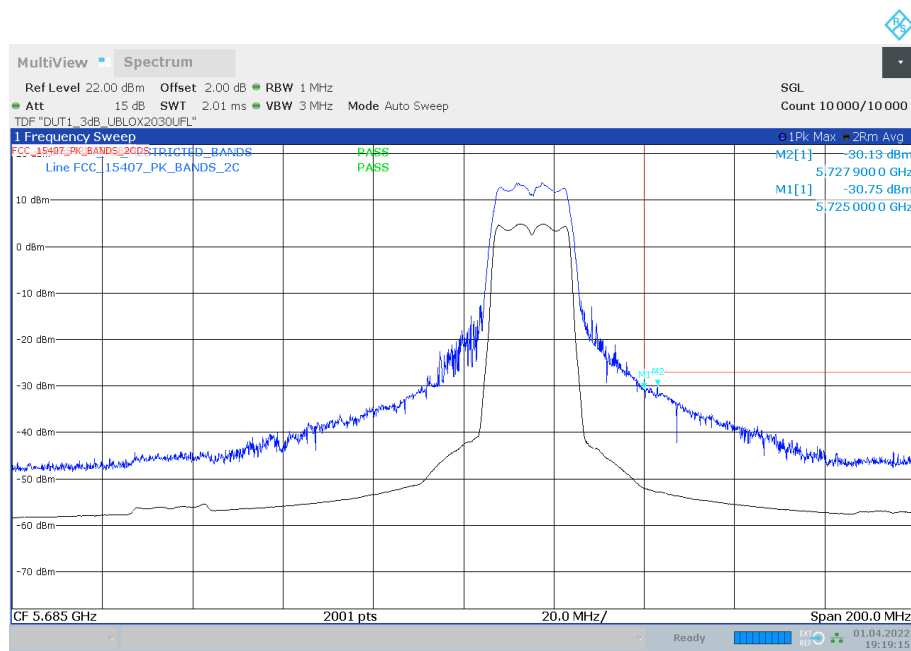

19:19:16 01.04.2022

Antenna B

Radio Technology = WLAN a, Operating Frequency = low, Subband = U-NII-1
(S02_377_AD01)

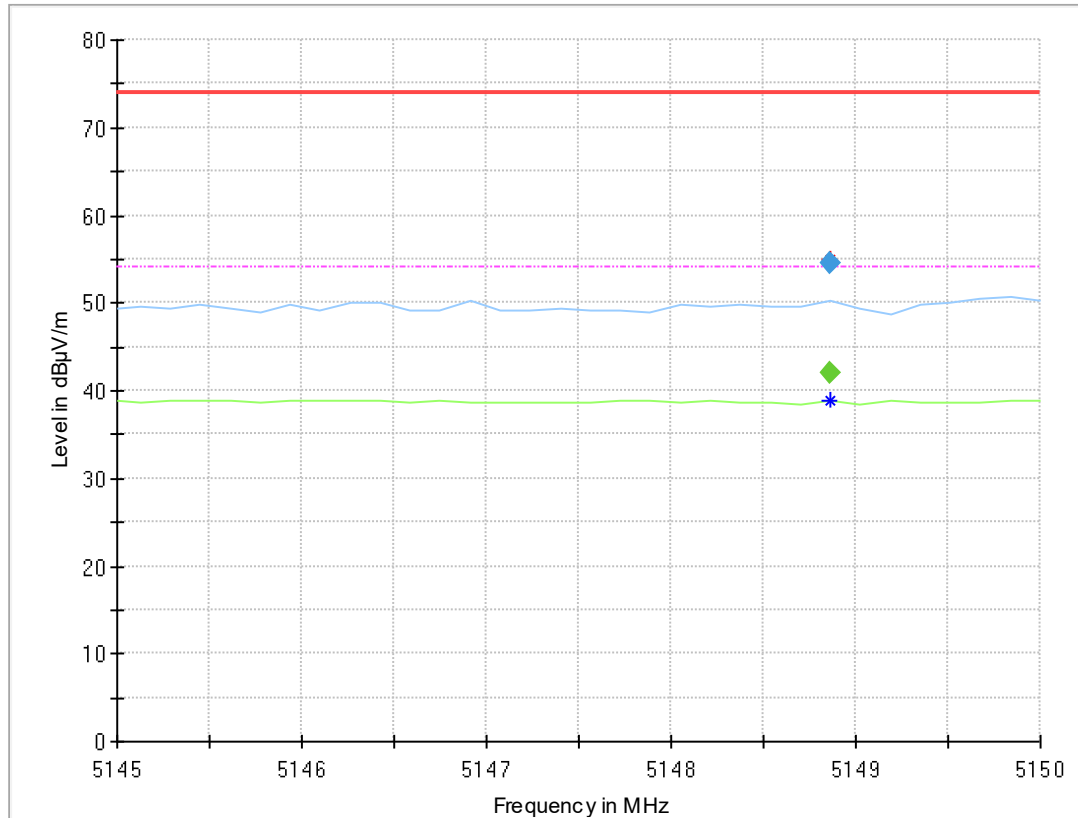

Final Result

Frequency (MHz)	MaxPeak (dBµV/m)	CAverage (dBµV/m)	Limit (dBµV/m)	Margin (dB)	Meas. Time (ms)	Bandwidth (kHz)	Height (cm)	Pol	Azimuth (deg)	Elevation (deg)	Corr. (dB/m)
5148.863	---	41.9	54.00	12.07	1000.0	1000.000	150.0	V	45.0	96.0	13.5
5148.863	54.5	---	74.00	19.45	1000.0	1000.000	150.0	V	45.0	96.0	13.5

Radio Technology = WLAN a, Operating Frequency = low, Subband = U-NII-1
(S01_377_AA01)

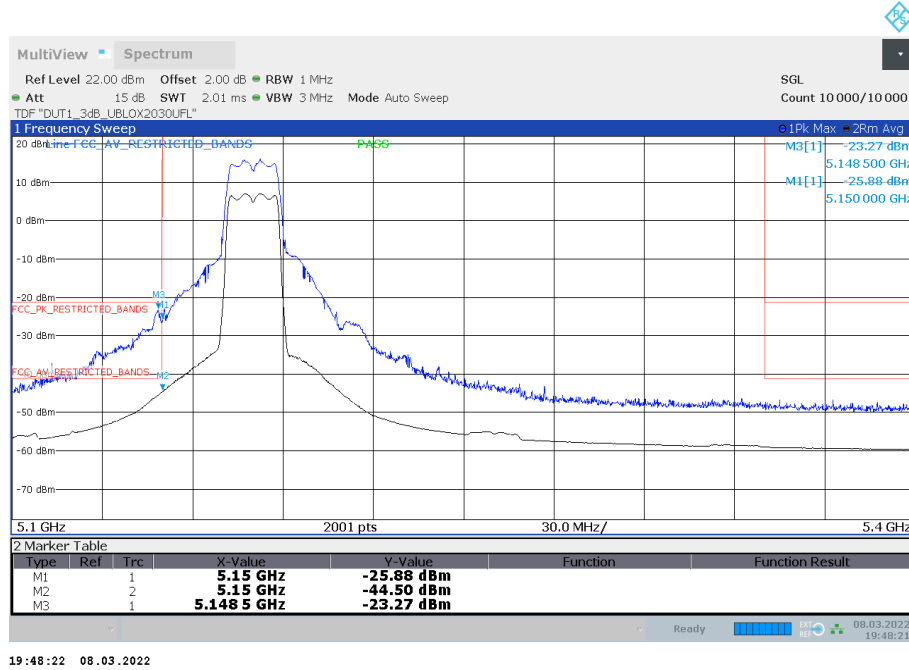

19:48:22 08.03.2022

Antenna A

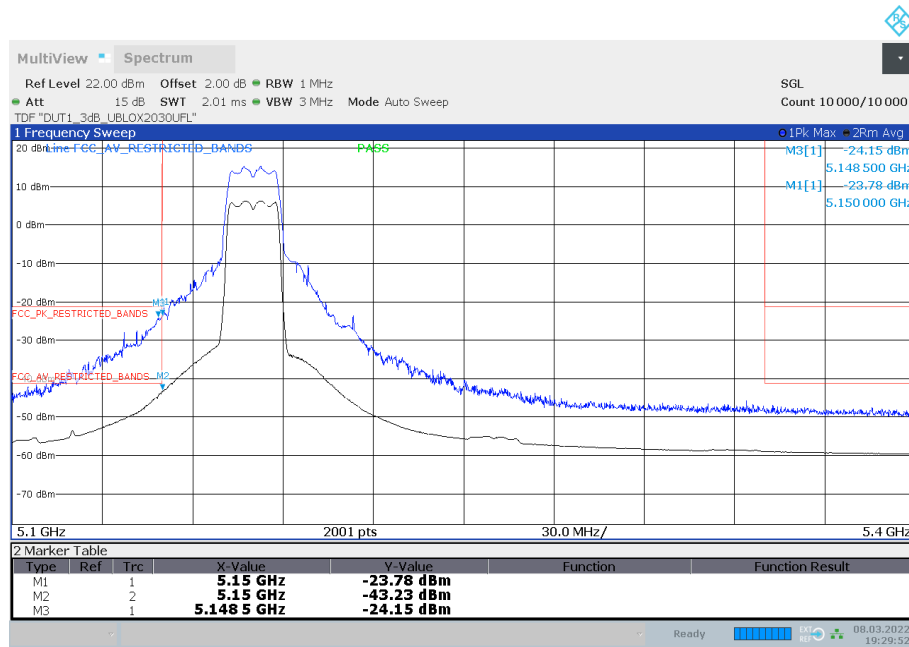

19:29:53 08.03.2022

Antenna B

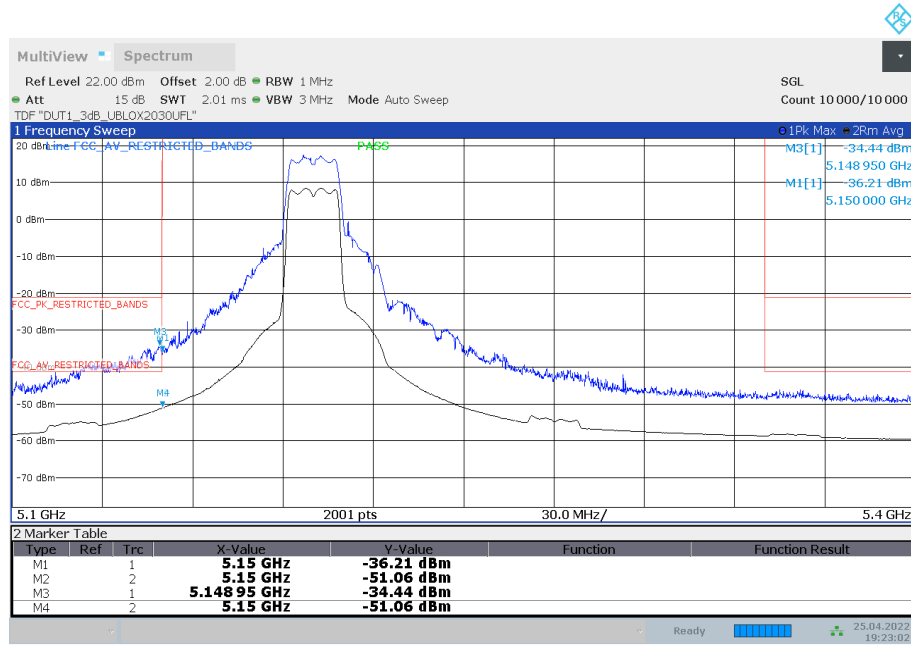

19:23:02 25.04.2022

Antenna A

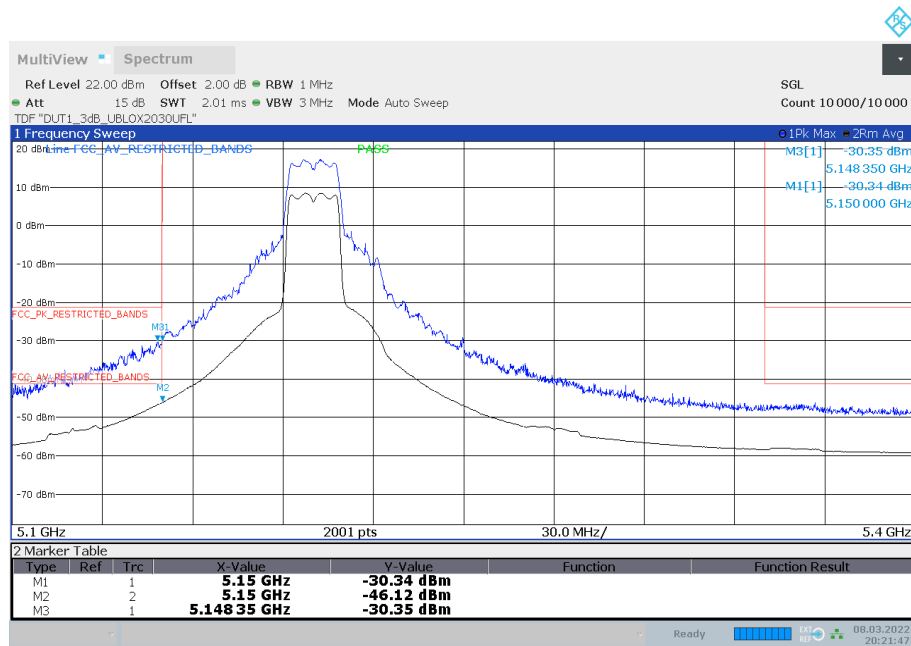

20:21:47 08.03.2022

Antenna B

Radio Technology = WLAN a, Operating Frequency = high, Subband = U-NII-2A (S01_377_AA01)

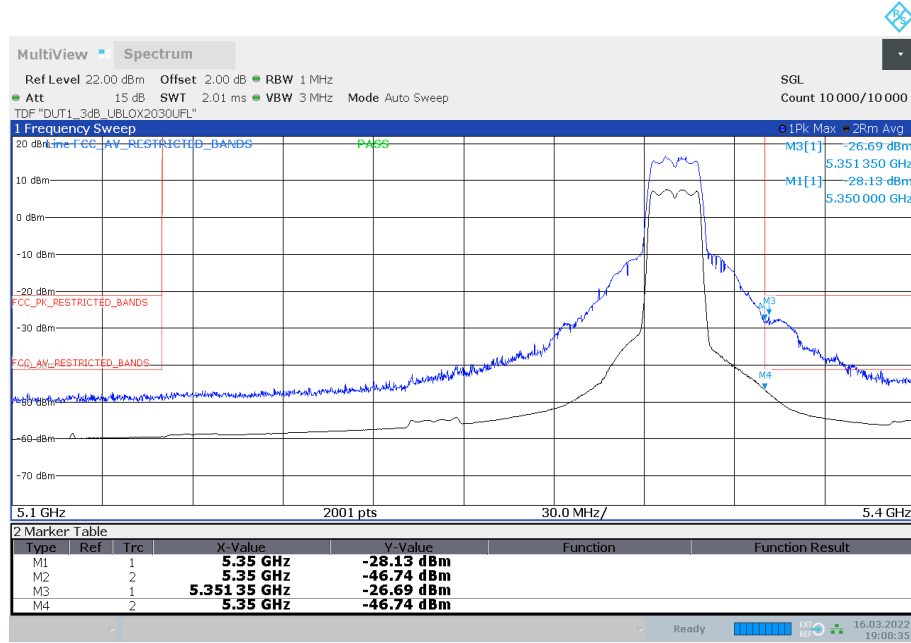

19:00:36 16.03.2022

Antenna A

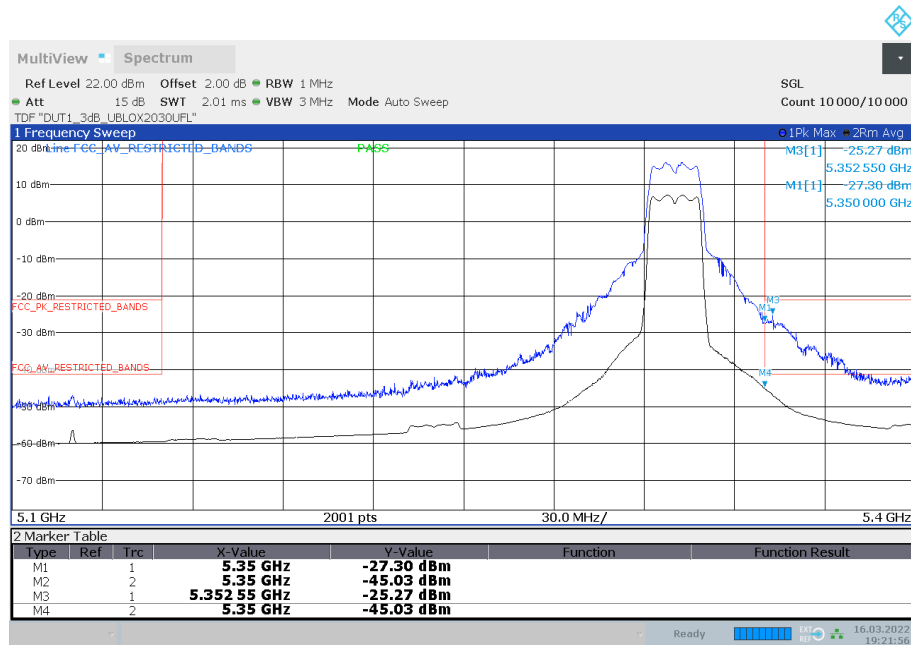

19:21:56 16.03.2022

Antenna B

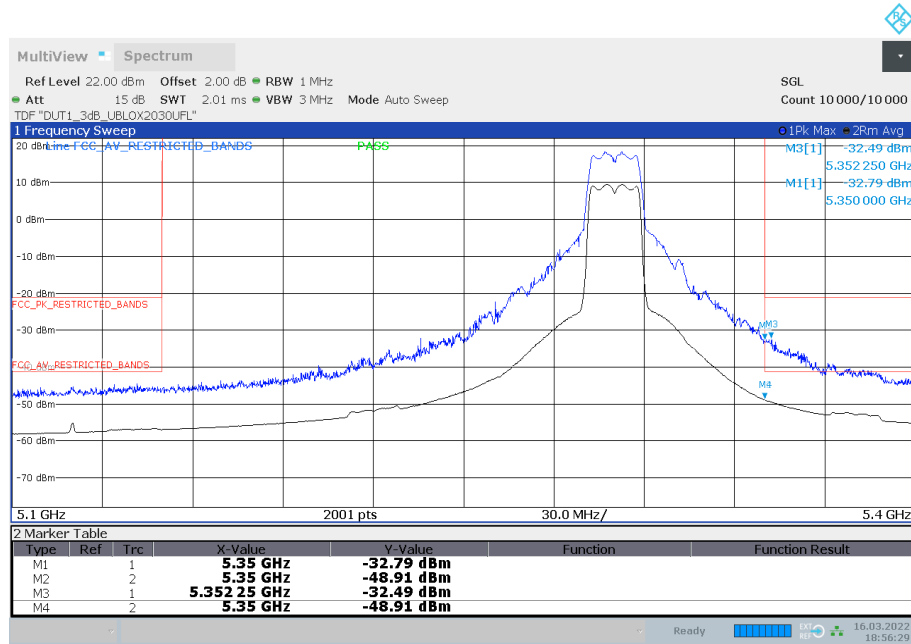

18:56:30 16.03.2022

Antenna A

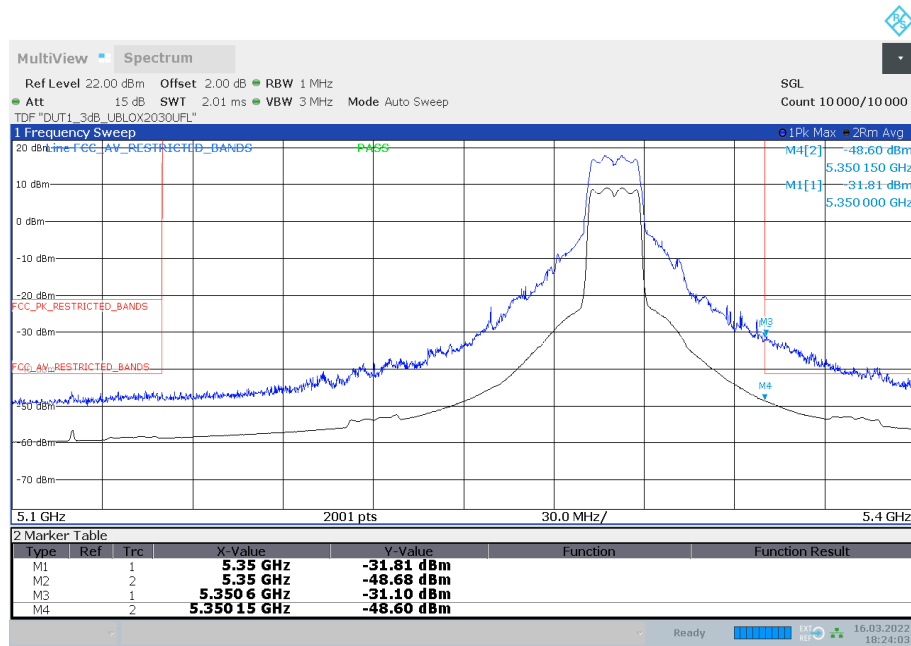

18:24:03 16.03.2022

Antenna B

Radio Technology = WLAN a, Operating Frequency = high, Subband = U-NII-2A
(S02_377_AD01)

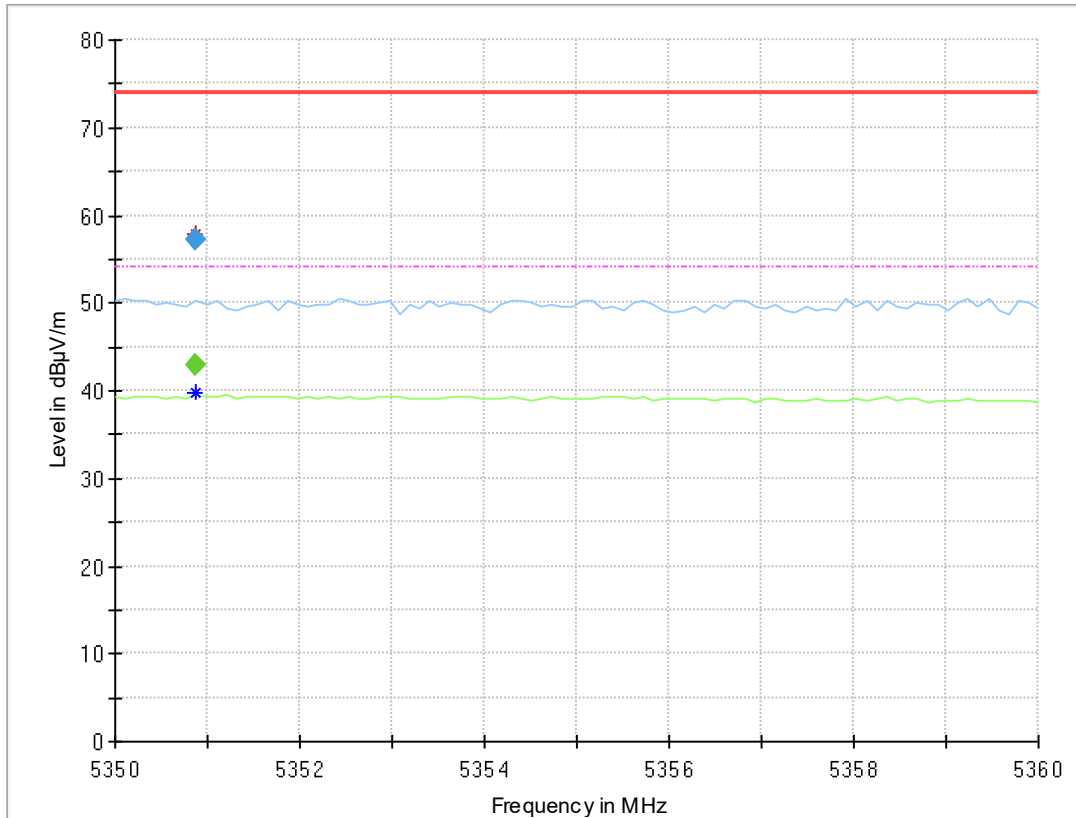

Final Result

Frequency (MHz)	MaxPeak (dBµV/m)	CAverage (dBµV/m)	Limit (dBµV/m)	Marg in (dB)	Meas. Time (ms)	Bandwidth (kHz)	Height (cm)	Pol	Azimuth (deg)	Elevation (deg)	Cor. (dB/m)
5350.880	57.2	---	74.0	16.78	1000.0	1000.00	150.	H	2.0	92.0	14.1
5350.880	---	42.9	54.0	11.13	1000.0	1000.00	150.	H	2.0	92.0	14.1

Radio Technology = WLAN a, Operating Frequency = low, Subband = U-NII-2C
(S02_377_AD01)

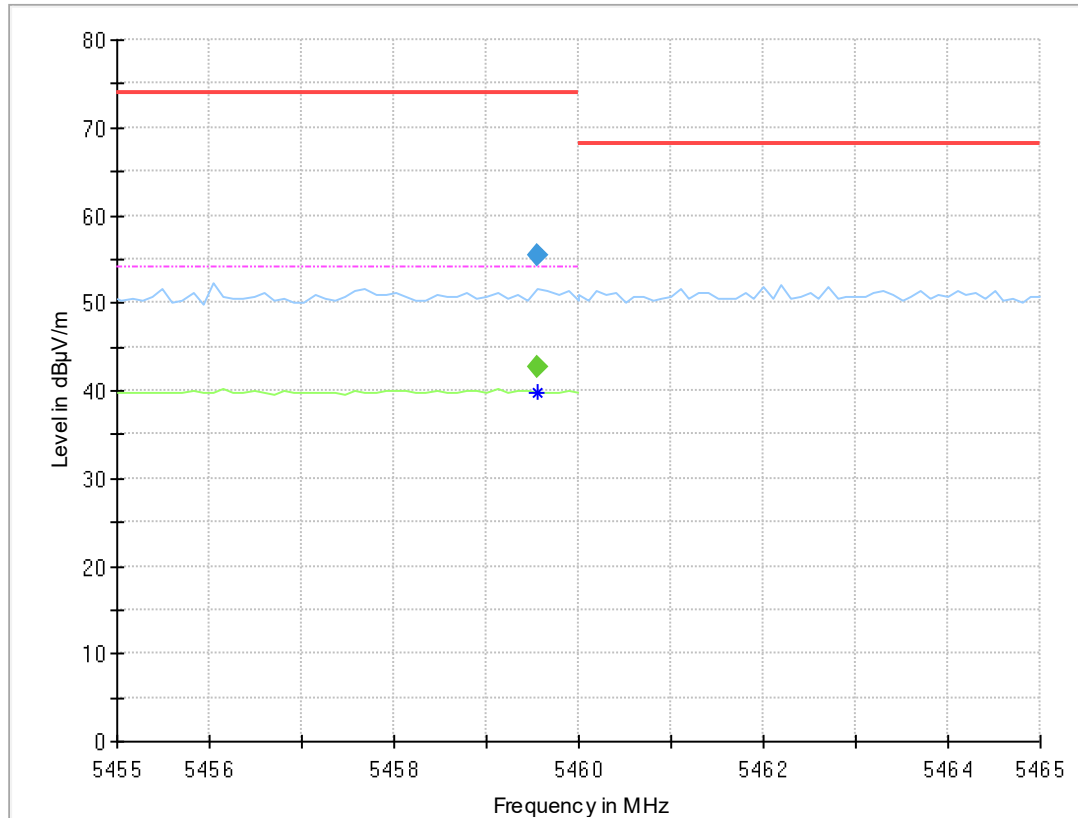

Final Result

Frequency (MHz)	MaxPeak (dBµV/m)	CAverage (dBµV/m)	Limit (dBµV/m)	Margin (dB)	Meas. Time (ms)	Bandwidth (kHz)	Height (cm)	Pol	Azimuth (deg)	Elevation (deg)	Corr. (dB/m)
5459.560	---	42.6	54.00	11.38	1000.0	1000.000	150.0	V	-85.0	105.0	14.5
5459.560	55.3	---	74.00	18.66	1000.0	1000.000	150.0	V	-85.0	105.0	14.5

Radio Technology = WLAN a, Operating Frequency = high, Subband = U-NII-2C
(S02_377_AD01)

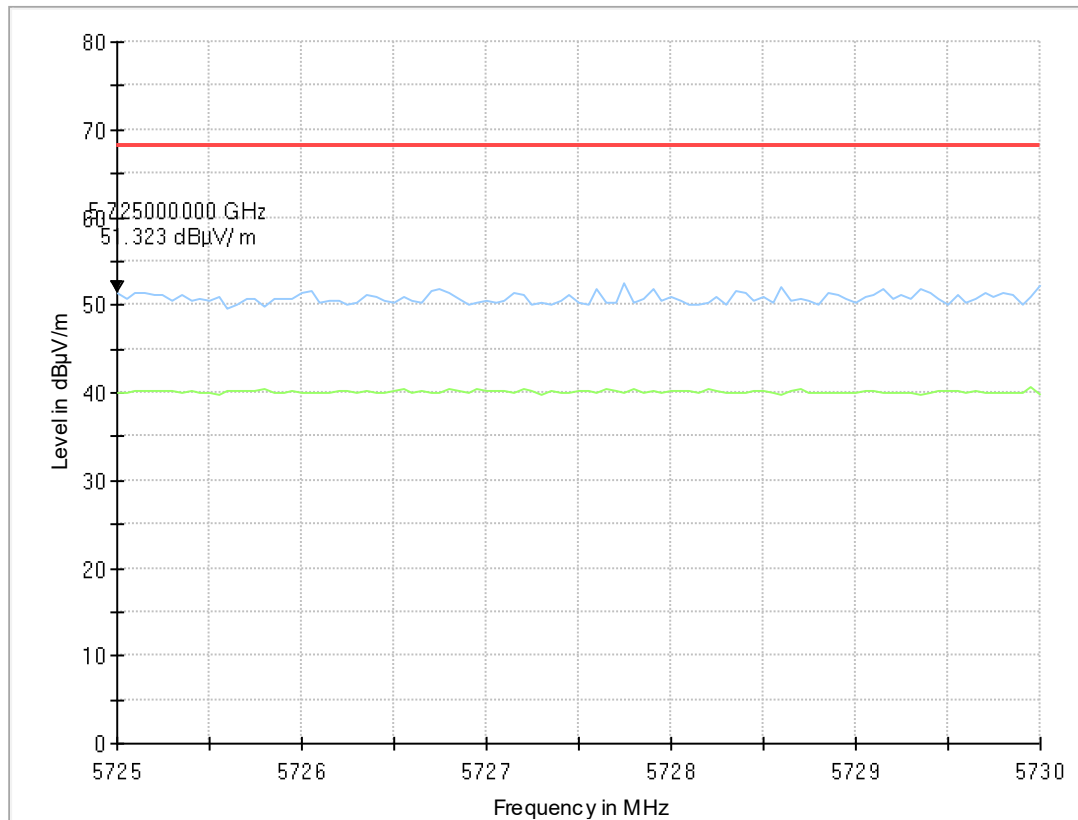

Radio Technology = WLAN a, Operating Frequency = low, Subband = U-NII-3
(S02_377_AD01)

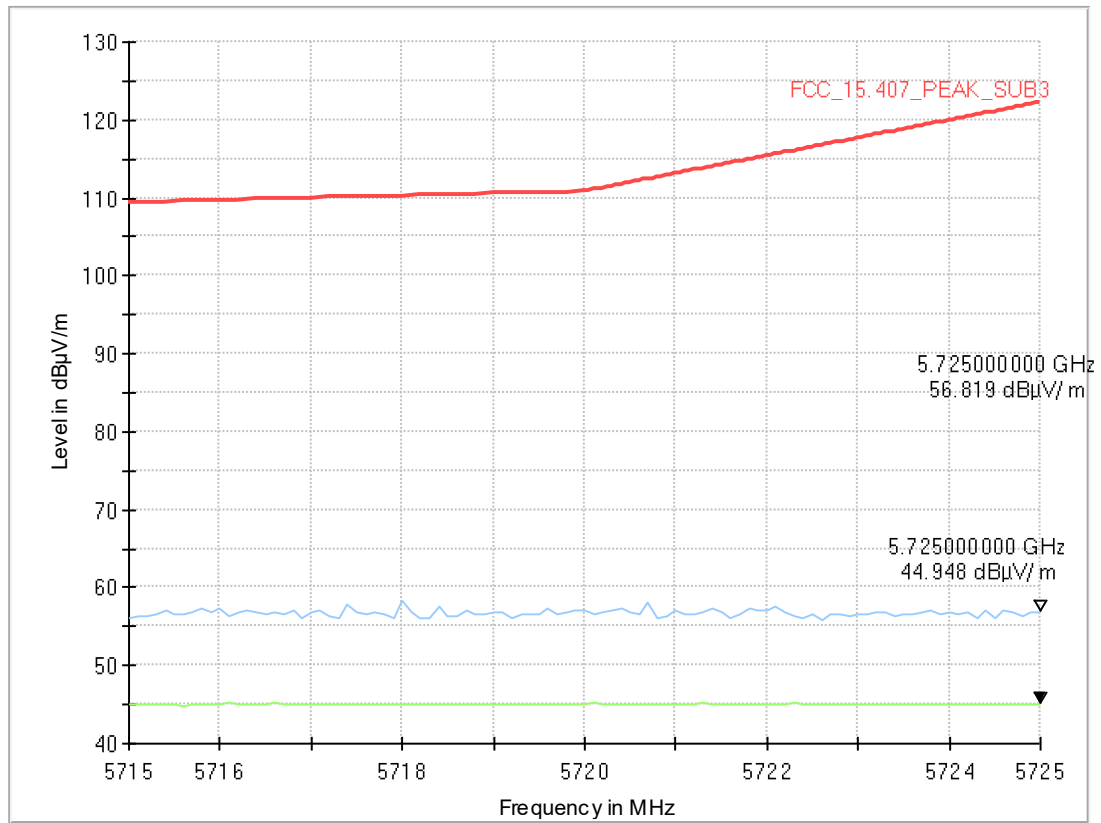

Radio Technology = WLAN a, Operating Frequency = high, Subband = U-NII-3
(S02_377_AD01)

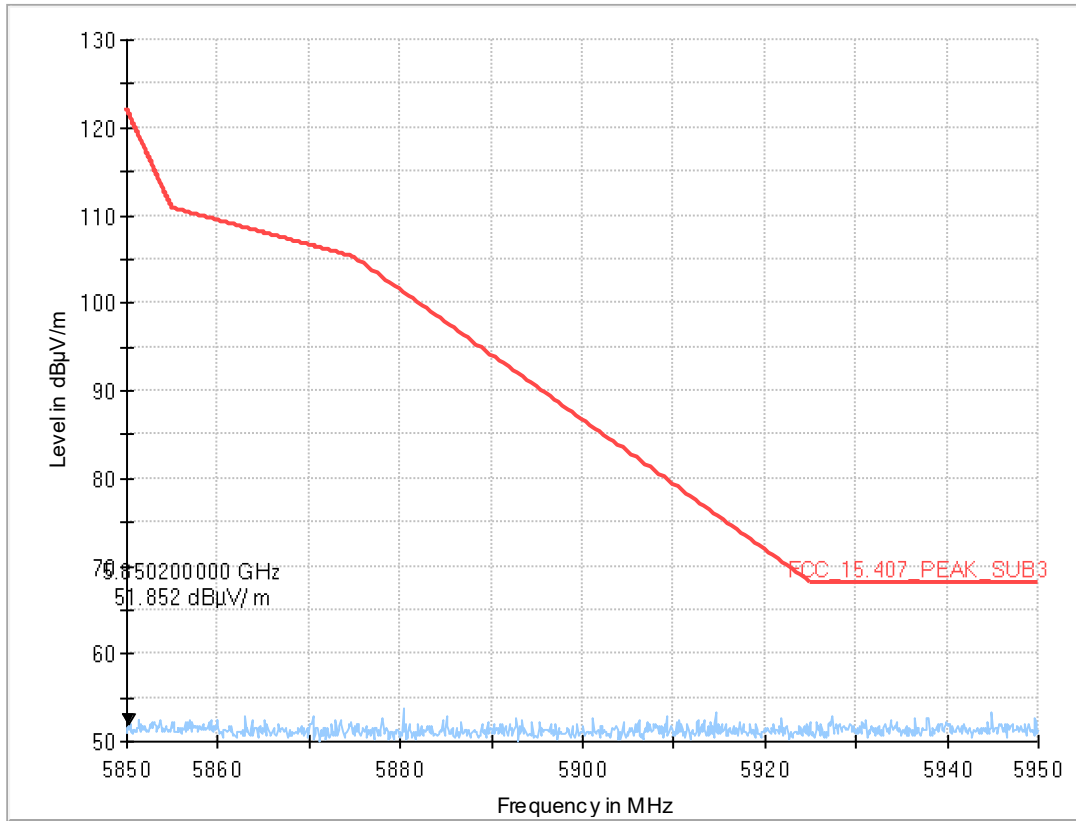

Radio Technology = WLAN ax 20 MHz, Operating Frequency = low, Subband = U-NII-1 (S01_377_AA01)

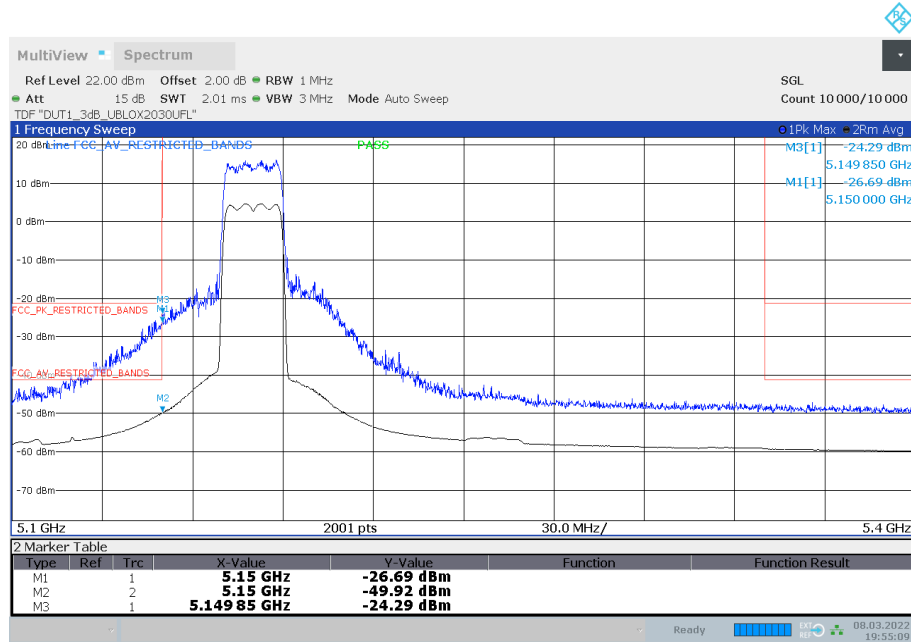

19:55:10 08.03.2022

Antenna A

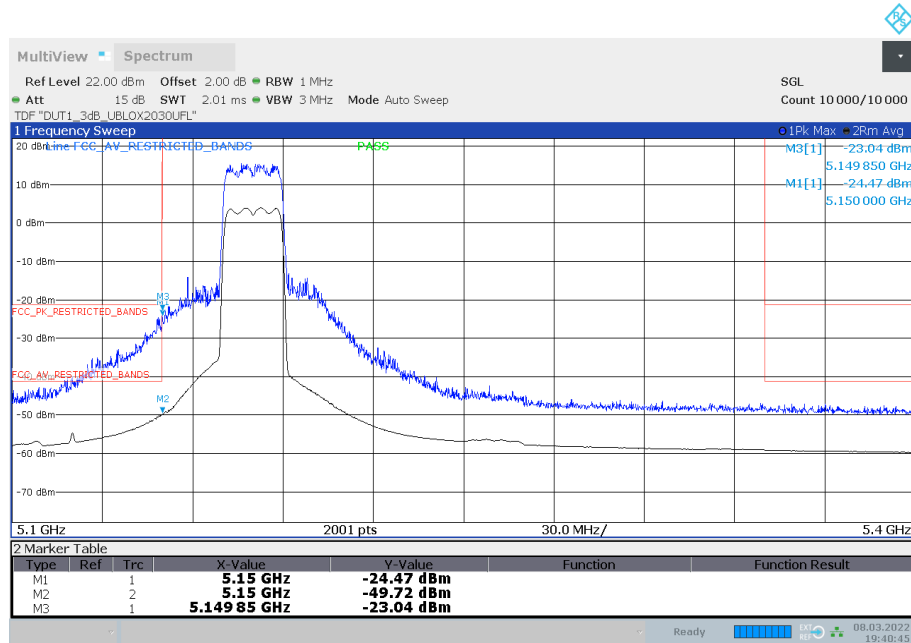

19:40:45 08.03.2022

Antenna B

Radio Technology = WLAN ax 20 MHz, Operating Frequency = high, Subband = U-NII-2A (S01_377_AA01)

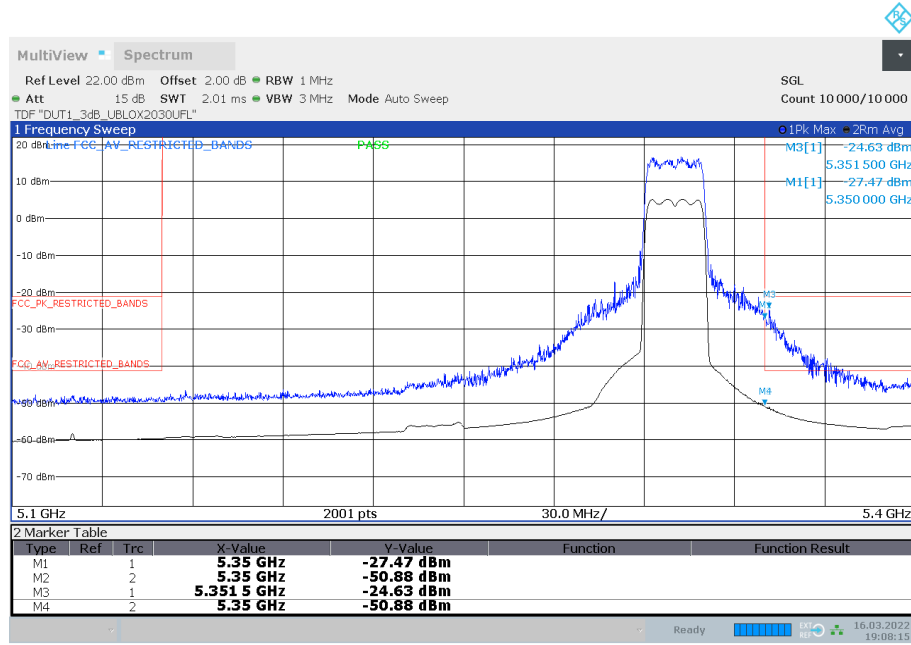

19:08:16 16.03.2022

Antenna A

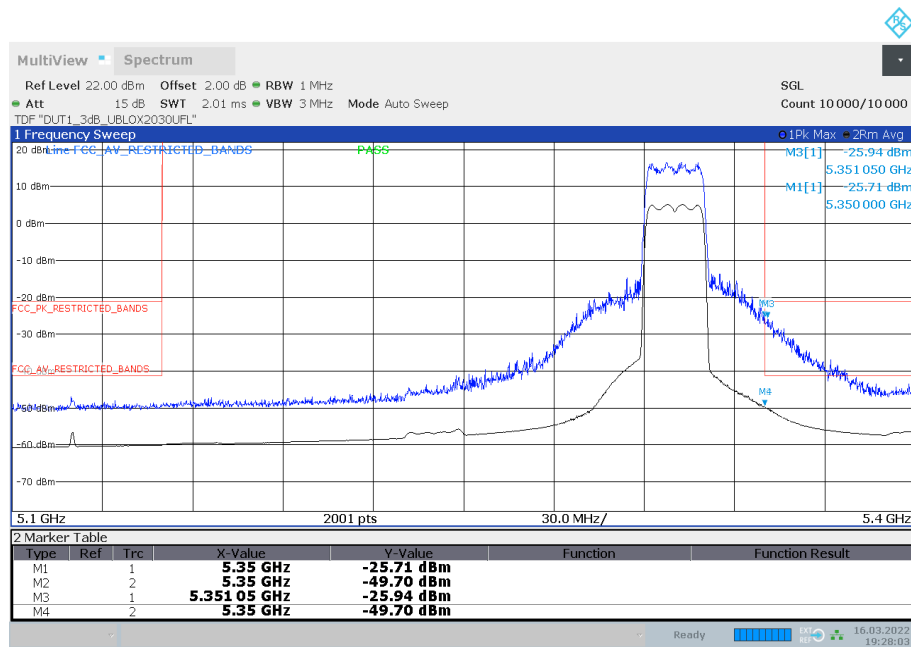

19:28:04 16.03.2022

Antenna B

Radio Technology = WLAN ax 20 MHz, Operating Frequency = low, Subband = U-NII-2C (S01_377_AA01)

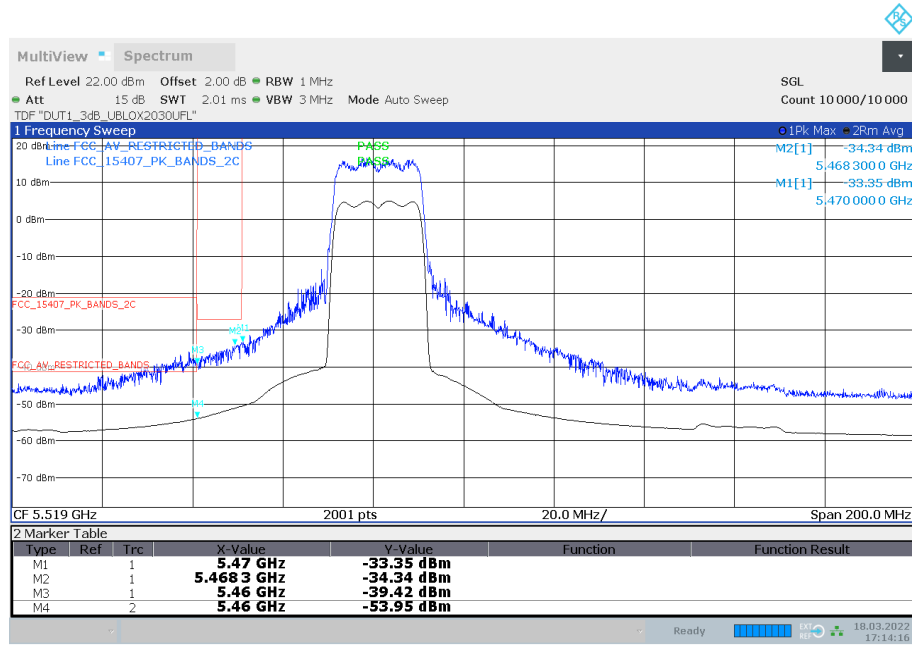

17:14:16 18.03.2022

Antenna A

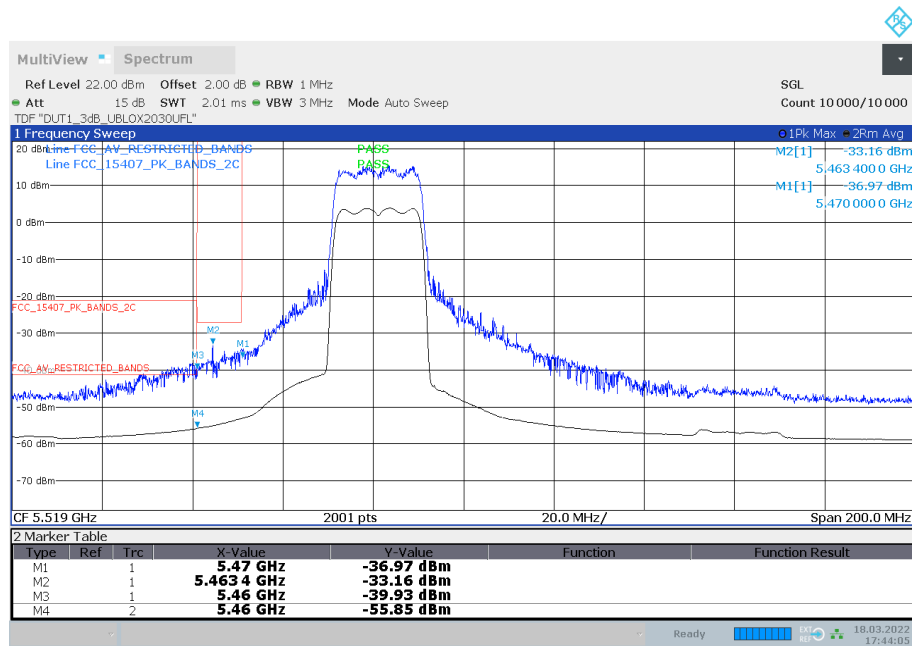

17:44:06 18.03.2022

Antenna B

Radio Technology = WLAN ax 20 MHz, Operating Frequency = high, Subband = U-NII-2C (S01_377_AA01)

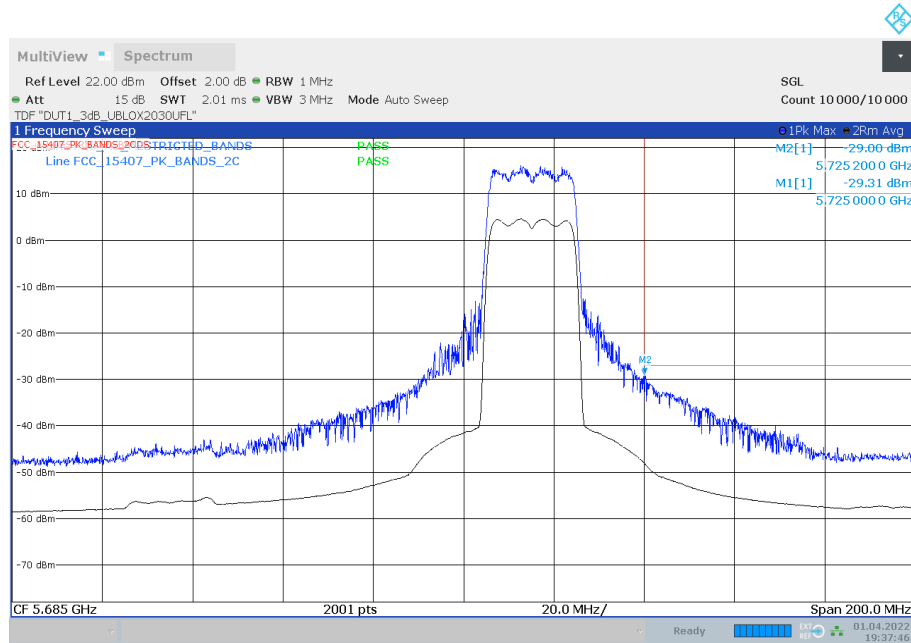

19:37:47 01.04.2022

Antenna A

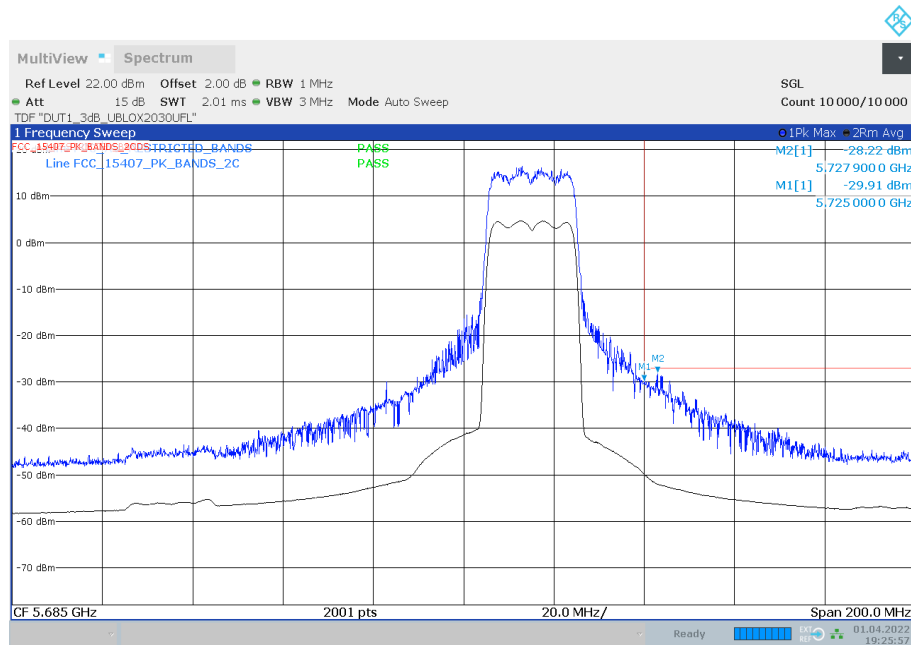

19:25:57 01.04.2022

Antenna B

Radio Technology = WLAN ax 40 MHz, Operating Frequency = low, Subband = U-NII-1 (S01_377_AA01)

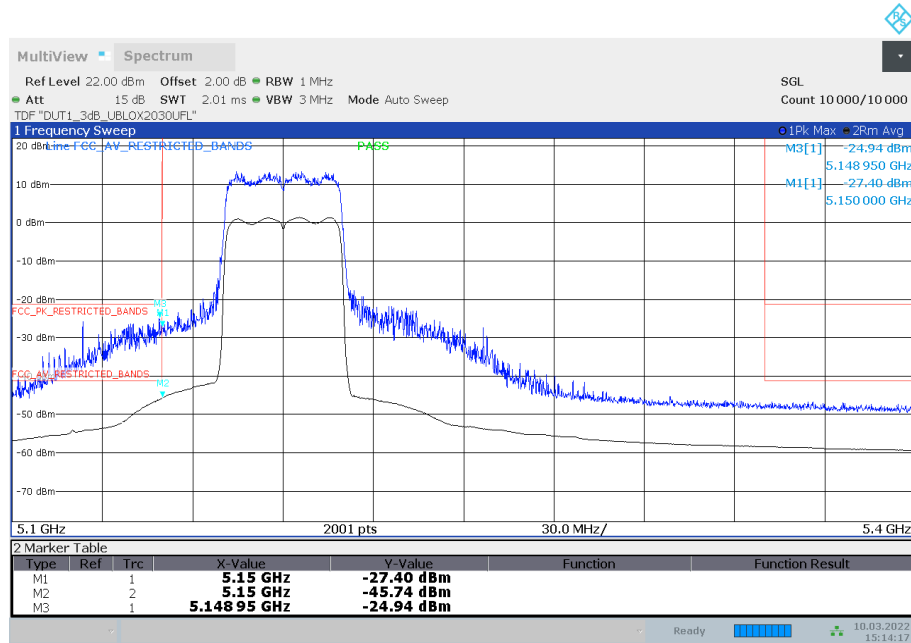

15:14:17 10.03.2022

Antenna A

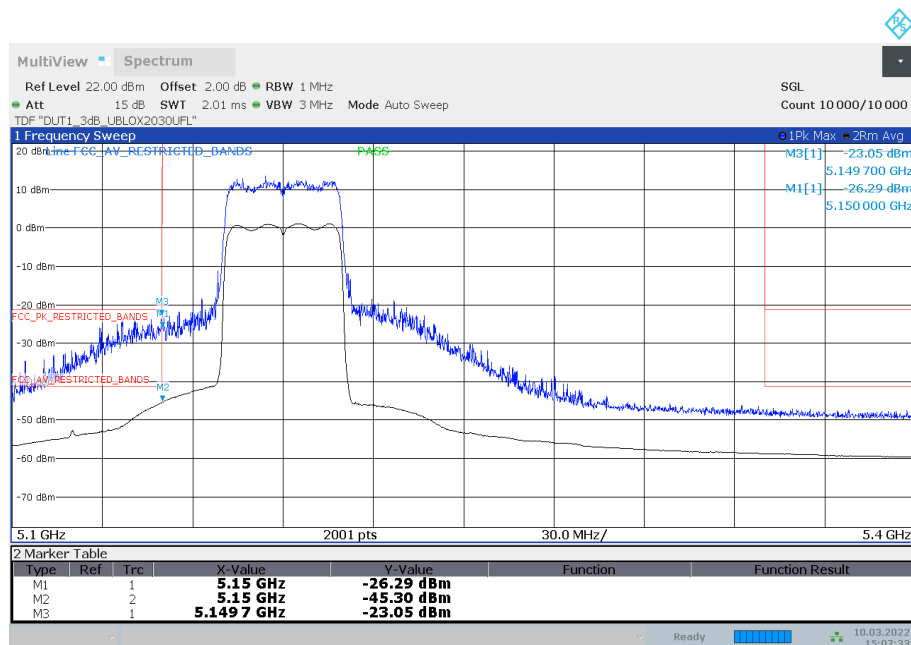

15:07:33 10.03.2022

Antenna B

Radio Technology = WLAN ax 40 MHz, Operating Frequency = high, Subband = U-NII-2A (S01_377_AA01)

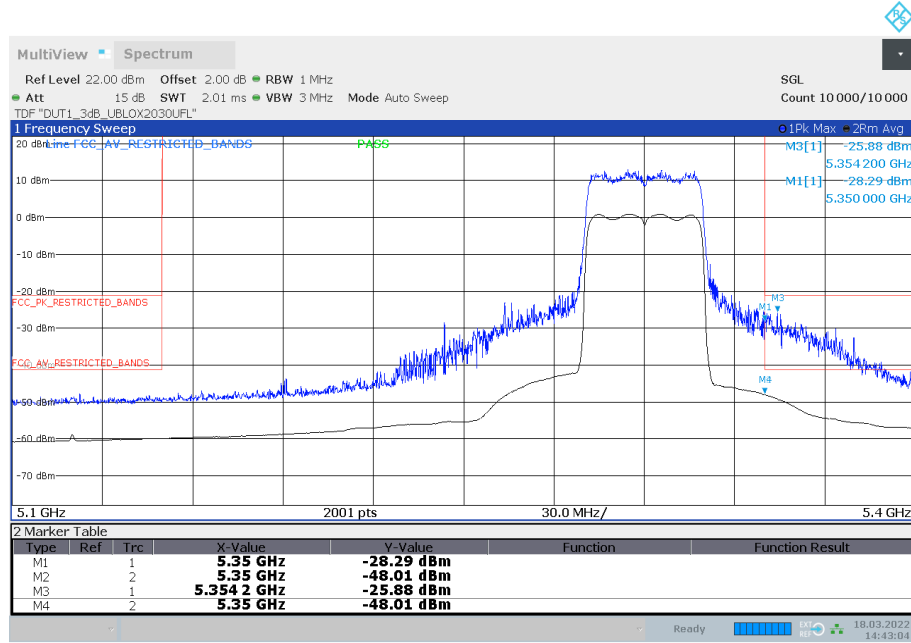

14:43:04 18.03.2022

Antenna A

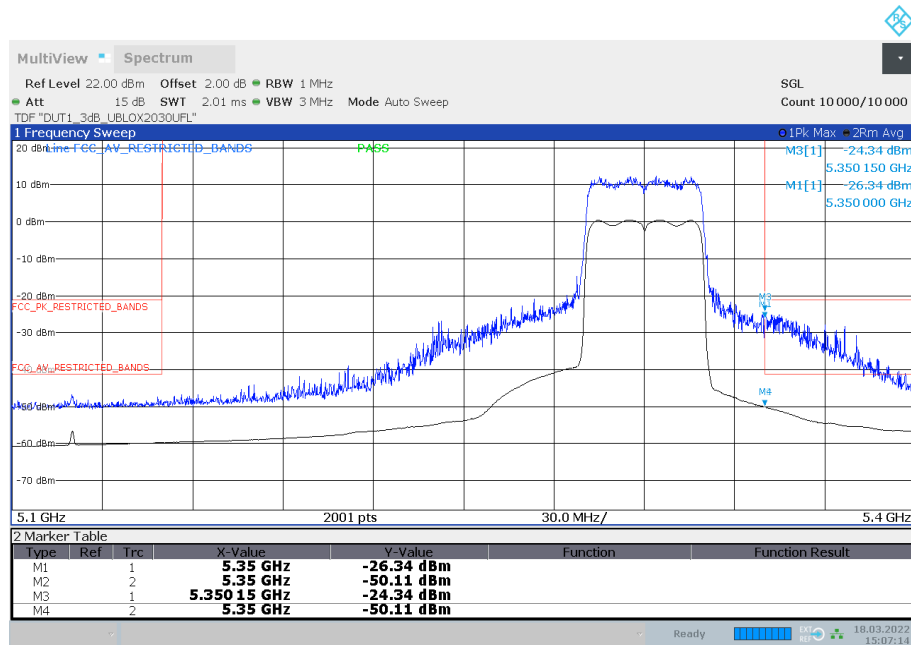

15:07:15 18.03.2022

Antenna B

Radio Technology = WLAN ax 40 MHz, Operating Frequency = low, Subband = U-NII-2C (S01_377_AA01)

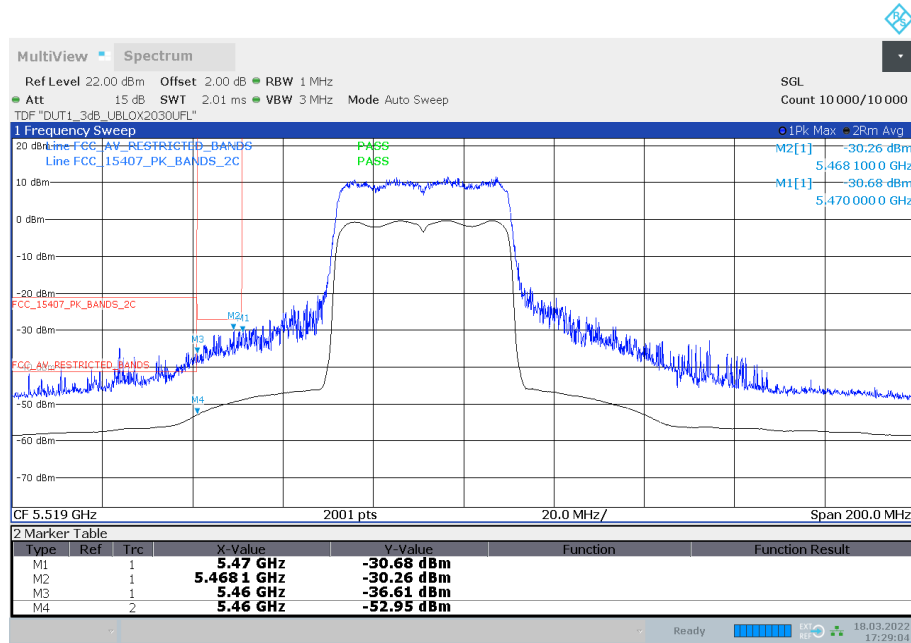

17:29:05 18.03.2022

Antenna A

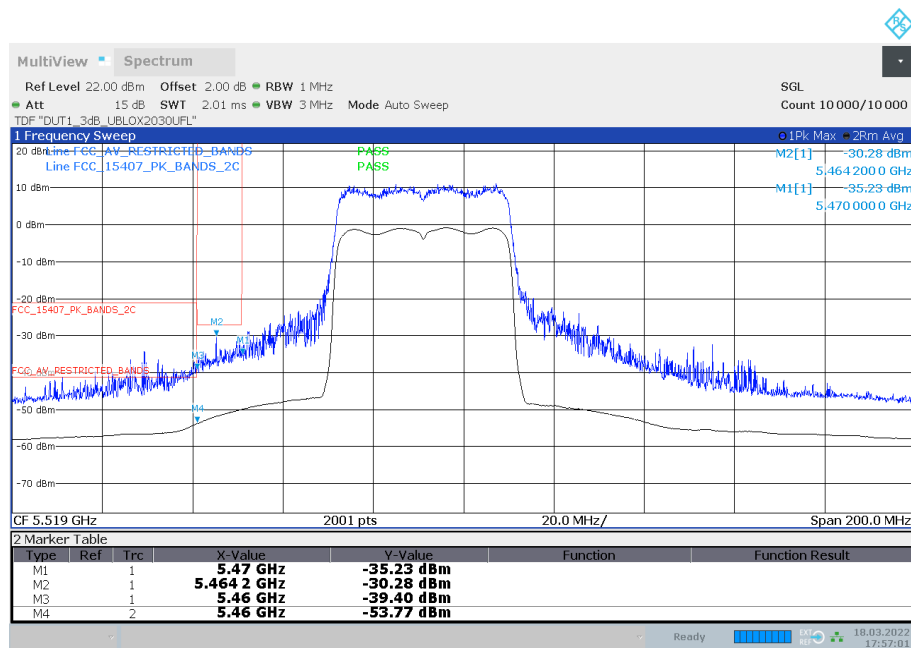

17:57:02 18.03.2022

Antenna B

Radio Technology = WLAN n 20 MHz, Operating Frequency = low, Subband = U-NII-1 (S01_377_AA01)

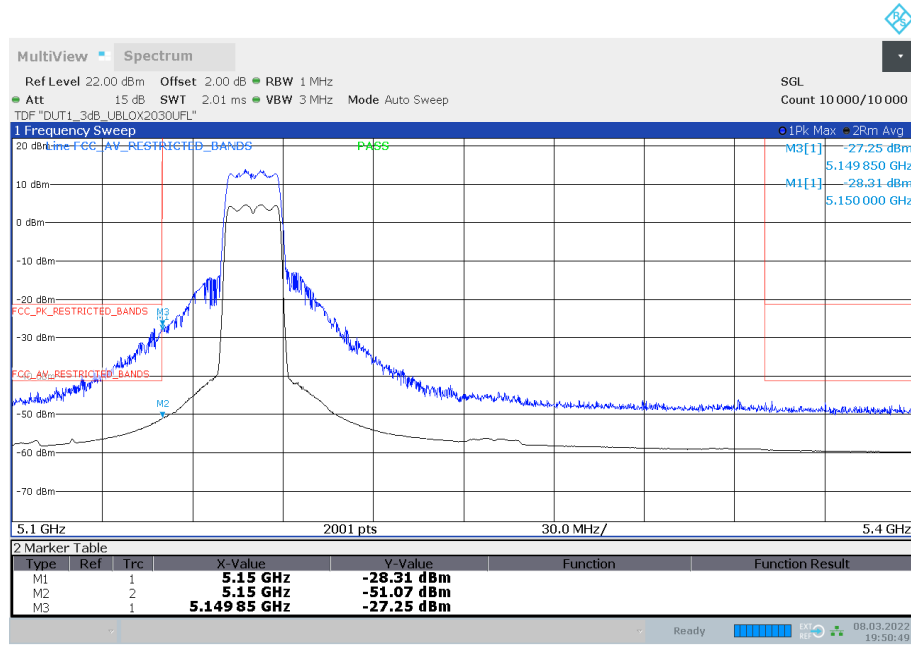

19:50:49 08.03.2022

Antenna A

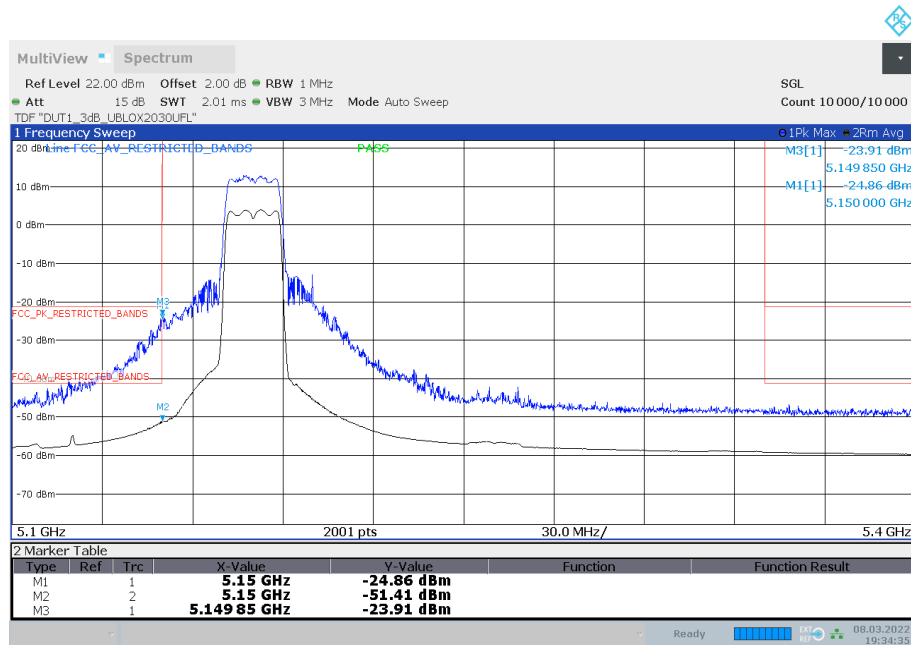

19:34:36 08.03.2022

Antenna B

Radio Technology = WLAN n 20 MHz, Operating Frequency = high, Subband = U-NII-2A (S01_377_AA01)

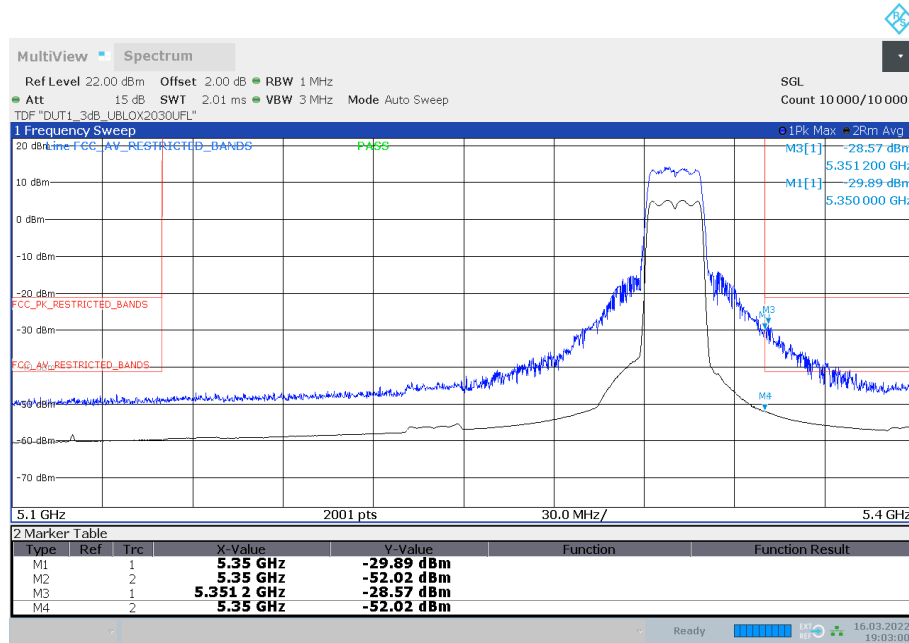

19:03:01 16.03.2022

Antenna A

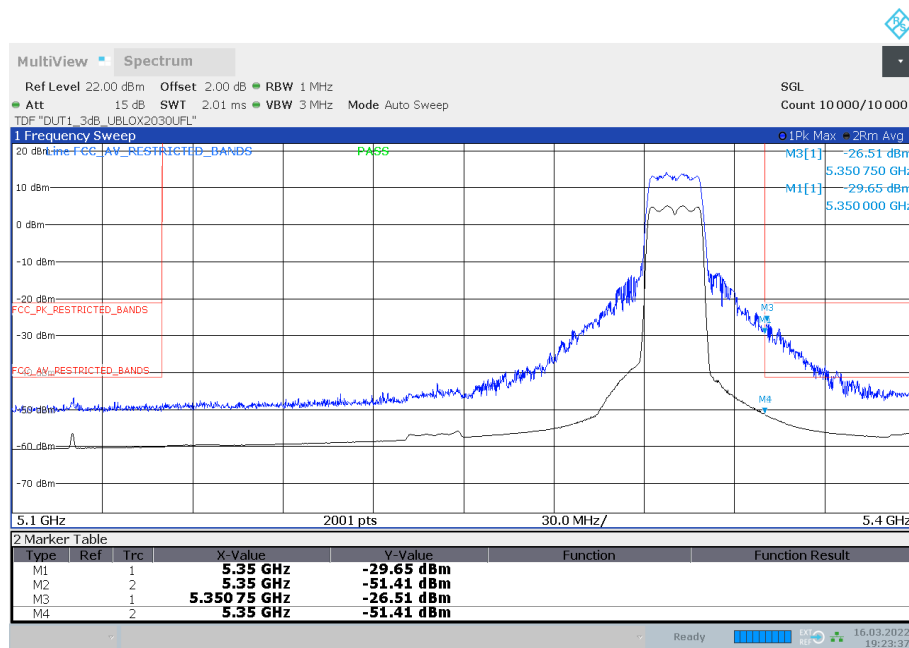

19:23:38 16.03.2022

Antenna B

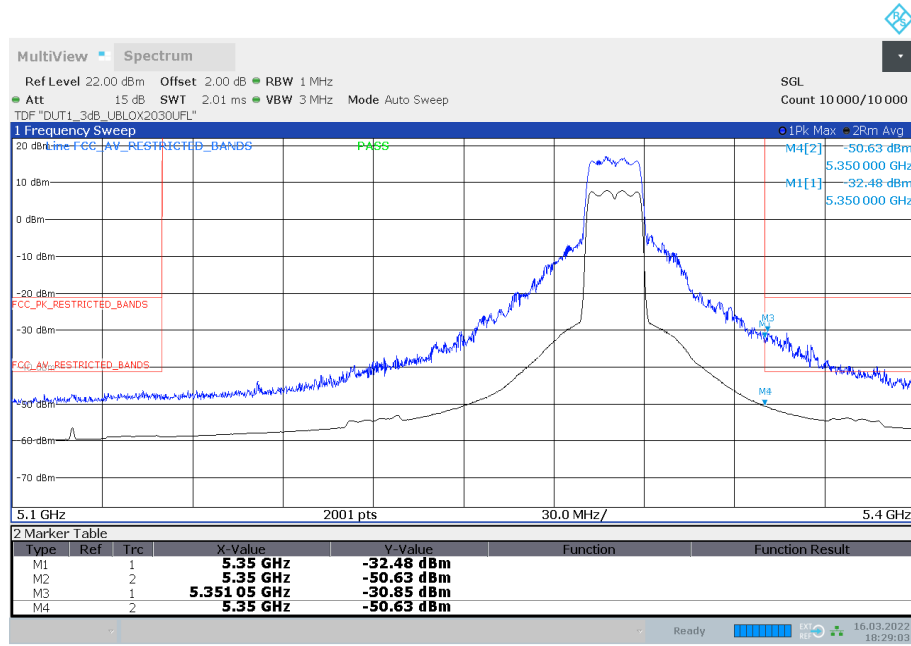

18:29:03 16.03.2022

Antenna B

Radio Technology = WLAN n 20 MHz, Operating Frequency = low, Subband = U-NII-2C (S01_377_AA01)

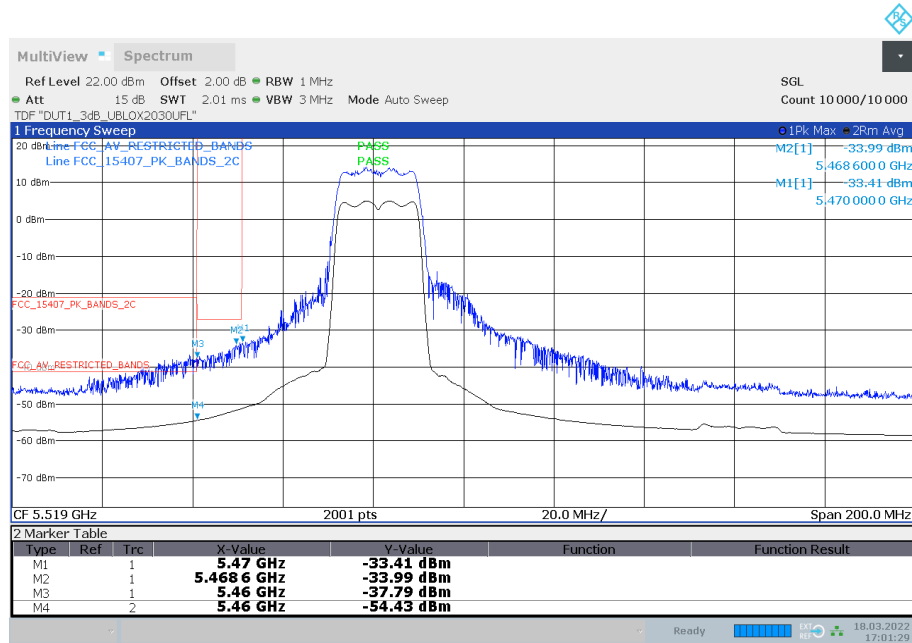

Antenna A

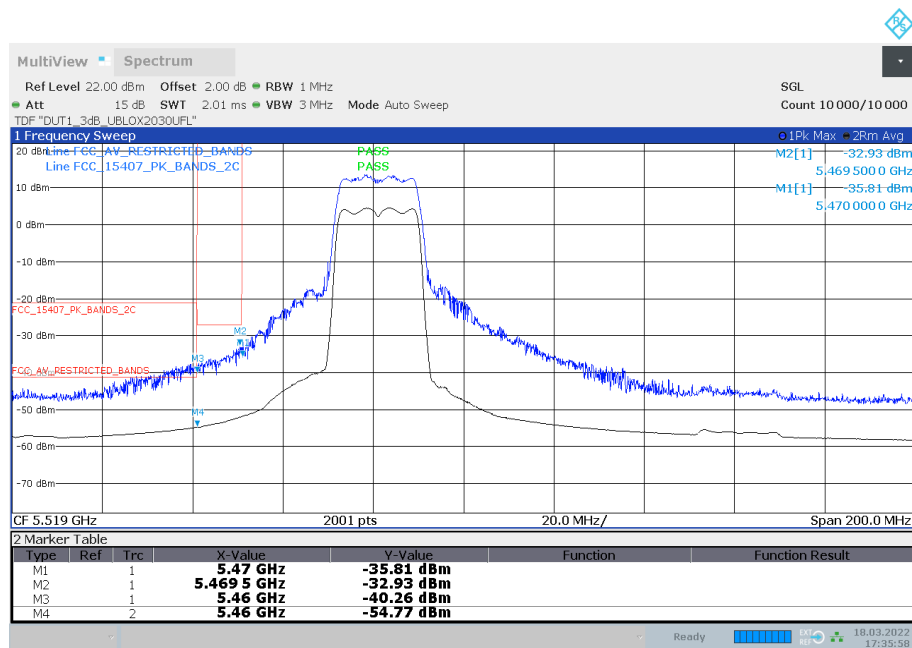

Antenna B

Radio Technology = WLAN n 20 MHz, Operating Frequency = high, Subband = U-NII-2C (S01_377_AA01)

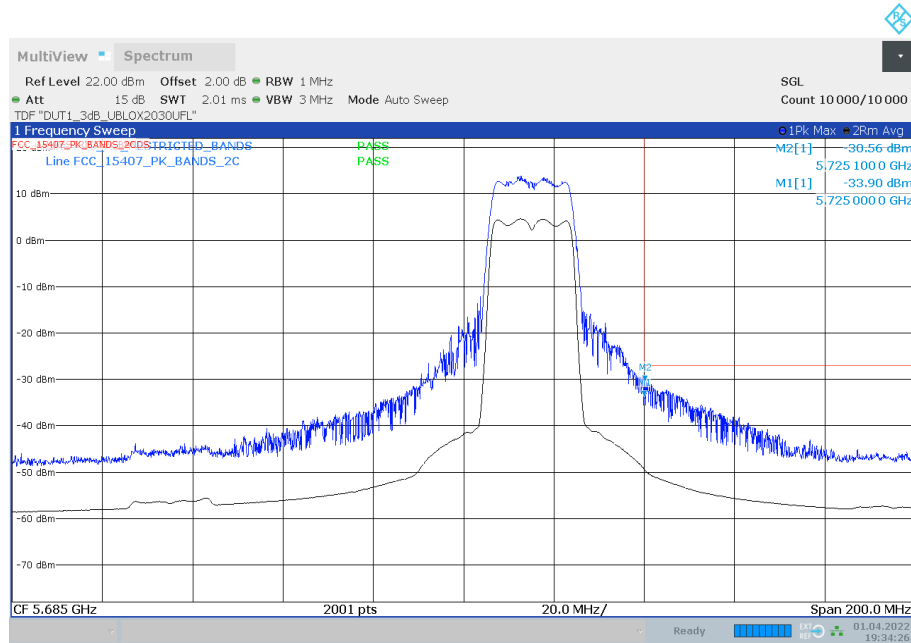

19:34:26 01.04.2022

Antenna A

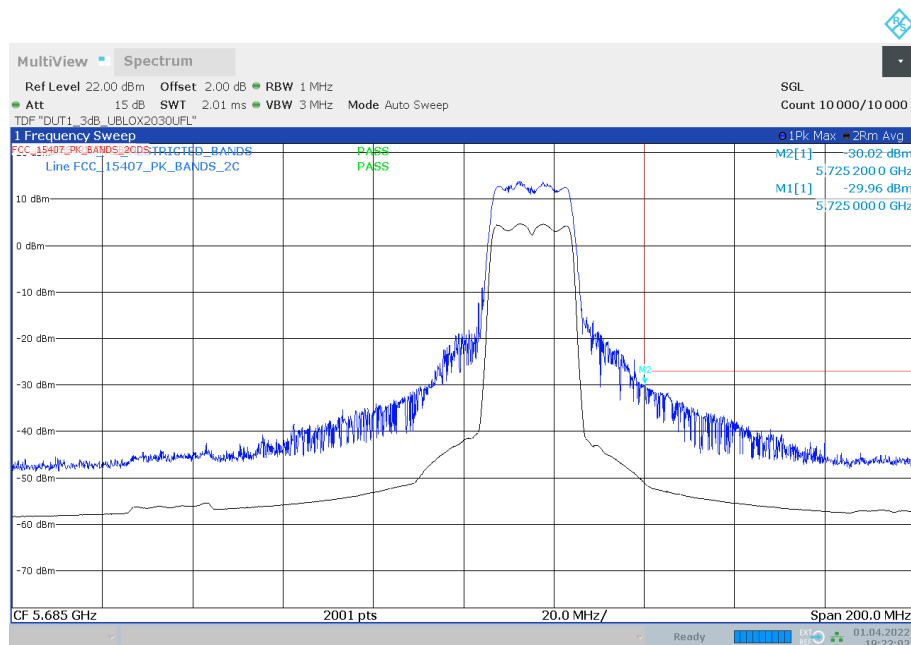

19:22:02 01.04.2022

Antenna B

Radio Technology = WLAN ax 80 MHz, Operating Frequency = mid, Subband = U-NII-1 (S01_377_AA01)

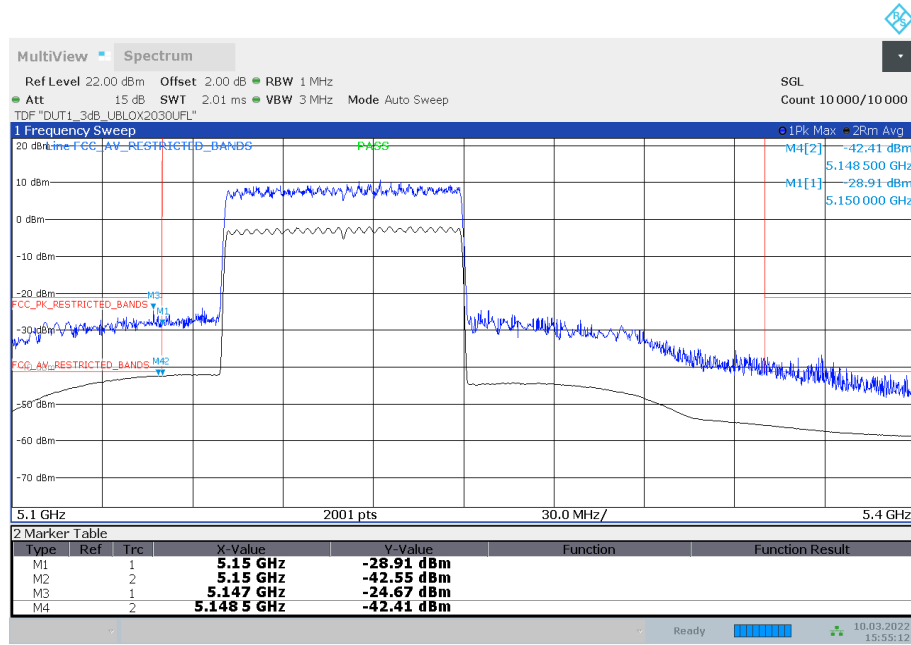

15:55:13 10.03.2022

Antenna A

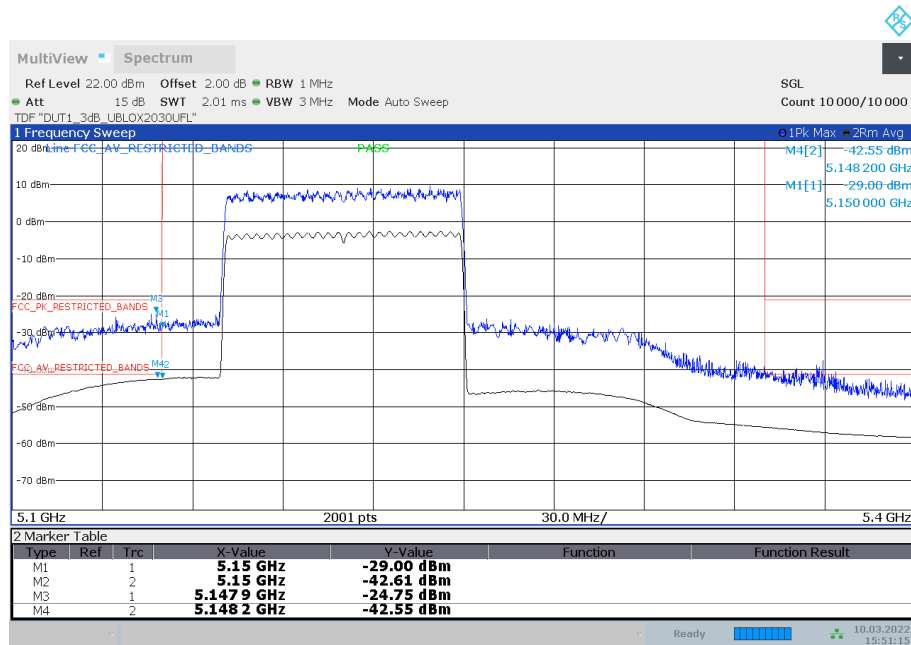

15:51:16 10.03.2022

Antenna B

Radio Technology = WLAN ax 80 MHz, Operating Frequency = mid, Subband = U-NII-2A (S01_377_AA01)

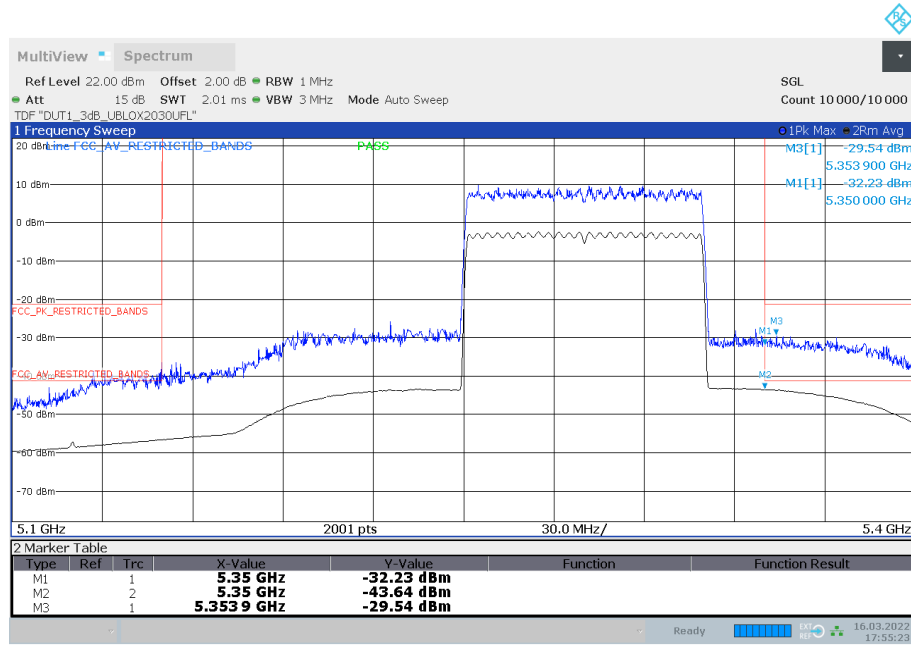

17:55:23 16.03.2022

Antenna A

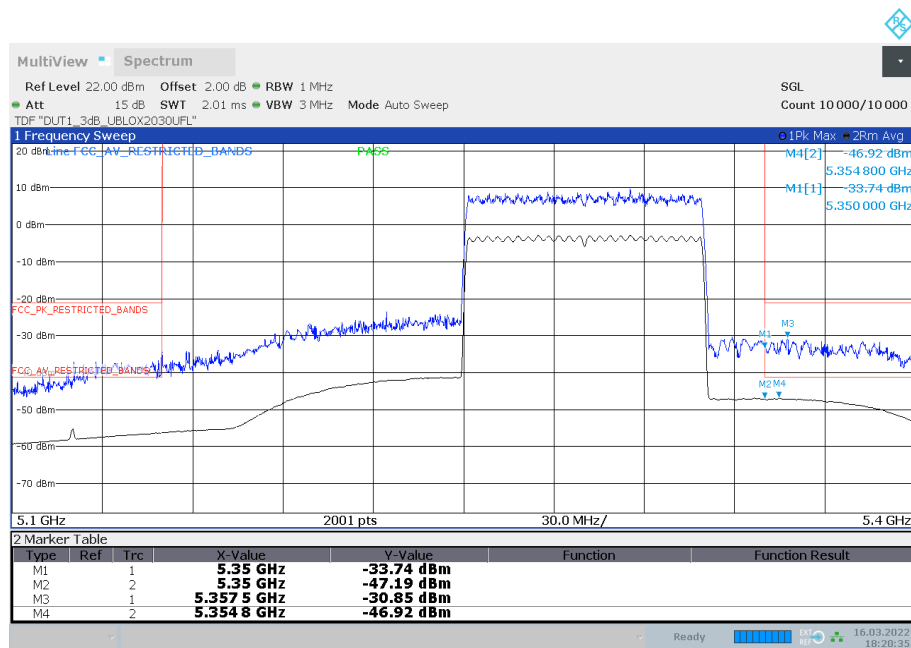

18:20:35 16.03.2022

Antenna B

Radio Technology = WLAN ax 80 MHz, Operating Frequency = low, Subband = U-NII-2C (S01_377_AA01)

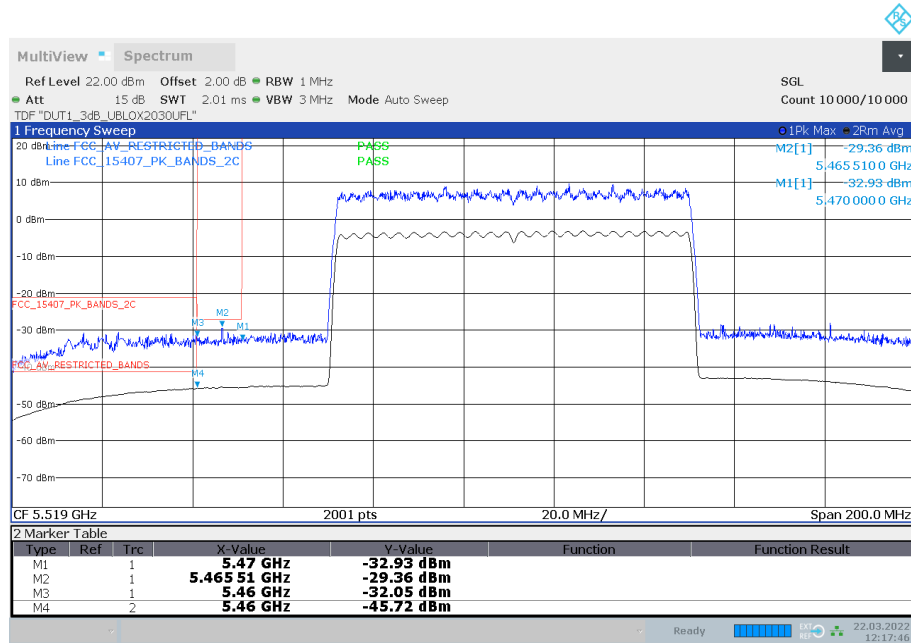

12:17:46 22.03.2022

Antenna A

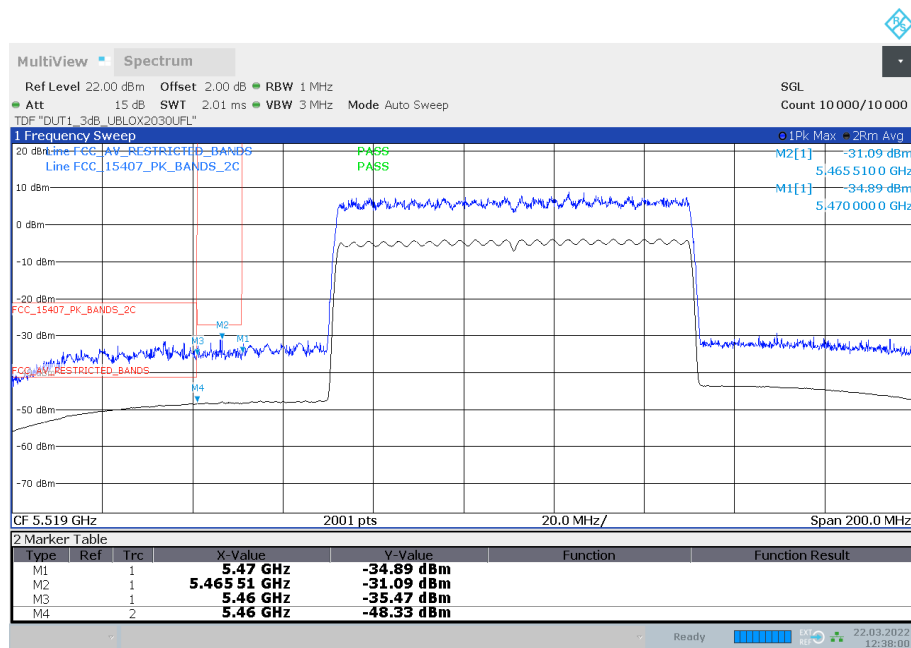

12:38:00 22.03.2022

Antenna B

Radio Technology = WLAN n 40 MHz, Operating Frequency = low, Subband = U-NII-1 (S01_377_AA01)

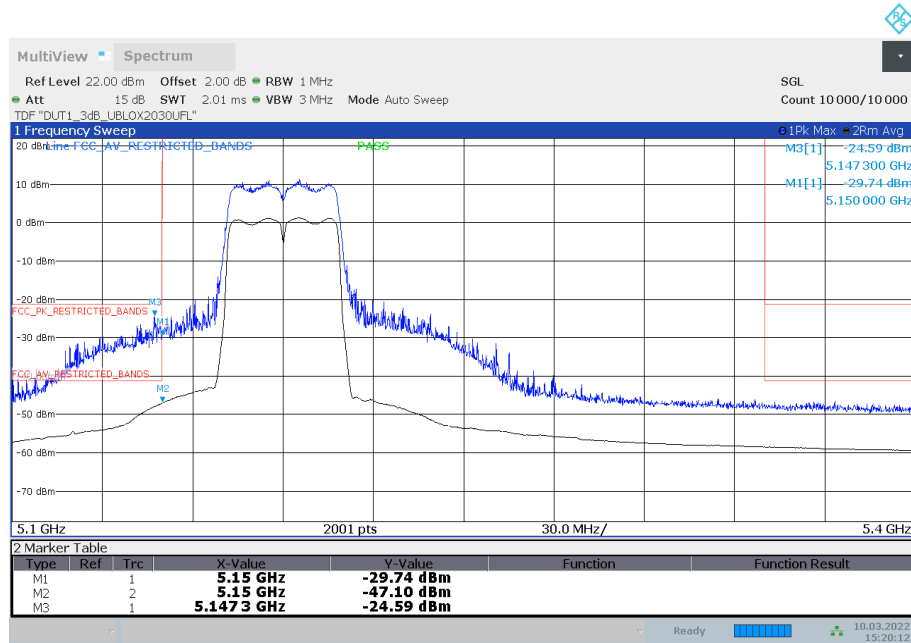

15:20:12 10.03.2022

Antenna A

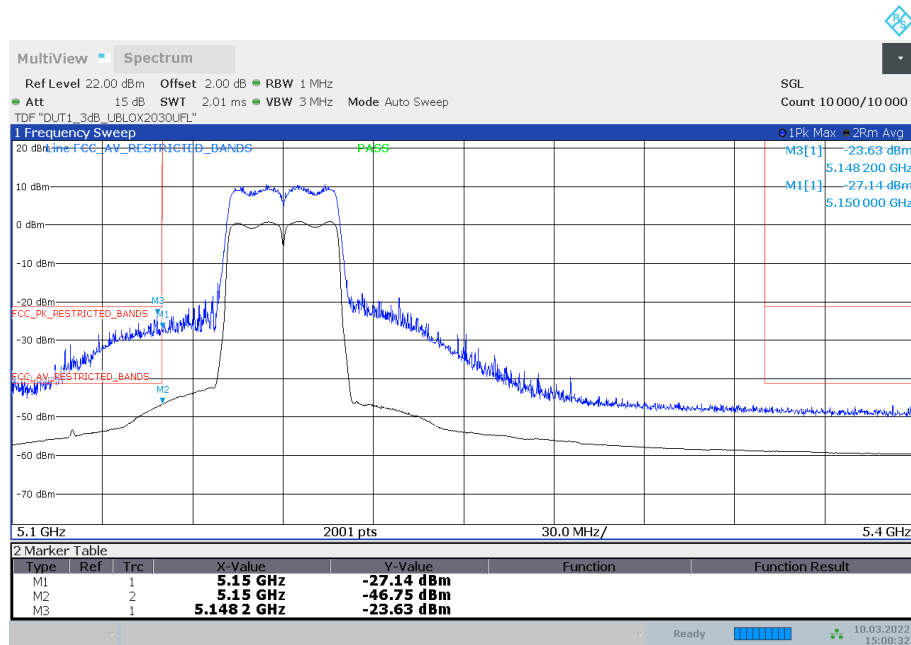

15:00:33 10.03.2022

Antenna B

Radio Technology = WLAN n 40 MHz, Operating Frequency = high, Subband = U-NII-2A (S01_377_AA01)

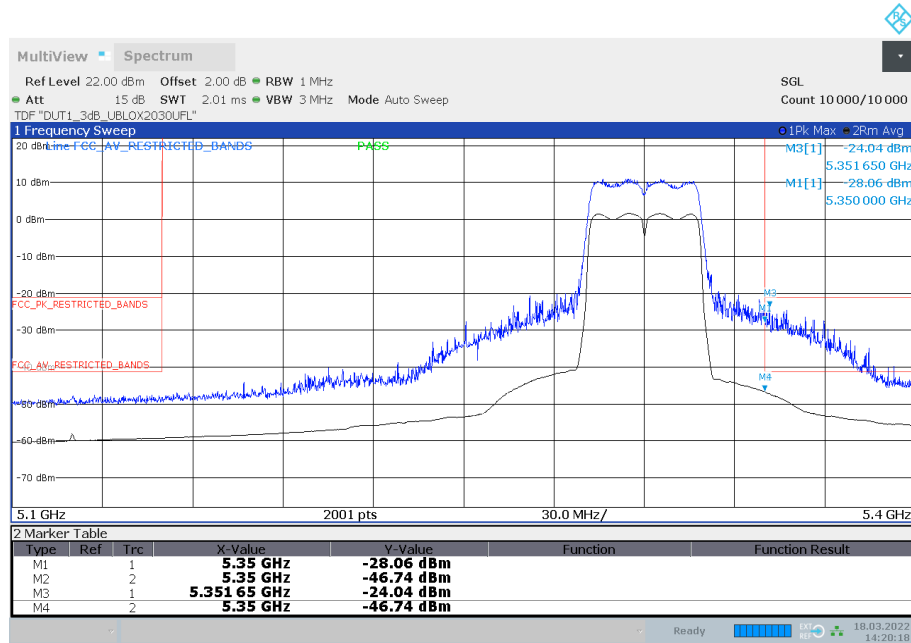

14:20:19 18.03.2022

Antenna A

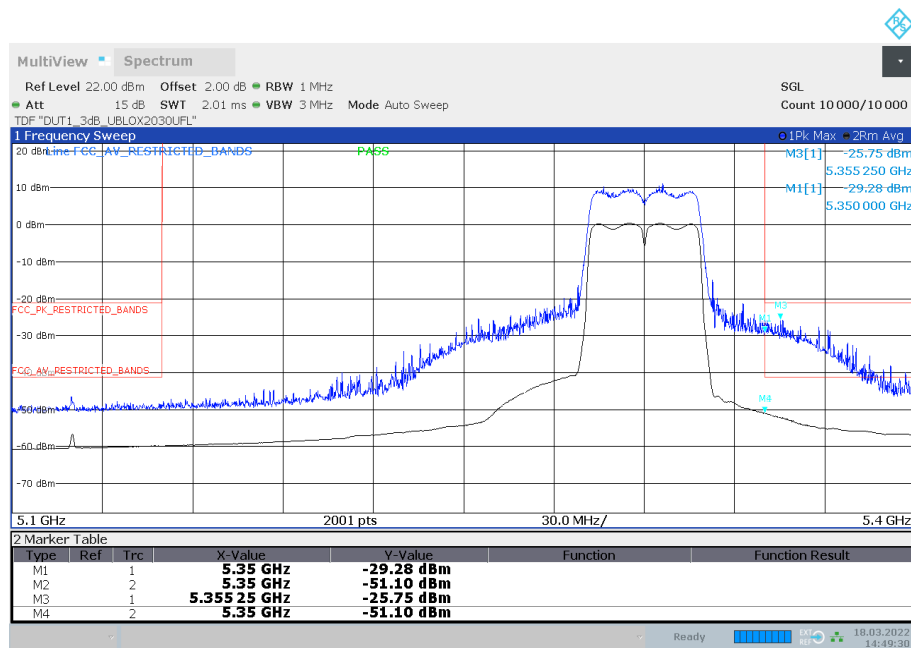

14:49:31 18.03.2022

Antenna B

Radio Technology = WLAN n 40 MHz, Operating Frequency = low, Subband = U-NII-2C (S01_377_AA01)

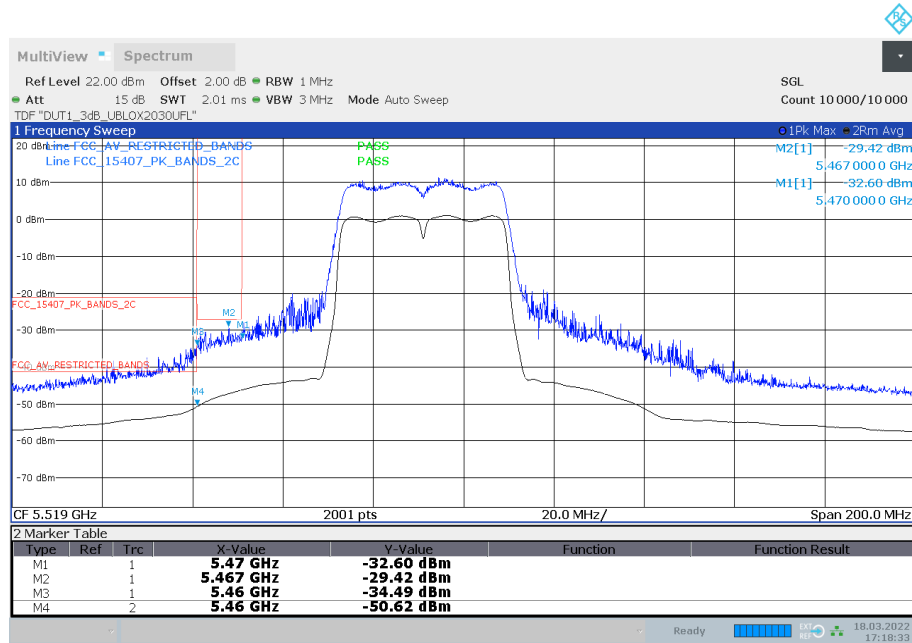

17:18:34 18.03.2022

Antenna A

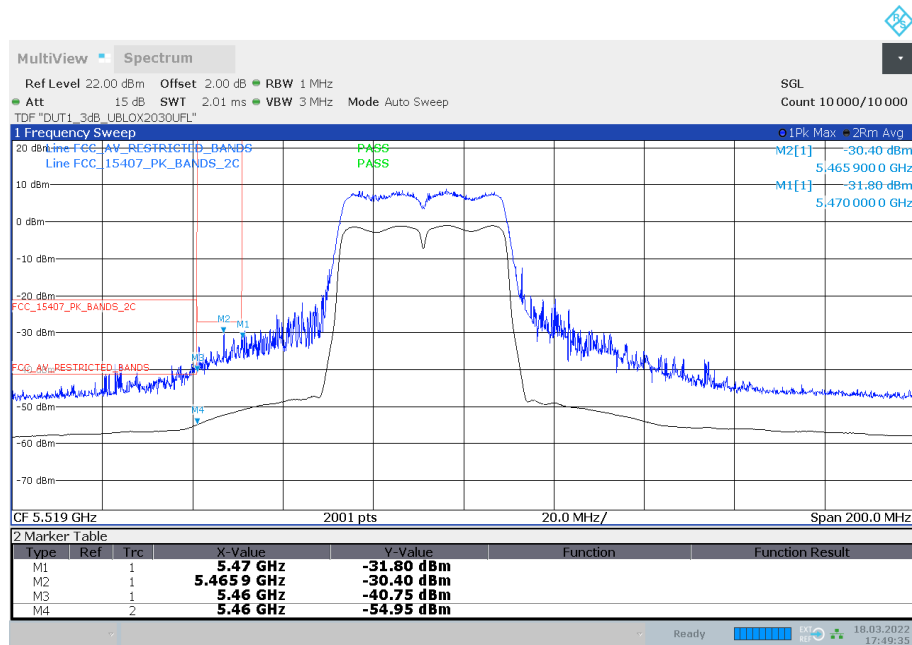

17:49:36 18.03.2022

Antenna B

Radio Technology = WLAN n 40 MHz, Operating Frequency = high, Subband = U-NII-2C
(S01_377_AA01)

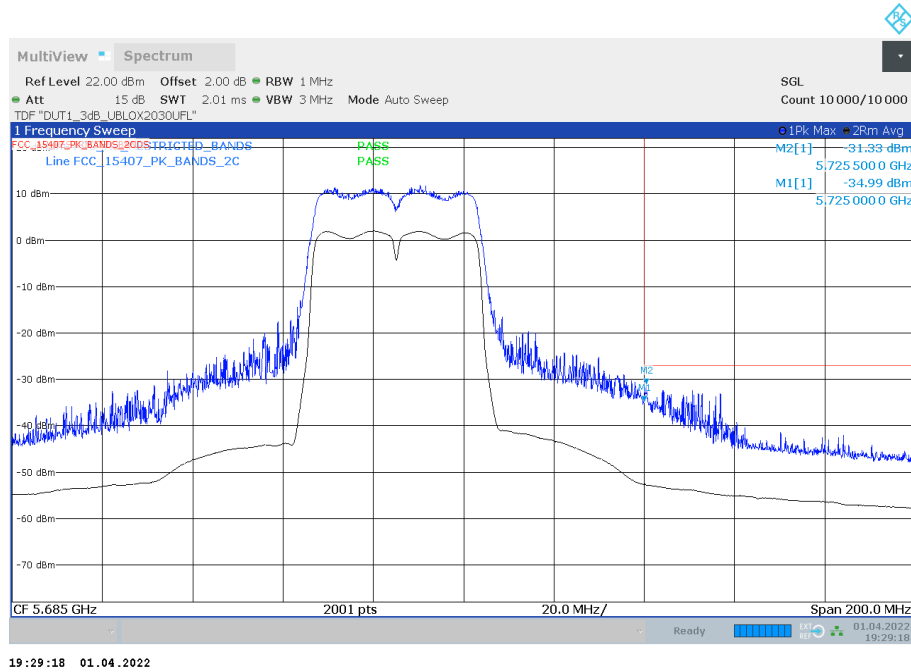

Antenna B

Radio Technology = WLAN ac 20 MHz, Operating Frequency = low, Subband = U-NII-1 (S01_377_AA01)

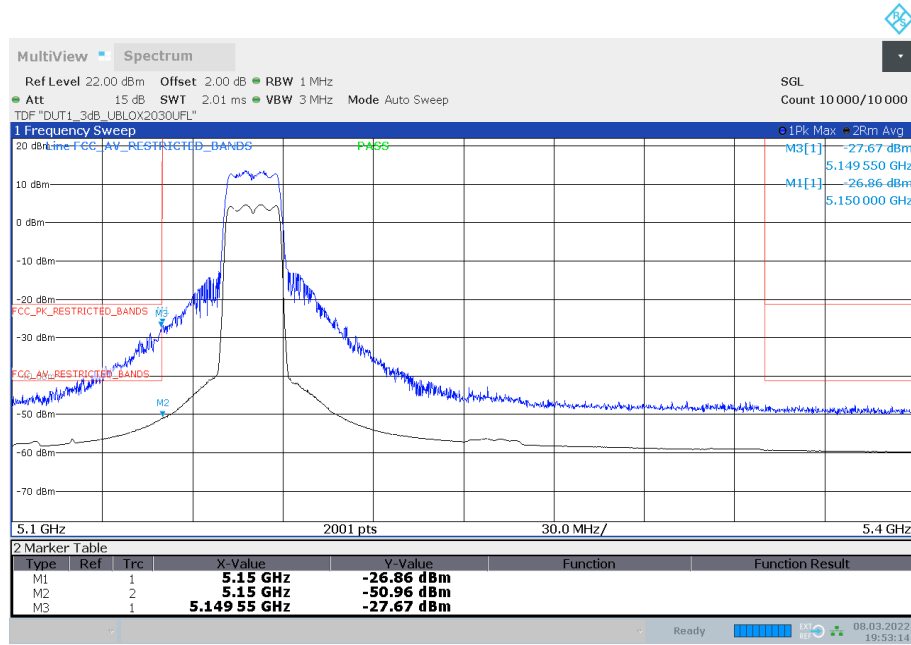

19:53:14 08.03.2022

Antenna A

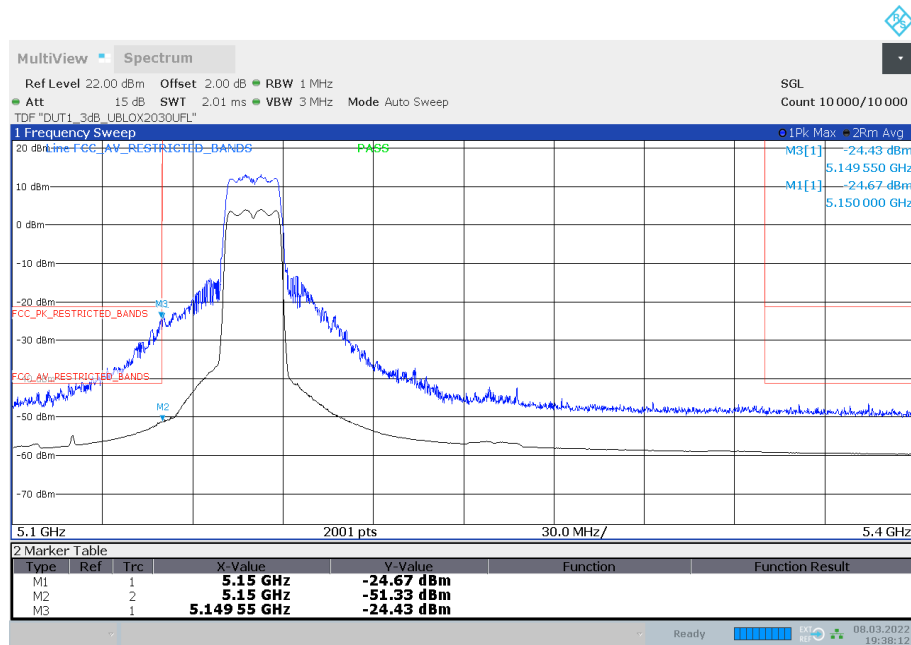

19:38:12 08.03.2022

Antenna B