

Antenna B

Radio Technology = WLAN ax 40 MHz MIMO, Operating Frequency = high, Measurement range = 1 GHz - 26 GHz (S01_377_AA01)

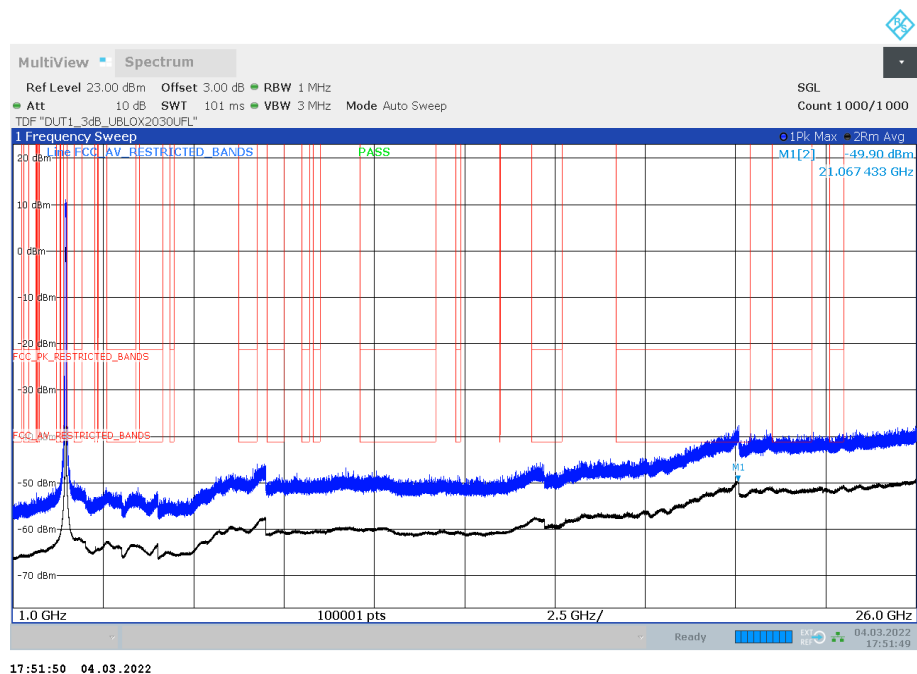

Antenna A

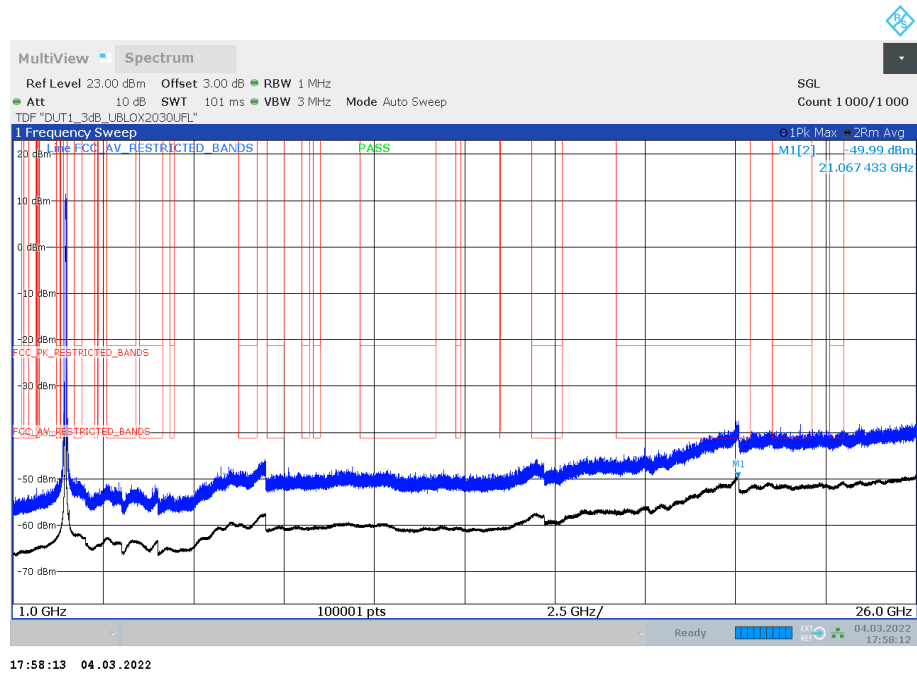

Antenna B

5.6.5 TEST EQUIPMENT USED

- Radiated Emissions FAR 2.4 GHz FCC
- Radiated Emissions SAC H-Field
- Radiated Emissions SAC up to 1 GHz
- R&S TS8997

5.7 BAND EDGE COMPLIANCE CONDUCTED

Standard **FCC Part 15 Subpart C**

The test was performed according to:
ANSI C63.10 11.11

5.7.1 TEST DESCRIPTION

For the conducted measurement, the Equipment Under Test (EUT) is placed in a shielded room. The reference power was measured in the test case "Spurious RF Conducted Emissions".

The EUT was connected to the test system as described in the block diagram below. The complete attenuation of the measurement path is known and considered.

Analyser settings:

- Lower Band Edge:
Measured range: 2310.0 MHz to 2483.5 MHz
Upper Band Edge
Measured range: 2400.0 MHz to 2500 MHz
- Detector: Peak
- Resolution Bandwidth (RBW): 100 kHz
- Video Bandwidth (VBW): 300 kHz
- Sweptime: Auto
- Sweeps: Till stable (min. 300, max. 15000)
- Trace: Maxhold

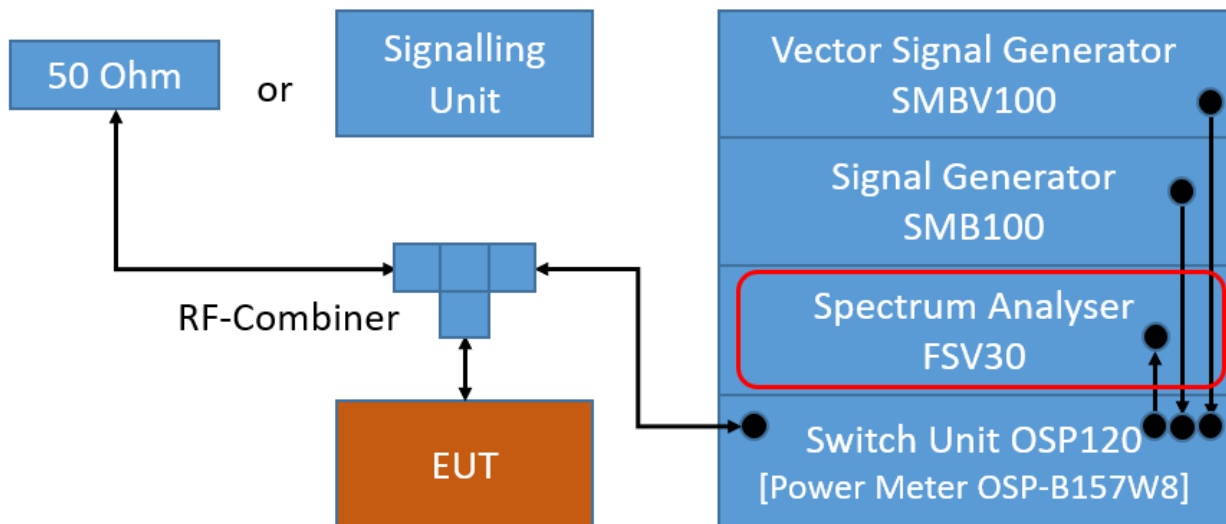

TS8997; Band Edge Conducted

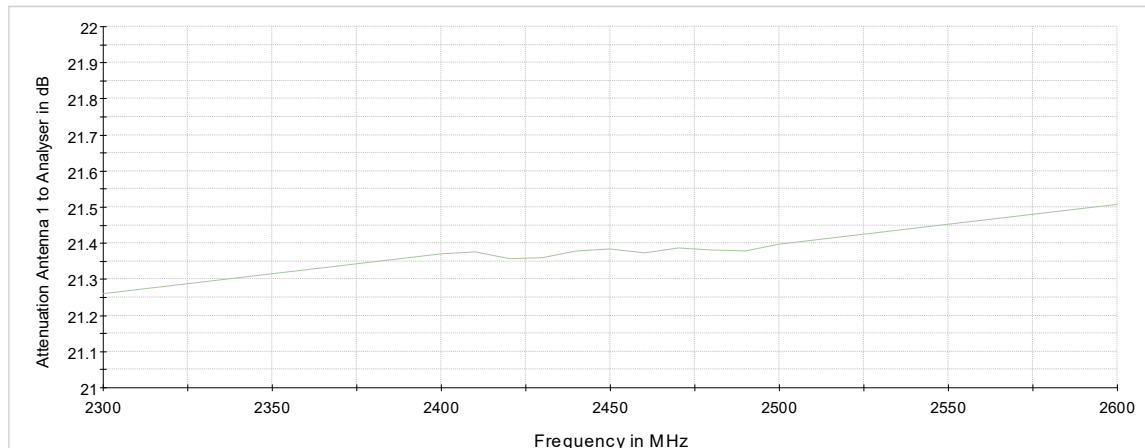

Attenuation of the measurement path

5.7.2 TEST REQUIREMENTS / LIMITS

FCC Part 15.247 (d)

“In any 100 kHz bandwidth outside the frequency band in which the spread spectrum or digitally modulated intentional radiator is operating, the radio frequency power that is produced by the intentional radiator shall be at least 20 dB below that in the 100 kHz bandwidth within the band that contains the highest level of the desired power, based on either an RF conducted or a radiated measurement, provided the transmitter demonstrates compliance with the peak conducted power limits. ...

If the transmitter complies with the conducted power limits based on the use of RMS averaging over a time interval, as permitted under paragraph (b)(3) of this section, the attenuation required under this paragraph shall be 30 dB instead of 20 dB. Attenuation below the general limits specified in Section 15.209(a) is not required. In addition, radiated emissions which fall in the restricted bands, as defined in Section 15.205(a), must also comply with the radiated emission limits specified in Section 15.209(a) (see Section 15.205(c)).”

For the conducted measurement the RF power at the band edge shall be “at least 20 dB below that in the 100 kHz bandwidth within the band that contains the highest level of the desired power...”

5.7.3 TEST PROTOCOL

Ambient temperature: 25 °C
 Air Pressure: 1026 hPa
 Humidity: 33 %
 BT GFSK (1-DH5)

Variants	Channel Center Frequency [MHz]	Band Edge Freq. [MHz]	Spurious Level [dBm]	Detector	RBW [kHz]	Ref. Level [dBm]	Limit [dBm]	Margin to Limit [dB]
377	2402	2400.0	-45.2	PEAK	100	10.9	-9.1	36.1
374	2402	2400.0	-45.8	PEAK	100	11.0	-9.0	36.8
374	2480	2483.5	-50.1	PEAK	100	10.8	-9.2	40.9
377	2480	2483.5	-49.5	PEAK	100	11.0	-9.0	40.5

BT DQPSK (2-DH5)

Variants	Channel Center Frequency [MHz]	Band Edge Freq. [MHz]	Spurious Level [dBm]	Detector	RBW [kHz]	Ref. Level [dBm]	Limit [dBm]	Margin to Limit [dB]
374	2402	2400.0	-46.3	PEAK	100	8.1	-11.9	34.4
377	2402	2400.0	-44.8	PEAK	100	8.1	-11.9	32.9
377	2480	2483.5	-45.6	PEAK	100	8.0	-12.0	33.6
374	2480	2483.5	-48.2	PEAK	100	8.0	-12.0	36.2

BT 8-DPSK (3-DH5)

Variants	Channel Center Frequency [MHz]	Band Edge Freq. [MHz]	Spurious Level [dBm]	Detector	RBW [kHz]	Ref. Level [dBm]	Limit [dBm]	Margin to Limit [dB]
374	2402	2400.0	-42.0	PEAK	100	8.1	-11.9	30.1
377	2402	2400.0	-42.1	PEAK	100	8.1	-11.9	30.2
374	2480	2483.5	-45.5	PEAK	100	11.0	-9.0	36.5
377	2480	2483.5	-45.4	PEAK	100	8.0	-12.0	33.4

BT LE 1 Mbit/s

Variants	Channel Center Frequency [MHz]	Band Edge Freq. [MHz]	Spurious Level [dBm]	Detector	RBW [kHz]	Ref. Level [dBm]	Limit [dBm]	Margin to Limit [dB]
377	2402	2400.0	-49.1	PEAK	100	7.8	-12.2	36.9
374	2402	2400.0	-49.0	PEAK	100	7.4	-12.6	36.4
374	2480	2483.5	-51.0	PEAK	100	7.2	-12.8	38.2
377	2480	2483.5	-50.3	PEAK	100	7.7	-12.3	38.0

BT LE 2 Mbit/s

Variants	Channel Center Frequency [MHz]	Band Edge Freq. [MHz]	Spurious Level [dBm]	Detector	RBW [kHz]	Ref. Level [dBm]	Limit [dBm]	Margin to Limit [dB]
377	2402	2400.0	-22.7	PEAK	100	7.9	-12.1	10.6
374	2402	2400.0	-22.4	PEAK	100	7.6	-12.4	10.0
377	2480	2483.5	-49.0	PEAK	100	7.4	-12.6	36.4
374	2480	2483.5	-49.7	PEAK	100	7.4	-12.6	37.1

WLAN b-Mode; 20 MHz; 1 Mbit/s

Variant	Channel Center Frequency [MHz]	Band Edge Freq. [MHz]	Spurious Level [dBm]	Detector	RBW [kHz]	Ref. Level [dBm]	Limit [dBm]	Margin to Limit [dB]
377	2412	2400.0	-39.1	PEAK	100	9.3	-20.7	18.4
377	2462	2483.5	-44.6	PEAK	100	9.5	-20.5	24.1

WLAN g-Mode; 20 MHz; 6 Mbit/s

Variant	Channel Center Frequency [MHz]	Band Edge Freq. [MHz]	Spurious Level [dBm]	Detector	RBW [kHz]	Ref. Level [dBm]	Limit [dBm]	Margin to Limit [dB]
377	2412	2400.0	-35.3	PEAK	100	3.6	-26.4	8.9
377	2462	2483.5	-45.1	PEAK	100	2.7	-27.3	17.8

WLAN n-Mode; 20 MHz; MCS0

Variant	Channel Center Frequency [MHz]	Band Edge Freq. [MHz]	Spurious Level [dBm]	Detector	RBW [kHz]	Ref. Level [dBm]	Limit [dBm]	Margin to Limit [dB]
377	2412	2400.0	-32.6	PEAK	100	3.5	-26.5	6.1
377	2462	2483.5	-45.1	PEAK	100	2.8	-27.2	17.9

WLAN n-Mode; 40 MHz; MCS0

Variant	Channel Center Frequency [MHz]	Band Edge Freq. [MHz]	Spurious Level [dBm]	Detector	RBW [kHz]	Ref. Level [dBm]	Limit [dBm]	Margin to Limit [dB]
377	2422	2400.0	-32.1	PEAK	100	-0.4	-30.4	1.7
377	2452	2483.5	-43.8	PEAK	100	-0.9	-30.9	12.9

WLAN ax-Mode; 20 MHz; MCS0

Variant	Channel Center Frequency [MHz]	Band Edge Freq. [MHz]	Spurious Level [dBm]	Detector	RBW [kHz]	Ref. Level [dBm]	Limit [dBm]	Margin to Limit [dB]
377	2412	2400.0	-34.2	PEAK	100	2.5	-27.5	6.7
377	2462	2483.5	-46.3	PEAK	100	1.5	-28.5	17.8

WLAN ax-Mode; 40 MHz; MCS0

Variant	Channel Center Frequency [MHz]	Band Edge Freq. [MHz]	Spurious Level [dBm]	Detector	RBW [kHz]	Ref. Level [dBm]	Limit [dBm]	Margin to Limit [dB]
377	2422	2400.0	-37.1	PEAK	100	-0.4	-30.4	6.7
377	2452	2483.5	-44.4	PEAK	100	-0.9	-30.9	13.5

WLAN n-Mode; 20 MHz; MCS0; MIMO

Variant	Channel Center Frequency [MHz]	Band Edge Freq. [MHz]	Spurious Level [dBm]	Detector	RBW [kHz]	Ref. Level [dBm]	Limit [dBm]	Margin to Limit [dB]
377	2412	2400.0	-34.0	PEAK	100	5.7	-24.3	9.7
377	2462	2483.5	-43.3	PEAK	100	5.0	-25.0	18.3

WLAN n-Mode; 40 MHz; MCS0; MIMO

Variant	Channel Center Frequency [MHz]	Band Edge Freq. [MHz]	Spurious Level [dBm]	Detector	RBW [kHz]	Ref. Level [dBm]	Limit [dBm]	Margin to Limit [dB]
377	2422	2400.0	-36.5	PEAK	100	-1.2	-31.2	5.3
377	2452	2483.5	-44.0	PEAK	100	1.1	-28.9	15.1

WLAN ax-Mode; 20 MHz; MCS0; MIMO

Variant	Channel Center Frequency [MHz]	Band Edge Freq. [MHz]	Spurious Level [dBm]	Detector	RBW [kHz]	Ref. Level [dBm]	Limit [dBm]	Margin to Limit [dB]
377	2412	2400.0	-36.5	PEAK	100	4.7	-25.3	11.2
377	2462	2483.5	-45.9	PEAK	100	3.9	-26.1	19.8

WLAN ax-Mode; 40 MHz; MCS0; MIMO

Variant	Channel Center Frequency [MHz]	Band Edge Freq. [MHz]	Spurious Level [dBm]	Detector	RBW [kHz]	Ref. Level [dBm]	Limit [dBm]	Margin to Limit [dB]
377	2422	2400.0	-36.8	PEAK	100	2.1	-27.9	8.9
377	2452	2483.5	-42.6	PEAK	100	1.1	-28.9	13.7

Remark: Please see next sub-clause for the measurement plot.
WLAN SISO results of antenna A given in table above.

5.7.4 MEASUREMENT PLOT (EXAMPLE PLOT, SHOWING WORST CASE, IF APPLICABLE)

Radio Technology = Bluetooth BDR, Operating Frequency = low, Band Edge = low
(S01_374_BA01)

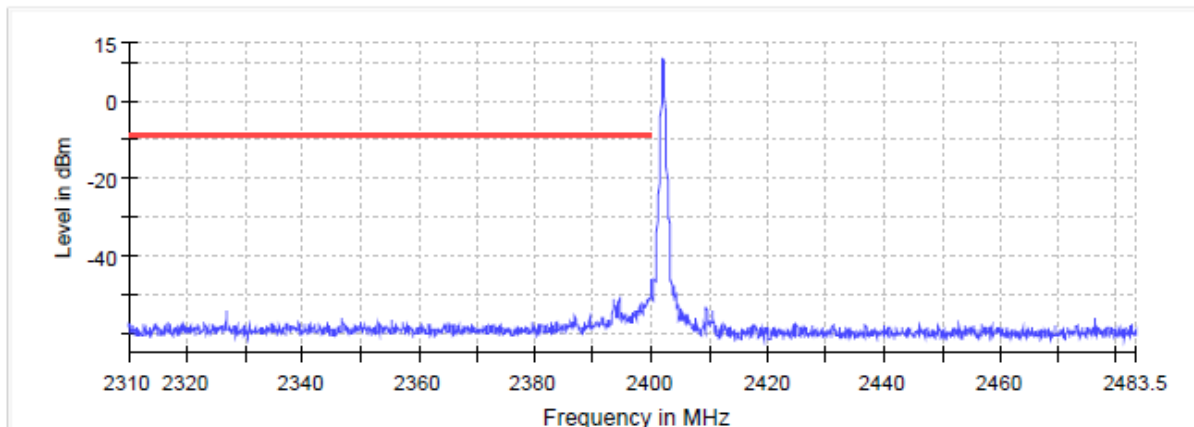

— Limit — Sum Level × Fail

Radio Technology = Bluetooth BDR, Operating Frequency = high, Band Edge = high
(S01_374_BA01)

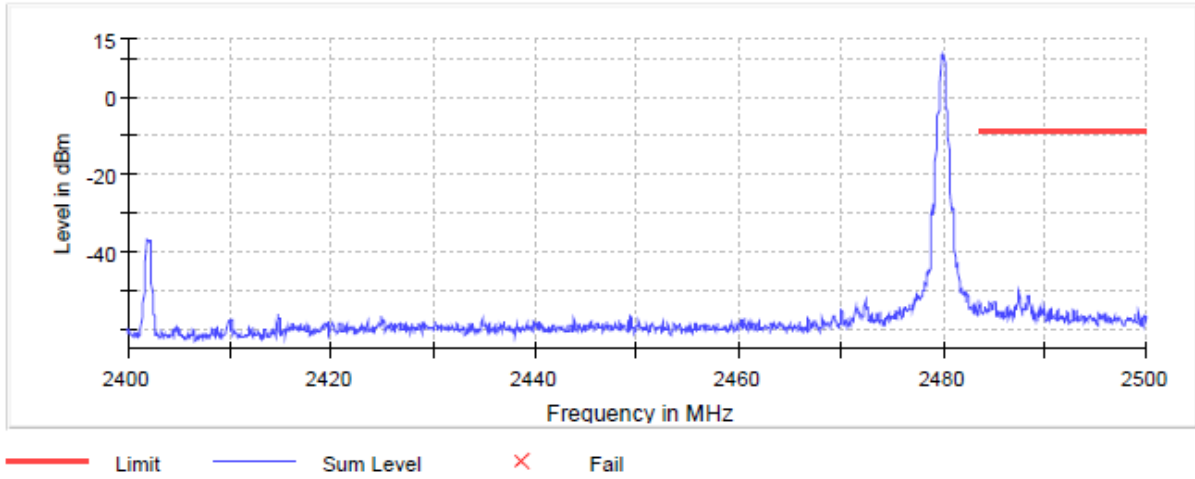

Radio Technology = Bluetooth BDR, Operating Frequency = low, Band Edge = low
(S01_377_AA01)

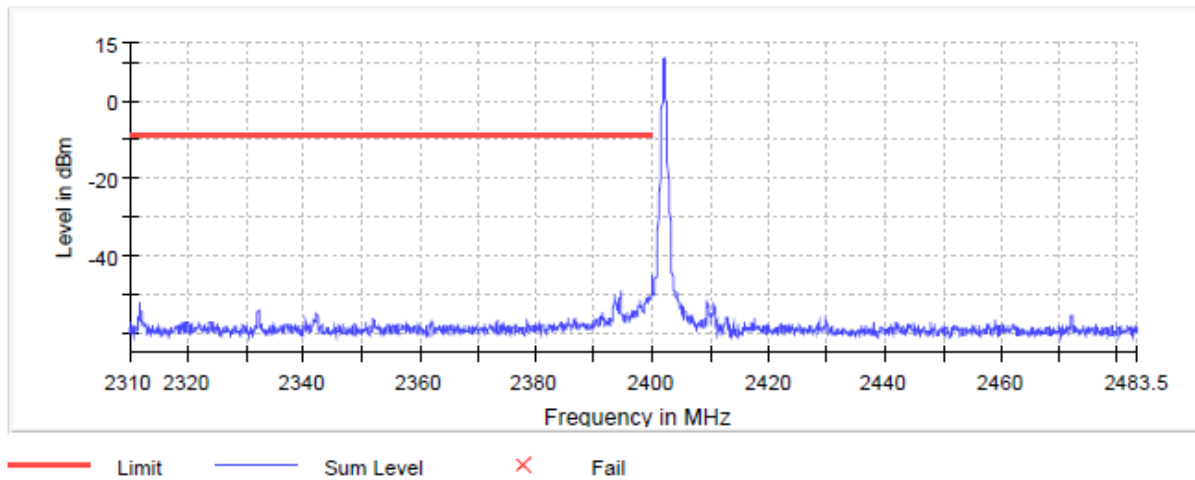

Radio Technology = Bluetooth BDR, Operating Frequency = high, Band Edge = high
(S01_377_AA01)

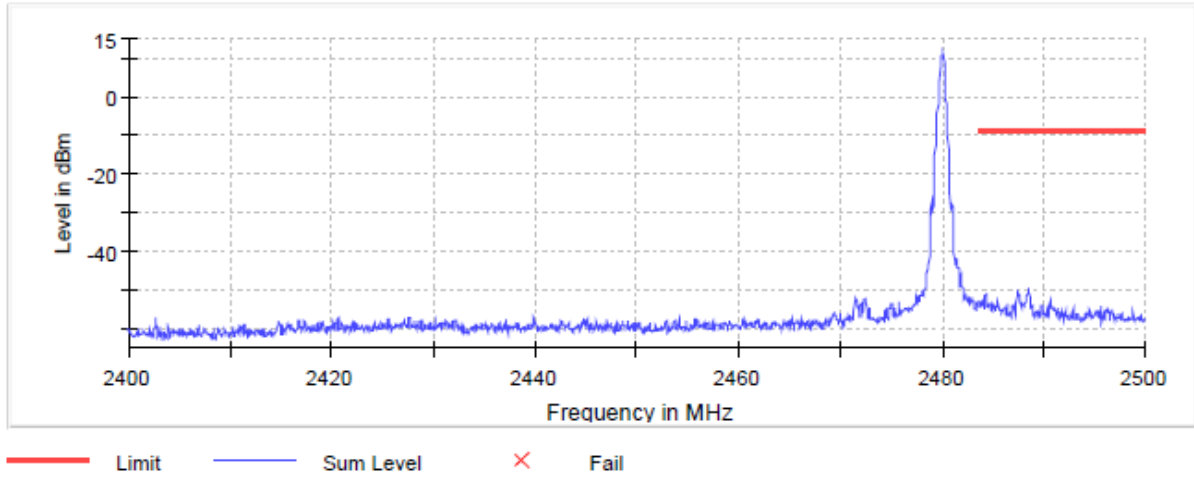

Radio Technology = Bluetooth BDR, Operating Frequency = hopping, Band Edge = low
(S01_377_AA01)

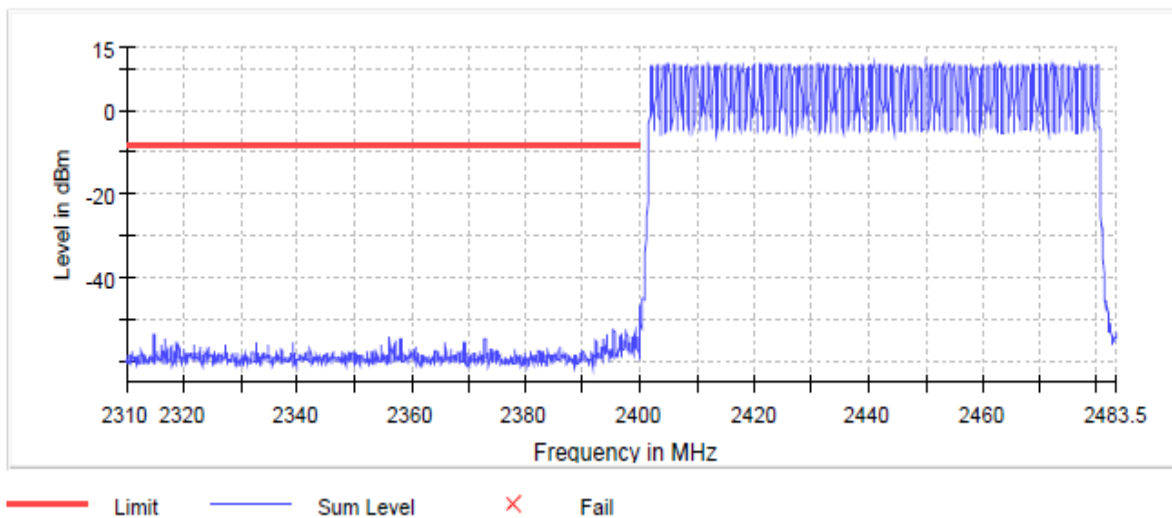

Radio Technology = Bluetooth BDR, Operating Frequency = hopping, Band Edge = high
(S01_377_AA01)

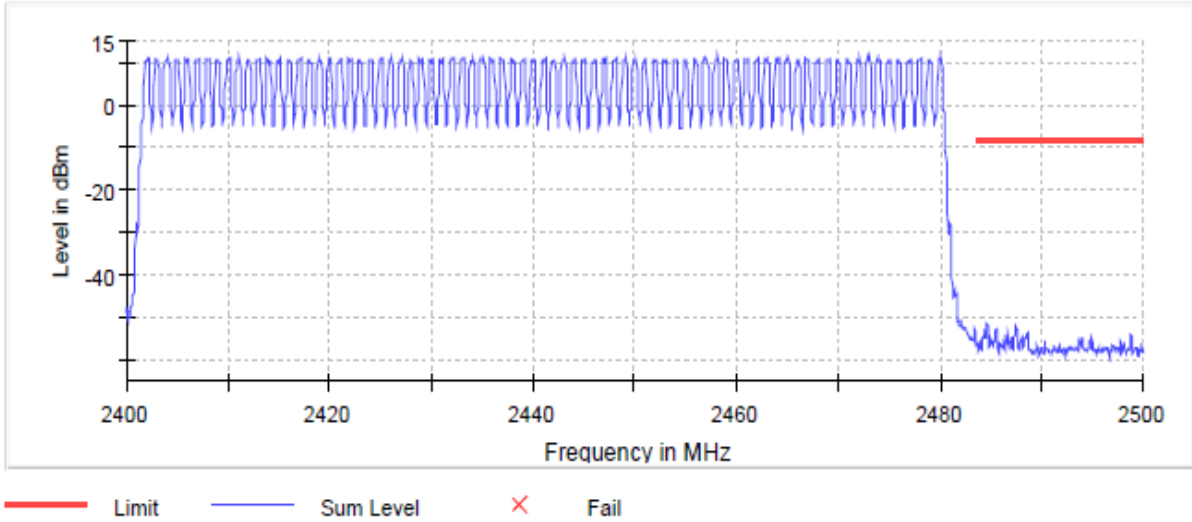

Radio Technology = Bluetooth EDR 2, Operating Frequency = low, Band Edge = low
(S01_377_AA01)

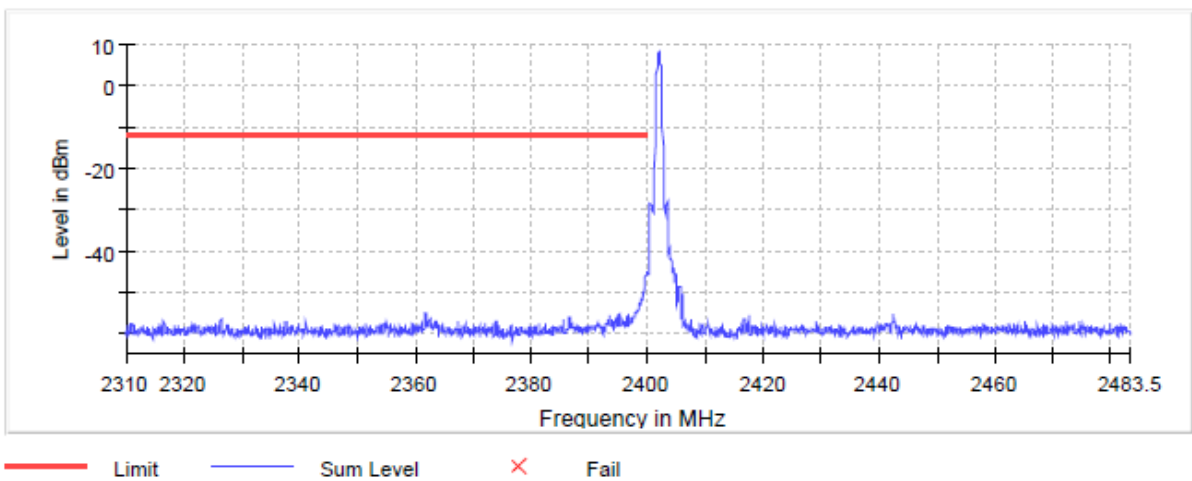

Radio Technology = Bluetooth EDR 2, Operating Frequency = high, Band Edge = high
(S01_377_AA01)

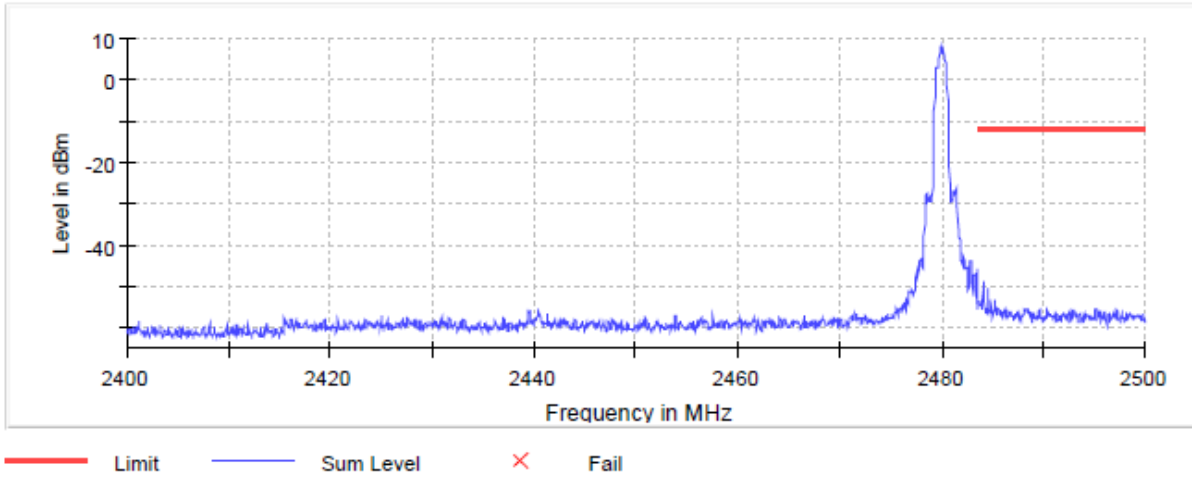

Radio Technology = Bluetooth EDR 2, Operating Frequency = hopping, Band Edge = low
(S01_377_AA01)

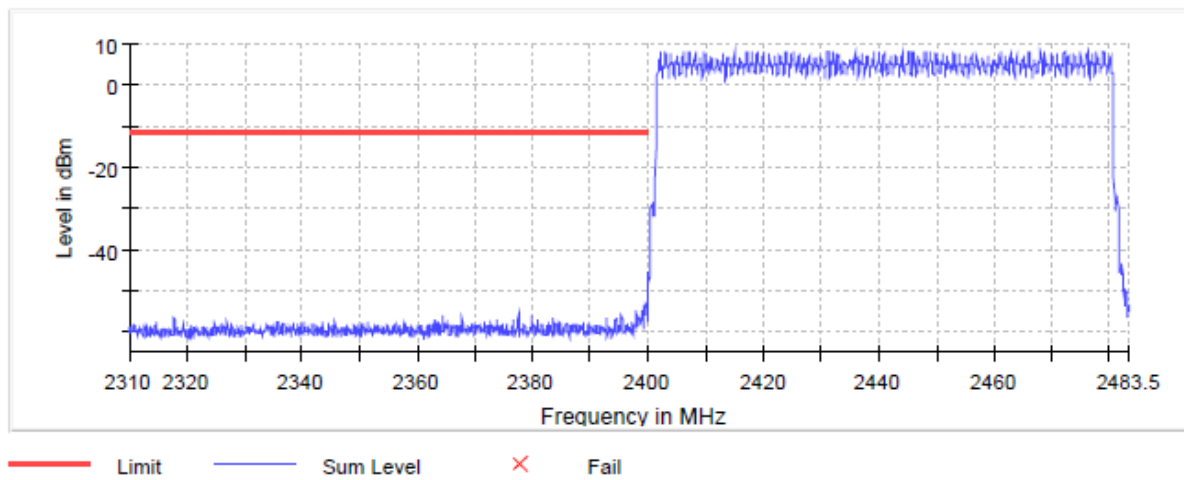

Radio Technology = Bluetooth EDR 2, Operating Frequency = hopping, Band Edge = high
(S01_377_AA01)

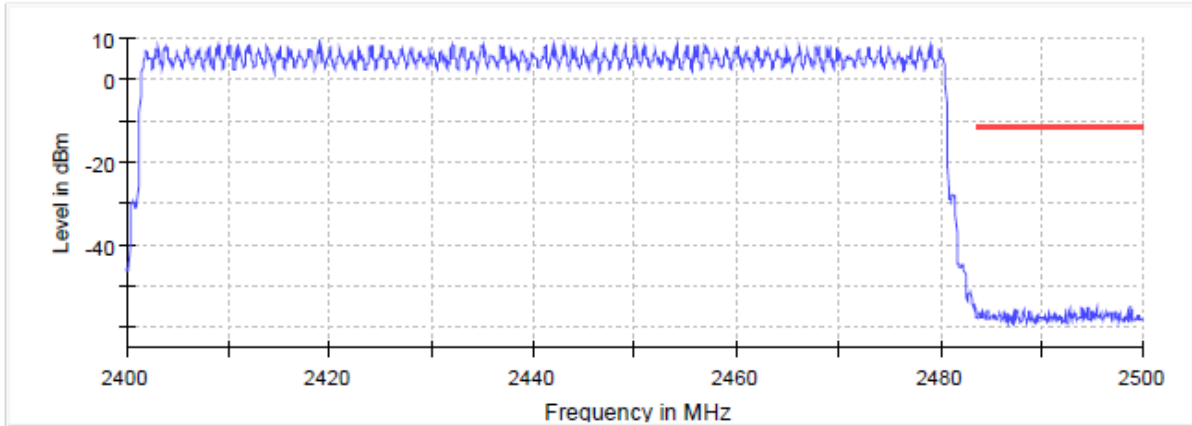

Radio Technology = Bluetooth EDR 2, Operating Frequency = low, Band Edge = low
(S01_374_BA01)

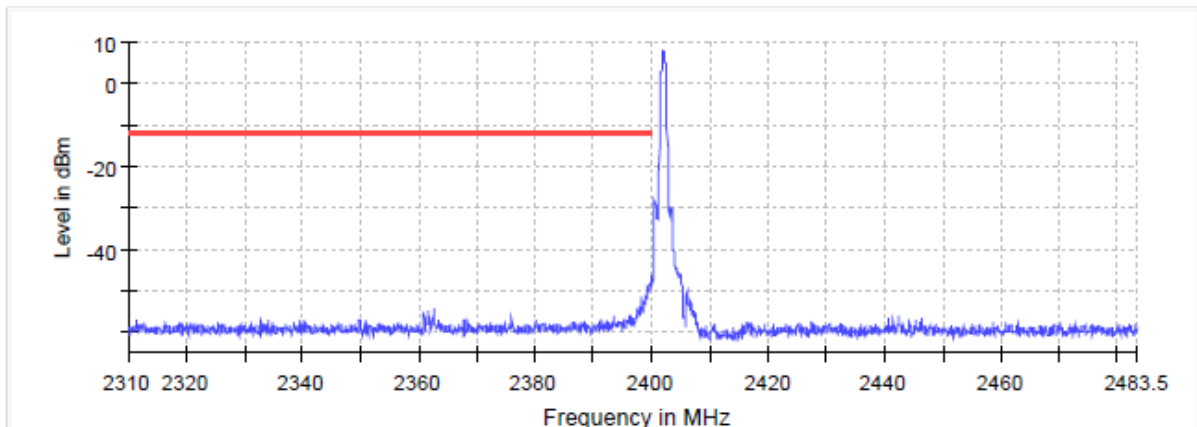

Radio Technology = Bluetooth EDR 2, Operating Frequency = high, Band Edge = high
(S01_374_BA01)

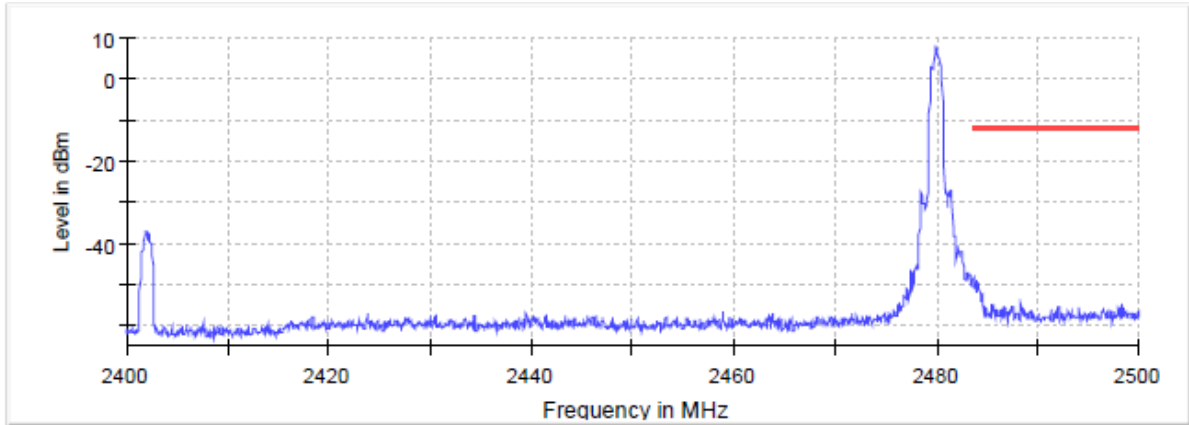

— Limit — Sum Level × Fail

Radio Technology = Bluetooth EDR 3, Operating Frequency = low, Band Edge = low
(S01_374_BA01)

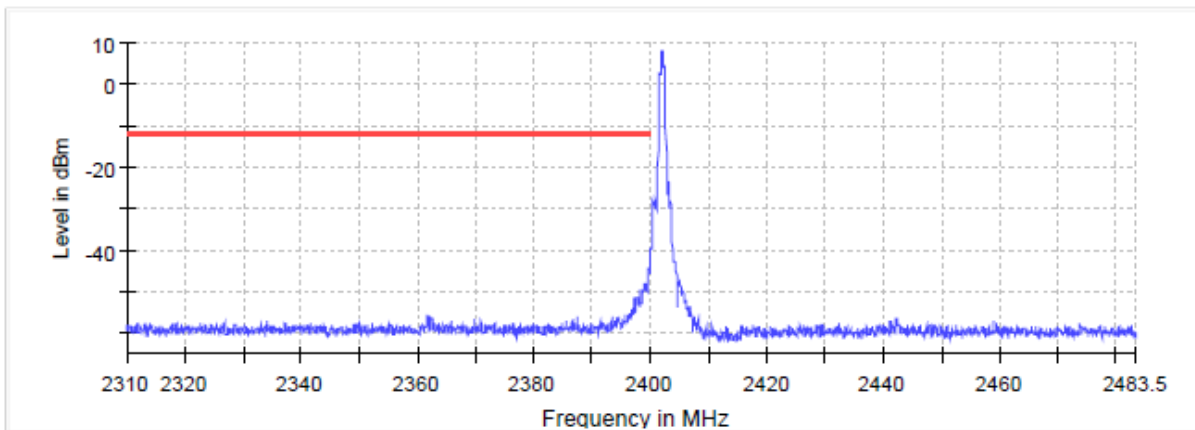

— Limit — Sum Level × Fail

Radio Technology = Bluetooth EDR 3, Operating Frequency = high, Band Edge = high
(S01_374_BA01)

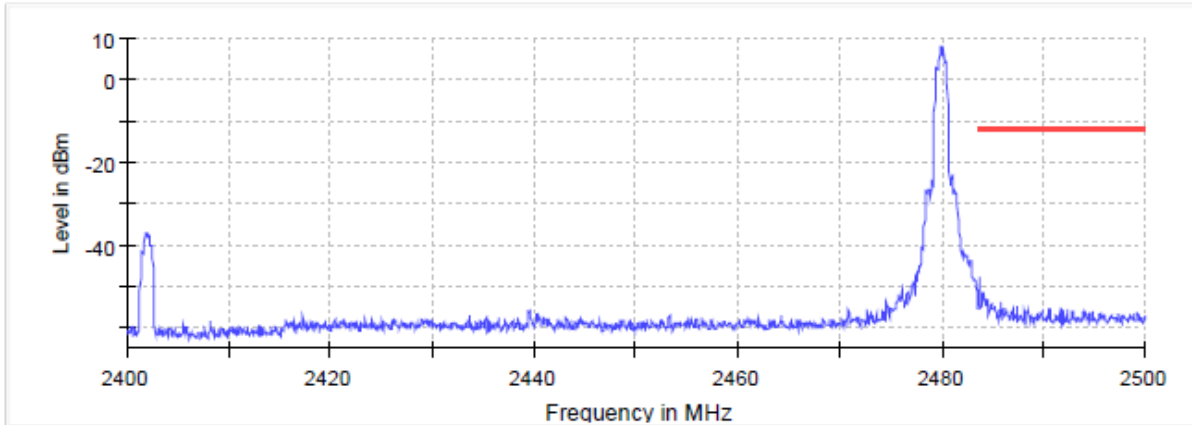

— Limit — Sum Level × Fail

Radio Technology = Bluetooth EDR 3, Operating Frequency = low, Band Edge = low
(S01_377_AA01)

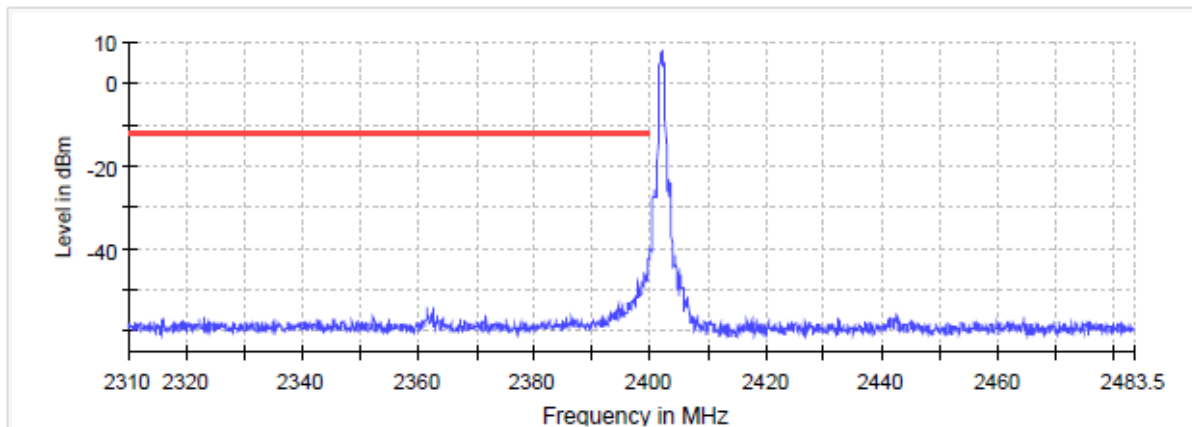

— Limit — Sum Level × Fail

Radio Technology = Bluetooth EDR 3, Operating Frequency = high, Band Edge = high
(S01_377_AA01)

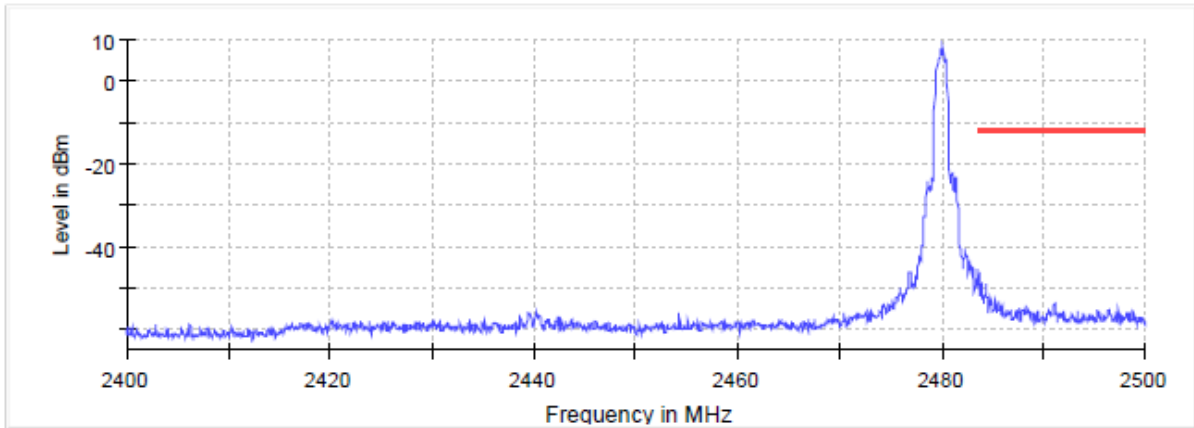

— Limit — Sum Level × Fail

Radio Technology = Bluetooth EDR 3, Operating Frequency = hopping, Band Edge = low
(S01_377_AA01)

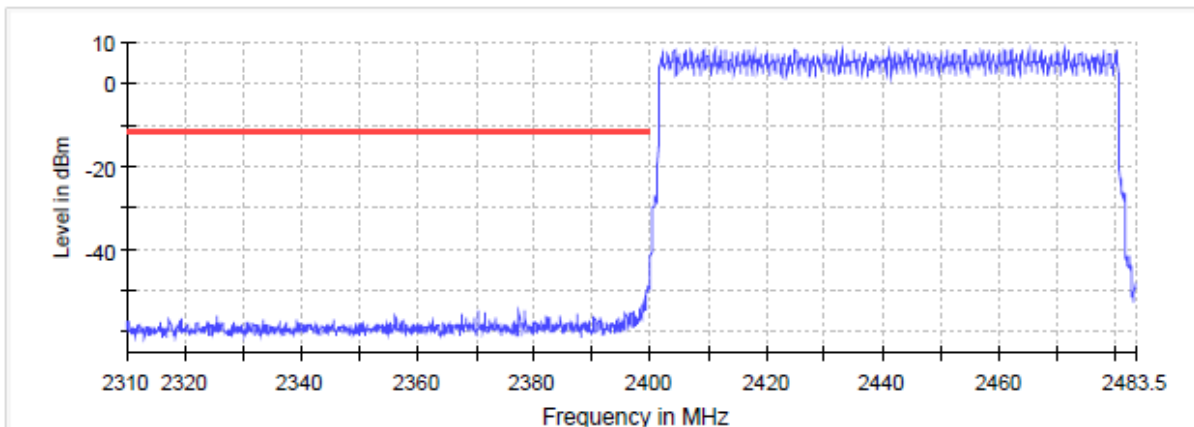

— Limit — Sum Level × Fail

Radio Technology = Bluetooth EDR 3, Operating Frequency = hopping, Band Edge = high
(S01_377_AA01)

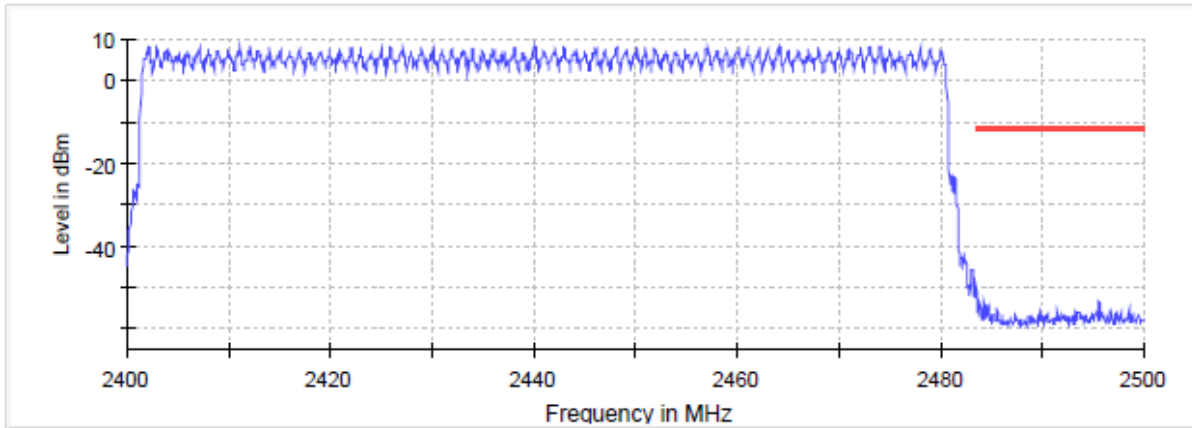

Radio Technology = Bluetooth LE 1 Mbps, Operating Frequency = low, Band Edge = low
(S01_374_BA01)

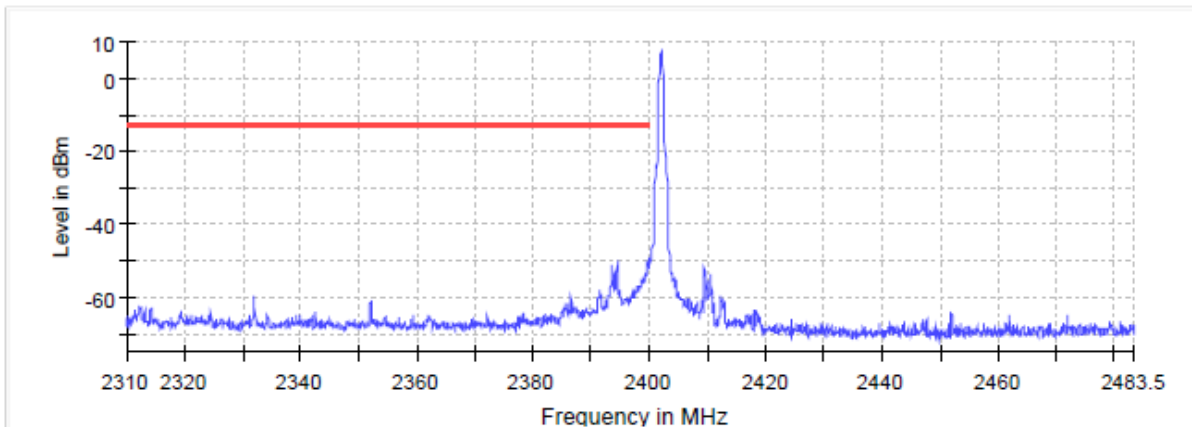

Radio Technology = Bluetooth LE 1 Mbps, Operating Frequency = high, Band Edge = high
(S01_374_BA01)

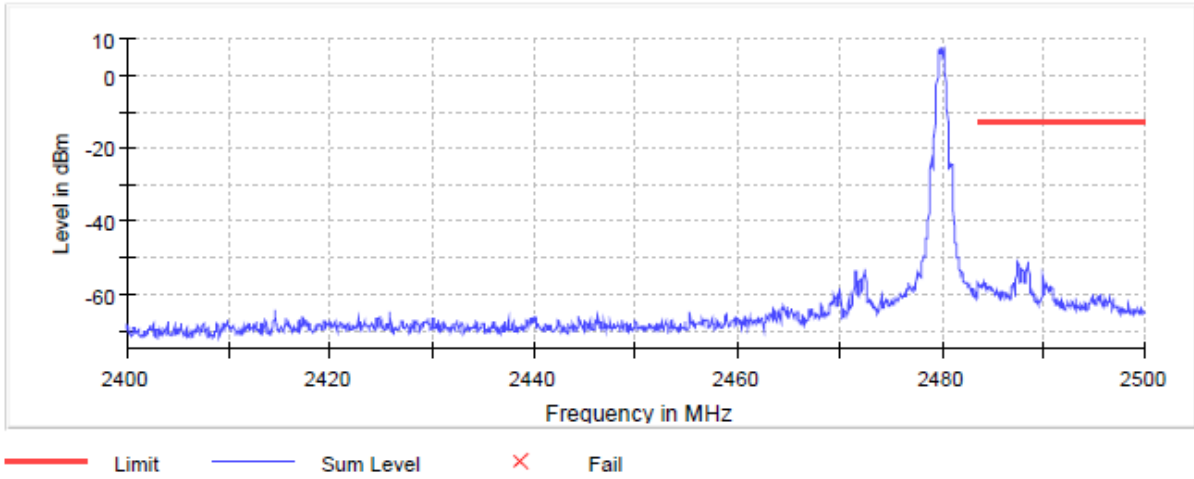

Radio Technology = Bluetooth LE 1 Mbps, Operating Frequency = low, Band Edge = low
(S01_377_AA01)

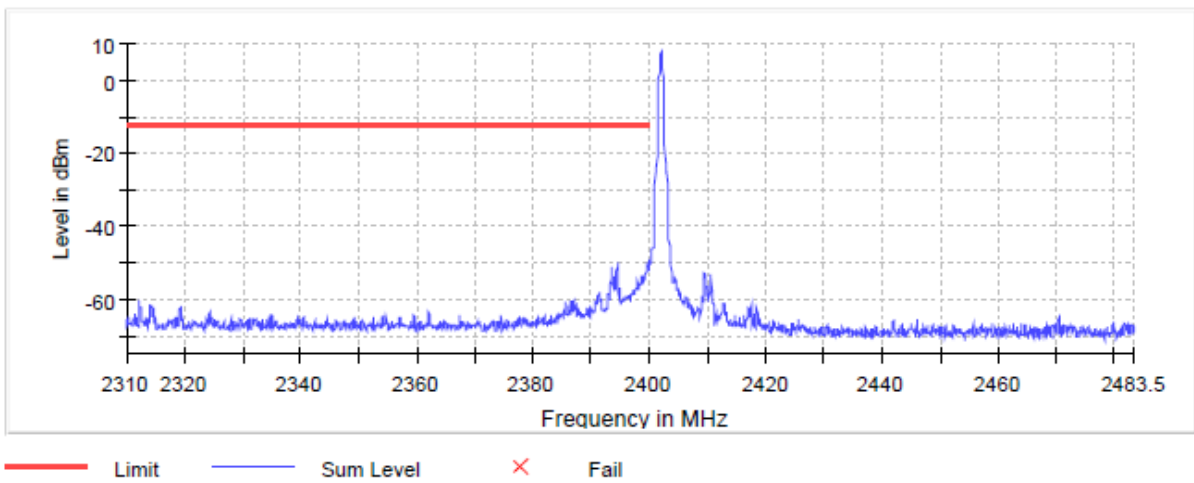

Radio Technology = Bluetooth LE 1 Mbps, Operating Frequency = high, Band Edge = high
(S01_377_AA01)

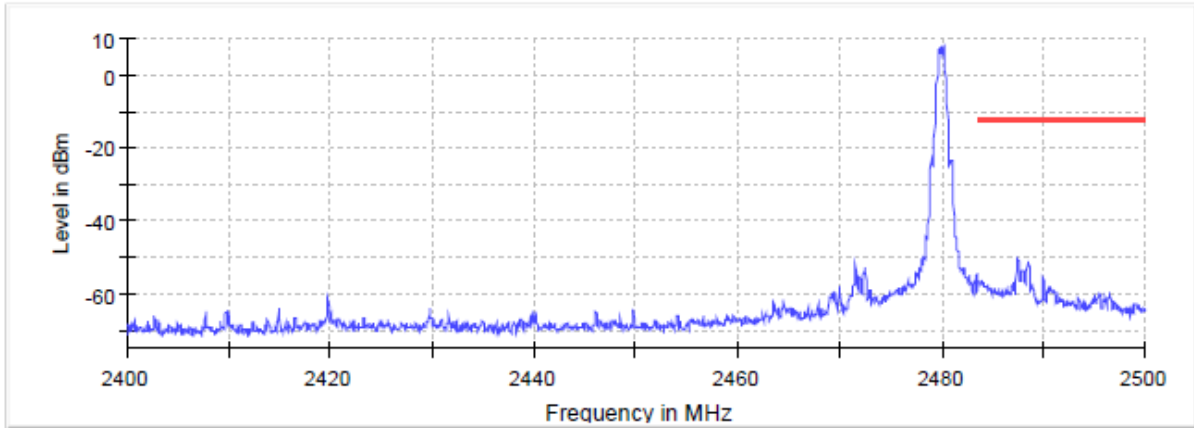

— Limit — Sum Level × Fail

Radio Technology = Bluetooth LE 2 Mbps, Operating Frequency = low, Band Edge = low
(S01_374_BA01)

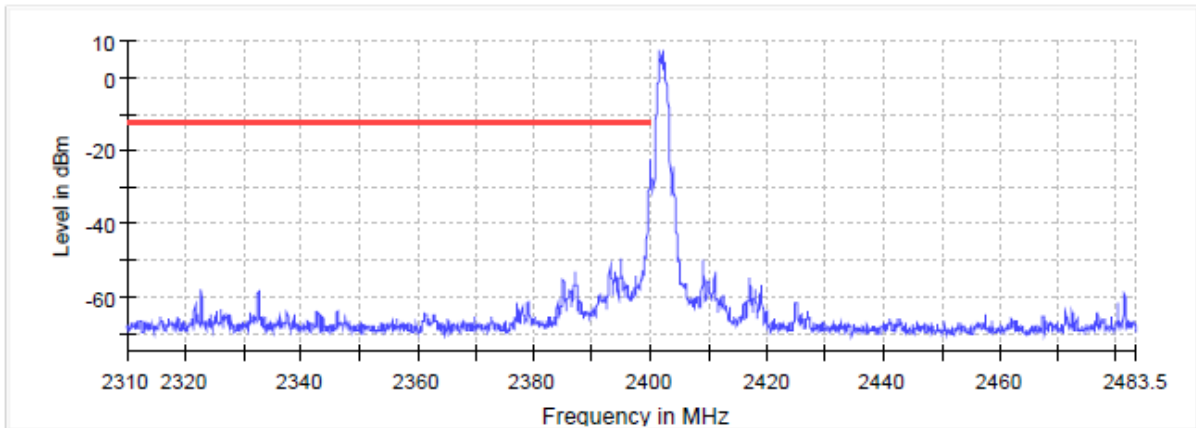

— Limit — Sum Level × Fail

Radio Technology = Bluetooth LE 2 Mbps, Operating Frequency = low, Band Edge = low
(S01_377_AA01)

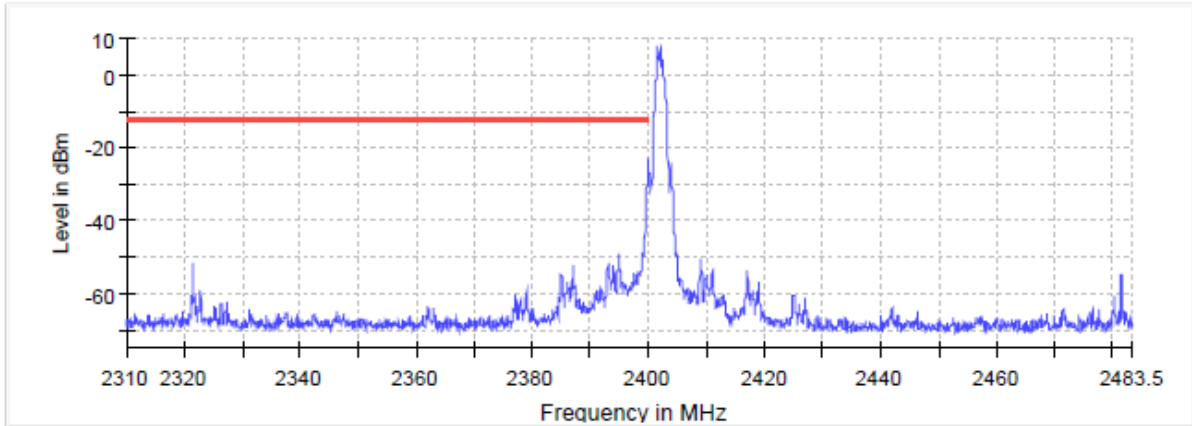

— Limit — Sum Level × Fail

Radio Technology = Bluetooth LE 2 Mbps, Operating Frequency = high, Band Edge = high
(S01_377_AA01)

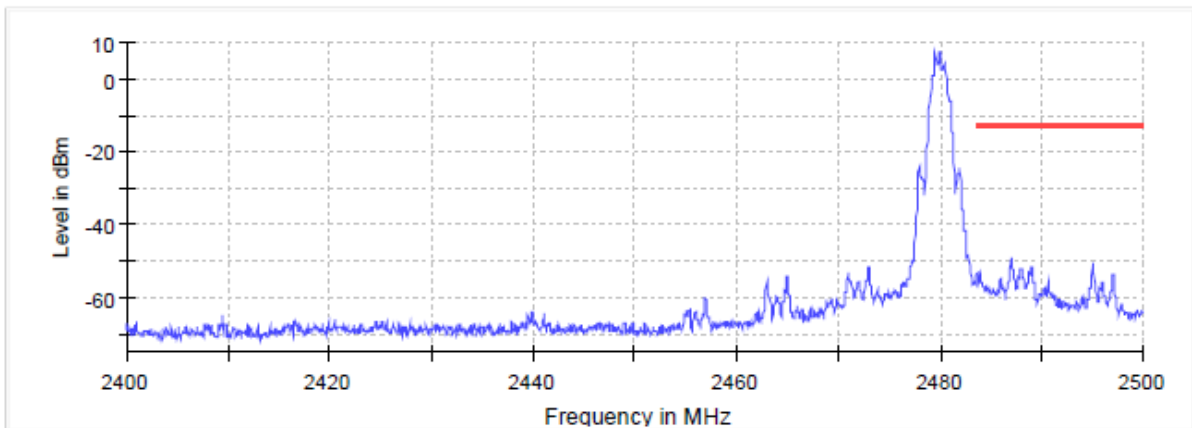

— Limit — Sum Level × Fail

Radio Technology = Bluetooth LE 2 Mbps, Operating Frequency = high, Band Edge = high
(S01_374_BA01)

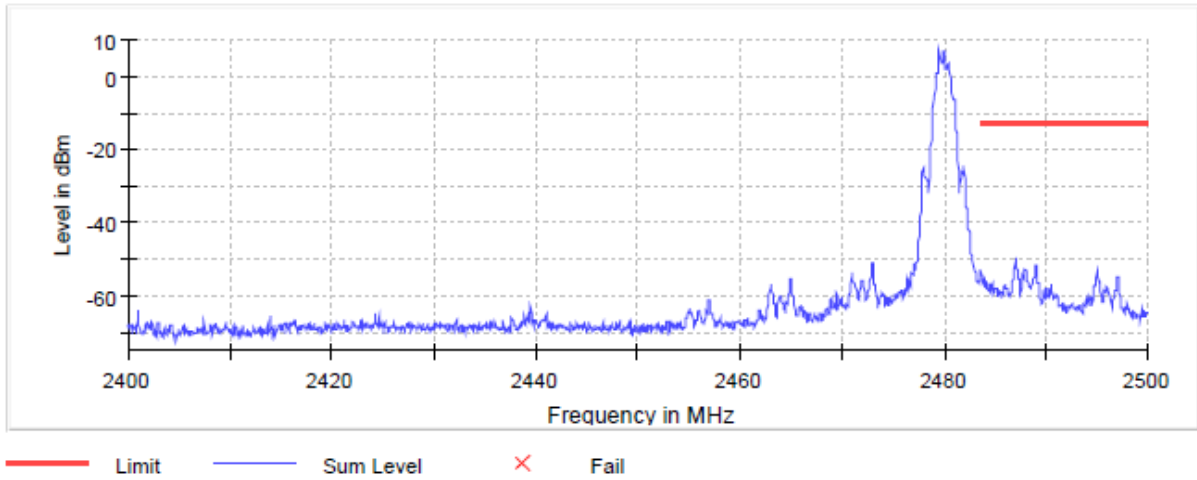

Radio Technology = WLAN b, Operating Frequency = low, Band Edge = low
(S01_377_AA01)

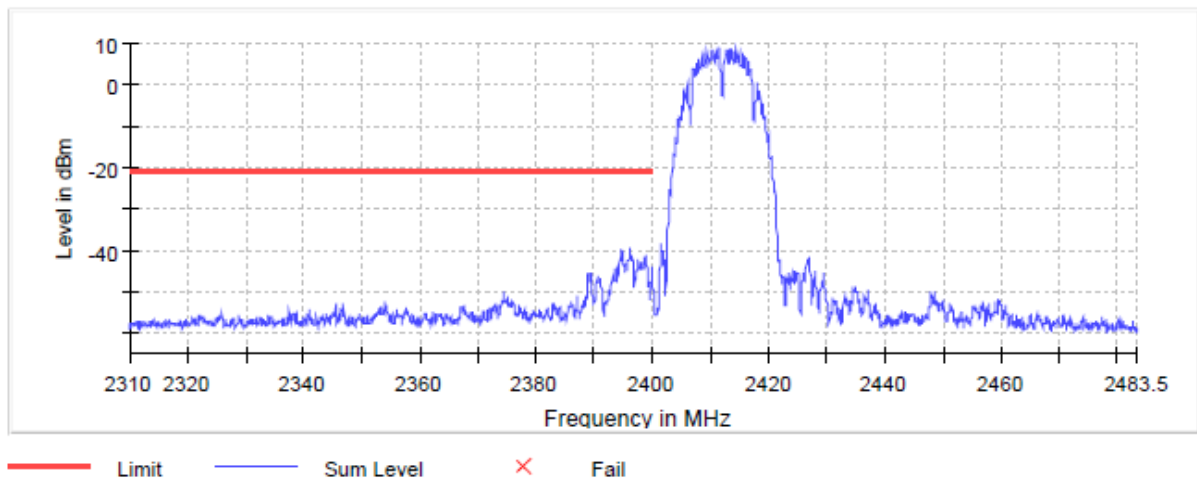

Radio Technology = WLAN b, Operating Frequency = high, Band Edge = high
(S01_377_AA01)

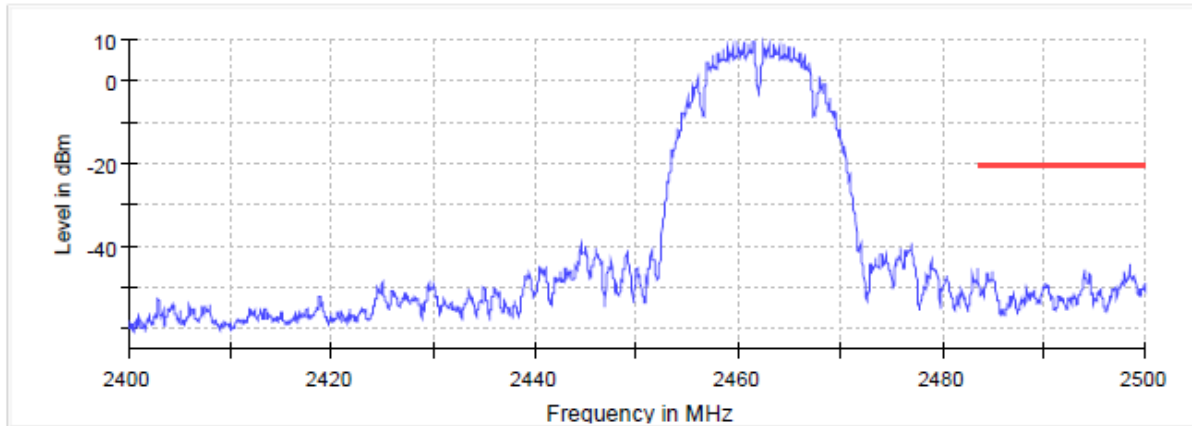

— Limit — Sum Level × Fail

Radio Technology = WLAN g, Operating Frequency = low, Band Edge = low
(S01_377_AA01)

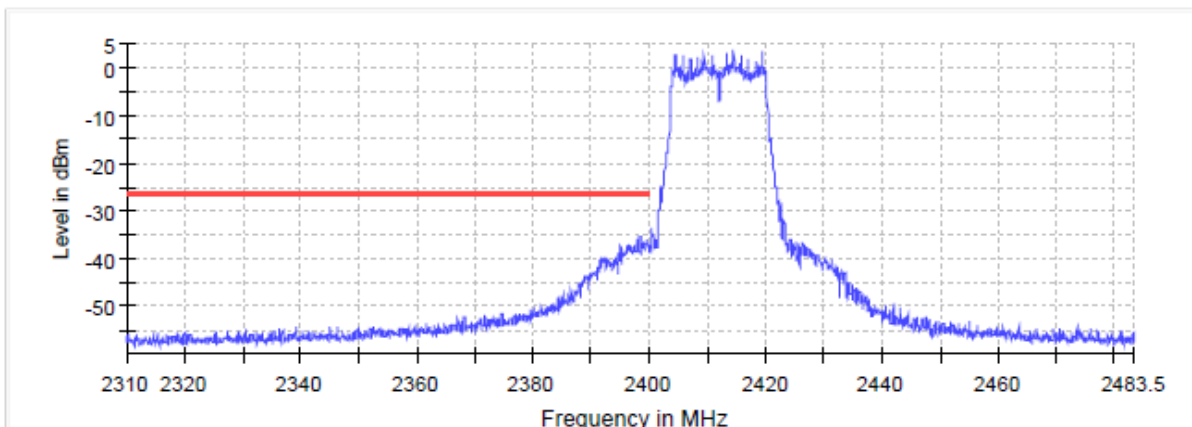

— Limit — Sum Level × Fail

Radio Technology = WLAN g, Operating Frequency = high, Band Edge = high
(S01_377_AA01)

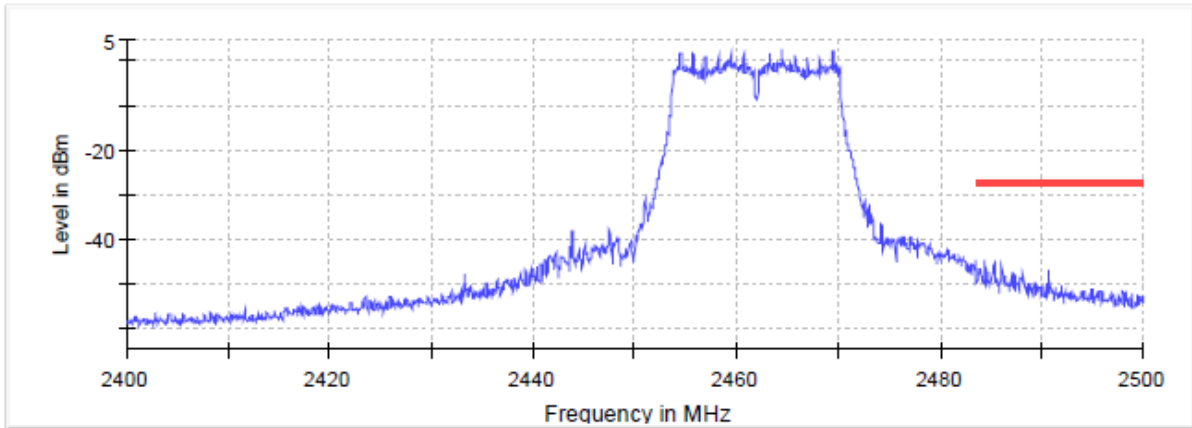

— Limit — Sum Level × Fail

Radio Technology = WLAN n 20 MHz, Operating Frequency = low, Band Edge = low
(S01_377_AA01)

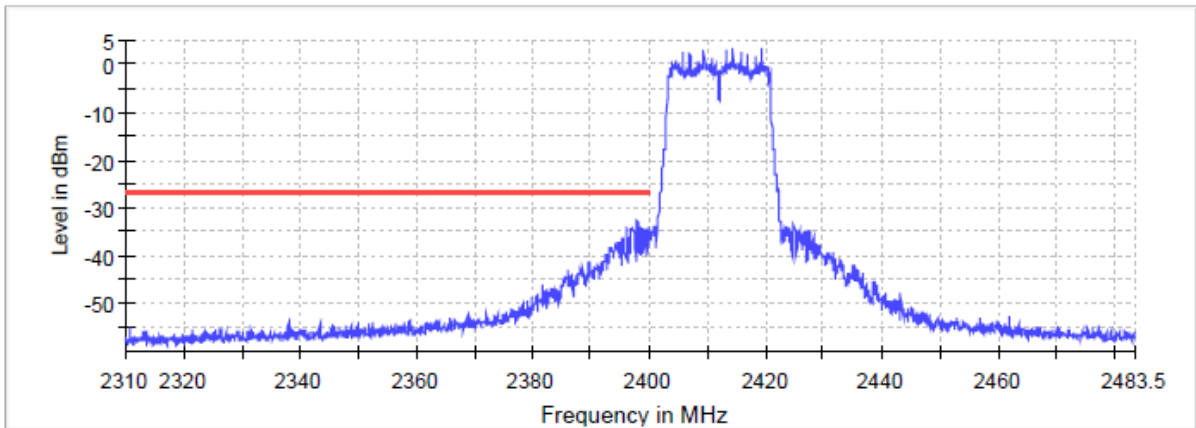

— Limit — Sum Level × Fail

Radio Technology = WLAN n 20 MHz, Operating Frequency = high, Band Edge = high
(S01_377_AA01)

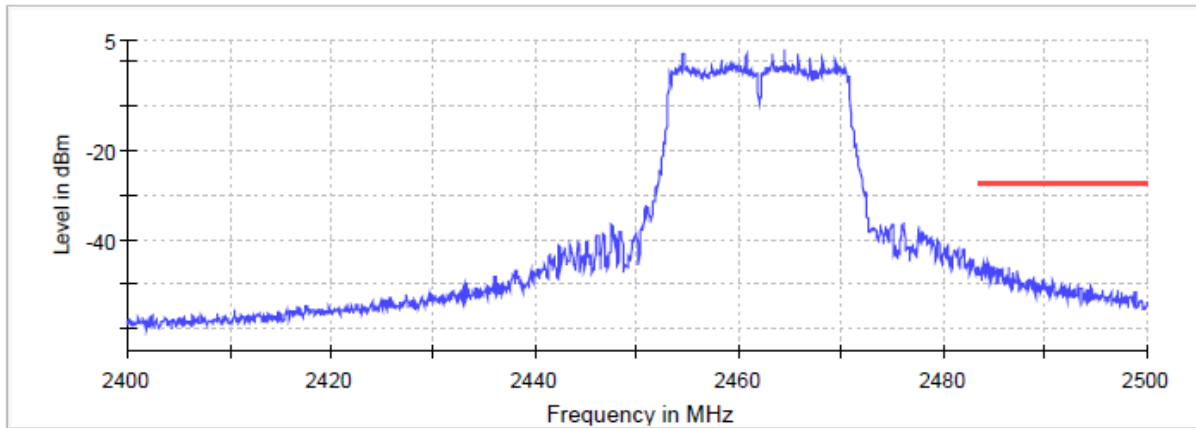

— Limit — Sum Level × Fail

Radio Technology = WLAN n 40 MHz, Operating Frequency = low, Band Edge = low
(S01_377_AA01)

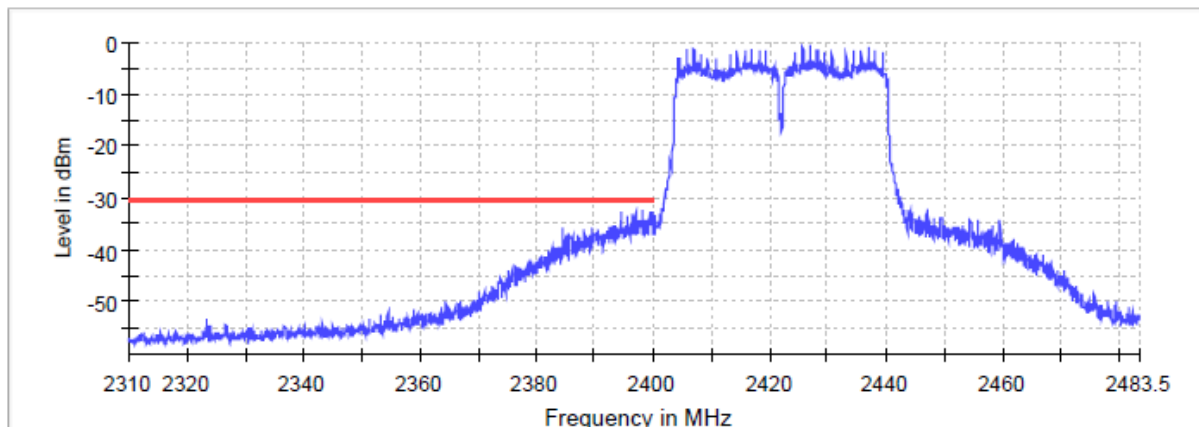

— Limit — Sum Level × Fail

Radio Technology = WLAN n 40 MHz, Operating Frequency = high, Band Edge = high
(S01_377_AA01)

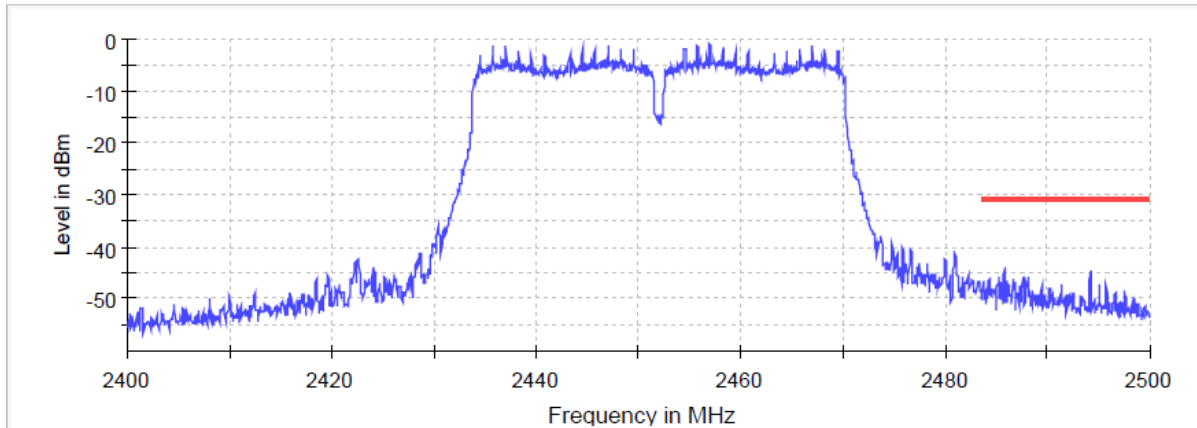

— Limit — Sum Level × Fail

Radio Technology = WLAN ax 20 MHz, Operating Frequency = low, Band Edge = low
(S01_377_AA01)

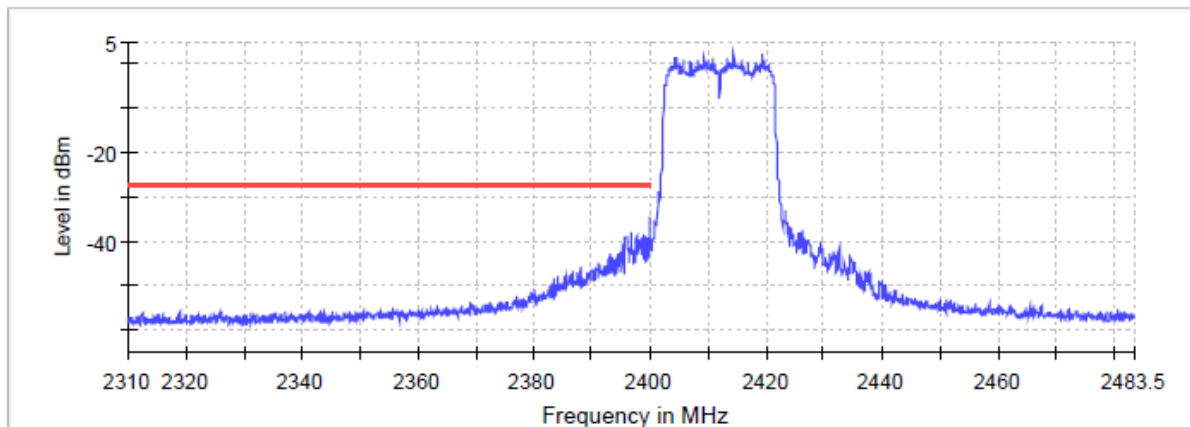

— Limit — Sum Level × Fail

Radio Technology = WLAN ax 20 MHz, Operating Frequency = high, Band Edge = high
(S01_377_AA01)

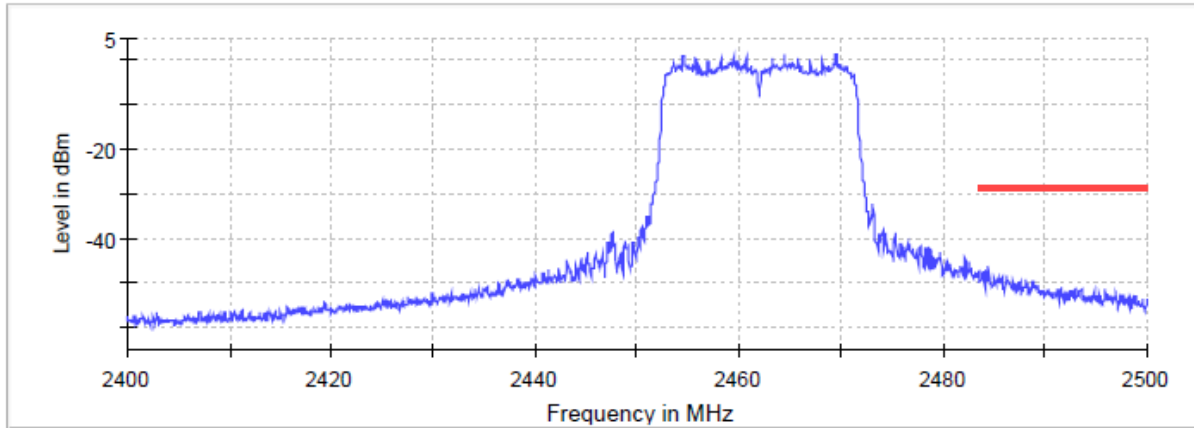

Radio Technology = WLAN ax 40 MHz, Operating Frequency = low, Band Edge = low
(S01_377_AA01)

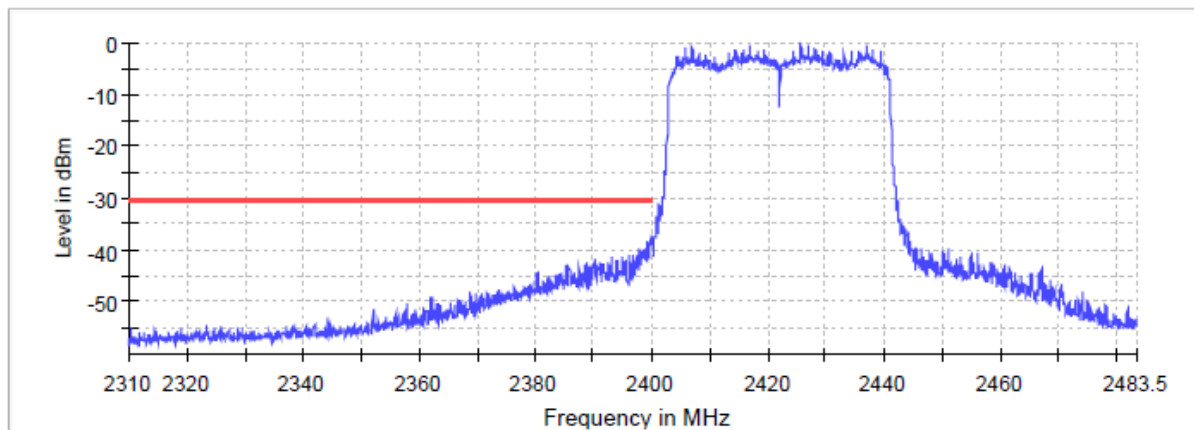

Radio Technology = WLAN ax 40 MHz, Operating Frequency = high, Band Edge = high
(S01_377_AA01)

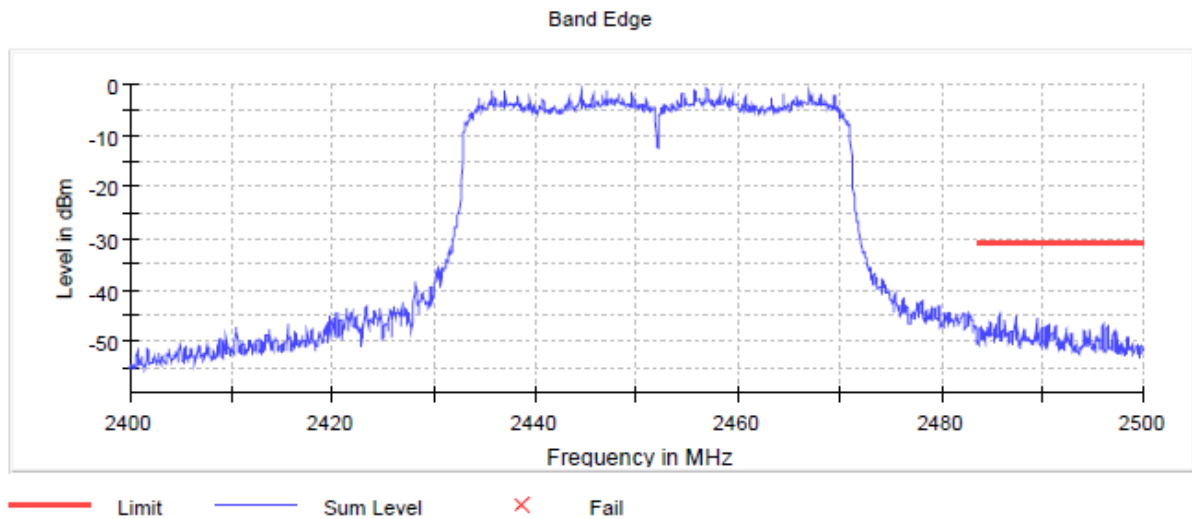

Radio Technology = WLAN n 20 MHz MIMO, Operating Frequency = low, Band Edge = low
(S01_377_AA01)

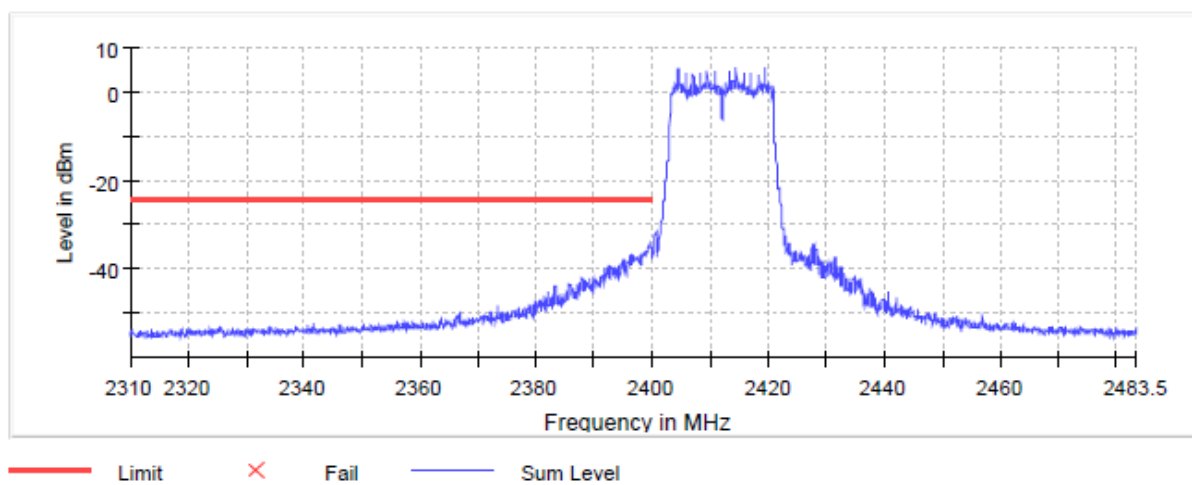

Radio Technology = WLAN n 20 MHz MIMO, Operating Frequency = high, Band Edge = high
(S01_377_AA01)

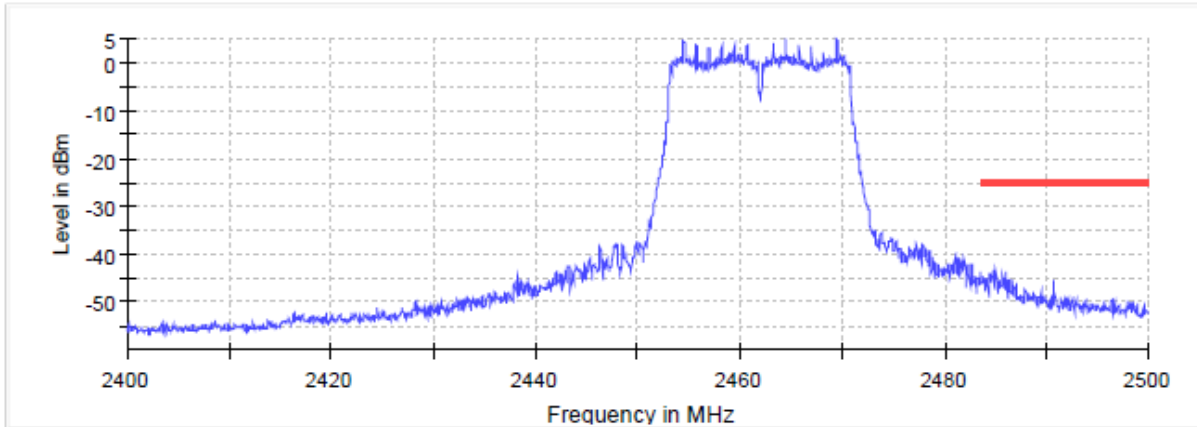

— Limit × Fail — Sum Level

Radio Technology = WLAN n 40 MHz MIMO, Operating Frequency = low, Band Edge = low
(S01_377_AA01)

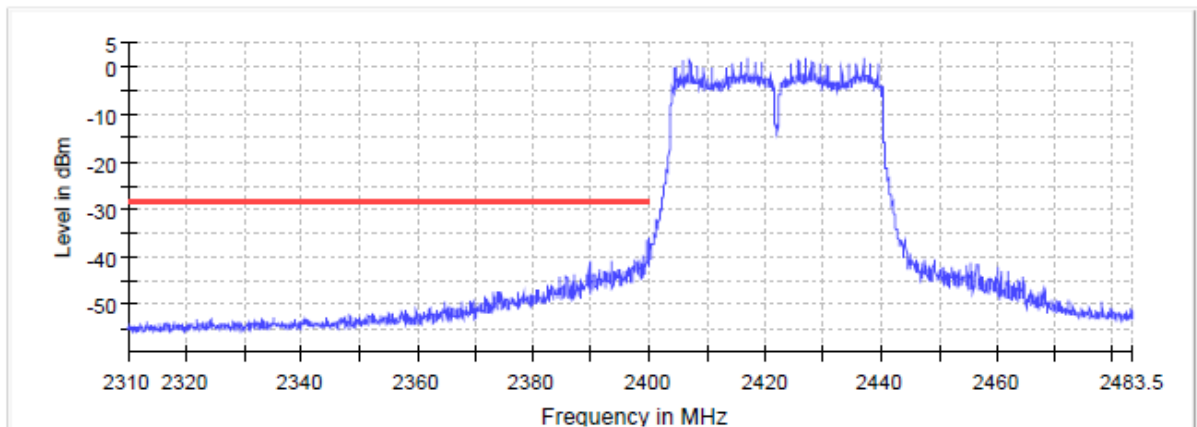

— Limit × Fail — Sum Level

Radio Technology = WLAN n 40 MHz MIMO, Operating Frequency = high, Band Edge = high
(S01_377_AA01)

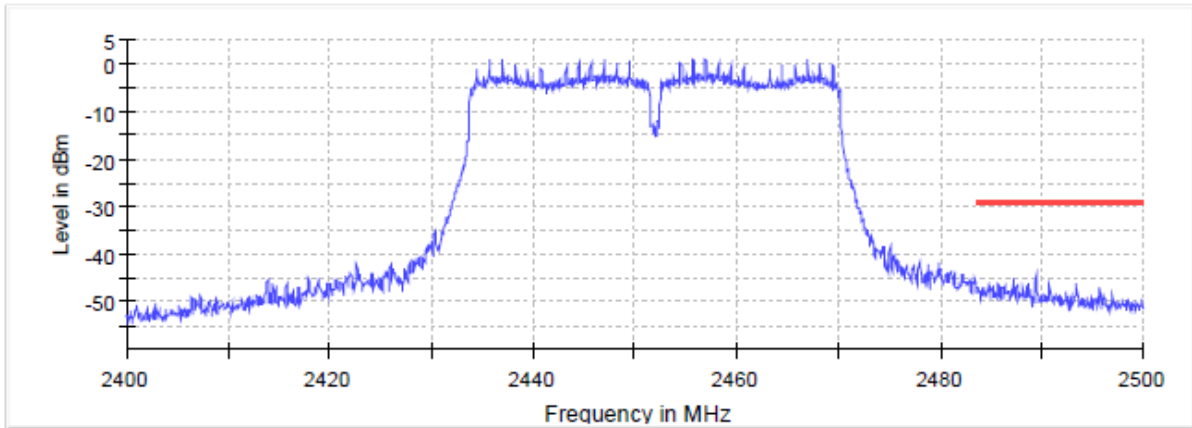

Radio Technology = WLAN ax 20 MHz MIMO, Operating Frequency = low, Band Edge = low
(S01_377_AA01)

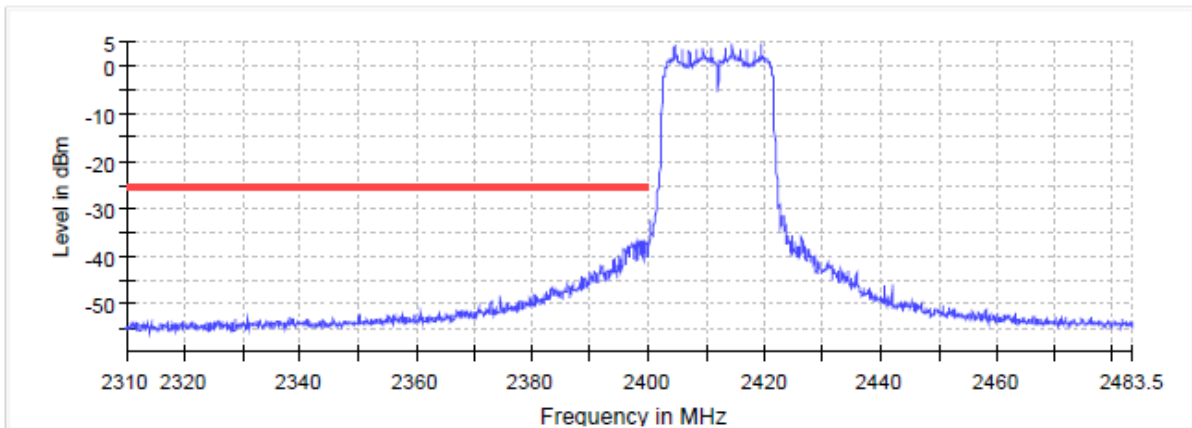

Radio Technology = WLAN ax 20 MHz MIMO, Operating Frequency = high, Band Edge = high
(S01_377_AA01)

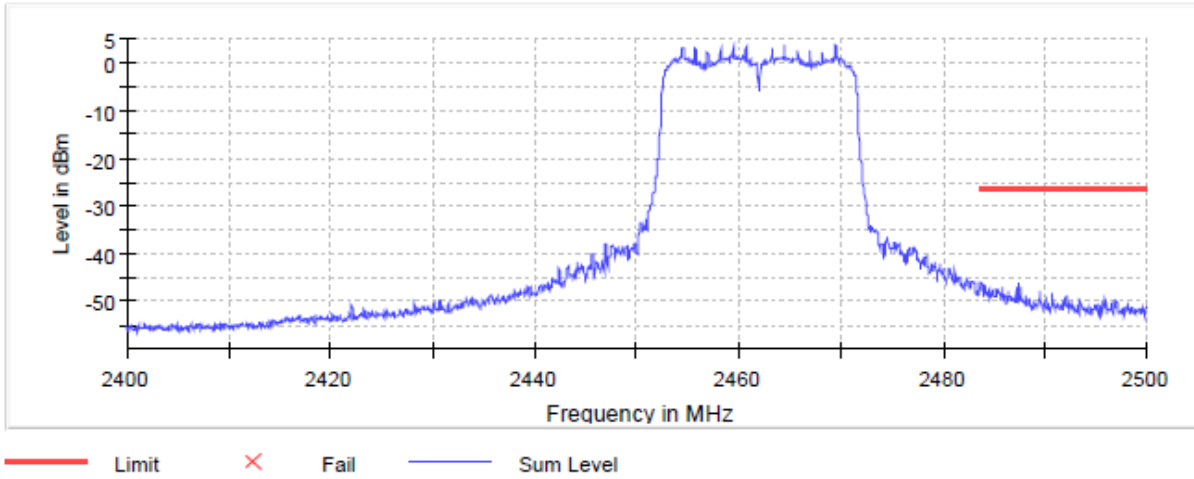

Radio Technology = WLAN ax 40 MHz MIMO, Operating Frequency = low, Band Edge = low
(S01_377_AA01)

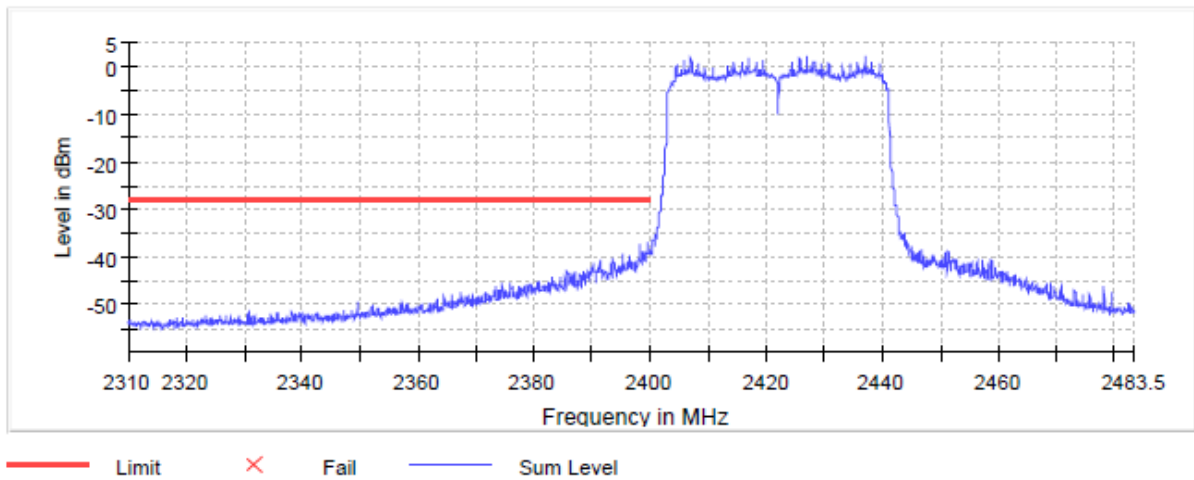

Radio Technology = WLAN ax 40 MHz MIMO, Operating Frequency = high, Band Edge = high
(S01_377_AA01)

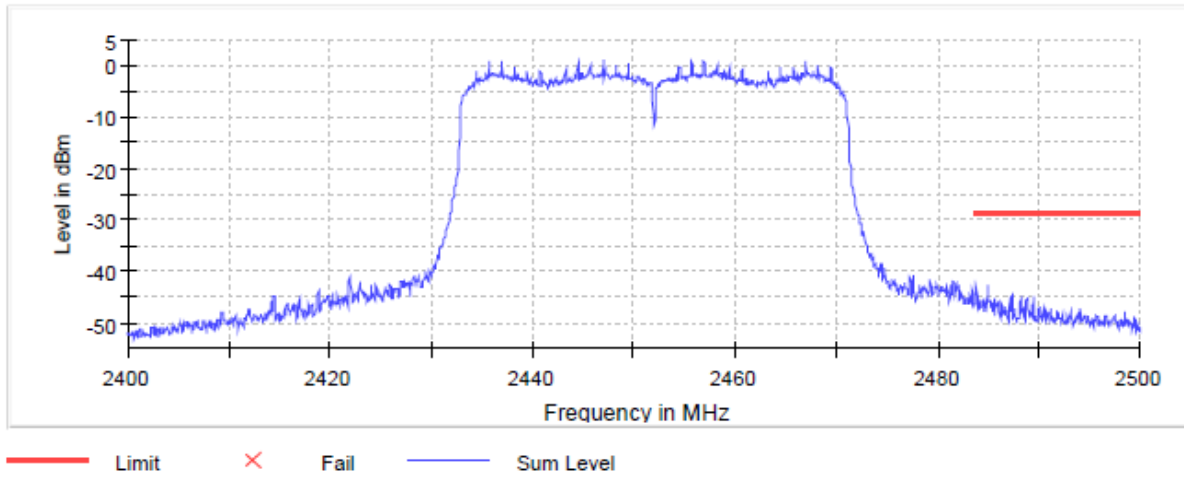

5.7.5 TEST EQUIPMENT USED

- R&S TS8997

5.8 BAND EDGE COMPLIANCE RADIATED

Standard **FCC Part 15 Subpart C**

The test was performed according to:
ANSI C63.10

5.8.1 TEST DESCRIPTION

Radiated Measurement with 50 Ohm termination at antenna ports

The test set-up was made in accordance to the general provisions of ANSI C63.10 in a typical installation configuration. The measurements were performed according the following sub-chapter of ANSI C63.10:

- Chapter 6.10.5

The Equipment Under Test (EUT) was set up on a non-conductive support (tilt device) at 1.5 m height in the fully-anechoic chamber.

All steps were performed with one height (1.5 m) of the receiving antenna only (procedure according ANSI C63.10, chapter 6.6.5).

3. Measurement above 1 GHz

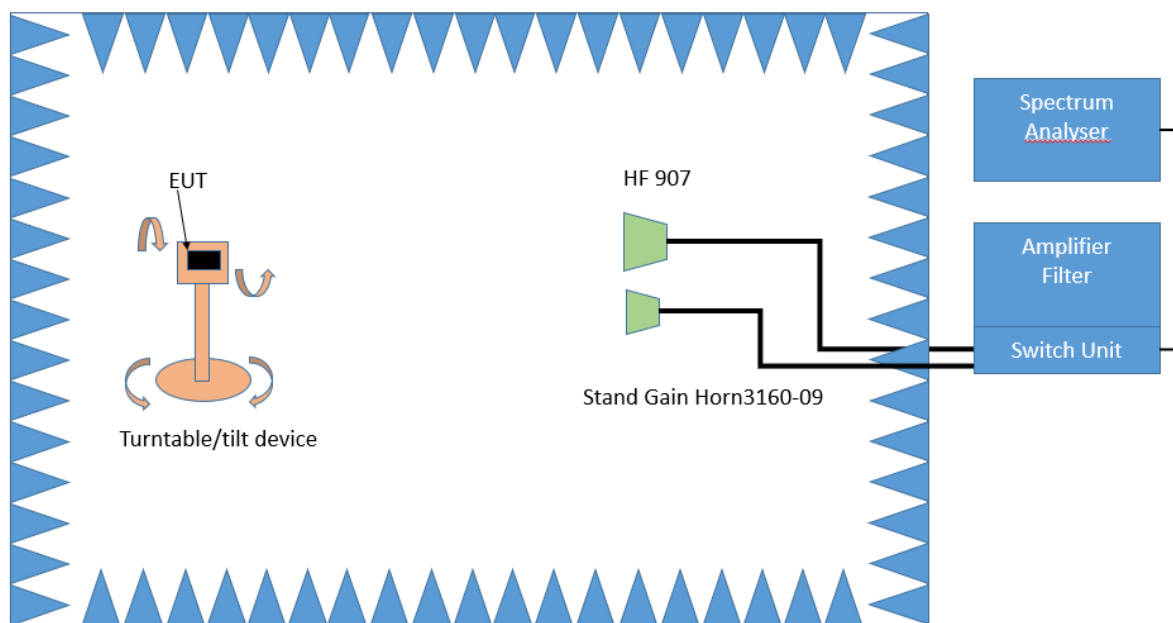

Test Setup; Spurious Emission Radiated (FAC), 1 GHz-26.5 GHz

Step 1:

The EUT is turned during the preliminary measurement across the elevation axis, with a step size of 90 °.

The turn table step size (azimuth angle) for the preliminary measurement is 45 °.

Spectrum analyser settings:

- Detector: Peak, Average
- RBW = 1 MHz
- VBW = 3 MHz

Step 2:

The turn table azimuth will slowly vary by $\pm 22.5^\circ$.
 The elevation angle will slowly vary by $\pm 45^\circ$
 Spectrum analyser settings:
 - Detector: Peak

Step 3:

Spectrum analyser settings for step 3:
 - Detector: Peak / CISPR Average
 - Measured frequencies: in step 1 determined frequencies
 - RBW = 1 MHz
 - VBW = 3 MHz
 - Measuring time: 1 s

Conducted Measurements at antenna ports

The Equipment Under Test (EUT) was set up to perform the spurious emissions measurements.

The EUT was connected to the test system as described in the block diagram below. The complete attenuation of the measurement path is known and considered.

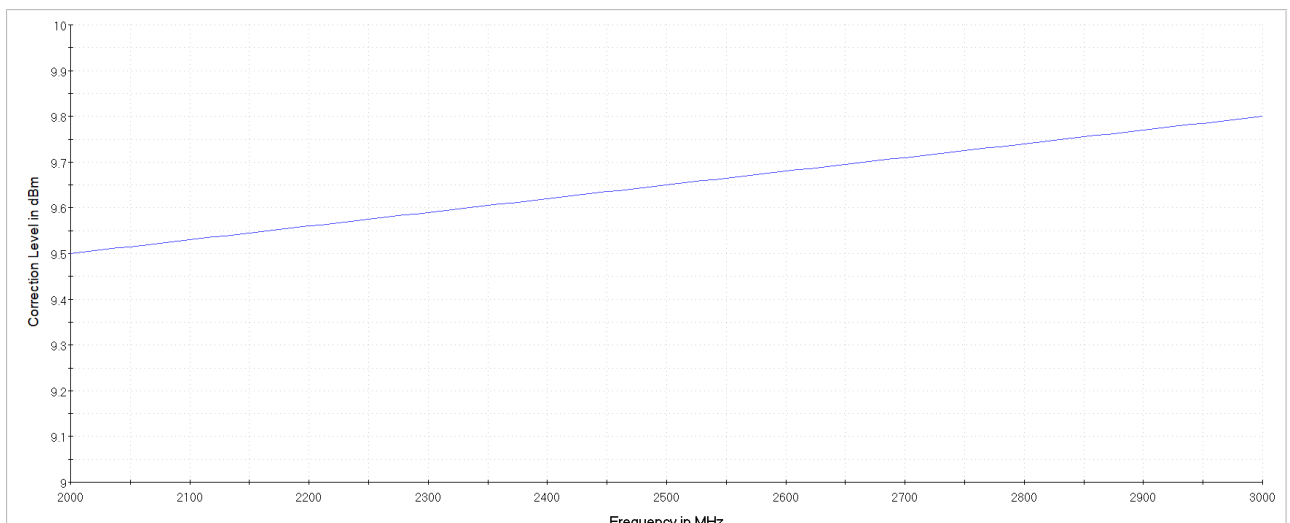
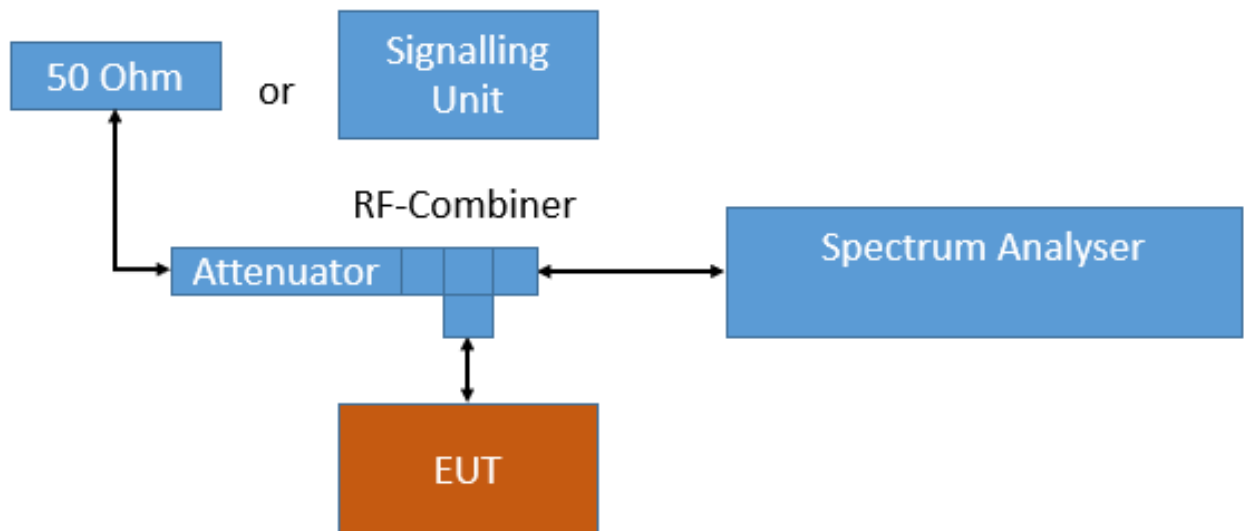

Analyser settings:

- Frequency range: 2350 – 2500 MHz
- Resolution Bandwidth (RBW): 1000 kHz
- Video Bandwidth (VBW): 3000 kHz
- Trace: Maxhold, Average Power
- Sweeps: 10000
- Sweep Time: coupled
- Detector: Peak, RMS

For the conducted emissions in restricted bands the Value is measured in dBm and then converted to dB μ V/m as given in KDB 558074:

1. Measure the conducted output power in dBm.
2. Add the maximum antenna gain in dBi. (Included in measurement result by offset)
3. Add the appropriate ground reflection factor (0 for measured range)
 - 6 dB for frequencies \leq 30 MHz;
 - 4.7 dB for frequencies between 30 MHz and 1000 MHz, inclusive; and
 - 0 dB for frequencies $>$ 1000 MHz).
4. Convert the resultant EIRP level to an equivalent electric field strength level using the following relationship:

$$E = \text{EIRP} - 20 \log D + 104.8$$
 Where E is the electric field strength in dB μ V/m,
 EIRP is the equivalent isotropically radiated power in dBm
 D is the specified measurement distance in m

Value [dB μ V/m] = Measured value [dBm] (including gain and ground reflection factor) – 20 log D + 104.8

5.8.2 TEST REQUIREMENTS / LIMITS

For band edges connected to a restricted band, the limits are specified in Section 15.209(a)

FCC Part 15, Subpart C, §15.209, Radiated Emission Limits

Frequency in MHz	Limit (μ V/m)	Measurement distance (m)	Limits (dB μ V/m)
0.009 – 0.49	2400/F(kHz)@300m	3	(48.5 – 13.8)@300m
0.49 – 1.705	24000/F(kHz)@30m	3	(33.8 – 23.0)@30m
1.705 – 30	30@30m	3	29.5@30m

The measured values are corrected with an inverse linear distance extrapolation factor (40 dB/decade) according FCC 15.31 (2).

Frequency in MHz	Limit (μ V/m)	Measurement distance (m)	Limits (dB μ V/m)
30 – 88	100@3m	3	40.0@3m
88 – 216	150@3m	3	43.5@3m
216 – 960	200@3m	3	46.0@3m
960 – 26000	500@3m	3	54.0@3m
26000 – 40000	500@3m	1	54.0@3m

The measured values above 26 GHz are corrected with an inverse linear distance extrapolation factor (20 dB/decade).

§15.35(b) ..., there is also a limit on the radio frequency emissions, as measured using instrumentation with a peak detector function, corresponding to 20 dB above the maximum permitted average limit....

Used conversion factor: Limit (dBµV/m) = 20 log (Limit (µV/m)/1µV/m)

5.8.3 TEST PROTOCOL

Ambient temperature: 24 -30 °C
 Air Pressure: 990 - 1020 hPa
 Humidity: 30 -40 %
 BT GFSK (1-DH1)
 Applied duty cycle correction (AV): 10.3 dB

Variant / Test Method	Ch. Center Freq. [MHz]	Band Edge Freq. [MHz]	Spurious Level [dBµV/m]	Detector	RBW [kHz]	Limit [dBµV/m]	Margin to Limit [dB]
374 / Radiated	2480	2483.5	48.5	PEAK	1000	74.0	25.5
374 / Radiated	2480	2483.5	45.2	AV	1000	54.0	8.8
374 / Conducted	2480	2483.5	57.6	PEAK	1000	74.0	16.5
374 / Conducted	2480	2483.5	49.0	AV	1000	54.0	5.0
377 / Radiated	2480	2483.5	48.2	PEAK	1000	74.0	25.8
377 / Radiated	2480	2483.5	37.1	AV	1000	54.0	19.2
377 / Conducted	2402	2390.0	48.9	PEAK	1000	74.0	25.8
377 / Conducted	2402	2390.0	39.2	AV	1000	54.0	19.2
377 / Conducted	2480	2483.5	56.2	PEAK	1000	74.0	25.8
377 / Conducted	2480	2483.5	45.6	AV	1000	54.0	19.2

BT π/4 DQPSK (2-DH1)
 Applied duty cycle correction (AV): 10.2 dB

Variant / Test Method	Ch. Center Freq. [MHz]	Band Edge Freq. [MHz]	Spurious Level [dBµV/m]	Detector	RBW [kHz]	Limit [dBµV/m]	Margin to Limit [dB]
374 / Radiated	2480	2483.5	47.7	PEAK	1000	74.0	26.3
374 / Radiated	2480	2483.5	44.9	AV	1000	54.0	9.1
374 / Conducted	2480	2483.5	67.0	PEAK	1000	74.0	7.0
374 / Conducted	2480	2483.5	50.3	AV	1000	54.0	3.7
377 / Conducted	2402	2390.0	51.7	PEAK	1000	74.0	22.3
377 / Conducted	2402	2390.0	38.3	AV	1000	54.0	15.7
377 / Conducted	2480	2483.5	67.9	PEAK	1000	74.0	6.1
377 / Conducted	2480	2483.5	44.7	AV	1000	54.0	9.3

BT 8-DPSK (3-DH1)
 Applied duty cycle correction (AV): 10.3 dB

Variant / Test Method	Ch. Center Freq. [MHz]	Band Edge Freq. [MHz]	Spurious Level [dBµV/m]	Detector	RBW [kHz]	Limit [dBµV/m]	Margin to Limit [dB]
374 / Radiated	2480	2483.5	54.0	PEAK	1000	74.0	20.0
374 / Radiated	2480	2483.5	45.0	AV	1000	54.0	9.0
374 / Conducted	2480	2483.5	66.8	PEAK	1000	74.0	7.2
374 / Conducted	2480	2483.5	50.3	AV	1000	54.0	3.7
377 / Conducted	2402	2390.0	51.6	PEAK	1000	74.0	22.4
377 / Conducted	2402	2390.0	38.3	AV	1000	54.0	15.7
377 / Conducted	2480	2483.5	68.3	PEAK	1000	74.0	5.7
377 / Conducted	2480	2483.5	45.8	AV	1000	54.0	8.2

BT LE 1 Mbit/s

Applied duty cycle correction (AV): 4.2 dB

Variant / Test Method	Ch. Center Freq. [MHz]	Band Edge Freq. [MHz]	Spurious Level [dBµV/m]	Detector	RBW [kHz]	Limit [dBµV/m]	Margin to Limit [dB]
374 / Conducted	2480	2483.5	50.6	PEAK	1000	74.0	23.4
374 / Conducted	2480	2483.5	42.2	AV	1000	54.0	11.8
377 / Radiated	2480	2483.5	47.6	PEAK	1000	74.0	26.4
377 / Radiated	2480	2483.5	39.0	AV	1000	54.0	15.0
377 / Conducted	2402	2390.0	50.2	PEAK	1000	74.0	23.8
377 / Conducted	2402	2390.0	36.6	AV	1000	54.0	17.4
377 / Conducted	2480	2483.5	53.9	PEAK	1000	74.0	20.1
377 / Conducted	2480	2483.5	42.3	AV	1000	54.0	11.7

BT LE 2 Mbit/s

Applied duty cycle correction (AV): 9.7 dB

Variant / Test Method	Ch. Center Freq. [MHz]	Band Edge Freq. [MHz]	Spurious Level [dBµV/m]	Detector	RBW [kHz]	Limit [dBµV/m]	Margin to Limit [dB]
374 / Radiated	2480	2483.5	47.7	PEAK	1000	74.0	26.3
374 / Radiated	2480	2483.5	44.4	AV	1000	54.0	9.6
374 / Conducted	2480	2483.5	54.3	PEAK	1000	74.0	19.7
374 / Conducted	2480	2483.5	51.0	AV	1000	54.0	3.0
377 / Conducted	2402	2390.0	50.3	PEAK	1000	74.0	23.7
377 / Conducted	2402	2390.0	41.0	AV	1000	54.0	13.0
377 / Conducted	2480	2483.5	57.9	PEAK	1000	74.0	16.1
377 / Conducted	2480	2483.5	51.9	AV	1000	54.0	2.1

Ambient temperature:

23 - 30 °C

Air Pressure:

990 - 1017 hPa

Humidity:

34 - 40%

WLAN b-Mode; 20 MHz; 1 Mbit/s

Applied duty cycle correction (AV): 0 dB

Variant / Test Method	Ch. Center Freq. [MHz]	Band Edge Freq. [MHz]	Spurious Level [dBµV/m]	Detector	RBW [kHz]	Limit [dBµV/m]	Margin to Limit [dB]
374 / Radiated	2462	2483.5	48.5	PEAK	1000	74.0	25.5
374 / Radiated	2462	2483.5	34.9	AV	1000	54.0	19.1
374 / Conducted	2412	2390.0	52.2	PEAK	1000	74.0	21.8
374 / Conducted	2412	2390.0	44.9	AV	1000	54.0	9.1
374 / Conducted	2417	2390.0	52.2	PEAK	1000	74.0	21.8
374 / Conducted	2417	2390.0	44.9	AV	1000	54.0	9.1
374 / Conducted	2457	2483.5	57.5	PEAK	1000	74.0	16.5
374 / Conducted	2457	2483.5	51.7	AV	1000	54.0	2.3
374 / Conducted	2462	2483.5	53.4	PEAK	1000	74.0	20.6
374 / Conducted	2462	2483.5	46.9	AV	1000	54.0	7.1
377 / Radiated	2462	2483.5	47.6	PEAK	1000	74.0	26.4
377 / Radiated	2462	2483.5	34.8	AV	1000	54.0	19.2
377 / Conducted	2412	2390.0	55.8	PEAK	1000	74.0	18.2
377 / Conducted	2412	2390.0	49.7	AV	1000	54.0	4.3
377 / Conducted	2417	2390.0	57.1	PEAK	1000	74.0	16.9
377 / Conducted	2417	2390.0	50.4	AV	1000	54.0	3.6
377 / Conducted	2457	2483.5	58.2	PEAK	1000	74.0	15.8
377 / Conducted	2457	2483.5	51.7	AV	1000	54.0	2.3
377 / Conducted	2462	2483.5	55.7	PEAK	1000	74.0	18.3
377 / Conducted	2462	2483.5	50.5	AV	1000	54.0	3.5

WLAN g-Mode; 20 MHz; 6 Mbit/s
Applied duty cycle correction (AV): 0.1 dB

Variant / Test Method	Ch. Center Freq. [MHz]	Band Edge Freq. [MHz]	Spurious Level [dBμV/m]	Detector	RBW [kHz]	Limit [dBμV/m]	Margin to Limit [dB]
377 / Radiated	2462	2483.5	47.6	PEAK	1000	74.0	26.4
377 / Radiated	2462	2483.5	34.8	AV	1000	54.0	19.2
377 / Conducted	2412	2483.5	71.1	PEAK	1000	74.0	2.9
377 / Conducted	2412	2483.5	48.0	AV	1000	54.0	6.0
377 / Conducted	2417	2483.5	70.1	PEAK	1000	74.0	3.9
377 / Conducted	2417	2483.5	51.8	AV	1000	54.0	2.2
377 / Conducted	2422	2483.5	71.8	PEAK	1000	74.0	2.2
377 / Conducted	2422	2483.5	51.1	AV	1000	54.0	2.9
377 / Conducted	2427	2483.5	71.2	PEAK	1000	74.0	2.8
377 / Conducted	2427	2483.5	52.2	AV	1000	54.0	1.8
377 / Conducted	2447	2483.5	70.9	PEAK	1000	74.0	3.1
377 / Conducted	2447	2483.5	51.6	AV	1000	54.0	2.4
377 / Conducted	2452	2483.5	71.8	PEAK	1000	74.0	2.2
377 / Conducted	2452	2483.5	51.6	AV	1000	54.0	2.4
377 / Conducted	2457	2483.5	69.7	PEAK	1000	74.0	4.3
377 / Conducted	2457	2483.5	50.2	AV	1000	54.0	3.8
377 / Conducted	2462	2483.5	70.3	PEAK	1000	74.0	3.7
377 / Conducted	2462	2483.5	45.4	AV	1000	54.0	8.6

WLAN n-Mode; 20 MHz; MCS0
Applied duty cycle correction (AV): 0 dB

Variant / Test Method	Ch. Center Freq. [MHz]	Band Edge Freq. [MHz]	Spurious Level [dBμV/m]	Detector	RBW [kHz]	Limit [dBμV/m]	Margin to Limit [dB]
377 / Radiated	2462	2483.5	47.6	PEAK	1000	74.0	26.4
377 / Radiated	2462	2483.5	34.7	AV	1000	54.0	19.3
377 / Conducted	2412	2483.5	71.4	PEAK	1000	74.0	2.6
377 / Conducted	2412	2483.5	48.5	AV	1000	54.0	5.5
377 / Conducted	2417	2483.5	70.7	PEAK	1000	74.0	3.3
377 / Conducted	2417	2483.5	48.9	AV	1000	54.0	5.1
377 / Conducted	2422	2483.5	71.4	PEAK	1000	74.0	2.6
377 / Conducted	2422	2483.5	49.2	AV	1000	54.0	4.8
377 / Conducted	2427	2483.5	73.5	PEAK	1000	74.0	0.5
377 / Conducted	2427	2483.5	49.6	AV	1000	54.0	4.4
377 / Conducted	2447	2483.5	71.9	PEAK	1000	74.0	2.1
377 / Conducted	2447	2483.5	49.9	AV	1000	54.0	4.1
377 / Conducted	2452	2483.5	70.8	PEAK	1000	74.0	3.2
377 / Conducted	2452	2483.5	49.9	AV	1000	54.0	4.1
377 / Conducted	2457	2483.5	71.7	PEAK	1000	74.0	2.3
377 / Conducted	2457	2483.5	47.7	AV	1000	54.0	6.3
377 / Conducted	2462	2483.5	69.9	PEAK	1000	74.0	4.1
377 / Conducted	2462	2483.5	47.5	AV	1000	54.0	6.5

WLAN n-Mode; 40 MHz; MCS0
Applied duty cycle correction (AV): 0 dB

Variant / Test Method	Ch. Center Freq. [MHz]	Band Edge Freq. [MHz]	Spurious Level [dBμV/m]	Detector	RBW [kHz]	Limit [dBμV/m]	Margin to Limit [dB]
377 / Radiated	2452	2483.5	48.0	PEAK	1000	74.0	26.0
377 / Radiated	2452	2483.5	34.7	AV	1000	54.0	19.3
377 / Conducted	2422	2483.5	71.1	PEAK	1000	74.0	2.9
377 / Conducted	2422	2483.5	48.0	AV	1000	54.0	6.0
377 / Conducted	2447	2483.5	72.1	PEAK	1000	74.0	1.9
377 / Conducted	2447	2483.5	48.1	AV	1000	54.0	5.9
377 / Conducted	2452	2483.5	71.2	PEAK	1000	74.0	2.8
377 / Conducted	2452	2483.5	46.5	AV	1000	54.0	7.5

WLAN ax-Mode; 20 MHz; MCS0
 Applied duty cycle correction (AV): 0.1 dB

Variant / Test Method	Ch. Center Freq. [MHz]	Band Edge Freq. [MHz]	Spurious Level [dB μ V/m]	Detector	RBW [kHz]	Limit [dB μ V/m]	Margin to Limit [dB]
377 / Conducted	2412	2483.5	67.7	PEAK	1000	74.0	6.3
377 / Conducted	2412	2483.5	48.3	AV	1000	54.0	5.7
377 / Conducted	2417	2483.5	72.0	PEAK	1000	74.0	2.0
377 / Conducted	2417	2483.5	50.6	AV	1000	54.0	3.4
377 / Conducted	2422	2483.5	69.7	PEAK	1000	74.0	4.3
377 / Conducted	2422	2483.5	47.9	AV	1000	54.0	6.1
377 / Conducted	2427	2483.5	71.2	PEAK	1000	74.0	2.8
377 / Conducted	2427	2483.5	48.8	AV	1000	54.0	5.2
377 / Conducted	2432	2483.5	72.8	PEAK	1000	74.0	1.2
377 / Conducted	2432	2483.5	48.8	AV	1000	54.0	5.2
377 / Conducted	2447	2483.5	72.1	PEAK	1000	74.0	1.9
377 / Conducted	2447	2483.5	51.9	AV	1000	54.0	2.1
377 / Conducted	2452	2483.5	72.7	PEAK	1000	74.0	1.3
377 / Conducted	2452	2483.5	52.0	AV	1000	54.0	2.0
377 / Conducted	2457	2483.5	72.9	PEAK	1000	74.0	1.1
377 / Conducted	2457	2483.5	49.3	AV	1000	54.0	4.7
377 / Conducted	2462	2483.5	68.8	PEAK	1000	74.0	5.2
377 / Conducted	2462	2483.5	46.7	AV	1000	54.0	7.3

WLAN ax-Mode; 40 MHz; MCS0
 Applied duty cycle correction (AV): 0 dB

Variant / Test Method	Ch. Center Freq. [MHz]	Band Edge Freq. [MHz]	Spurious Level [dB μ V/m]	Detector	RBW [kHz]	Limit [dB μ V/m]	Margin to Limit [dB]
377 / Conducted	2422	2483.5	-24.3	PEAK	1000	74.0	98.3
377 / Conducted	2422	2483.5	-47.6	AV	1000	54.0	101.6
377 / Conducted	2437	2483.5	-24.8	PEAK	1000	74.0	98.8
377 / Conducted	2437	2483.5	-49.7	AV	1000	54.0	103.7
377 / Conducted	2452	2483.5	-26.9	PEAK	1000	74.0	100.9
377 / Conducted	2452	2483.5	-49.0	AV	1000	54.0	103.0

WLAN n-Mode; 20 MHz; MCS0; MIMO
 Applied duty cycle correction (AV): 0 dB

Variant / Test Method	Ch. Center Freq. [MHz]	Band Edge Freq. [MHz]	Spurious Level [dB μ V/m]	Detector	RBW [kHz]	Limit [dB μ V/m]	Margin to Limit [dB]
377 / Radiated	2462	2483.5	48.4	PEAK	1000	74.0	25.6
377 / Radiated	2462	2483.5	34.8	AV	1000	54.0	19.2
377 / Conducted	2412	2483.5	70.2	PEAK	1000	74.0	3.8
377 / Conducted	2412	2483.5	48.6	AV	1000	54.0	5.4
377 / Conducted	2417	2483.5	70.8	PEAK	1000	74.0	3.2
377 / Conducted	2417	2483.5	49.3	AV	1000	54.0	4.7
377 / Conducted	2422	2483.5	68.4	PEAK	1000	74.0	5.6
377 / Conducted	2422	2483.5	49.9	AV	1000	54.0	4.1
377 / Conducted	2452	2483.5	71.3	PEAK	1000	74.0	2.7
377 / Conducted	2452	2483.5	49.5	AV	1000	54.0	4.5
377 / Conducted	2457	2483.5	70.6	PEAK	1000	74.0	3.4
377 / Conducted	2457	2483.5	46.8	AV	1000	54.0	7.2
377 / Conducted	2462	2483.5	69.6	PEAK	1000	74.0	4.4
377 / Conducted	2462	2483.5	47.5	AV	1000	54.0	6.5

WLAN n-Mode; 40 MHz; MCS0; MIMO
Applied duty cycle correction (AV): 0.1 dB

Variant / Test Method	Ch. Center Freq. [MHz]	Band Edge Freq. [MHz]	Spurious Level [dB μ V/m]	Detector	RBW [kHz]	Limit [dB μ V/m]	Margin to Limit [dB]
377 / Radiated	2452	2483.5	47.9	PEAK	1000	74.0	26.1
377 / Radiated	2452	2483.5	34.8	AV	1000	54.0	19.2
377 / Conducted	2422	2483.5	71.5	PEAK	1000	74.0	2.5
377 / Conducted	2422	2483.5	47.8	AV	1000	54.0	6.2
377 / Conducted	2447	2483.5	71.6	PEAK	1000	74.0	2.4
377 / Conducted	2447	2483.5	48.3	AV	1000	54.0	5.7
377 / Conducted	2452	2483.5	72.5	PEAK	1000	74.0	1.5
377 / Conducted	2452	2483.5	47.4	AV	1000	54.0	6.6

WLAN ax-Mode; 20 MHz; MCS0; MIMO
Applied duty cycle correction (AV): 0 dB

Variant / Test Method	Ch. Center Freq. [MHz]	Band Edge Freq. [MHz]	Spurious Level [dB μ V/m]	Detector	RBW [kHz]	Limit [dB μ V/m]	Margin to Limit [dB]
377 / Conducted	2412	2483.5	69.3	PEAK	1000	74.0	4.7
377 / Conducted	2412	2483.5	47.4	AV	1000	54.0	6.6
377 / Conducted	2417	2483.5	70.3	PEAK	1000	74.0	3.7
377 / Conducted	2417	2483.5	47.7	AV	1000	54.0	6.3
377 / Conducted	2422	2483.5	67.4	PEAK	1000	74.0	6.6
377 / Conducted	2422	2483.5	48.3	AV	1000	54.0	5.7
377 / Conducted	2427	2483.5	69.1	PEAK	1000	74.0	4.9
377 / Conducted	2427	2483.5	48.6	AV	1000	54.0	5.4
377 / Conducted	2432	2483.5	72.3	PEAK	1000	74.0	1.7
377 / Conducted	2432	2483.5	48.8	AV	1000	54.0	5.2
377 / Conducted	2447	2483.5	72.4	PEAK	1000	74.0	1.6
377 / Conducted	2447	2483.5	50.8	AV	1000	54.0	3.2
377 / Conducted	2452	2483.5	69.3	PEAK	1000	74.0	4.7
377 / Conducted	2452	2483.5	48.6	AV	1000	54.0	5.4
377 / Conducted	2457	2483.5	70.7	PEAK	1000	74.0	3.3
377 / Conducted	2457	2483.5	48.1	AV	1000	54.0	5.9
377 / Conducted	2462	2483.5	69.9	PEAK	1000	74.0	4.1
377 / Conducted	2462	2483.5	46.1	AV	1000	54.0	7.9

WLAN ax-Mode; 40 MHz; MCS0; MIMO
Applied duty cycle correction (AV): 0.1 dB

Variant / Test Method	Ch. Center Freq. [MHz]	Band Edge Freq. [MHz]	Spurious Level [dB μ V/m]	Detector	RBW [kHz]	Limit [dB μ V/m]	Margin to Limit [dB]
377 / Conducted	2422	2483.5	71.9	PEAK	1000	74.0	2.1
377 / Conducted	2422	2483.5	48.4	AV	1000	54.0	5.6
377 / Conducted	2437	2483.5	67.1	PEAK	1000	74.0	6.9
377 / Conducted	2437	2483.5	47.1	AV	1000	54.0	6.9
377 / Conducted	2452	2483.5	71.6	PEAK	1000	74.0	2.4
377 / Conducted	2452	2483.5	48.2	AV	1000	54.0	5.8

Remark: Please see next sub-clause for the measurement plot.

For conducted testing, WLAN SISO results in table above are worst case of both antennas. For radiated testing WLAN SISO results are transmission on Antenna A.

OFDMA with one active Resource Unit (worst case OFDMA):

WLAN ax-Mode; 20 MHz; MCS0; MIMO
 Applied duty cycle correction (AV): 0 dB

Variant / Test Method	Ch. Center Freq. [MHz]	Band Edge Freq. [MHz]	Spurious Level [dBμV/m]	Detector	RBW [kHz]	Limit [dBμV/m]	Margin to Limit [dB]
377 / Conducted	2412	2483.5	71.5	PEAK	1000	74.0	2.5
377 / Conducted	2412	2483.5	42.7	AV	1000	54.0	11.3
377 / Conducted	2462	2483.5	71.8	PEAK	1000	74.0	2.2
377 / Conducted	2462	2483.5	43.7	AV	1000	54.0	10.3

WLAN ax-Mode; 40 MHz; MCS0; MIMO
 Applied duty cycle correction (AV): 0.1 dB

Variant / Test Method	Ch. Center Freq. [MHz]	Band Edge Freq. [MHz]	Spurious Level [dBμV/m]	Detector	RBW [kHz]	Limit [dBμV/m]	Margin to Limit [dB]
377 / Conducted	2422	2483.5	71.7	PEAK	1000	74.0	2.3
377 / Conducted	2422	2483.5	41.1	AV	1000	54.0	12.9
377 / Conducted	2452	2483.5	73.6	PEAK	1000	74.0	0.4
377 / Conducted	2452	2483.5	41.6	AV	1000	54.0	12.4

Remark: Please see next sub-clause for the measurement plot.

5.8.4 MEASUREMENT PLOTS

Radio Technology = Bluetooth LE 2 Mbps, Operating Frequency = high, Band Edge = high (S01_374_BA01)

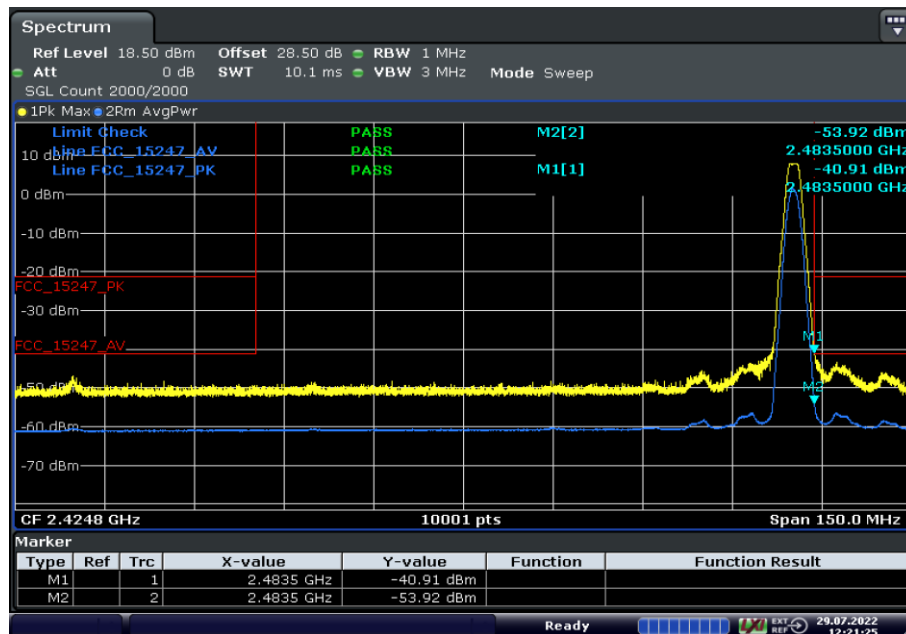

Date: 29.JUL.2022 12:21:25

Radio Technology = Bluetooth BDR, Operating Frequency = high, Band Edge = high
(S02_377_AB01)

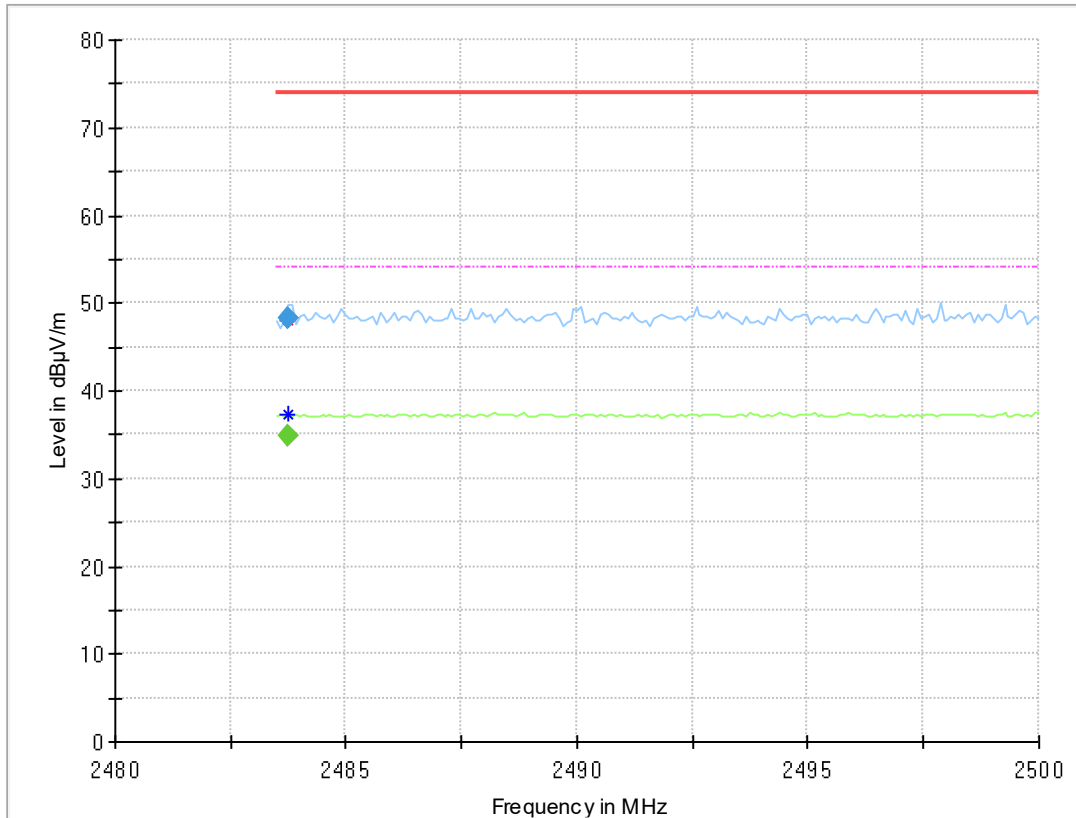

Final Result

Frequency (MHz)	MaxPeak (dBµV/m)	CAverage (dBµV/m)	Limit (dBµV/m)	Margin (dB)	Meas. Time (ms)	Bandwidth (kHz)	Height (cm)	Pol	Azimuth (deg)	Elevation (deg)	Corr. (dB/m)
2483.748	---	34.8	54.00	19.18	1000.0	1000.000	150.0	H	-19.0	105.0	5.3
2483.748	48.2	---	74.00	25.83	1000.0	1000.000	150.0	H	-19.0	105.0	5.3

Radio Technology = Bluetooth BDR, Operating Frequency = low + high, Band Edge = low + high
(S01_377_AE01)

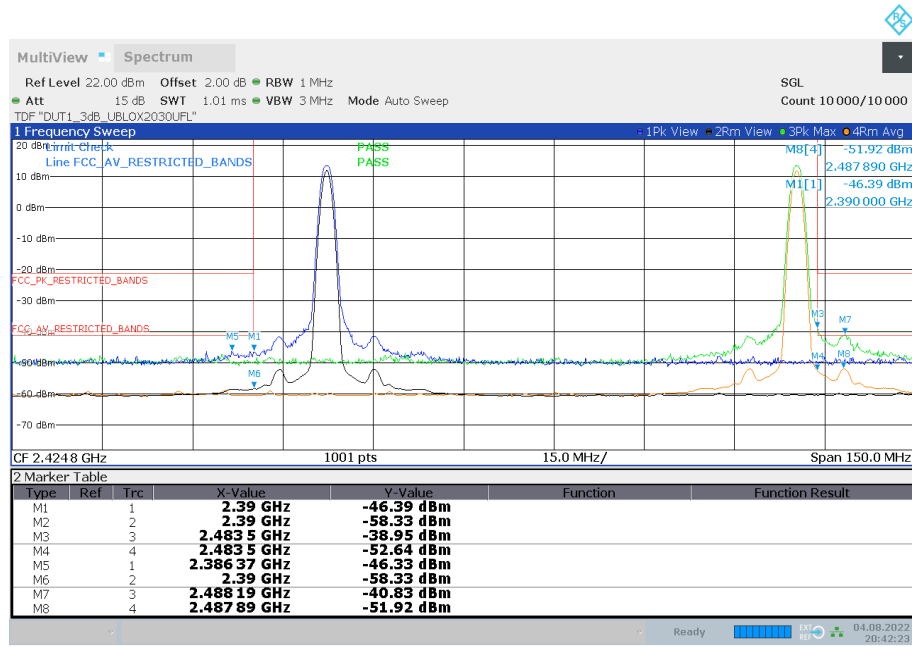

Radio Technology = Bluetooth BDR, Operating Frequency = high, Band Edge = high
(S02_374_BB01)

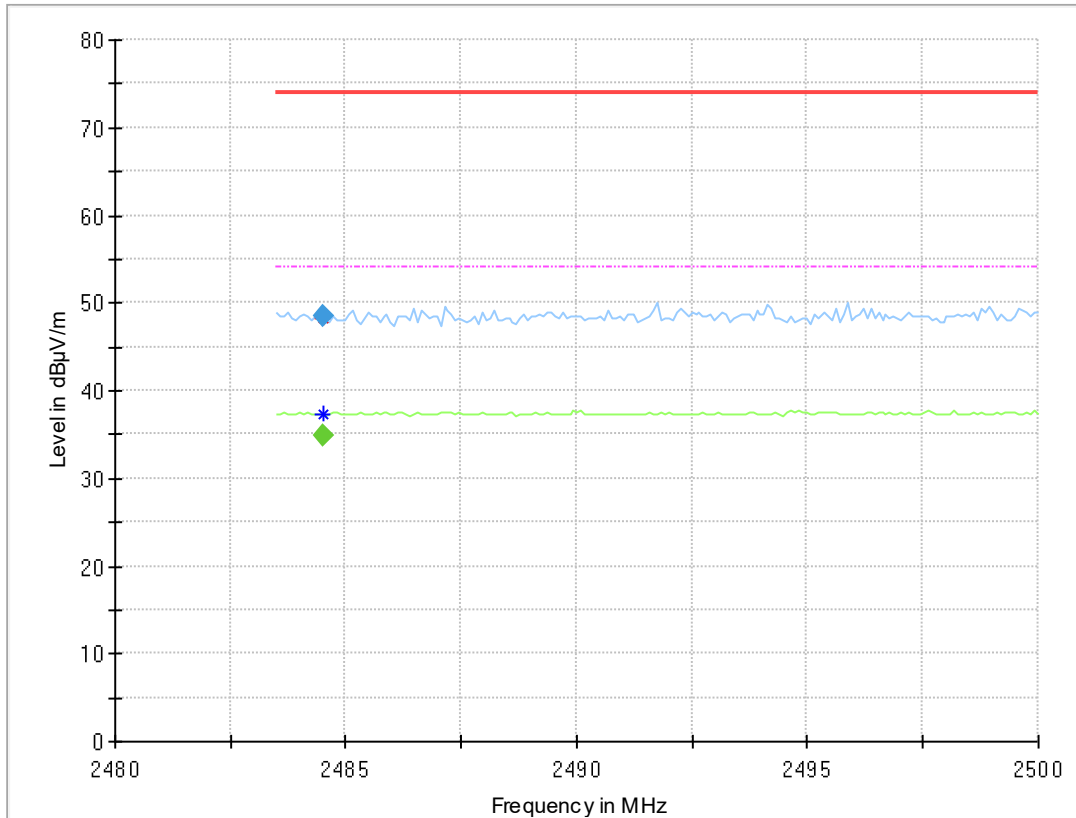

Final Result

Frequency (MHz)	MaxPeak (dBµV/m)	CAverage (dBµV/m)	Limit (dBµV/m)	Margin (dB)	Meas. Time (ms)	Bandwidth (kHz)	Height (cm)	Pol	Azimuth (deg)	Elevation (deg)	Corr. (dB/m)
2484.490	---	34.9	54.00	19.07	1000.0	1000.000	150.0	V	77.0	-11.0	5.3
2484.490	48.5	---	74.00	25.49	1000.0	1000.000	150.0	V	77.0	-11.0	5.3

Radio Technology = Bluetooth BDR, Operating Frequency = high, Band Edge = high
(S01_374_BA01)

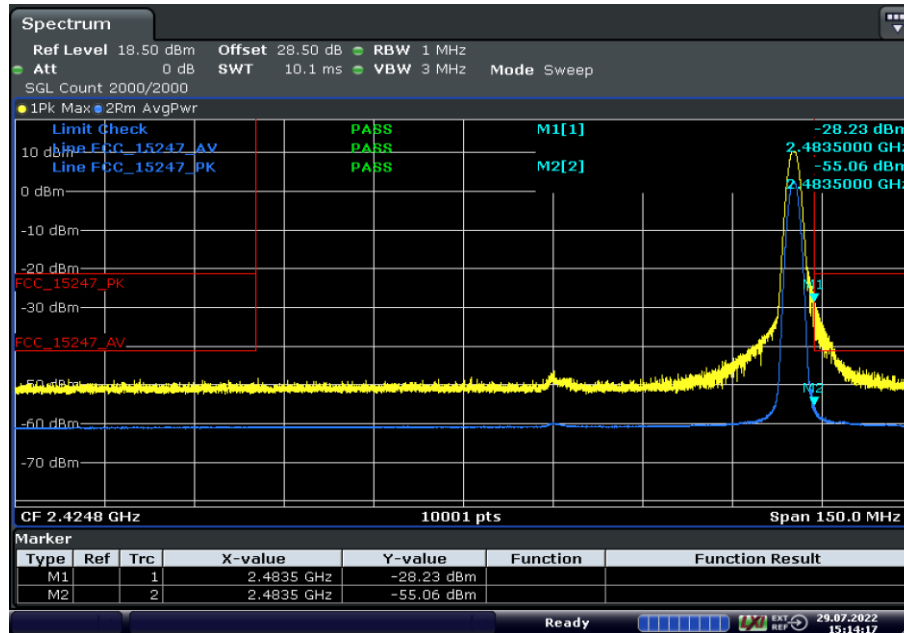

Date: 29.JUL.2022 15:14:17

Radio Technology = Bluetooth EDR 2, Operating Frequency = low + high, Band Edge = low + high
(S01_377_AE01)

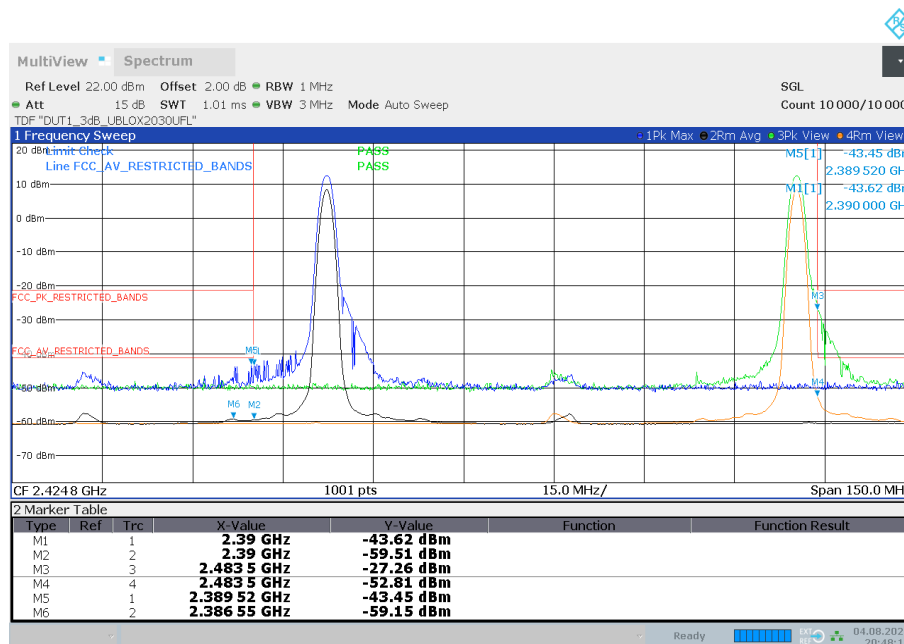

20:48:11 04.08.2022

Radio Technology = Bluetooth EDR 2, Operating Frequency = high, Band Edge = high
(S02_374_BB01)

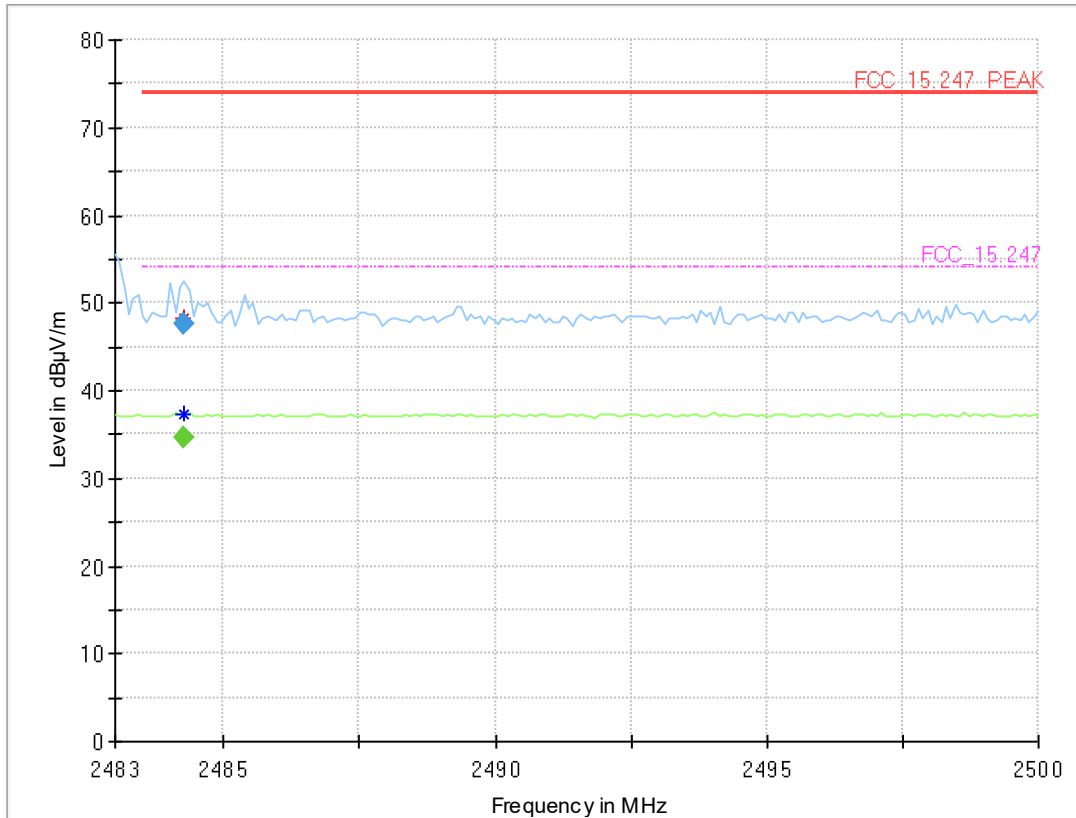

Final Result

Frequency (MHz)	MaxPeak (dBµV/m)	CAverage (dBµV/m)	Limit (dBµV/m)	Margin (dB)	Meas. Time (ms)	Bandwidth (kHz)	Height (cm)	Pol	Azimuth (deg)	Elevation (deg)	Corr. (dB/m)
2484.275	---	34.7	54.00	19.33	1000.0	1000.000	150.0	H	-124.0	15.0	5.3
2484.275	47.7	---	74.00	26.35	1000.0	1000.000	150.0	H	-124.0	15.0	5.3

Radio Technology = Bluetooth EDR 2, Operating Frequency = high, Band Edge = high (S01_374_BA01)

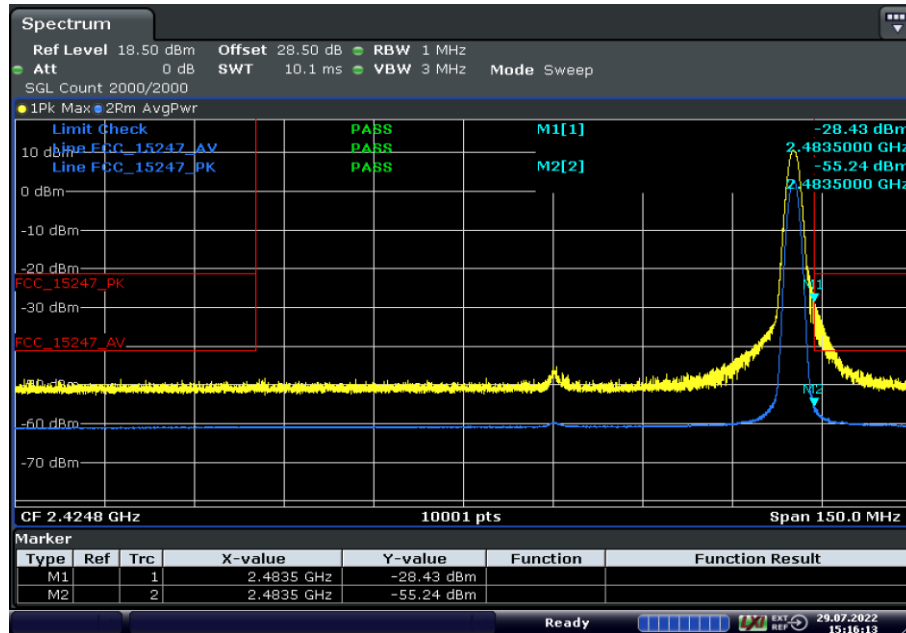

Date: 29.JUL.2022 15:16:13

Radio Technology = Bluetooth EDR 3, Operating Frequency = low + high, Band Edge = low + high (S01_377_AE01)

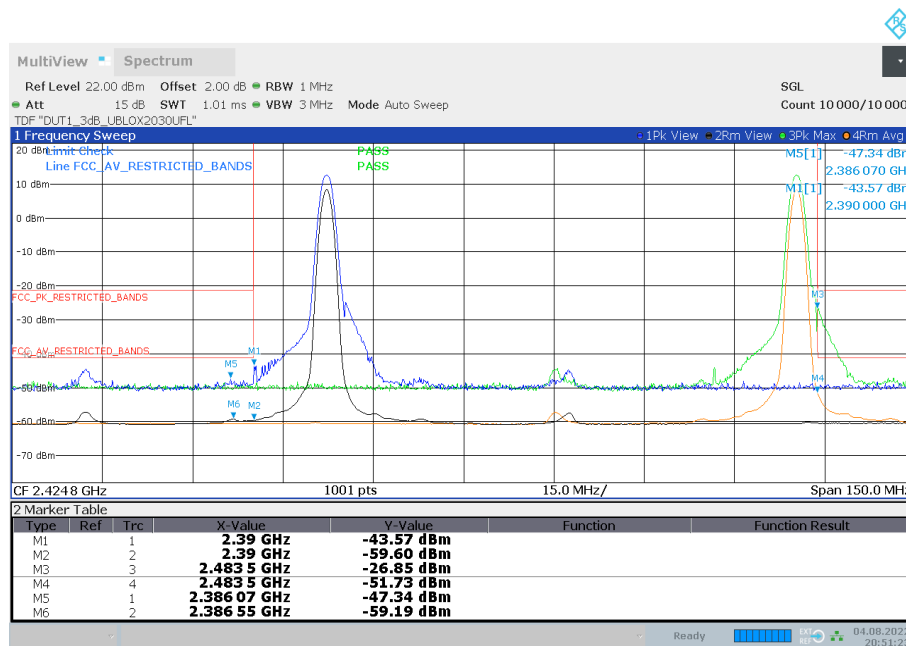

20:51:24 04.08.2022

Radio Technology = Bluetooth EDR 3, Operating Frequency = high, Band Edge = high
(S02_374_BB01)

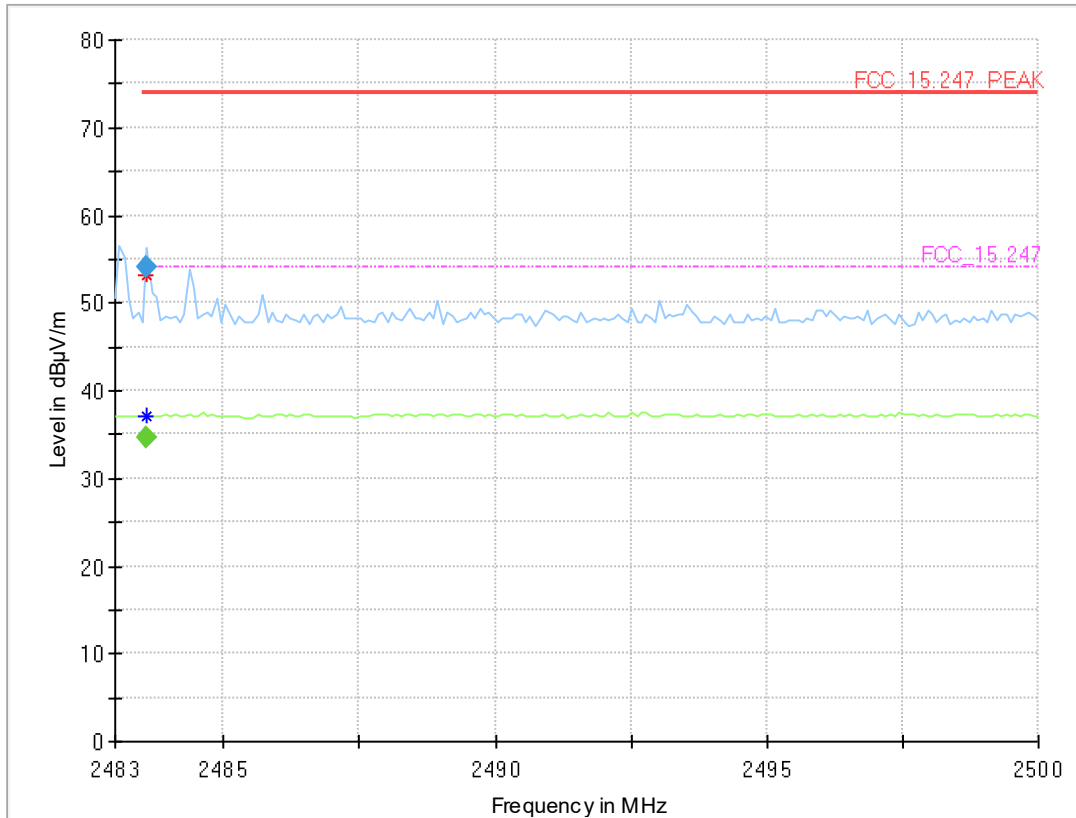

Final Result

Frequency (MHz)	MaxPeak (dBµV/m)	CAverage (dBµV/m)	Limit (dBµV/m)	Margin (dB)	Meas. Time (ms)	Bandwidth (kHz)	Height (cm)	Pol	Azimuth (deg)	Elevation (deg)	Corr. (dB/m)
2483.595	---	34.7	54.00	19.29	1000.0	1000.000	150.0	V	-130.0	-8.0	5.3
2483.595	54.0	---	74.00	20.00	1000.0	1000.000	150.0	V	-130.0	-8.0	5.3

Radio Technology = Bluetooth EDR 3, Operating Frequency = high, Band Edge = high
(S01_374_BA01)

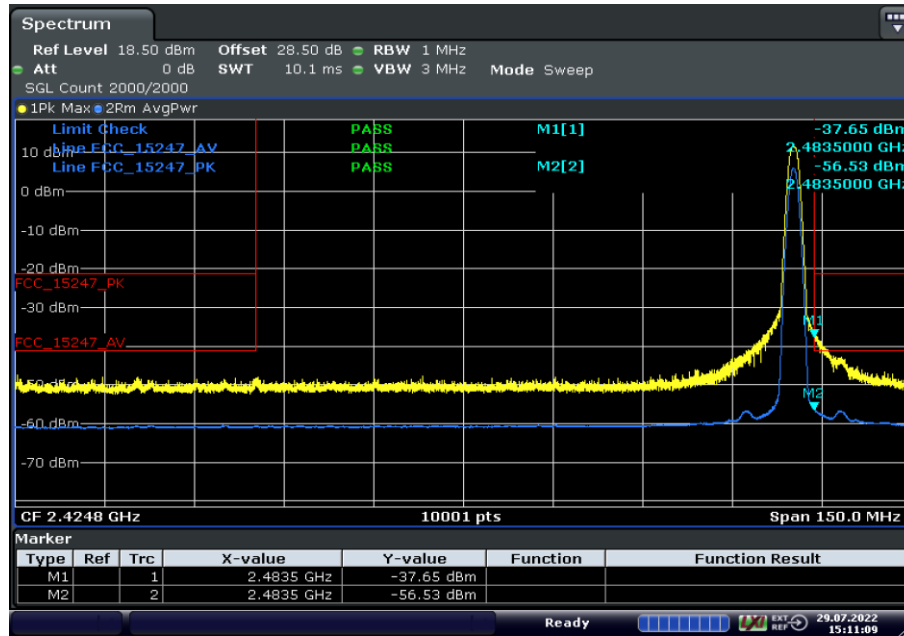

Date: 29.JUL.2022 15:11:09

Radio Technology = Bluetooth LE 1 Mbps, Operating Frequency = high, Band Edge = high (S02_377_AD01)

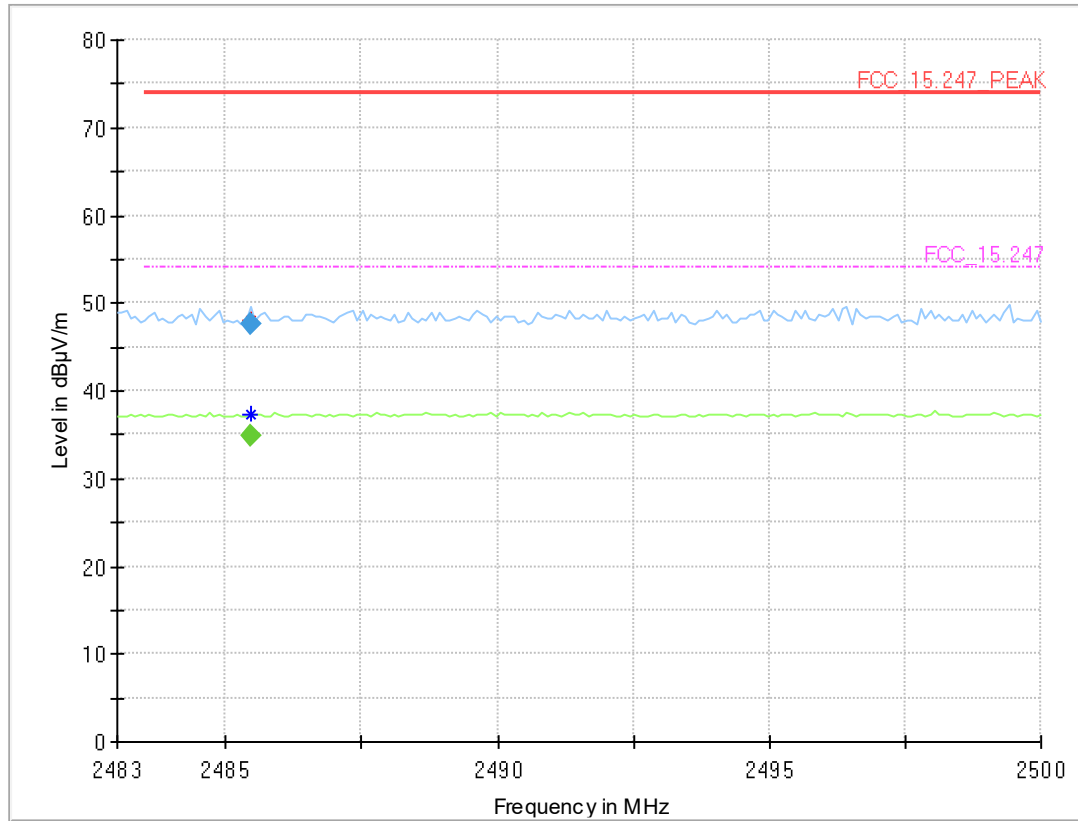

Final Result

Frequency (MHz)	MaxPeak (dBµV/m)	CAverage (dBµV/m)	Limit (dBµV/m)	Margin (dB)	Meas. Time (ms)	Bandwidth (kHz)	Height (cm)	Pol	Azimuth (deg)	Elevation (deg)	Corr. (dB/m)
2485.465	---	34.8	54.00	19.23	1000.0	1000.000	150.0	H	117.0	15.0	5.3
2485.465	47.6	---	74.00	26.45	1000.0	1000.000	150.0	H	117.0	15.0	5.3

Radio Technology = Bluetooth LE 1 Mbps, Operating Frequency = low + high, Band Edge = low + high
(S01_377_AA01)

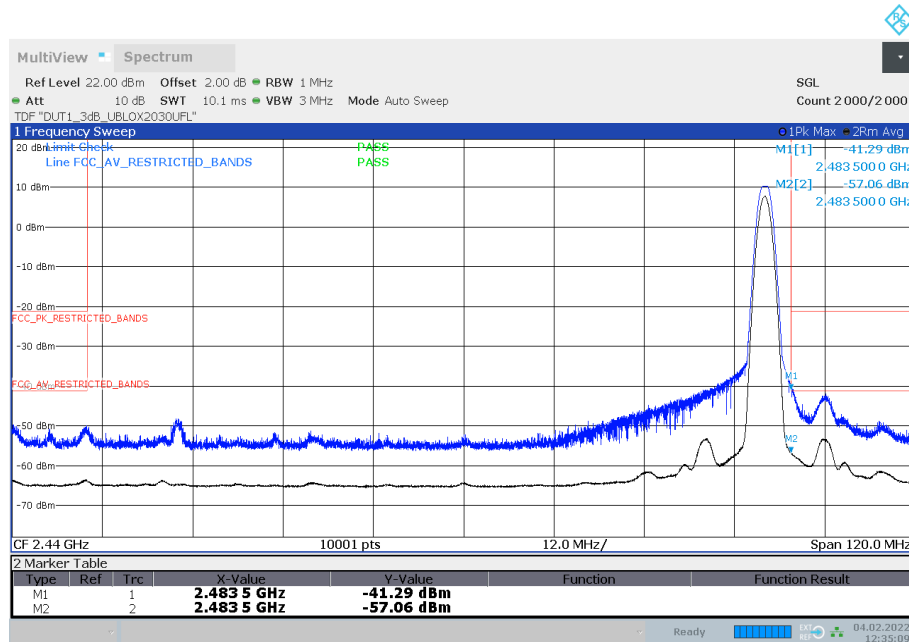

12:35:09 04.02.2022

High Channel, high BE

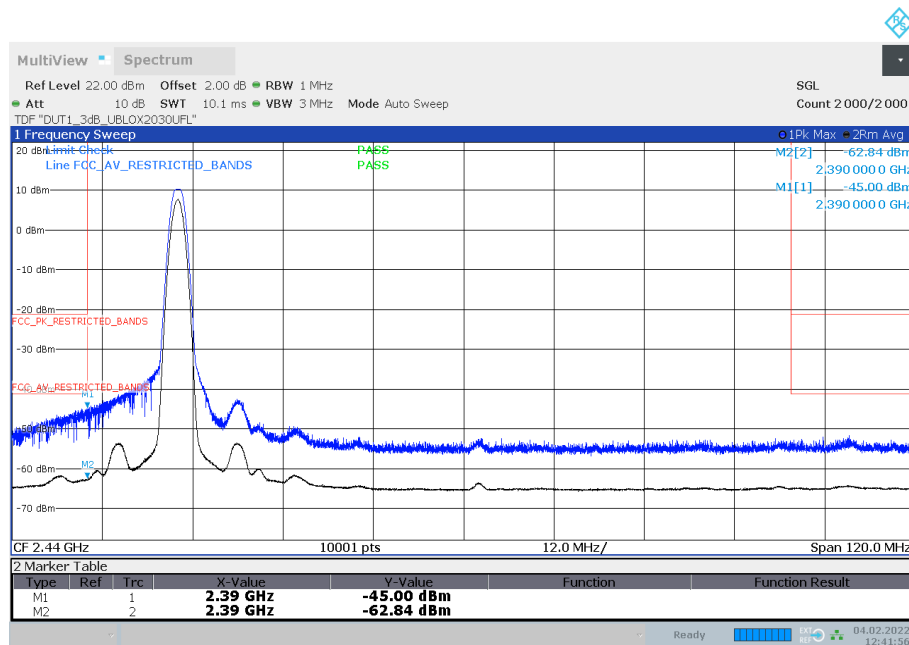

12:41:57 04.02.2022

Low Channel, low BE

Radio Technology = Bluetooth LE 1 Mbps, Operating Frequency = high, Band Edge = high (S01_374_BA01)

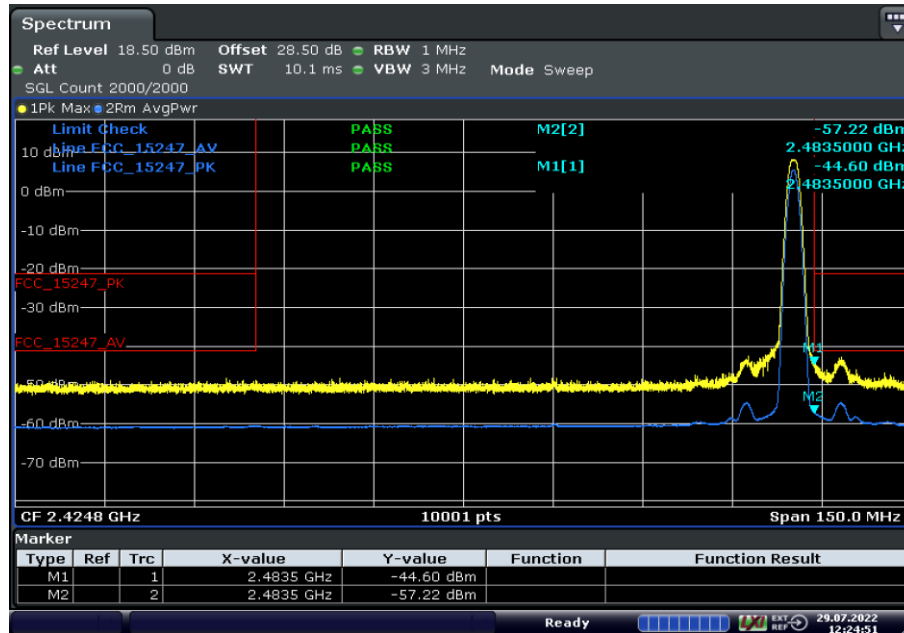

Date: 29.JUL.2022 12:24:51

Radio Technology = WLAN b, Operating Frequency = low + high, Band Edge = low + high (S01_374_BA01)

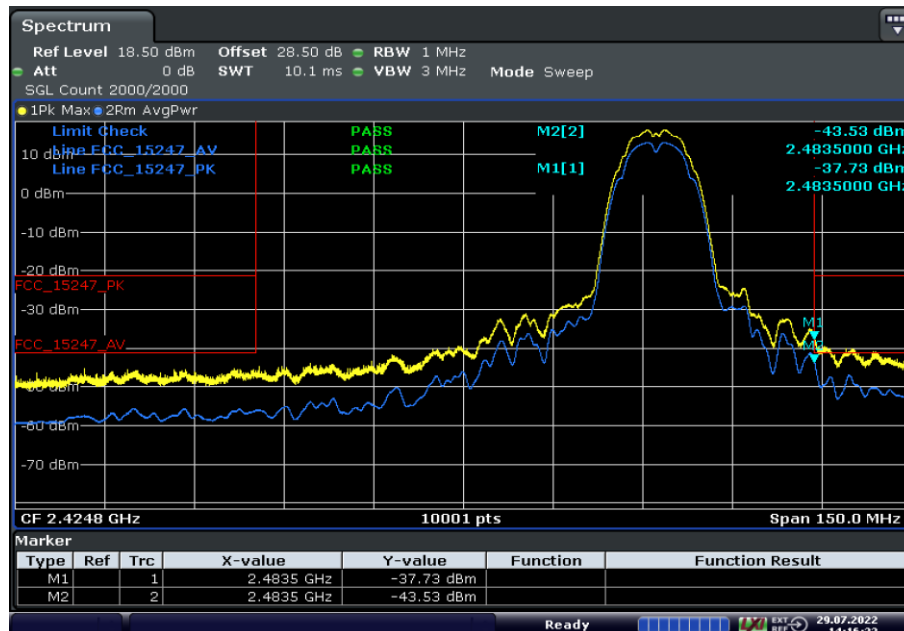

Date: 29.JUL.2022 14:16:23

2nd highest Channel, high BE

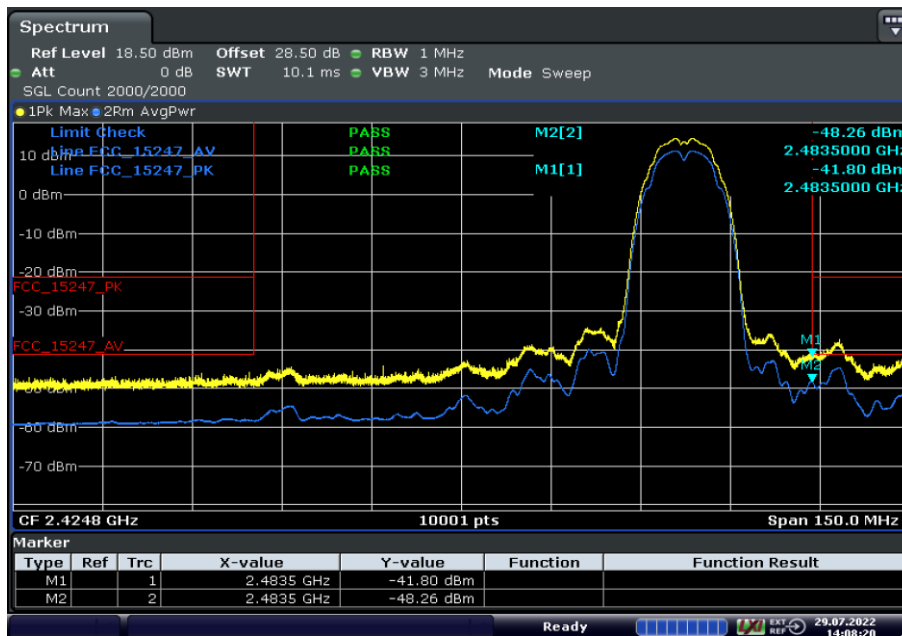

Date: 29.JUL.2022 14:08:21

Highest Channel, high BE

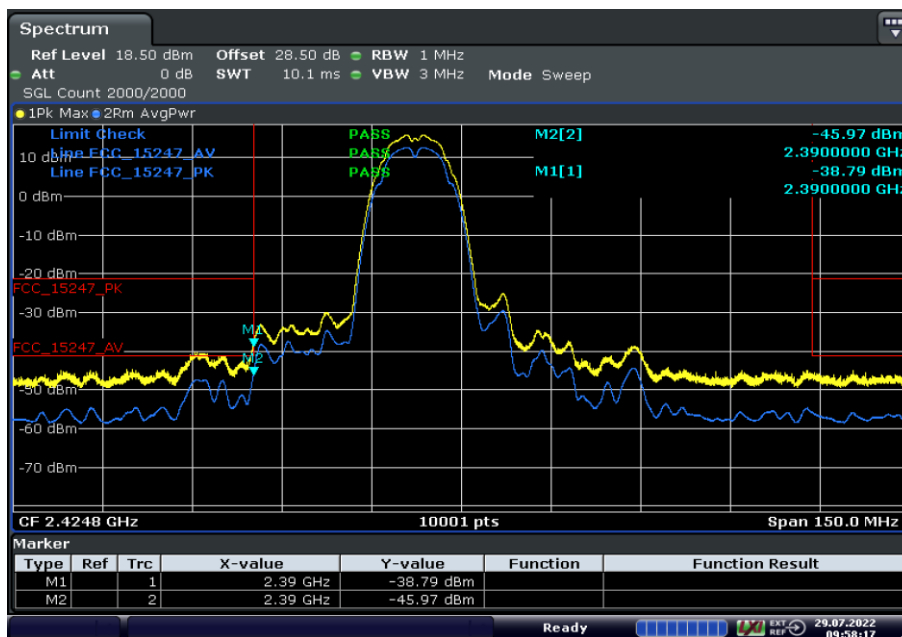

Date: 29.JUL.2022 09:58:17

2nd lowest Channel, low BE

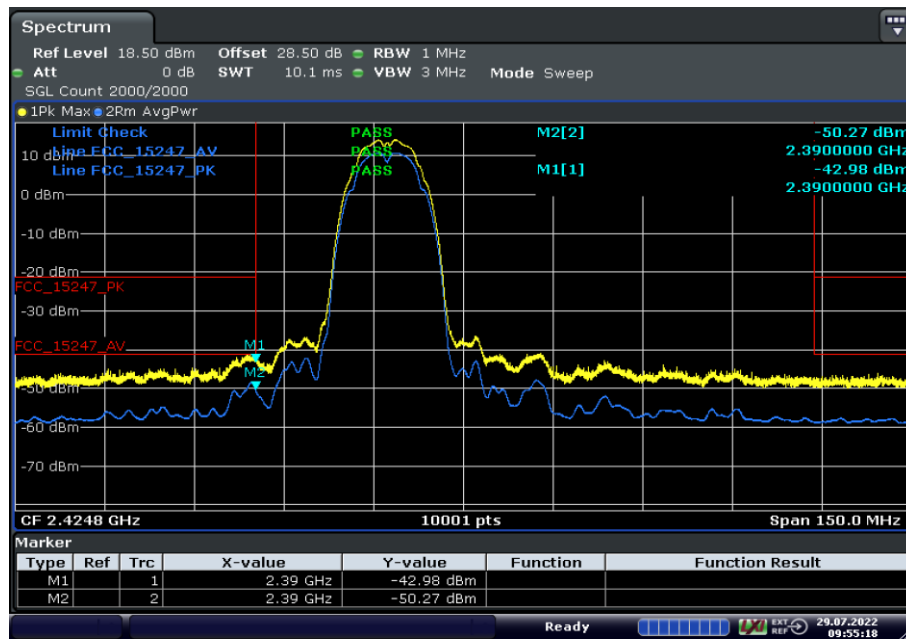

Date: 29.JUL.2022 09:55:18

Lowest Channel, low BE

Radio Technology = Bluetooth LE 2 Mbps, Operating Frequency = high, Band Edge = high (S02_374_BB01)

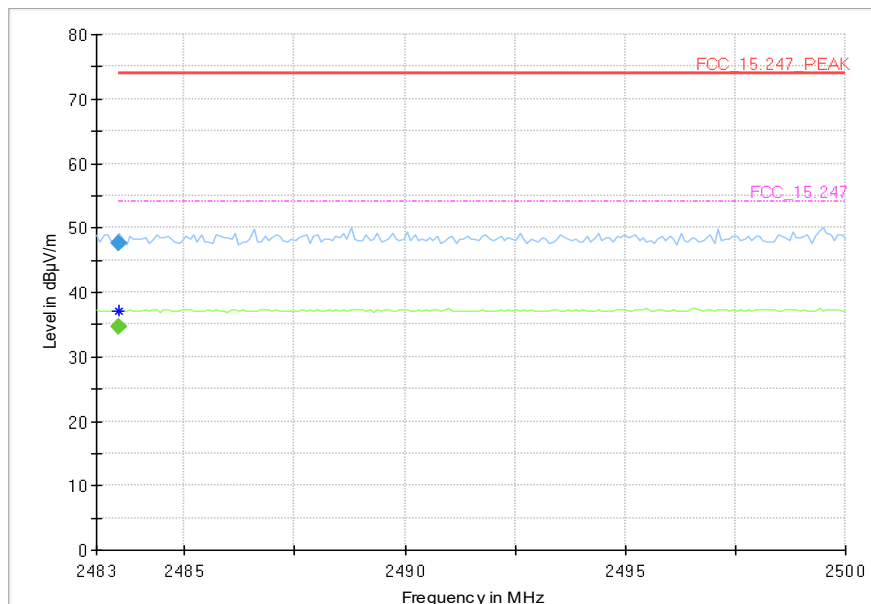

Final Result

Frequency (MHz)	MaxPeak (dBµV/m)	CAverage (dBµV/m)	Limit (dBµV/m)	Margin (dB)	Meas. Time (ms)	Bandwidth (kHz)	Height (cm)	Pol	Azimuth (deg)	Elevation (deg)	Corr. (dB/m)
2483.510	---	34.7	54.00	19.33	1000.0	1000.000	150.0	H	-69.0	81.0	5.3
2483.510	47.7	---	74.00	26.33	1000.0	1000.000	150.0	H	-69.0	81.0	5.3

Radio Technology = Bluetooth LE 2 Mbps, Operating Frequency = low + high, Band Edge = low + high
(S01_377_AA01)

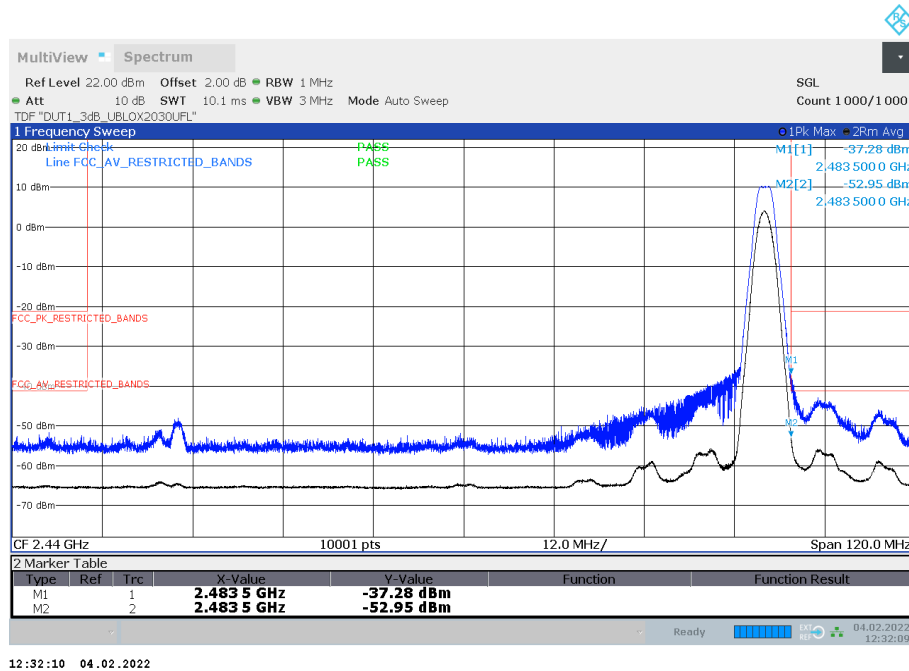

High Channel, high BE

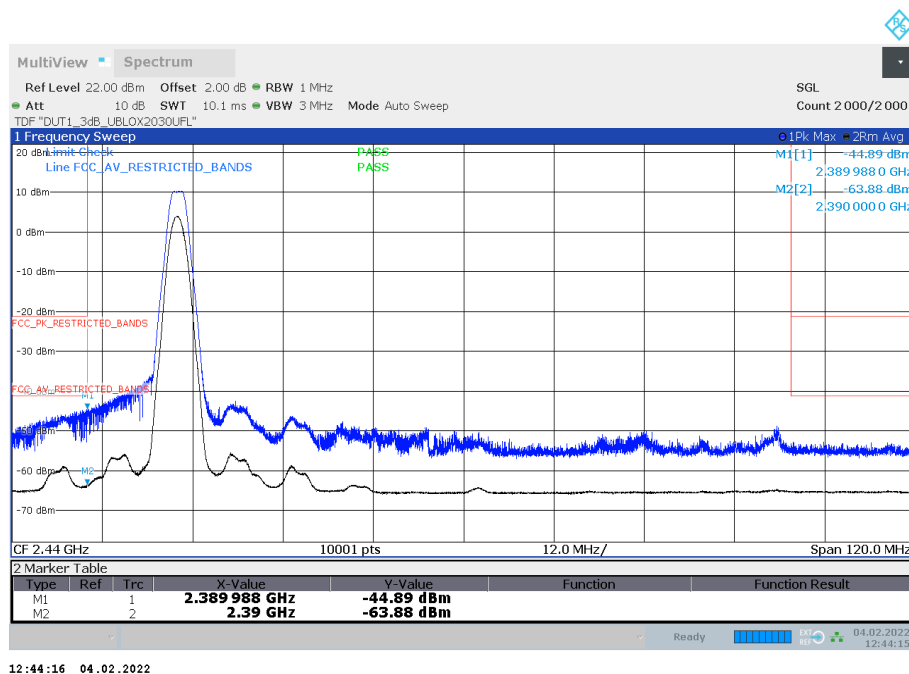

Low Channel, low BE

Radio Technology = WLAN b, Operating Frequency = high, Band Edge = high
(S02_377_AD01)

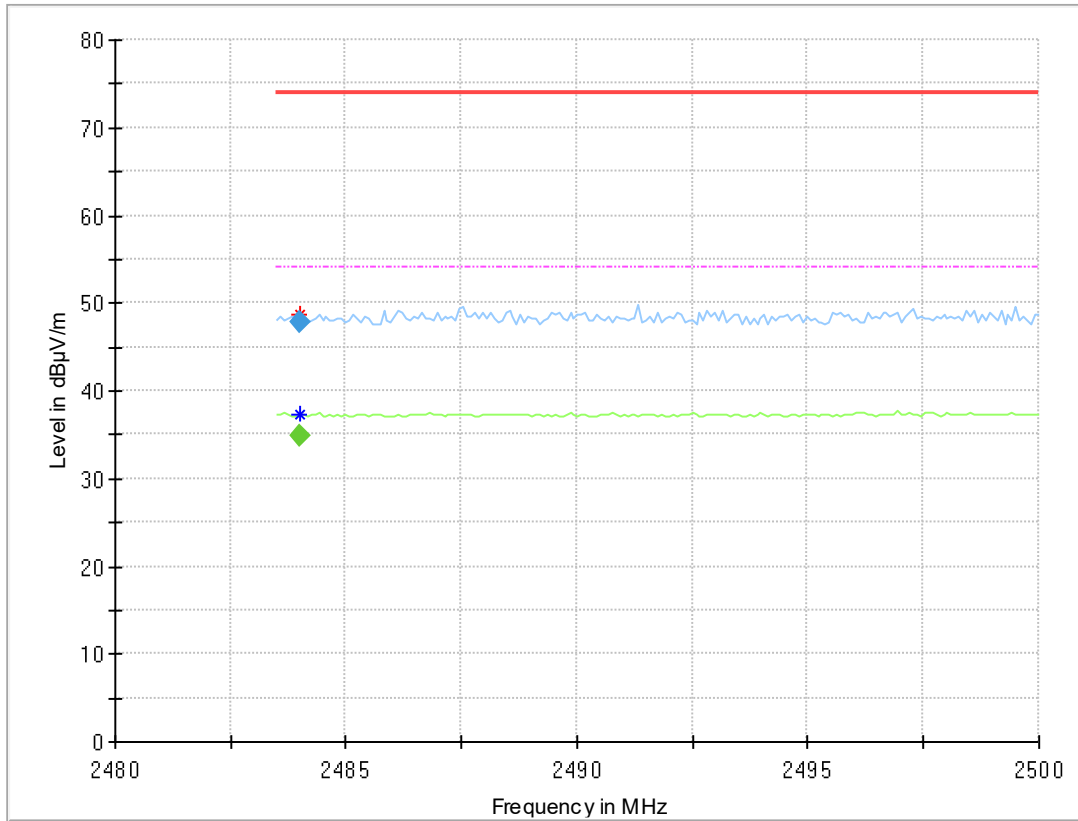

Final Result

Frequency (MHz)	MaxPeak (dBµV/m)	CAverage (dBµV/m)	Limit (dBµV/m)	Margin (dB)	Meas. Time (ms)	Bandwidth (kHz)	Height (cm)	Pol	Azimuth (deg)	Elevation (deg)	Corr. (dB/m)
2483.995	---	34.8	54.00	19.21	1000.0	1000.000	150.0	V	-171.0	5.0	5.3
2483.995	47.7	---	74.00	26.27	1000.0	1000.000	150.0	V	-171.0	5.0	5.3

Radio Technology = WLAN b, Operating Frequency = low + high, Band Edge = low + high (S01_377_AA01)

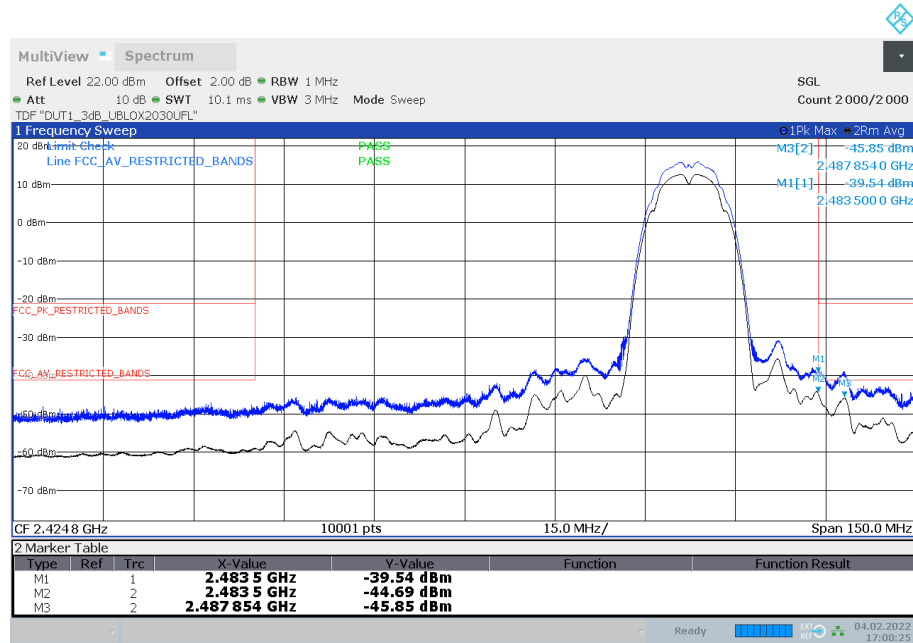

17:00:25 04.02.2022

Highest Channel, high BE

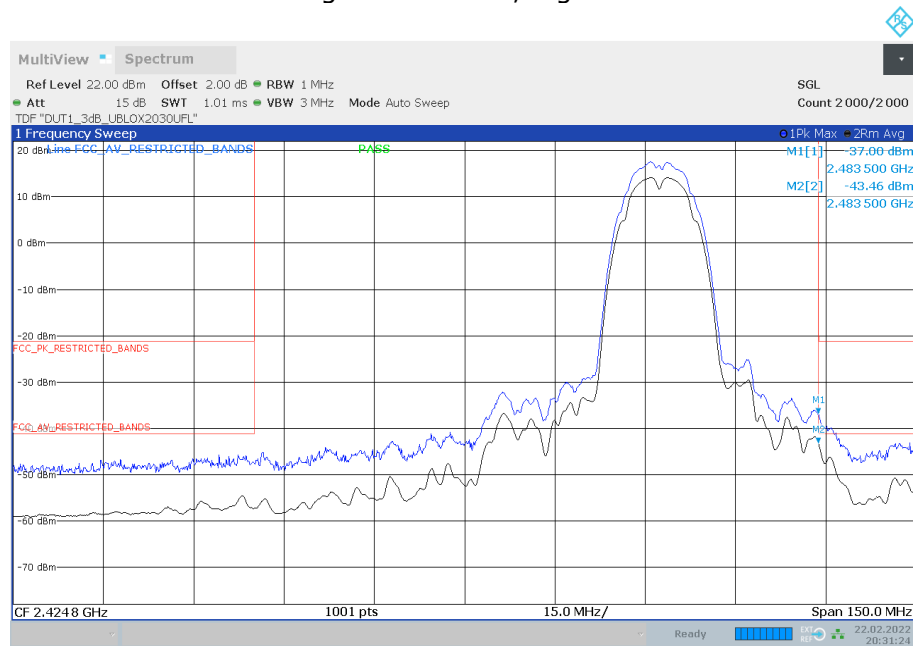

20:31:24 22.02.2022

2nd highest Channel, high BE

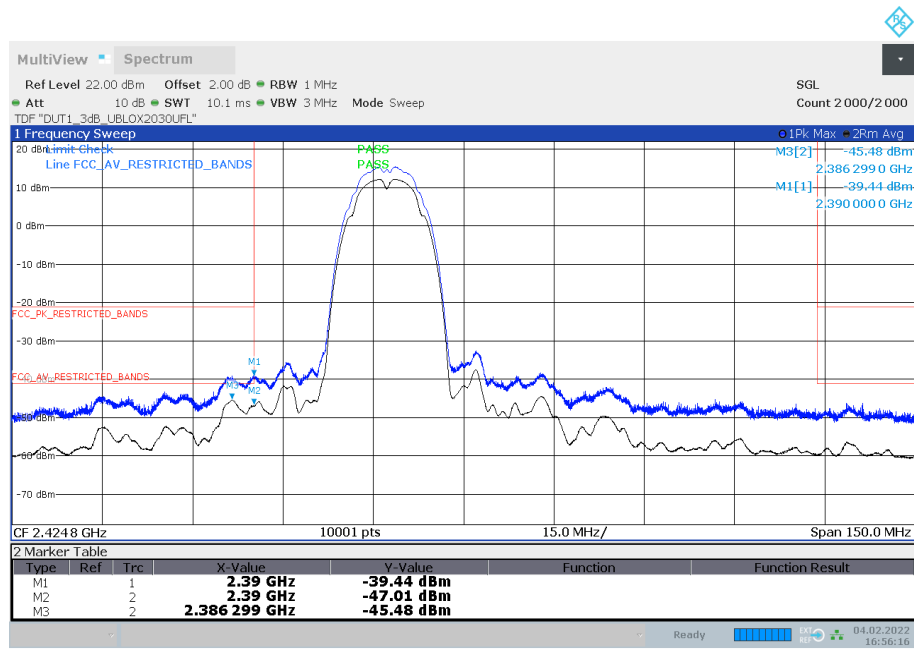

16:56:16 04.02.2022

Lowest Channel, low BE

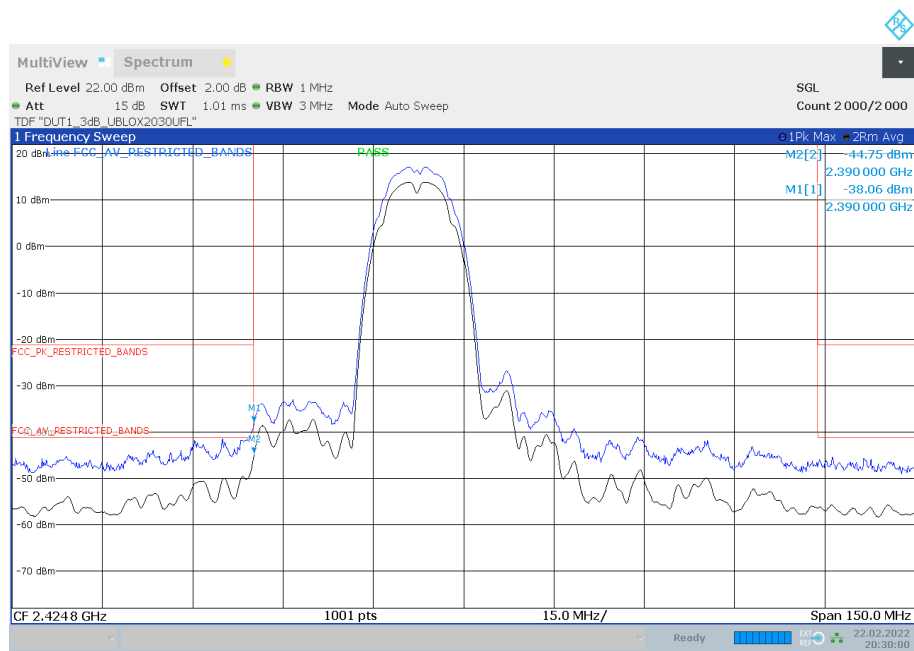

20:30:00 22.02.2022

2nd lowest Channel, low BE

Radio Technology = WLAN b, Operating Frequency = high, Band Edge = high
(S02_374_BB01)

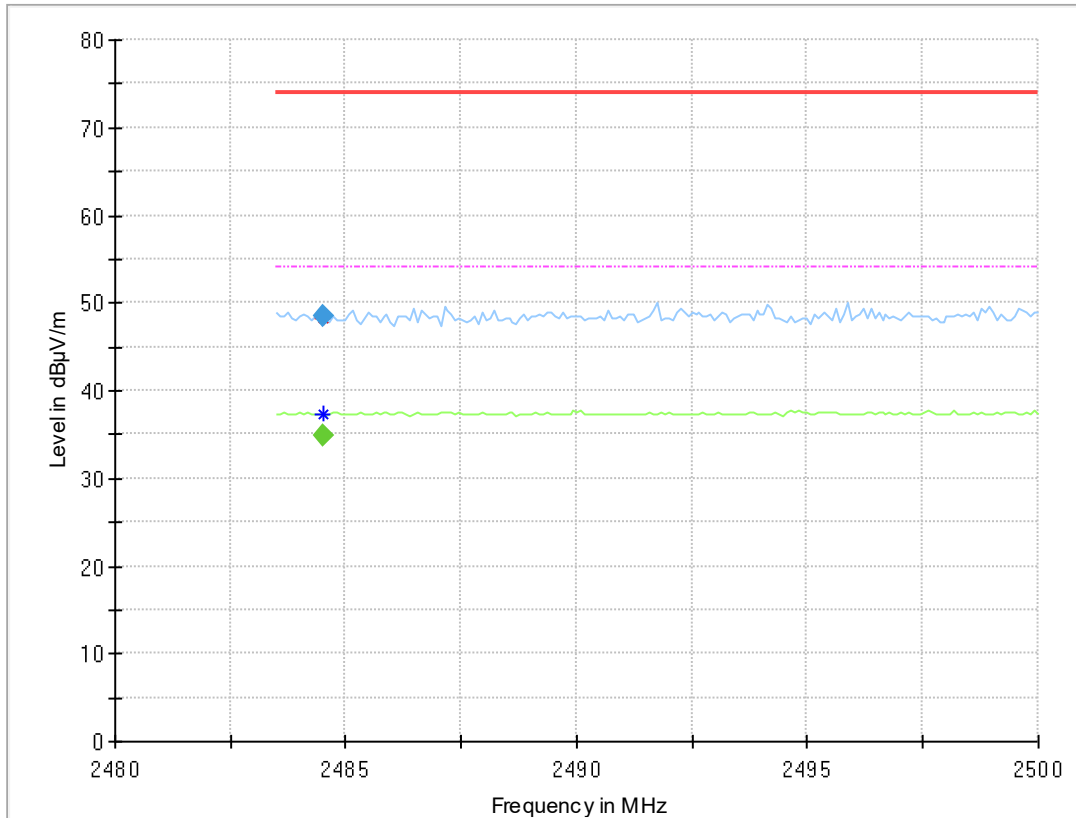

Final Result

Frequency (MHz)	MaxPeak (dBµV/m)	CAverage (dBµV/m)	Limit (dBµV/m)	Margin (dB)	Meas. Time (ms)	Bandwidth (kHz)	Height (cm)	Pol	Azimuth (deg)	Elevation (deg)	Corr. (dB/m)
2484.490	---	34.9	54.00	19.07	1000.0	1000.000	150.0	V	77.0	-11.0	5.3
2484.490	48.5	---	74.00	25.49	1000.0	1000.000	150.0	V	77.0	-11.0	5.3

Radio Technology = WLAN g, Operating Frequency = high, Band Edge = high
(S02_377_AD01)

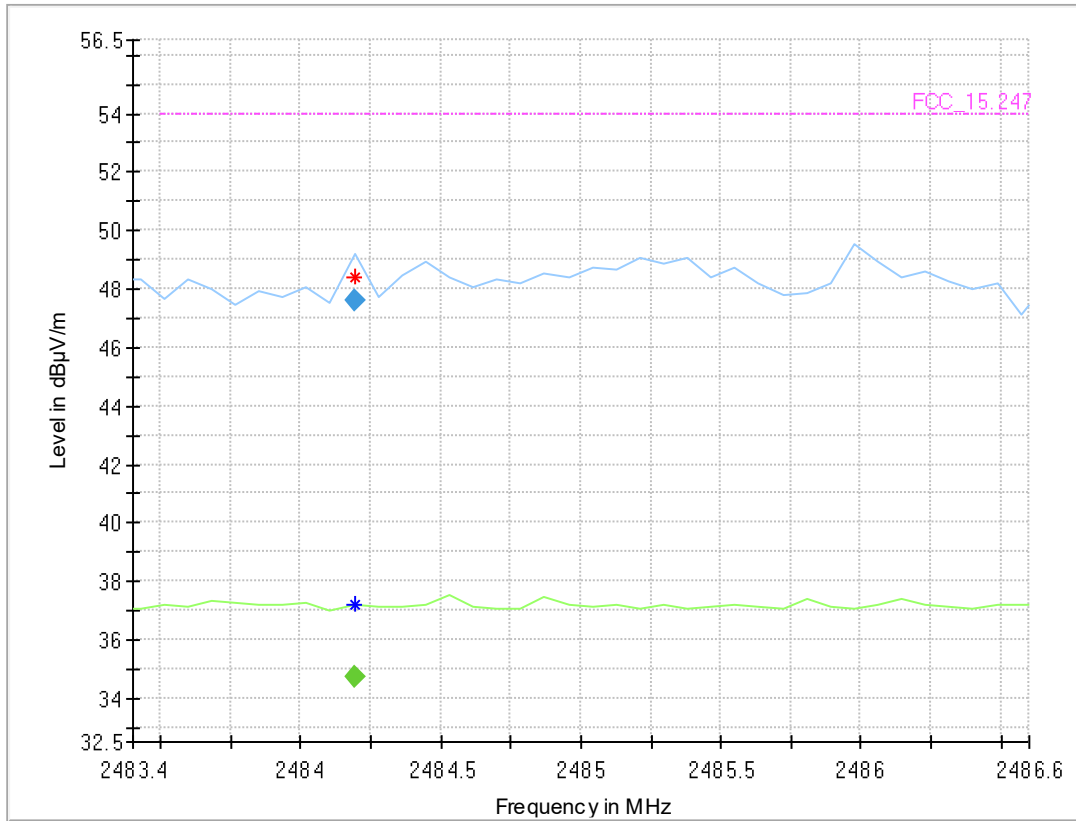

Final Result

Frequency (MHz)	MaxPeak (dBµV/m)	CAverage (dBµV/m)	Limit (dBµV/m)	Margin (dB)	Meas. Time (ms)	Bandwidth (kHz)	Height (cm)	Pol	Azimuth (deg)	Elevation (deg)	Corr. (dB/m)
2484.190	---	34.7	54.00	19.29	1000.0	1000.000	150.0	V	-4.0	12.0	5.3
2484.190	47.6	---	74.00	26.42	1000.0	1000.000	150.0	V	-4.0	12.0	5.3

Radio Technology = WLAN g, Operating Frequency = low + high, Band Edge = low + high (S01_377_AA01)

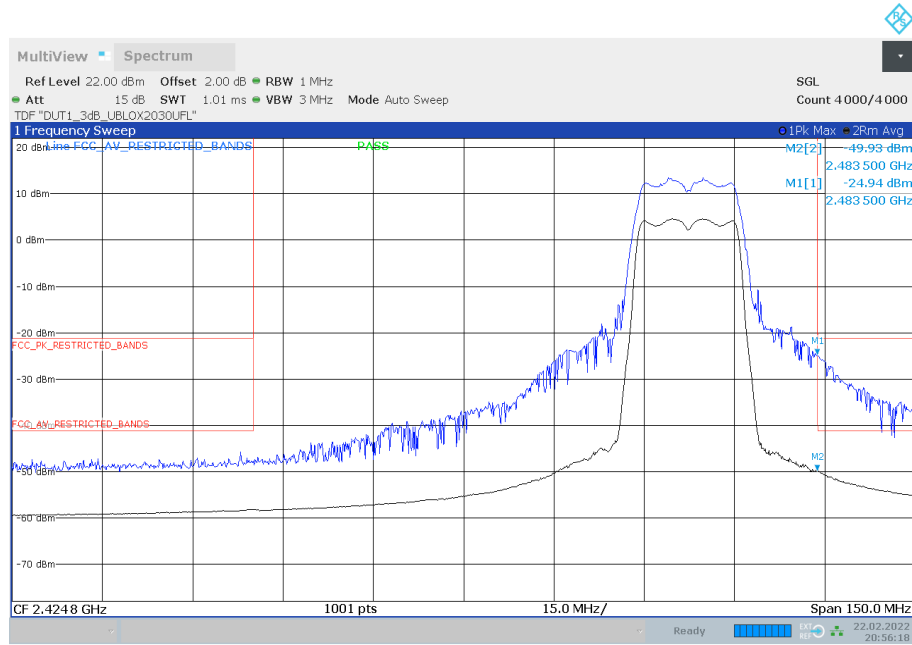

20:56:18 22.02.2022

Highest Channel, high BE

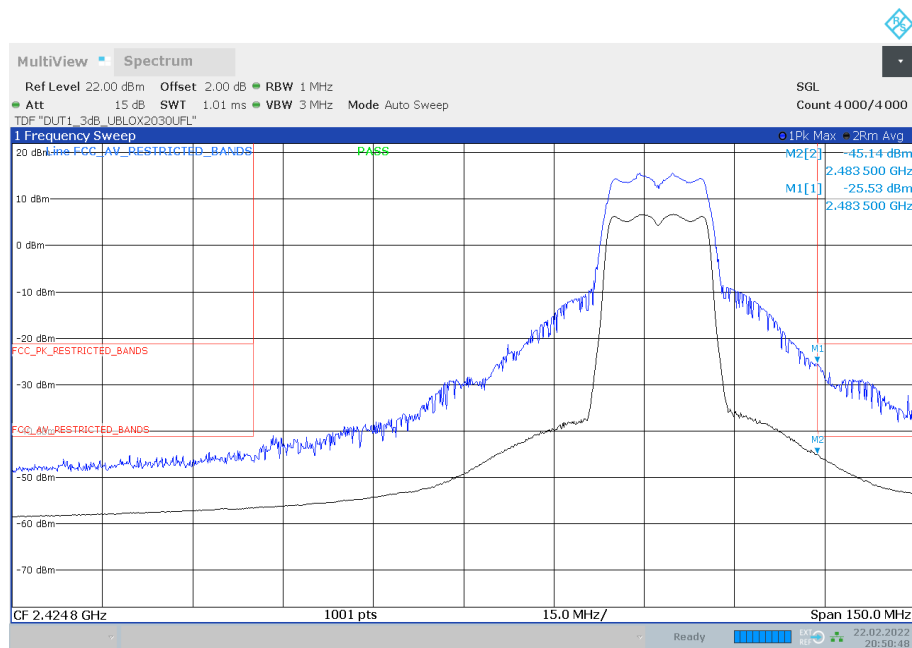

20:56:49 22.02.2022

2nd highest Channel, high BE

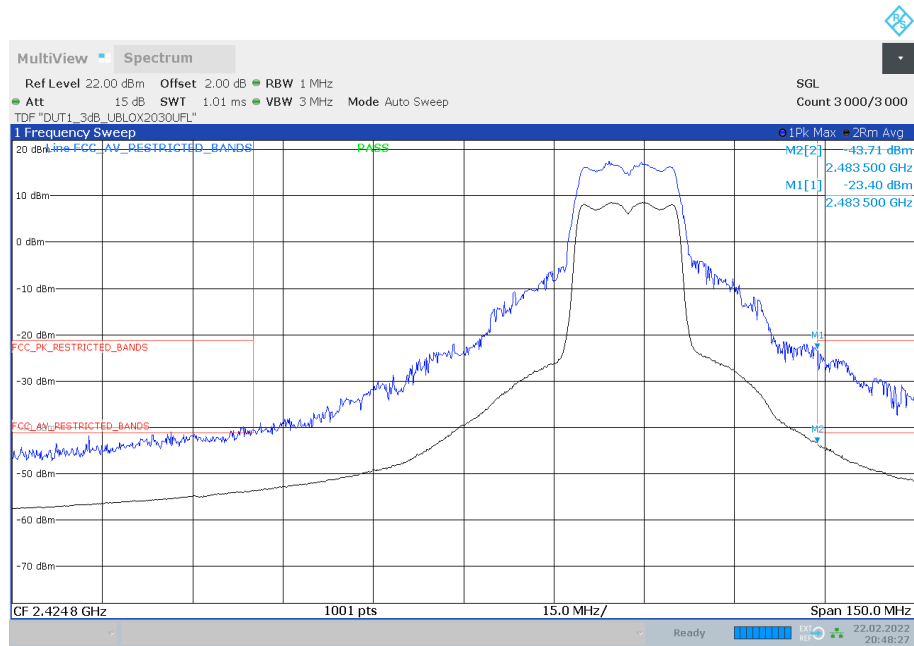

20:48:27 22.02.2022

3rd highest Channel, high BE

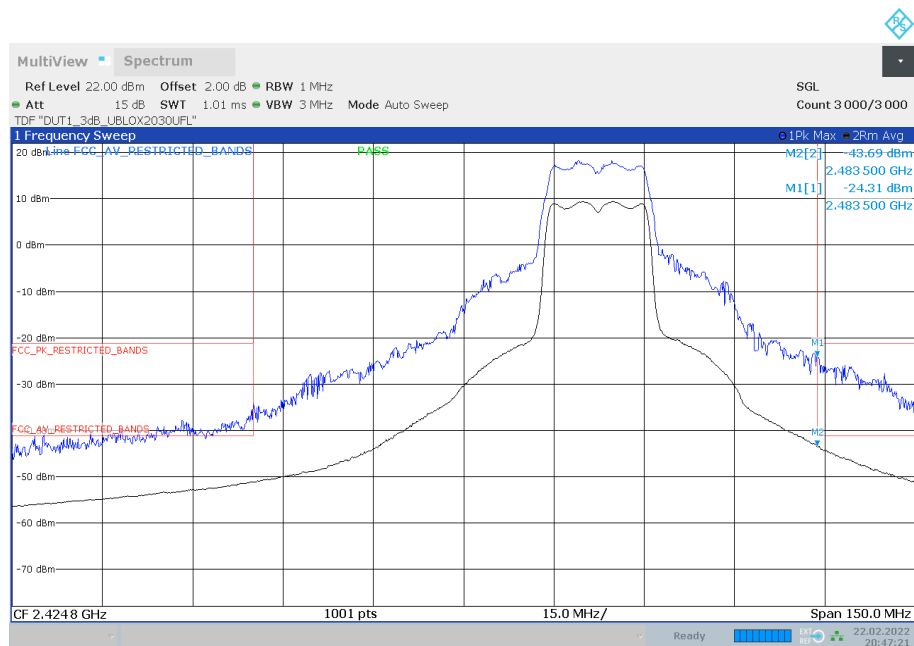

20:47:21 22.02.2022

4th highest Channel, high BE

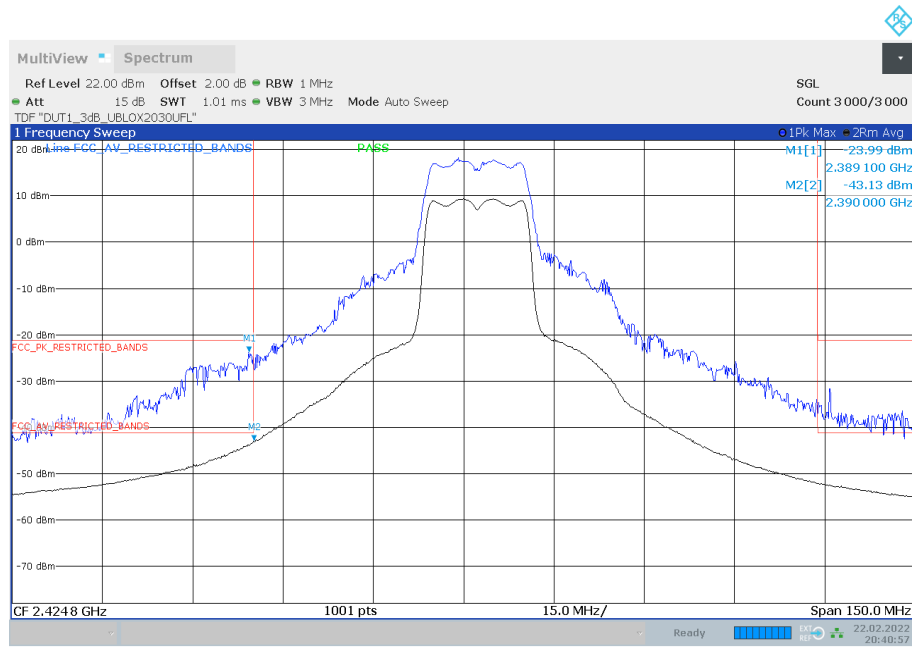

20:40:57 22.02.2022

4th lowest Channel, low BE

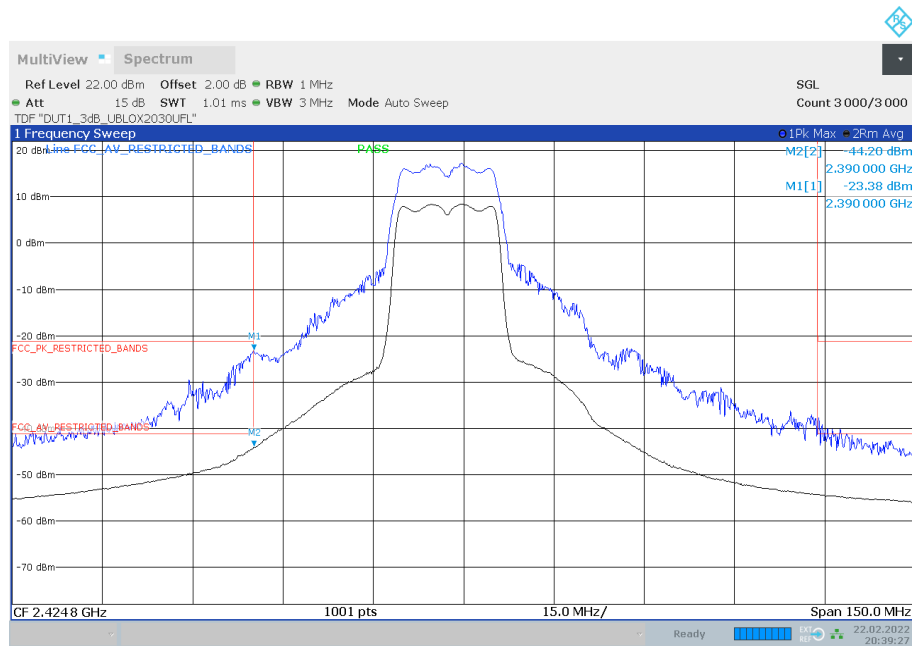

20:39:27 22.02.2022

3rd lowest Channel, low BE

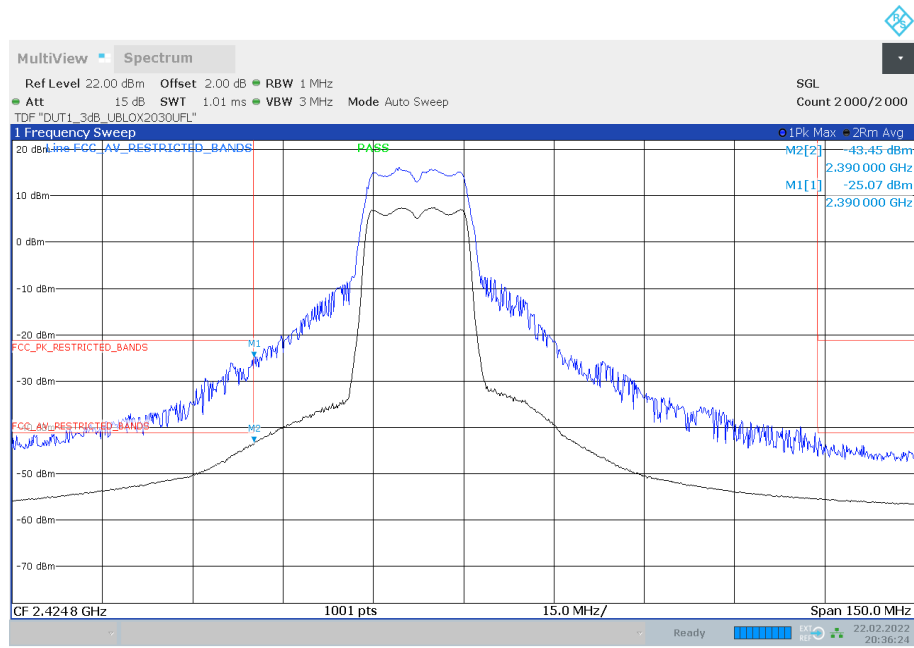

20:36:24 22.02.2022

2nd lowest Channel, low BE

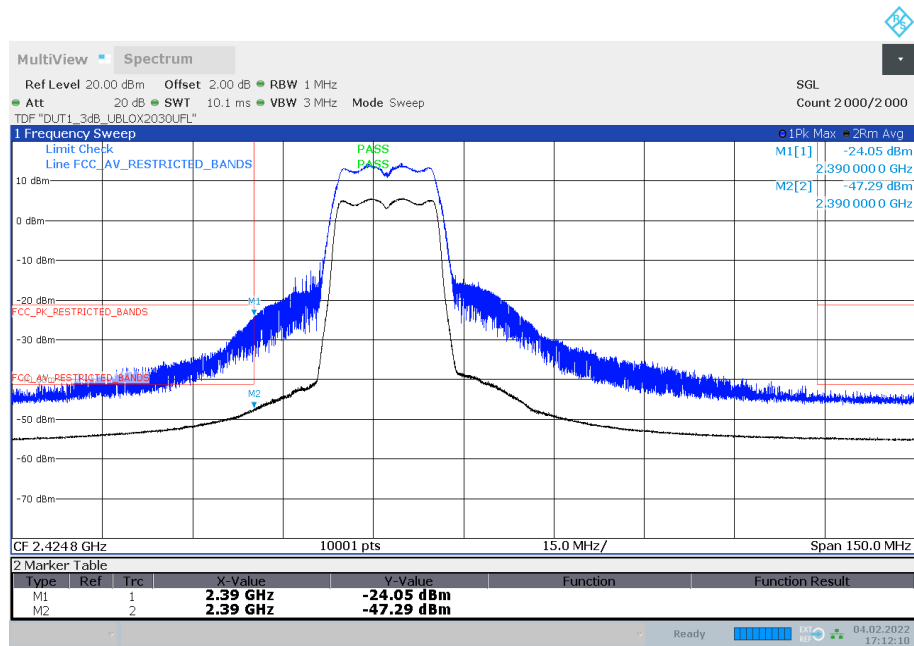

17:12:10 04.02.2022

Lowest Channel, low BE

Radio Technology = WLAN n 20 MHz, Operating Frequency = high, Band Edge = high
(S02_377_AD01)

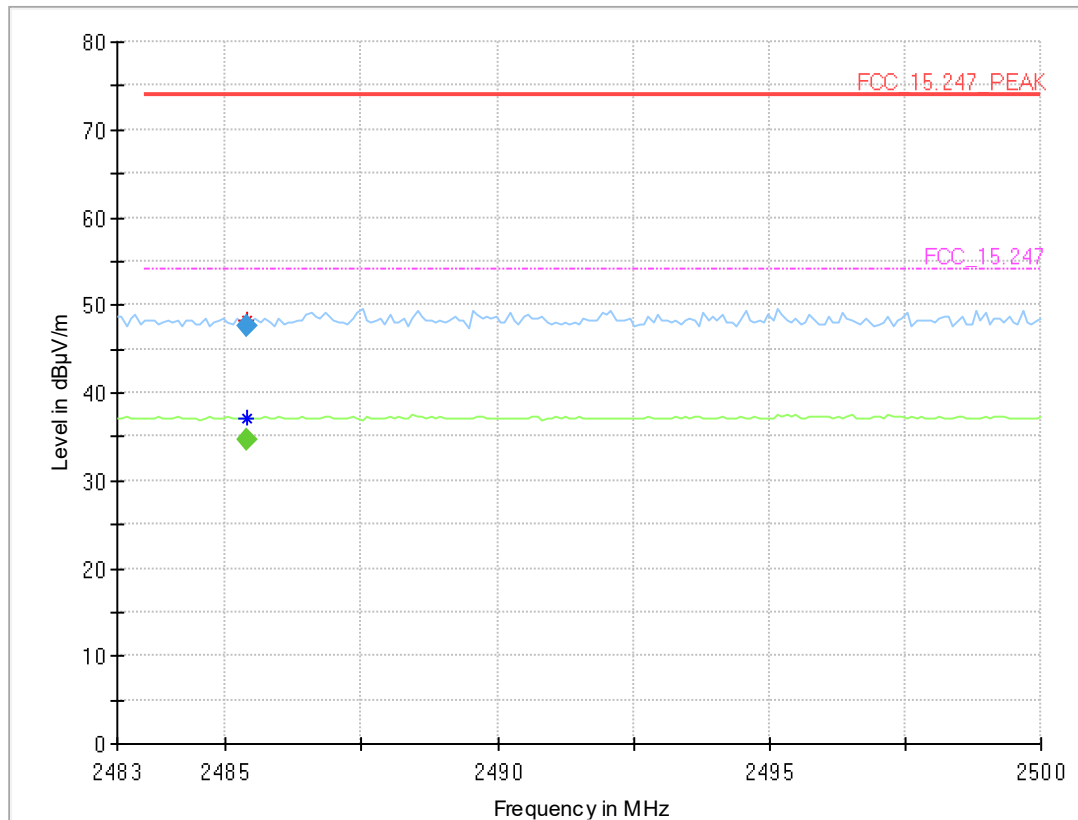

Final Result

Frequency (MHz)	MaxPeak (dBµV/m)	CAverage (dBµV/m)	Limit (dBµV/m)	Margin (dB)	Meas. Time (ms)	Bandwidth (kHz)	Height (cm)	Pol	Azimuth (deg)	Elevation (deg)	Corr. (dB/m)
2485.380	---	34.7	54.00	19.29	1000.0	1000.000	150.0	V	-120.0	82.0	5.3
2485.380	47.6	---	74.00	26.37	1000.0	1000.000	150.0	V	-120.0	82.0	5.3

Radio Technology = WLAN n 20 MHz, Operating Frequency = low + high, Band Edge = low + high
(S01_377_AA01)

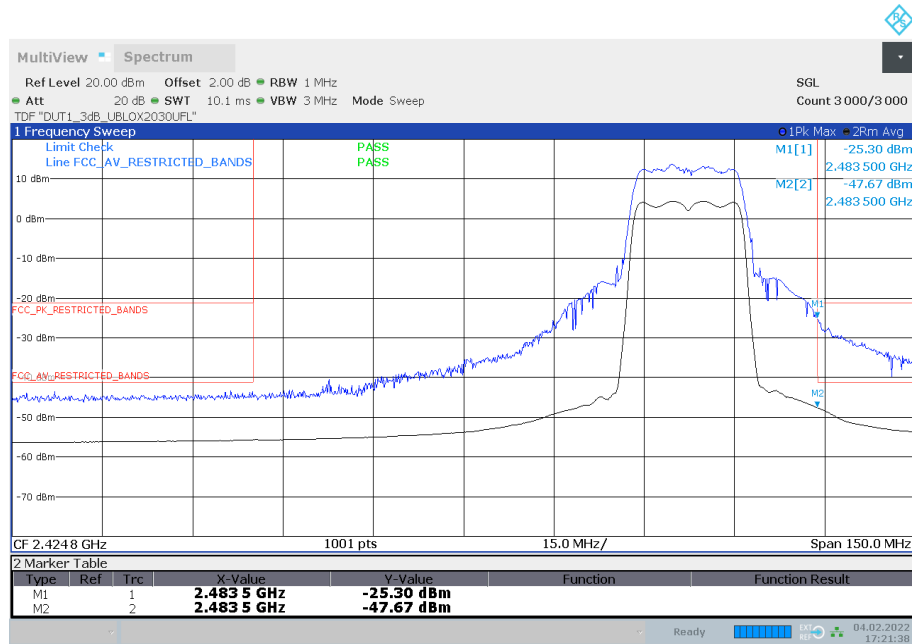

17:21:39 04.02.2022

Highest Channel, high BE

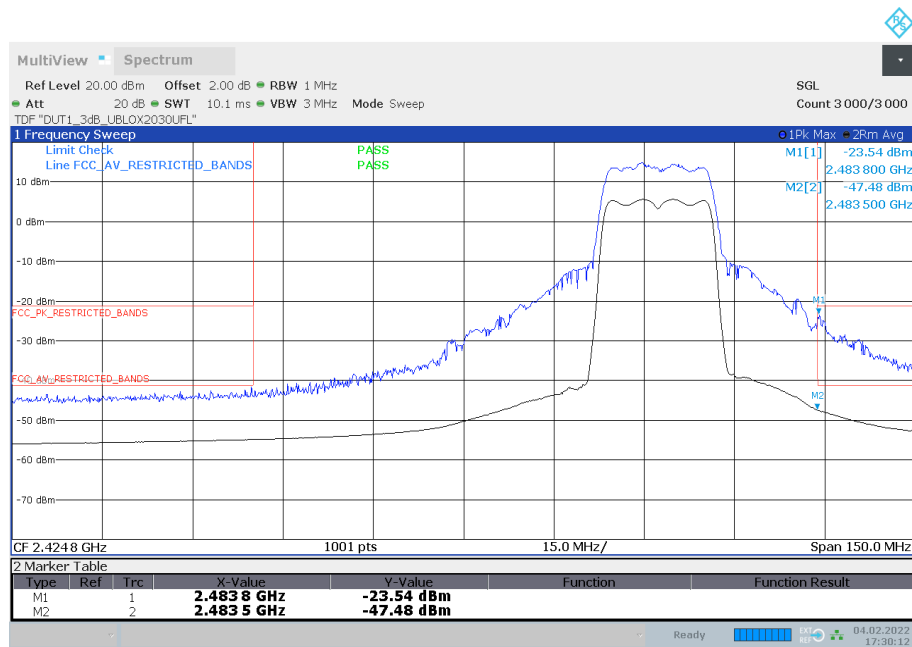

17:30:12 04.02.2022

2nd highest Channel, high BE

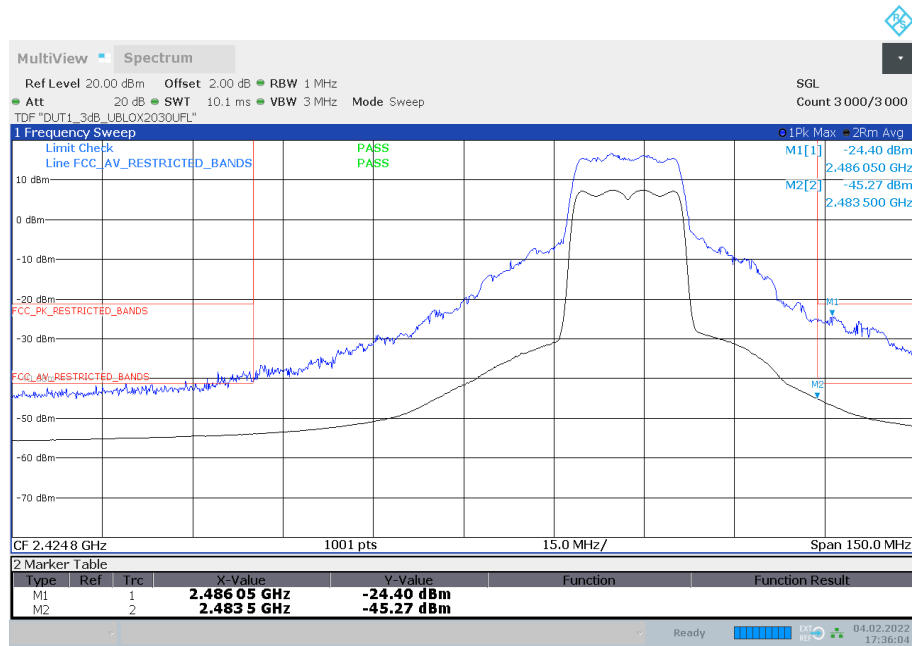

17:36:05 04.02.2022

3rd highest Channel, high BE

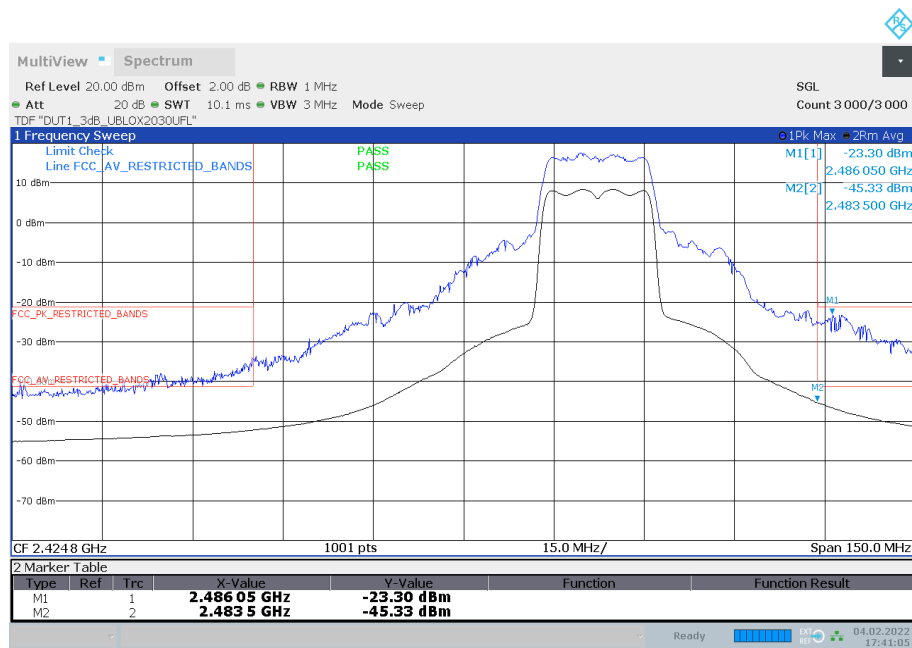

17:41:05 04.02.2022

4th highest Channel, high BE

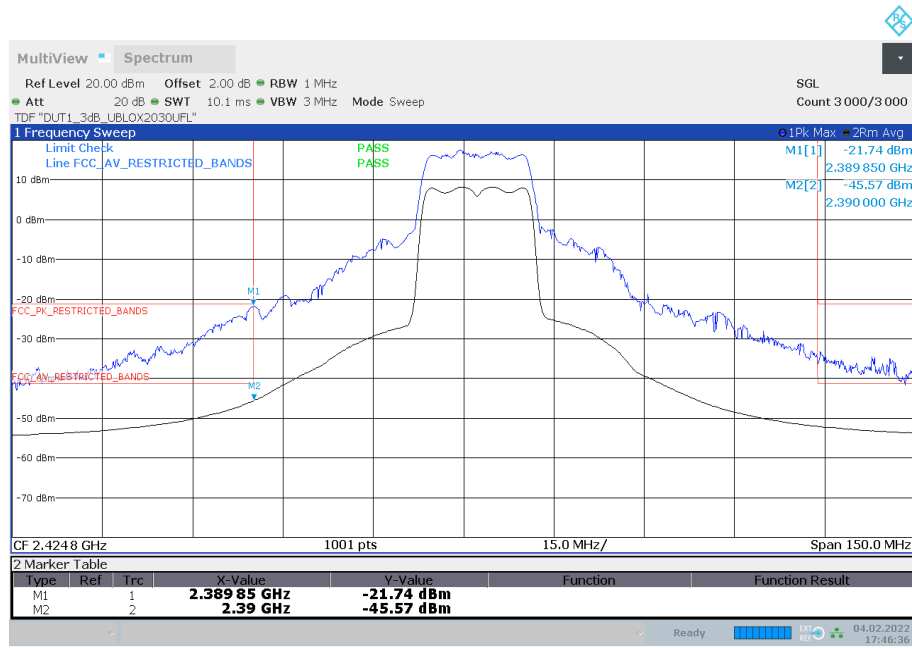

17:46:36 04.02.2022

4th lowest Channel, low BE

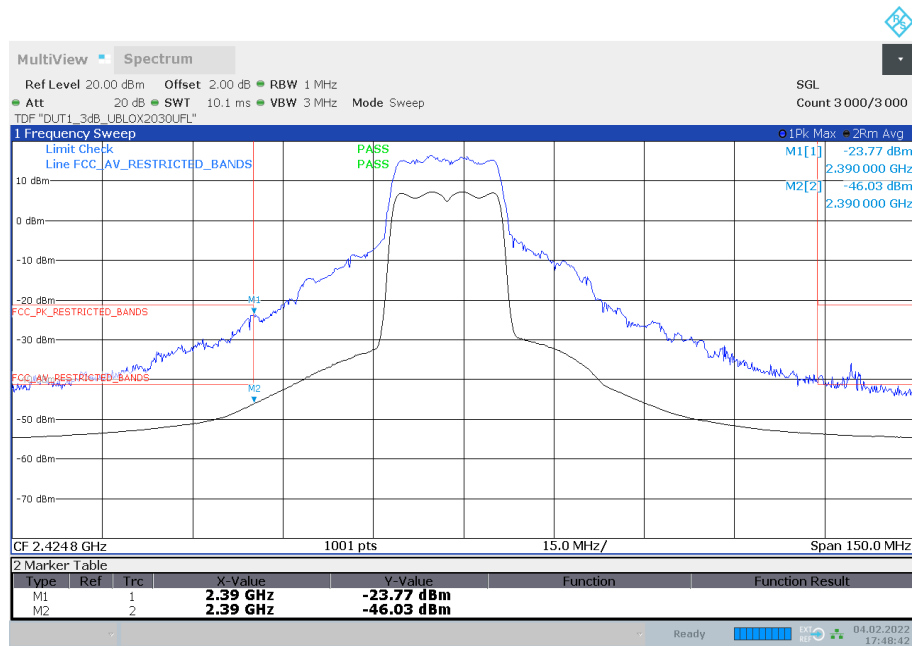

17:48:42 04.02.2022

3rd lowest Channel, low BE

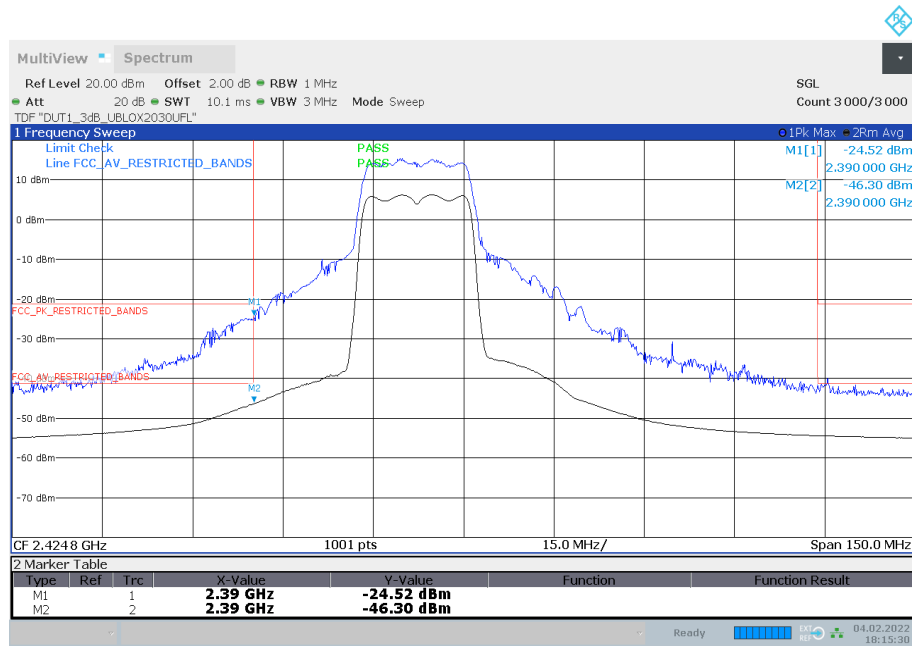

18:15:31 04.02.2022

2nd lowest Channel, low BE

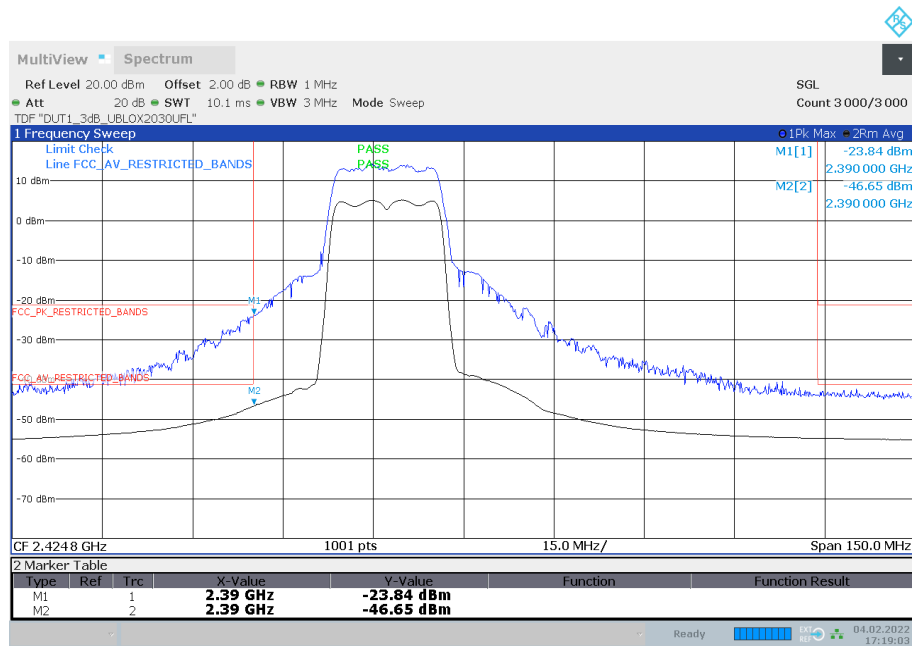

17:19:03 04.02.2022

Lowest Channel, low BE

Radio Technology = WLAN n 40 MHz, Operating Frequency = high, Band Edge = high
(S02_377_AD01)

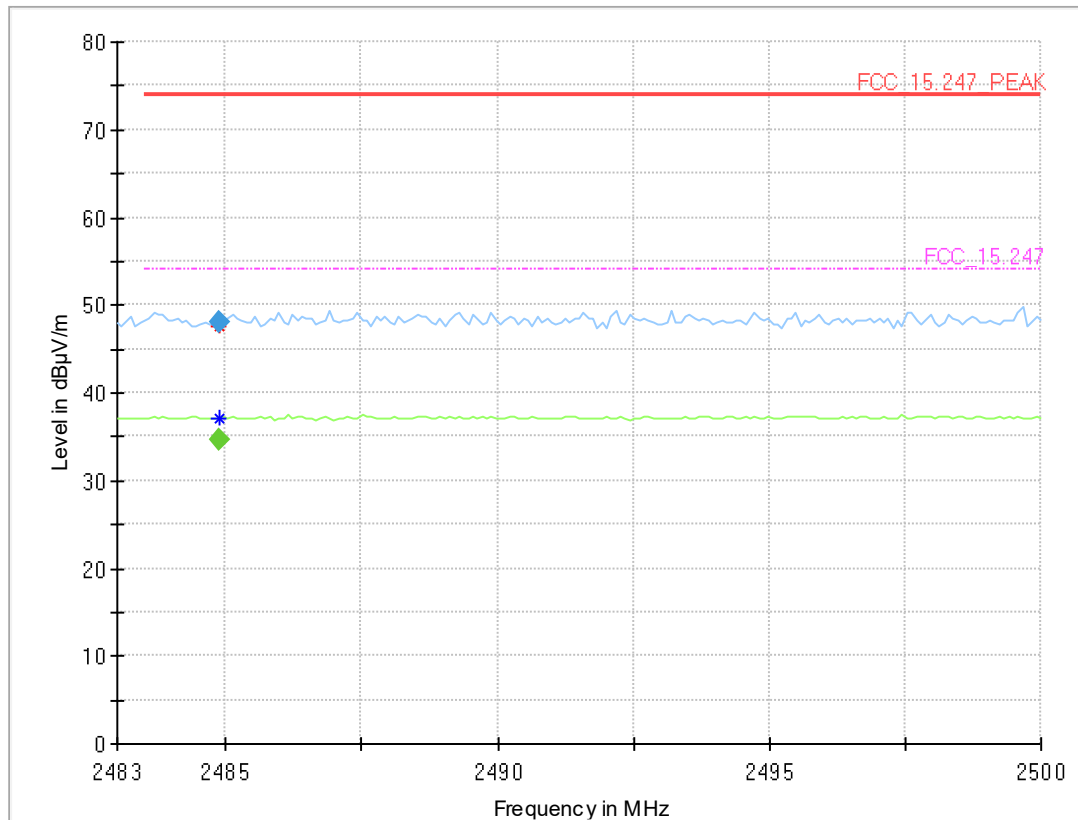

Final Result

Frequency (MHz)	MaxPeak (dBµV/m)	CAverage (dBµV/m)	Limit (dBµV/m)	Margin (dB)	Meas. Time (ms)	Bandwidth (kHz)	Height (cm)	Pol	Azimuth (deg)	Elevation (deg)	Corr. (dB/m)
2484.870	---	34.7	54.00	19.29	1000.0	1000.000	150.0	H	-25.0	15.0	5.3
2484.870	48.0	---	74.00	26.05	1000.0	1000.000	150.0	H	-25.0	15.0	5.3

Radio Technology = WLAN n 40 MHz, Operating Frequency = low + high, Band Edge = low + high
(S01_377_AA01)

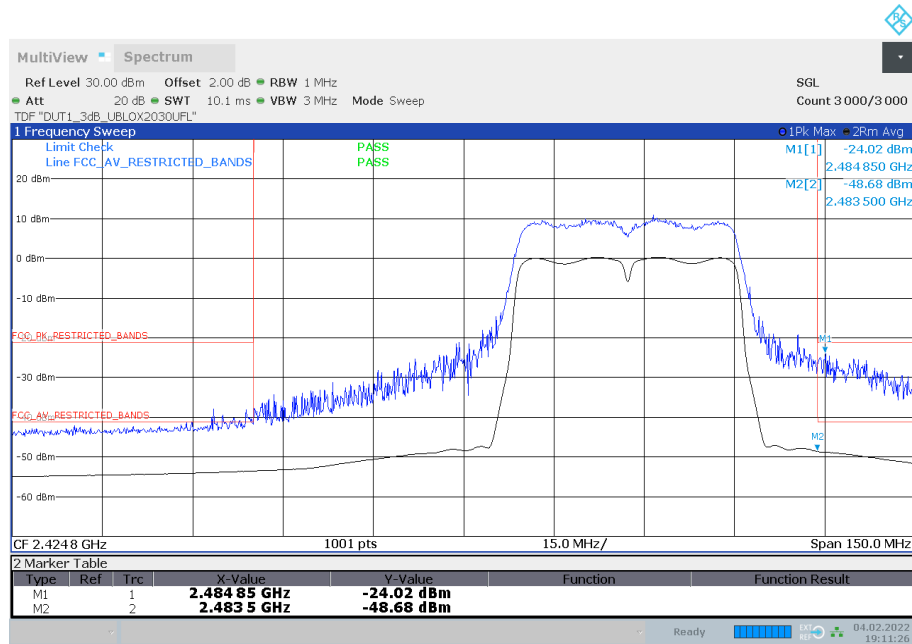

19:11:27 04.02.2022

Highest Channel, high BE

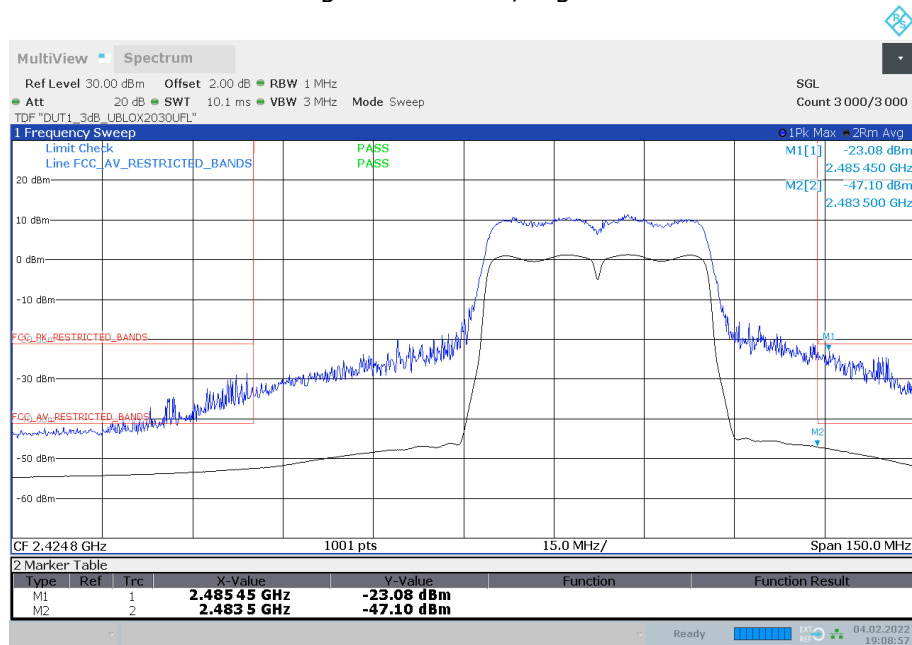

19:08:57 04.02.2022

2nd highest Channel, high BE

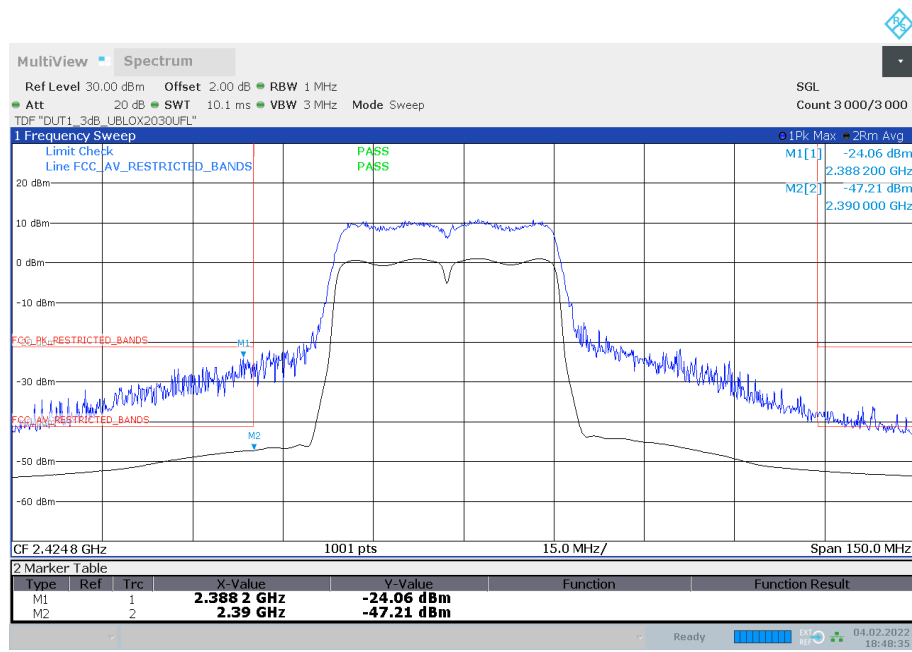

18:48:36 04.02.2022

Lowest Channel, low BE

Radio Technology = WLAN ax 20 MHz, Operating Frequency = low + high, Band Edge = low + high
(S01_377_AA01)

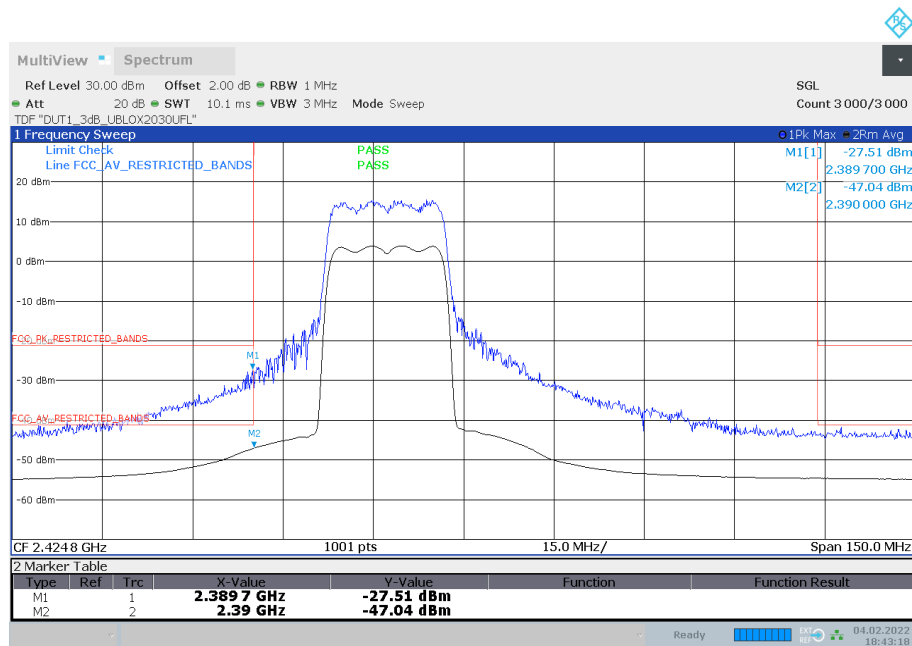

18:43:18 04.02.2022

Lowest Channel, low BE

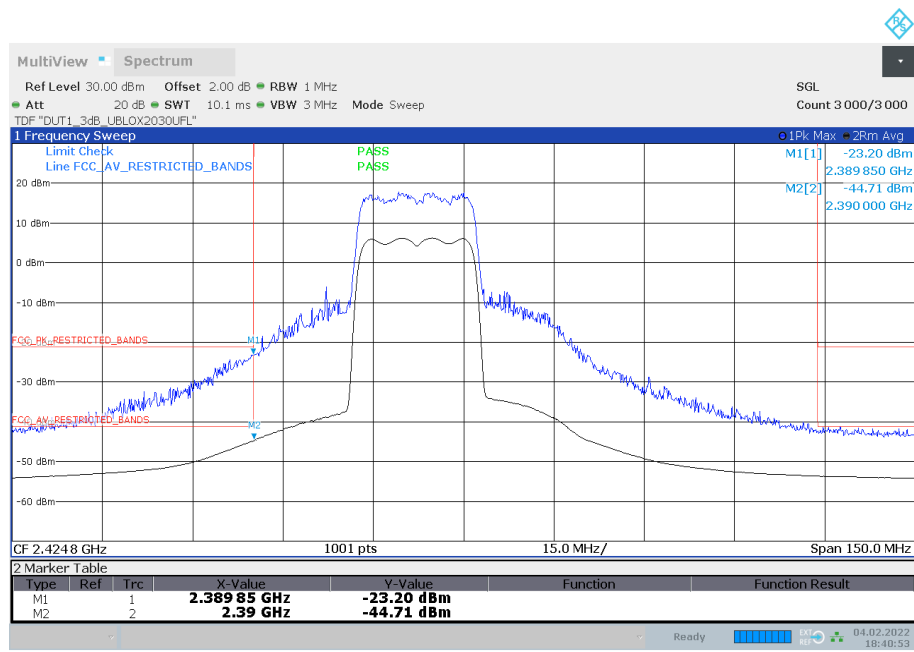

18:40:53 04.02.2022

2nd lowest Channel, low BE

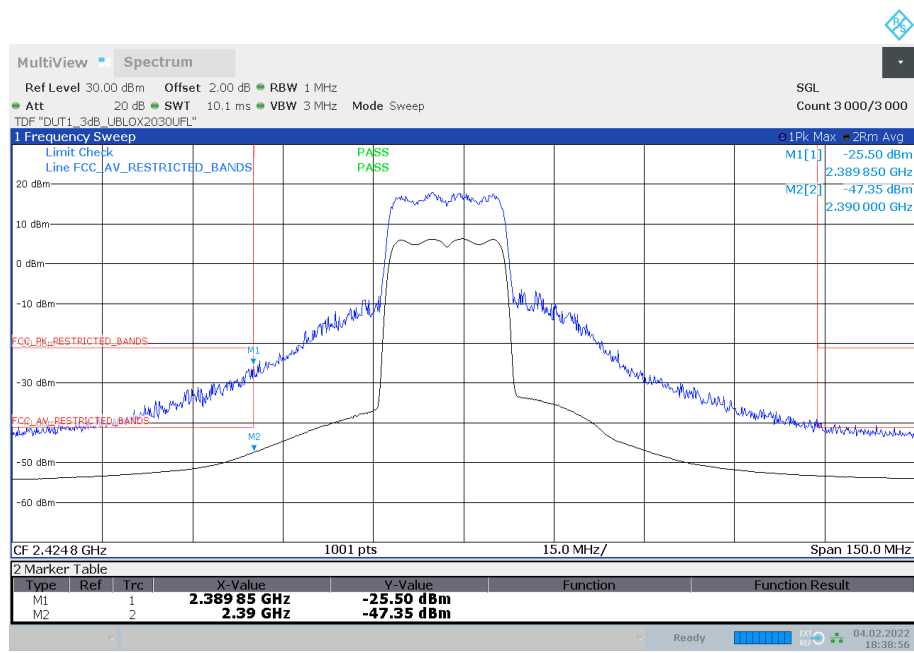

18:38:57 04.02.2022

3rd lowest Channel, low BE

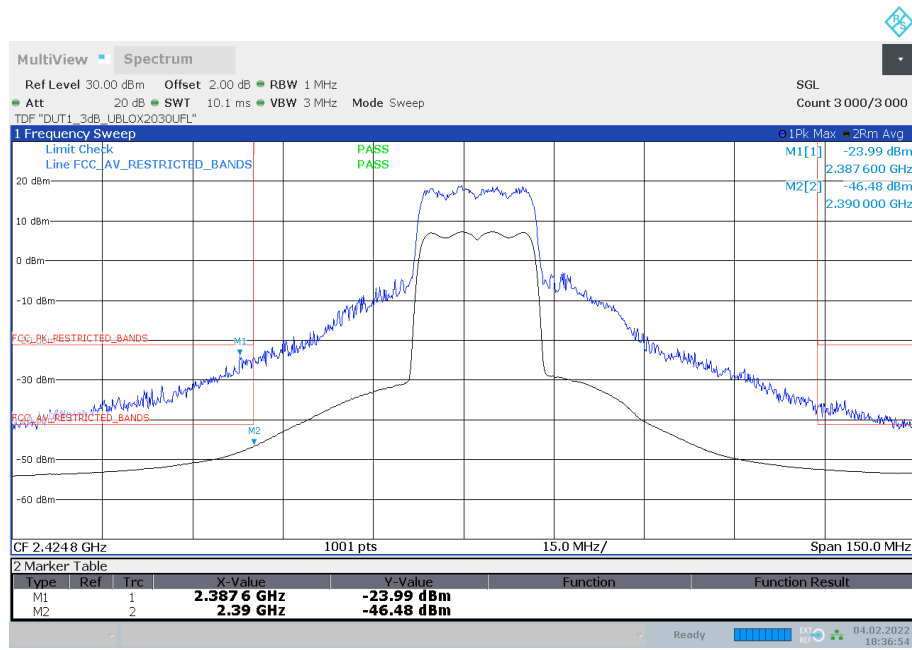

18:36:54 04.02.2022

4th lowest Channel, low BE

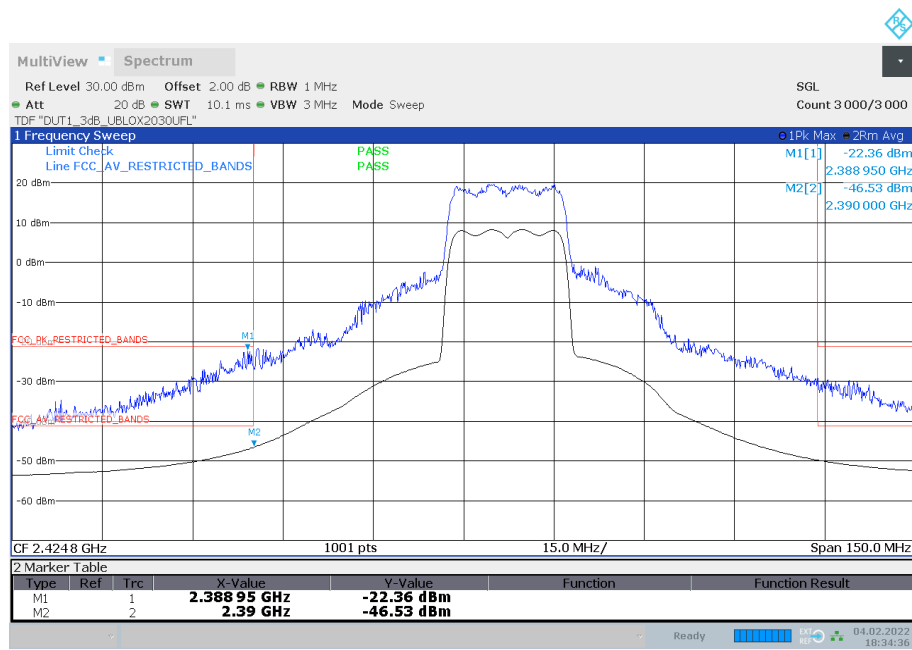

18:34:37 04.02.2022

5th lowest Channel, low BE

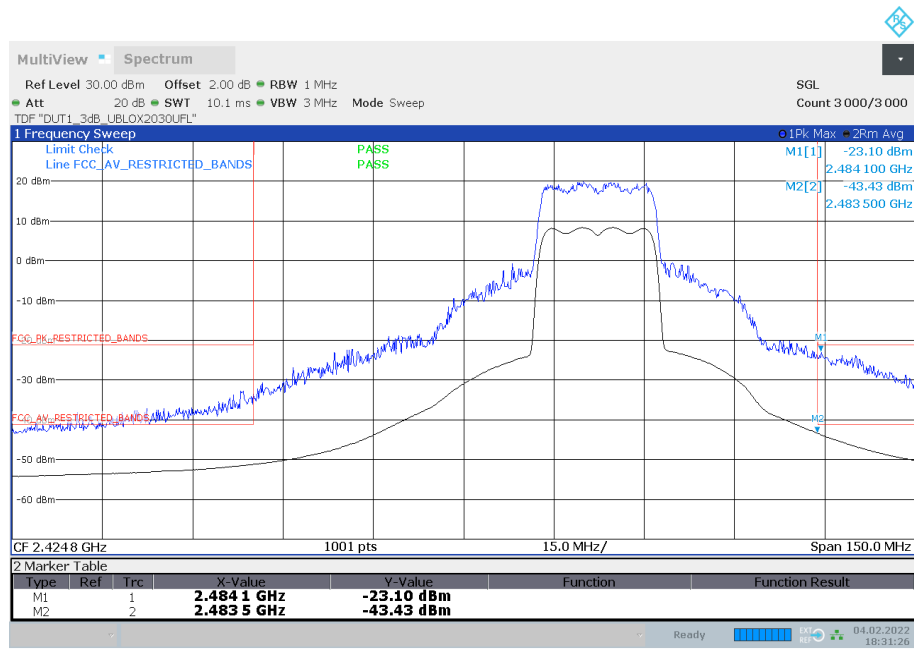

18:31:26 04.02.2022

4th highest Channel, high BE

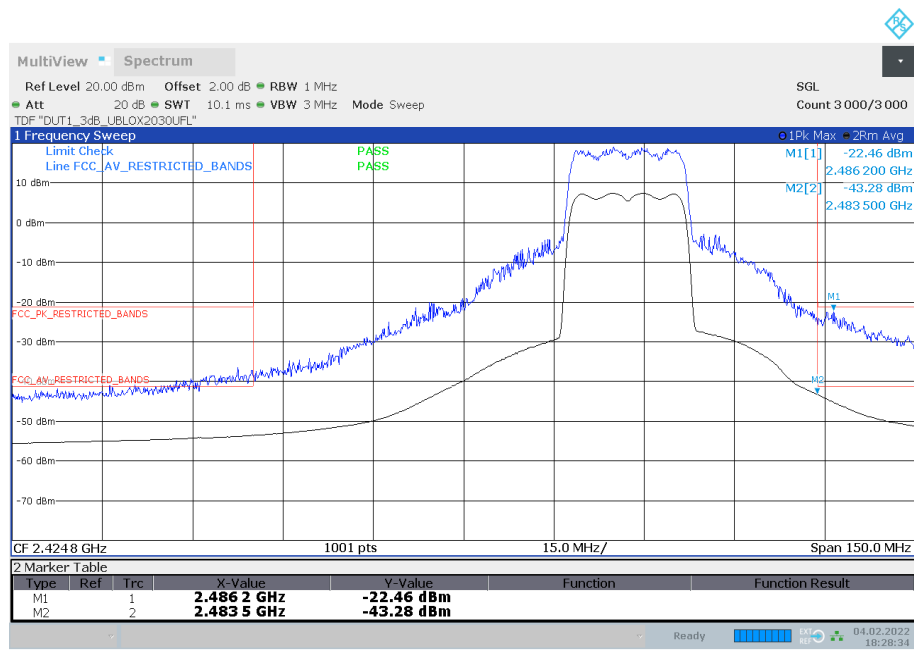

18:28:34 04.02.2022

3rd highest Channel, high BE

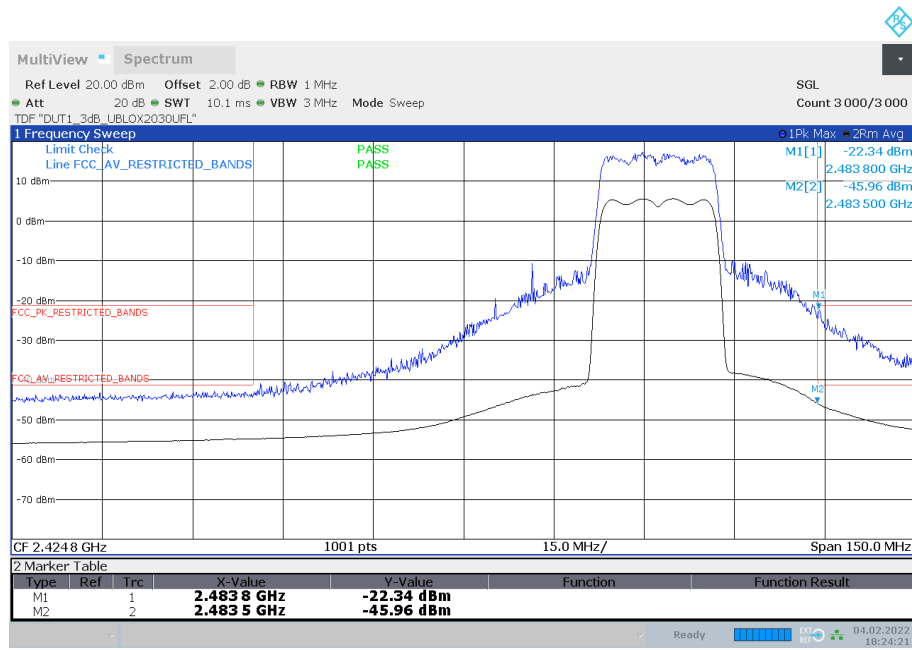

18:24:21 04.02.2022

2nd highest Channel, high BE

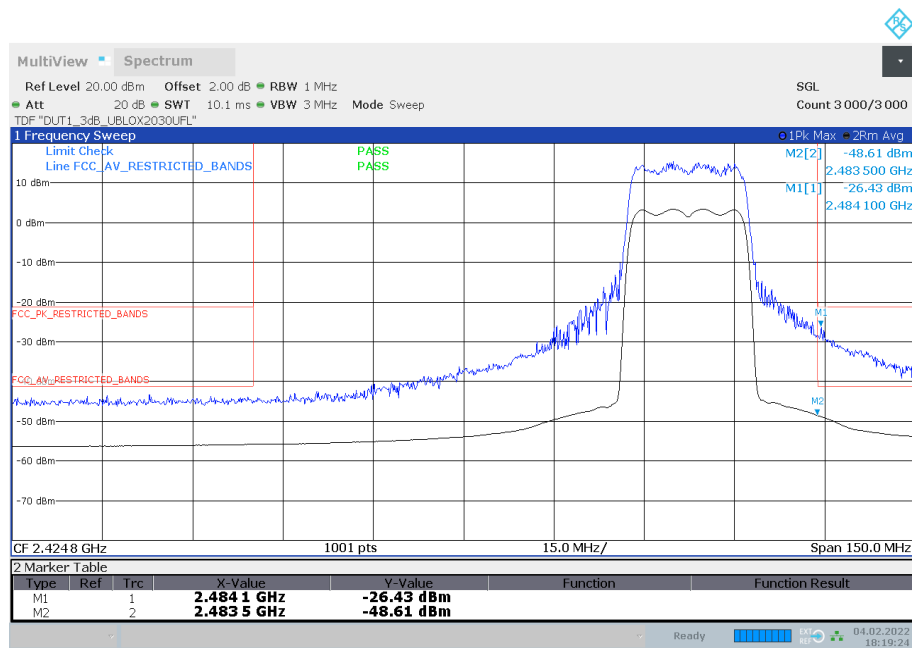

18:19:25 04.02.2022

Highest Channel, high BE

Radio Technology = WLAN ax 40 MHz, Operating Frequency = low + high, Band Edge = low + high
(S01_377_AA01)

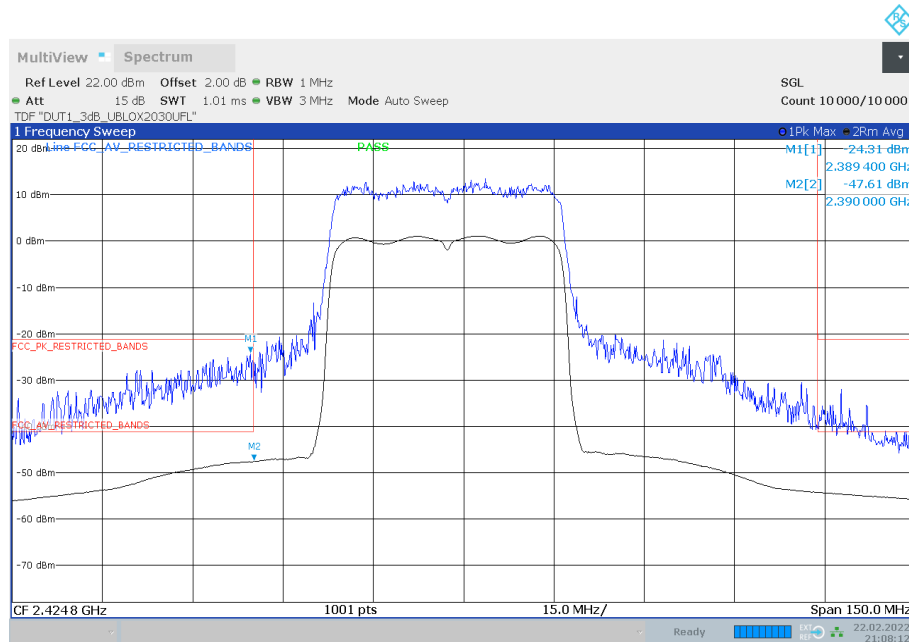

21:08:12 22.02.2022

Lowest Channel, low BE

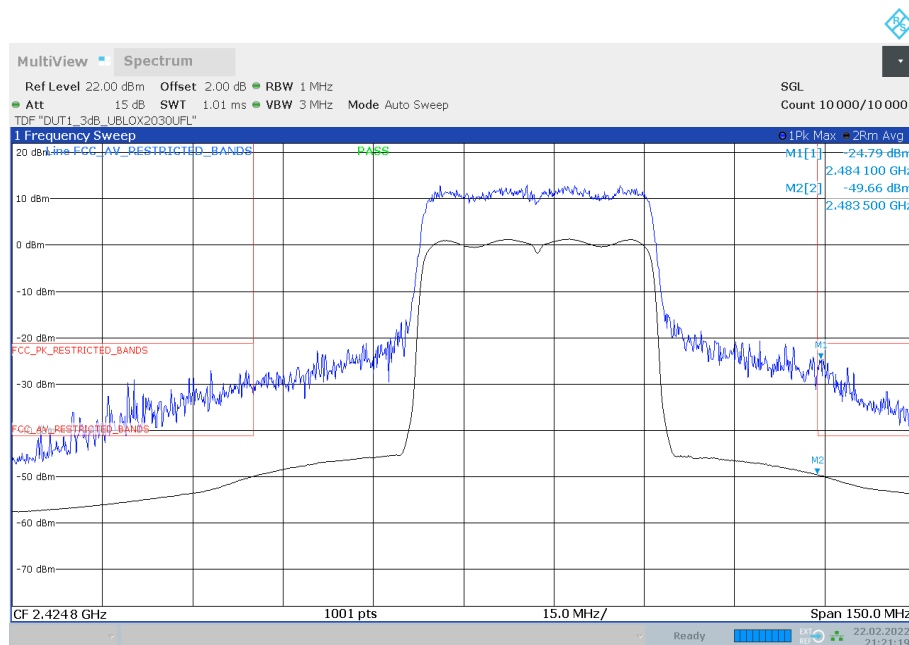

21:21:20 22.02.2022

Mid Channel, high BE

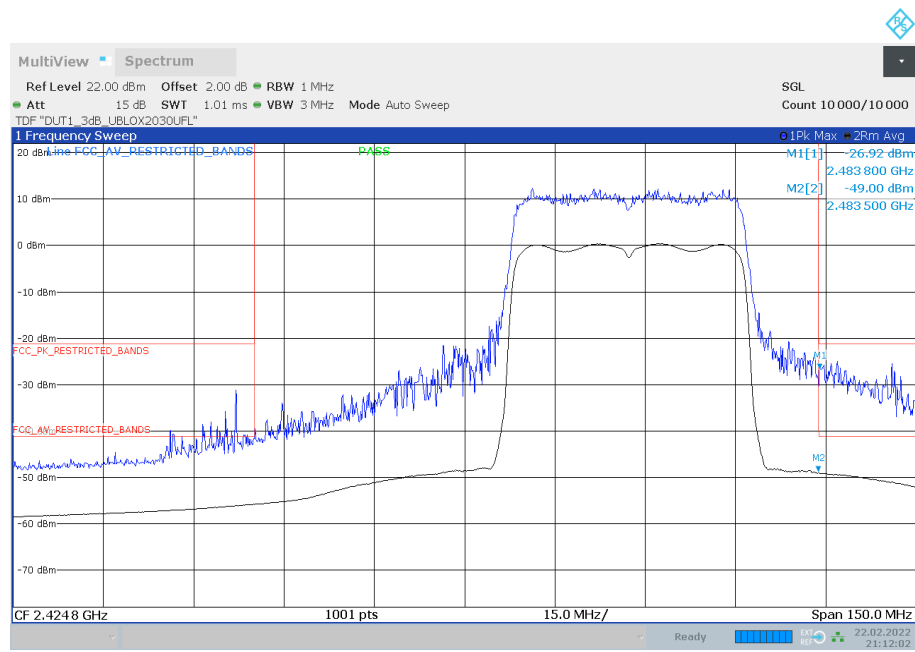

21:12:02 22.02.2022

Highest Channel, high BE

Radio Technology = WLAN n 20 MHz MIMO, Operating Frequency = high, Band Edge = high (S02_377_AD01)

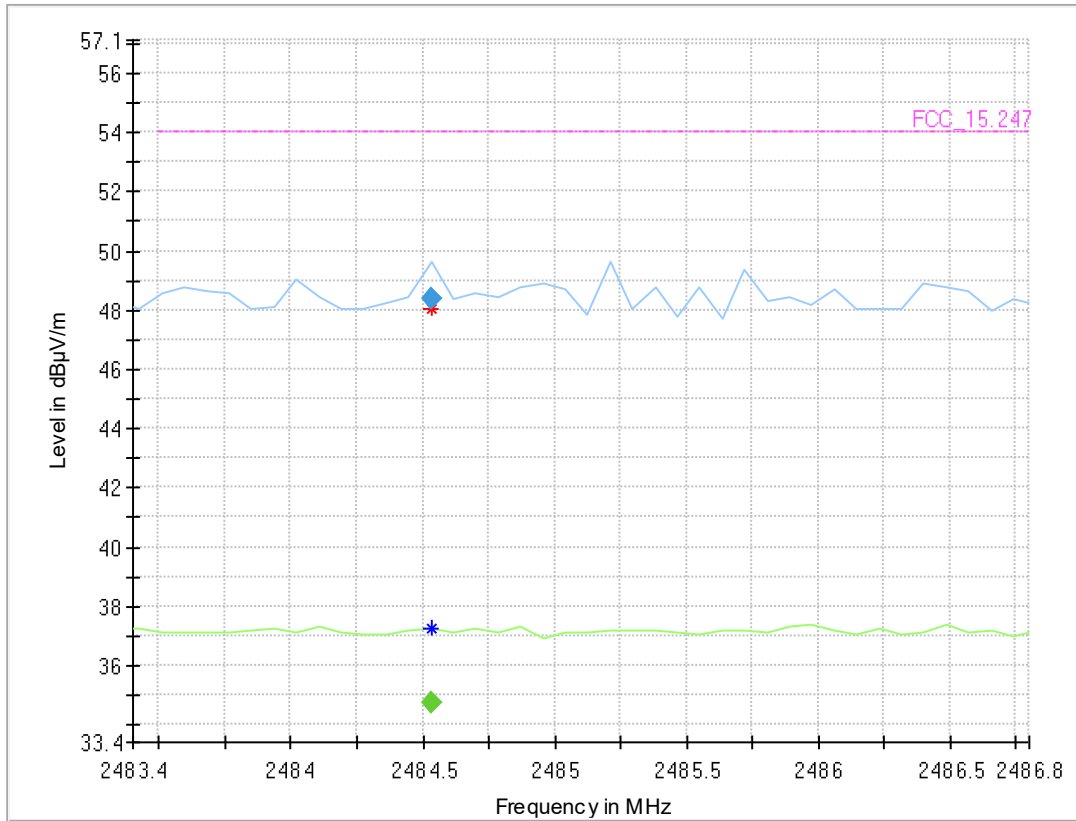

Final Result

Frequency (MHz)	MaxPeak (dBµV/m)	CAverage (dBµV/m)	Limit (dBµV/m)	Margin (dB)	Meas. Time (ms)	Bandwidth (kHz)	Height (cm)	Pol	Azimuth (deg)	Elevation (deg)	Corr. (dB/m)
2484.530	---	34.8	54.00	19.24	1000.0	1000.000	150.0	V	-187.0	15.0	5.3
2484.530	48.4	---	74.00	25.61	1000.0	1000.000	150.0	V	-187.0	15.0	5.3

Radio Technology = WLAN n 20 MHz MIMO, Operating Frequency = low + high, Band Edge = low + high (S01_377_AA01)

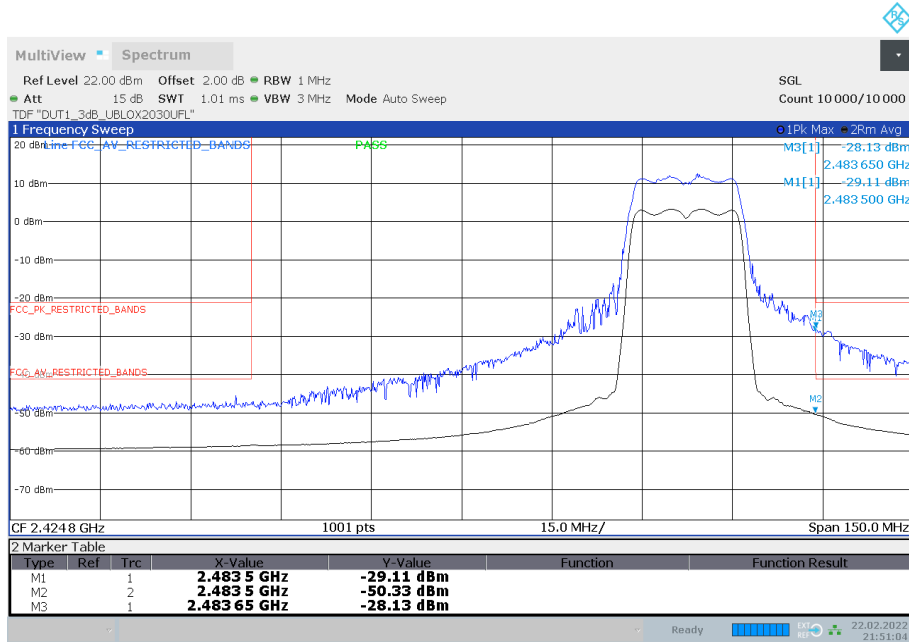

21:51:05 22.02.2022

Highest Channel, high BE, Antenna A

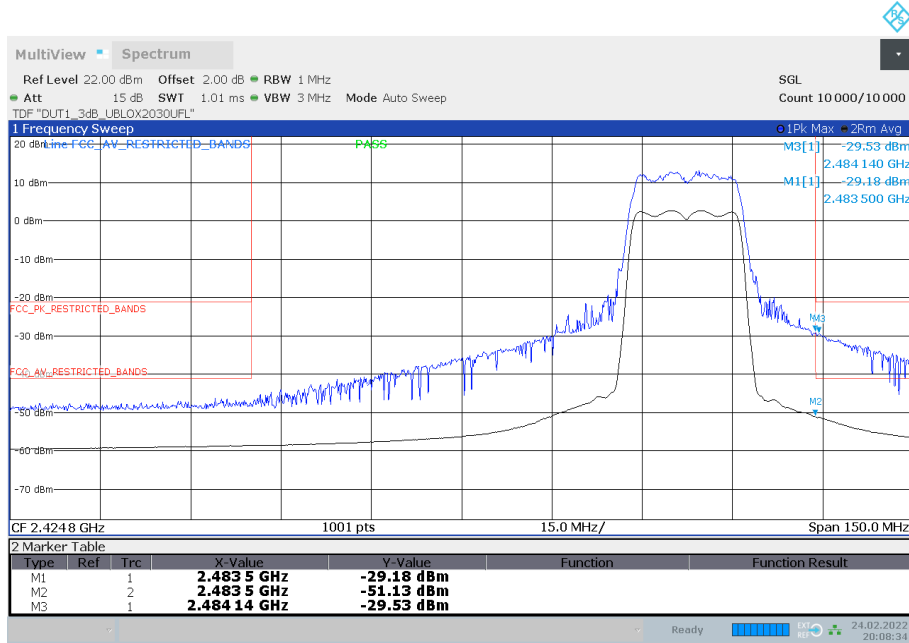

20:08:34 24.02.2022

Highest Channel, high BE, Antenna B

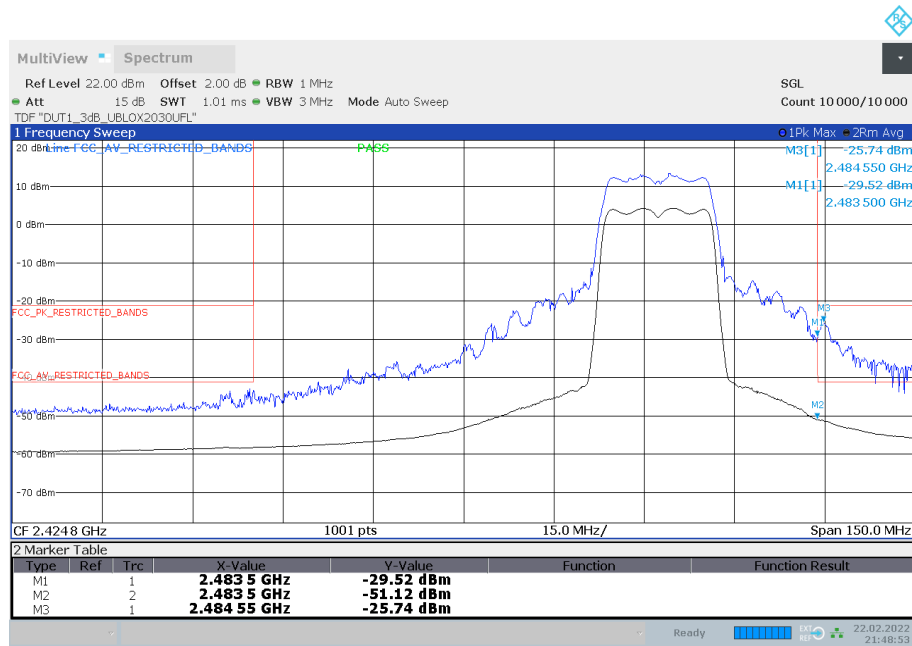

21:48:54 22.02.2022

2nd highest Channel, high BE, Antenna A

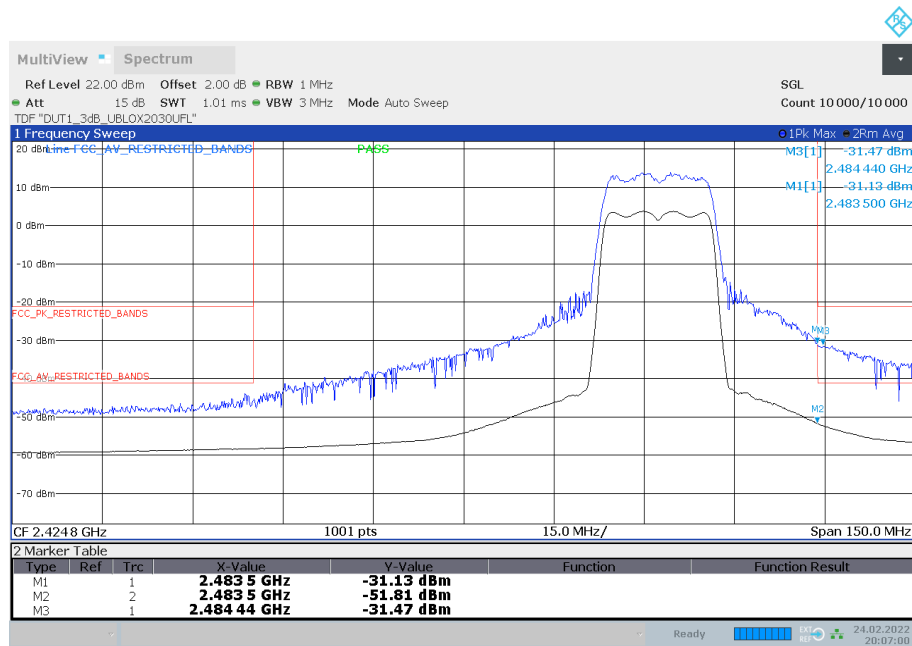

20:07:00 24.02.2022

2nd highest Channel, high BE, Antenna B

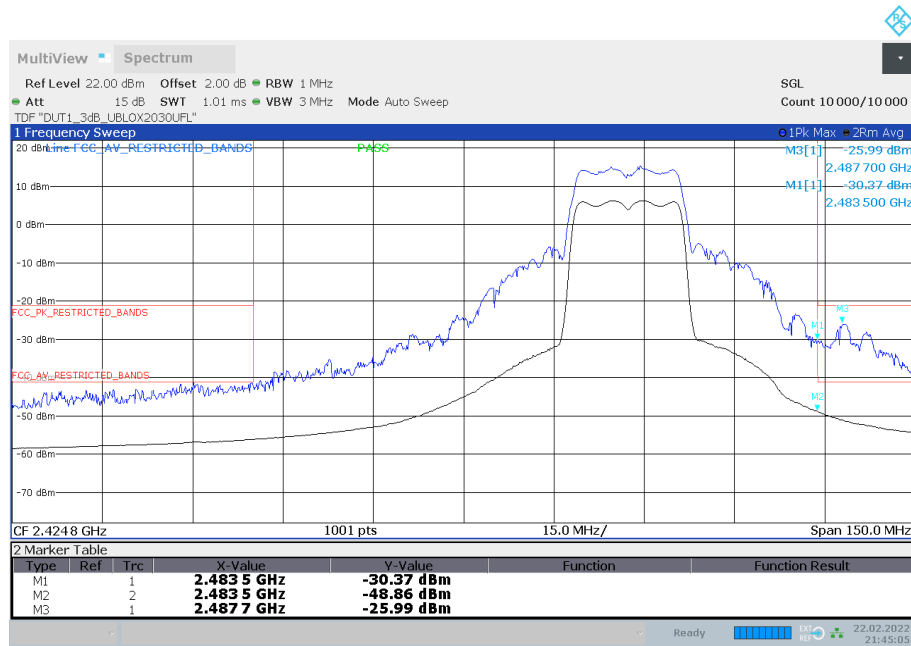

21:45:05 22.02.2022

3rd highest Channel, high BE, Antenna A

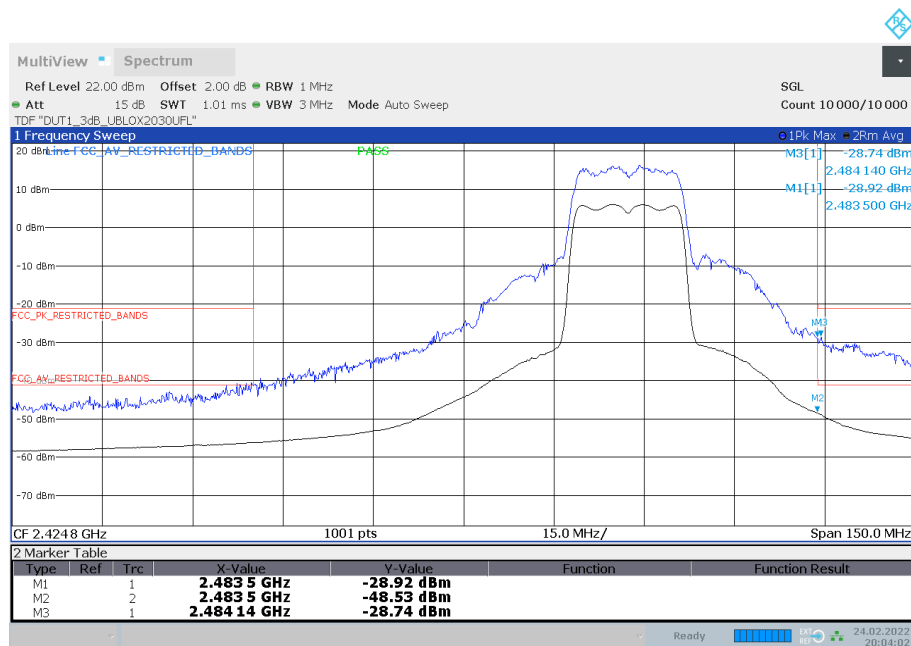

20:04:03 24.02.2022

3rd highest Channel, high BE, Antenna B

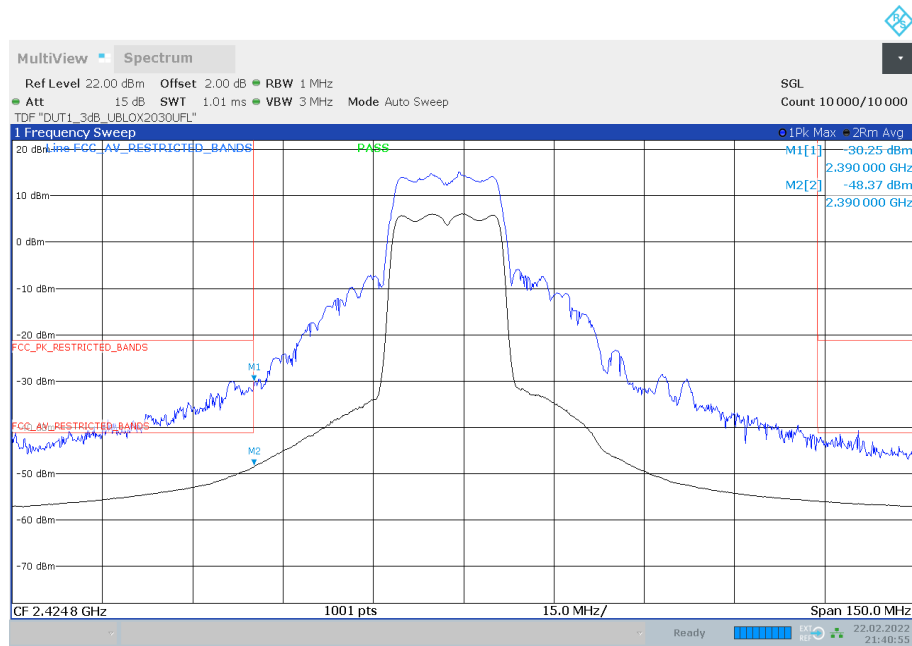

21:40:56 22.02.2022

3rd lowest Channel, low BE, Antenna A

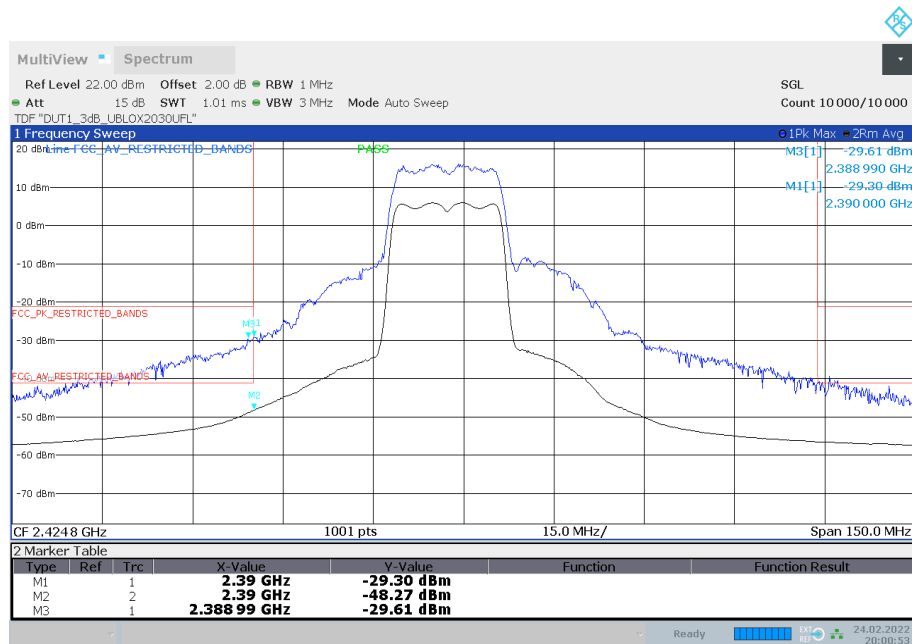

20:00:54 24.02.2022

3rd lowest Channel, low BE, Antenna B

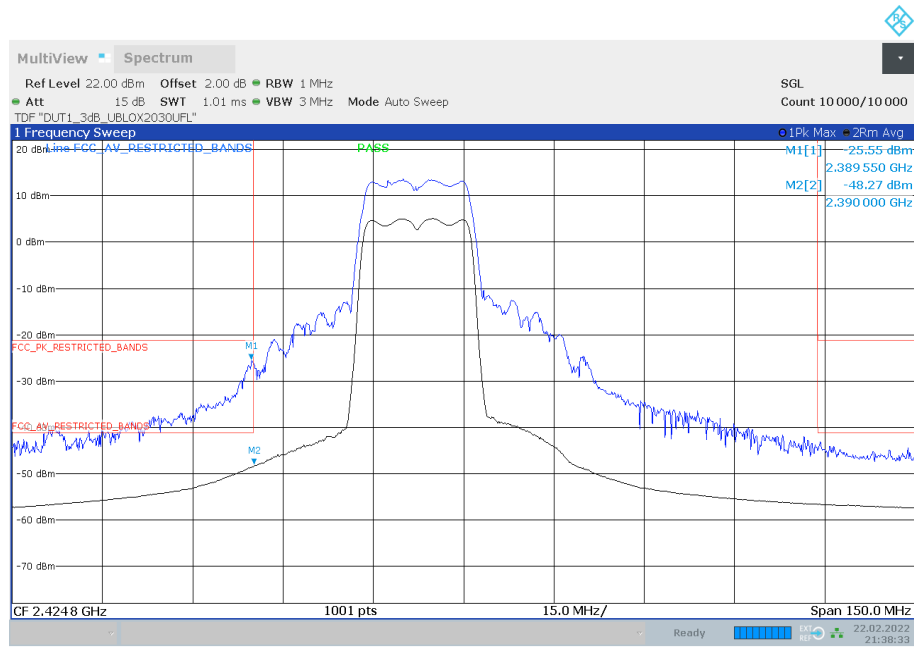

21:38:33 22.02.2022

2nd lowest Channel, low BE, Antenna A

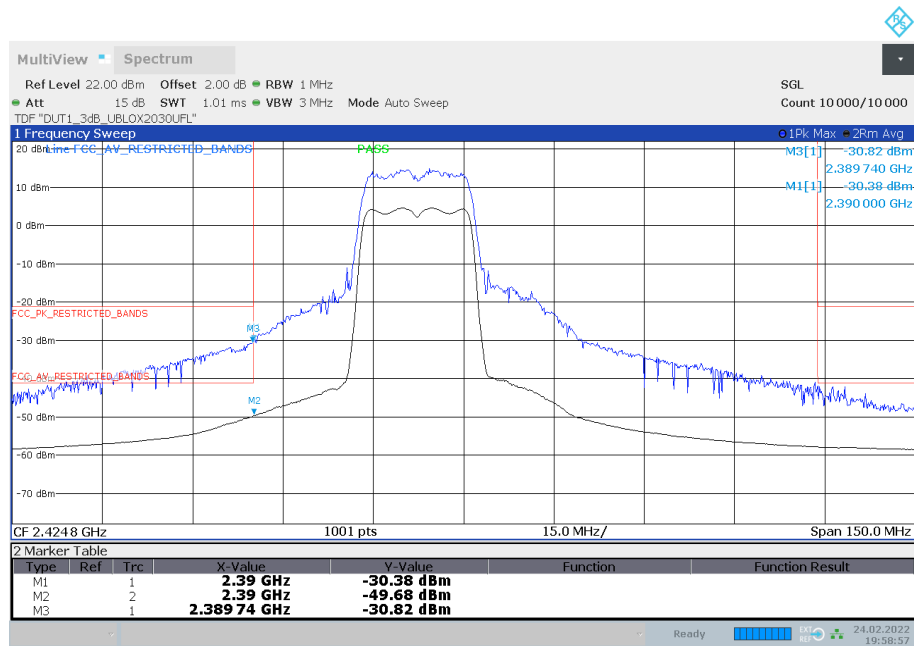

19:58:58 24.02.2022

2nd lowest Channel, low BE, Antenna B

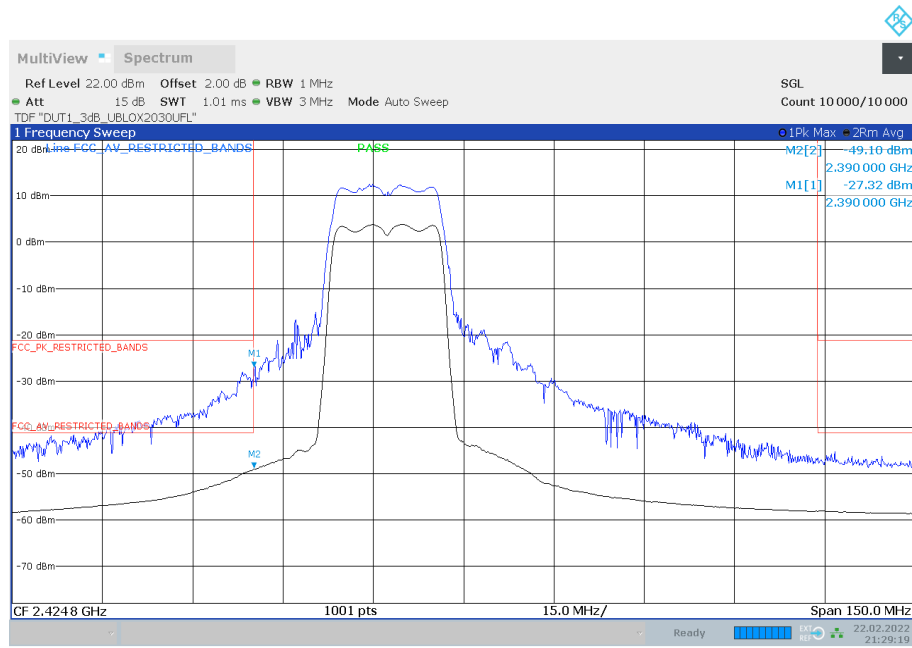

21:29:19 22.02.2022

Lowest Channel, low BE, Antenna A

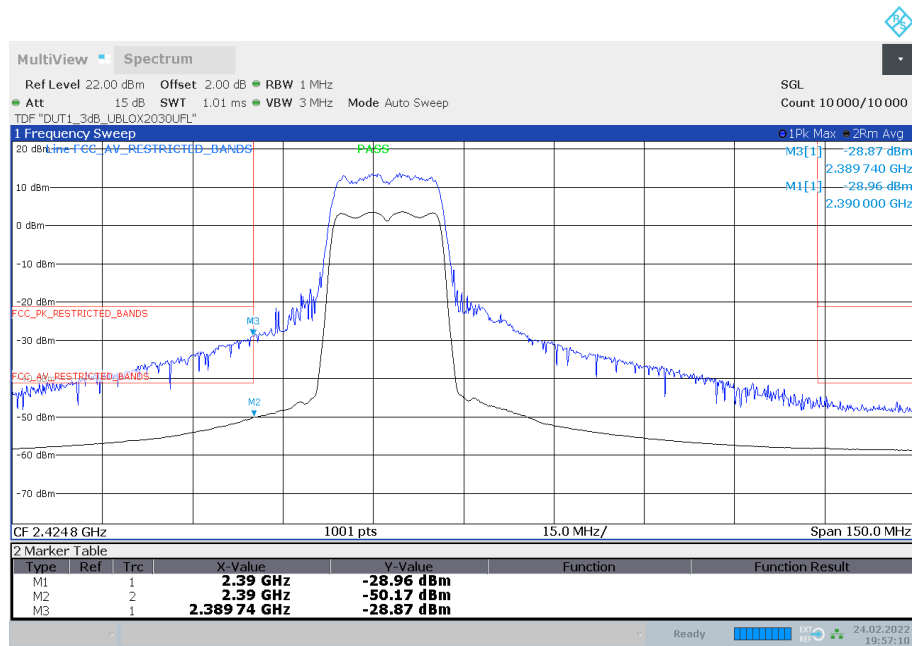

19:57:10 24.02.2022

Lowest Channel, low BE, Antenna B

Radio Technology = WLAN n 40 MHz MIMO, Operating Frequency = high, Band Edge = high (S02_377_AD01)

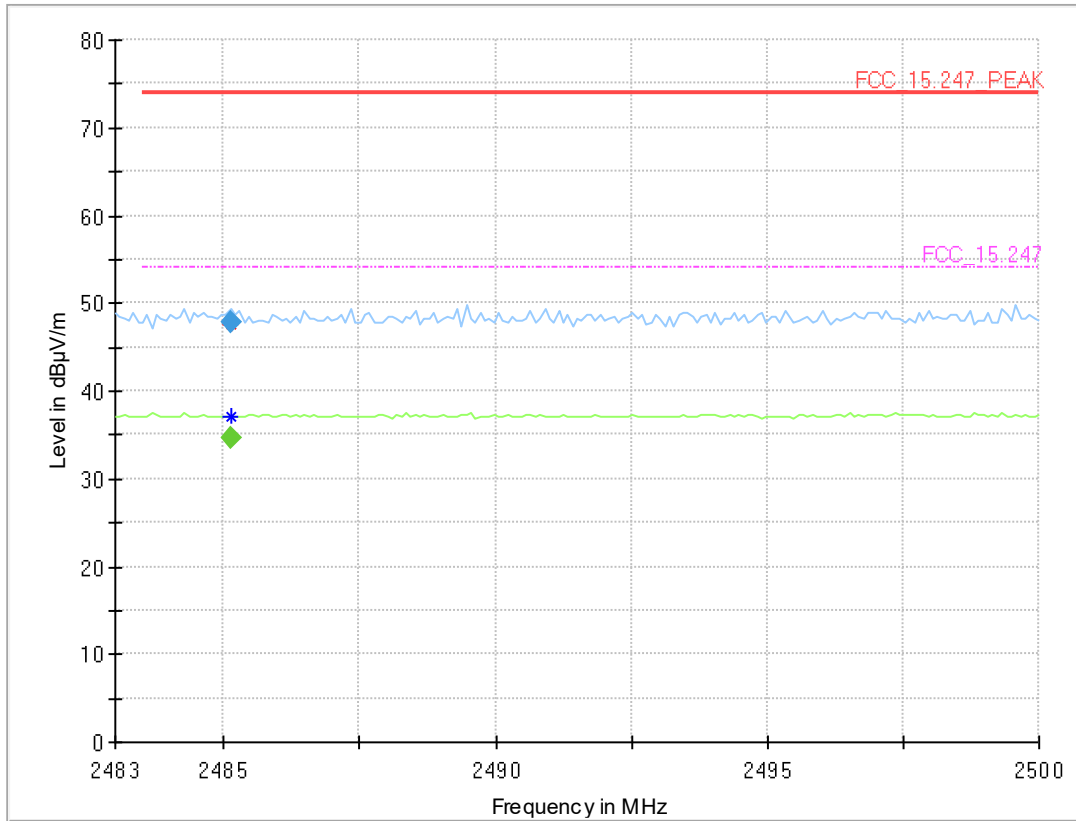

Final Result

Frequency (MHz)	MaxPeak (dBµV/m)	CAverage (dBµV/m)	Limit (dBµV/m)	Margin (dB)	Meas. Time (ms)	Bandwidth (kHz)	Height (cm)	Pol	Azimuth (deg)	Elevation (deg)	Corr. (dB/m)
2485.125	---	34.7	54.00	19.27	1000.0	1000.000	150.0	V	21.0	2.0	5.3
2485.125	47.9	---	74.00	26.07	1000.0	1000.000	150.0	V	21.0	2.0	5.3

Radio Technology = WLAN n 40 MHz MIMO, Operating Frequency = low + high, Band Edge = low + high (S01_377_AA01)

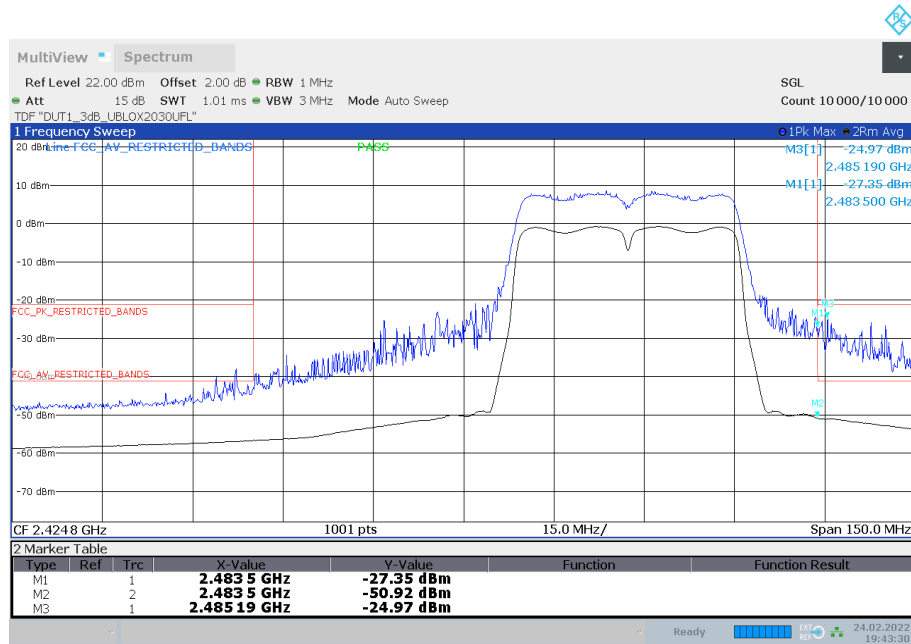

19:43:30 24.02.2022

Highest Channel, high BE, Antenna A

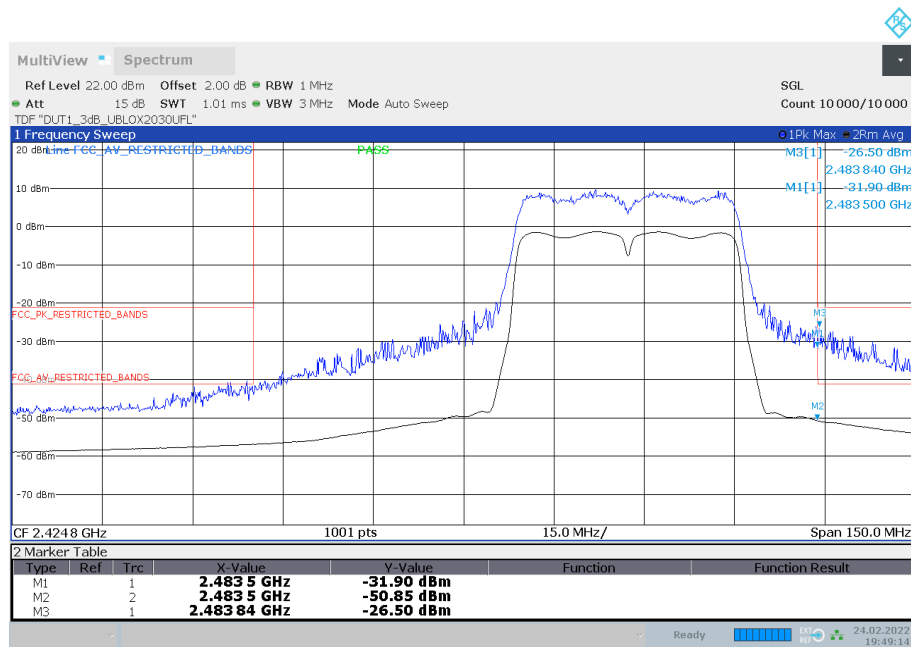

19:49:15 24.02.2022

Highest Channel, high BE, Antenna B

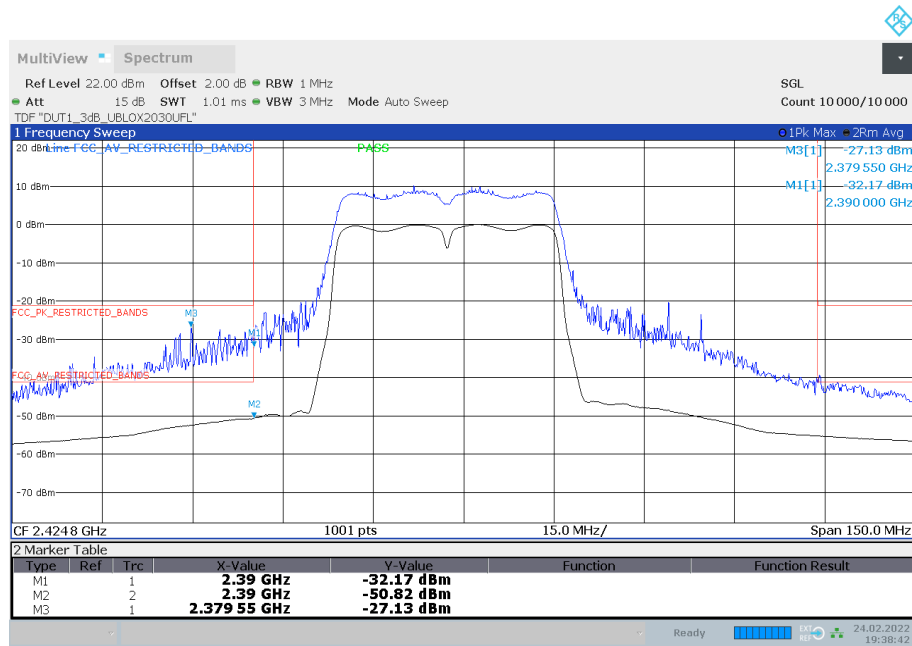

19:38:43 24.02.2022

Lowest Channel, low BE, Antenna A

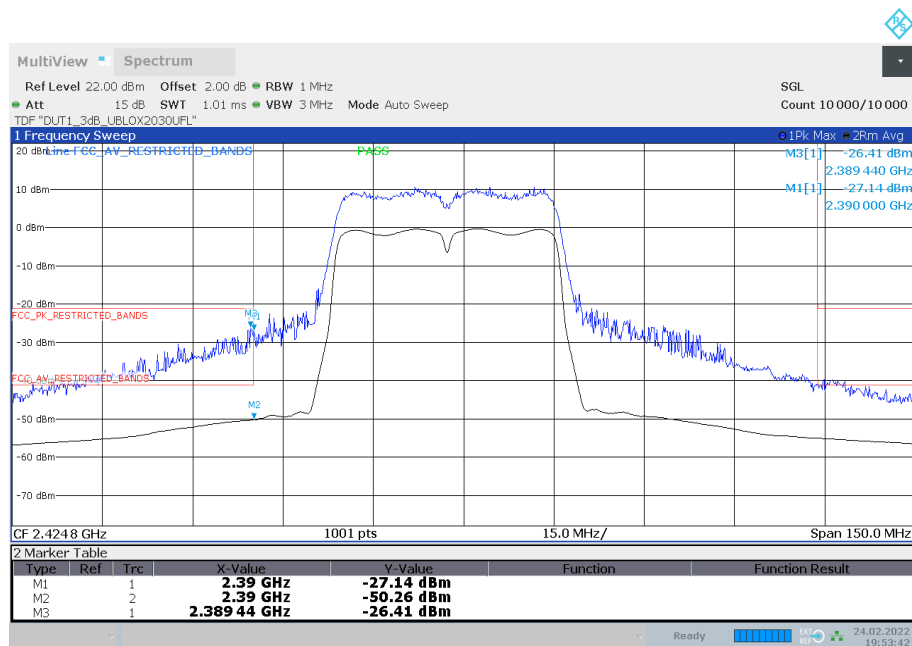

19:53:43 24.02.2022

Lowest Channel, low BE, Antenna B

Radio Technology = WLAN ax 20 MHz MIMO, Operating Frequency = high, Band Edge = high (S01_377_AA01)

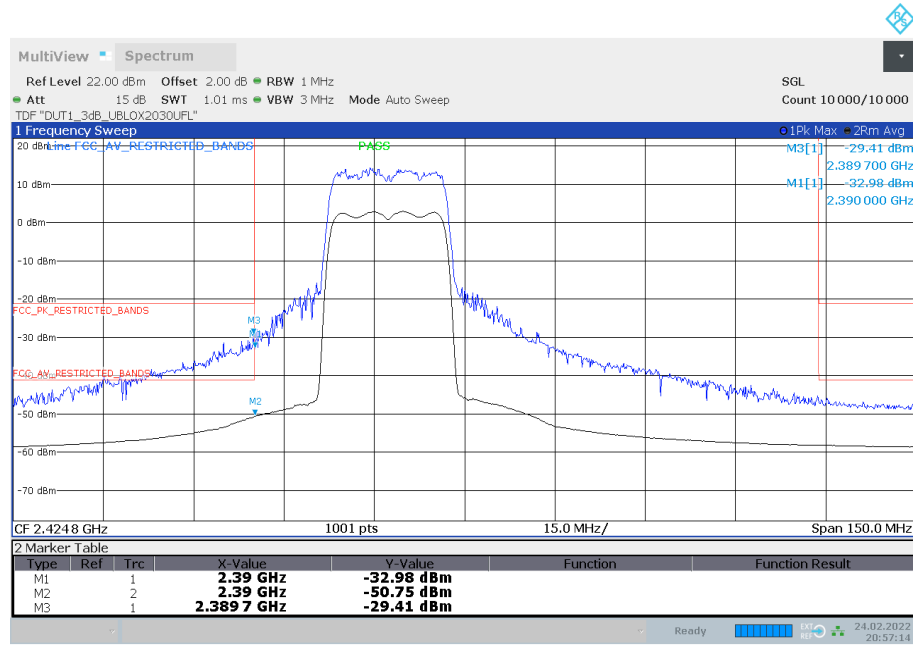

20:57:15 24.02.2022

Lowest Channel, low BE, Antenna A

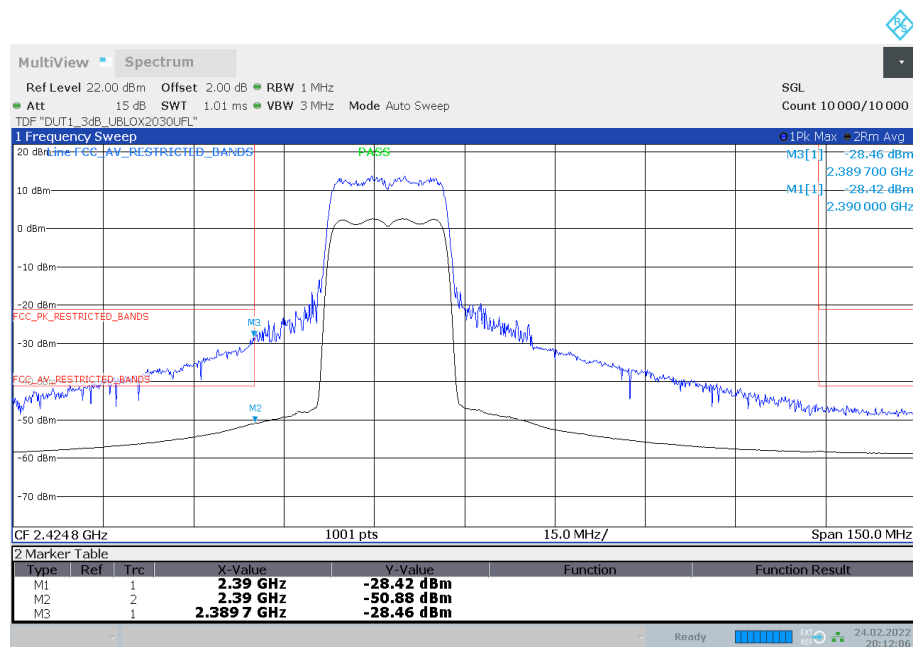

20:12:06 24.02.2022

Lowest Channel, low BE, Antenna B

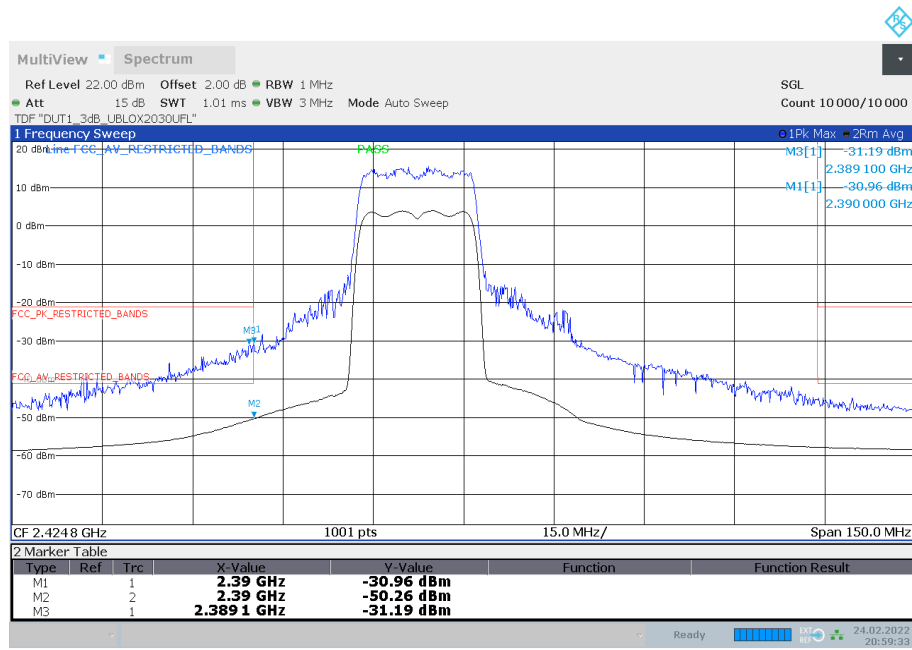

20:59:34 24.02.2022

2nd lowest Channel, low BE, Antenna A

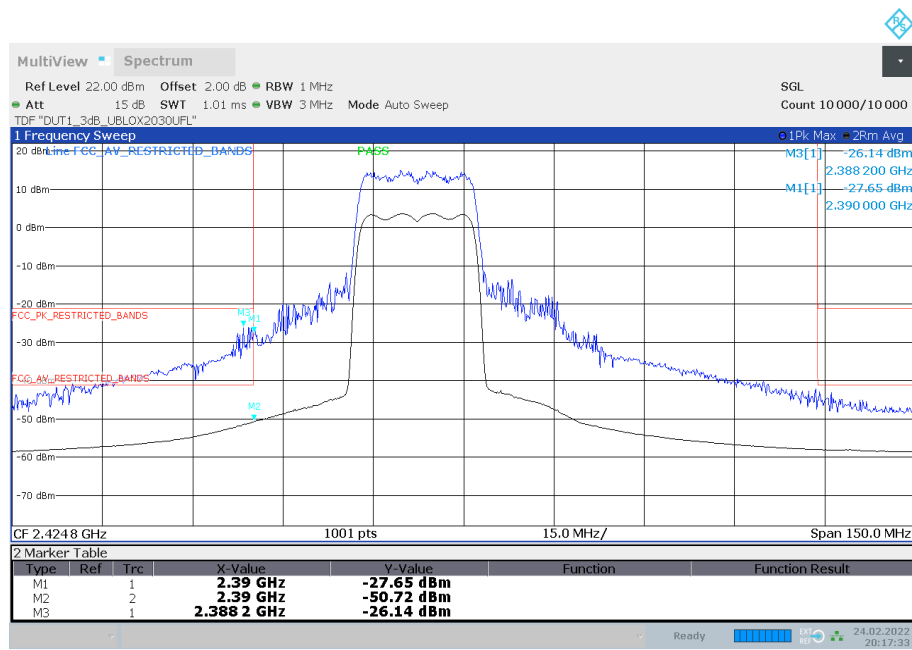

20:17:33 24.02.2022

2nd lowest Channel, low BE, Antenna B

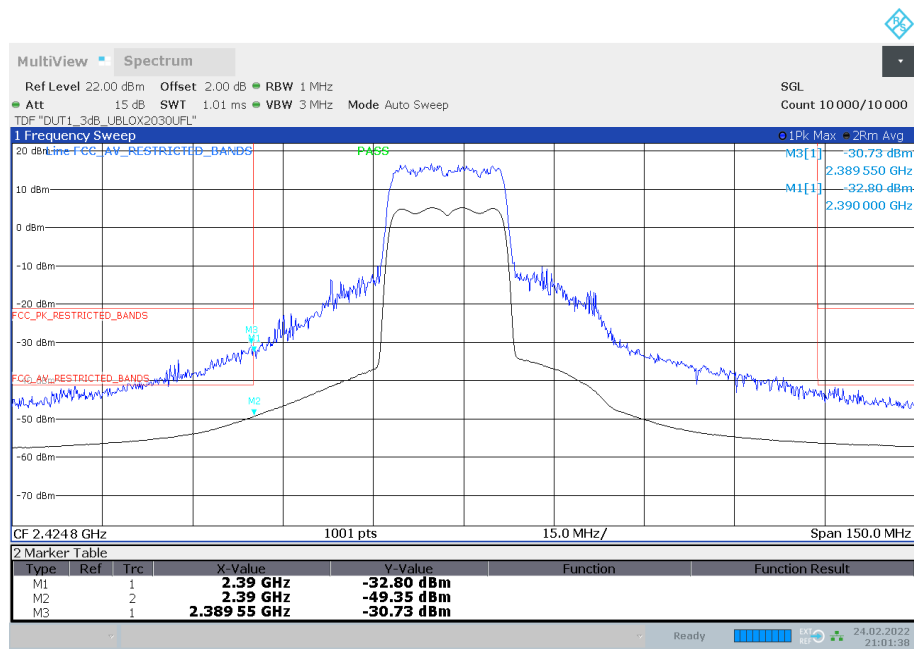

21:01:39 24.02.2022

3rd lowest Channel, low BE, Antenna A

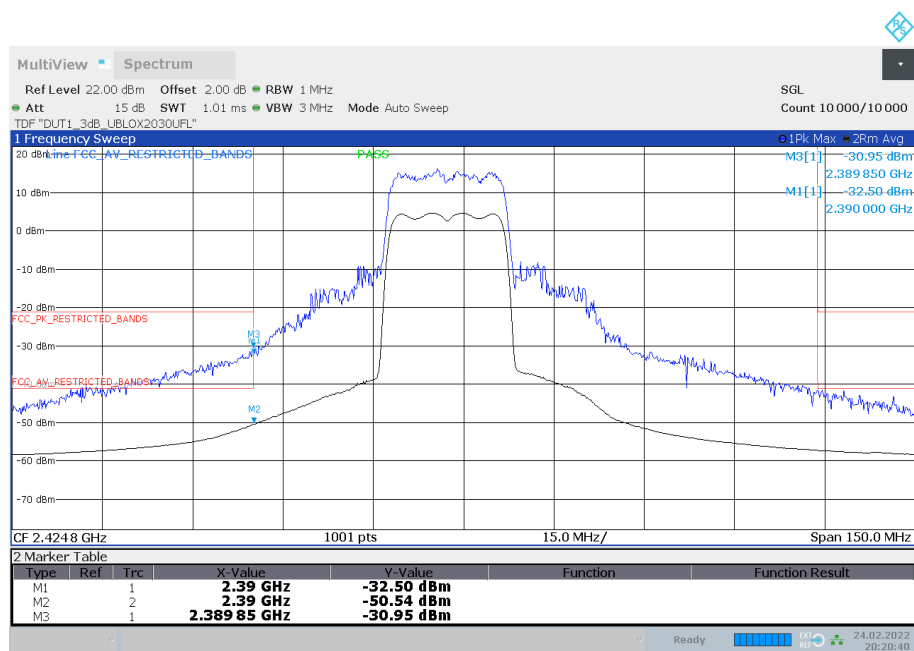

20:20:40 24.02.2022

3rd lowest Channel, low BE, Antenna B

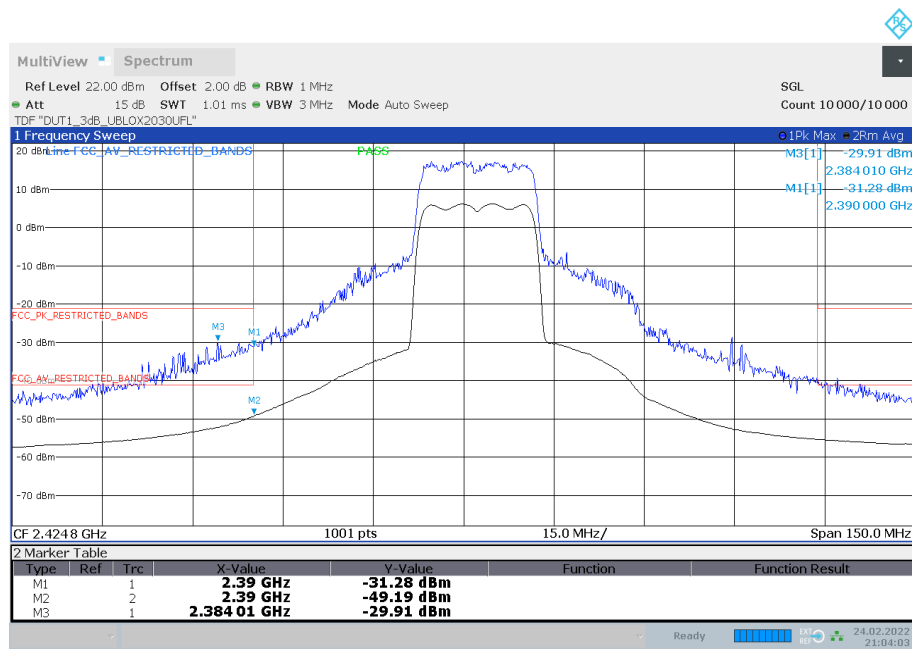

21:04:04 24.02.2022

4th lowest Channel, low BE, Antenna A

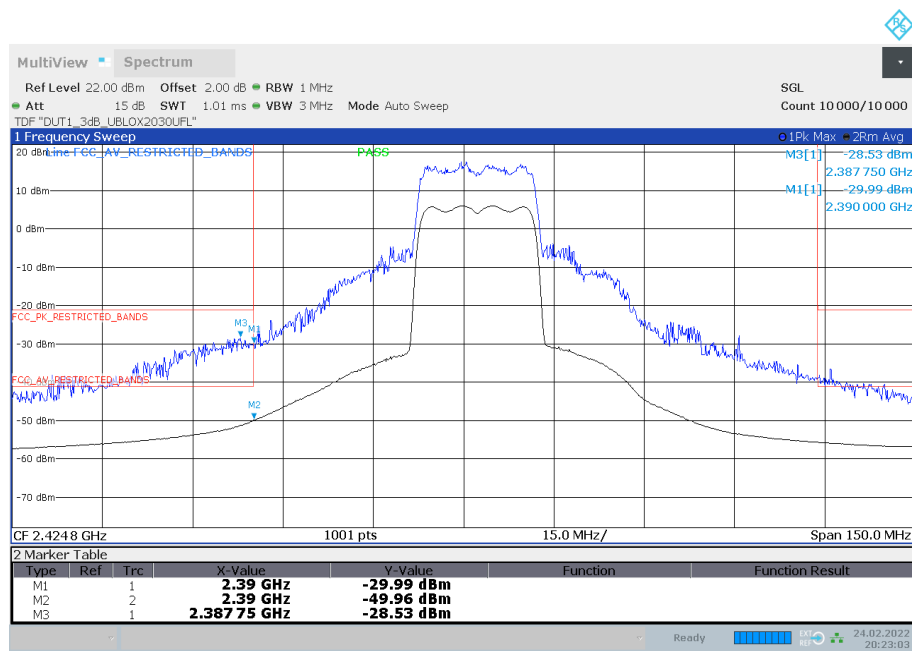

20:23:03 24.02.2022

4th lowest Channel, low BE, Antenna B

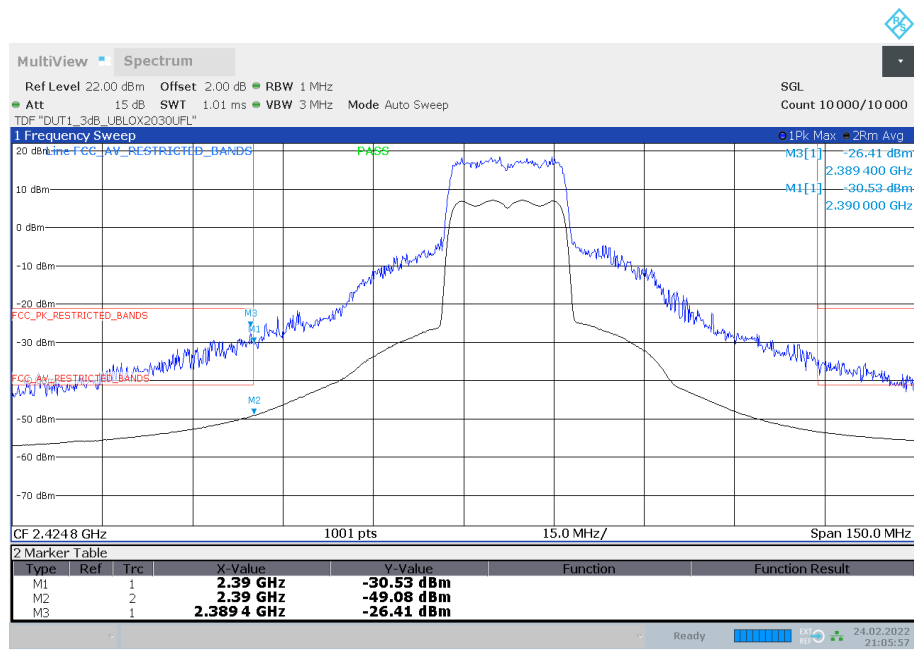

21:05:58 24.02.2022

5th lowest Channel, low BE, Antenna A

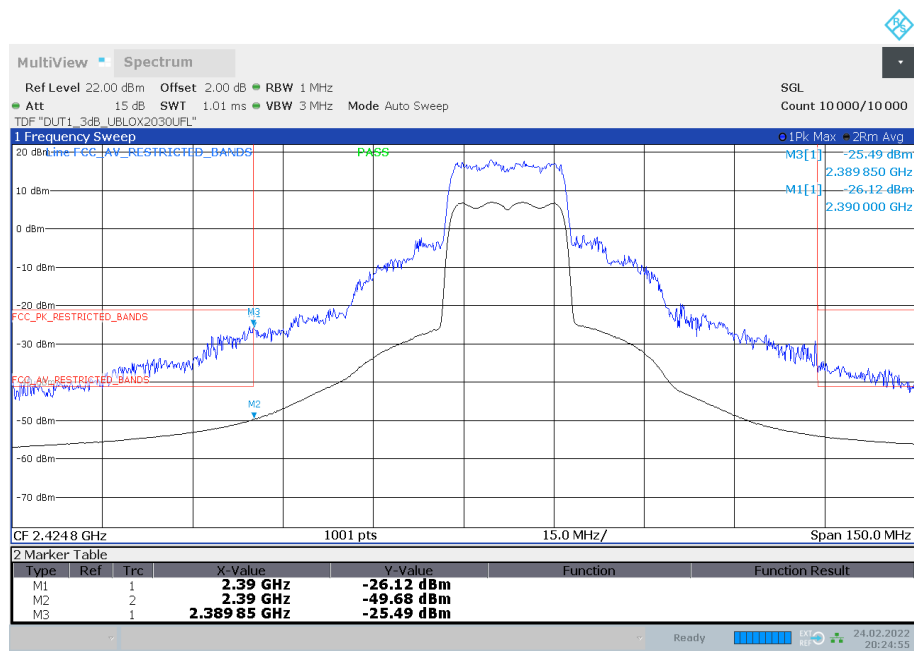

20:24:56 24.02.2022

5th lowest Channel, low BE, Antenna B

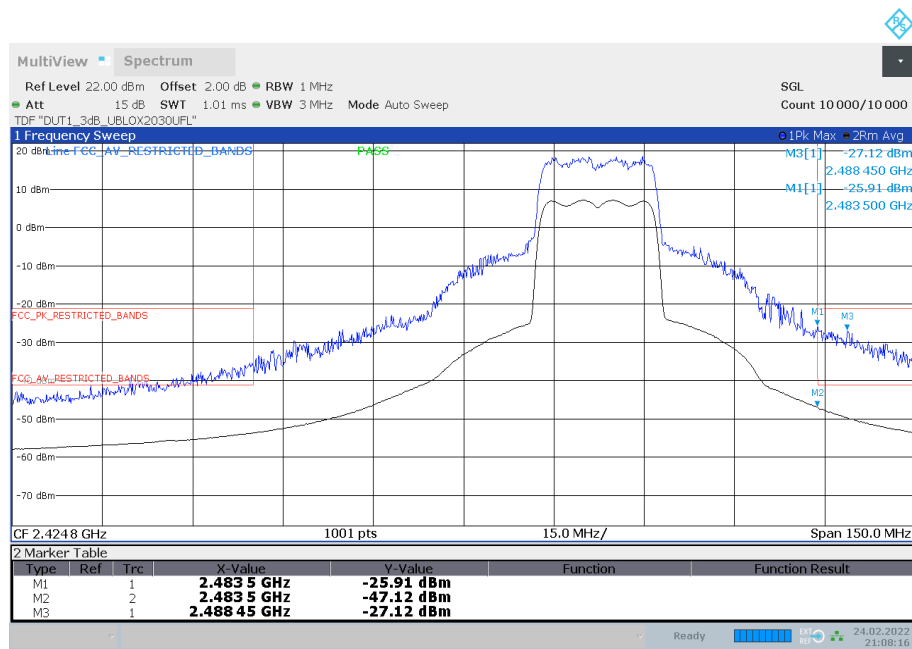

21:08:16 24.02.2022

4th highest Channel, high BE, Antenna A

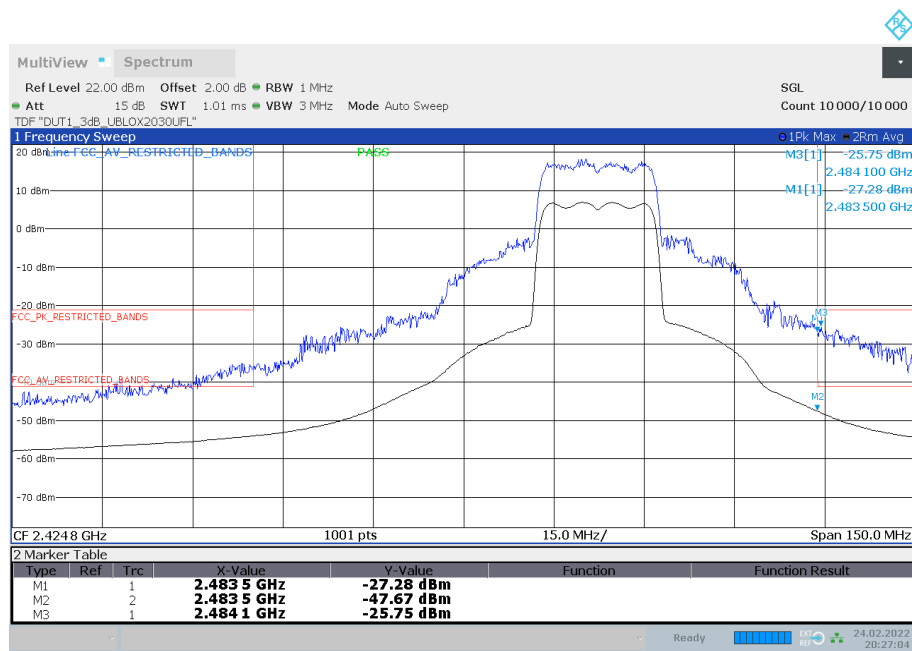

20:27:05 24.02.2022

4th highest Channel, high BE, Antenna B

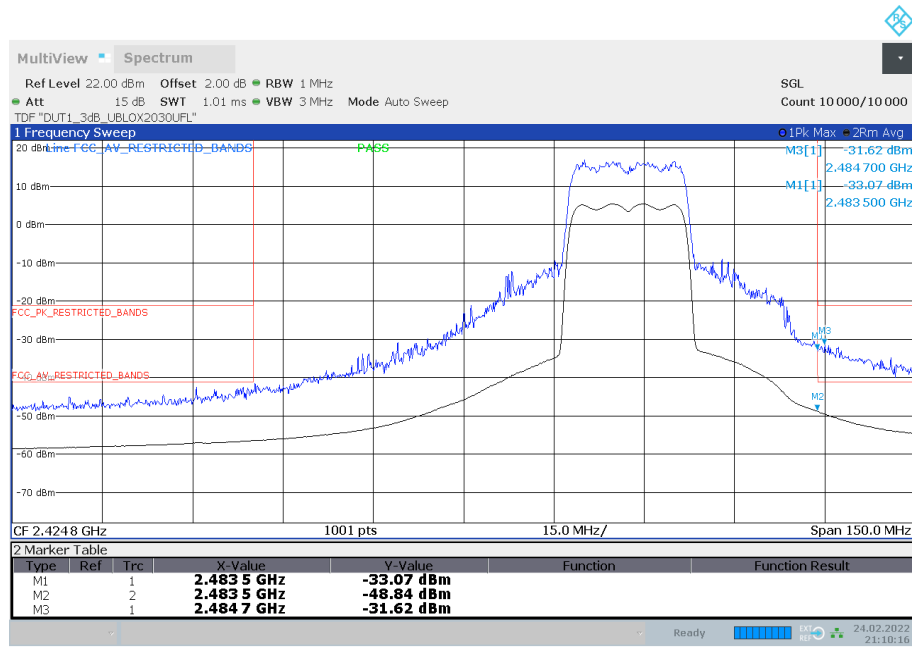

21:10:17 24.02.2022

3rd highest Channel, high BE, Antenna A

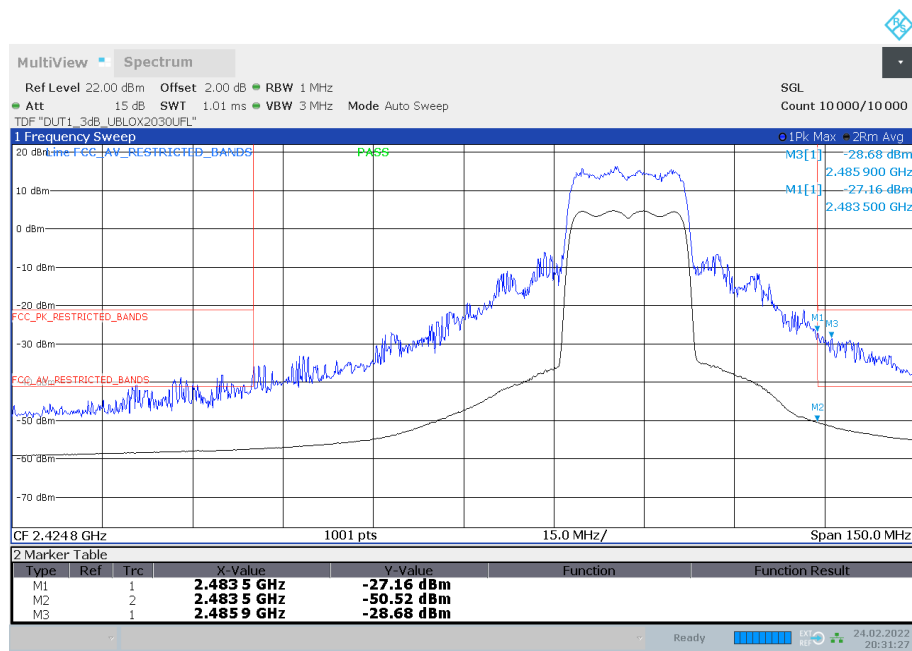

20:31:28 24.02.2022

3rd highest Channel, high BE, Antenna B

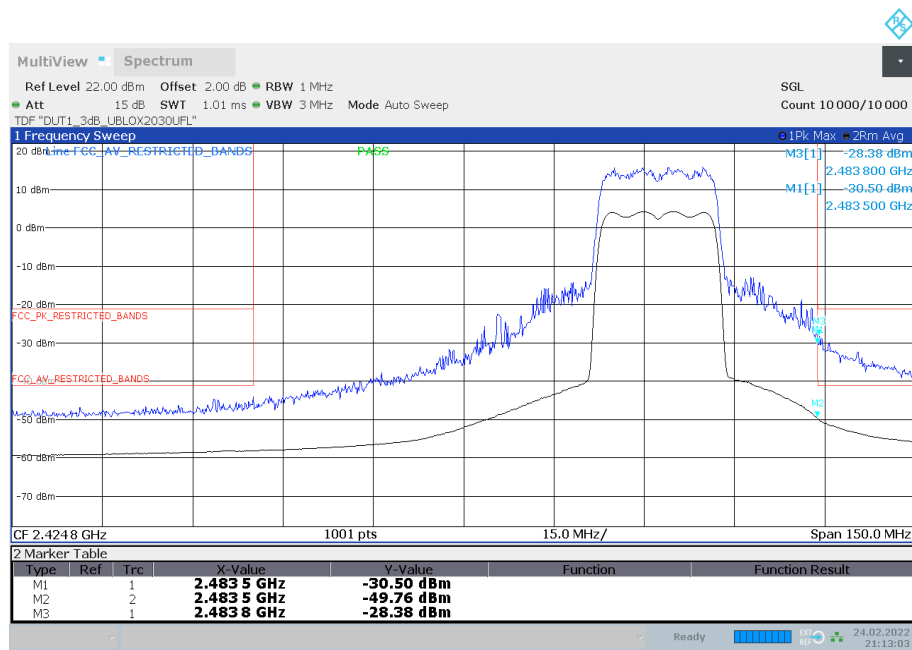

21:13:04 24.02.2022

2nd highest Channel, high BE, Antenna A

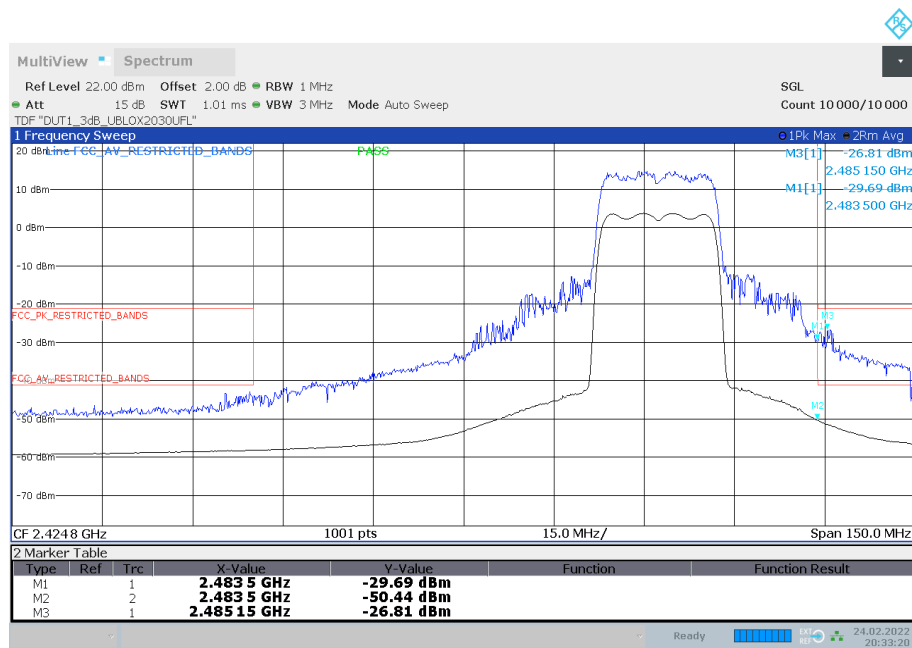

20:33:20 24.02.2022

2nd highest Channel, high BE, Antenna B

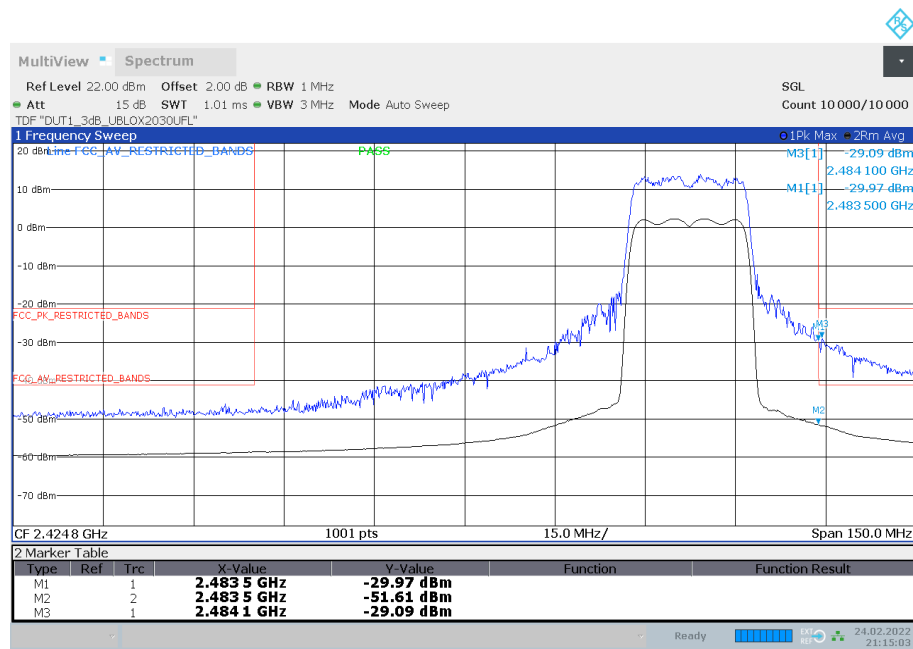

21:15:04 24.02.2022

Highest Channel, high BE, Antenna A

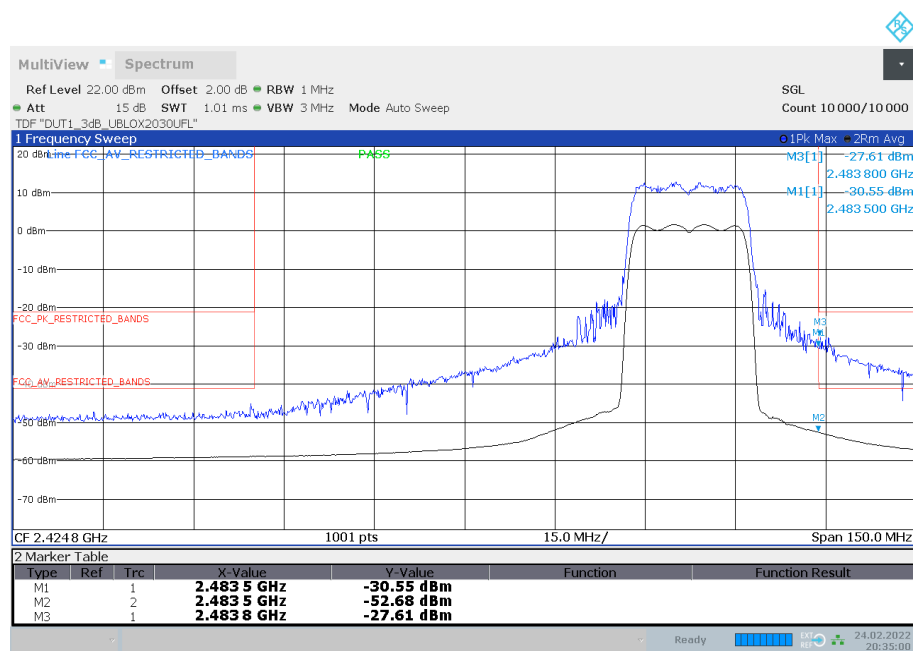

20:35:01 24.02.2022

Highest Channel, high BE, Antenna B

Radio Technology = WLAN ax 40 MHz MIMO, Operating Frequency = high, Band Edge = high (S01_377_AA01)

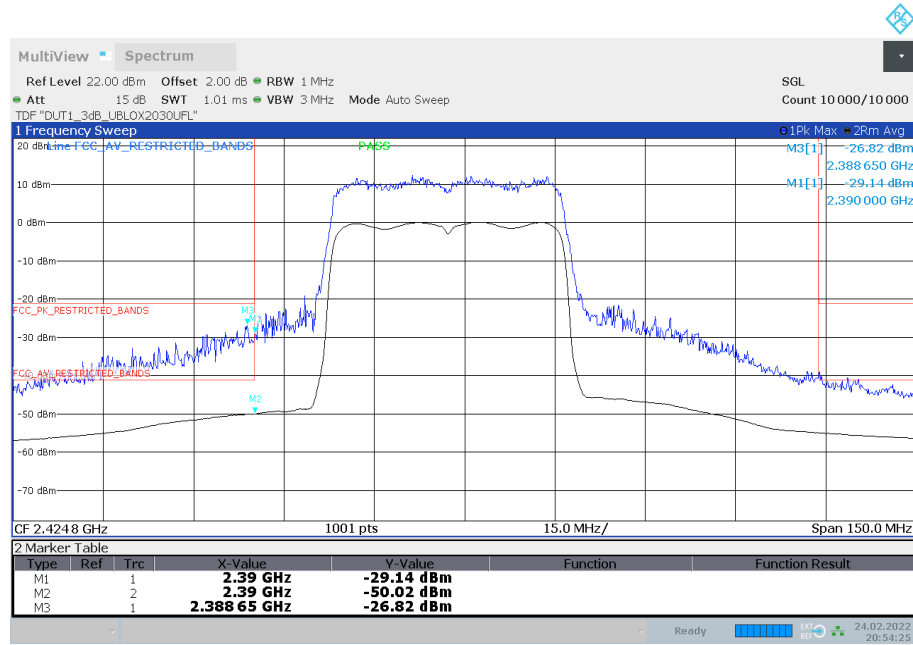

20:54:26 24.02.2022

Lowest Channel, low BE, Antenna A

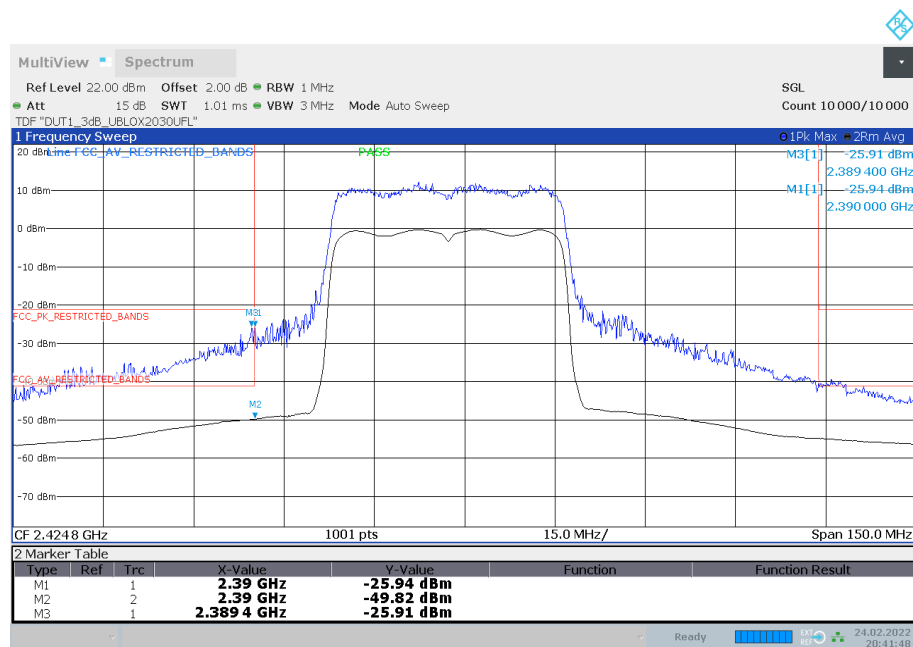

20:41:49 24.02.2022

Lowest Channel, low BE, Antenna B

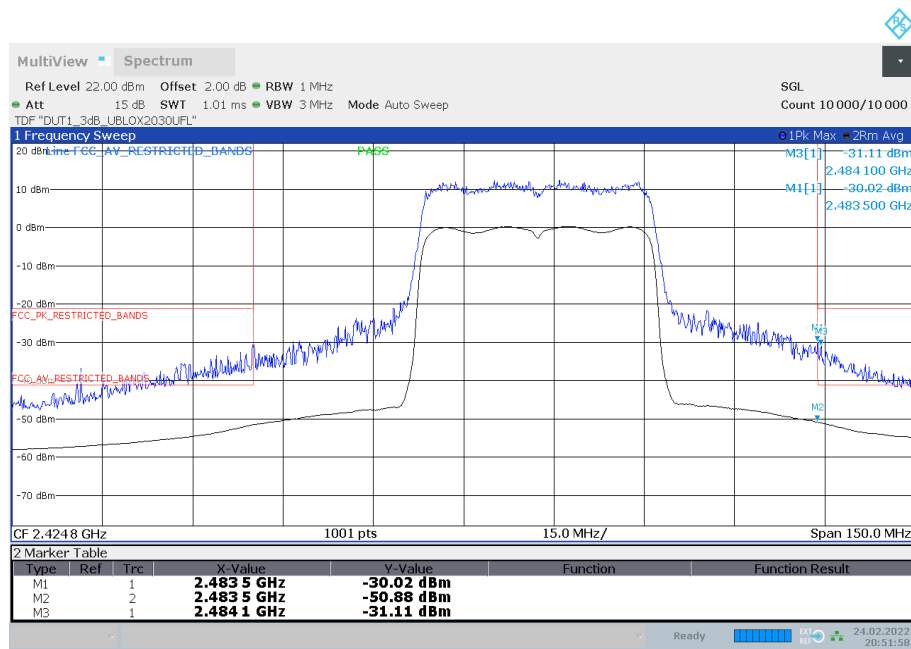

20:51:59 24.02.2022

Mid Channel, low BE, Antenna A

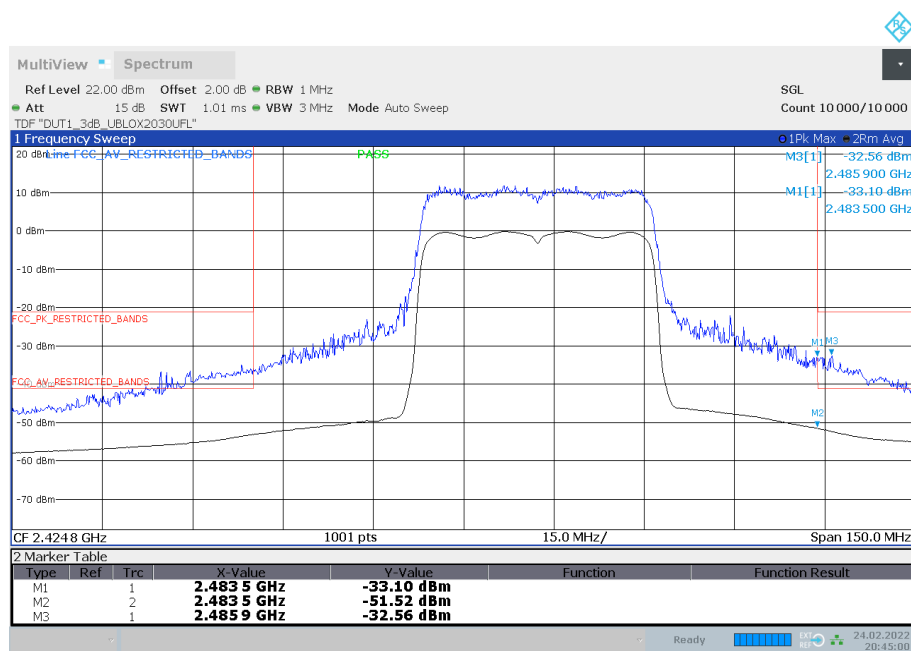

20:45:01 24.02.2022

Mid Channel, low BE, Antenna B

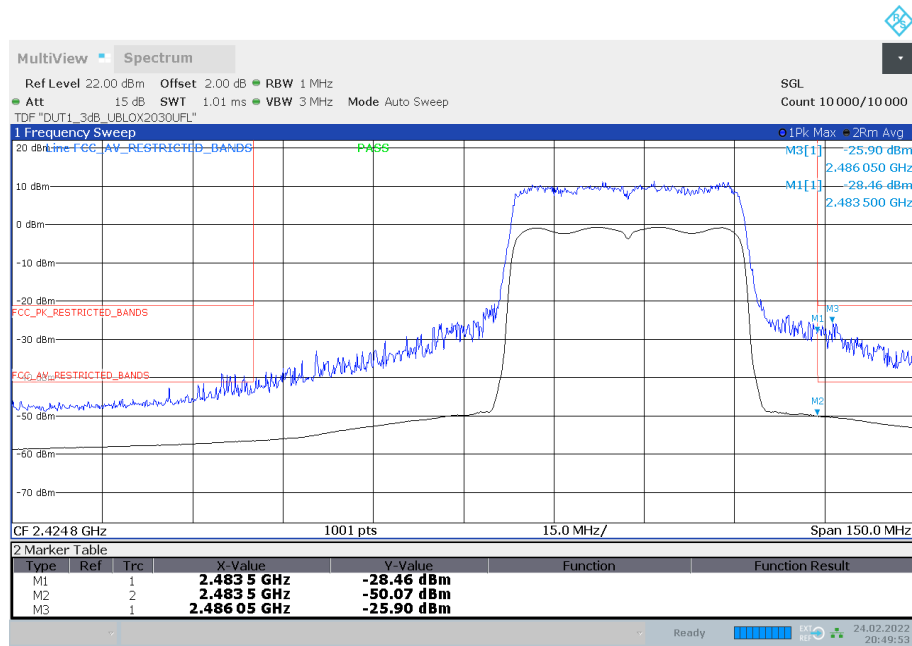

20:49:53 24.02.2022

Highest Channel, high BE, Antenna A

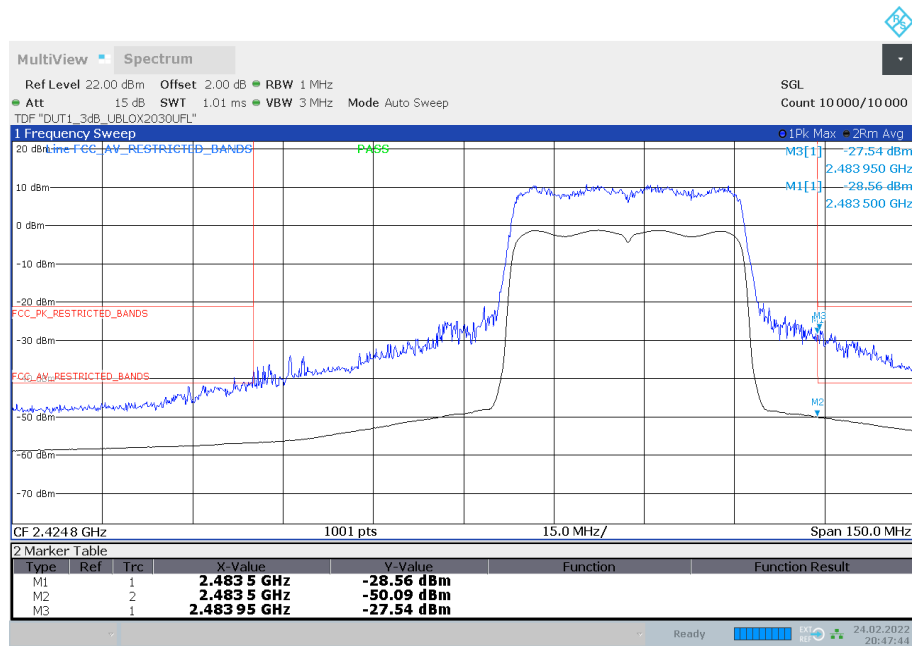

20:47:45 24.02.2022

Highest Channel, high BE, Antenna B