

# FCC Measurement/Technical Report on WLAN and Bluetooth module JODY-W2

FCC ID: XPYJODYW263  
IC: 8595A-JODYW263

**Test Report Reference:** MDE\_UBLOX\_2312\_FCC\_02\_rev01

**Test Laboratory:**

7layers GmbH  
Borsigstrasse 11  
40880 Ratingen  
Germany



Deutsche  
Akkreditierungsstelle  
D-PL-12140-01-01  
D-PL-12140-01-02  
D-PL-12140-01-03

**Note:**

The following test results relate only to the devices specified in this document. This report shall not be reproduced in parts without the written approval of the test laboratory.

**7layers GmbH**

Borsigstraße 11  
40880 Ratingen, Germany  
T +49 (0) 2102 749 0  
F +49 (0) 2102 749 350

Geschäftsführer/  
Managing Directors:  
Sebastian Doose  
Bernhard Retka

Registergericht/registered:  
Düsseldorf HRB 75554  
USt-Id.-Nr./VAT-No. DE203159652  
Steuer-Nr./TAX-No. 147/5869/0385

a Bureau Veritas  
Group Company

[www.7layers.com](http://www.7layers.com)

## Table of Contents

<b>1 Applied Standards and Test Summary</b>	<b>3</b>
1.1 Applied Standards	3
1.2 FCC-IC Correlation Table	4
1.3 Measurement Summary	4
<b>2 Revision History / Signatures</b>	<b>7</b>
<b>3 Administrative Data</b>	<b>8</b>
3.1 Testing Laboratory	8
3.2 Project Data	8
3.3 Applicant Data	8
3.4 Manufacturer Data	9
<b>4 Test object Data</b>	<b>10</b>
4.1 General EUT Description	10
4.2 EUT Main components	10
4.3 Ancillary Equipment	11
4.4 Auxiliary Equipment	12
4.5 EUT Setups	12
4.6 Operating Modes / Test Channels	13
4.7 Product labelling	13
<b>5 Test Results</b>	<b>14</b>
5.1 Peak Power Output	14
5.2 Transmitter Spurious Radiated Emissions	21
5.3 Band Edge Compliance Radiated	29
<b>6 Test Equipment</b>	<b>51</b>
6.1 Test Equipment Hardware	51
6.2 Test Equipment Software	54
<b>7 Antenna Factors, Cable Loss and Sample Calculations</b>	<b>55</b>
7.1 LISN R&S ESH3-Z5 (150 kHz – 30 MHz)	55
7.2 Antenna R&S HFH2-Z2 (9 kHz – 30 MHz)	56
7.3 Antenna R&S HL562 (30 MHz – 1 GHz)	57
7.4 Antenna R&S HF907 (1 GHz – 18 GHz)	58
7.5 Antenna EMCO 3160-09 (18 GHz – 26.5 GHz)	59
7.6 Antenna EMCO 3160-10 (26.5 GHz – 40 GHz)	60
<b>8 Measurement Uncertainties</b>	<b>61</b>
<b>9 Photo Report</b>	<b>62</b>

## 1 APPLIED STANDARDS AND TEST SUMMARY

### 1.1 APPLIED STANDARDS

#### **Type of Authorization**

Certification for an Intentional Radiator.

#### **Applicable FCC Rules**

Prepared in accordance with the requirements of FCC Rules and Regulations as listed in 47 CFR Ch.1 Parts 2 and 15 (10-1-22 Edition). The following subparts are applicable to the results in this test report.

Part 2, Subpart J - Equipment Authorization Procedures, Certification

Part 15, Subpart C – Intentional Radiators

§ 15.201 Equipment authorization requirement

§ 15.207 Conducted limits

§ 15.209 Radiated emission limits; general requirements

§ 15.247 Operation within the bands 902-928 MHz, 2400-2483.5 MHz

#### Note:

The tests were selected and performed with reference to the FCC Public Notice "Guidance for Compliance Measurements on Digital Transmission System, Frequency Hopping Spread Spectrum System, and Hybrid System Devices Operating under Section 15.247 of the FCC Rules, 558074 D01 15.247 Meas Guidance v05r02, 2019-04-02". ANSI C63.10-2013 is applied.

## 1.2 FCC-IC CORRELATION TABLE

### Correlation of measurement requirements for DTS (e.g. WLAN 2.4 GHz, BT LE) equipment from FCC and IC

#### DTS equipment

Measurement	FCC reference	IC reference
Conducted emissions on AC Mains	§ 15.207	RSS-Gen Issue 5 & AMD 1 & AMD 2: 8.8
Occupied bandwidth	§ 15.247 (a) (2)	RSS-247 Issue 3: 5.2 (a)
Peak conducted output power	§ 15.247 (b) (3), (4)	RSS-247 Issue 3: 5.4 (d)
Transmitter spurious RF conducted emissions	§ 15.247 (d)	RSS-Gen Issue 5 & AMD 1 & AMD 2: 6.13 / 8.9/8.10; RSS-247 Issue 3: 5.5
Transmitter spurious radiated emissions	§ 15.247 (d); § 15.209 (a)	RSS-Gen Issue 5 & AMD 1 & AMD 2: 6.13 / 8.9/8.10; RSS-247 Issue 3: 5.5
Band edge compliance	§ 15.247 (d)	RSS-247 Issue 3: 5.5
Power density	§ 15.247 (e)	RSS-247 Issue 3: 5.2 (b)
Antenna requirement	§ 15.203 / 15.204	RSS-Gen Issue 5 & AMD 1 & AMD 2: 8.3
Receiver spurious emissions	–	–

### 1.3 MEASUREMENT SUMMARY

**47 CFR CHAPTER I FCC PART 15 § 15.247 (b) (3)**  
**Subpart C §15.247**

Peak Power Output  
 The measurement was performed according to ANSI C63.10, chapter 11.9.1.3 **Final Result**

<b>OP-Mode</b> Radio Technology, Operating Frequency, Measurement method	<b>Setup</b>	<b>Date</b>	<b>FCC</b>	<b>IC</b>
Bluetooth LE 1 Mbps, high, conducted	S01_AA01	2024-02-05	Passed	Passed
Bluetooth LE 1 Mbps, low, conducted	S01_AA01	2024-02-05	Passed	Passed
Bluetooth LE 1 Mbps, mid, conducted	S01_AA01	2024-02-05	Passed	Passed
Bluetooth LE 2 Mbps, high, conducted	S01_AA01	2024-02-05	Passed	Passed
Bluetooth LE 2 Mbps, low, conducted	S01_AA01	2024-02-05	Passed	Passed
Bluetooth LE 2 Mbps, mid, conducted	S01_AA01	2024-02-05	Passed	Passed
WLAN b, high, conducted	S01_AA01	2024-02-05	Passed	Passed
WLAN b, low, conducted	S01_AA01	2024-02-05	Passed	Passed
WLAN b, mid, conducted	S01_AA01	2024-02-05	Passed	Passed
WLAN g, high, conducted	S01_AA01	2024-02-05	Passed	Passed
WLAN g, low, conducted	S01_AA01	2024-02-05	Passed	Passed
WLAN g, mid, conducted	S01_AA01	2024-02-05	Passed	Passed
WLAN n 20 MHz, high, conducted	S01_AA01	2024-02-05	Passed	Passed
WLAN n 20 MHz, low, conducted	S01_AA01	2024-02-05	Passed	Passed
WLAN n 20 MHz, mid, conducted	S01_AA01	2024-02-05	Passed	Passed
WLAN n 40 MHz, high, conducted	S01_AA01	2024-02-05	Passed	Passed
WLAN n 40 MHz, low, conducted	S01_AA01	2024-02-05	Passed	Passed
WLAN n 40 MHz, mid, conducted	S01_AA01	2024-02-05	Passed	Passed

**47 CFR CHAPTER I FCC PART 15 § 15.247 (d)**  
**Subpart C §15.247**

Transmitter Spurious Radiated Emissions  
 The measurement was performed according to ANSI C63.10, chapter 6.4, 6.5, 6.6.5 **Final Result**

<b>OP-Mode</b> Radio Technology, Operating Frequency, Measurement range	<b>Setup</b>	<b>Date</b>	<b>FCC</b>	<b>IC</b>
WLAN b, mid, 1 GHz - 26 GHz	S02_AA01	2024-02-08	Passed	Passed
WLAN b, mid, 30 MHz - 1 GHz	S02_AB01	2024-02-08	Passed	Passed
WLAN b, mid, 9 kHz - 30 MHz	S02_AB01	2024-02-08	Passed	Passed

**47 CFR CHAPTER I FCC PART 15 § 15.247 (d)**  
**Subpart C §15.247**

Band Edge Compliance Radiated

The measurement was performed according to ANSI C63.10, chapter 6.6.5

**Final Result**

<b>OP-Mode</b>	<b>Setup</b>	<b>Date</b>	<b>FCC</b>	<b>IC</b>
Radio Technology, Operating Frequency, Band Edge				
Bluetooth LE 2 Mbps, high, high	S02_AA01	2024-02-07	Passed	Passed
WLAN b, high, high	S02_AA01	2024-02-07	Passed	Passed
WLAN g, high, high	S02_AA01	2024-02-07	Passed	Passed
WLAN n 20 MHz, high, high	S02_AA01	2024-02-07	Passed	Passed
WLAN n 40 MHz, high, high	S02_AA01	2024-02-07	Passed	Passed

N/A: Not applicable  
 N/P: Not performed

## 2 REVISION HISTORY / SIGNATURES

Report version control			
Version	Release date	Change Description	Version validity
initial	2024-03-12	--	valid
rev01	2024-06-05	Added abbreviation HMN, FVIN, HVIN. Added 50 Ohm to antenna description, added labtool version	valid

COMMENT: This is a spot check report for a C2PC. Not all tests were performed. See MDE\_UBLOX\_2008\_FCC\_02 for results of original certification.



(responsible for accreditation scope)  
Dipl.-Ing. Marco Kullik



(responsible for testing and report)  
Dipl.-Ing. Daniel Gall



7 layers GmbH, Borsigstr. 11  
40880 Ratingen, Germany  
Phone +49 (0)2102 749 0

### 3 ADMINISTRATIVE DATA

#### 3.1 TESTING LABORATORY

Company Name: 7layers GmbH  
Address: Borsigstr. 11  
40880 Ratingen  
Germany

The test facility is accredited by the following accreditation organisation:

Laboratory accreditation no: DAKKS D-PL-12140-01-01 | -02 | -03  
FCC Designation Number: DE0015  
FCC Test Firm Registration: 929146  
ISED CAB Identifier DE0007; ISED#: 3699A

Responsible for accreditation scope: Dipl.-Ing. Marco Kullik

Report Template Version: 2023-09-29

#### 3.2 PROJECT DATA

Responsible for testing and report: Dipl.-Ing. Daniel Gall  
Employees who performed the tests: documented internally at 7Layers  
Date of Report: 2024-06-05  
Testing Period: 2024-02-05 to 2024-02-08

#### 3.3 APPLICANT DATA

Company Name: u-blox AG  
Address: Zürcherstrasse 68  
8800 Thalwil  
Switzerland  
Contact Person: Filip Kruzela



### 3.4 MANUFACTURER DATA

Company Name: please see Applicant Data

Address:

Contact Person:

## 4 TEST OBJECT DATA

### 4.1 GENERAL EUT DESCRIPTION

Kind of Device product description	Host-based module with Wi-Fi and Bluetooth 5.0											
Product name (HMN)	JODY-W263-01B											
Type (HVIN)	JODY-W263-01B											
<b>Declared EUT data by the supplier</b>												
Voltage Type	DC											
Voltage Level	1.8 and 3.3 V at Module (voltage is generated on the auxiliary carrier board, which is supplied by SDIO from the computer board for conducted tests or external power supply at 5 or 12 V for radiated tests. For AC conducted emissions the module was supplied directly by a laboratory power supply)											
Antenna / Gain	External single band antenna 50 Ohm with 2.2 dBi max. gain in the relevant 2.4 GHz ISM band for Bluetooth and external dual band antenna with 2.5 dBi max. gain in the relevant 2.4 GHz ISM band for WLAN											
Tested Modulation Type	BT LE: GFSK WLAN: WLANb: DSSS, WLANg,n: OFDM											
Specific product description for the EUT	<p>The EUT is a Bluetooth and WLAN module.</p> <p>In the 2.4 GHz band it supports SISO Mode only.</p> <p>Supported technologies are Bluetooth Classic, Bluetooth Low Energy and WLAN b, g, n, ac</p> <p>Relevant for this report is Bluetooth Low Energy and WLAN. The Bluetooth Low Energy transmitter supports 1 and 2 Mbits, the WLAN transmitter supports WLAN b, g and n in 20 MHz BW as well as n in 40 MHz BW. 20 MHz channels 12 and 13 as well as 40 MHz channels 10 and 11 are not supported.</p>											
EUT ports (connected cables during testing):	Enclosure Data DC Power Antenna											
Tested datarates	BT LE: 1 Mbps, 2 Mbps WLAN b: 1 Mbps, WLAN g: 6 Mbps, WLAN n: MCS0											
Special software used for testing	The test modes were set by the software "labtool" version 1.0.0.146 provided by the applicant on an auxiliary computer board.											
Power to be set in test software:	Channel	1	2	3	4	5	6	7	8	9	10	11
	Frequency	2412	2417	2422	2427	2432	2437	2442	2447	2452	2457	2462
	WLAN b	12	12	12	12	12	12	12	12	12	12	12
	WLAN g	11	16	16	16	16	16	16	16	16	16	11
	WLAN n 20	11	16	16	16	16	16	16	16	16	16	11
	WLAN n 40	-	-	9	10	11	12	12	12	11	-	-

#### 4.2 EUT MAIN COMPONENTS

Sample Name	Sample Code	Description
EUT aa01	DE1015184aa01	
Sample Parameter	Value	
Serial No.	BB55464DEDD28E40400	
HW Version	04	
SW Version (FVIN)	16.80.205.p164	
Comment	Mounted on JODY-MODULE Board REV. B S/N: 10000003261021001006	

Sample Name	Sample Code	Description
EUT ab01	DE1015184ab01	
Sample Parameter	Value	
Serial No.	BB55464DEDD29180400	
HW Version	04	
SW Version (FVIN)	16.80.205.p164	
Comment	Mounted on JODY-MODULE Board REV. B S/N: 10000003261021001002	

NOTE: The short description is used to simplify the identification of the EUT in this test report.

#### 4.3 ANCILLARY EQUIPMENT

For the purposes of this test report, ancillary equipment is defined as equipment which is used in conjunction with the EUT to provide operational and control features to the EUT. It is necessary to configure the system in a typical fashion, as a customer would normally use it. But nevertheless Ancillary Equipment can influence the test results.

Device	Details (Manufacturer, Type Model, OUT Code)	Description
-	-	-

#### 4.4 AUXILIARY EQUIPMENT

For the purposes of this test report, auxiliary equipment is defined as equipment which is used temporarily to enable operational and control features especially used for the tests of the EUT which is not used during normal operation or equipment that is used during the tests in combination with the EUT but is not subject of this test report. It is necessary to configure the system in a typical fashion, as a customer would normally use it. But nevertheless Auxiliary Equipment can influence the test results.

<b>Device</b>	<b>Details (Manufacturer, Type Model, HW, SW, S/N)</b>	<b>Description</b>
AUX 01	UBLOX, JODY-Carrier Board, REV. D, -, , 10000003247494016001	Carrier board for module providing ports
AUX 02	UBLOX, JODY-Carrier Board, Rev. D, -, , 10000003370145009002	Carrier board for module providing ports
AUX 03	Linx, ANT-DB1-RAF-RPS, -, -, -	Dual band antenna used for WLAN
AUX 04	Linx, ANT-2.4-CW-RCT-RP, -, -, -	Single band antenna for Bluetooth in the 2.4 GHz ISM band
AUX 05	Toradex, Ixora, V1.1A, apalis- tk1_rocko_2023-07-27, 10592246	Board Computer

#### 4.5 EUT SETUPS

This chapter describes the combination of EUTs and equipment used for testing. The rationale for selecting the EUTs, ancillary and auxiliary equipment and interconnecting cables, is to test a representative configuration meeting the requirements of the referenced standards.

<b>Setup</b>	<b>Combination of EUTs</b>	<b>Description and Rationale</b>
S01_AA01	EUT aa01, AUX 05, AUX 01,	Conducted Setup
S02_AA01	EUT aa01, AUX 01, AUX 03, AUX 04	Radiated Setup
S02_AB01	EUT ab01, AUX 02, AUX 03, AUX 04	Radiated Setup

## 4.6 OPERATING MODES / TEST CHANNELS

This chapter describes the operating modes of the EUTs used for testing.

<b>2.4 GHz ISM 2400 - 2483.5 MHz</b>			
	<b>low</b>	<b>mid</b>	<b>high</b>
<b>WLAN 20 MHz Test Channels: Channel:</b>	1	6	11
<b>Frequency [MHz]</b>	2412	2437	2462

	<b>low</b>	<b>mid</b>	<b>high</b>
<b>40 MHz Test Channels: Channel:</b>	3	6	11
<b>Frequency [MHz]</b>	2422	2437	2462

<b>2.4 GHz ISM 2400 - 2483.5 MHz</b>			
	<b>low</b>	<b>mid</b>	<b>high</b>
<b>BT LE Test Channels: Channel:</b>	0	19	39
<b>Frequency [MHz]</b>	2402	2440	2480

## 4.7 PRODUCT LABELLING

### 4.7.1 FCC ID LABEL

Please refer to the documentation of the applicant.

### 4.7.2 LOCATION OF THE LABEL ON THE EUT

Please refer to the documentation of the applicant.

## 5 TEST RESULTS

### 5.1 PEAK POWER OUTPUT

Standard **FCC Part 15 Subpart C**

**The test was performed according to:**

ANSI C63.10, chapter 11.9.1.3

#### 5.1.1 TEST DESCRIPTION

DTS EQUIPMENT:

The Equipment Under Test (EUT) was set up to perform the output power measurements. The results recorded were measured with the modulation which produces the worst-case (highest) output power.

Maximum peak conducted output power (e.g. Bluetooth Low Energy):

The EUT was connected to the test system as described in the block diagram below. The complete attenuation of the measurement path is known and considered. The reference level of the spectrum analyser was set higher than the output power of the EUT.

Analyser settings:

- Resolution Bandwidth (RBW):  $\geq$  DTS bandwidth
- Video Bandwidth (VBW):  $\geq$  3 times RBW or maximum of analyzer
- Span:  $\geq$  3 times RBW
- Trace: Maxhold
- Sweeps: Till stable (min. 300, max. 15000)
- Sweeptime: Auto
- Detector: Peak

Maximum conducted average output power (e.g. WLAN):

The EUT was connected to the test system as described in the block diagram below. The complete attenuation of the measurement path is known and considered. Measurement is performed using the gated RF average power meter integrated in the OSP 120 module OSP-B157W8 with signal bandwidth  $>300$  MHz.

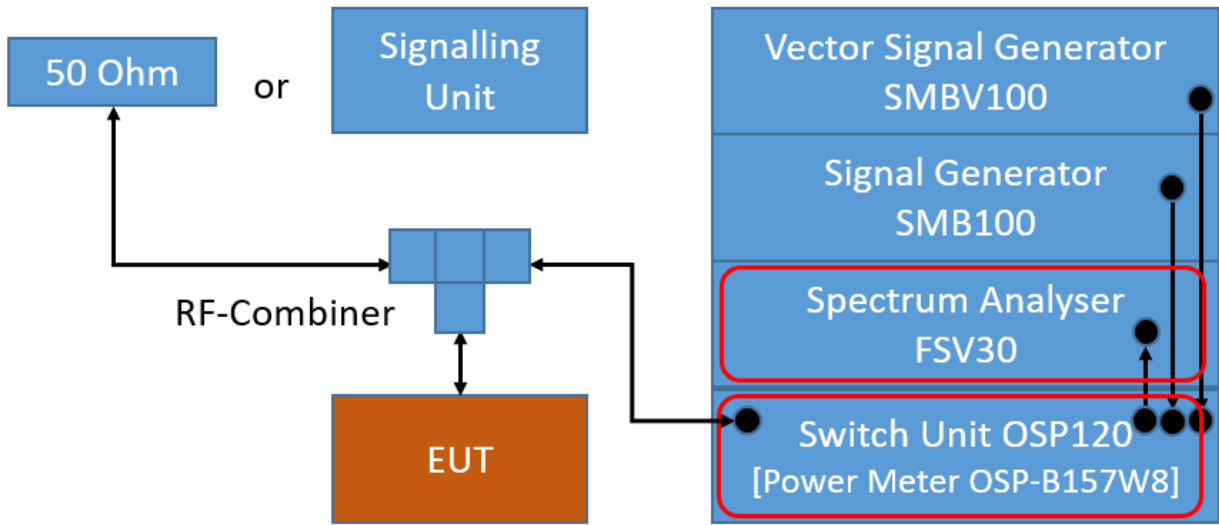

TS8997; Output Power

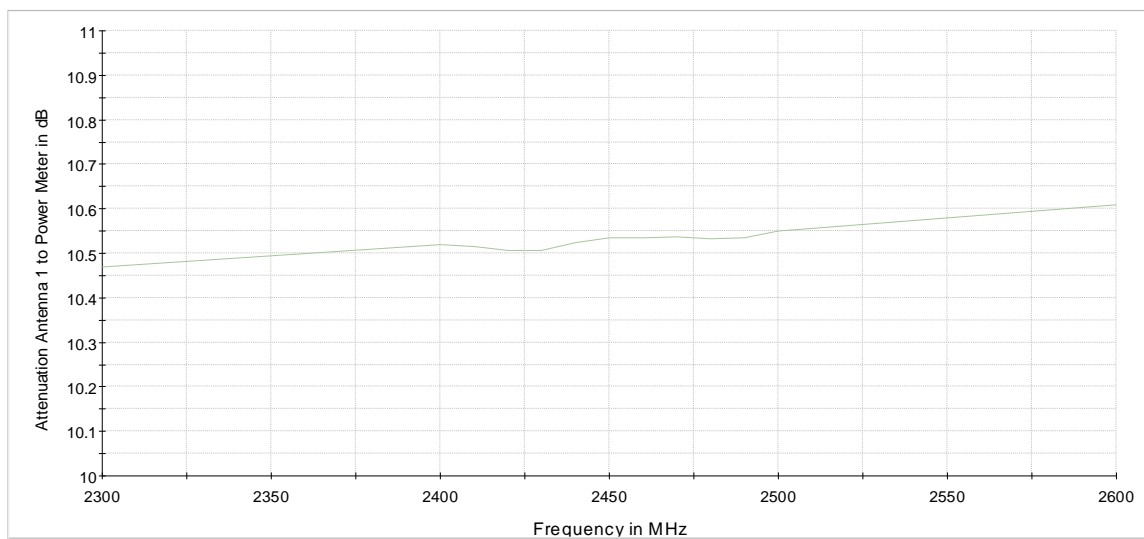

Attenuation of the measurement path to Power Meter

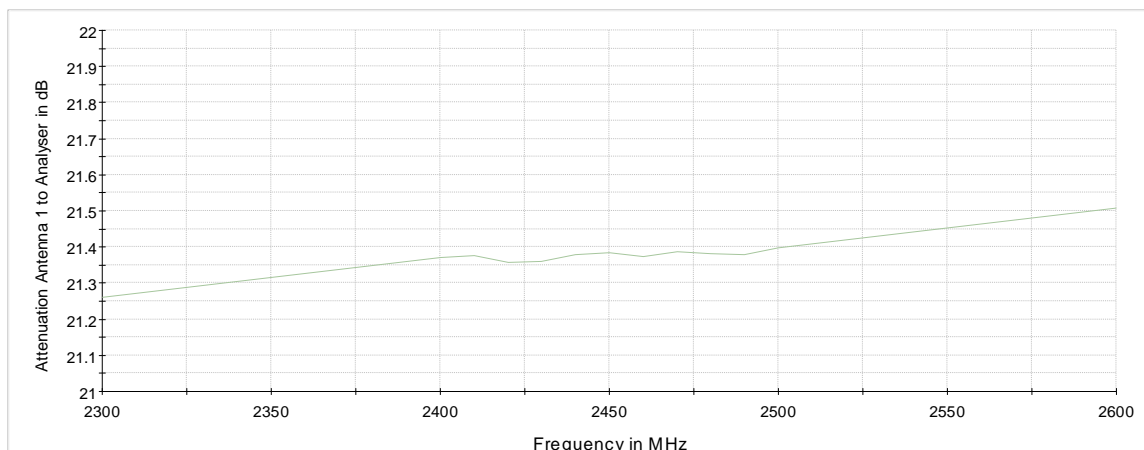

## Attenuation of the measurement path to Analyser

### 5.1.2 TEST REQUIREMENTS / LIMITS

#### **DTS devices:**

FCC Part 15, Subpart C, §15.247 (b) (3)

For systems using digital modulation techniques in the 902-928 MHz, 2400-2483.5 MHz and 5725-5850 MHz bands: 1 watt.

==> Maximum conducted peak output power: 30 dBm (excluding antenna gain, if antennas with directional gains that do not exceed 6 dBi are used).

#### **Frequency Hopping Systems:**

FCC Part 15, Subpart C, §15.247 (b) (1)

For frequency hopping systems operating in the 2400-2483.5 MHz band employing at least 75 non-overlapping hopping channels, and all frequency hopping systems in the 5725-5850 MHz band: 1 watt. For all other frequency hopping systems in the 2400-2483.5 MHz band: 0.125 watts.

FCC Part 15, Subpart C, §15.247 (b) (2)

For frequency hopping systems operating in the 902-928 MHz band: 1 watt for systems employing at least 50 hopping channels; and, 0.25 watts for systems employing less than 50 hopping channels, but at least 25 hopping channels, as permitted under paragraph (a)(1)(i) of this section.

Used conversion factor: Limit (dBm) = 10 log (Limit (W)/1mW)



### 5.1.3 TEST PROTOCOL

Ambient temperature: 25 °C  
 Air Pressure: 1027 hPa  
 Humidity: 40 %  
 BT LE 1 Mbit/s

Frequency [MHz]	Peak Power [dBm]	Limit [dBm]	Margin to Limit [dB]	E.I.R.P [dBm]	Peak Power Original Module Certification [dBm]	Margin [dB]
2402	2.1	30.0	27.9	4.3	3.7	-1.6
2440	3.0	30.0	27.0	5.2	3.7	-0.7
2480	2.1	30.0	27.9	4.3	3.8	-1.7

BT LE 2 Mbit/s

Frequency [MHz]	Peak Power [dBm]	Limit [dBm]	Margin to Limit [dB]	E.I.R.P [dBm]	Peak Power Original Module Certification [dBm]	Margin [dB]
2402	2.7	30.0	27.3	4.9	3.7	-1.0
2440	3.6	30.0	26.4	5.8	3.8	-0.2
2480	2.7	30.0	27.3	4.9	3.9	-1.2

WLAN b-Mode; 20 MHz; 1 Mbit/s

Frequency [MHz]	Maximum Average Power [dBm]	Limit [dBm]	Margin to Limit [dB]	E.I.R.P [dBm]	Maximum Average Power Original Module Certification [dBm]	Margin [dB]
2412	9.4	30.0	20.6	11.9	11.2	-1.8
2437	10.1	30.0	19.9	12.6	11.5	-1.4
2462	10.4	30.0	19.6	12.9	11.7	-1.3

WLAN g-Mode; 20 MHz; 6 Mbit/s

Frequency [MHz]	Maximum Average Power [dBm]	Limit [dBm]	Margin to Limit [dB]	E.I.R.P [dBm]	Maximum Average Power Original Module Certification [dBm]	Margin [dB]
2412	8.5	30.0	21.5	11.0	10.6	-2.1
2437	14.4	30.0	15.6	16.9	15.3	-0.9
2462	9.5	30.0	20.5	12.0	10.9	-1.4

WLAN n-Mode; 20 MHz; MCS0

Frequency [MHz]	Maximum Average Power [dBm]	Limit [dBm]	Margin to Limit [dB]	E.I.R.P [dBm]	Maximum Average Power Original Module Certification [dBm]	Margin [dB]
2412	8.6	30.0	21.4	11.1	10.6	-2.0
2437	14.5	30.0	15.5	17.0	15.6	-1.1
2462	9.6	30.0	20.4	12.1	11.1	-1.5

WLAN n-Mode; 40 MHz; MCS0

Frequency [MHz]	Maximum Average Power [dBm]	Limit [dBm]	Margin to Limit [dB]	E.I.R.P [dBm]	Maximum Average Power Original Module Certification [dBm]	Margin [dB]
2422	7.7	30.0	22.3	10.2	7.2	0.5
2437	11.3	30.0	18.7	13.8	10.7	0.6
2452	10.4	30.0	19.6	12.9	9.7	0.7

Remark: Please see next sub-clause for the measurement plot.

No plots are provided for WLAN since the measurement is performed with a power meter.

### 5.1.4 MEASUREMENT PLOTS

Radio Technology = Bluetooth LE 1 Mbps, Operating Frequency = low, Measurement method = conducted (S01\_AA01)

DUT Frequency (MHz)	Peak Power (dBm)	Limit Max (dBm)	Result
2402.000000	2.1	30.0	PASS

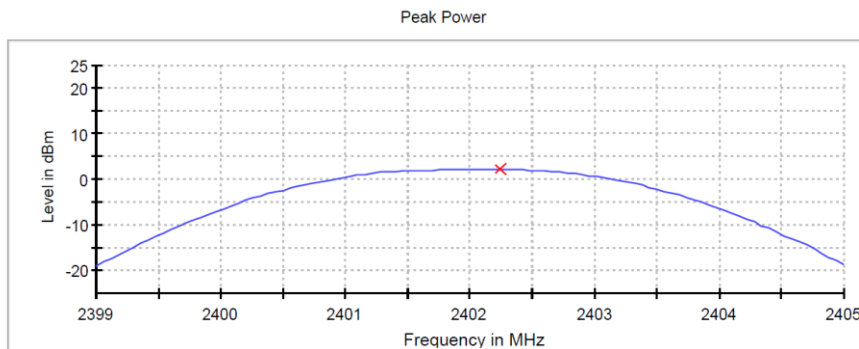

Setting	Instrument Value
Start Frequency	2.39900 GHz
Stop Frequency	2.40500 GHz
Span	6.000 MHz
RBW	2.000 MHz
VBW	10.000 MHz
SweepPoints	101
SweepTime	1.000 ms
Reference Level	10.000 dBm
Attenuation	20.000 dB
Detector	MaxPeak
SweepCount	100
Filter	3 dB
Trace Mode	Max Hold
SweepType	Sweep
Preamp	off
Stablemode	Trace
Stablevalue	0.50 dB
Run	4 / max. 150
Stable	3 / 3
Max Stable Difference	0.04 dB

Radio Technology = Bluetooth LE 1 Mbps, Operating Frequency = mid, Measurement method = conducted (S01\_AA01)

DUT Frequency (MHz)	Peak Power (dBm)	Limit Max (dBm)	Result
2440.000000	3.0	30.0	PASS

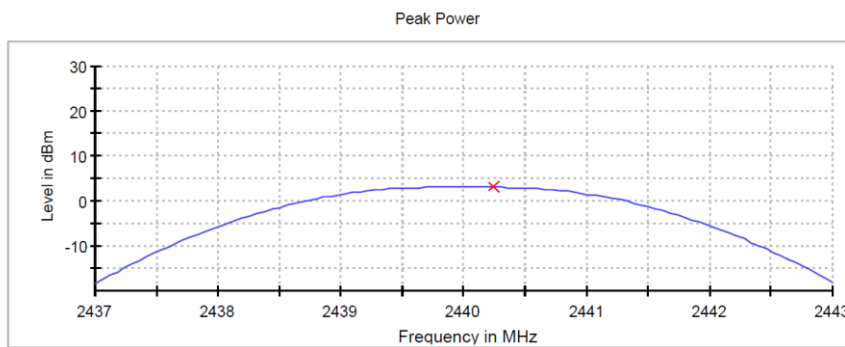

Setting	Instrument Value
Start Frequency	2.43700 GHz
Stop Frequency	2.44300 GHz
Span	6.000 MHz
RBW	2.000 MHz
VBW	10.000 MHz
SweepPoints	101
SweepTime	1.000 ms
Reference Level	10.000 dBm
Attenuation	20.000 dB
Detector	MaxPeak
SweepCount	100
Filter	3 dB
Trace Mode	Max Hold
SweepType	Sweep
Preamp	off
Stablemode	Trace
Stablevalue	0.50 dB
Run	4 / max. 150
Stable	3 / 3
Max Stable Difference	0.03 dB

Radio Technology = Bluetooth LE 1 Mbps, Operating Frequency = high, Measurement method = conducted (S01\_AA01)

DUT Frequency (MHz)	Peak Power (dBm)	Limit Max (dBm)	Result
2480.000000	2.1	30.0	PASS

Setting	Instrument Value
Start Frequency	2.47700 GHz
Stop Frequency	2.48300 GHz
Span	6.000 MHz
RBW	2.000 MHz
VBW	10.000 MHz
SweepPoints	101
Sweeptime	1.000 ms
Reference Level	10.000 dBm
Attenuation	20.000 dB
Detector	MaxPeak
SweepCount	100
Filter	3 dB
Trace Mode	Max Hold
SweepType	Sweep
Preamp	off
Stablemode	Trace
Stablevalue	0.50 dB
Run	4 / max. 150
Stable	3 / 3
Max Stable Difference	0.05 dB

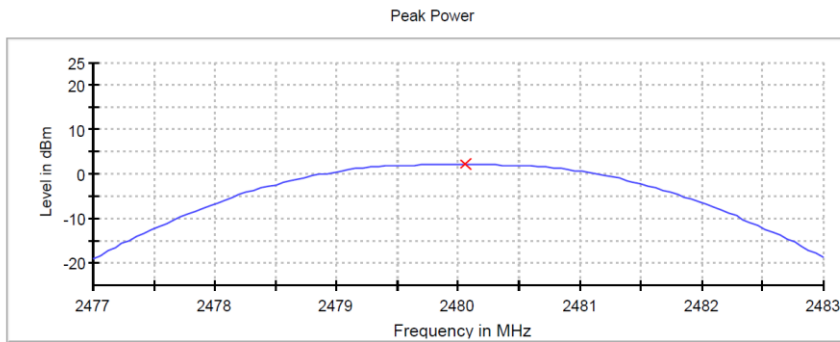

Radio Technology = Bluetooth LE 2 Mbps, Operating Frequency = low, Measurement method = conducted (S01\_AA01)

DUT Frequency (MHz)	Peak Power (dBm)	Limit Max (dBm)	Result
2402.000000	2.7	30.0	PASS

Setting	Instrument Value
Start Frequency	2.39750 GHz
Stop Frequency	2.40650 GHz
Span	9.000 MHz
RBW	3.000 MHz
VBW	10.000 MHz
SweepPoints	101
Sweeptime	1.000 ms
Reference Level	0.000 dBm
Attenuation	10.000 dB
Detector	MaxPeak
SweepCount	100
Filter	3 dB
Trace Mode	Max Hold
SweepType	Sweep
Preamp	off
Stablemode	Trace
Stablevalue	0.50 dB
Run	4 / max. 150
Stable	3 / 3
Max Stable Difference	0.02 dB

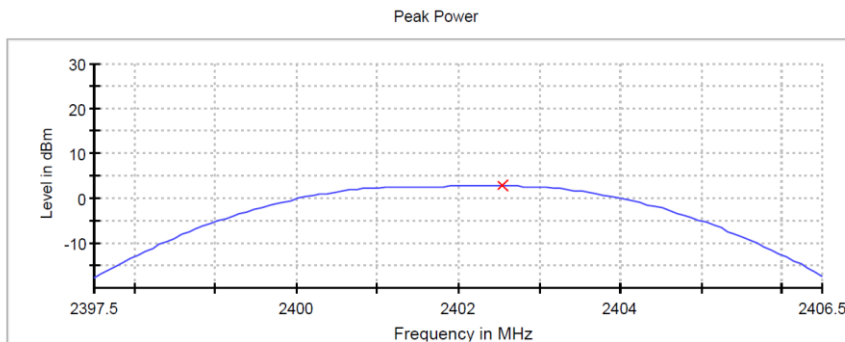

Radio Technology = Bluetooth LE 2 Mbps, Operating Frequency = mid, Measurement method = conducted (S01\_AA01)

DUT Frequency (MHz)	Peak Power (dBm)	Limit Max (dBm)	Result
2440.000000	3.6	30.0	PASS

Setting	Instrument Value
Start Frequency	2.43550 GHz
Stop Frequency	2.44450 GHz
Span	9.000 MHz
RBW	3.000 MHz
VBW	10.000 MHz
SweepPoints	101
Sweptime	1.000 ms
Reference Level	0.000 dBm
Attenuation	10.000 dB
Detector	MaxPeak
SweepCount	100
Filter	3 dB
Trace Mode	Max Hold
Sweeptype	Sweep
Preamp	off
Stablemode	Trace
Stablevalue	0.50 dB
Run	4 / max. 150
Stable	3 / 3
Max Stable Difference	0.03 dB

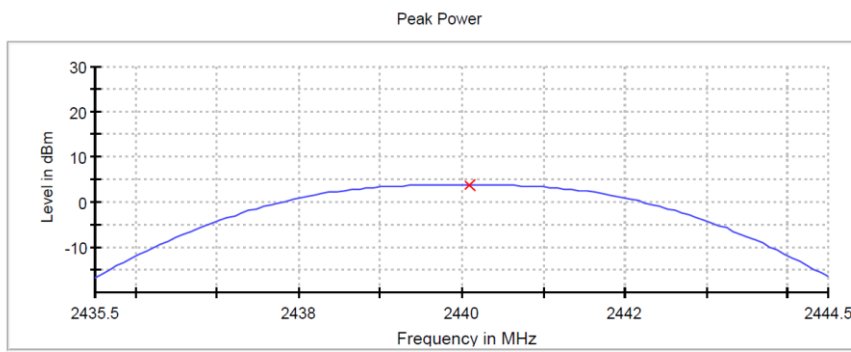

Radio Technology = Bluetooth LE 2 Mbps, Operating Frequency = high, Measurement method = conducted (S01\_AA01)

DUT Frequency (MHz)	Peak Power (dBm)	Limit Max (dBm)	Result
2480.000000	2.7	30.0	PASS

Setting	Instrument Value
Start Frequency	2.47550 GHz
Stop Frequency	2.48450 GHz
Span	9.000 MHz
RBW	3.000 MHz
VBW	10.000 MHz
SweepPoints	101
Sweptime	1.000 ms
Reference Level	0.000 dBm
Attenuation	10.000 dB
Detector	MaxPeak
SweepCount	100
Filter	3 dB
Trace Mode	Max Hold
Sweeptype	Sweep
Preamp	off
Stablemode	Trace
Stablevalue	0.50 dB
Run	4 / max. 150
Stable	3 / 3
Max Stable Difference	0.01 dB

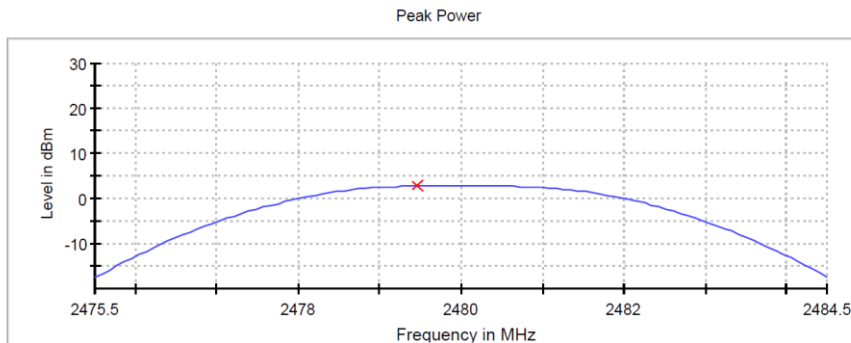

### 5.1.5 TEST EQUIPMENT USED

- R&S TS8997

## 5.2 TRANSMITTER SPURIOUS RADIATED EMISSIONS

Standard **FCC Part 15 Subpart C**

**The test was performed according to:**

ANSI C63.10, chapter 6.4, 6.5, 6.6.5

### 5.2.1 TEST DESCRIPTION

The test set-up was made in accordance to the general provisions of ANSI C63.10 in a typical installation configuration. The measurements were performed according the following sub-chapters of ANSI C63.10:

- < 30 MHz: Chapter 6.4
- 30 MHz – 1 GHz: Chapter 6.5
- > 1 GHz: Chapter 6.6 (procedure according 6.6.5 used)

The measurement procedure is implemented into the EMI test software EMC32 from R&S. Exploratory tests are performed at 3 orthogonal axes to determine the worst-case orientation of a body-worn or handheld EUT. The final test on all kind of EUTs is also performed at 3 axes. A pre-check is performed while the EUT is powered.

#### **Below 1 GHz:**

The Equipment Under Test (EUT) was set up on a non-conductive table in the semi-anechoic chamber. The influence of the EUT support table that is used between 30–1000 MHz was evaluated.

#### **1. Measurement up to 30 MHz**

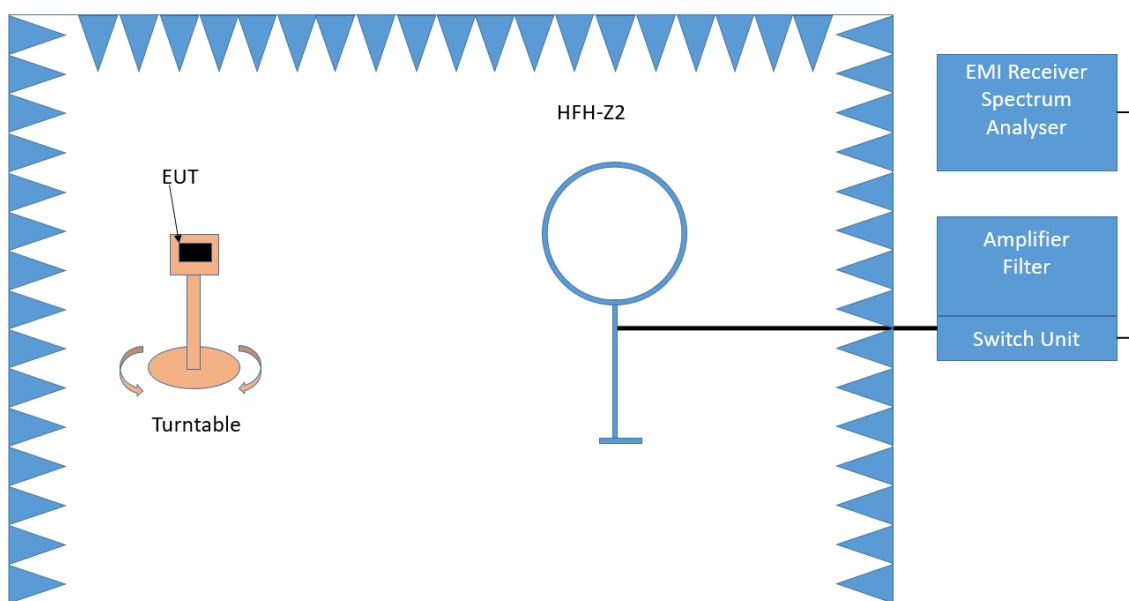

Test Setup; Spurious Emission Radiated (SAC), 9 kHz – 30 MHz

The Loop antenna HFH2-Z2 is used.

#### **Step 1:** pre measurement

- Anechoic chamber
- Antenna distance: 3 m
- Antenna height: 1 m
- Detector: Peak-Maxhold
- Frequency range: 0.009 - 0.15 MHz and 0.15 - 30 MHz
- Frequency steps: 0.05 kHz and 2.25 kHz
- IF-Bandwidth: 0.2 kHz and 9 kHz
- Measuring time / Frequency step: 100 ms (FFT-based)

Intention of this step is, to determine the radiated EMI-profile of the EUT. Afterwards the relevant emissions for the final measurement are identified.

### Step 2: final measurement

For the relevant emissions determined in step 1, an additional measurement with the following settings will be performed. Intention of this step is to find the maximum emission level.

- Detector: Quasi-Peak (9 kHz - 150 kHz, Peak / Average 150 kHz- 30 MHz)
- Frequency range: 0.009 - 30 MHz
- Frequency steps: measurement at frequencies detected in step 1
- IF-Bandwidth: 0.2 - 10 kHz
- Measuring time / Frequency step: 1 s

## 2. Measurement above 30 MHz and up to 1 GHz

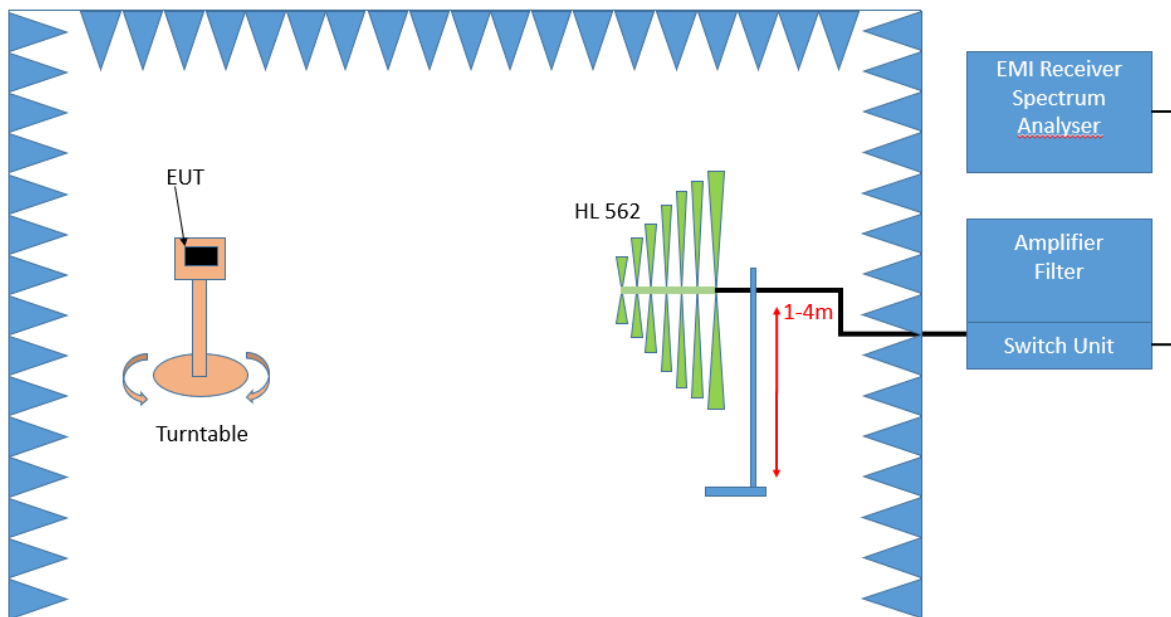

Test Setup; Spurious Emission Radiated (SAC), 30 MHz- 1GHz

### Step 1: Preliminary scan

This is a preliminary test to identify the highest amplitudes relative to the limit.

Settings for step 1:

- Antenna distance: 3 m
- Detector: Peak-Maxhold / Quasipeak (FFT-based)
- Frequency range: 30 - 1000 MHz
- Frequency steps: 30 kHz
- IF-Bandwidth: 120 kHz
- Measuring time / Frequency step: 100 ms
- Turntable angle range: -180° to 90°
- Turntable step size: 90°

- Height variation range: 1 – 4 m
- Height variation step size: 1.5 m
- Polarisation: Horizontal + Vertical

Intention of this step is, to determine the radiated EMI-profile of the EUT. Afterwards the relevant emissions for the final measurement are identified.

### **Step 2:** Adjustment measurement

In this step the accuracy of the turntable azimuth and antenna height will be improved. This is necessary to find out the maximum value of every frequency.

For each frequency, which was determined the turntable azimuth and antenna height will be adjusted. The turntable azimuth will slowly vary by 360°. During this action, the value of emission is continuously measured. The turntable azimuth at the highest emission will be recorded and adjusted. In this position, the antenna height will also slowly vary between 1 – 4 meter. During this action, the value of emission is also continuously measured. The antenna height of the highest emission will also be recorded and adjusted.

- Detector: Peak – Maxhold
- Measured frequencies: in step 1 determined frequencies
- IF – Bandwidth: 120 kHz
- Measuring time: 100 ms
- Turntable angle range: 360 °
- Height variation range: 1 – 4 m
- Antenna Polarisation: max. value determined in step 1

### **Step 3:** Final measurement with QP detector

With the settings determined in step 2, the final measurement will be performed:

EMI receiver settings for step 3:

- Detector: Quasi-Peak (< 1 GHz)
- Measured frequencies: in step 1 determined frequencies
- IF – Bandwidth: 120 kHz
- Measuring time: 1 s

After the measurement a plot will be generated which contains a diagram with the results of the preliminary scan and a chart with the frequencies and values of the results of the final measurement.

### Above 1 GHz:

The Equipment Under Test (EUT) was set up on a non-conductive support (tilt device) at 1.5 m height in the fully-anechoic chamber.

All steps were performed with one height (1.5 m) of the receiving antenna only.

### 3. Measurement above 1 GHz

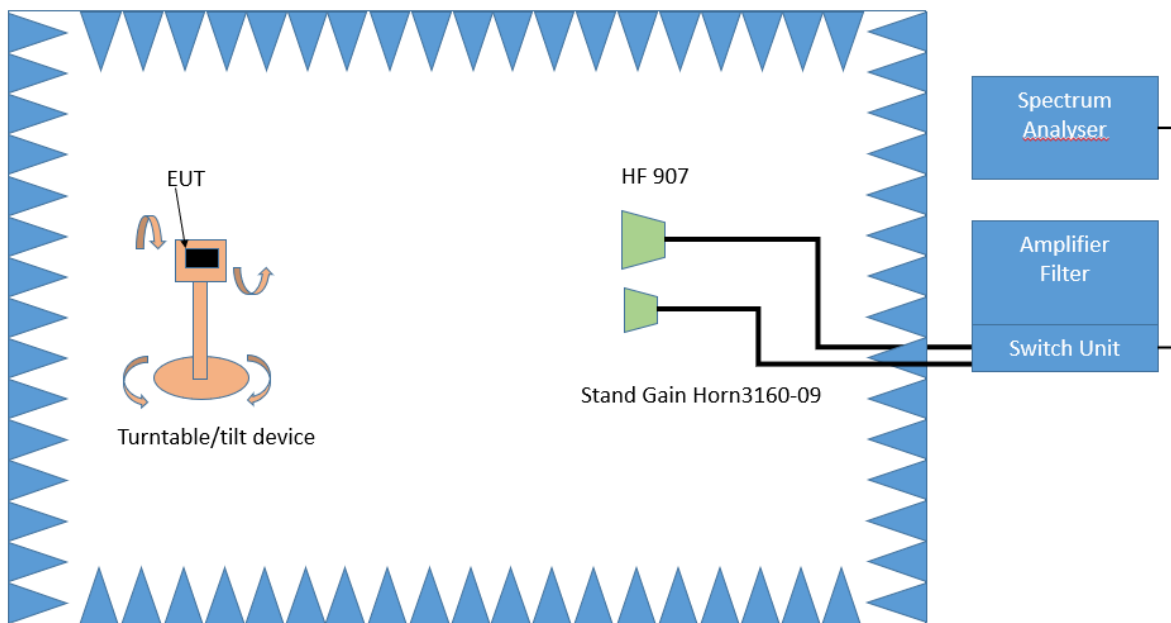

Test Setup; Spurious Emission Radiated (FAC), 1 GHz-26.5 GHz

#### Step 1:

The EUT is turned during the preliminary measurement across the elevation axis, with a step size of 90 °.

The turn table step size (azimuth angle) for the preliminary measurement is 45 °.

Spectrum analyser settings:

- Detector: Peak, Average
- RBW = 1 MHz
- VBW = 3 MHz

#### Step 2:

The turn table azimuth will slowly vary by  $\pm 22.5^\circ$ .

The elevation angle will slowly vary by  $\pm 45^\circ$

Spectrum analyser settings:

- Detector: Peak

#### Step 3:

Spectrum analyser settings for step 3:

- Detector: Peak / CISPR Average
- Measured frequencies: in step 1 determined frequencies
- RBW = 1 MHz
- VBW = 3 MHz
- Measuring time: 1 s



## 5.2.2 TEST REQUIREMENTS / LIMITS

FCC Part 15, Subpart C, §15.247 (d)

... In addition, radiated emissions which fall in the restricted bands, as defined in Section 15.205(a), must also comply with the radiated emission limits specified in Section 15.209(a) (see Section 15.205(c)).

FCC Part 15, Subpart C, §15.209, Radiated Emission Limits

Frequency in MHz	Limit ( $\mu\text{V}/\text{m}$ )	Measurement distance (m)	Limits ( $\text{dB}\mu\text{V}/\text{m}$ )
0.009 – 0.49	2400/F(kHz)@300m	3	(48.5 – 13.8)@300m
0.49 – 1.705	24000/F(kHz)@30m	3	(33.8 – 23.0)@30m
1.705 – 30	30@30m	3	29.5@30m

The measured values are corrected with an inverse linear distance extrapolation factor (40 dB/decade) according FCC 15.31 (2).

Frequency in MHz	Limit ( $\mu\text{V}/\text{m}$ )	Measurement distance (m)	Limits ( $\text{dB}\mu\text{V}/\text{m}$ )
30 – 88	100@3m	3	40.0@3m
88 – 216	150@3m	3	43.5@3m
216 – 960	200@3m	3	46.0@3m
960 - 26000	500@3m	3	54.0@3m
26000 - 40000	500@3m	1	54.0@3m

The measured values above 26 GHz are corrected with an inverse linear distance extrapolation factor (20 dB/decade).

§15.35(b) ..., there is also a limit on the radio frequency emissions, as measured using instrumentation with a peak detector function, corresponding to 20 dB above the maximum permitted average limit....

Used conversion factor:  $\text{Limit (dB}\mu\text{V}/\text{m)} = 20 \log (\text{Limit } (\mu\text{V}/\text{m})/1\mu\text{V}/\text{m})$

### 5.2.3 TEST PROTOCOL

Ambient temperature: 22 °C  
 Air Pressure: 992 hPa  
 Humidity: 41 %  
 WLAN b-Mode; 20 MHz; 1 Mbit/s  
 Applied duty cycle correction (AV): 0 dB

Ch. No.	Ch. Center Freq. [MHz]	Spurious Freq. [MHz]	Spurious Level [dBµV/m]	Detector	RBW [kHz]	Limit [dBµV/m]	Margin to Limit [dB]	Limit Type
6	2437	2484.7	54.2	PEAK	1000	74.0	19.8	RB
6	2437	2484.7	43.9	AV	1000	54.0	10.1	RB
6	2437	4874.1	56.6	PEAK	1000	74.0	17.4	RB
6	2437	4874.1	53.0	AV	1000	54.0	1.0	RB

Remark: Please see next sub-clause for the measurement plot.

### 5.2.4 MEASUREMENT PLOTS

Radio Technology = WLAN b, Operating Frequency = mid, Measurement range = 9 kHz - 30 MHz  
 (S01\_AB01)

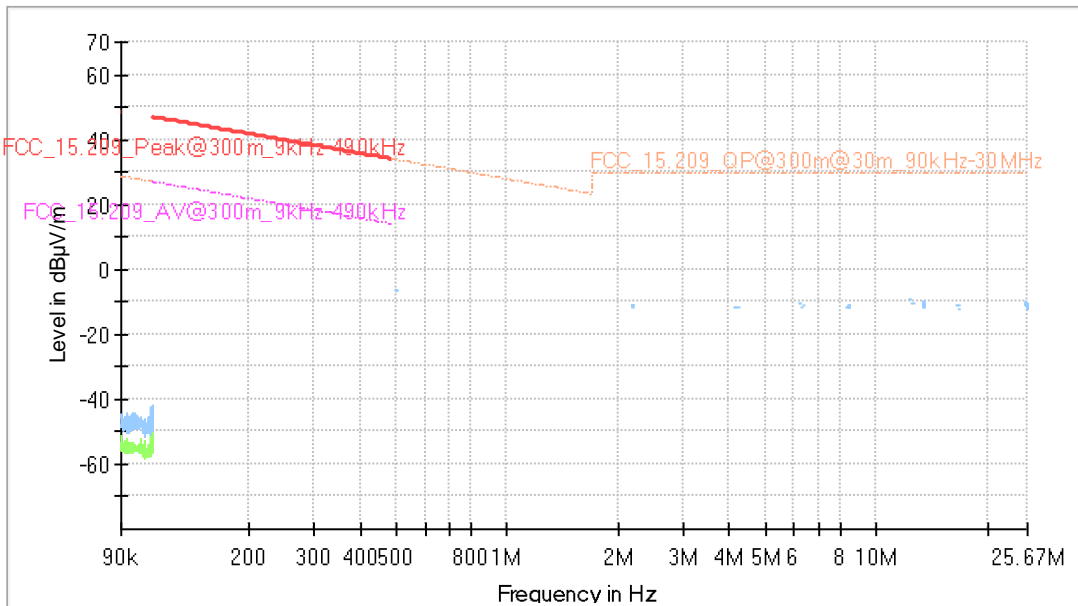

### Final Result

Frequency (MHz)	MaxPeak (dBµV/m)	QuasiPeak (dBµV/m)	Limit (dBµV/m)	Margin (dB)	Meas. Time (ms)	Bandwidth (kHz)	Height (cm)	Azimuth (deg)	Corr. (dB/m)
---	---	---	---	---	---	---	---	---	---

Radio Technology = WLAN b, Operating Frequency = mid, Measurement range = 30 MHz - 1 GHz  
(S01\_AB01)

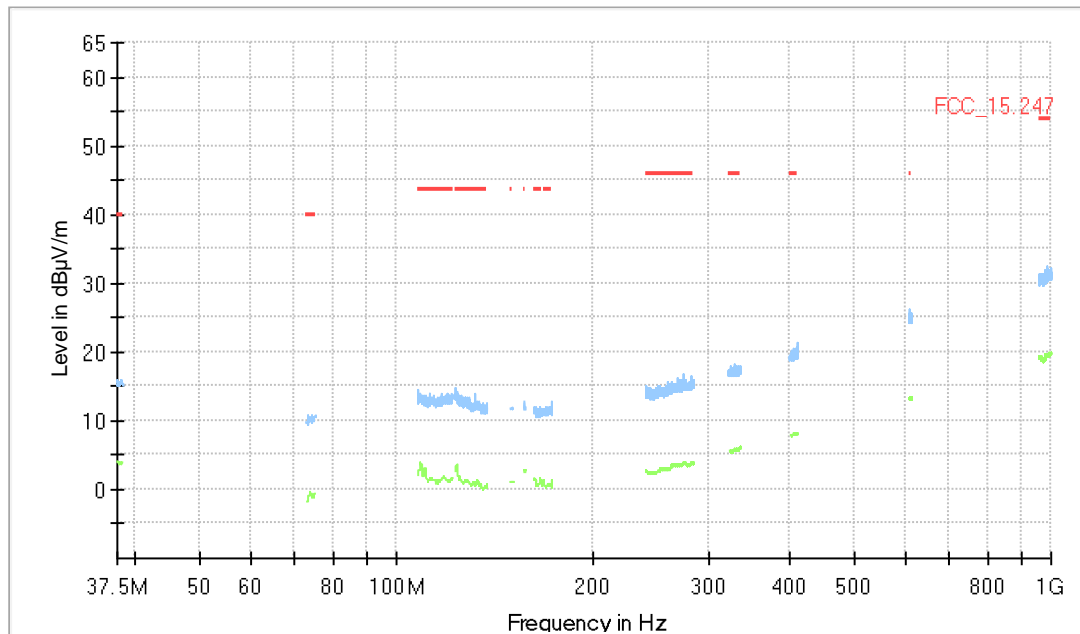

**Final Result**

Frequency (MHz)	QuasiPeak (dBµV/m)	Limit (dBµV/m)	Margin (dB)	Meas. Time (ms)	Bandwidth (kHz)	Height (cm)	Pol	Azimuth (deg)	Corr. (dB/m)
---	---	---	---	---	---	---		---	---

Radio Technology = WLAN b, Operating Frequency = mid, Measurement range = 1 GHz - 26 GHz  
(S01\_AA01)

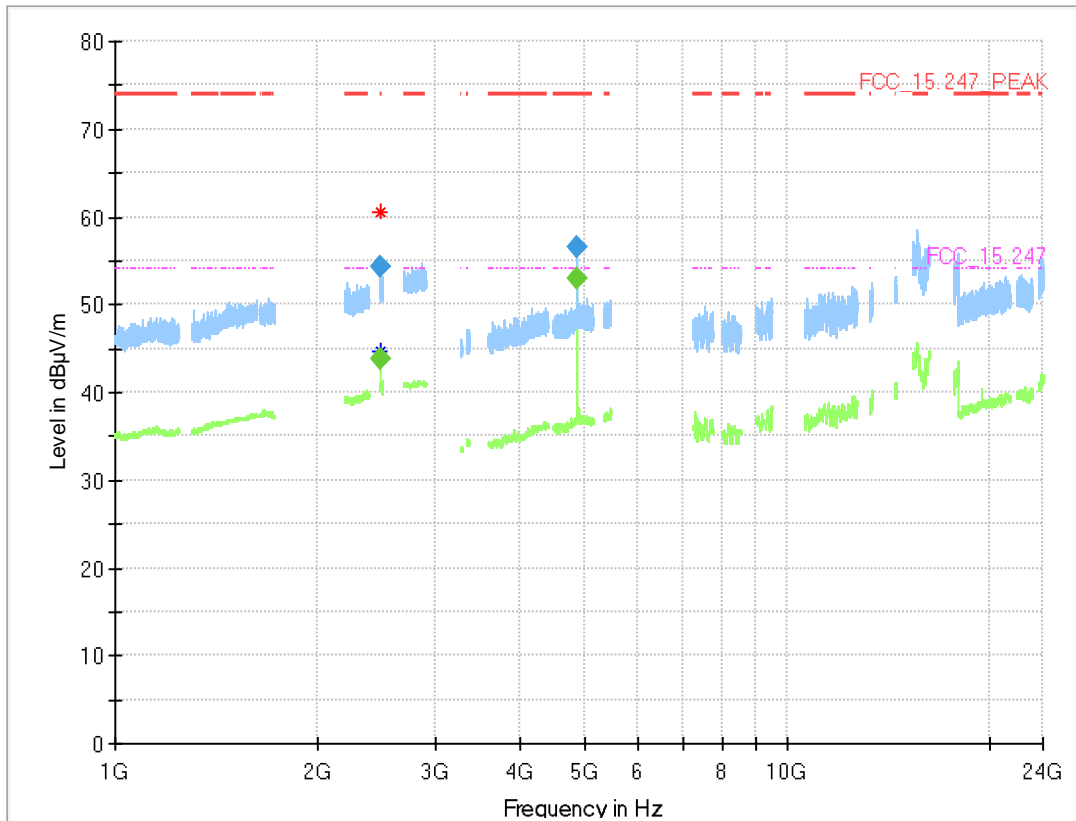

**Final\_Result**

Frequency (MHz)	MaxPeak (dBµV/m)	CAverage (dBµV/m)	Limit (dBµV/m)	Margin (dB)	Meas. Time (ms)	Bandwidth (kHz)	Height (cm)	Pol	Azimuth (deg)	Elevation (deg)	Corr. (dB/m)
2484.655	---	43.9	54.00	10.13	1000.0	1000.000	150.0	V	-185.0	8.0	7.8
2484.655	54.2	---	74.00	19.79	1000.0	1000.000	150.0	V	-185.0	8.0	7.8
4874.075	---	53.0	54.00	0.96	1000.0	1000.000	150.0	V	89.0	-12.0	6.4
4874.075	56.6	---	74.00	17.39	1000.0	1000.000	150.0	V	89.0	-12.0	6.4

**5.2.5 TEST EQUIPMENT USED**

- Radiated Emissions FAR 2.4 GHz FCC
- Radiated Emissions SAC H-Field
- Radiated Emissions SAC up to 1 GHz

### 5.3 BAND EDGE COMPLIANCE RADIATED

Standard **FCC Part 15 Subpart C**

**The test was performed according to:**

ANSI C63.10, chapter 6.6.5

#### 5.3.1 TEST DESCRIPTION

The test set-up was made in accordance to the general provisions of ANSI C63.10 in a typical installation configuration. The measurements were performed according the following sub-chapter of ANSI C63.10:

- Chapter 6.10.5

The Equipment Under Test (EUT) was set up on a non-conductive support (tilt device) at 1.5 m height in the fully-anechoic chamber.

All steps were performed with one height (1.5 m) of the receiving antenna only (procedure according ANSI C63.10, chapter 6.6.5).

#### 3. Measurement above 1 GHz

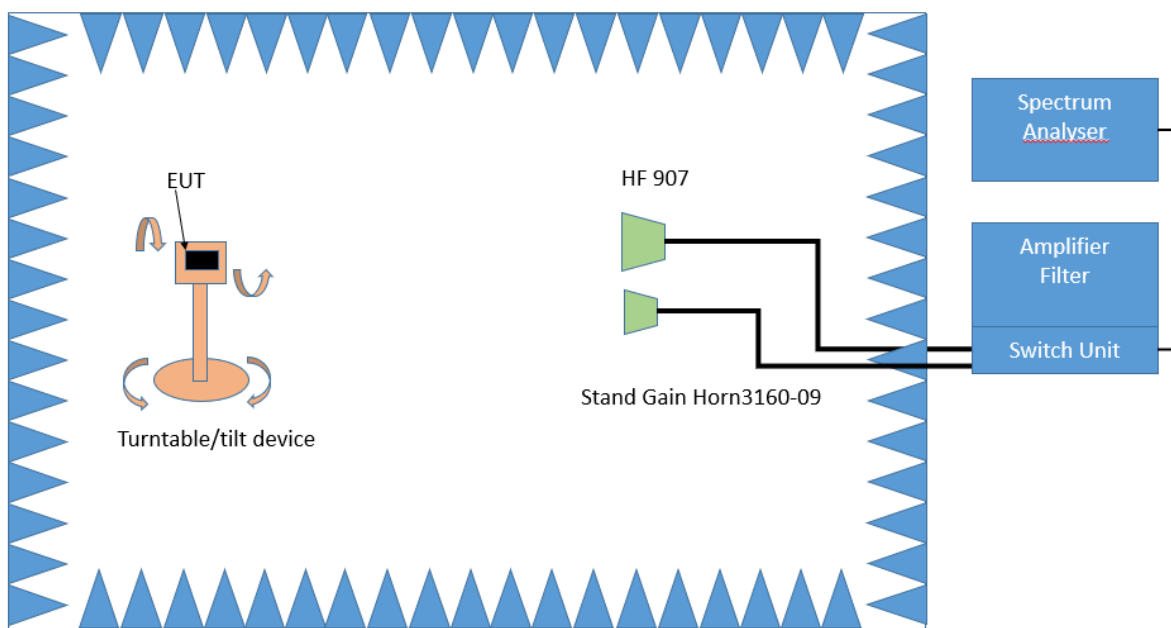

Test Setup; Spurious Emission Radiated (FAC), 1 GHz-26.5 GHz

#### Step 1:

The EUT is turned during the preliminary measurement across the elevation axis, with a step size of 90 °.

The turn table step size (azimuth angle) for the preliminary measurement is 45 °.

Spectrum analyser settings:

- Detector: Peak, Average
- RBW = 1 MHz
- VBW = 3 MHz

#### Step 2:

The turn table azimuth will slowly vary by  $\pm 22.5^\circ$ .

The elevation angle will slowly vary by  $\pm 45^\circ$

Spectrum analyser settings:

- Detector: Peak

### Step 3:

Spectrum analyser settings for step 3:

- Detector: Peak / CISPR Average
- Measured frequencies: in step 1 determined frequencies
- RBW = 1 MHz
- VBW = 3 MHz
- Measuring time: 1 s

## 5.3.2 TEST REQUIREMENTS / LIMITS

For band edges connected to a restricted band, the limits are specified in Section 15.209(a)

FCC Part 15, Subpart C, §15.209, Radiated Emission Limits

Frequency in MHz	Limit ( $\mu\text{V}/\text{m}$ )	Measurement distance (m)	Limits ( $\text{dB}\mu\text{V}/\text{m}$ )
0.009 – 0.49	2400/F(kHz)@300m	3	(48.5 – 13.8)@300m
0.49 – 1.705	24000/F(kHz)@30m	3	(33.8 – 23.0)@30m
1.705 – 30	30@30m	3	29.5@30m

The measured values are corrected with an inverse linear distance extrapolation factor (40 dB/decade) according FCC 15.31 (2).

Frequency in MHz	Limit ( $\mu\text{V}/\text{m}$ )	Measurement distance (m)	Limits ( $\text{dB}\mu\text{V}/\text{m}$ )
30 – 88	100@3m	3	40.0@3m
88 – 216	150@3m	3	43.5@3m
216 – 960	200@3m	3	46.0@3m
960 – 26000	500@3m	3	54.0@3m
26000 – 40000	500@3m	1	54.0@3m

The measured values above 26 GHz are corrected with an inverse linear distance extrapolation factor (20 dB/decade).

§15.35(b) ..., there is also a limit on the radio frequency emissions, as measured using instrumentation with a peak detector function, corresponding to 20 dB above the maximum permitted average limit....

Used conversion factor:  $\text{Limit (dB}\mu\text{V}/\text{m)} = 20 \log (\text{Limit } (\mu\text{V}/\text{m})/1\mu\text{V}/\text{m})$

### 5.3.3 TEST PROTOCOL

Ambient temperature: 24 °C  
 Air Pressure: 999 hPa  
 Humidity: 37 %  
 BT LE 2 Mbit/s  
 Applied duty cycle correction (AV): 9.5 dB

Ch. Center Freq. [MHz]	Band Edge Freq. [MHz]	Spurious Level [dBµV/m]	Detector	RBW [kHz]	Limit [dBµV/m]	Margin to Limit [dB]	Level Original Module Certification [dBµV/m]	Margin [dB]
2402	2390.0	50.3	PEAK	1000	74.0	23.7	-	-
2402	2390.0	46.6	AV	1000	54.0	7.4	-	-
2480	2483.5	54.0	PEAK	1000	74.0	20.0	55.2	-1.2
2480	2483.5	48.0	AV	1000	54.0	6.0	45.7	2.3

WLAN b-Mode; 20 MHz; 1 Mbit/s  
 Applied duty cycle correction (AV): 0 dB

Ch. Center Freq. [MHz]	Band Edge Freq. [MHz]	Spurious Level [dBµV/m]	Detector	RBW [kHz]	Limit [dBµV/m]	Margin to Limit [dB]	Level Original Module Certification [dBµV/m]	Margin [dB]
2412	2390.0	50.3	PEAK	1000	74.0	23.7	56.2	-5.9
2412	2390.0	37.1	AV	1000	54.0	16.9	49.4	-12.3
2462	2483.5	61.7	PEAK	1000	74.0	12.3	49.9	11.8
2462	2483.5	40.0	AV	1000	54.0	14.0	44.1	-4.1

WLAN g-Mode; 20 MHz; 6 Mbit/s  
 Applied duty cycle correction (AV): 0 dB

Ch. Center Freq. [MHz]	Band Edge Freq. [MHz]	Spurious Level [dBµV/m]	Detector	RBW [kHz]	Limit [dBµV/m]	Margin to Limit [dB]	Level Original Module Certification [dBµV/m]	Margin [dB]
2412	2390.0	60.6	PEAK	1000	74.0	13.4	72.2	-11.6
2412	2390.0	41.4	AV	1000	54.0	12.6	53.3	-11.9
2417	2390.0	58.8	PEAK	1000	74.0	15.2	69.8	-11.0
2417	2390.0	38.7	AV	1000	54.0	15.3	50.7	-12.0
2457	2483.5	67.6	PEAK	1000	74.0	6.4	72.1	-4.5
2457	2483.5	43.8	AV	1000	54.0	10.2	48.5	-4.7
2462	2483.5	66.4	PEAK	1000	74.0	7.6	69.6	-3.2
2462	2483.5	45.1	AV	1000	54.0	8.9	48.0	-2.9

WLAN n-Mode; 20 MHz; MCS0  
 Applied duty cycle correction (AV): 0 dB

Ch. Center Freq. [MHz]	Band Edge Freq. [MHz]	Spurious Level [dBµV/m]	Detector	RBW [kHz]	Limit [dBµV/m]	Margin to Limit [dB]	Level Original Module Certification [dBµV/m]	Margin [dB]
2412	2390.0	61.8	PEAK	1000	74.0	12.2	73.0	-11.2
2412	2390.0	43.1	AV	1000	54.0	10.9	52.7	-9.6
2417	2390.0	60.1	PEAK	1000	74.0	13.9	73.9	-13.8
2417	2390.0	39.5	AV	1000	54.0	14.5	53.7	-14.2
2457	2483.5	72.2	PEAK	1000	74.0	1.8	71.1	1.1
2457	2483.5	48.4	AV	1000	54.0	5.6	50.1	-1.7
2462	2483.5	65.9	PEAK	1000	74.0	8.1	69.1	-3.2
2462	2483.5	46.4	AV	1000	54.0	7.6	47.8	-1.4

WLAN n-Mode; 40 MHz; MCS0  
Applied duty cycle correction (AV): 0 dB

Ch. Center Freq. [MHz]	Band Edge Freq. [MHz]	Spurious Level [dB $\mu$ V/m]	Detector	RBW [kHz]	Limit [dB $\mu$ V/m]	Margin to Limit [dB]	Level Original Module Certification [dB $\mu$ V/m]	Margin [dB]
2422	2390.0	63.2	PEAK	1000	74.0	10.8	70.9	-7.7
2422	2390.0	44.4	AV	1000	54.0	9.6	53.9	-9.5
2427	2390.0	64.1	PEAK	1000	74.0	9.9	70.9	-6.8
2427	2390.0	45.9	AV	1000	54.0	8.1	53.4	-7.5
2432	2390.0	59.2	PEAK	1000	74.0	14.8	69.1	-9.9
2432	2390.0	40.6	AV	1000	54.0	13.4	53.2	-12.6
2437	2390.0	65.0	PEAK	1000	74.0	9.0	71.9	-6.9
2437	2390.0	44.6	AV	1000	54.0	9.4	52.1	-7.5
2447	2483.5	70.1	PEAK	1000	74.0	3.9	72.7	-2.6
2447	2483.5	52.1	AV	1000	54.0	1.9	52.6	-0.5
2452	2483.5	67.8	PEAK	1000	74.0	6.2	65.7	2.1
2452	2483.5	51.1	AV	1000	54.0	2.9	53.5	-2.4

Remark: Please see next sub-clause for the measurement plot.



### 5.3.4 MEASUREMENT PLOTS

Radio Technology = Bluetooth LE 2 Mbps, Operating Frequency = high, Band Edge = high (S01\_AA01)

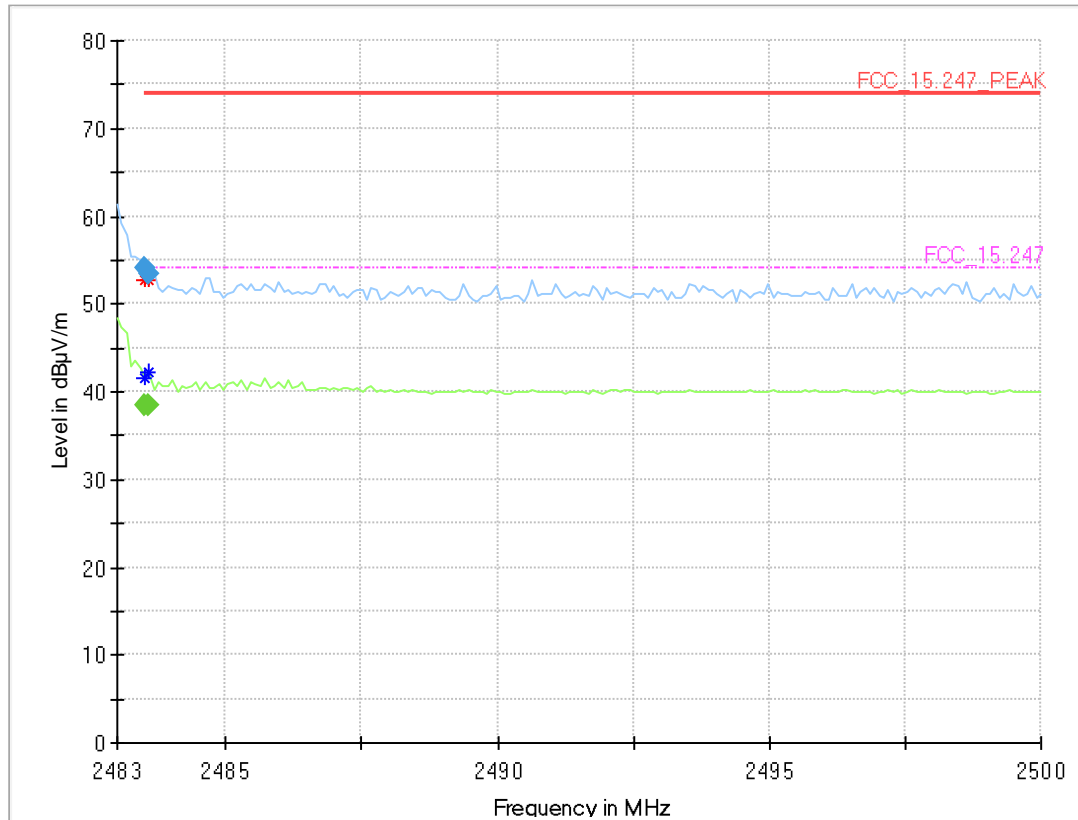

#### Final Result

Frequency (MHz)	MaxPeak (dBµV/m)	CAverage (dBµV/m)	Limit (dBµV/m)	Margin (dB)	Meas. Time (ms)	Bandwidth (kHz)	Height (cm)	Pol	Azimuth (deg)	Elevation (deg)	Corr. (dB/m)
2483.510	---	38.5	54.00	15.51	1000.0	1000.000	150.0	V	27.0	-10.0	7.8
2483.510	54.0	---	74.00	19.98	1000.0	1000.000	150.0	V	27.0	-10.0	7.8
2483.595	---	38.4	54.00	15.59	1000.0	1000.000	150.0	V	-8.0	-12.0	7.8
2483.595	53.4	---	74.00	20.56	1000.0	1000.000	150.0	V	-8.0	-12.0	7.8

Radio Technology = Bluetooth LE 2 Mbps, Operating Frequency = low, Band Edge = low (S01\_AA01)

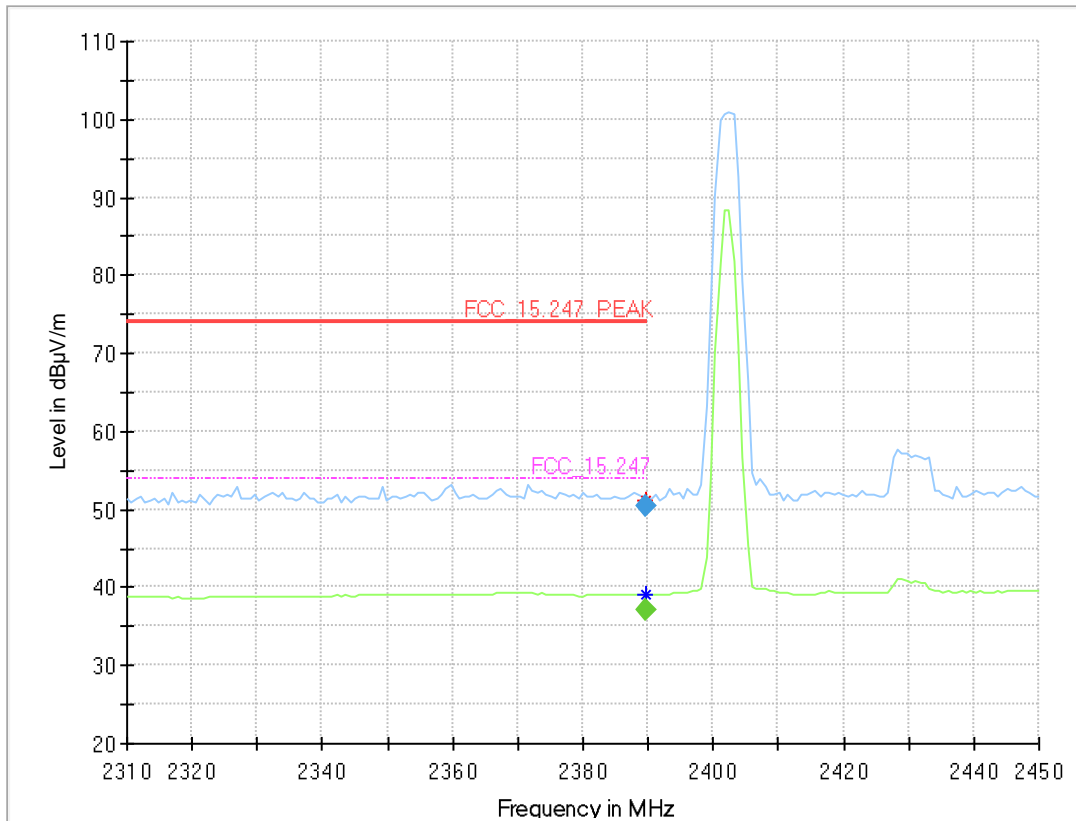

**Final Result**

Frequency (MHz)	MaxPeak (dBµV/m)	CAverage (dBµV/m)	Limit (dBµV/m)	Margin (dB)	Meas. Time (ms)	Bandwidth (kHz)	Height (cm)	Pol	Azimuth (deg)	Elevation (deg)	Corr. (dB/m)
2389.800	---	37.1	54.00	16.93	1000.0	1000.000	150.0	H	-120.0	15.0	7.6
2389.800	50.3	---	74.00	23.65	1000.0	1000.000	150.0	H	-120.0	15.0	7.6

Radio Technology = WLAN b, Operating Frequency = high, Band Edge = high (S01\_AA01)

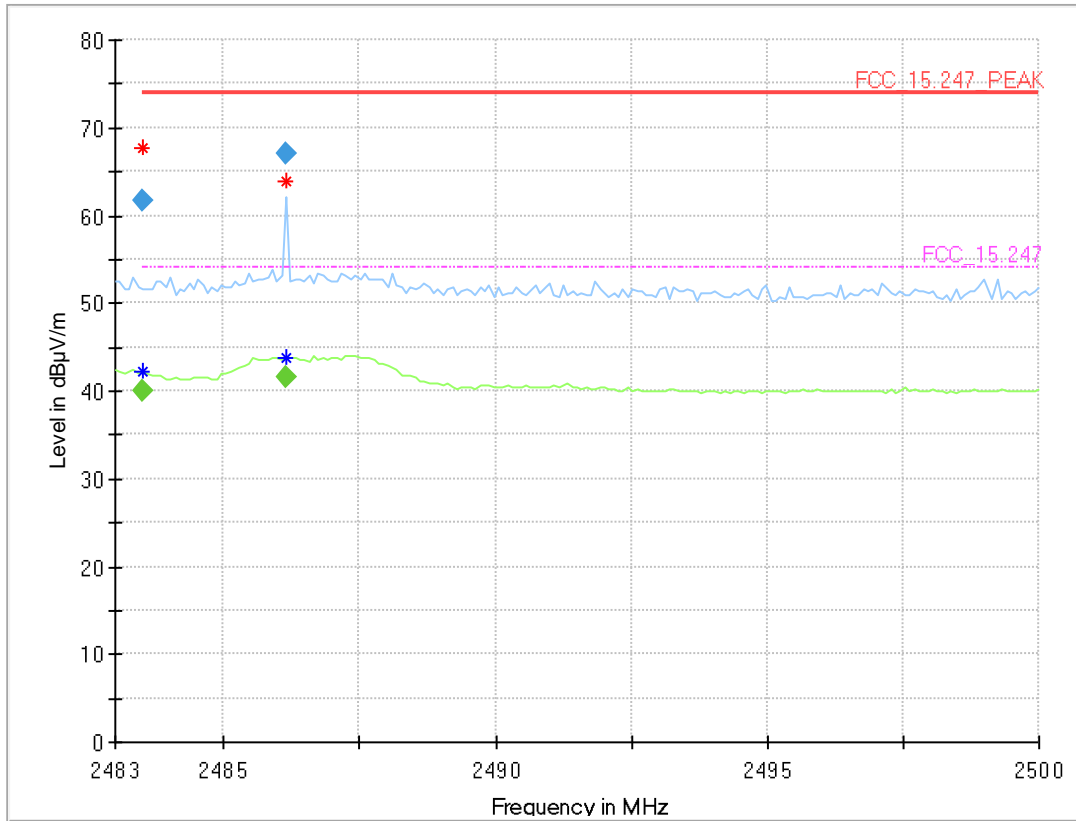

### Final Result

Frequency (MHz)	MaxPeak (dBµV/m)	CAverage (dBµV/m)	Limit (dBµV/m)	Margin (dB)	Meas. Time (ms)	Bandwidth (kHz)	Height (cm)	Pol	Azimuth (deg)	Elevation (deg)	Corr. (dB/m)
2483.510	---	40.0	54.00	14.01	1000.0	1000.000	150.0	V	-55.0	1.0	7.8
2483.510	61.7	---	74.00	12.31	1000.0	1000.000	150.0	V	-55.0	1.0	7.8
2486.145	---	41.6	54.00	12.36	1000.0	1000.000	150.0	V	131.0	11.0	7.9
2486.145	66.9	---	74.00	7.06	1000.0	1000.000	150.0	V	131.0	11.0	7.9

Radio Technology = WLAN b, Operating Frequency = low, Band Edge = low (S01\_AA01)

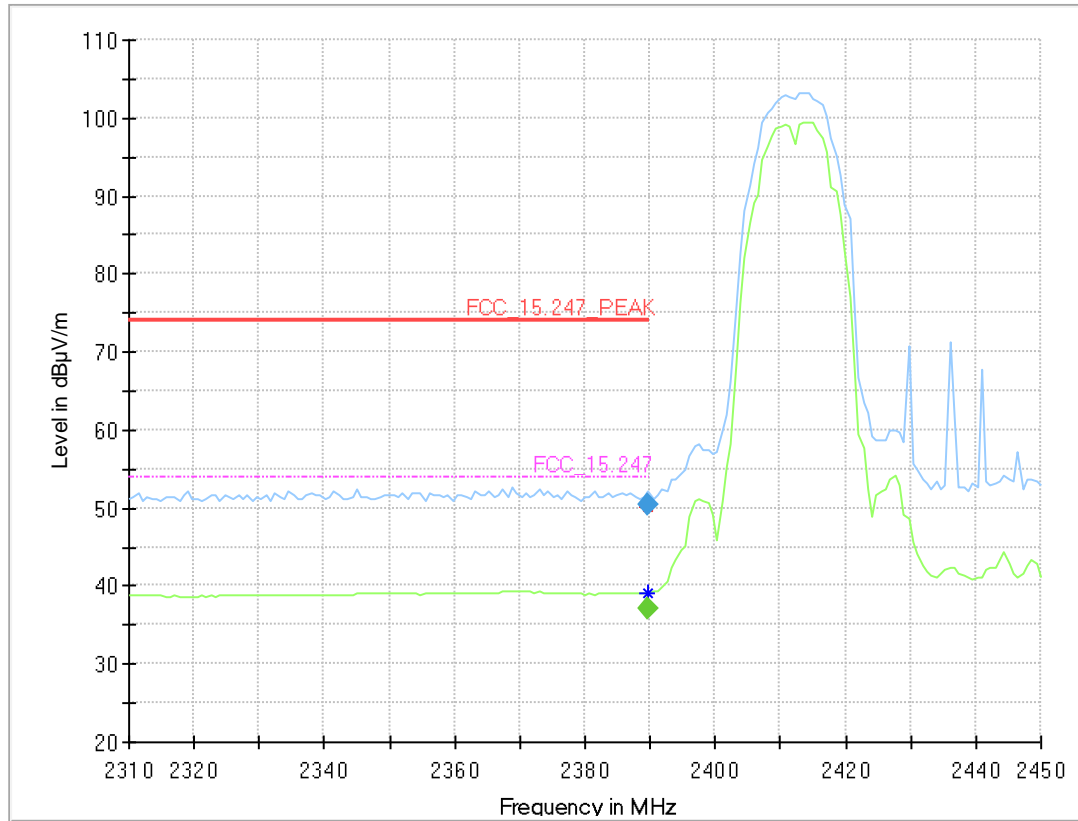

### Final Result

Frequency (MHz)	MaxPeak (dBµV/m)	CAverage (dBµV/m)	Limit (dBµV/m)	Margin (dB)	Meas. Time (ms)	Bandwidth (kHz)	Height (cm)	Pol	Azimuth (deg)	Elevation (deg)	Corr. (dB/m)
2389.800	---	37.1	54.00	16.94	1000.0	1000.000	150.0	V	-181.0	79.0	7.6
2389.800	50.3	---	74.00	23.69	1000.0	1000.000	150.0	V	-181.0	79.0	7.6

Radio Technology = WLAN g, Operating Frequency = high, Band Edge = high  
(S01\_AA01)

Channel 10

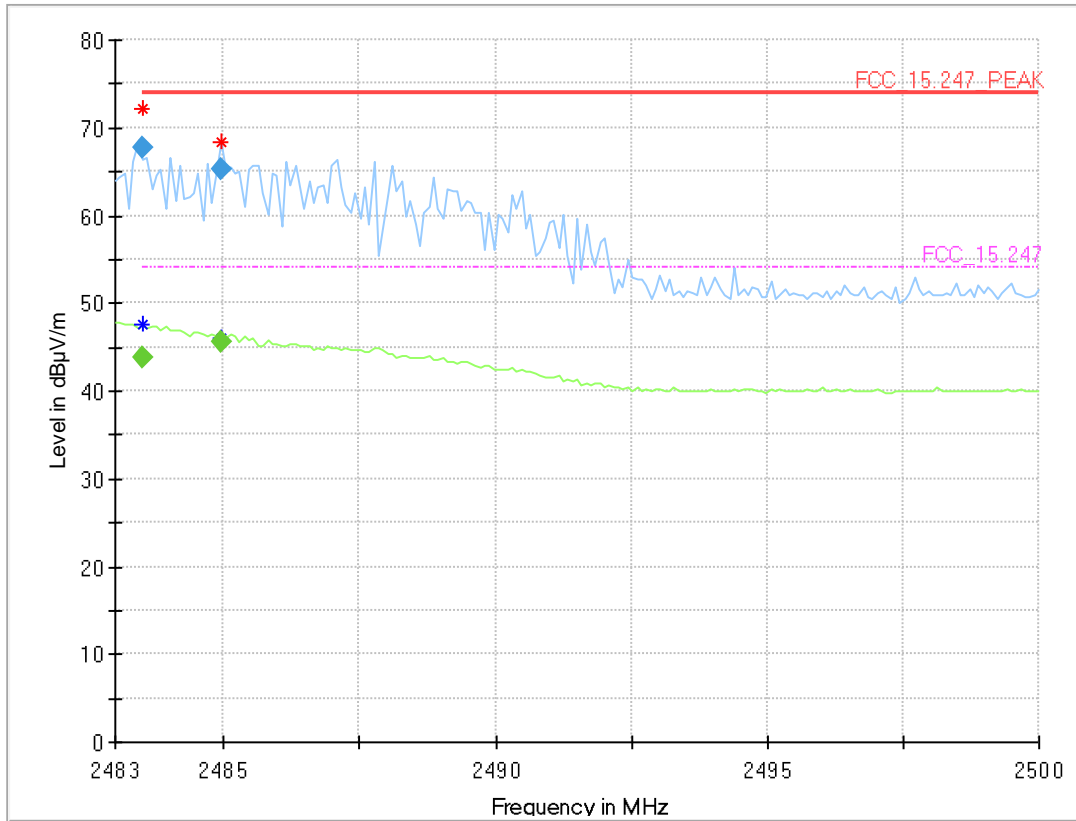

### Final Result

Frequency (MHz)	MaxPeak (dBµV/m)	CAverage (dBµV/m)	Limit (dBµV/m)	Margin (dB)	Meas. Time (ms)	Bandwidth (kHz)	Height (cm)	Pol	Azimuth (deg)	Elevation (deg)	Corr. (dB/m)
2483.510	---	43.8	54.00	10.16	1000.0	1000.000	150.0	V	139.0	-12.0	7.8
2483.510	67.6	---	74.00	6.37	1000.0	1000.000	150.0	V	139.0	-12.0	7.8
2484.955	---	45.5	54.00	8.45	1000.0	1000.000	150.0	V	11.0	-12.0	7.9
2484.955	65.2	---	74.00	8.79	1000.0	1000.000	150.0	V	11.0	-12.0	7.9

Channel 11

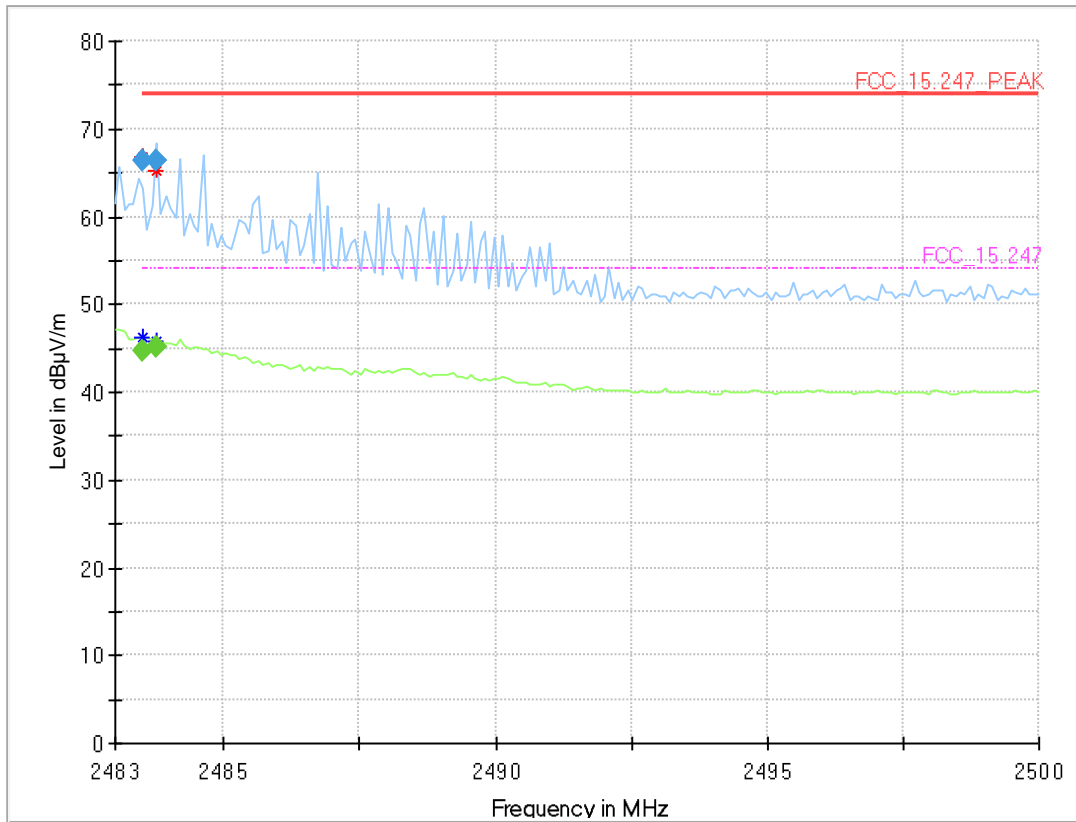

**Final Result**

Frequency (MHz)	MaxPeak (dBµV/m)	CAverage (dBµV/m)	Limit (dBµV/m)	Margin (dB)	Meas. Time (ms)	Bandwidth (kHz)	Height (cm)	Pol	Azimuth (deg)	Elevation (deg)	Corr. (dB/m)
2483.510	---	44.8	54.00	9.21	1000.0	1000.000	150.0	V	-11.0	2.0	7.8
2483.510	66.4	---	74.00	7.63	1000.0	1000.000	150.0	V	-11.0	2.0	7.8
2483.765	---	45.1	54.00	8.86	1000.0	1000.000	150.0	V	-11.0	-10.0	7.8
2483.765	66.4	---	74.00	7.59	1000.0	1000.000	150.0	V	-11.0	-10.0	7.8

Radio Technology = WLAN g, Operating Frequency = low, Band Edge = low (S01\_AA01)

Channel 1

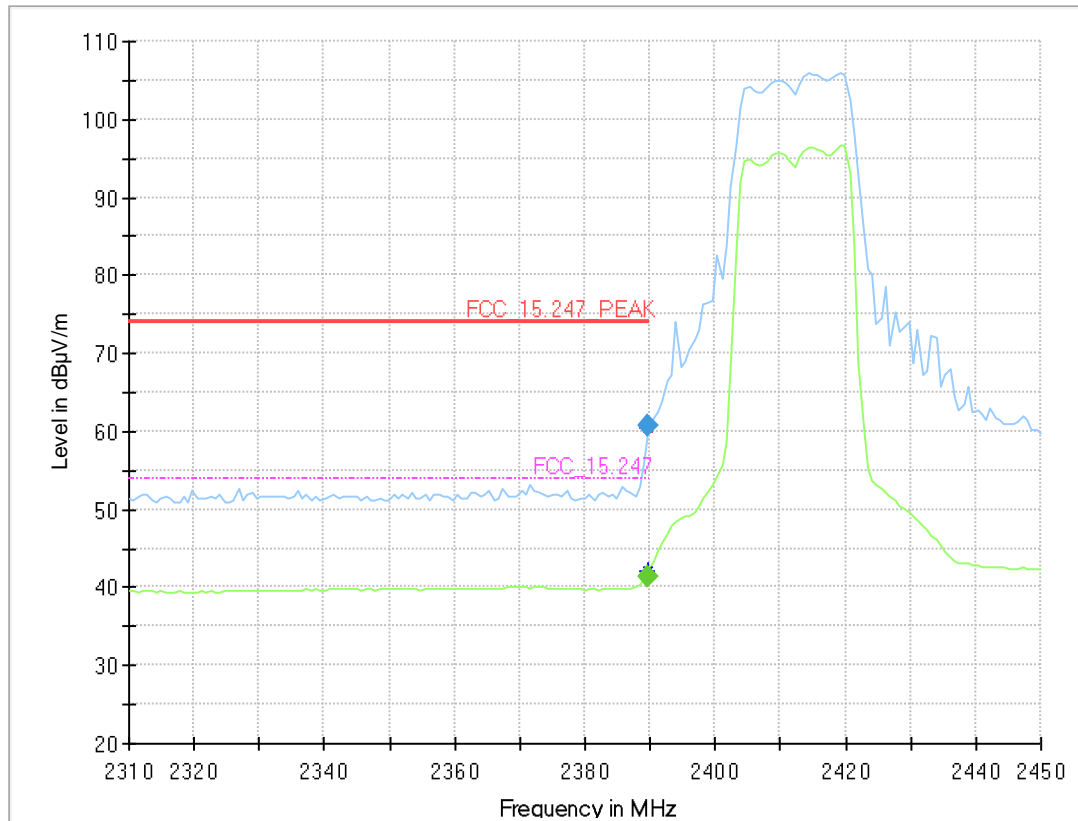

**Final Result**

Frequency (MHz)	MaxPeak (dBµV/m)	CAverage (dBµV/m)	Limit (dBµV/m)	Margin (dB)	Meas. Time (ms)	Bandwidth (kHz)	Height (cm)	Pol	Azimuth (deg)	Elevation (deg)	Corr. (dB/m)
2389.800	---	41.4	54.00	12.58	1000.0	1000.000	150.0	V	-189.0	8.0	7.6
2389.800	60.6	---	74.00	13.37	1000.0	1000.000	150.0	V	-189.0	8.0	7.6

Channel 2

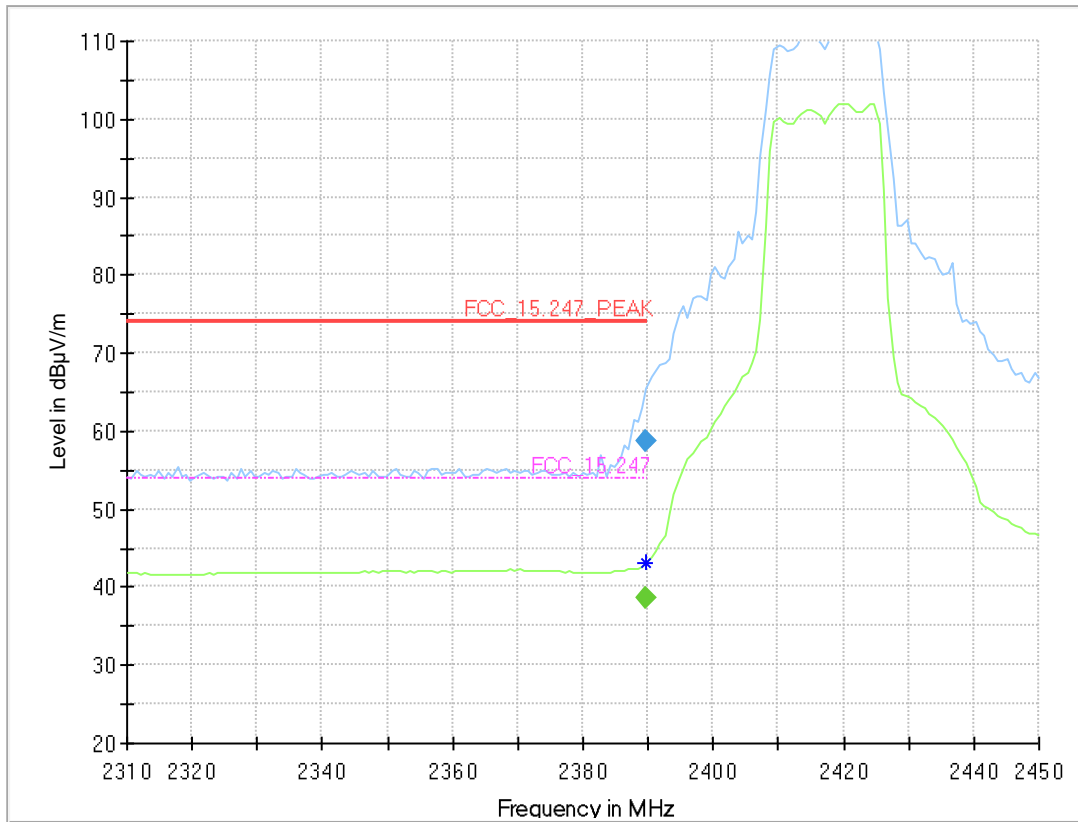

**Final Result**

Frequency (MHz)	MaxPeak (dBµV/m)	CAverage (dBµV/m)	Limit (dBµV/m)	Margin (dB)	Meas. Time (ms)	Bandwidth (kHz)	Height (cm)	Pol	Azimuth (deg)	Elevation (deg)	Corr. (dB/m)
2389.800	---	38.7	54.00	15.29	1000.0	1000.000	150.0	V	-19.0	-6.0	7.6
2389.800	58.8	---	74.00	15.22	1000.0	1000.000	150.0	V	-19.0	-6.0	7.6



Radio Technology = WLAN n 20 MHz, Operating Frequency = high, Band Edge = high (S01\_AA01)

Channel 10

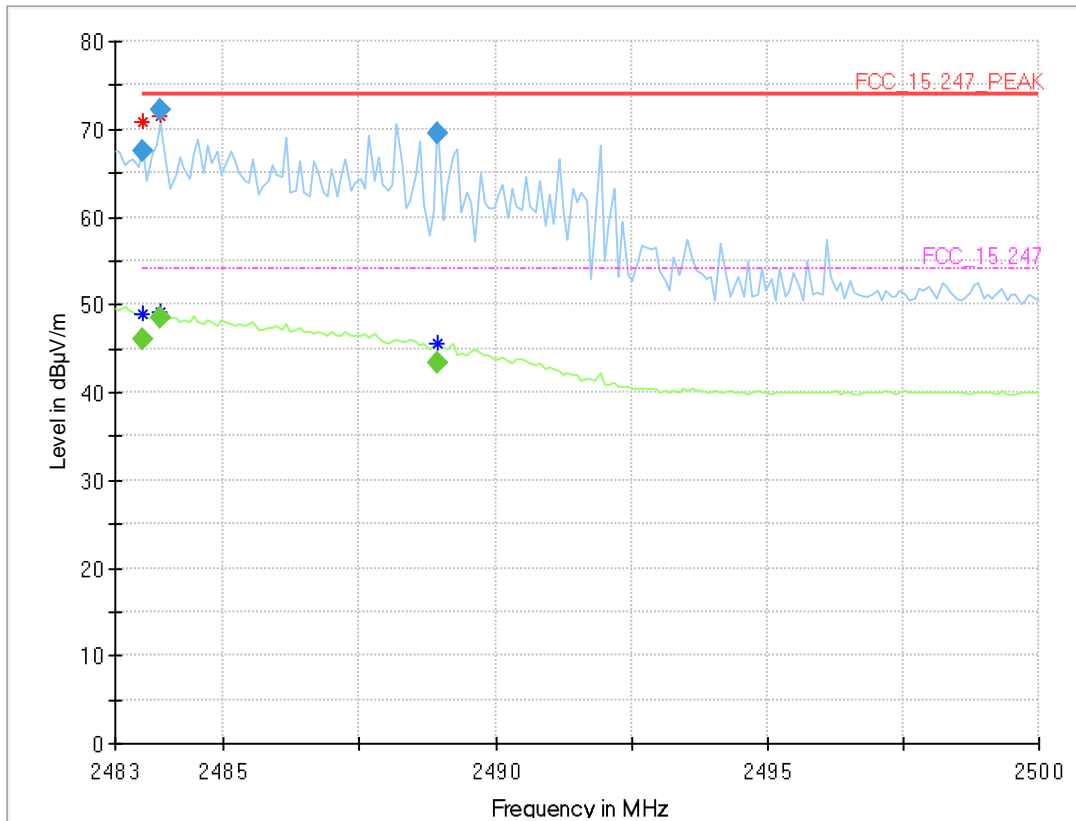

### Final Result

Frequency (MHz)	MaxPeak (dBµV/m)	CAverage (dBµV/m)	Limit (dBµV/m)	Margin (dB)	Meas. Time (ms)	Bandwidth (kHz)	Height (cm)	Pol	Azimuth (deg)	Elevation (deg)	Corr. (dB/m)
2483.510	---	46.0	54.00	7.99	1000.0	1000.000	150.0	H	109.0	82.0	7.8
2483.510	67.5	---	74.00	6.45	1000.0	1000.000	150.0	H	109.0	82.0	7.8
2483.850	---	48.4	54.00	5.59	1000.0	1000.000	150.0	V	-191.0	15.0	7.8
2483.850	72.2	---	74.00	1.80	1000.0	1000.000	150.0	V	-191.0	15.0	7.8
2488.950	---	43.3	54.00	10.72	1000.0	1000.000	150.0	V	-177.0	3.0	7.9
2488.950	69.6	---	74.00	4.41	1000.0	1000.000	150.0	V	-177.0	3.0	7.9

Channel 11

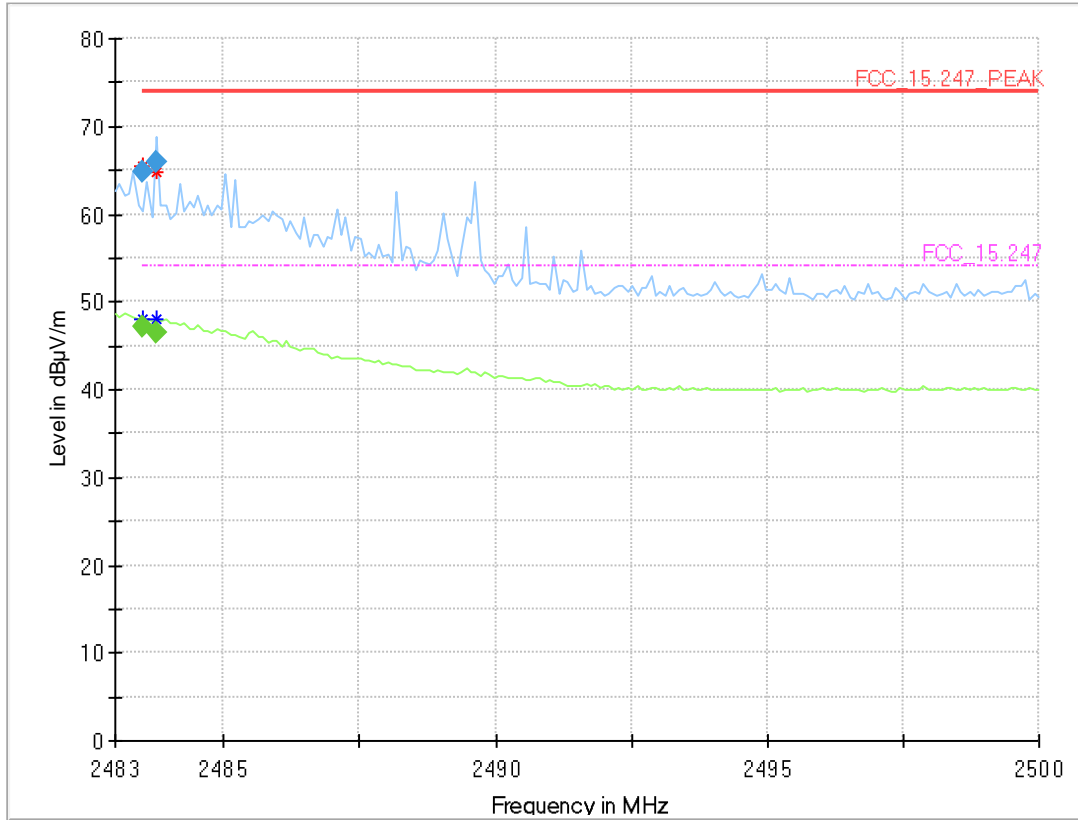

**Final Result**

Frequency (MHz)	MaxPeak (dBµV/m)	CAverage (dBµV/m)	Limit (dBµV/m)	Margin (dB)	Meas. Time (ms)	Bandwidth (kHz)	Height (cm)	Pol	Azimuth (deg)	Elevation (deg)	Corr. (dB/m)
2483.510	---	47.2	54.00	6.82	1000.0	1000.000	150.0	V	-11.0	-15.0	7.8
2483.510	64.8	---	74.00	9.18	1000.0	1000.000	150.0	V	-11.0	-15.0	7.8
2483.765	---	46.4	54.00	7.57	1000.0	1000.000	150.0	V	19.0	-2.0	7.8
2483.765	65.9	---	74.00	8.10	1000.0	1000.000	150.0	V	19.0	-2.0	7.8

Radio Technology = WLAN n 20 MHz, Operating Frequency = low, Band Edge = low (S01\_AA01)

Channel 1

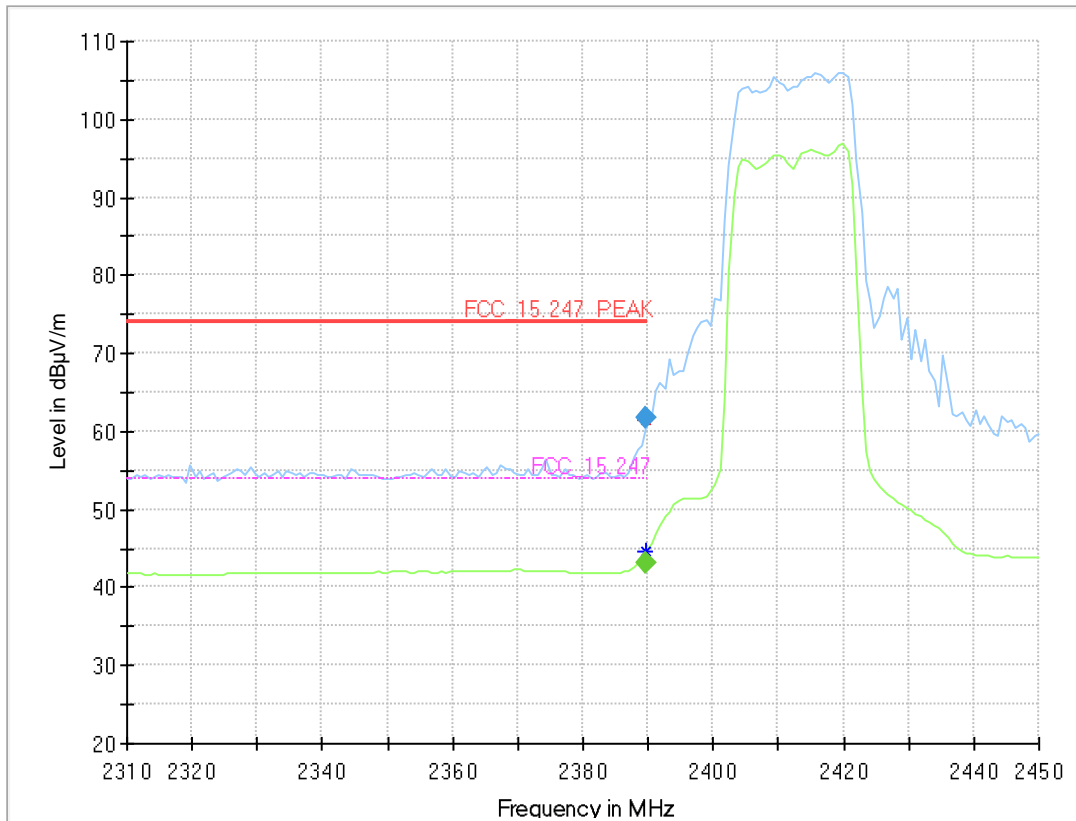

**Final Result**

Frequency (MHz)	MaxPeak (dBµV/m)	CAverage (dBµV/m)	Limit (dBµV/m)	Margin (dB)	Meas. Time (ms)	Bandwidth (kHz)	Height (cm)	Pol	Azimuth (deg)	Elevation (deg)	Corr. (dB/m)
2389.800	---	43.1	54.00	10.86	1000.0	1000.000	150.0	V	-189.0	8.0	7.6
2389.800	61.8	---	74.00	12.19	1000.0	1000.000	150.0	V	-189.0	8.0	7.6

Channel 2

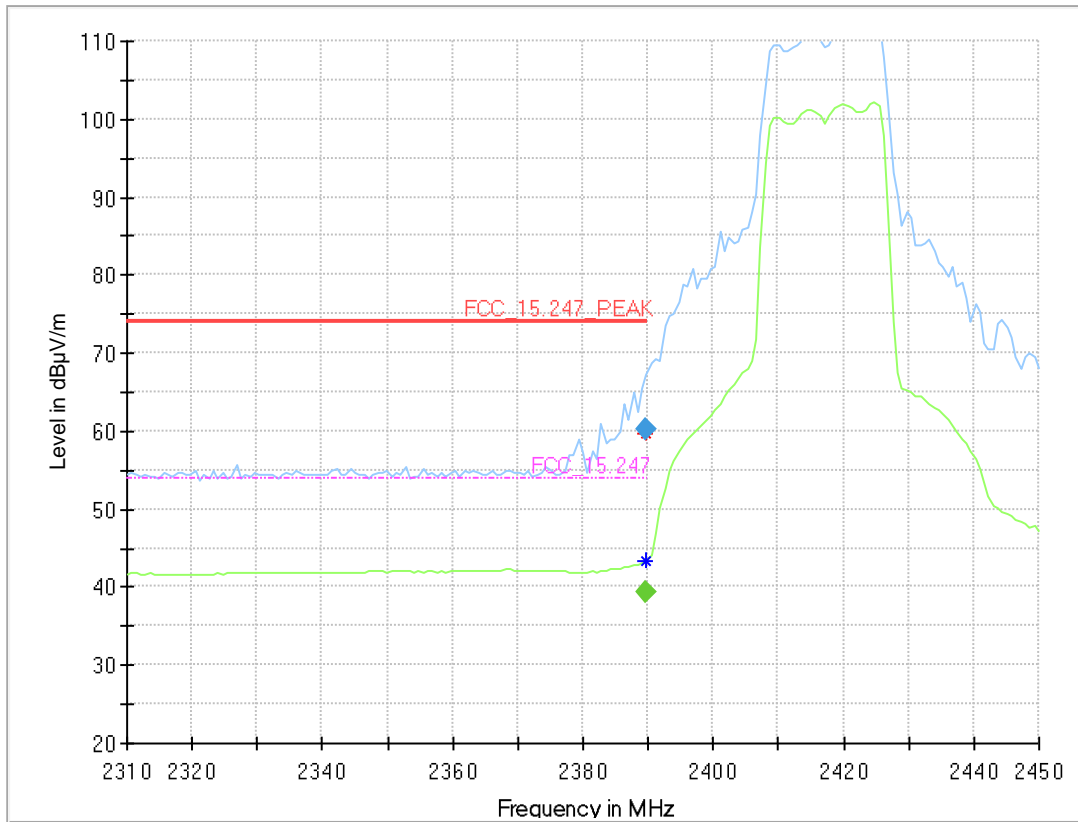

**Final Result**

Frequency (MHz)	MaxPeak (dBµV/m)	CAverage (dBµV/m)	Limit (dBµV/m)	Margin (dB)	Meas. Time (ms)	Bandwidth (kHz)	Height (cm)	Pol	Azimuth (deg)	Elevation (deg)	Corr. (dB/m)
2389.800	---	39.5	54.00	14.53	1000.0	1000.000	150.0	V	-28.0	-12.0	7.6
2389.800	60.1	---	74.00	13.87	1000.0	1000.000	150.0	V	-28.0	-12.0	7.6

Radio Technology = WLAN n 40 MHz, Operating Frequency = high, Band Edge = high (S01\_AA01)

Channel 8

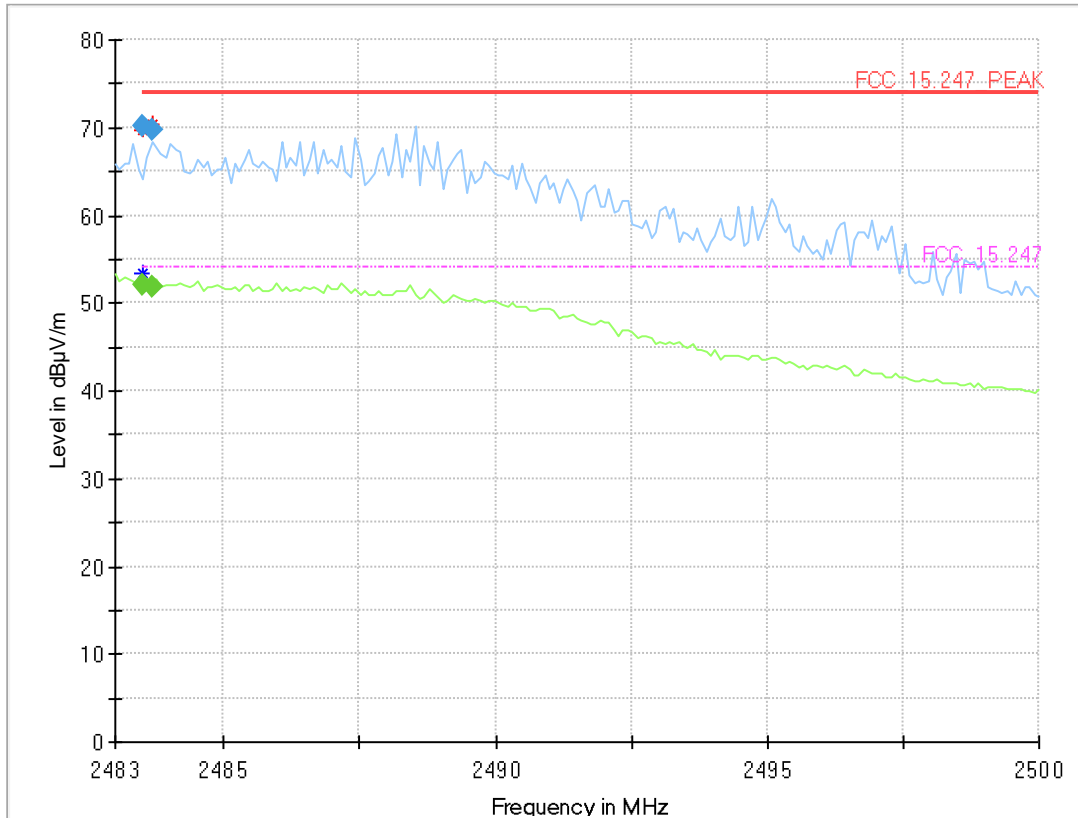

Final\_Result

Frequency (MHz)	MaxPeak (dBµV/m)	CAverage (dBµV/m)	Limit (dBµV/m)	Margin (dB)	Meas. Time (ms)	Bandwidth (kHz)	Height (cm)	Pol	Azimuth (deg)	Elevation (deg)	Corr. (dB/m)
2483.510	---	52.1	54.00	1.91	1000.0	1000.000	150.0	V	94.0	4.0	7.8
2483.510	70.1	---	74.00	3.93	1000.0	1000.000	150.0	V	94.0	4.0	7.8
2483.680	---	51.7	54.00	2.26	1000.0	1000.000	150.0	V	97.0	15.0	7.8
2483.680	69.8	---	74.00	4.21	1000.0	1000.000	150.0	V	97.0	15.0	7.8

### Channel 9

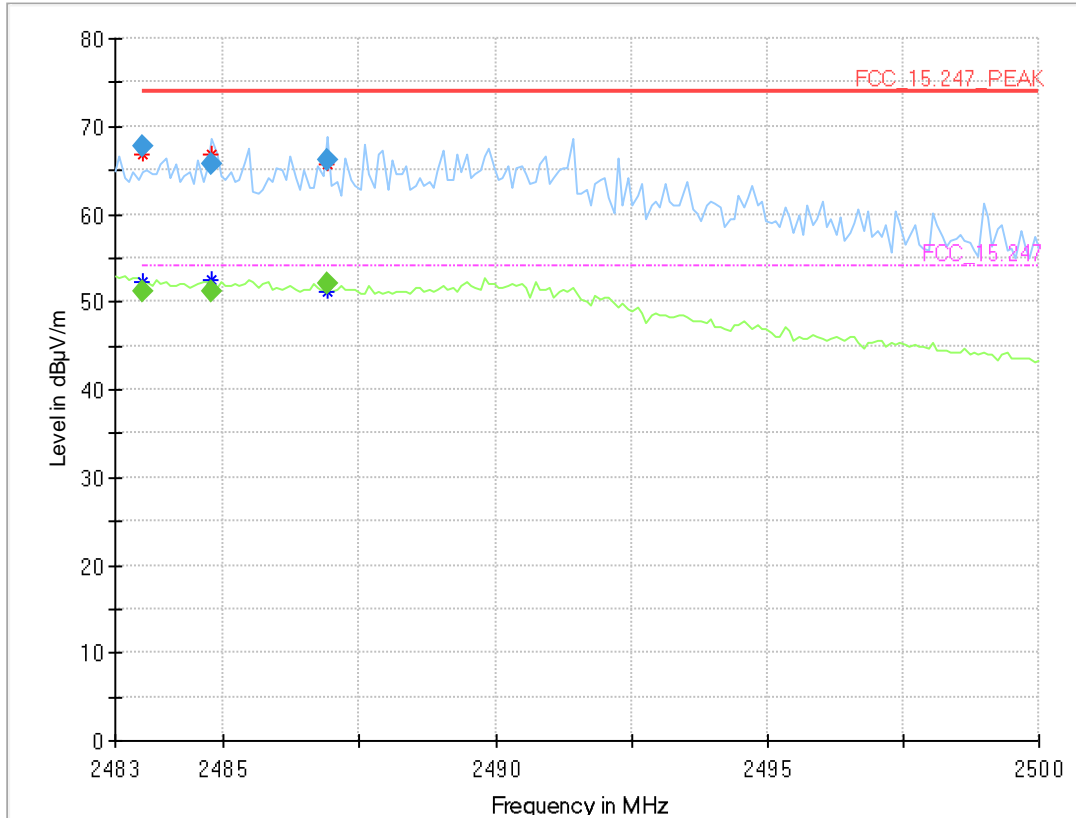

### Final Result

Frequency (MHz)	MaxPeak (dBµV/m)	CAverage (dBµV/m)	Limit (dBµV/m)	Margin (dB)	Meas. Time (ms)	Bandwidth (kHz)	Height (cm)	Pol	Azimuth (deg)	Elevation (deg)	Corr. (dB/m)
2483.510	---	51.1	54.00	2.90	1000.0	1000.000	150.0	V	19.0	-4.0	7.8
2483.510	67.8	---	74.00	6.21	1000.0	1000.000	150.0	V	19.0	-4.0	7.8
2484.785	---	51.2	54.00	2.76	1000.0	1000.000	150.0	V	19.0	-15.0	7.8
2484.785	65.7	---	74.00	8.27	1000.0	1000.000	150.0	V	19.0	-15.0	7.8
2486.910	---	52.0	54.00	1.97	1000.0	1000.000	150.0	V	11.0	-10.0	7.9
2486.910	66.1	---	74.00	7.92	1000.0	1000.000	150.0	V	11.0	-10.0	7.9

Radio Technology = WLAN n 40 MHz, Operating Frequency = low, Band Edge = low  
(S01\_AA01)

Channel 3

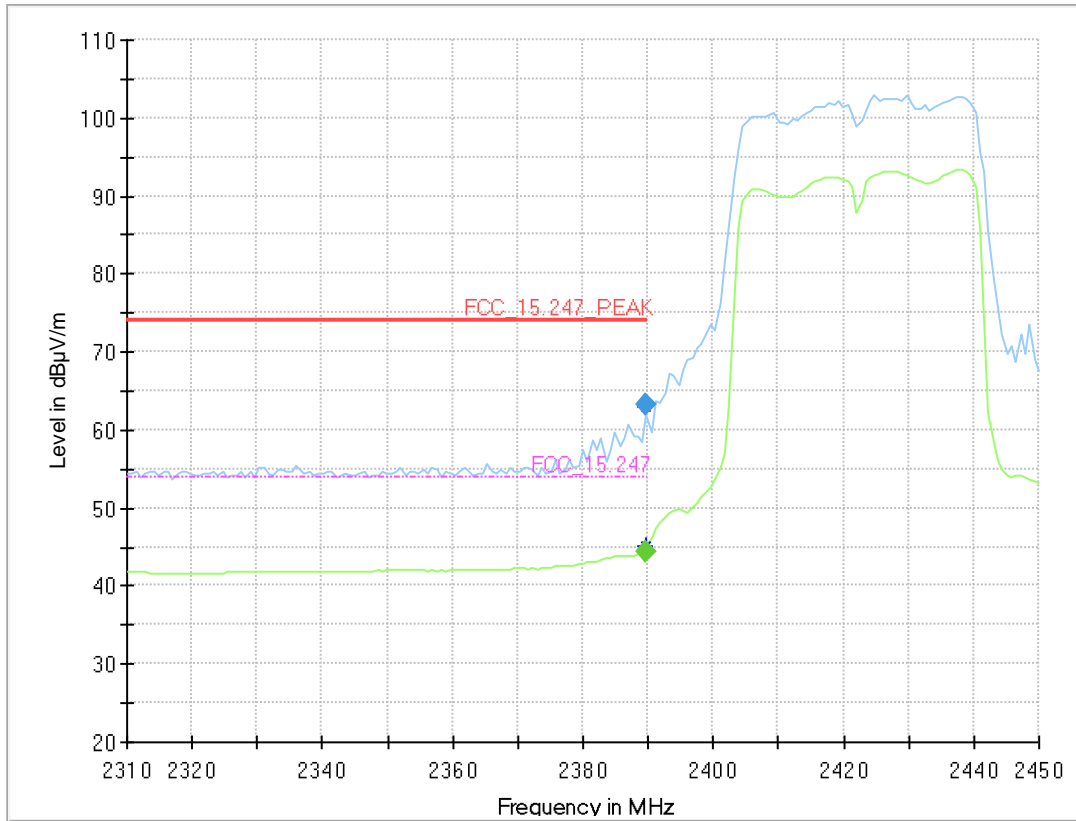

### Final Result

Frequency (MHz)	MaxPeak (dBµV/m)	CAverage (dBµV/m)	Limit (dBµV/m)	Margin (dB)	Meas. Time (ms)	Bandwidth (kHz)	Height (cm)	Pol	Azimuth (deg)	Elevation (deg)	Corr. (dB/m)
2389.800	---	44.4	54.00	9.64	1000.0	1000.000	150.0	V	-190.0	12.0	7.6
2389.800	63.2	---	74.00	10.84	1000.0	1000.000	150.0	V	-190.0	12.0	7.6

Channel 4

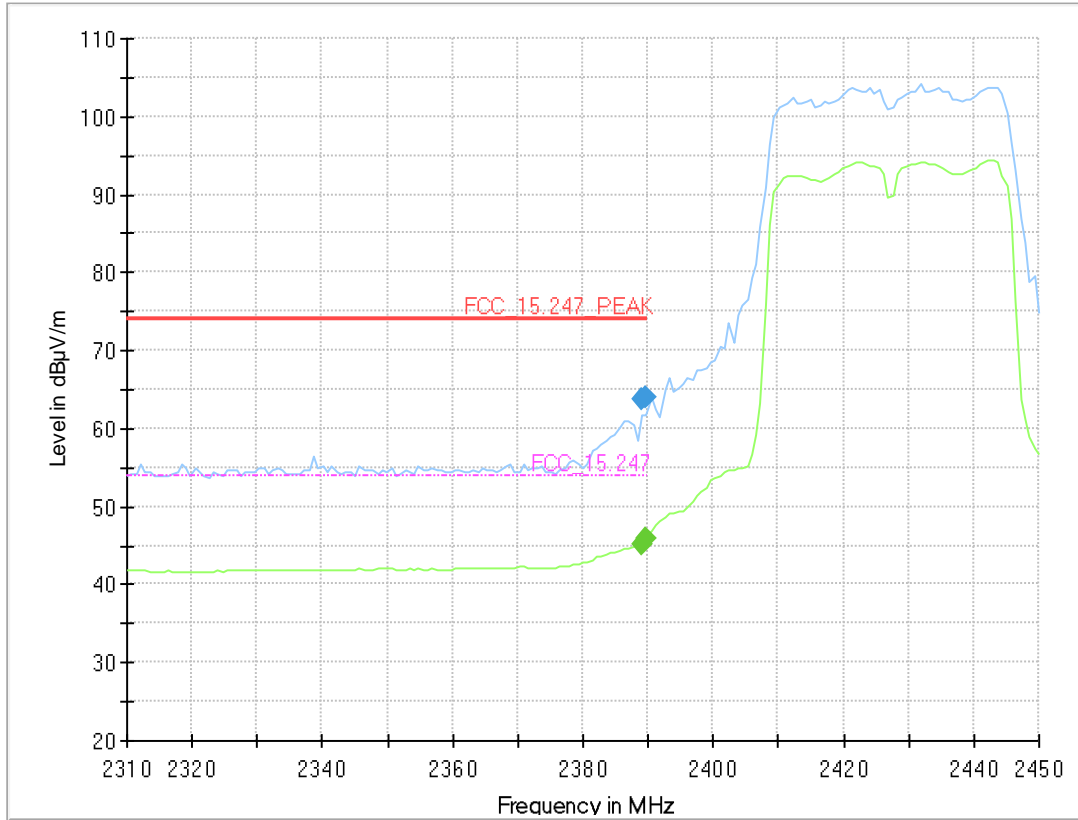

Final Result

Frequency (MHz)	MaxPeak (dBµV/m)	CAverage (dBµV/m)	Limit (dBµV/m)	Margin (dB)	Meas. Time (ms)	Bandwidth (kHz)	Height (cm)	Pol	Azimuth (deg)	Elevation (deg)	Corr. (dB/m)
2389.100	---	45.1	54.00	8.89	1000.0	1000.000	150.0	V	-190.0	15.0	7.6
2389.100	63.8	---	74.00	10.16	1000.0	1000.000	150.0	V	-190.0	15.0	7.6
2389.800	---	45.9	54.00	8.13	1000.0	1000.000	150.0	V	-190.0	15.0	7.6
2389.800	64.1	---	74.00	9.92	1000.0	1000.000	150.0	V	-190.0	15.0	7.6



Channel 5

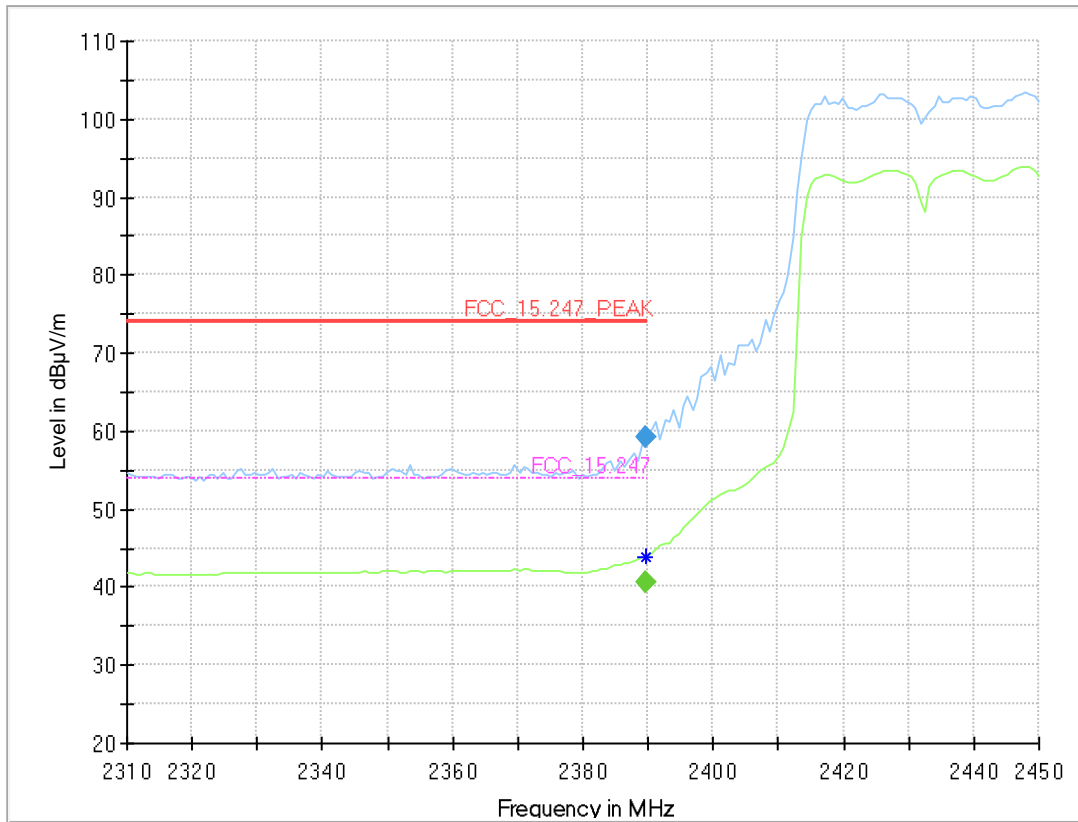

**Final Result**

Frequency (MHz)	MaxPeak (dBµV/m)	CAverage (dBµV/m)	Limit (dBµV/m)	Margin (dB)	Meas. Time (ms)	Bandwidth (kHz)	Height (cm)	Pol	Azimuth (deg)	Elevation (deg)	Corr. (dB/m)
2389.800	---	40.6	54.00	13.37	1000.0	1000.000	150.0	V	-172.0	8.0	7.6
2389.800	59.2	---	74.00	14.84	1000.0	1000.000	150.0	V	-172.0	8.0	7.6

Channel 6

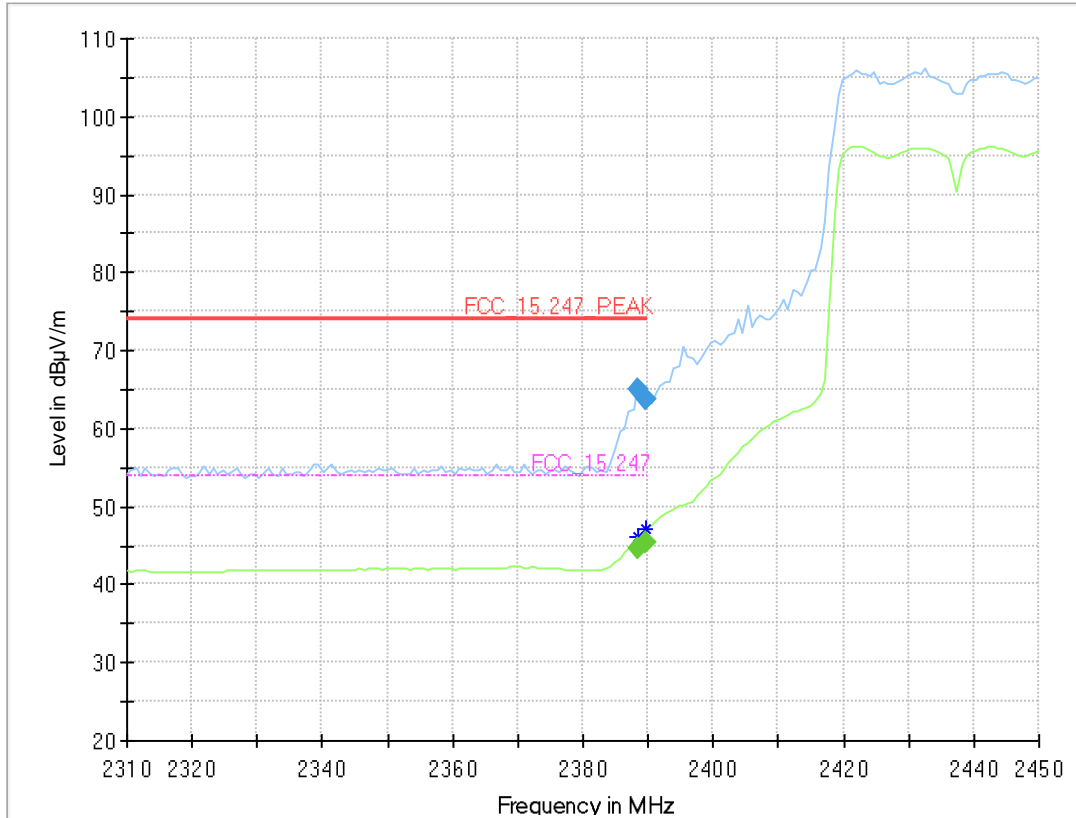

**Final Result**

Frequency (MHz)	MaxPeak (dBµV/m)	CAverage (dBµV/m)	Limit (dBµV/m)	Margin (dB)	Meas. Time (ms)	Bandwidth (kHz)	Height (cm)	Pol	Azimuth (deg)	Elevation (deg)	Corr. (dB/m)
2388.400	---	44.6	54.00	9.39	1000.0	1000.000	150.0	V	-189.0	12.0	7.5
2388.400	65.0	---	74.00	9.02	1000.0	1000.000	150.0	V	-189.0	12.0	7.5
2389.800	---	45.3	54.00	8.66	1000.0	1000.000	150.0	V	-184.0	15.0	7.6
2389.800	63.6	---	74.00	10.38	1000.0	1000.000	150.0	V	-184.0	15.0	7.6

5.3.5 TEST EQUIPMENT USED

- Radiated Emissions FAR 2.4 GHz FCC

## 6 TEST EQUIPMENT

### 6.1 TEST EQUIPMENT HARDWARE

- 1 R&S TS8997  
2.4 and 5 GHz Bands Conducted Test Lab

Ref.No.	Device Name	Description	Manufacturer	Serial Number	Last Calibration	Calibration Due
1.1	Opus10 TPR (8253.00)	T/P Logger 13	Lufft Mess- und Regeltechnik GmbH	13936	2023-12	2025-12
1.2	SMB100A	Signal Generator 9 kHz - 6 GHz	Rohde & Schwarz	107695	2021-06	2024-06
1.3	EX520	Digital Multimeter 12	Extech Instruments Corp	05157876	2022-06	2024-06
1.4	FSV30	Signal Analyzer 10 Hz - 30 GHz	Rohde & Schwarz	103005	2023-08	2025-08
1.5	NGSM 32/10	Power Supply	Rohde & Schwarz GmbH & Co. KG	3456		
1.6	Temperature Chamber VT 4002	Temperature Chamber Vötsch 03	Vötsch	58566002150010	2022-05	2024-05
1.7	FSW43	Signal Analyser	Rohde & Schwarz GmbH & Co. KG	102013	2023-07	2025-07
1.8	Opus10 THI (8152.00)	T/H Logger 14	Lufft Mess- und Regeltechnik GmbH	13993	2023-12	2025-12
1.9	SMBV100A	Vector Signal Generator 9 kHz - 6 GHz	Rohde & Schwarz	259291	2023-01	2026-01
1.10	OSP120	Contains Power Meter and Switching Unit OSP-B157W8 PLUS	Rohde & Schwarz	101158	2021-08	2024-08
1.11	CS-RUB6	Rubidium Frequency Standard	Rohde & Schwarz GmbH & Co. KG	100321	2023-10	2024-10

- 2 Radiated Emissions FAR 2.4 GHz FCC  
Radiated emission tests for 2.4 GHz ISM devices in a fully anechoic room

Ref.No.	Device Name	Description	Manufacturer	Serial Number	Last Calibration	Calibration Due
2.1	Opus10 TPR (8253.00)	T/P Logger 13	Lufft Mess- und Regeltechnik GmbH	13936	2023-12	2025-12
2.2	Innco Systems CO3000	Controller for bore sight mast FAC		CO3000/1460/54740522/P	N/A	N/A
2.3	AMF-7D00101800-30-10P-R	Broadband Amplifier 100 MHz - 18 GHz	Miteq		N/A	N/A
2.4	Anechoic Chamber 03	FAR, 8.80m x 4.60m x 4.05m (l x w x h)	Albatross Projects	P26971-647-001-PRB	N/A	N/A

Ref.No.	Device Name	Description	Manufacturer	Serial Number	Last Calibration	Calibration Due
2.5	Fluke 177	Digital Multimeter 03 (Multimeter)	Fluke Europe B.V.	86670383	2023-08	2025-08
2.6	JS4-18002600-32-5P	Broadband Amplifier 18 GHz - 26 GHz	Miteq	849785	N/A	N/A
2.7	FSW43	Spectrum Analyzer	Rohde & Schwarz GmbH & Co. KG	103779	2023-04	2025-04
2.8	EP 1200/B, NA/B1	AC Source, Amplifier with integrated variable Oscillator	Spitzenberger & Spies GmbH & Co. KG	B6278	N/A	N/A
2.9	3160-09	Standard Gain / Pyramidal Horn Antenna 26.5 GHz	EMCO Elektronik GmbH	00083069	N/A	N/A
2.10	WHKX 7.0/18G-8SS	High Pass Filter	Wainwright Instruments GmbH	09	N/A	N/A
2.11	MA3000/0800-XP-ET-compact	Bore Sight Antenna Mast			N/A	N/A
2.12	TT 1.5 WI	Turn Table	Maturo GmbH	-	N/A	N/A
2.13	5HC3500/18000-1.2-KK	High Pass Filter	Trilithic	200035008	N/A	N/A
2.14	Opus 20 THI (8120.00)	ThermoHygro Datalogger	Lufft Mess- und Regeltechnik GmbH	115.0318.0802.033	2023-08	2025-08
2.15	TD1.5-10kg	EUT Tilt Device (Rohacell)	Maturo GmbH	TD1.5-10kg/024/3790709	N/A	N/A
2.16	AFS42-00101800-25-S-42	Broadband Amplifier 25 MHz - 18 GHz	Miteq	2035324	N/A	N/A
2.17	HF 907	Double-ridged horn	Rohde & Schwarz	102444	2021-09	2024-09

3 Radiated Emissions SAC H-Field  
Radiated emission tests in the H-Field in a semi anechoic room

Ref.No.	Device Name	Description	Manufacturer	Serial Number	Last Calibration	Calibration Due
3.1	N5000/NP	Filter for EUT, 2 Lines, 250 V, 16 A	ETS-LINDGREN	241515	N/A	N/A
3.2	Opus10 TPR (8253.00)	T/P Logger 13	Lufft Mess- und Regeltechnik GmbH	13936	2023-12	2025-12
3.3	ESW44	EMI Receiver / Spectrum Analyzer	Rohde & Schwarz GmbH & Co. KG	101603		
3.4	Anechoic Chamber 01	SAC/FAR, 10.58 m x 6.38 m x 6.00 m	undefined, undefined	none	N/A	N/A
3.5	Fluke 177	Digital Multimeter 03 (Multimeter)	Fluke Europe B.V.	86670383	2023-08	2025-08
3.6	Opus10 THI (8152.00)	T/H Logger 10	Lufft Mess- und Regeltechnik GmbH	12488	2023-12	2025-12

Ref.No.	Device Name	Description	Manufacturer	Serial Number	Last Calibration	Calibration Due
3.7	EP 1200/B, NA/B1	AC Source, Amplifier with integrated variable Oscillator	Spitzenberger & Spies GmbH & Co. KG	B6278	N/A	N/A
3.8	DS 420S	Turn Table 2 m diameter	HD GmbH	420/573/99	N/A	N/A
3.9	HFH2-Z2	Loop Antenna + 3 Axis Tripod	Rohde & Schwarz GmbH & Co. KG	829324/006		
3.10	CS-RUB6	Rubidium Frequency Standard	Rohde & Schwarz GmbH & Co. KG	100321	2023-10	2024-10

4 Radiated Emissions SAC up to 1 GHz  
 Radiated emission tests up to 1 GHz in a semi anechoic room

Ref.No.	Device Name	Description	Manufacturer	Serial Number	Last Calibration	Calibration Due
4.1	N5000/NP	Filter for EUT, 2 Lines, 250 V, 16 A	ETS-LINDGREN	241515	N/A	N/A
4.2	Opus10 TPR (8253.00)	T/P Logger 13	Lufft Mess- und Regeltechnik GmbH	13936	2023-12	2025-12
4.3	ESW44	EMI Receiver / Spectrum Analyzer	Rohde & Schwarz GmbH & Co. KG	101603		
4.4	Anechoic Chamber 01	SAC/FAR, 10.58 m x 6.38 m x 6.00 m	undefined, undefined	none	N/A	N/A
4.5	HL 562 ULTRALOG	Biconical-log-per antenna (30 MHz - 3 GHz) with HL 562E biconicals	Rohde & Schwarz GmbH & Co. KG	830547/003	2021-09	2024-09
4.6	Fluke 177	Digital Multimeter 03 (Multimeter)	Fluke Europe B.V.	86670383	2023-08	2025-08
4.7	Opus10 THI (8152.00)	T/H Logger 10	Lufft Mess- und Regeltechnik GmbH	12488	2023-12	2025-12
4.8	EP 1200/B, NA/B1	AC Source, Amplifier with integrated variable Oscillator	Spitzenberger & Spies GmbH & Co. KG	B6278	N/A	N/A
4.9	DS 420S	Turn Table 2 m diameter	HD GmbH	420/573/99	N/A	N/A
4.10	CS-RUB6	Rubidium Frequency Standard	Rohde & Schwarz GmbH & Co. KG	100321	2023-10	2024-10
4.11	AM 4.0	Antenna Mast 4 m	Maturo GmbH	AM4.0/180/1192 0513	N/A	N/A

The calibration interval is the time interval between "Last Calibration" and "Calibration Due"

## 6.2 TEST EQUIPMENT SOFTWARE

<b>Semi-Anechoic Chamber:</b>	
Software	Version
EMC32 Measurement Software	10.60.10
INNCO Mast Controller	1.02.62
MATURO Mast Controller	12.19
MATURO Turn-Table Controller	30.10
<b>Fully-Anechoic Chamber:</b>	
Software	Version
EMC32 Measurement Software	10.60.10
MATURO Turn-Unit Controller	11.10
MATURO Mast Controller	12.10
MATURO Turntable Controller	12.11
INNCO Mast Controller	1.02.62
<b>TS 8997</b>	
WMC32 Measurement Software	11.40.00
<b>Conducted AC Emissions:</b>	
Software	Version
EMC32 Measurement Software	10.60.20

## 7 ANTENNA FACTORS, CABLE LOSS AND SAMPLE CALCULATIONS

This chapter contains the antenna factors with their corresponding path loss of the used measurement path for all antennas as well as the insertion loss of the LISN.

### 7.1 LISN R&S ESH3-Z5 (150 KHZ – 30 MHZ)

Frequency MHz	Corr. dB	LISN insertion loss ESH3- Z5 dB	cable loss (incl. 10 dB atten- uator) dB
0.15	10.1	0.1	10.0
5	10.3	0.1	10.2
7	10.5	0.2	10.3
10	10.5	0.2	10.3
12	10.7	0.3	10.4
14	10.7	0.3	10.4
16	10.8	0.4	10.4
18	10.9	0.4	10.5
20	10.9	0.4	10.5
22	11.1	0.5	10.6
24	11.1	0.5	10.6
26	11.2	0.5	10.7
28	11.2	0.5	10.7
30	11.3	0.5	10.8

#### Sample calculation

$$U_{\text{LISN}} (\text{dB } \mu\text{V}) = U (\text{dB } \mu\text{V}) + \text{Corr. (dB)}$$

U = Receiver reading

LISN Insertion loss = Voltage Division Factor of LISN

Corr. = sum of single correction factors of used LISN, cables, switch units (if used)

Linear interpolation will be used for frequencies in between the values in the table.

## 7.2 ANTENNA R&S HFH2-Z2 (9 KHZ – 30 MHZ)

Frequency MHz	AF HFH-Z2) dB (1/m)	Corr. dB	cable loss 1 (inside chamber) dB	cable loss 2 (outside chamber) dB	cable loss 3 (switch unit) dB	cable loss 4 (to receiver) dB	distance corr. (-40 dB/ decade) dB	d <sub>Limit</sub> (meas. distance (limit) m	d <sub>used</sub> (meas. distance (used) m
0.009	20.50	-79.6	0.1	0.1	0.1	0.1	-80	300	3
0.01	20.45	-79.6	0.1	0.1	0.1	0.1	-80	300	3
0.015	20.37	-79.6	0.1	0.1	0.1	0.1	-80	300	3
0.02	20.36	-79.6	0.1	0.1	0.1	0.1	-80	300	3
0.025	20.38	-79.6	0.1	0.1	0.1	0.1	-80	300	3
0.03	20.32	-79.6	0.1	0.1	0.1	0.1	-80	300	3
0.05	20.35	-79.6	0.1	0.1	0.1	0.1	-80	300	3
0.08	20.30	-79.6	0.1	0.1	0.1	0.1	-80	300	3
0.1	20.20	-79.6	0.1	0.1	0.1	0.1	-80	300	3
0.2	20.17	-79.6	0.1	0.1	0.1	0.1	-80	300	3
0.3	20.14	-79.6	0.1	0.1	0.1	0.1	-80	300	3
0.49	20.12	-79.6	0.1	0.1	0.1	0.1	-80	300	3
0.490001	20.12	-39.6	0.1	0.1	0.1	0.1	-40	30	3
0.5	20.11	-39.6	0.1	0.1	0.1	0.1	-40	30	3
0.8	20.10	-39.6	0.1	0.1	0.1	0.1	-40	30	3
1	20.09	-39.6	0.1	0.1	0.1	0.1	-40	30	3
2	20.08	-39.6	0.1	0.1	0.1	0.1	-40	30	3
3	20.06	-39.6	0.1	0.1	0.1	0.1	-40	30	3
4	20.05	-39.5	0.2	0.1	0.1	0.1	-40	30	3
5	20.05	-39.5	0.2	0.1	0.1	0.1	-40	30	3
6	20.02	-39.5	0.2	0.1	0.1	0.1	-40	30	3
8	19.95	-39.5	0.2	0.1	0.1	0.1	-40	30	3
10	19.83	-39.4	0.2	0.1	0.2	0.1	-40	30	3
12	19.71	-39.4	0.2	0.1	0.2	0.1	-40	30	3
14	19.54	-39.4	0.2	0.1	0.2	0.1	-40	30	3
16	19.53	-39.3	0.3	0.1	0.2	0.1	-40	30	3
18	19.50	-39.3	0.3	0.1	0.2	0.1	-40	30	3
20	19.57	-39.3	0.3	0.1	0.2	0.1	-40	30	3
22	19.61	-39.3	0.3	0.1	0.2	0.1	-40	30	3
24	19.61	-39.3	0.3	0.1	0.2	0.1	-40	30	3
26	19.54	-39.3	0.3	0.1	0.2	0.1	-40	30	3
28	19.46	-39.2	0.3	0.1	0.3	0.1	-40	30	3
30	19.73	-39.1	0.4	0.1	0.3	0.1	-40	30	3

### Sample calculation

$$E \text{ (dB } \mu\text{V/m)} = U \text{ (dB } \mu\text{V)} + AF \text{ (dB 1/m)} + Corr. \text{ (dB)}$$

U = Receiver reading

AF = Antenna factor

Corr. = sum of single correction factors of used cables, switch unit, distance correction, amplifier (if applicable)

distance correction =  $-40 * \text{LOG} (d_{\text{Limit}} / d_{\text{used}})$

Linear interpolation will be used for frequencies in between the values in the table.

Table shows an extract of values



### 7.3 ANTENNA R&S HL562 (30 MHZ – 1 GHZ)

( $d_{Limit} = 3\text{ m}$ )

Frequency	AF R&S HL562	Corr.
MHz	dB (1/m)	dB
30	18.6	0.6
50	6.0	0.9
100	9.7	1.2
150	7.9	1.6
200	7.6	1.9
250	9.5	2.1
300	11.0	2.3
350	12.4	2.6
400	13.6	2.9
450	14.7	3.1
500	15.6	3.2
550	16.3	3.5
600	17.2	3.5
650	18.1	3.6
700	18.5	3.6
750	19.1	4.1
800	19.6	4.1
850	20.1	4.4
900	20.8	4.7
950	21.1	4.8
1000	21.6	4.9

cable loss 1 (inside chamber)	cable loss 2 (outside chamber)	cable loss 3 (switch unit)	cable loss 4 (to receiver)	distance corr. (-20 dB/decade)	$d_{Limit}$ (meas. distance (limit))	$d_{used}$ (meas. distance (used))
dB	dB	dB	dB	dB	m	m
0.29	0.04	0.23	0.02	0.0	3	3
0.39	0.09	0.32	0.08	0.0	3	3
0.56	0.14	0.47	0.08	0.0	3	3
0.73	0.20	0.59	0.12	0.0	3	3
0.84	0.21	0.70	0.11	0.0	3	3
0.98	0.24	0.80	0.13	0.0	3	3
1.04	0.26	0.89	0.15	0.0	3	3
1.18	0.31	0.96	0.13	0.0	3	3
1.28	0.35	1.03	0.19	0.0	3	3
1.39	0.38	1.11	0.22	0.0	3	3
1.44	0.39	1.20	0.19	0.0	3	3
1.55	0.46	1.24	0.23	0.0	3	3
1.59	0.43	1.29	0.23	0.0	3	3
1.67	0.34	1.35	0.22	0.0	3	3
1.67	0.42	1.41	0.15	0.0	3	3
1.87	0.54	1.46	0.25	0.0	3	3
1.90	0.46	1.51	0.25	0.0	3	3
1.99	0.60	1.56	0.27	0.0	3	3
2.14	0.60	1.63	0.29	0.0	3	3
2.22	0.60	1.66	0.33	0.0	3	3
2.23	0.61	1.71	0.30	0.0	3	3

( $d_{Limit} = 10\text{ m}$ )

30	18.6	-9.9
50	6.0	-9.6
100	9.7	-9.2
150	7.9	-8.8
200	7.6	-8.6
250	9.5	-8.3
300	11.0	-8.1
350	12.4	-7.9
400	13.6	-7.6
450	14.7	-7.4
500	15.6	-7.2
550	16.3	-7.0
600	17.2	-6.9
650	18.1	-6.9
700	18.5	-6.8
750	19.1	-6.3
800	19.6	-6.3
850	20.1	-6.0
900	20.8	-5.8
950	21.1	-5.6
1000	21.6	-5.6

0.29	0.04	0.23	0.02	-10.5	10	3
0.39	0.09	0.32	0.08	-10.5	10	3
0.56	0.14	0.47	0.08	-10.5	10	3
0.73	0.20	0.59	0.12	-10.5	10	3
0.84	0.21	0.70	0.11	-10.5	10	3
0.98	0.24	0.80	0.13	-10.5	10	3
1.04	0.26	0.89	0.15	-10.5	10	3
1.18	0.31	0.96	0.13	-10.5	10	3
1.28	0.35	1.03	0.19	-10.5	10	3
1.39	0.38	1.11	0.22	-10.5	10	3
1.44	0.39	1.20	0.19	-10.5	10	3
1.55	0.46	1.24	0.23	-10.5	10	3
1.59	0.43	1.29	0.23	-10.5	10	3
1.67	0.34	1.35	0.22	-10.5	10	3
1.67	0.42	1.41	0.15	-10.5	10	3
1.87	0.54	1.46	0.25	-10.5	10	3
1.90	0.46	1.51	0.25	-10.5	10	3
1.99	0.60	1.56	0.27	-10.5	10	3
2.14	0.60	1.63	0.29	-10.5	10	3
2.22	0.60	1.66	0.33	-10.5	10	3
2.23	0.61	1.71	0.30	-10.5	10	3

#### Sample calculation

$$E \text{ (dB } \mu\text{V/m)} = U \text{ (dB } \mu\text{V)} + \text{AF (dB 1/m)} + \text{Corr. (dB)}$$

U = Receiver reading

AF = Antenna factor

Corr. = sum of single correction factors of used cables, switch unit, distance correction, amplifier (if applicable)

distance correction =  $-20 * \text{LOG} (d_{Limit} / d_{used})$

Linear interpolation will be used for frequencies in between the values in the table.

Tables show an extract of values.

### 7.4 ANTENNA R&S HF907 (1 GHZ – 18 GHZ)

Frequency	AF R&S HF907	Corr.
MHz	dB (1/m)	dB
1000	24.4	-19.4
2000	28.5	-17.4
3000	31.0	-16.1
4000	33.1	-14.7
5000	34.4	-13.7
6000	34.7	-12.7
7000	35.6	-11.0

cable loss 1 (relay + cable inside chamber)	cable loss 2 (outside chamber)	cable loss 3 (switch unit, attenuator & pre-amp)	cable loss 4 (to receiver)		
dB	dB	dB	dB		
0.99	0.31	-21.51	0.79		
1.44	0.44	-20.63	1.38		
1.87	0.53	-19.85	1.33		
2.41	0.67	-19.13	1.31		
2.78	0.86	-18.71	1.40		
2.74	0.90	-17.83	1.47		
2.82	0.86	-16.19	1.46		

Frequency	AF R&S HF907	Corr.
MHz	dB (1/m)	dB
3000	31.0	-23.4
4000	33.1	-23.3
5000	34.4	-21.7
6000	34.7	-21.2
7000	35.6	-19.8

cable loss 1 (relay inside chamber)	cable loss 2 (inside chamber)	cable loss 3 (outside chamber)	cable loss 4 (switch unit, attenuator & pre-amp)	cable loss 5 (to receiver)	used for FCC 15.247
dB	dB	dB	dB	dB	
0.47	1.87	0.53	-27.58	1.33	
0.56	2.41	0.67	-28.23	1.31	
0.61	2.78	0.86	-27.35	1.40	
0.58	2.74	0.90	-26.89	1.47	
0.66	2.82	0.86	-25.58	1.46	

Frequency	AF R&S HF907	Corr.
MHz	dB (1/m)	dB
7000	35.6	-57.3
8000	36.3	-56.3
9000	37.1	-55.3
10000	37.5	-56.2
11000	37.5	-55.3
12000	37.6	-53.7
13000	38.2	-53.5
14000	39.9	-56.3
15000	40.9	-54.1
16000	41.3	-54.1
17000	42.8	-54.4
18000	44.2	-54.7

cable loss 1 (relay inside chamber)	cable loss 2 (High Pass)	cable loss 3 (pre-amp)	cable loss 4 (inside chamber)	cable loss 5 (outside chamber)	cable loss 6 (to receiver)
dB	dB	dB	dB	dB	dB
0.56	1.28	-62.72	2.66	0.94	1.46
0.69	0.71	-61.49	2.84	1.00	1.53
0.68	0.65	-60.80	3.06	1.09	1.60
0.70	0.54	-61.91	3.28	1.20	1.67
0.80	0.61	-61.40	3.43	1.27	1.70
0.84	0.42	-59.70	3.53	1.26	1.73
0.83	0.44	-59.81	3.75	1.32	1.83
0.91	0.53	-63.03	3.91	1.40	1.77
0.98	0.54	-61.05	4.02	1.44	1.83
1.23	0.49	-61.51	4.17	1.51	1.85
1.36	0.76	-62.36	4.34	1.53	2.00
1.70	0.53	-62.88	4.41	1.55	1.91

#### Sample calculation

$E \text{ (dB } \mu\text{V/m)} = U \text{ (dB } \mu\text{V)} + AF \text{ (dB 1/m)} + Corr. \text{ (dB)}$   
 U = Receiver reading  
 AF = Antenna factor  
 Corr. = sum of single correction factors of used cables, switch unit, distance correction, amplifier (if applicable)  
 Linear interpolation will be used for frequencies in between the values in the table.  
 Tables show an extract of values.

### 7.5 ANTENNA EMCO 3160-09 (18 GHZ – 26.5 GHZ)

Frequency MHz	AF EMCO 3160-09 dB (1/m)	Corr. dB
18000	40.2	-23.5
18500	40.2	-23.2
19000	40.2	-22.0
19500	40.3	-21.3
20000	40.3	-20.3
20500	40.3	-19.9
21000	40.3	-19.1
21500	40.3	-19.1
22000	40.3	-18.7
22500	40.4	-19.0
23000	40.4	-19.5
23500	40.4	-19.3
24000	40.4	-19.8
24500	40.4	-19.5
25000	40.4	-19.3
25500	40.5	-20.4
26000	40.5	-21.3
26500	40.5	-21.1

cable loss 1 (inside chamber) dB	cable loss 2 (pre- amp) dB	cable loss 3 (inside chamber) dB	cable loss 4 (switch unit) dB	cable loss 5 (to receiver) dB
0.72	-35.85	6.20	2.81	2.65
0.69	-35.71	6.46	2.76	2.59
0.76	-35.44	6.69	3.15	2.79
0.74	-35.07	7.04	3.11	2.91
0.72	-34.49	7.30	3.07	3.05
0.78	-34.46	7.48	3.12	3.15
0.87	-34.07	7.61	3.20	3.33
0.90	-33.96	7.47	3.28	3.19
0.89	-33.57	7.34	3.35	3.28
0.87	-33.66	7.06	3.75	2.94
0.88	-33.75	6.92	3.77	2.70
0.90	-33.35	6.99	3.52	2.66
0.88	-33.99	6.88	3.88	2.58
0.91	-33.89	7.01	3.93	2.51
0.88	-33.00	6.72	3.96	2.14
0.89	-34.07	6.90	3.66	2.22
0.86	-35.11	7.02	3.69	2.28
0.90	-35.20	7.15	3.91	2.36

#### Sample calculation

$E \text{ (dB } \mu\text{V/m)} = U \text{ (dB } \mu\text{V)} + AF \text{ (dB 1/m)} + Corr. \text{ (dB)}$   
 U = Receiver reading  
 AF = Antenna factor  
 Corr. = sum of single correction factors of used cables, switch unit, distance correction, amplifier (if applicable)  
 Linear interpolation will be used for frequencies in between the values in the table.  
 Table shows an extract of values.

## 7.6 ANTENNA EMCO 3160-10 (26.5 GHZ – 40 GHZ)

Frequency GHz	AF EMCO 3160-10 dB (1/m)	Corr. dB	cable loss 1 (inside chamber) dB	cable loss 2 (outside chamber) dB	cable loss 3 (switch unit) dB	cable loss 4 (to receiver) dB	distance corr. (-20 dB/ decade) dB	d <sub>Limit</sub> (meas. distance (limit) m	d <sub>used</sub> (meas. distance (used) m
26.5	43.4	-11.2	4.4				-9.5	3	1.0
27.0	43.4	-11.2	4.4				-9.5	3	1.0
28.0	43.4	-11.1	4.5				-9.5	3	1.0
29.0	43.5	-11.0	4.6				-9.5	3	1.0
30.0	43.5	-10.9	4.7				-9.5	3	1.0
31.0	43.5	-10.8	4.7				-9.5	3	1.0
32.0	43.5	-10.7	4.8				-9.5	3	1.0
33.0	43.6	-10.7	4.9				-9.5	3	1.0
34.0	43.6	-10.6	5.0				-9.5	3	1.0
35.0	43.6	-10.5	5.1				-9.5	3	1.0
36.0	43.6	-10.4	5.1				-9.5	3	1.0
37.0	43.7	-10.3	5.2				-9.5	3	1.0
38.0	43.7	-10.2	5.3				-9.5	3	1.0
39.0	43.7	-10.2	5.4				-9.5	3	1.0
40.0	43.8	-10.1	5.5				-9.5	3	1.0

### Sample calculation

$$E \text{ (dB } \mu\text{V/m)} = U \text{ (dB } \mu\text{V)} + \text{AF (dB 1/m)} + \text{Corr. (dB)}$$

U = Receiver reading

AF = Antenna factor

Corr. = sum of single correction factors of used cables, switch unit, distance correction, amplifier (if applicable)

Linear interpolation will be used for frequencies in between the values in the table.

$$\text{distance correction} = -20 * \text{LOG} (d_{\text{Limit}} / d_{\text{used}})$$

Linear interpolation will be used for frequencies in between the values in the table.

Table shows an extract of values.

## 8 MEASUREMENT UNCERTAINTIES

Test Case	Parameter	Uncertainty
AC Power Line	Power	$\pm 3.4$ dB
Field Strength of spurious radiation	Power	$\pm 5.5$ dB
6 dB / 26 dB / 99% Bandwidth	Power Frequency	$\pm 2.9$ dB $\pm 11.2$ kHz
Conducted Output Power	Power	$\pm 2.2$ dB
Band Edge Compliance	Power Frequency	$\pm 2.2$ dB $\pm 11.2$ kHz
Frequency Stability	Frequency	$\pm 25$ Hz
Power Spectral Density	Power	$\pm 2.2$ dB

The measurement uncertainties for all parameters are calculated with an expansion factor (coverage factor)  $k = 1.96$ . This means, that the true value is in the corresponding interval with a probability of 95 %.

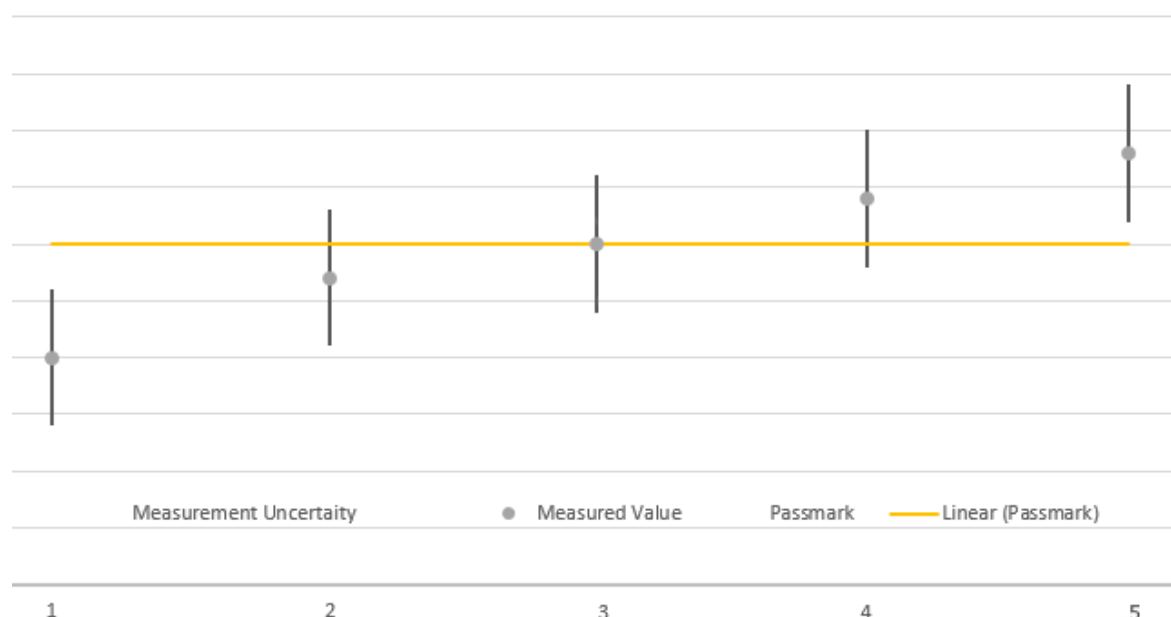

The verdicts in this test report are given according the above diagram:

Case	Measured Value	Uncertainty Range	Verdict
1	below pass mark	below pass mark	Passed
2	below pass mark	within pass mark	Passed
3	on pass mark	within pass mark	Passed
4	above pass mark	within pass mark	Failed
5	above pass mark	above pass mark	Failed

That means, the laboratory applies, as decision rule (see ISO/IEC 17025:2017), the so-called shared risk principle.

## 9 PHOTO REPORT

Please see separate photo report.

\*\*\*\*\*END OF TEST REPORT\*\*\*\*\*