

FCC Measurement/Technical Report on

WLAN and Bluetooth Module

PMN: JODY-W167-03A

HVIN: JODY-W167-03A

FCC ID: XPYJODYW167

IC: 8595A-JODYW167

Test Report Reference: MDE_UBLOX_2104_FCC_05

Test Laboratory:

7layers GmbH
Borsigstrasse 11
40880 Ratingen
Germany



Deutsche
Akkreditierungsstelle
D-PL-12140-01-01
D-PL-12140-01-02
D-PL-12140-01-03

Note:

The following test results relate only to the devices specified in this document. This report shall not be reproduced in parts without the written approval of the test laboratory.

7layers GmbH

Borsigstraße 11
40880 Ratingen, Germany
T +49 (0) 2102 749 0
F +49 (0) 2102 749 350

Geschäftsführer/
Managing Directors:
Frank Spiller
Bernhard Retka
Alexandre Norré-Oudard

Registergericht/registered:
Düsseldorf HRB 75554
USt-Id.-Nr./VAT-No. DE203159652
Steuer-Nr./TAX-No. 147/5869/0385

a Bureau Veritas
Group Company

www.7layers.com

Table of Contents

1	Applied Standards and Test Summary	3
1.1	Applied Standards	3
1.2	FCC-IC Correlation Table	4
1.3	Measurement Summary	5
2	Revision History / Signatures	10
3	Administrative Data	11
3.1	Testing Laboratory	11
3.2	Project Data	11
3.3	Applicant Data	11
3.4	Manufacturer Data	12
4	Test object Data	13
4.1	General EUT Description	13
4.2	EUT Main components	14
4.3	Ancillary Equipment	14
4.4	Auxiliary Equipment	14
4.5	EUT Setups	15
4.6	Operating Modes / Test Channels	15
4.7	Product labelling	16
5	Test Results	17
5.1	26 dB Bandwidth	17
5.2	6 dB Bandwidth	21
5.3	99 % Bandwidth	25
5.4	Band Edge	29
5.5	Undesirable Emissions; General Field Strength Limits	63
6	Test Equipment	72
7	Antenna Factors, Cable Loss and Sample Calculations	74
7.1	LISN R&S ESH3-Z5 (150 kHz – 30 MHz)	74
7.2	Antenna R&S HFH2-Z2 (9 kHz – 30 MHz)	75
7.3	Antenna R&S HL562 (30 MHz – 1 GHz)	76
7.4	Antenna R&S HF907 (1 GHz – 18 GHz)	77
7.5	Antenna EMCO 3160-09 (18 GHz – 26.5 GHz)	78
7.6	Antenna EMCO 3160-10 (26.5 GHz – 40 GHz)	79
8	Measurement Uncertainties	80
9	Photo Report	81

1 APPLIED STANDARDS AND TEST SUMMARY

1.1 APPLIED STANDARDS

Type of Authorization

Certification for an Intentional Radiator (Digital Device / Spread Spectrum).

Applicable FCC Rules

Prepared in accordance with the requirements of FCC Rules and Regulations as listed in 47 CFR Ch.1 Parts 2 (10-1-19 Edition) and 15 (10-1-19 Edition). The following subparts are applicable to the results in this test report.

Part 2, Subpart J - Equipment Authorization Procedures, Certification

Part 15, Subpart C – Intentional Radiators

§ 15.201 Equipment authorization requirement

§ 15.207 Conducted limits

§ 15.209 Radiated emission limits; general requirements

Part 15, Subpart E – Unlicensed National Information Infrastructure Devices

§ 15.403 Definitions

§ 15.407 General technical requirements

Note:

The tests were selected and performed with reference to the FCC Public Notice “Guidelines for Compliance Testing of Unlicensed National Information Infrastructure (U-NII) Devices - Part 15, Subpart E, 789033 D02 General U-NII Test Procedures New Rules v02r01, 2017-12-14”.

ANSI C63.10-2013 is applied.

1.2 FCC-IC CORRELATION TABLE

Correlation of measurement requirements for UNII / LE-LAN (e.g. WLAN 5 GHz) equipment from FCC and IC

UNII equipment

Measurement	FCC reference	IC reference
Conducted emissions on AC Mains	§ 15.207	RSS-Gen Issue 5: 8.8
Occupied bandwidth	§ 15.403 (i) (26 dB) / § 15.407 (e) (6 dB)	RSS-247 Issue 2: 6.2.1.1, 6.2.2.1, 6.2.3.1 (99%) RSS-247 Issue 2: 6.2.4.1 (6 dB)
Maximum conducted output power	§ 15.407 (a) (1),(2),(3),(4)	RSS-247 Issue 2: 6.2.1.1, 6.2.2.1, 6.2.3.1, 6.2.4.1
Maximum power spectral density	§ 15.407 (a) (1),(2),(3),(5)	RSS-247 Issue 2: 6.2.1.1, 6.2.2.1, 6.2.3.1, 6.2.4.1
Transmitter undesirable emissions; General Field Strength Limits, Restricted Bands	§ 15.407 (b) § 15.209 (a)	RSS-Gen Issue 5: 6.13/8.9/8.10; RSS-247 Issue 2: 3.3/6.2 6.2.1.2, 6.2.2.2, 6.2.3.2, 6.2.4.2
Frequency stability	§ 15.407 (g)	RSS-Gen Issue 5: 6.11/8.11
Transmit Power Control (TPC) and Dynamic Frequency Selection (DFS)	§ 15.407 (h)	RSS-247 Issue 2: 6.2.2.1, 6.2.3.1, 6.3
Antenna requirement	§ 15.203 / 15.204	RSS-Gen Issue 5: 8.3
Receiver spurious emissions	-	-

1.3 MEASUREMENT SUMMARY

47 CFR CHAPTER I FCC PART 15 Subpart E §15.407

FCC §15.31, §15.403 (i)

26 dB Bandwidth

The measurement was performed according to ANSI C63.10

Final Result

OP-Mode Radio Technology, Operating Frequency, Subband	Setup	Date	FCC	IC
WLAN a, high, U-NII-1	S01_AE01	2021-05-18	Performed	N/A
WLAN a, high, U-NII-2A	S01_AE01	2021-05-18	Performed	N/A
WLAN a, high, U-NII-2C	S01_AE01	2021-05-18	Performed	N/A
WLAN a, high, U-NII-3	S01_AE01	2021-05-18	Performed	N/A
WLAN a, low, U-NII-1	S01_AE01	2021-05-18	Performed	N/A
WLAN a, low, U-NII-2A	S01_AE01	2021-05-18	Performed	N/A
WLAN a, low, U-NII-2C	S01_AE01	2021-05-18	Performed	N/A
WLAN a, low, U-NII-3	S01_AE01	2021-05-18	Performed	N/A
WLAN ac 20 MHz, high, U-NII-1	S01_AE01	2021-05-18	Performed	N/A
WLAN ac 20 MHz, high, U-NII-2A	S01_AE01	2021-05-18	Performed	N/A
WLAN ac 20 MHz, high, U-NII-2C	S01_AE01	2021-05-18	Performed	N/A
WLAN ac 20 MHz, high, U-NII-3	S01_AE01	2021-05-18	Performed	N/A
WLAN ac 20 MHz, low, U-NII-1	S01_AE01	2021-05-18	Performed	N/A
WLAN ac 20 MHz, low, U-NII-2A	S01_AE01	2021-05-18	Performed	N/A
WLAN ac 20 MHz, low, U-NII-2C	S01_AE01	2021-05-18	Performed	N/A
WLAN ac 20 MHz, low, U-NII-3	S01_AE01	2021-05-18	Performed	N/A
WLAN ac 40 MHz, high, U-NII-1	S01_AE01	2021-05-18	Performed	N/A
WLAN ac 40 MHz, high, U-NII-2A	S01_AE01	2021-05-18	Performed	N/A
WLAN ac 40 MHz, high, U-NII-2C	S01_AE01	2021-05-18	Performed	N/A
WLAN ac 40 MHz, high, U-NII-3	S01_AE01	2021-05-18	Performed	N/A
WLAN ac 40 MHz, low, U-NII-1	S01_AE01	2021-05-18	Performed	N/A
WLAN ac 40 MHz, low, U-NII-2A	S01_AE01	2021-05-18	Performed	N/A
WLAN ac 40 MHz, low, U-NII-2C	S01_AE01	2021-05-18	Performed	N/A
WLAN ac 40 MHz, low, U-NII-3	S01_AE01	2021-05-18	Performed	N/A
WLAN ac 80 MHz, high, U-NII-2C	S01_AE01	2021-05-18	Performed	N/A
WLAN ac 80 MHz, low, U-NII-2C	S01_AE01	2021-05-18	Performed	N/A
WLAN ac 80 MHz, mid, U-NII-1	S01_AE01	2021-05-18	Performed	N/A
WLAN ac 80 MHz, mid, U-NII-2A	S01_AE01	2021-05-18	Performed	N/A
WLAN ac 80 MHz, mid, U-NII-3	S01_AE01	2021-05-18	Performed	N/A
WLAN n 20 MHz, high, U-NII-1	S01_AE01	2021-05-18	Performed	N/A
WLAN n 20 MHz, high, U-NII-2A	S01_AE01	2021-05-18	Performed	N/A
WLAN n 20 MHz, high, U-NII-2C	S01_AE01	2021-05-18	Performed	N/A
WLAN n 20 MHz, high, U-NII-3	S01_AE01	2021-05-18	Performed	N/A
WLAN n 20 MHz, low, U-NII-1	S01_AE01	2021-05-18	Performed	N/A
WLAN n 20 MHz, low, U-NII-2A	S01_AE01	2021-05-18	Performed	N/A
WLAN n 20 MHz, low, U-NII-2C	S01_AE01	2021-05-18	Performed	N/A
WLAN n 20 MHz, low, U-NII-3	S01_AE01	2021-05-18	Performed	N/A
WLAN n 40 MHz, high, U-NII-1	S01_AE01	2021-05-18	Performed	N/A

**47 CFR CHAPTER I FCC PART 15
Subpart E §15.407**

FCC §15.31, §15.403 (i)

26 dB Bandwidth

The measurement was performed according to ANSI C63.10

Final Result

OP-Mode Radio Technology, Operating Frequency, Subband	Setup	Date	FCC	IC
WLAN n 40 MHz, high, U-NII-2A	S01_AE01	2021-05-18	Performed	N/A
WLAN n 40 MHz, high, U-NII-2C	S01_AE01	2021-05-18	Performed	N/A
WLAN n 40 MHz, high, U-NII-3	S01_AE01	2021-05-18	Performed	N/A
WLAN n 40 MHz, low, U-NII-1	S01_AE01	2021-05-18	Performed	N/A
WLAN n 40 MHz, low, U-NII-2A	S01_AE01	2021-05-18	Performed	N/A
WLAN n 40 MHz, low, U-NII-2C	S01_AE01	2021-05-18	Performed	N/A
WLAN n 40 MHz, low, U-NII-3	S01_AE01	2021-05-18	Performed	N/A

**47 CFR CHAPTER I FCC PART 15
Subpart E §15.407**

FCC §15.31, §15.407 (e)

6 dB Bandwidth

The measurement was performed according to ANSI C63.10

Final Result

OP-Mode Radio Technology, Operating Frequency, Subband	Setup	Date	FCC	IC
WLAN a, high, U-NII-3	S01_AE01	2021-05-18	Passed	Passed
WLAN a, low, U-NII-3	S01_AE01	2021-05-18	Passed	Passed
WLAN ac 20 MHz, high, U-NII-3	S01_AE01	2021-05-18	Passed	Passed
WLAN ac 20 MHz, low, U-NII-3	S01_AE01	2021-05-18	Passed	Passed
WLAN ac 40 MHz, high, U-NII-3	S01_AE01	2021-05-18	Passed	Passed
WLAN ac 40 MHz, low, U-NII-3	S01_AE01	2021-05-18	Passed	Passed
WLAN ac 80 MHz, mid, U-NII-3	S01_AE01	2021-05-18	Passed	Passed
WLAN n 20 MHz, high, U-NII-3	S01_AE01	2021-05-18	Passed	Passed
WLAN n 20 MHz, low, U-NII-3	S01_AE01	2021-05-18	Passed	Passed
WLAN n 40 MHz, high, U-NII-3	S01_AE01	2021-05-18	Passed	Passed
WLAN n 40 MHz, low, U-NII-3	S01_AE01	2021-05-18	Passed	Passed

**47 CFR CHAPTER I FCC PART 15
Subpart E §15.407**

FCC §15.31, IC RSS 247 Ch. 6.2.x

99 % Bandwidth

The measurement was performed according to ANSI C63.10

Final Result

OP-Mode Radio Technology, Operating Frequency, Subband	Setup	Date	FCC	IC
WLAN a, high, U-NII-1	S01_AE01	2021-05-18	N/A	Performed
WLAN a, high, U-NII-2A	S01_AE01	2021-05-18	N/A	Performed
WLAN a, high, U-NII-2C	S01_AE01	2021-05-18	N/A	Performed
WLAN a, high, U-NII-3	S01_AE01	2021-05-18	N/A	Performed
WLAN a, low, U-NII-1	S01_AE01	2021-05-18	N/A	Performed
WLAN a, low, U-NII-2A	S01_AE01	2021-05-18	N/A	Performed
WLAN a, low, U-NII-2C	S01_AE01	2021-05-18	N/A	Performed
WLAN a, low, U-NII-3	S01_AE01	2021-05-18	N/A	Performed
WLAN ac 20 MHz, high, U-NII-1	S01_AE01	2021-05-18	N/A	Performed
WLAN ac 20 MHz, high, U-NII-2A	S01_AE01	2021-05-18	N/A	Performed
WLAN ac 20 MHz, high, U-NII-2C	S01_AE01	2021-05-18	N/A	Performed
WLAN ac 20 MHz, high, U-NII-3	S01_AE01	2021-05-18	N/A	Performed
WLAN ac 20 MHz, low, U-NII-1	S01_AE01	2021-05-18	N/A	Performed
WLAN ac 20 MHz, low, U-NII-2A	S01_AE01	2021-05-18	N/A	Performed
WLAN ac 20 MHz, low, U-NII-2C	S01_AE01	2021-05-18	N/A	Performed
WLAN ac 20 MHz, low, U-NII-3	S01_AE01	2021-05-18	N/A	Performed
WLAN ac 40 MHz, high, U-NII-1	S01_AE01	2021-05-18	N/A	Performed
WLAN ac 40 MHz, high, U-NII-2A	S01_AE01	2021-05-18	N/A	Performed
WLAN ac 40 MHz, high, U-NII-2C	S01_AE01	2021-05-18	N/A	Performed
WLAN ac 40 MHz, high, U-NII-3	S01_AE01	2021-05-18	N/A	Performed
WLAN ac 40 MHz, low, U-NII-1	S01_AE01	2021-05-18	N/A	Performed
WLAN ac 40 MHz, low, U-NII-2A	S01_AE01	2021-05-18	N/A	Performed
WLAN ac 40 MHz, low, U-NII-2C	S01_AE01	2021-05-18	N/A	Performed
WLAN ac 40 MHz, low, U-NII-3	S01_AE01	2021-05-18	N/A	Performed
WLAN ac 80 MHz, high, U-NII-2C	S01_AE01	2021-05-18	N/A	Performed
WLAN ac 80 MHz, low, U-NII-2C	S01_AE01	2021-05-18	N/A	Performed
WLAN ac 80 MHz, mid, U-NII-1	S01_AE01	2021-05-18	N/A	Performed
WLAN ac 80 MHz, mid, U-NII-2A	S01_AE01	2021-05-18	N/A	Performed
WLAN ac 80 MHz, mid, U-NII-3	S01_AE01	2021-05-18	N/A	Performed
WLAN n 20 MHz, high, U-NII-1	S01_AE01	2021-05-18	N/A	Performed
WLAN n 20 MHz, high, U-NII-2A	S01_AE01	2021-05-18	N/A	Performed
WLAN n 20 MHz, high, U-NII-2C	S01_AE01	2021-05-18	N/A	Performed
WLAN n 20 MHz, high, U-NII-3	S01_AE01	2021-05-18	N/A	Performed
WLAN n 20 MHz, low, U-NII-1	S01_AE01	2021-05-18	N/A	Performed
WLAN n 20 MHz, low, U-NII-2A	S01_AE01	2021-05-18	N/A	Performed
WLAN n 20 MHz, low, U-NII-2C	S01_AE01	2021-05-18	N/A	Performed
WLAN n 20 MHz, low, U-NII-3	S01_AE01	2021-05-18	N/A	Performed
WLAN n 40 MHz, high, U-NII-1	S01_AE01	2021-05-18	N/A	Performed
WLAN n 40 MHz, high, U-NII-2A	S01_AE01	2021-05-18	N/A	Performed
WLAN n 40 MHz, high, U-NII-2C	S01_AE01	2021-05-18	N/A	Performed
WLAN n 40 MHz, high, U-NII-3	S01_AE01	2021-05-18	N/A	Performed

**47 CFR CHAPTER I FCC PART 15
Subpart E §15.407**

FCC §15.31, IC RSS 247 Ch. 6.2.x

99 % Bandwidth

The measurement was performed according to ANSI C63.10

Final Result

OP-Mode Radio Technology, Operating Frequency, Subband	Setup	Date	FCC	IC
WLAN n 40 MHz, low, U-NII-1	S01_AE01	2021-05-18	N/A	Performed
WLAN n 40 MHz, low, U-NII-2A	S01_AE01	2021-05-18	N/A	Performed
WLAN n 40 MHz, low, U-NII-2C	S01_AE01	2021-05-18	N/A	Performed
WLAN n 40 MHz, low, U-NII-3	S01_AE01	2021-05-18	N/A	Performed

**47 CFR CHAPTER I FCC PART 15
Subpart E §15.407**

FCC §15.407 (b), (1),(2),(3),(4)

Band Edge

The measurement was performed according to ANSI C63.10

Final Result

OP-Mode Radio Technology, Operating Frequency, Subband	Setup	Date	FCC	IC
WLAN a, high, U-NII-2A	S01_AE01	2021-05-26	Passed	Passed
WLAN a, high, U-NII-2C	S01_AF01	2021-05-29	Passed	Passed
WLAN a, high, U-NII-3	S01_AF01	2021-05-29	Passed	Passed
WLAN a, low, U-NII-1	S01_AE01	2021-05-26	Passed	Passed
WLAN a, low, U-NII-2C	S01_AF01	2021-05-29	Passed	Passed
WLAN a, low, U-NII-3	S01_AF01	2021-05-29	Passed	Passed
WLAN ac 20 MHz MIMO, high, U-NII-2A	S01_AE01	2021-05-26	Passed	Passed
WLAN ac 20 MHz MIMO, high, U-NII-2C	S01_AF01	2021-05-29	Passed	Passed
WLAN ac 20 MHz MIMO, high, U-NII-3	S01_AF01	2021-05-29	Passed	Passed
WLAN ac 20 MHz MIMO, low, U-NII-1	S01_AE01	2021-05-26	Passed	Passed
WLAN ac 20 MHz MIMO, low, U-NII-2C	S01_AF01	2021-05-29	Passed	Passed
WLAN ac 20 MHz MIMO, low, U-NII-3	S01_AF01	2021-05-29	Passed	Passed
WLAN ac 40 MHz MIMO, high, U-NII-2A	S01_AE01	2021-05-26	Passed	Passed
WLAN ac 40 MHz MIMO, high, U-NII-2C	S01_AF01	2021-05-29	Passed	Passed
WLAN ac 40 MHz MIMO, high, U-NII-3	S01_AF01	2021-05-29	Passed	Passed
WLAN ac 40 MHz MIMO, low, U-NII-1	S01_AE01	2021-05-26	Passed	Passed
WLAN ac 40 MHz MIMO, low, U-NII-2C	S01_AF01	2021-05-29	Passed	Passed
WLAN ac 40 MHz MIMO, low, U-NII-3	S01_AF01	2021-05-29	Passed	Passed
WLAN ac 80 MHz MIMO, high, U-NII-2C	S01_AF01	2021-05-29	Passed	Passed
WLAN ac 80 MHz MIMO, low, U-NII-2C	S01_AF01	2021-05-29	Passed	Passed
WLAN ac 80 MHz MIMO, mid, U-NII-1	S01_AE01	2021-05-26	Passed	Passed
WLAN ac 80 MHz MIMO, mid, U-NII-2A	S01_AE01	2021-05-26	Passed	Passed
WLAN ac 80 MHz MIMO, mid, U-NII-3	S01_AF01	2021-05-29	Passed	Passed
WLAN n 20 MHz MIMO, high, U-NII-2A	S01_AE01	2021-05-26	Passed	Passed
WLAN n 20 MHz MIMO, high, U-NII-2C	S01_AF01	2021-05-29	Passed	Passed
WLAN n 20 MHz MIMO, high, U-NII-3	S01_AF01	2021-05-29	Passed	Passed
WLAN n 20 MHz MIMO, low, U-NII-1	S01_AE01	2021-05-26	Passed	Passed
WLAN n 20 MHz MIMO, low, U-NII-2C	S01_AF01	2021-05-29	Passed	Passed
WLAN n 20 MHz MIMO, low, U-NII-3	S01_AF01	2021-05-29	Passed	Passed

**47 CFR CHAPTER I FCC PART 15
Subpart E §15.407**

FCC §15.407 (b), (1),(2),(3),(4)

Band Edge

The measurement was performed according to ANSI C63.10

Final Result

OP-Mode Radio Technology, Operating Frequency, Subband	Setup	Date	FCC	IC
WLAN n 40 MHz MIMO, high, U-NII-2A	S01_AE01	2021-05-26	Passed	Passed
WLAN n 40 MHz MIMO, high, U-NII-2C	S01_AF01	2021-05-29	Passed	Passed
WLAN n 40 MHz MIMO, high, U-NII-3	S01_AF01	2021-05-29	Passed	Passed
WLAN n 40 MHz MIMO, low, U-NII-1	S01_AE01	2021-05-26	Passed	Passed
WLAN n 40 MHz MIMO, low, U-NII-2C	S01_AF01	2021-05-29	Passed	Passed
WLAN n 40 MHz MIMO, low, U-NII-3	S01_AF01	2021-05-29	Passed	Passed

**47 CFR CHAPTER I FCC PART 15
Subpart E §15.407**

**FCC §15.407 (b), (1),(2),(3),(4); FCC
§15.205, §15.209, §15.407 (b) (5),(6)**

Undesirable Emissions; General Field Strength Limits

The measurement was performed according to ANSI C63.10

Final Result

OP-Mode Radio Technology, Operating Frequency, Measurement range, Subband	Setup	Date	FCC	IC
WLAN a, mid, 1GHz - 26GHz, U-NII-2C	S02_AF01	2021-06-08	Passed	Passed

N/A: Not applicable
N/P: Not performed

2 REVISION HISTORY / SIGNATURES

Report version control			
Version	Release date	Change Description	Version validity
initial	2021-06-24	--	valid
--	--	--	--

COMMENT: This is a delta test report due to hardware change. Not all tests were performed.
See test report MDE_UBLOX_1828_FCCg for results of the other test cases.



(responsible for accreditation scope)
Dipl.-Ing. Marco Kullik



(responsible for testing and report)
Dipl.-Ing. Daniel Gall



7 layers GmbH, Borsigstr. 11
40880 Ratingen, Germany
Phone +49 (0)2102 749 0

3 ADMINISTRATIVE DATA

3.1 TESTING LABORATORY

Company Name: 7layers GmbH
Address: Borsigstr. 11
40880 Ratingen
Germany

The test facility is accredited by the following accreditation organisation:

Laboratory accreditation no: DAKKS D-PL-12140-01-01 | -02 | -03
FCC Designation Number: DE0015
FCC Test Firm Registration: 929146
ISED CAB Identifier: DE0007; ISED#: 3699A
Responsible for accreditation scope: Dipl.-Ing. Marco Kullik
Report Template Version: 2021-01-13

3.2 PROJECT DATA

Responsible for testing and report: Dipl.-Ing. Daniel Gall
Employees who performed the tests: documented internally at 7Layers
Date of Report: 2021-06-24
Testing Period: 2021-05-18 to 2021-06-08

3.3 APPLICANT DATA

Company Name: u-blox AG
Address: Zürcherstrasse 68
8800 Thalwil
Switzerland
Contact Person: Filip Kruzela

3.4 MANUFACTURER DATA

Company Name: please see Applicant Data

Address:

Contact Person:

4 TEST OBJECT DATA

4.1 GENERAL EUT DESCRIPTION

Kind of Device product description	The EUT is a module supporting WLAN in the 2.4 GHz and 5 GHz bands as well as Bluetooth (BT) 4.2 including Bluetooth Low Energy (BT LE)
Product name	WLAN and Bluetooth module
Type	JODY-W167-03A
Declared EUT data by the supplier	
Voltage Type	DC
Voltage Level	3.3 V
Tested Modulation Type	OFDM: WLAN a: 6 Mbps WLAN n/ac: MCS0 (20/40/80 MHz)
Specific product description	<p>The JODY-W1 is a compact automotive grade module that provides Wi-Fi, Bluetooth, and Bluetooth low energy communication. The JODY-W167-03A module can be operated in the following modes:</p> <p>Wi-Fi 2x2 MIMO 802.11n in the 2.4 GHz and 5 GHz bands.</p> <p>Wi-Fi 2x2 MIMO 802.11ac in the 5GHz band.</p> <p>Wi-Fi 802.11n/ac real simultaneous dual band on two antennas.</p> <p>Dual-mode Bluetoothv4.2, can be operated fully simultaneous with both the Wi-Fi modes.</p> <p>It is equipped with three antenna pins connected two three SMA connectors on the evaluation board.</p> <p>Maximum supported band width in 2.4 GHz Wi-Fi mode: 20 MHz, 5GHz Wi-Fi mode: 80 MHz</p>
Ports of the device	DC Power Supply Antenna ports Signal ports
Antenna 1	None provided, 2 dBi antenna gain assumed for conducted measurements
Antenna 2	None provided, 2 dBi antenna gain assumed for conducted measurements
Special software used for testing	The test modes were set using scripts that were run on a board computer with Linux operating system provided by the applicant.

4.2 EUT MAIN COMPONENTS

Sample Name	Sample Code	Description
EUT ae01	DE1015139ae01	
Sample Parameter	Value	
Serial No.	L166009C3FB5B740900	
HW Version	11	
SW Version	PCIe CLUTCH 9.40.117.x, NVRAM jody-w167 (08-12-2020)	
Comment		

Sample Name	Sample Code	Description
EUT af01	DE1015139af01	
Sample Parameter	Value	
Serial No.	L166009C3FB5B8C0900	
HW Version	11	
SW Version	PCIe CLUTCH 9.40.117.x, NVRAM jody-w167 (08-12-2020)	
Comment		

NOTE: The short description is used to simplify the identification of the EUT in this test report.

4.3 ANCILLARY EQUIPMENT

For the purposes of this test report, ancillary equipment is defined as equipment which is used in conjunction with the EUT to provide operational and control features to the EUT. It is necessary to configure the system in a typical fashion, as a customer would normally use it. But nevertheless Ancillary Equipment can influence the test results.

Device	Details (Manufacturer, Type Model, OUT Code)	Description
Evaluation Board	UBLOX, JODY-W1 EVB Certification board, REV. A, - , -	Board the EUT is mounted to, providing ports to the EUT (DC, Antennas, wired communication)

4.4 AUXILIARY EQUIPMENT

For the purposes of this test report, auxiliary equipment is defined as equipment which is used temporarily to enable operational and control features especially used for the tests of the EUT which is not used during normal operation or equipment that is used during the tests in combination with the EUT but is not subject of this test report. It is necessary to configure the system in a typical fashion, as a customer would normally use it. But nevertheless Auxiliary Equipment can influence the test results.

Device	Details (Manufacturer, Type Model, HW, SW, S/N)	Description
Board Computer	Toradex, Ixora, -, - , -	Computer used for setting test modes and supplying EUT

4.5 EUT SETUPS

This chapter describes the combination of EUTs and equipment used for testing. The rationale for selecting the EUTs, ancillary and auxiliary equipment and interconnecting cables, is to test a representative configuration meeting the requirements of the referenced standards.

Setup	Combination of EUTs	Description and Rationale
S01_AE01	EUT ae01, Evaluation Board, Board Computer	Conducted measurement setup
S01_AF01	EUT af01, Evaluation Board, Board Computer	Conducted measurement setup
S01_AF01	EUT af01, Evaluation Board,	Radiated measurement setup

4.6 OPERATING MODES / TEST CHANNELS

This chapter describes the operating modes of the EUTs used for testing.

U-NII-Subband 1 5150 - 5250 MHz			U-NII-Subband 2A 5250 - 5350 MHz			U-NII-Subband 2C 5470 - 5725 MHz			U-NII-Subband 3 5725 - 5850 MHz			Nom. BW
low	mid	high	low	mid	high	low	mid	high	low	mid	high	20 MHz
36 / 40 ¹⁾		48	52		60 ¹⁾ /64	100/104 ¹⁾		136 ¹⁾ /140	149		165	Ch.-No.
5180/5200		5240	5260		5300/5320	5500/5520		5680/5700	5745		5825	MHz

low	mid	high	low	mid	high	low	mid	high	low	mid	high	40 MHz
38	-	46 ¹⁾	54 ¹⁾	-	62	102	110 ¹⁾	130 ¹⁾ /138	151	-	159	Ch.-No.
5190	-	5230	5270	-	5310	5510	5550	5650/5690	5755	-	5795	MHz
low	mid	high	low	mid	high	low	mid	high	low	mid	high	80 MHz
42	-		58	-		106		122	155	-	159	Ch.-No.
5210	-		5290	-		5530		5610	5775	-	5795	MHz

- 1) Since the lowest and second lowest as well as highest and second highest channel have different output power, the second lowest / highest channel were also measured for Band Edge.

Power Setting in EUT Script according to applicant:

20 MHz Channel

Channel No.	36	40	44	48	52	56	60	64	100	104	108	112	116	120	124	128	132	136	140	144	149	153	157	161	165
Channel freq. [MHz]	5180	5200	5220	5240	5260	5280	5300	5320	5500	5520	5540	5560	5580	5600	5620	5640	5660	5680	5700	5720	5745	5765	5785	5805	5825
WLAN mode a	12	14	14	14	14	14	14	12	11	14	14	14	14	14	14	14	14	14	11	14	17	17	17	17	17
WLAN mode n	12	14	14	14	14	14	14	12	11	14	14	14	14	14	14	14	14	14	11	14	17	17	17	17	17
WLAN mode ac	12	14	14	14	14	14	14	12	11	14	14	14	14	14	14	14	14	14	11	14	17	17	17	17	17

40 MHz Channel

Channel No.	38	46	54	62	102	110	118	126	134	142	151	159
Channel freq. [MHz]	5190	5230	5270	5310	5510	5550	5590	5630	5670	5710	5755	5795
WLAN mode n	10	13	13	12	10	14	14	14	11	14	17	17
WLAN mode ac	10	13	13	12	10	14	14	14	11	14	17	17

80 MHz Channel

Channel No.	42	58	106	122	138	155
Channel freq. [MHz]	5210	5290	5530	5610	5690	5775
WLAN mode ac	10	10	9	9	12	15

4.7 PRODUCT LABELLING

4.7.1 FCC ID LABEL

Please refer to the documentation of the applicant.

4.7.2 LOCATION OF THE LABEL ON THE EUT

Please refer to the documentation of the applicant.

5 TEST RESULTS

5.1 26 DB BANDWIDTH

Standard **FCC Part 15 Subpart E**

The test was performed according to:
ANSI C63.10

5.1.1 TEST DESCRIPTION

The Equipment Under Test (EUT) was set up to perform the occupied bandwidth measurements.

The reference level is the level of the highest amplitude signal observed from the transmitter at either the fundamental frequency or first-order modulation products in all typical modes of operation, including the unmodulated carrier, even if atypical.

The results recorded were measured with the modulation which produce the worst-case (widest) emission bandwidth.

The EUT was connected to the test system as described in the block diagram below. The complete attenuation of the measurement path is known and considered.

Analyzer settings:

- Resolution Bandwidth (RBW): initially approx. 1 % of nominal emission bandwidth
- Video Bandwidth (VBW): > RBW
- Span: 40 / 80 / 160 / 320 MHz (for 20 / 40 / 80 / 160 MHz nominal bandwidth)
- Trace: Maxhold
- Sweeps: Until the trace is stable
- Sweptime: Auto
- Detector: Peak

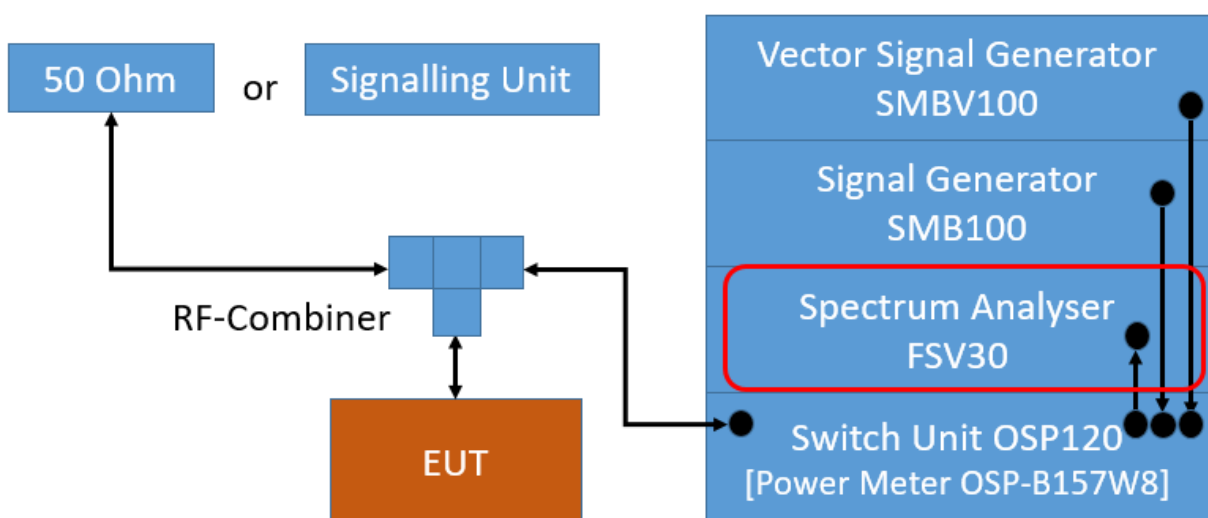

TS8997; Occupied Channel Bandwidth 6 dB / 26 dB / 99 %

5.1.2 TEST REQUIREMENTS / LIMITS

FCC Part 15, Subpart E, §15.403 (i)

There exist no applicable limits for the U-NII subbands 1, 2A and 2C. The test was performed to determine the limits for the "Maximum Conducted Output Power" test case. Therefore no result was applied.

5.1.3 TEST PROTOCOL

Ambient temperature: 24 °C
 Air Pressure: 1007 hPa
 Humidity: 39 %

Radio Technology	Operating Frequency	Subband	26 dB Bandwidth [MHz]
WLAN a	low	U-NII-1	21.3
WLAN a	high	U-NII-1	21.5
WLAN a	low	U-NII-2A	21.8
WLAN a	high	U-NII-2A	21.5
WLAN a	low	U-NII-2C	21.8
WLAN a	high	U-NII-2C	22.0
WLAN a	low	U-NII-3	27.1
WLAN a	high	U-NII-3	24.7
WLAN n 20 MHz	low	U-NII-1	21.7
WLAN n 20 MHz	high	U-NII-1	22.8
WLAN n 20 MHz	low	U-NII-2A	22.2
WLAN n 20 MHz	high	U-NII-2A	21.8
WLAN n 20 MHz	low	U-NII-2C	21.9
WLAN n 20 MHz	high	U-NII-2C	21.9
WLAN n 20 MHz	low	U-NII-3	33.7
WLAN n 20 MHz	high	U-NII-3	30.9
WLAN n 40 MHz	low	U-NII-1	40.1
WLAN n 40 MHz	high	U-NII-1	41.7
WLAN n 40 MHz	low	U-NII-2A	40.7
WLAN n 40 MHz	high	U-NII-2A	41.1
WLAN n 40 MHz	low	U-NII-2C	39.9
WLAN n 40 MHz	high	U-NII-2C	39.9
WLAN n 40 MHz	low	U-NII-3	66.6
WLAN n 40 MHz	high	U-NII-3	66.6
WLAN ac 20 MHz	low	U-NII-1	22.0
WLAN ac 20 MHz	high	U-NII-1	22.0
WLAN ac 20 MHz	low	U-NII-2A	24.5
WLAN ac 20 MHz	high	U-NII-2A	22.3
WLAN ac 20 MHz	low	U-NII-2C	21.9
WLAN ac 20 MHz	high	U-NII-2C	21.8
WLAN ac 20 MHz	low	U-NII-3	33.5
WLAN ac 20 MHz	high	U-NII-3	32.8
WLAN ac 40 MHz	low	U-NII-1	39.8
WLAN ac 40 MHz	high	U-NII-1	40.1
WLAN ac 40 MHz	low	U-NII-2A	39.8
WLAN ac 40 MHz	high	U-NII-2A	39.9
WLAN ac 40 MHz	low	U-NII-2C	40.1
WLAN ac 40 MHz	high	U-NII-2C	40.2
WLAN ac 40 MHz	low	U-NII-3	63.8
WLAN ac 40 MHz	high	U-NII-3	70.5
WLAN ac 80 MHz	mid	U-NII-1	82.5
WLAN ac 80 MHz	mid	U-NII-2A	83.0
WLAN ac 80 MHz	low	U-NII-2C	82.5
WLAN ac 80 MHz	high	U-NII-2C	83.0
WLAN ac 80 MHz	mid	U-NII-3	83.5

Remark: Please see next sub-clause for the measurement plot.

5.1.4 MEASUREMENT PLOT (EXAMPLE PLOT, SHOWING WORST CASE, IF APPLICABLE)

Radio Technology = WLAN n 40 MHz, Operating Frequency = high, Subband = U-NII-1 (S01_AE01)

26 dB Bandwidth

DUT Frequency (MHz)	Bandwidth (MHz)	Limit Min (MHz)	Limit Max (MHz)	Band Edge Left (MHz)	Band Edge Right (MHz)	Max Level (dBm)	Result
5230.000000	41.726079	---	---	5208.236398	5249.962477	-0.8	PASS

Setting	Instrument Value
Start Frequency	5.19000 GHz
Stop Frequency	5.27000 GHz
Span	80.000 MHz
RBW	300.000 kHz
VBW	1.000 MHz
SweepPoints	533
SweepTime	31.621 μ s
Reference Level	0.000 dBm
Attenuation	20.000 dB
Detector	MaxPeak
SweepCount	200
Filter	3 dB
Trace Mode	Max Hold
SweepType	FFT
Preamp	off
Stablemode	Trace
Stablevalue	0.30 dB
Run	107 / max. 150
Stable	5 / 5
Max Stable Difference	0.24 dB

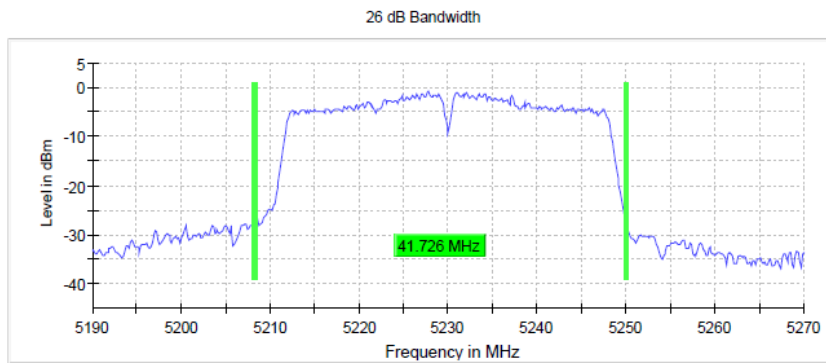

Radio Technology = WLAN ac 20 MHz, Operating Frequency = low, Subband = U-NII-2A (S01_AE01)

26 dB Bandwidth

DUT Frequency (MHz)	Bandwidth (MHz)	Limit Min (MHz)	Limit Max (MHz)	Band Edge Left (MHz)	Band Edge Right (MHz)	Max Level (dBm)	Result
5260.000000	24.500000	---	---	5246.450000	5270.950000	0.2	PASS

Setting	Instrument Value
Start Frequency	5.24000 GHz
Stop Frequency	5.28000 GHz
Span	40.000 MHz
RBW	200.000 kHz
VBW	1.000 MHz
SweepPoints	400
SweepTime	28.477 μ s
Reference Level	0.000 dBm
Attenuation	20.000 dB
Detector	MaxPeak
SweepCount	200
Filter	3 dB
Trace Mode	Max Hold
SweepType	FFT
Preamp	off
Stablemode	Trace
Stablevalue	0.30 dB
Run	70 / max. 150
Stable	5 / 5
Max Stable Difference	0.00 dB

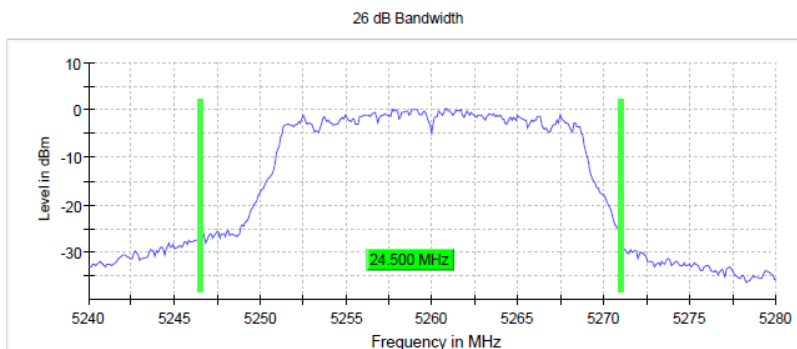

Radio Technology = WLAN ac 80 MHz, Operating Frequency = mid, Subband = U-NII-2A (S01_AE01)

26 dB Bandwidth

DUT Frequency (MHz)	Bandwidth (MHz)	Limit Min (MHz)	Limit Max (MHz)	Band Edge Left (MHz)	Band Edge Right (MHz)	Max Level (dBm)	Result
5290.000000	83.000000	---	---	5248.750000	5331.750000	-1.8	PASS

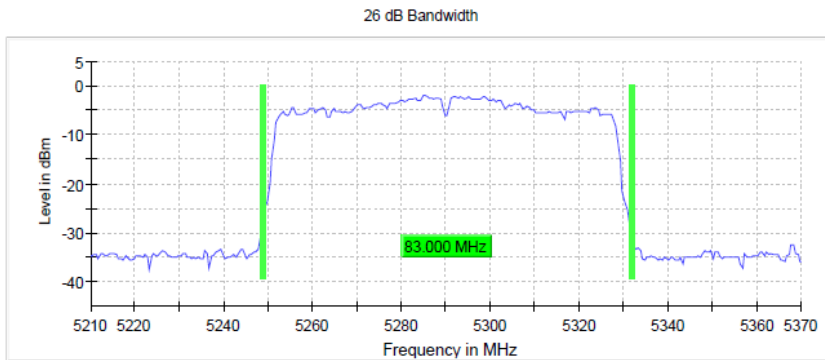

Setting	Instrument Value
Start Frequency	5.21000 GHz
Stop Frequency	5.37000 GHz
Span	160.000 MHz
RBW	1.000 MHz
VBW	3.000 MHz
SweepPoints	320
Sweeptime	22.875 μ s
Reference Level	0.000 dBm
Attenuation	20.000 dB
Detector	MaxPeak
SweepCount	200
Filter	3 dB
Trace Mode	Max Hold
Sweeptype	FFT
Preamp	off
Stablemode	Trace
Stablevalue	0.30 dB
Run	38 / max. 150
Stable	5 / 5
Max Stable Difference	0.00 dB

5.1.5 TEST EQUIPMENT USED

- R&S TS8997

5.2 6 DB BANDWIDTH

Standard **FCC Part 15 Subpart E**

The test was performed according to:
ANSI C63.10

5.2.1 TEST DESCRIPTION

The Equipment Under Test (EUT) was setup in a shielded room to perform the occupied bandwidth measurements.

The reference level is the level of the highest amplitude signal observed from the transmitter at either the fundamental frequency or first-order modulation products in all typical modes of operation, including the unmodulated carrier, even if atypical.

The results recorded were measured with the modulation which produce the worst-case (smallest) emission bandwidth.

The EUT was connected to the test system as described in the block diagram below. The complete attenuation of the measurement path is known and considered.

Analyzer settings:

- Resolution Bandwidth (RBW): 100 kHz
- Video Bandwidth (VBW): 300 kHz
- Span: 40 / 80 / 160 / 320 MHz (for 20 / 40 / 80 / 160 MHz nominal bandwidth))
- Trace: Maxhold
- Sweeps: Until the trace is stable
- Sweeptime: Auto
- Detector: Peak

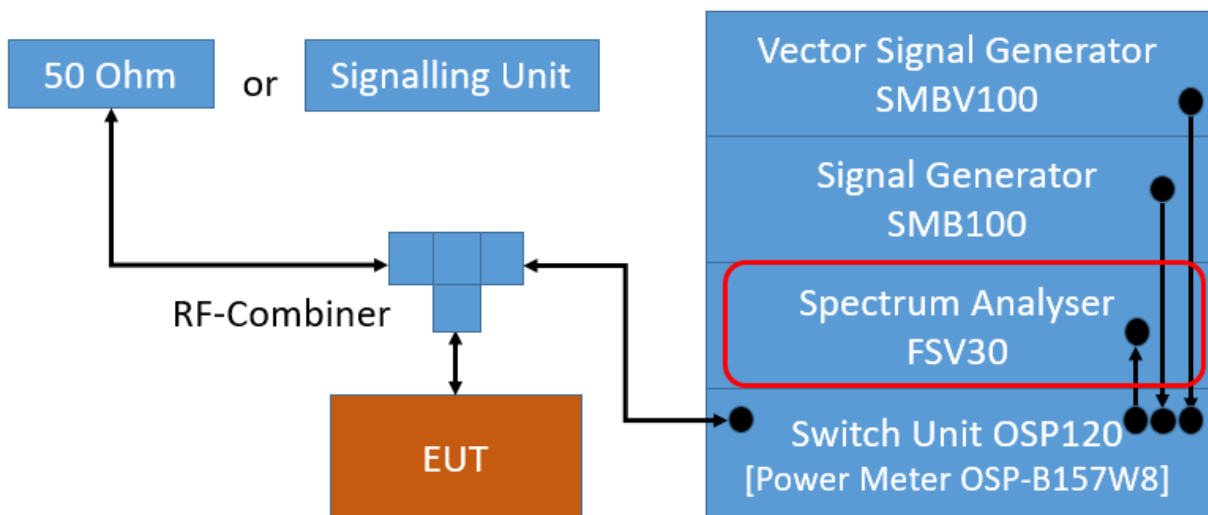

TS8997; Occupied Channel Bandwidth 6 dB / 26 dB / 99 %

5.2.2 TEST REQUIREMENTS / LIMITS

FCC Part 15, Subpart E, §15.407 (e)

Within the 5.725-5.850 GHz band, the minimum 6 dB bandwidth of U-NII devices shall be at least 500 kHz.

5.2.3 TEST PROTOCOL

Ambient temperature: 24 °C
 Air Pressure: 1007 hPa
 Humidity: 39 %

Radio Technology	Operating Frequency	6 dB Bandwidth [MHz]	Limit [MHz]	Margin [MHz]
WLAN a	low	16.40	0.5	15.90
WLAN a	high	16.40	0.5	15.90
WLAN n 20 MHz	low	17.65	0.5	17.15
WLAN n 20 MHz	high	17.65	0.5	17.15
WLAN n 40 MHz	low	35.85	0.5	35.35
WLAN n 40 MHz	high	35.75	0.5	35.25
WLAN ac 20 MHz	low	17.65	0.5	17.15
WLAN ac 20 MHz	high	17.65	0.5	17.15
WLAN ac 40 MHz	low	35.90	0.5	35.40
WLAN ac 40 MHz	high	35.90	0.5	35.40
WLAN ac 80 MHz	mid	75.40	0.5	74.90

Remark: Please see next sub-clause for the measurement plot.

5.2.4 MEASUREMENT PLOT (EXAMPLE PLOT, SHOWING WORST CASE, IF APPLICABLE)

Radio Technology = WLAN a, Operating Frequency = high, Subband = U-NII-3 (S01_AE01)

6 dB Bandwidth

DUT Frequency (MHz)	Bandwidth (MHz)	Limit Min (MHz)	Limit Max (MHz)	Band Edge Left (MHz)	Band Edge Right (MHz)	Max Level (dBm)	Result
5825.000000	16.400000	0.500000	---	5816.775000	5833.175000	1.5	PASS

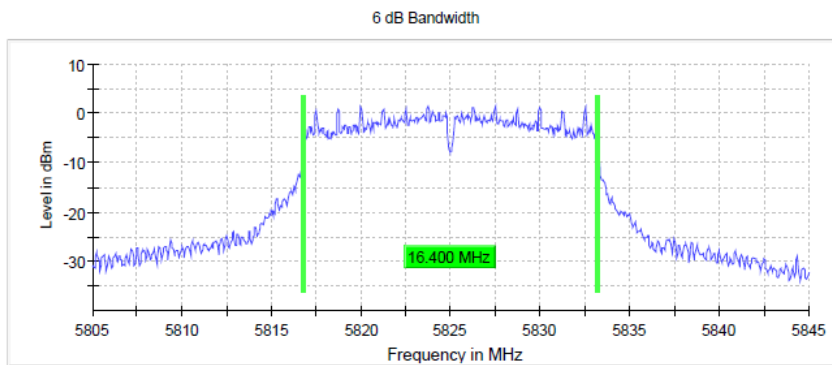

Setting	Instrument Value
Start Frequency	5.80500 GHz
Stop Frequency	5.84500 GHz
Span	40.000 MHz
RBW	100.000 kHz
VBW	300.000 kHz
SweepPoints	800
Sweeptime	56.836 μ s
Reference Level	0.000 dBm
Attenuation	20.000 dB
Detector	MaxPeak
SweepCount	200
Filter	3 dB
Trace Mode	Max Hold
Sweeptype	FFT
Preamp	off
Stablemode	Trace
Stablevalue	0.30 dB
Run	21 / max. 150
Stable	5 / 5
Max Stable Difference	0.23 dB

Radio Technology = WLAN n 40 MHz, Operating Frequency = high, Subband = U-NII-3 (S01_AE01)

6 dB Bandwidth

DUT Frequency (MHz)	Bandwidth (MHz)	Limit Min (MHz)	Limit Max (MHz)	Band Edge Left (MHz)	Band Edge Right (MHz)	Max Level (dBm)	Result
5795.000000	35.750000	0.500000	---	5777.025000	5812.775000	-0.4	PASS

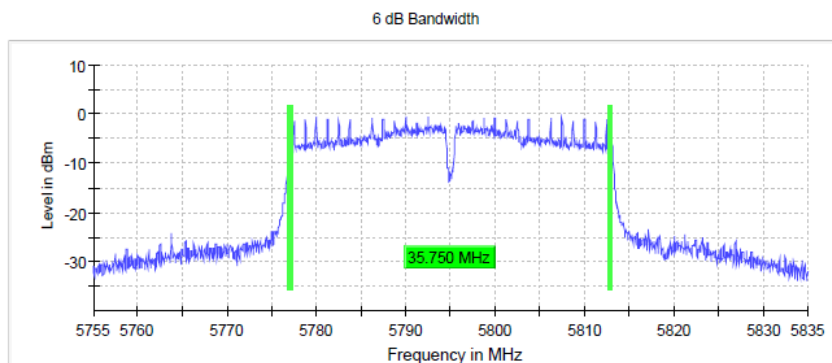

Setting	Instrument Value
Start Frequency	5.75500 GHz
Stop Frequency	5.83500 GHz
Span	80.000 MHz
RBW	100.000 kHz
VBW	300.000 kHz
SweepPoints	1600
Sweeptime	94.727 μ s
Reference Level	0.000 dBm
Attenuation	20.000 dB
Detector	MaxPeak
SweepCount	200
Filter	3 dB
Trace Mode	Max Hold
Sweeptype	FFT
Preamp	off
Stablemode	Trace
Stablevalue	0.30 dB
Run	93 / max. 150
Stable	5 / 5
Max Stable Difference	0.17 dB

Radio Technology = WLAN ac 80 MHz, Operating Frequency = mid, Subband = U-NII-3 (S01_AE01)

6 dB Bandwidth

DUT Frequency (MHz)	Bandwidth (MHz)	Limit Min (MHz)	Limit Max (MHz)	Band Edge Left (MHz)	Band Edge Right (MHz)	Max Level (dBm)	Result
5775.000000	75.450000	0.500000	---	5737.175000	5812.625000	-5.4	PASS

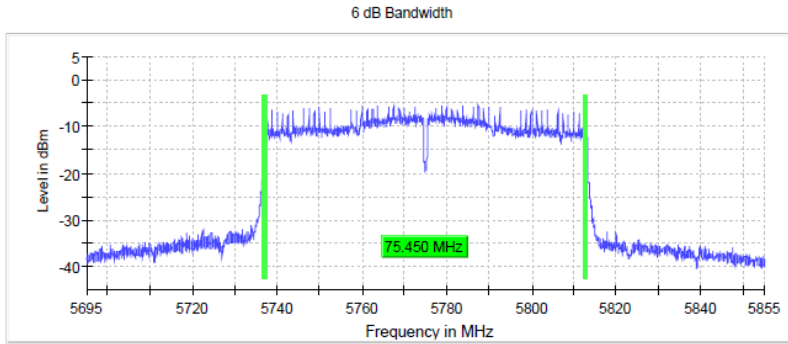

Setting	Instrument Value
Start Frequency	5.69500 GHz
Stop Frequency	5.85500 GHz
Span	160.000 MHz
RBW	100.000 kHz
VBW	300.000 kHz
SweepPoints	3200
Sweeptime	189.453 μ s
Reference Level	0.000 dBm
Attenuation	20.000 dB
Detector	MaxPeak
SweepCount	200
Filter	3 dB
Trace Mode	Max Hold
SweepType	FFT
Preamp	off
Stablemode	Trace
Stablevalue	0.30 dB
Run	105 / max. 150
Stable	5 / 5
Max Stable Difference	0.06 dB

5.2.5 TEST EQUIPMENT USED

- R&S TS8997

5.3 99 % BANDWIDTH

Standard **FCC Part 15 Subpart E**

The test was performed according to:
ANSI C63.10

5.3.1 TEST DESCRIPTION

The Equipment Under Test (EUT) was set up to perform the occupied bandwidth measurements.

The reference level is the level of the highest amplitude signal observed from the transmitter at either the fundamental frequency or first-order modulation products in all typical modes of operation, including the unmodulated carrier, even if atypical.

The results recorded were measured with the modulation which produce the worst-case (widest) emission bandwidth.

The EUT was connected to the test system as described in the block diagram below. The complete attenuation of the measurement path is known and considered.

Analyzer settings:

- Resolution Bandwidth (RBW): approx. $\geq 1\%$ of the span, but not below
- Video Bandwidth (VBW): ≥ 3 times the RBW
- Span: 40 / 80 / 160 / 320 MHz (for 20 / 40 / 80 / 160 MHz nominal bandwidth)
- Trace: Maxhold
- Sweeps: Until the trace is stable
- Sweeptime: Auto
- Detector: Peak

The 99 % measurement function of the spectrum analyser function was used to determine the 99 % bandwidth.

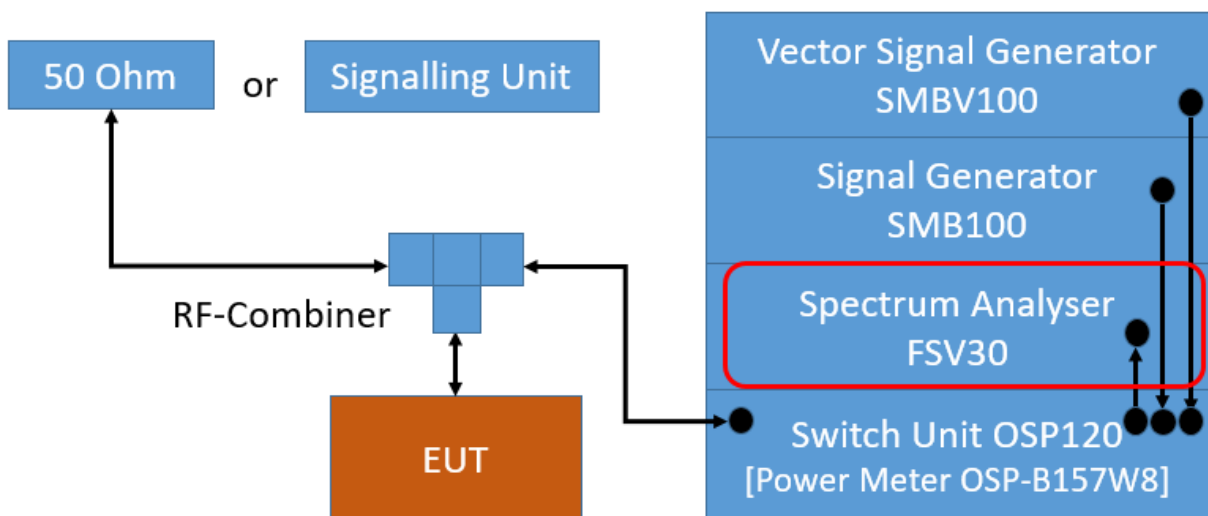

TS8997; Occupied Channel Bandwidth 6 dB / 26 dB / 99 %

5.3.2 TEST REQUIREMENTS / LIMITS

No applicable limit.

5.3.3 TEST PROTOCOL

Ambient temperature: 24 °C
 Air Pressure: 1007 hPa
 Humidity: 39 %

Radio Technology	Operating Frequency	Subband	99% Bandwidth [MHz]
WLAN a	low	U-NII-1	16.7
WLAN a	high	U-NII-1	16.7
WLAN a	low	U-NII-2A	16.8
WLAN a	high	U-NII-2A	16.8
WLAN a	low	U-NII-2C	16.7
WLAN a	high	U-NII-2C	16.8
WLAN a	low	U-NII-3	17.1
WLAN a	high	U-NII-3	17.1
WLAN n 20 MHz	low	U-NII-1	17.9
WLAN n 20 MHz	high	U-NII-1	18.0
WLAN n 20 MHz	low	U-NII-2A	18.3
WLAN n 20 MHz	high	U-NII-2A	17.9
WLAN n 20 MHz	low	U-NII-2C	17.9
WLAN n 20 MHz	high	U-NII-2C	18.0
WLAN n 20 MHz	low	U-NII-3	18.5
WLAN n 20 MHz	high	U-NII-3	18.5
WLAN n 40 MHz	low	U-NII-1	36.5
WLAN n 40 MHz	high	U-NII-1	36.5
WLAN n 40 MHz	low	U-NII-2A	36.5
WLAN n 40 MHz	high	U-NII-2A	36.5
WLAN n 40 MHz	low	U-NII-2C	36.5
WLAN n 40 MHz	high	U-NII-2C	36.5
WLAN n 40 MHz	low	U-NII-3	37.3
WLAN n 40 MHz	high	U-NII-3	37.3
WLAN ac 20 MHz	low	U-NII-1	17.9
WLAN ac 20 MHz	high	U-NII-1	18.1
WLAN ac 20 MHz	low	U-NII-2A	18.1
WLAN ac 20 MHz	high	U-NII-2A	17.9
WLAN ac 20 MHz	low	U-NII-2C	18.0
WLAN ac 20 MHz	high	U-NII-2C	17.9
WLAN ac 20 MHz	low	U-NII-3	18.5
WLAN ac 20 MHz	high	U-NII-3	18.3
WLAN ac 40 MHz	low	U-NII-1	36.3
WLAN ac 40 MHz	high	U-NII-1	36.3
WLAN ac 40 MHz	low	U-NII-2A	36.5
WLAN ac 40 MHz	high	U-NII-2A	36.5
WLAN ac 40 MHz	low	U-NII-2C	36.3
WLAN ac 40 MHz	high	U-NII-2C	36.3
WLAN ac 40 MHz	low	U-NII-3	37.0
WLAN ac 40 MHz	high	U-NII-3	37.3
WLAN ac 80 MHz	mid	U-NII-1	76.5
WLAN ac 80 MHz	mid	U-NII-2A	76.0
WLAN ac 80 MHz	low	U-NII-2C	76.5
WLAN ac 80 MHz	high	U-NII-2C	76.5
WLAN ac 80 MHz	mid	U-NII-3	76.5

Remark: Please see next sub-clause for the measurement plot.

5.3.4 MEASUREMENT PLOT (EXAMPLE PLOT, SHOWING WORST CASE, IF APPLICABLE)

Radio Technology = WLAN ac 20 MHz, Operating Frequency = low, Subband = U-NII-3 (S01_AE01)

99 % Bandwidth

DUT Frequency (MHz)	Bandwidth (MHz)	Limit Min (MHz)	Limit Max (MHz)	Band Edge Left (MHz)	Band Edge Right (MHz)	Result
5745.000000	18.500000	--	--	5735.650000	5754.150000	PASS

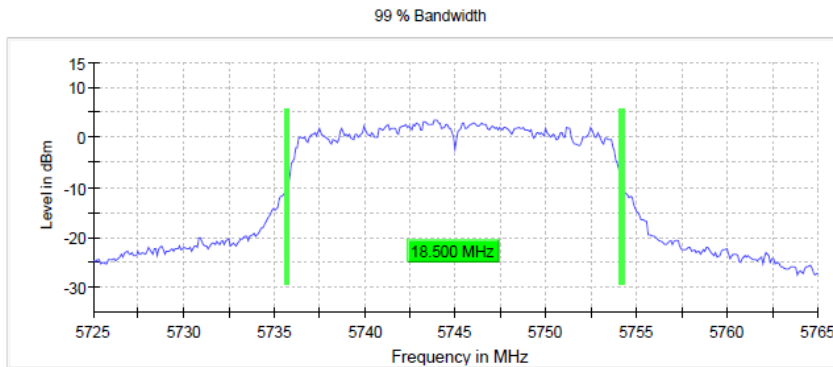

Setting	Instrument Value
Start Frequency	5.72500 GHz
Stop Frequency	5.76500 GHz
Span	40.000 MHz
RBW	200.000 kHz
VBW	1.000 MHz
SweepPoints	400
Sweeptime	28.477 μs
Reference Level	0.000 dBm
Attenuation	20.000 dB
Detector	MaxPeak
SweepCount	200
Filter	3 dB
Trace Mode	Max Hold
Sweeptype	FFT
Preamp	off
Stablemode	Trace
Stablevalue	0.30 dB
Run	68 / max. 150
Stable	5 / 5
Max Stable Difference	0.16 dB

Radio Technology = WLAN ac 40 MHz, Operating Frequency = high, Subband = U-NII-3 (S01_AE01)

99 % Bandwidth

DUT Frequency (MHz)	Bandwidth (MHz)	Limit Min (MHz)	Limit Max (MHz)	Band Edge Left (MHz)	Band Edge Right (MHz)	Result
5795.000000	37.250000	--	--	5776.375000	5813.625000	PASS

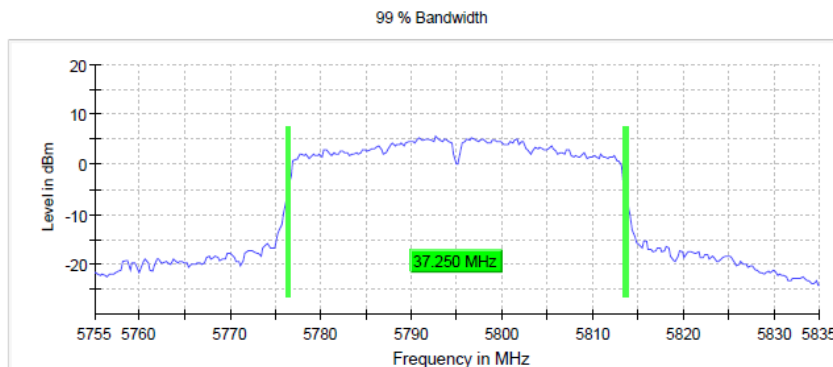

Setting	Instrument Value
Start Frequency	5.75500 GHz
Stop Frequency	5.83500 GHz
Span	80.000 MHz
RBW	500.000 kHz
VBW	2.000 MHz
SweepPoints	320
Sweeptime	18.906 μs
Reference Level	0.000 dBm
Attenuation	20.000 dB
Detector	MaxPeak
SweepCount	200
Filter	3 dB
Trace Mode	Max Hold
Sweeptype	FFT
Preamp	off
Stablemode	Trace
Stablevalue	0.30 dB
Run	102 / max. 150
Stable	5 / 5
Max Stable Difference	0.27 dB

Radio Technology = WLAN ac 80 MHz, Operating Frequency = mid, Subband = U-NII-3 (S01_AE01)

99 % Bandwidth

DUT Frequency (MHz)	Bandwidth (MHz)	Limit Min (MHz)	Limit Max (MHz)	Band Edge Left (MHz)	Band Edge Right (MHz)	Result
5775.000000	76.500000	---	---	5736.750000	5813.250000	PASS

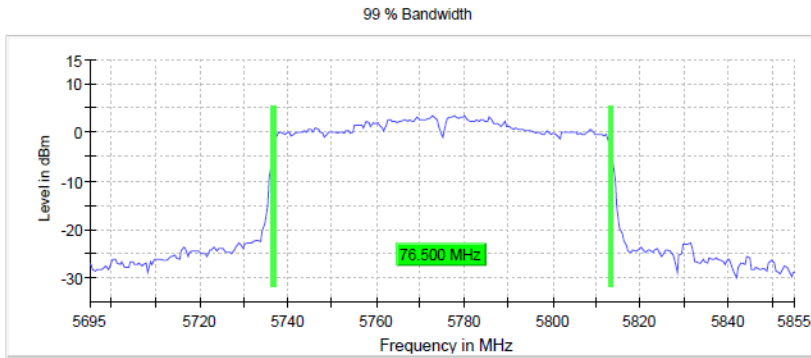

Setting	Instrument Value
Start Frequency	5.69500 GHz
Stop Frequency	5.85500 GHz
Span	160.000 MHz
RBW	1.000 MHz
VBW	3.000 MHz
SweepPoints	320
SweepTime	22.875 μ s
Reference Level	0.000 dBm
Attenuation	20.000 dB
Detector	MaxPeak
SweepCount	200
Filter	3 dB
Trace Mode	Max Hold
SweepType	FFT
Preamp	off
Stablemode	Trace
Stablevalue	0.30 dB
Run	58 / max. 150
Stable	5 / 5
Max Stable Difference	0.28 dB

5.3.5 TEST EQUIPMENT USED

- R&S TS8997

5.4 BAND EDGE

Standard **FCC Part 15 Subpart E**

The test was performed according to:
ANSI C63.10

5.4.1 TEST DESCRIPTION

The Equipment Under Test (EUT) was set up to perform the conducted spurious emissions measurements. The antenna port of the EUT was connected to spectrum analyzer via a short coax cable with a known cable loss C_L . The measured voltage U_{meas} at the 50 Ohm input of the analyser was used to calculate the EUT output power at the antenna port:

$$P = U_{meas} + C_L - 107$$

where

P is the output power in dBm

U_{meas} is the measured voltage at the 50 Ohm input of the analyzer in dB μ V

C_L is the cable loss of the used cable.

The maximum transmit isotropically antenna gain G_i (in dBi) was added to the measured output power P to determine the equivalent isotropically radiated power EIRP.

$$EIRP = P + G_i$$

where

P is the output power in dBm

G_i is maximum transmit antenna gain in dBi.

The resultant EIRP level was converted to an equivalent electric field strength using the following relationship:

$$E = EIRP - 20 \log d + 104.8$$

where

E is the electric field strength in dB μ V/m

EIRP is the equivalent isotropically radiated power in dBm

d is the specified measurement distance in m.

The appropriate maximum ground reflection factor was added to the EIRP:

6 dB for frequencies ≤ 30 MHz;

4.7 dB for frequencies between 30 MHz and 1000 MHz, inclusive; and

0 dB for frequencies > 1000 MHz).

Frequency range [MHz]	measurement distance d [m]	-20 log d [dB]	ground reflection factor [dB]
0,009 - 0,49	300	-49,54	6
0,49 - 30	30	-29,54	6
30 - 1000	3	-9,54	4,7
>1000	3	-9,54	0

For the MIMO values of Core 0 + Core 1, the measured dBm values were converted to mW, then added together, reconverted to dBm and afterwards converted to dB μ V/m as described above.

- Detector: Peak / RMS

- RBW = 1 MHz

- VBW = 3 MHz

See plots for further details

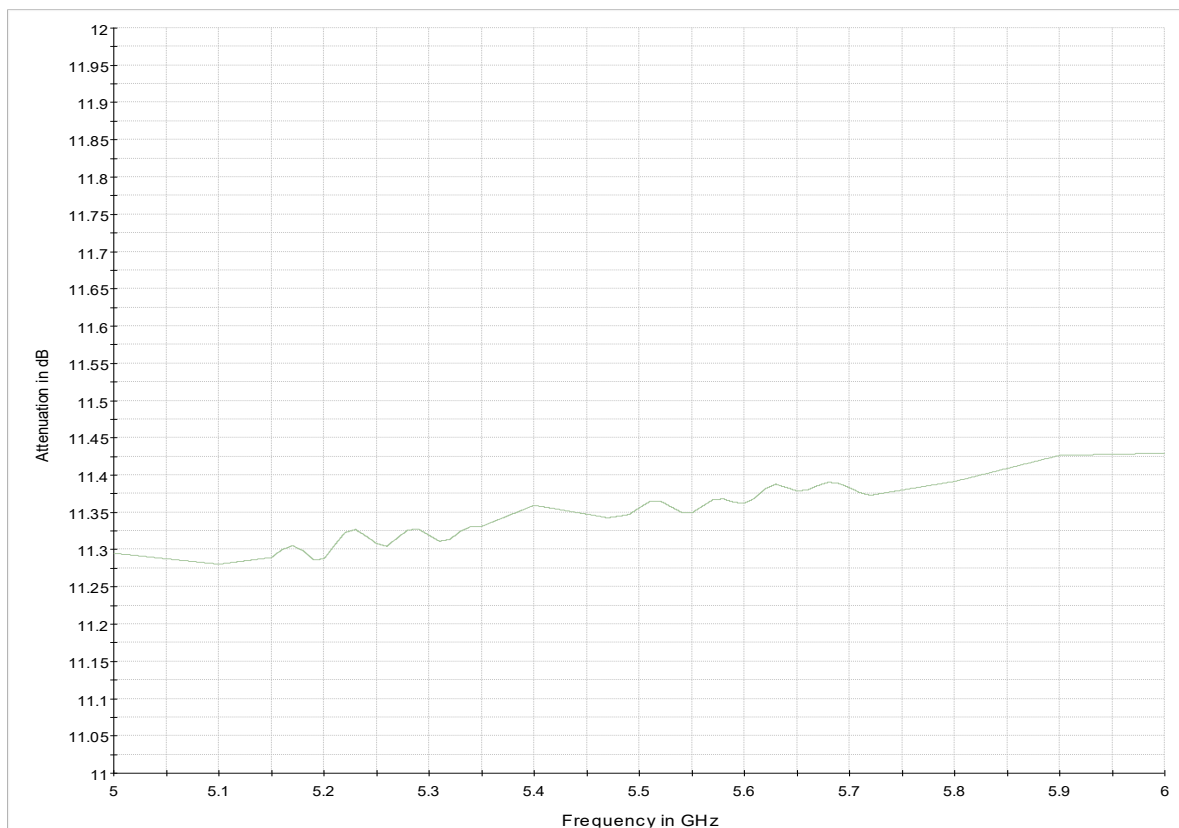
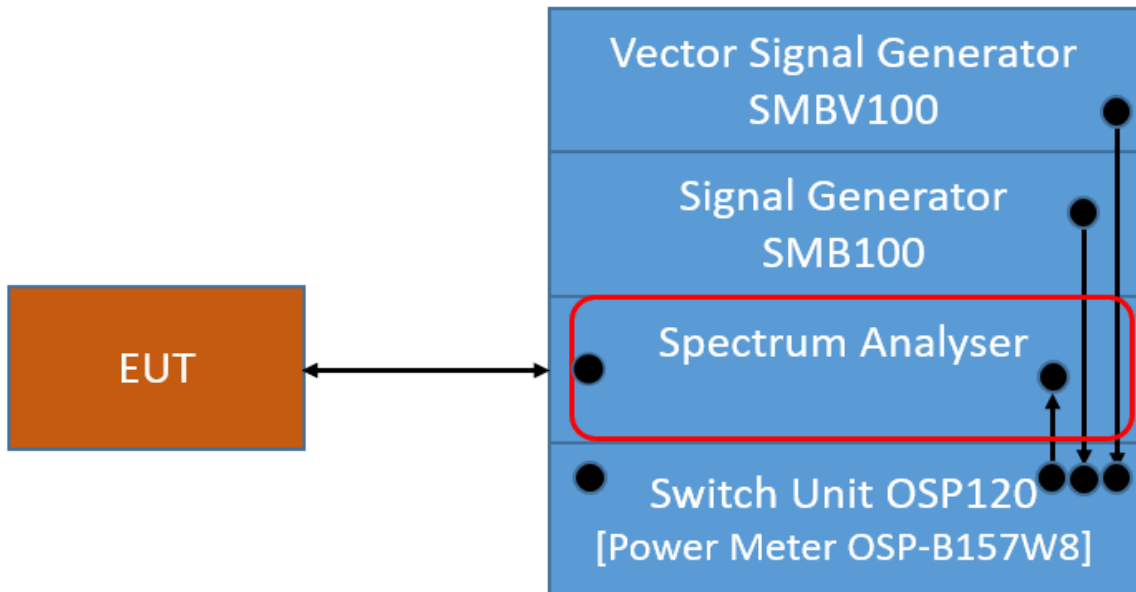

5.4.2 TEST REQUIREMENTS / LIMITS

For band edges connected to a restricted band, the limits are specified in Section 15.209(a)

FCC Part 15, Subpart C, §15.209, Radiated Emission Limits

Frequency in MHz	Limit ($\mu\text{V}/\text{m}$)	Measurement distance (m)	Limits ($\text{dB}\mu\text{V}/\text{m}$)
0.009 – 0.49	2400/F(kHz)@300m	3	(48.5 – 13.8)@300m
0.49 – 1.705	24000/F(kHz)@30m	3	(33.8 – 23.0)@30m
1.705 – 30	30@30m	3	29.5@30m

The measured values are corrected with an inverse linear distance extrapolation factor (40 dB/decade) according FCC 15.31 (2).

Frequency in MHz	Limit ($\mu\text{V}/\text{m}$)	Measurement distance (m)	Limits ($\text{dB}\mu\text{V}/\text{m}$)
30 – 88	100@3m	3	40.0@3m
88 – 216	150@3m	3	43.5@3m
216 – 960	200@3m	3	46.0@3m
960 - 26000	500@3m	3	54.0@3m
26000 - 40000	500@3m	1	54.0@3m

The measured values above 26 GHz are corrected with an inverse linear distance extrapolation factor (20 dB/decade).

§15.35(b) ..., there is also a limit on the radio frequency emissions, as measured using instrumentation with a peak detector function, corresponding to 20 dB above the maximum permitted average limit....

Used conversion factor: $\text{Limit (dB}\mu\text{V}/\text{m)} = 20 \log (\text{Limit } (\mu\text{V}/\text{m})/1\mu\text{V}/\text{m})$

5.4.3 TEST PROTOCOL

Ambient temperature: 24–26 °C
 Air Pressure: 1002–1024 hPa
 Humidity: 32–44 %
 WLAN a-Mode; 20 MHz; 6Mbit/s
 Applied duty cycle correction (AV): 0 dB

U-NII-Subband	Ch. No.	Ch. Center Freq. [MHz]	Band Edge Freq. [MHz]	Spurious Level [dBµV/m]	Detector	RBW [kHz]	Limit [dBµV/m]	Margin [dB]	Limit Type
1	36	5180	5150.0	66.7	PEAK	1000	74.0	7.3	BE-RB
	36	5180	5150.0	48.2	AV	1000	54.0	5.8	BE-RB
	40	5200	5150.0	60.8	PEAK	1000	74.0	13.2	BE-RB
	40	5200	5150.0	49.7	AV	1000	54.0	4.3	BE-RB
2A	60	5300	5350.0	61.6	PEAK	1000	74.0	12.4	BE-RB
	60	5300	5350.0	48.7	AV	1000	54.0	5.3	BE-RB
	64	5320	5350.0	63.2	PEAK	1000	74.0	10.8	BE-RB
	64	5320	5350.0	48.4	AV	1000	54.0	5.6	BE-RB
2C	100	5500	5460.0	64.6	PEAK	1000	74.0	9.4	BE-RB
	100	5500	5460.0	46.4	AV	1000	54.0	7.6	BE-RB
	100	5500	5470.0	61.4	PEAK	1000	68.2	6.8	BE-UE
	104	5520	5460.0	61.1	PEAK	1000	74.0	12.9	BE-RB
	104	5520	5460.0	47.2	AV	1000	54.0	6.8	BE-RB
	104	5520	5470.0	64.1	PEAK	1000	68.2	4.1	BE-UE
	136	5680	5725.0	65.5	PEAK	1000	68.2	2.7	BE-UE
	140	5700	5725.0	64.2	PEAK	1000	68.2	4.0	BE-UE
3	149	5745	5725.0	54.6	PEAK	1000	68.2	13.6	BE-UE
	165	5825	5850.0	52.9	PEAK	1000	68.2	15.3	BE-UE

WLAN n-Mode; 20 MHz; MCS 0; MIMO
 Applied duty cycle correction (AV): 0 dB

U-NII-Subband	Ch. No.	Ch. Center Freq. [MHz]	Band Edge Freq. [MHz]	Spurious Level [dBµV/m]	Detector	RBW [kHz]	Limit [dBµV/m]	Margin [dB]	Limit Type
1	36	5180	5150.0	66.5	PEAK	1000	74.0	7.5	BE-RB
	36	5180	5150.0	51.1	AV	1000	54.0	2.9	BE-RB
	40	5200	5150.0	64.3	PEAK	1000	74.0	9.7	BE-RB
	40	5200	5150.0	51.1	AV	1000	54.0	2.9	BE-RB
2A	60	5300	5350.0	63.2	PEAK	1000	74.0	10.8	BE-RB
	60	5300	5350.0	51.5	AV	1000	54.0	2.5	BE-RB
	64	5320	5350.0	66.9	PEAK	1000	74.0	7.1	BE-RB
	64	5320	5350.0	50.9	AV	1000	54.0	3.1	BE-RB
2C	100	5500	5460.0	61.0	PEAK	1000	74.0	13.0	BE-RB
	100	5500	5460.0	48.5	AV	1000	54.0	5.5	BE-RB
	100	5500	5470.0	61.1	PEAK	1000	68.2	7.1	BE-UE
	104	5520	5460.0	61.4	PEAK	1000	74.0	12.6	BE-RB
	104	5520	5460.0	51.1	AV	1000	54.0	2.9	BE-RB
	104	5520	5470.0	66.8	PEAK	1000	68.2	1.4	BE-UE
	136	5680	5725.0	65.6	PEAK	1000	68.2	2.6	BE-UE
	140	5700	5725.0	62.7	PEAK	1000	68.2	5.5	BE-UE
3	149	5745	5725.0	57.5	PEAK	1000	68.2	10.7	BE-UE
	165	5825	5850.0	55.4	PEAK	1000	68.2	12.8	BE-UE

WLAN n-Mode; 40 MHz; MCS0; MIMO
 Applied duty cycle correction (AV): 0 dB

U-NII-Subband	Ch. No.	Ch. Center Freq. [MHz]	Band Edge Freq. [MHz]	Spurious Level [dBµV/m]	Detector	RBW [kHz]	Limit [dBµV/m]	Margin [dB]	Limit Type
1	38	5190	5150.0	62.1	PEAK	1000	74.0	11.9	BE-RB
	38	5190	5150.0	49.7	AV	1000	54.0	4.3	BE-RB
	46	5230	5150.0	62.0	PEAK	1000	74.0	12.0	BE-RB
	46	5230	5150.0	48.3	AV	1000	54.0	5.7	BE-RB
2A	54	5270	5350.0	61.2	PEAK	1000	74.0	12.8	BE-RB
	54	5270	5350.0	48.5	AV	1000	54.0	5.5	BE-RB
	62	5310	5350.0	67.9	PEAK	1000	74.0	6.1	BE-RB
	62	5310	5350.0	52.7	AV	1000	54.0	1.3	BE-RB
2C	102	5510	5460.0	57.6	PEAK	1000	74.0	16.4	BE-RB
	102	5510	5460.0	47.2	AV	1000	54.0	6.8	BE-RB
	102	5510	5470.0	60.4	PEAK	1000	68.2	7.8	BE-UE
	110	5550	5460.0	59.7	PEAK	1000	74.0	14.3	BE-RB
	110	5550	5460.0	48.2	AV	1000	54.0	5.8	BE-RB
	110	5550	5470.0	62.6	PEAK	1000	68.2	5.6	BE-UE
	126	5630	5725.0	57.7	PEAK	1000	68.2	10.5	BE-UE
	134	5670	5725.0	62.2	PEAK	1000	68.2	6.0	BE-UE
3	151	5755	5725.0	65.4	PEAK	1000	68.2	2.8	BE-UE
	159	5795	5850.0	57.4	PEAK	1000	68.2	10.8	BE-UE

WLAN ac-Mode; 20 MHz; MCS0; MIMO
 Applied duty cycle correction (AV): 0 dB

U-NII-Subband	Ch. No.	Ch. Center Freq. [MHz]	Band Edge Freq. [MHz]	Spurious Level [dBµV/m]	Detector	RBW [kHz]	Limit [dBµV/m]	Margin [dB]	Limit Type
1	36	5180	5150.0	69.3	PEAK	1000	74.0	4.7	BE-RB
	36	5180	5150.0	51.3	AV	1000	54.0	2.7	BE-RB
	40	5200	5150.0	64.8	PEAK	1000	74.0	9.2	BE-RB
	40	5200	5150.0	51.6	AV	1000	54.0	2.4	BE-RB
2A	60	5300	5350.0	63.0	PEAK	1000	74.0	11.0	BE-RB
	60	5300	5350.0	51.0	AV	1000	54.0	3.0	BE-RB
	64	5320	5350.0	67.5	PEAK	1000	74.0	6.5	BE-RB
	64	5320	5350.0	51.2	AV	1000	54.0	2.8	BE-RB
2C	100	5500	5460.0	61.0	PEAK	1000	74.0	13.0	BE-RB
	100	5500	5460.0	48.2	AV	1000	54.0	5.8	BE-RB
	100	5500	5470.0	62.1	PEAK	1000	68.2	6.1	BE-UE
	104	5520	5460.0	64.2	PEAK	1000	74.0	9.8	BE-RB
	104	5520	5460.0	51.3	AV	1000	54.0	2.7	BE-RB
	104	5520	5470.0	65.7	PEAK	1000	68.2	2.5	BE-UE
	136	5680	5725.0	64.2	PEAK	1000	68.2	4.0	BE-UE
	140	5700	5725.0	65.2	PEAK	1000	68.2	3.0	BE-UE
3	149	5745	5725.0	57.1	PEAK	1000	68.2	11.1	BE-UE
	165	5825	5850.0	55.4	PEAK	1000	68.2	12.8	BE-UE

WLAN ac-Mode; 40 MHz; MCS0; MIMO
 Applied duty cycle correction (AV): 0 dB

U-NII-Subband	Ch. No.	Ch. Center Freq. [MHz]	Band Edge Freq. [MHz]	Spurious Level [dBμV/m]	Detector	RBW [kHz]	Limit [dBμV/m]	Margin [dB]	Limit Type
1	38	5190	5150.0	62.8	PEAK	1000	74.0	11.2	BE-RB
	38	5190	5150.0	50.6	AV	1000	54.0	3.4	BE-RB
	46	5230	5150.0	62.6	PEAK	1000	74.0	11.4	BE-RB
	46	5230	5150.0	49.0	AV	1000	54.0	5.0	BE-RB
2A	54	5270	5350.0	60.2	PEAK	1000	74.0	13.8	BE-RB
	54	5270	5350.0	48.3	AV	1000	54.0	5.7	BE-RB
	62	5310	5350.0	65.9	PEAK	1000	74.0	8.1	BE-RB
	62	5310	5350.0	52.2	AV	1000	54.0	1.8	BE-RB
2C	102	5510	5460.0	57.3	PEAK	1000	74.0	16.7	BE-RB
	102	5510	5460.0	47.2	AV	1000	54.0	6.8	BE-RB
	102	5510	5470.0	58.3	PEAK	1000	68.2	9.9	BE-UE
	110	5550	5460.0	57.9	PEAK	1000	74.0	16.1	BE-RB
	110	5550	5460.0	47.9	AV	1000	54.0	6.1	BE-RB
	110	5550	5470.0	59.9	PEAK	1000	68.2	8.3	BE-UE
	126	5630	5725.0	58.2	PEAK	1000	68.2	10.0	BE-UE
	134	5670	5725.0	58.8	PEAK	1000	68.2	9.4	BE-UE
3	151	5755	5725.0	64.2	PEAK	1000	68.2	4.0	BE-UE
	159	5795	5850.0	57.4	PEAK	1000	68.2	10.8	BE-UE

WLAN ac-Mode; 80 MHz; MCS0; MIMO
 Applied duty cycle correction (AV): 0 dB

U-NII-Subband	Ch. No.	Ch. Center Freq. [MHz]	Band Edge Freq. [MHz]	Spurious Level [dBμV/m]	Detector	RBW [kHz]	Limit [dBμV/m]	Margin [dB]	Limit Type
1	42	5210	5150.0	63.5	PEAK	1000	74.0	10.5	BE-RB
	42	5210	5150.0	50.7	AV	1000	54.0	3.3	BE-RB
2A	58	5290	5350.0	59.4	PEAK	1000	74.0	14.6	BE-RB
	58	5290	5350.0	48.4	AV	1000	54.0	5.6	BE-RB
2C	106	5530	5460.0	55.1	PEAK	1000	74.0	18.9	BE-RB
	106	5530	5460.0	44.6	AV	1000	54.0	9.4	BE-RB
	106	5530	5470.0	55.5	PEAK	1000	68.2	12.7	BE-UE
	122	5610	5725.0	55.3	PEAK	1000	68.2	12.9	BE-UE
3	155	5775	5725.0	67.5	PEAK	1000	68.2	0.7	BE-UE
	155	5775	5850.0	61.1	PEAK	1000	68.2	7.1	BE-UE

Remark: Please see next sub-clause for the measurement plot.

5.4.4 MEASUREMENT PLOT (EXAMPLE PLOT, SHOWING WORST CASE, IF APPLICABLE)

Radio Technology = WLAN a, Subband = U-NII-1/2A (S01_AE01)

Antenna 0

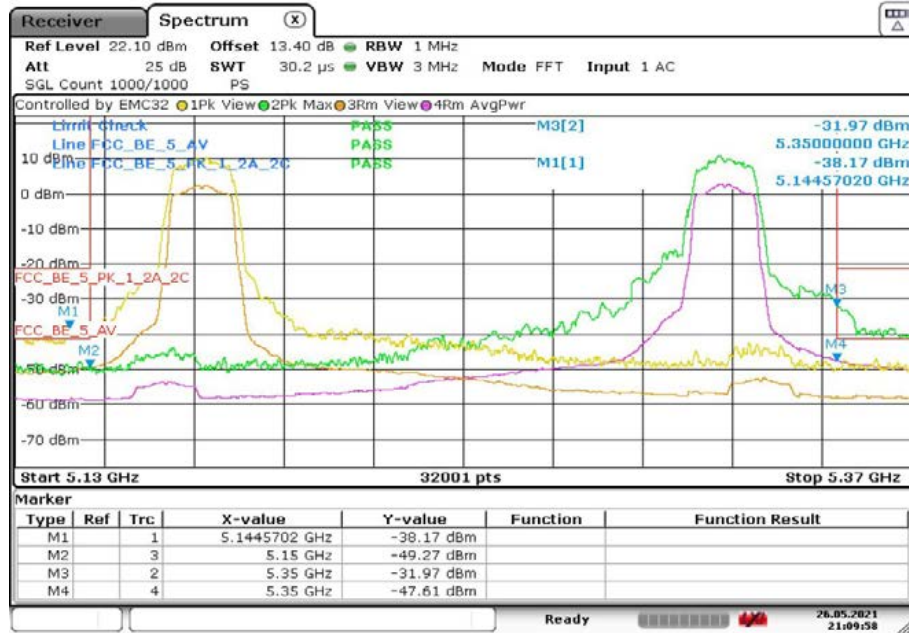

Date: 26.MAY.2021 21:09:57

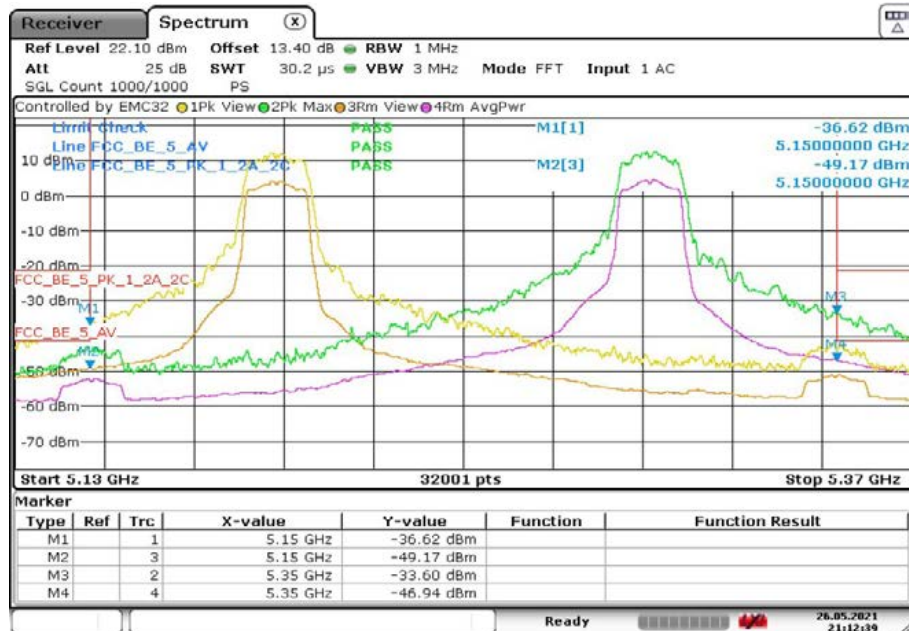

Date: 26.MAY.2021 21:12:38

Antenna 1

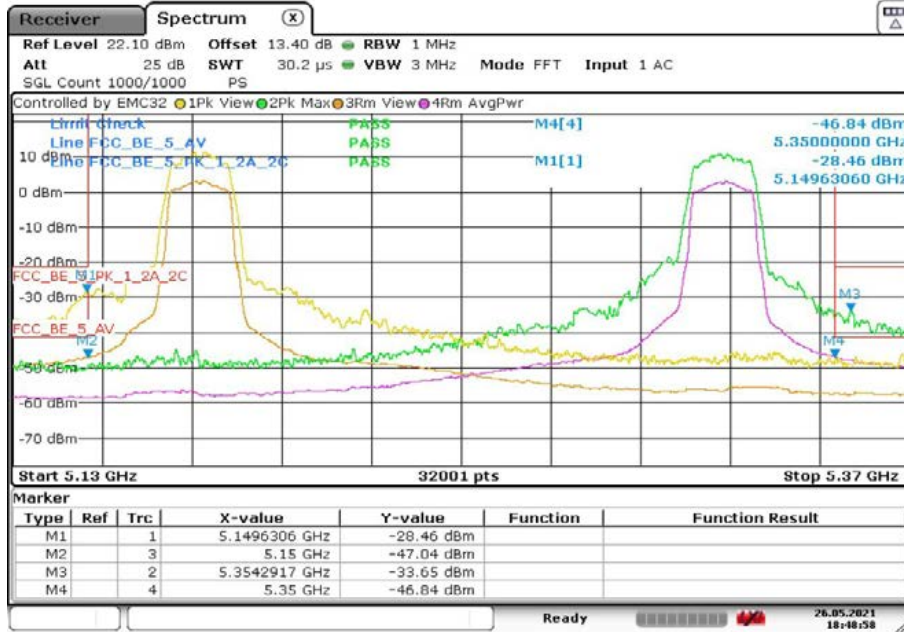

Date: 26.MAY.2021 18:48:58

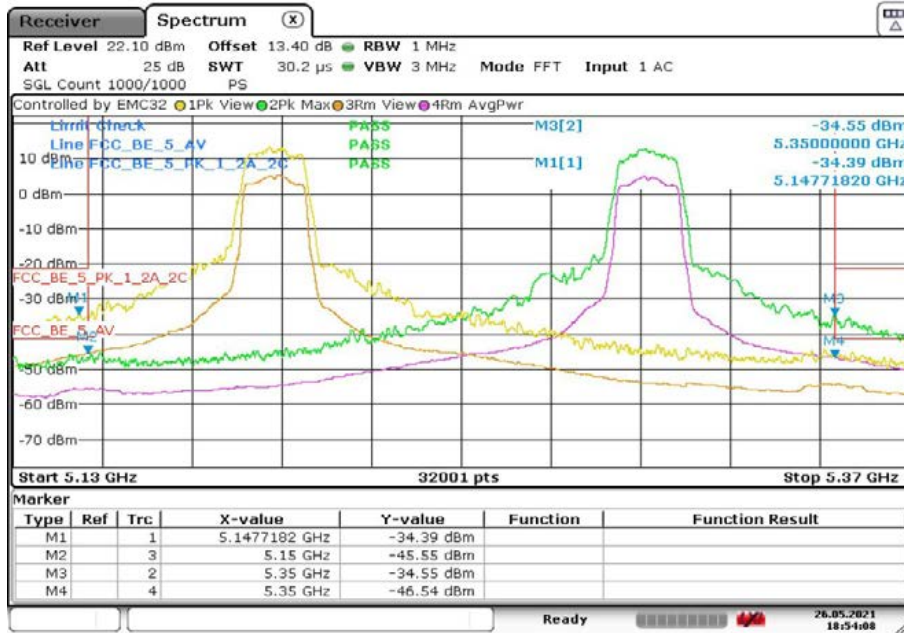

Date: 26.MAY.2021 18:54:08

Radio Technology = WLAN a, Subband = U-NII-2C
(S01_AF01)

Antenna 0

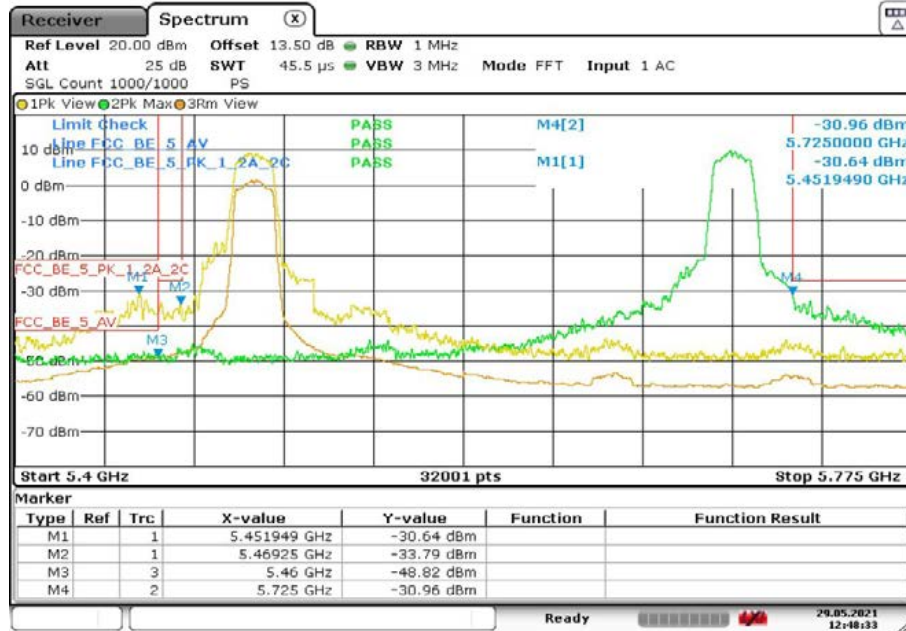

Date: 29.MAY.2021 12:48:33

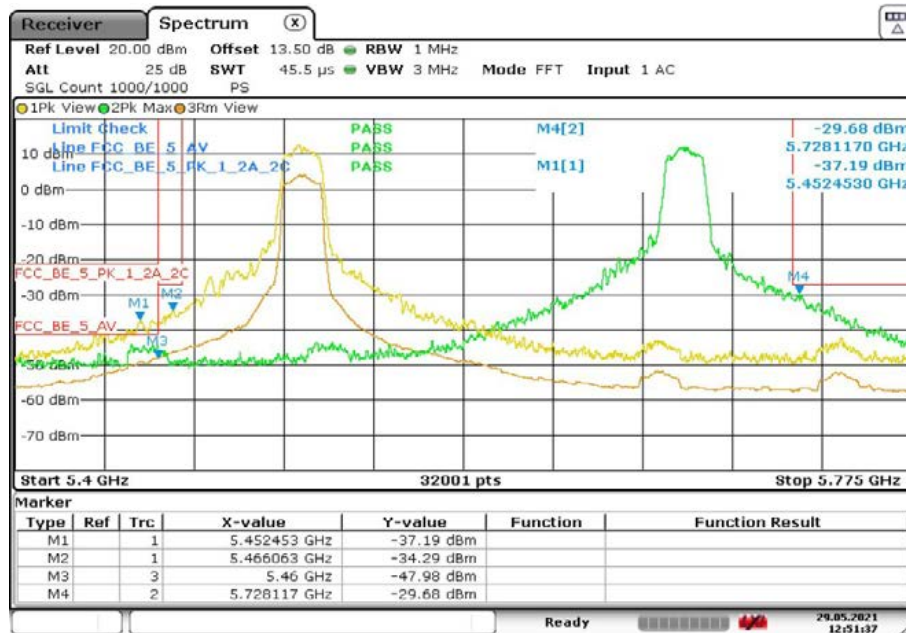

Date: 29.MAY.2021 12:51:37

Antenna 1

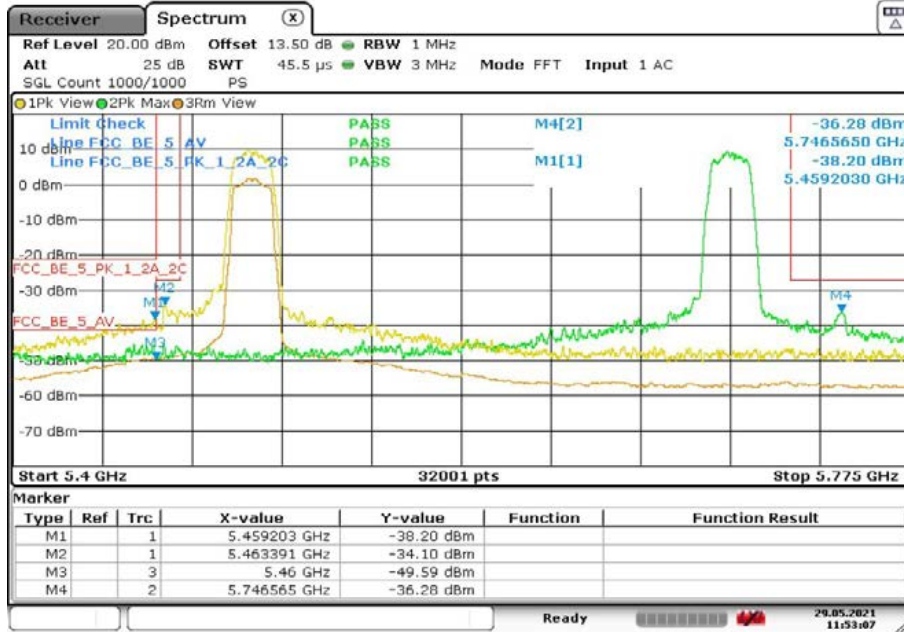

Date: 29.MAY.2021 11:53:06

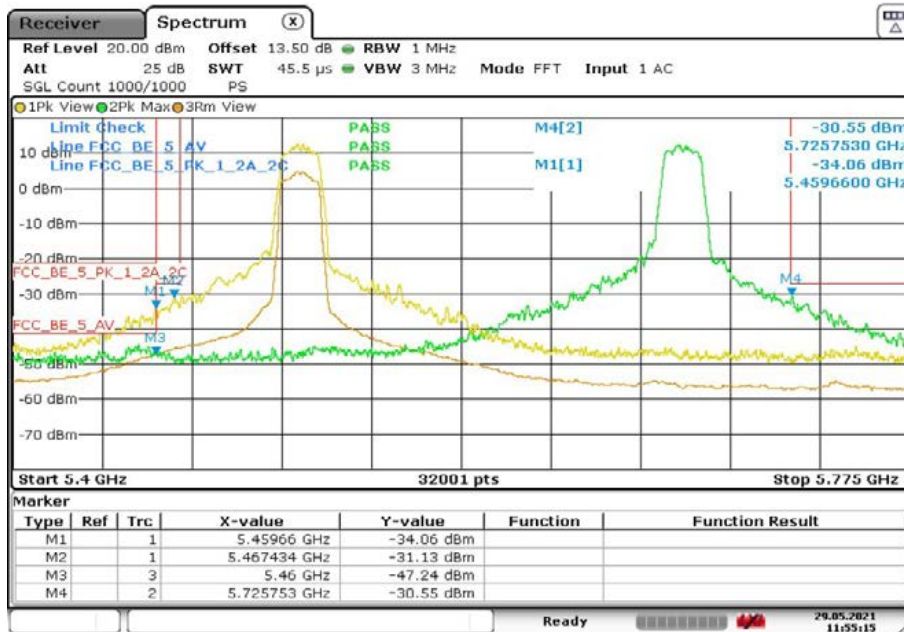

Date: 29.MAY.2021 11:55:14

Radio Technology = WLAN a, Subband = U-NII-3
(S01_AF01)

Antenna 0

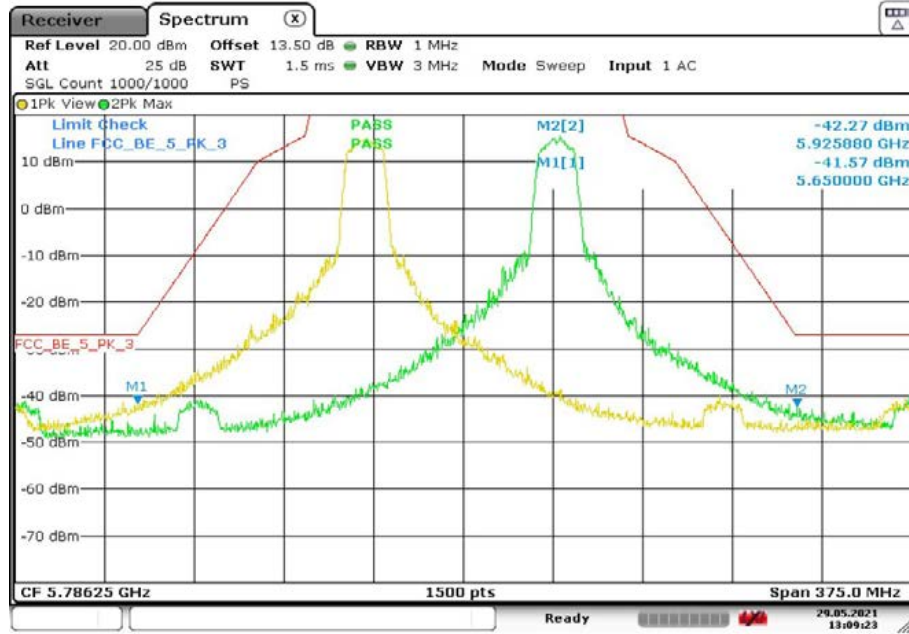

Date: 29.MAY.2021 13:09:23

Antenna 1

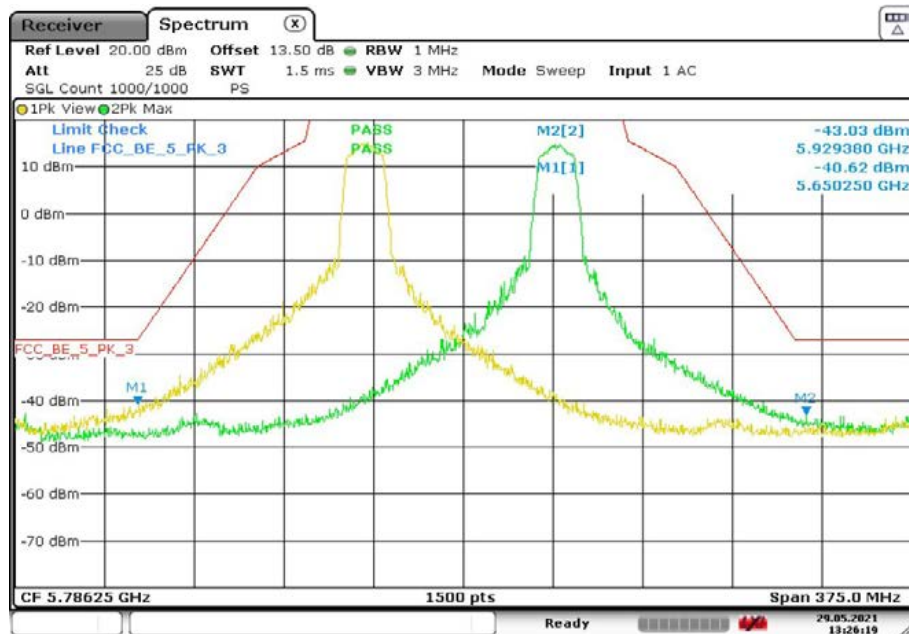

Date: 29.MAY.2021 13:26:19

Radio Technology = WLAN n 20 MHz MIMO, Subband = U-NII-1/2A (S01_AE01)

Antenna 0

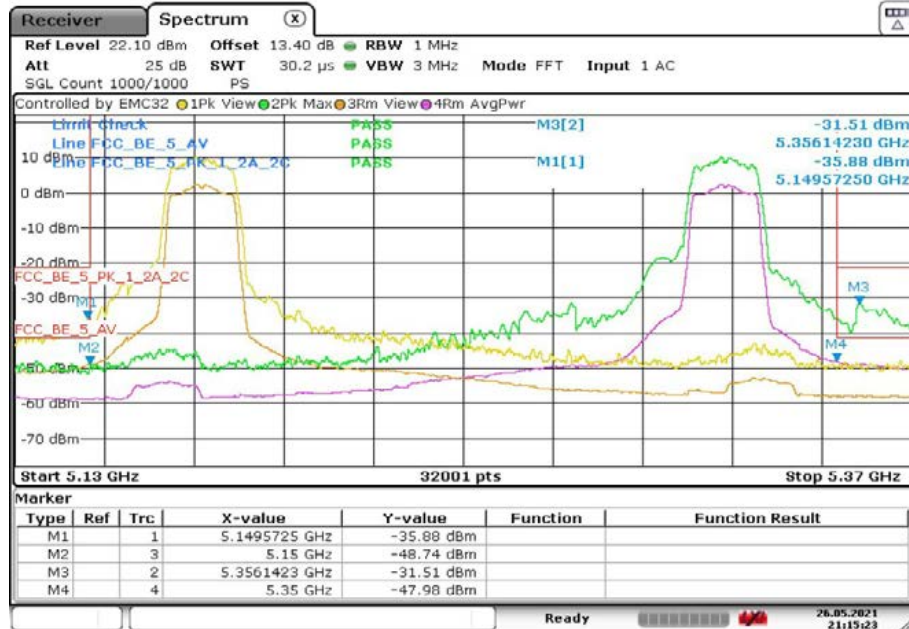

Date: 26.MAY.2021 21:15:23

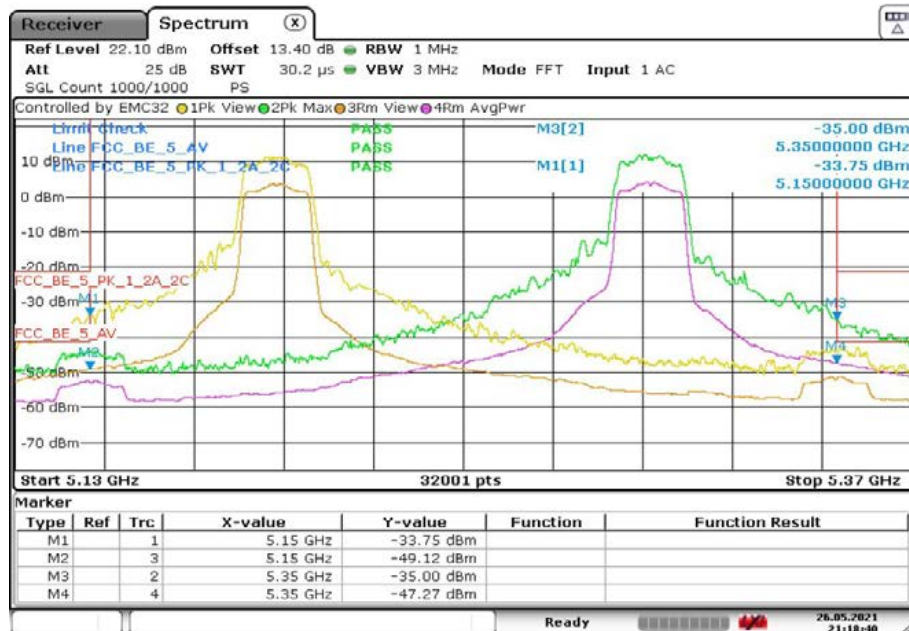

Date: 26.MAY.2021 21:18:39

Antenna 1

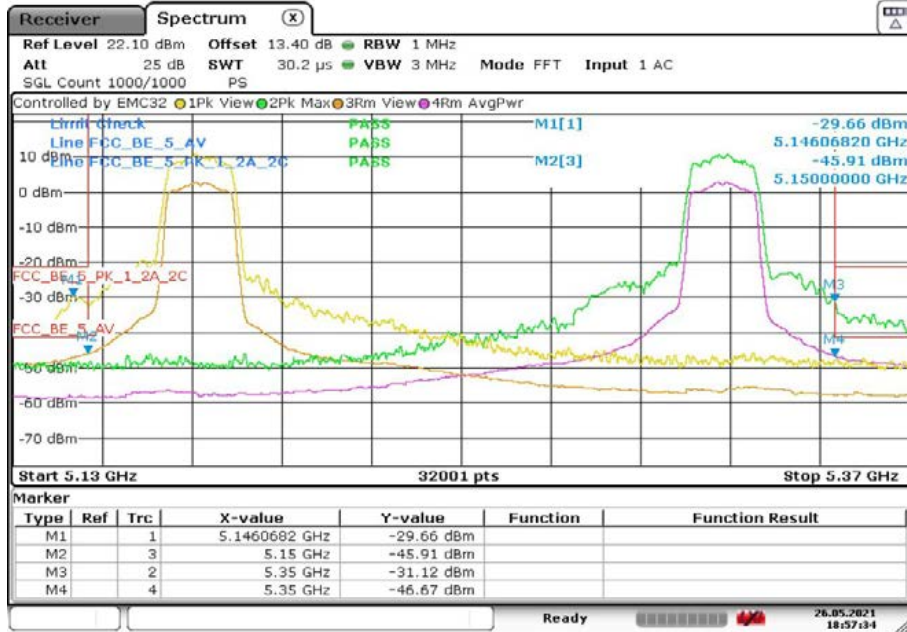

Date: 26.MAY.2021 18:57:34

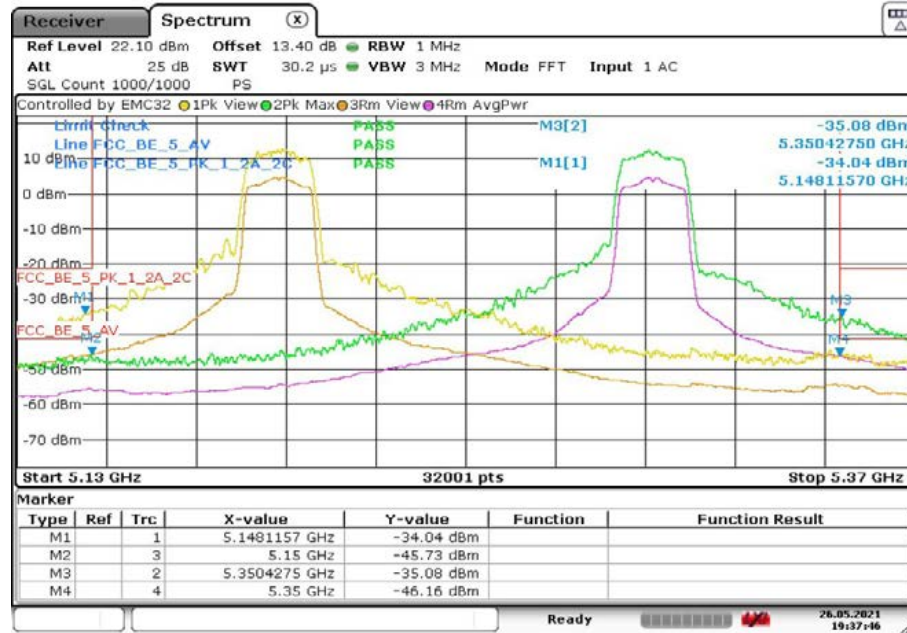

Date: 26.MAY.2021 19:37:46

Radio Technology = WLAN n 20 MHz MIMO, Subband = U-NII-2C (S01_AF01)

Antenna 0

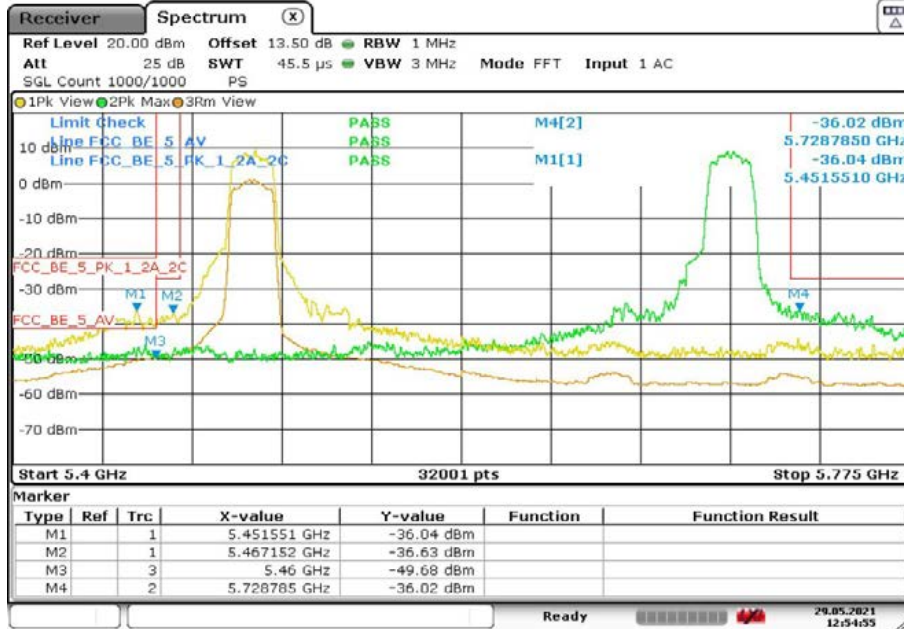

Date: 29.MAY.2021 12:54:55

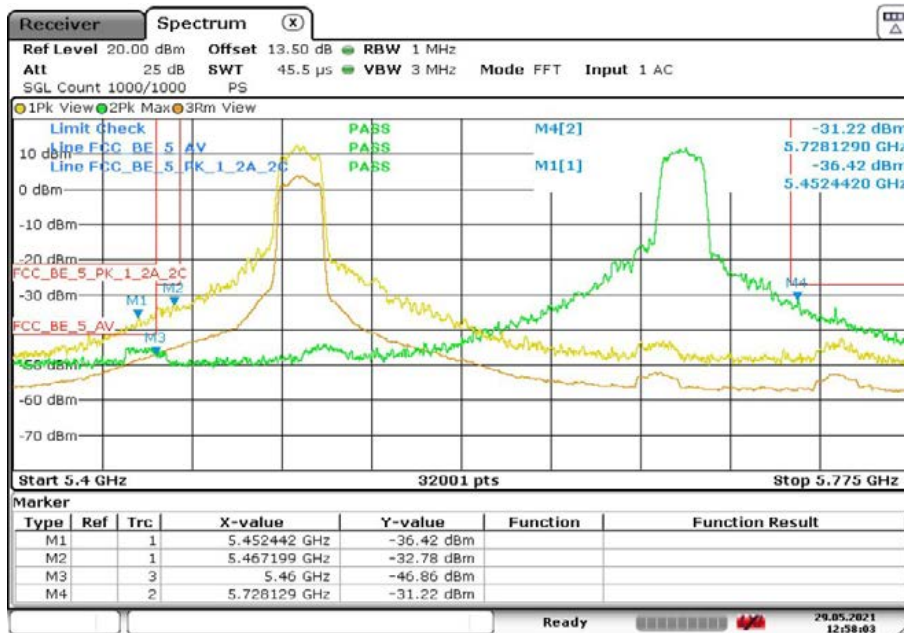

Date: 29.MAY.2021 12:58:02

Antenna 1

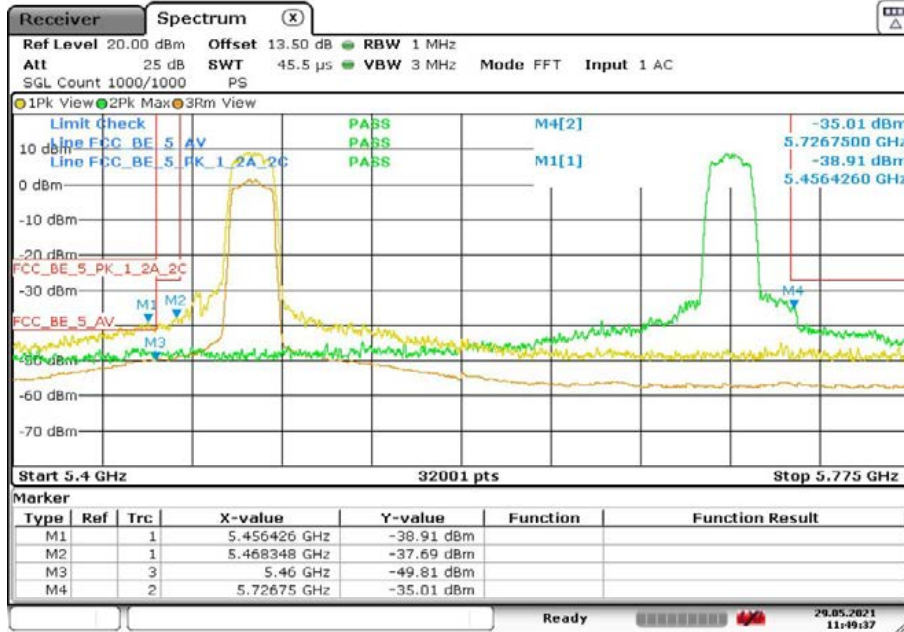

Date: 29.MAY.2021 11:49:37

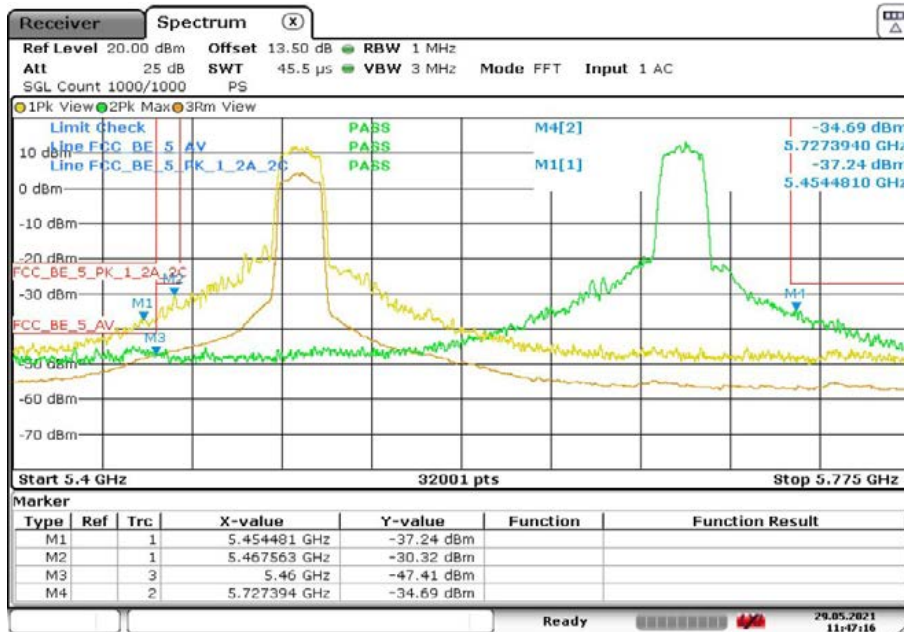

Date: 29.MAY.2021 11:47:16

Radio Technology = WLAN n 20 MHz MIMO, Subband = U-NII-3
(S01_AF01)

Antenna 0

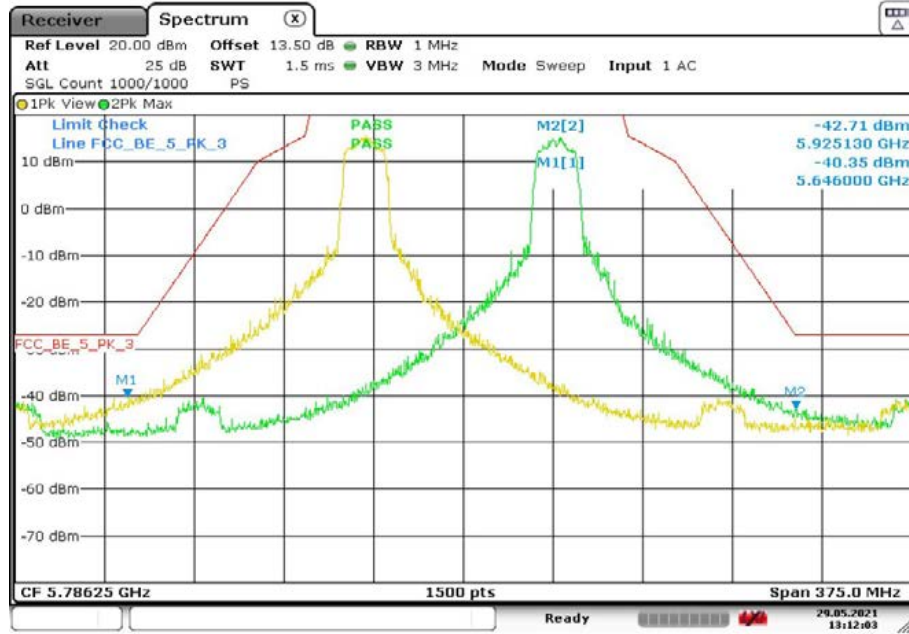

Date: 29.MAY.2021 13:12:03

Antenna 1

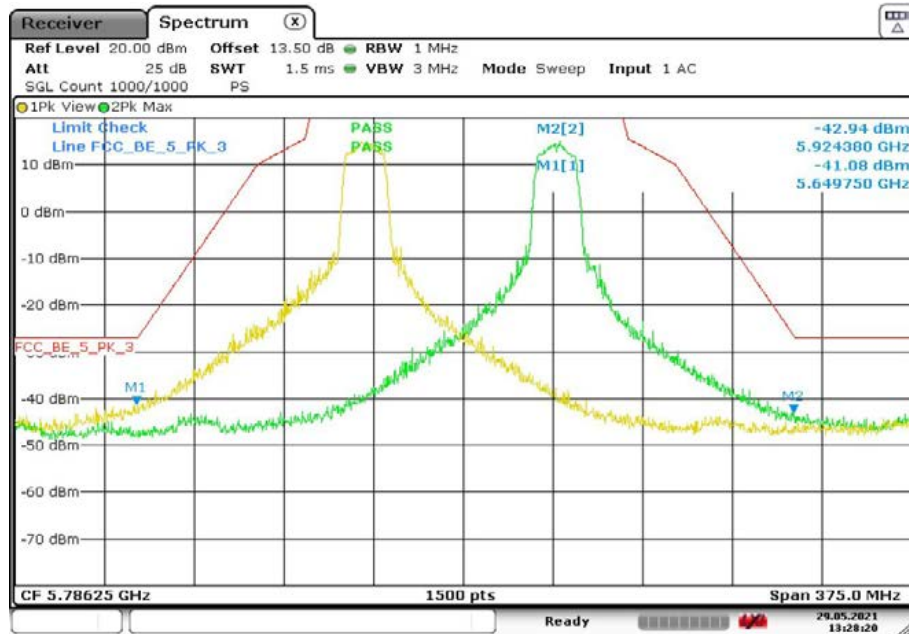

Date: 29.MAY.2021 13:28:21

Radio Technology = WLAN n 40 MHz MIMO, Subband = U-NII-1/2A (S01_AE01)

Antenna 0

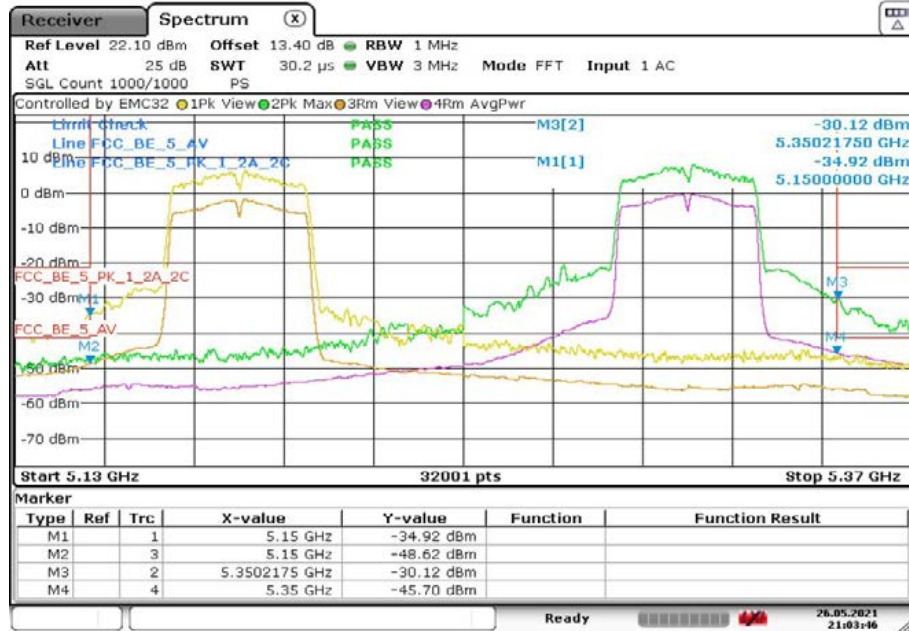

Date: 26.MAY.2021 21:03:45

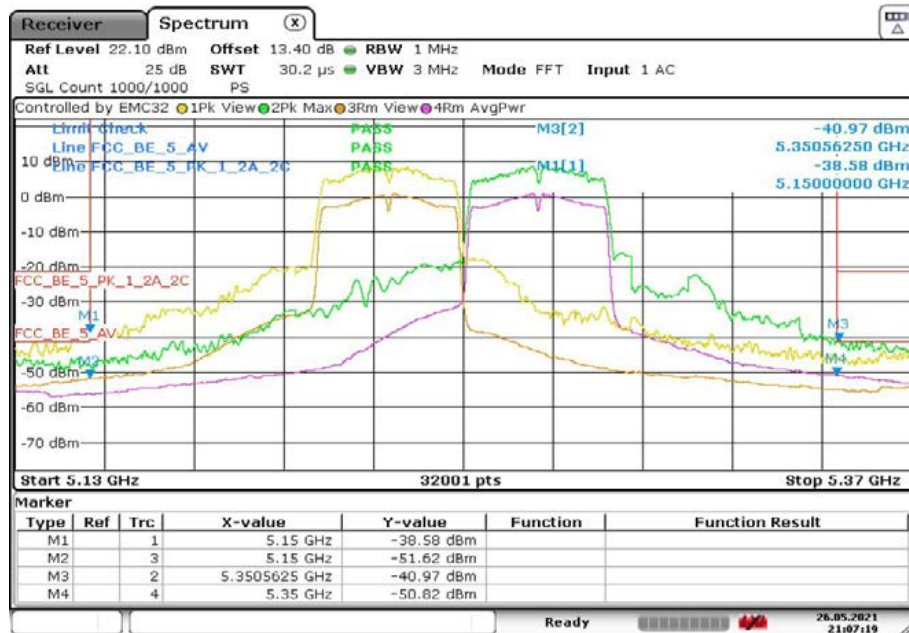

Date: 26.MAY.2021 21:07:20

Antenna 1

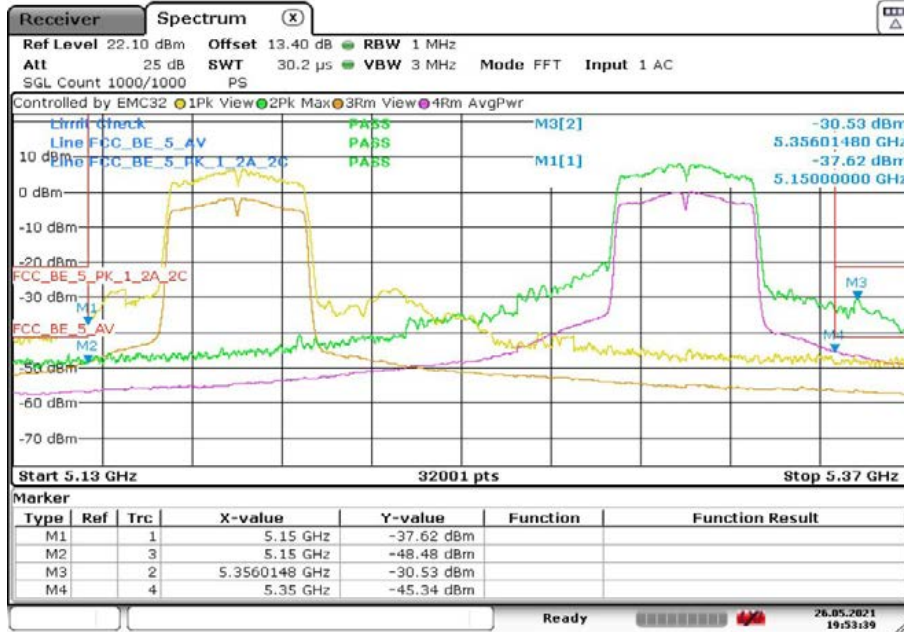

Date: 26.MAY.2021 19:53:39

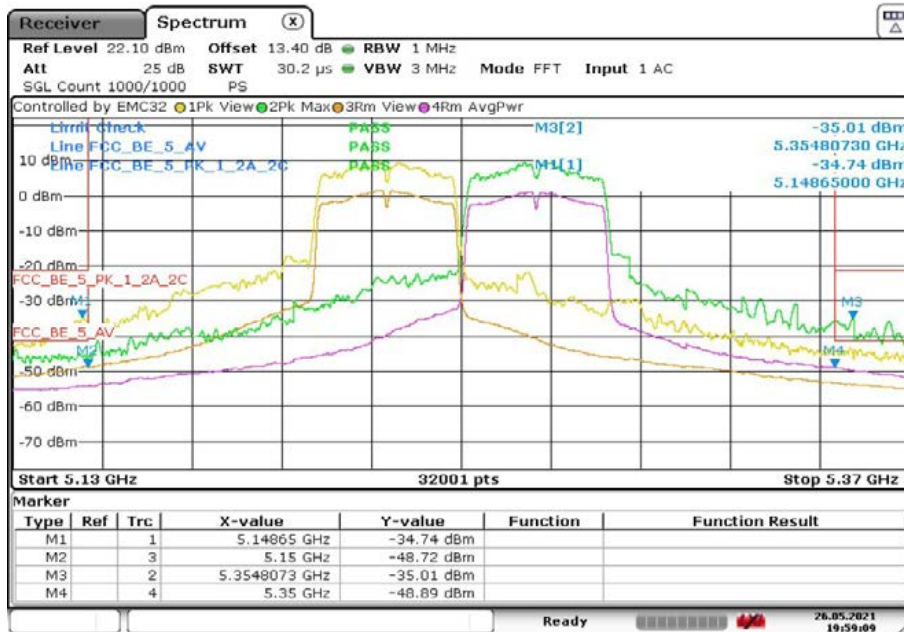

Date: 26.MAY.2021 19:59:09

Radio Technology = WLAN n 40 MHz MIMO, Subband = U-NII-2C (S01_AF01)

Antenna 0

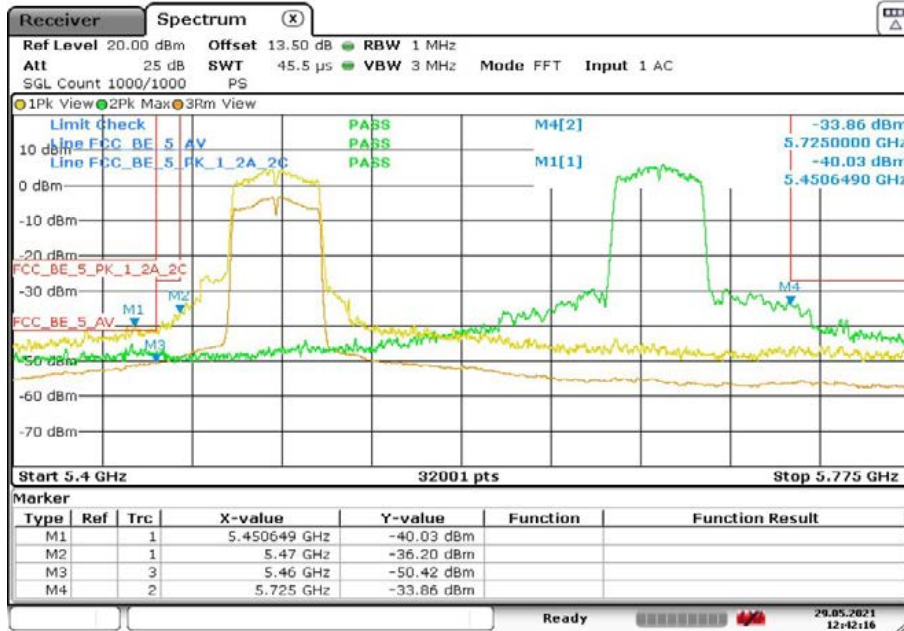

Date: 29.MAY.2021 12:42:16

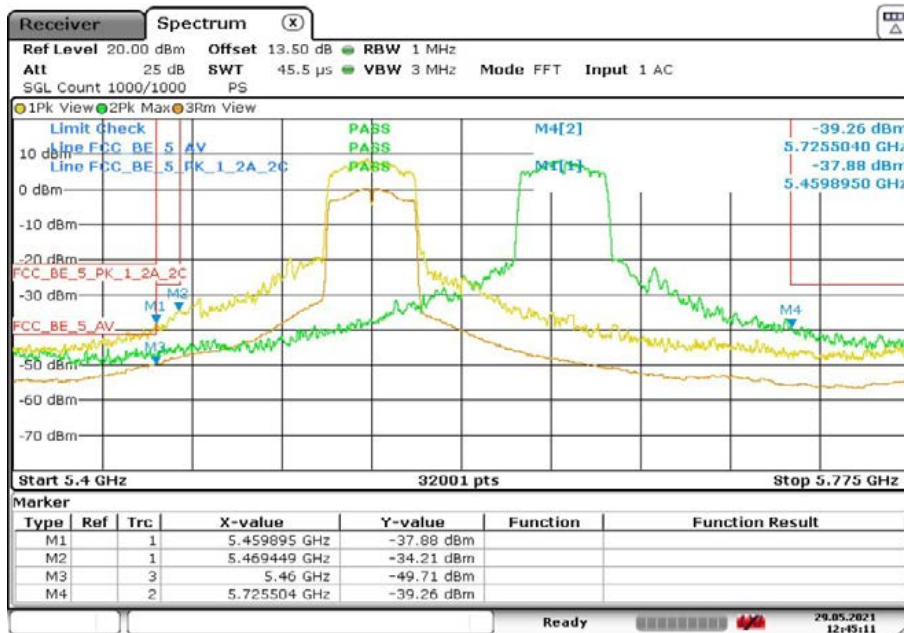

Date: 29.MAY.2021 12:45:11

Antenna 1

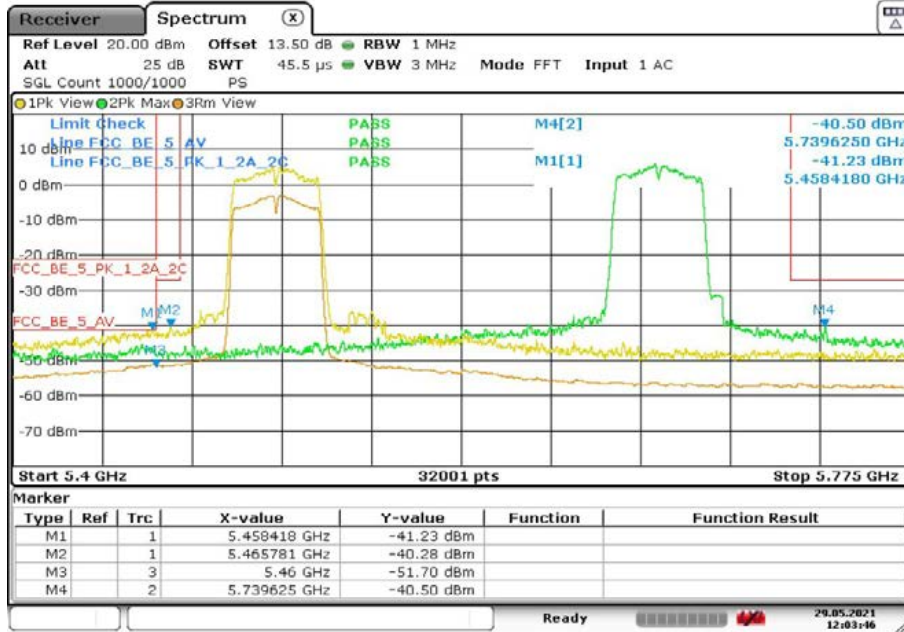

Date: 29.MAY.2021 12:03:46

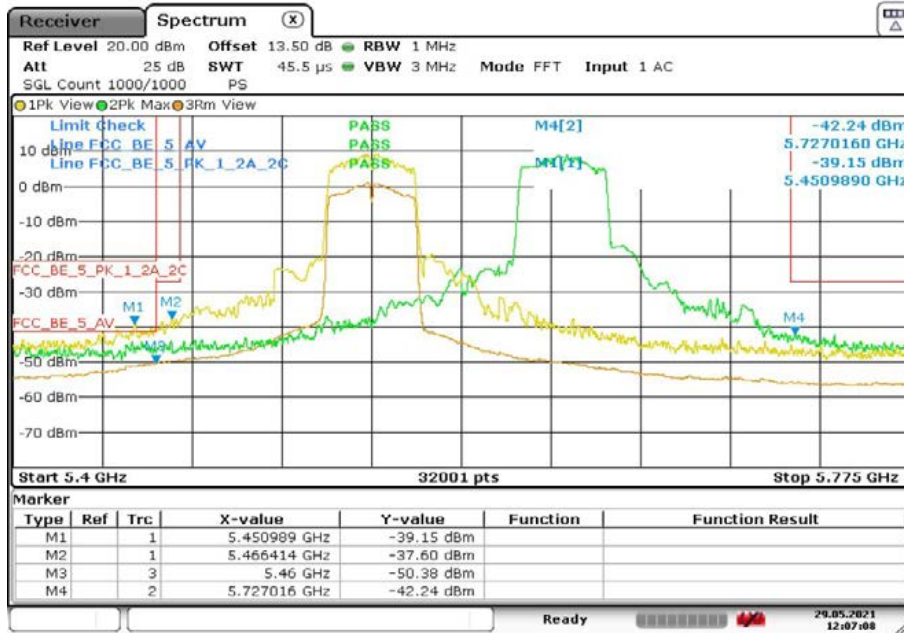

Date: 29.MAY.2021 12:07:08

Radio Technology = WLAN n 40 MHz MIMO, Subband = U-NII-3
(S01_AF01)

Antenna 0

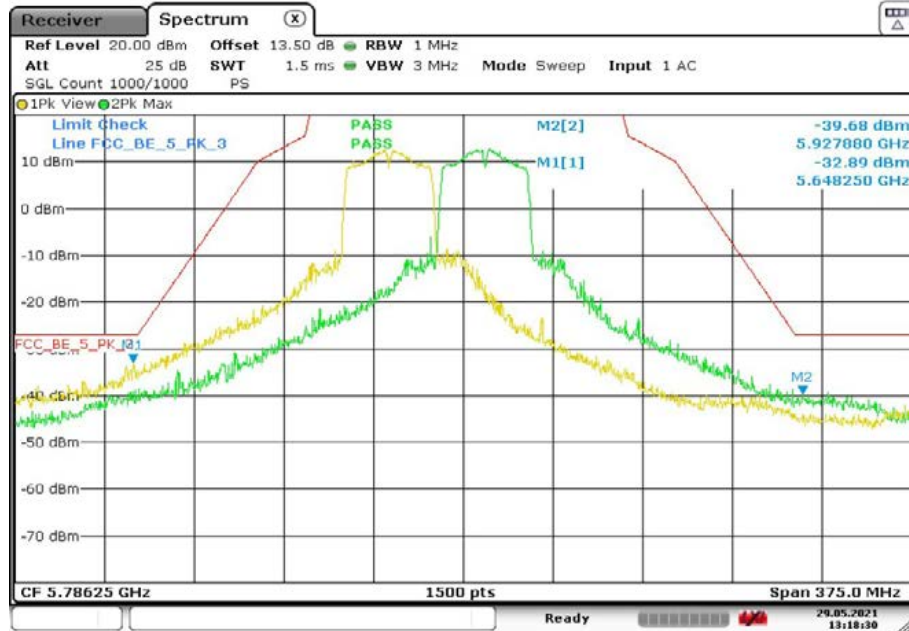

Date: 29.MAY.2021 13:18:31

Antenna 1

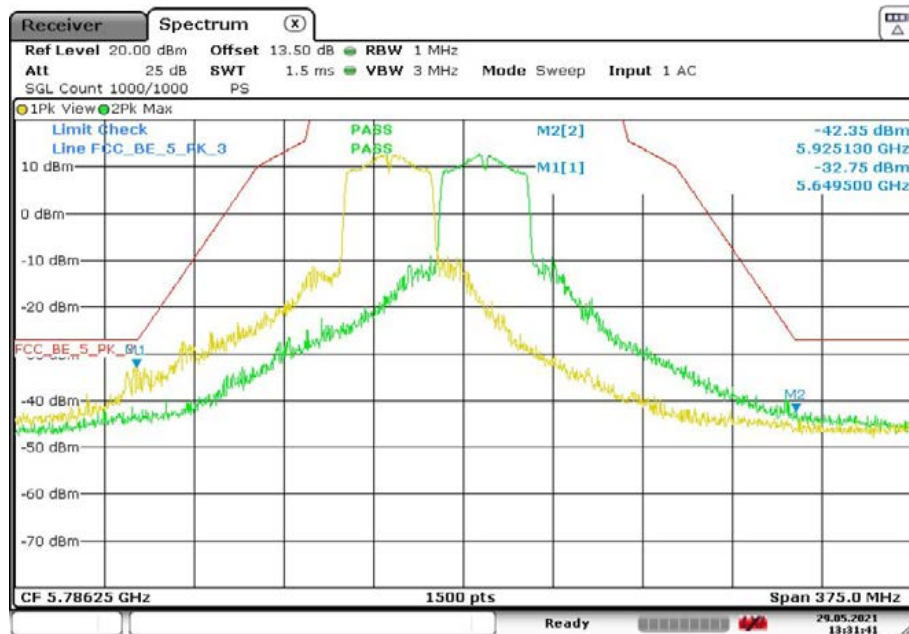

Date: 29.MAY.2021 13:31:42

Radio Technology = WLAN ac 20 MHz MIMO, Subband = U-NII-1/2A (S01_AE01)

Antenna 0

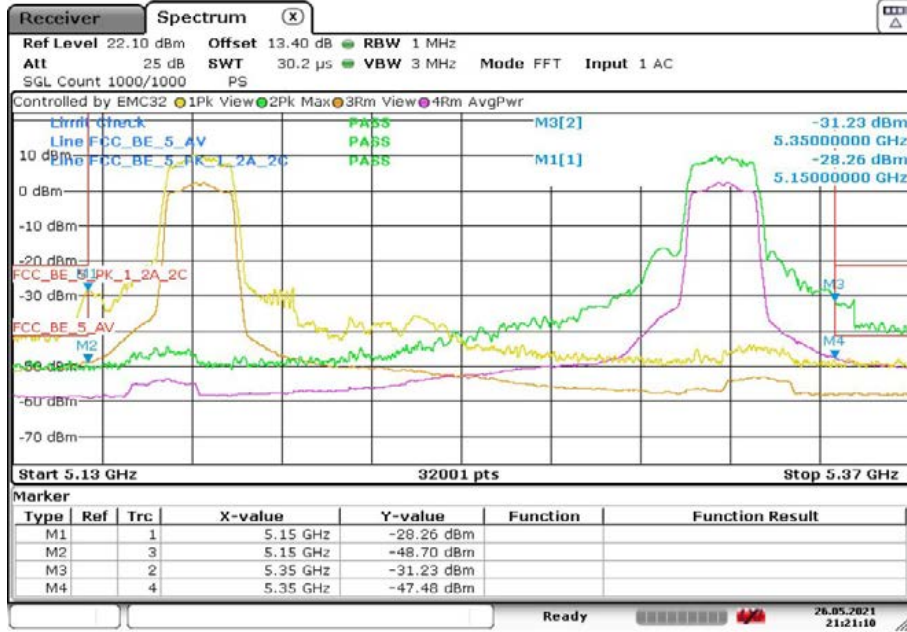

Date: 26.MAY.2021 21:21:10

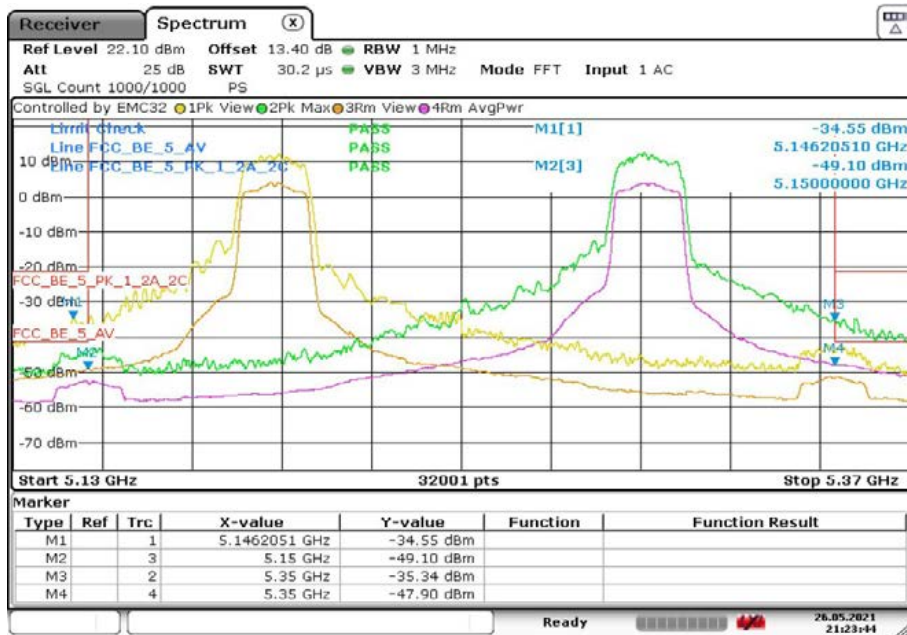

Date: 26.MAY.2021 21:23:44

Antenna 1

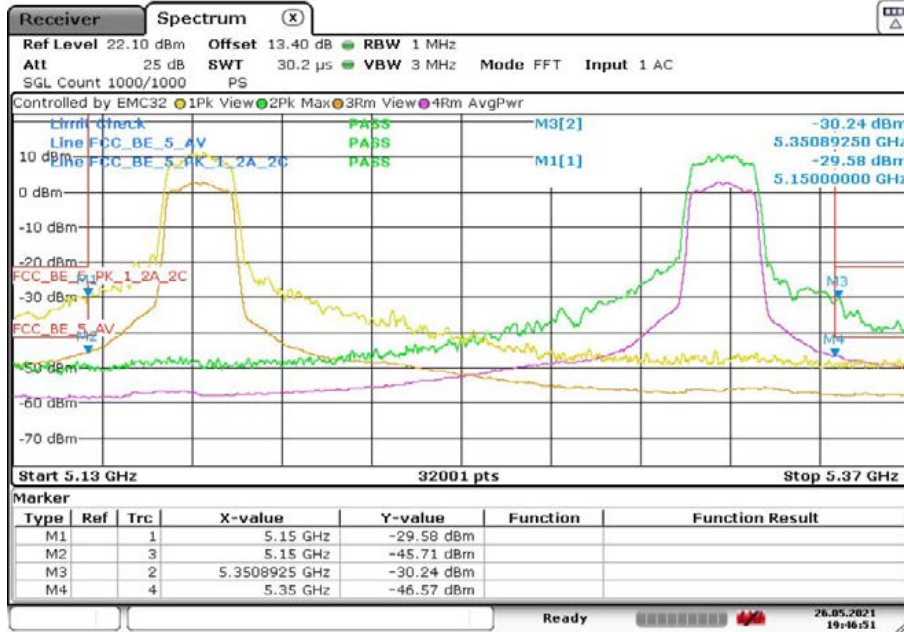

Date: 26.MAY.2021 19:46:51

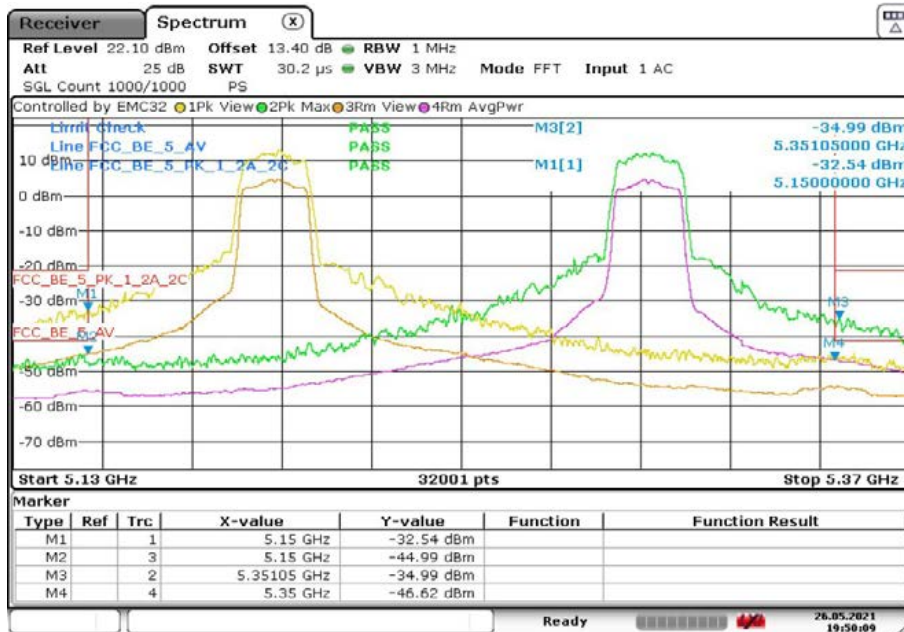

Date: 26.MAY.2021 19:50:10

Radio Technology = WLAN ac 20 MHz MIMO, Subband = U-NII-2C (S01_AF01)

Antenna 0

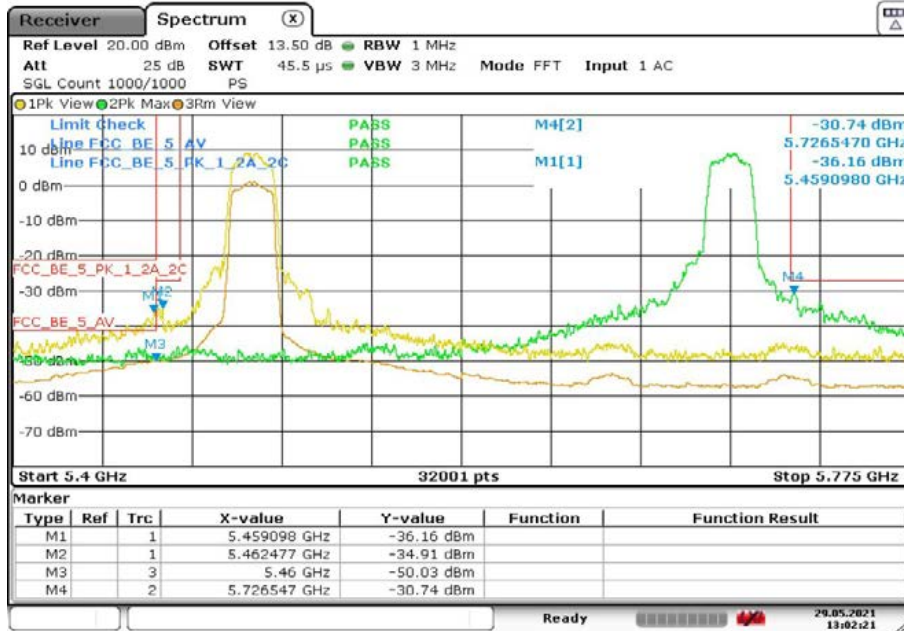

Date: 29.MAY.2021 13:02:21

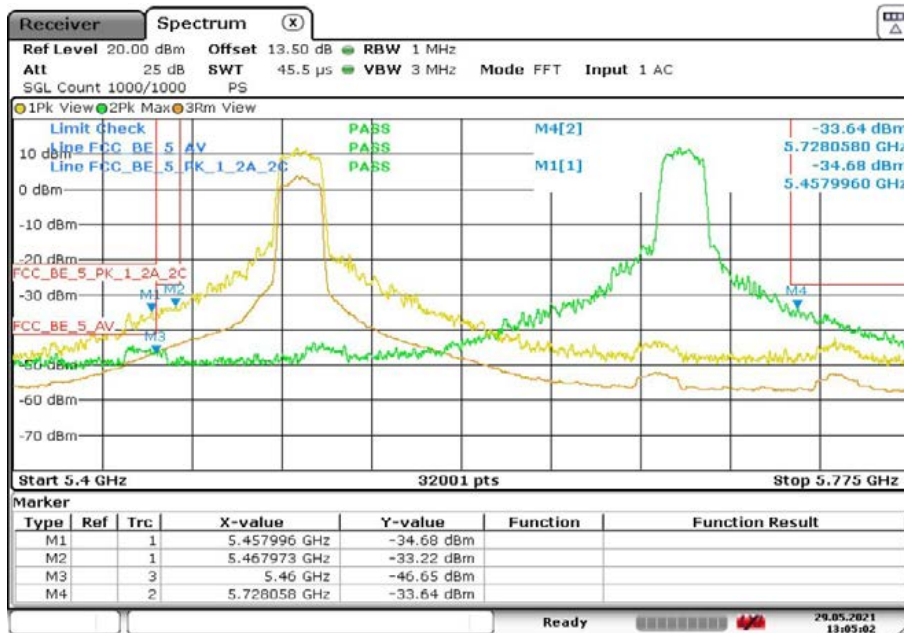

Date: 29.MAY.2021 13:05:02

Antenna 1

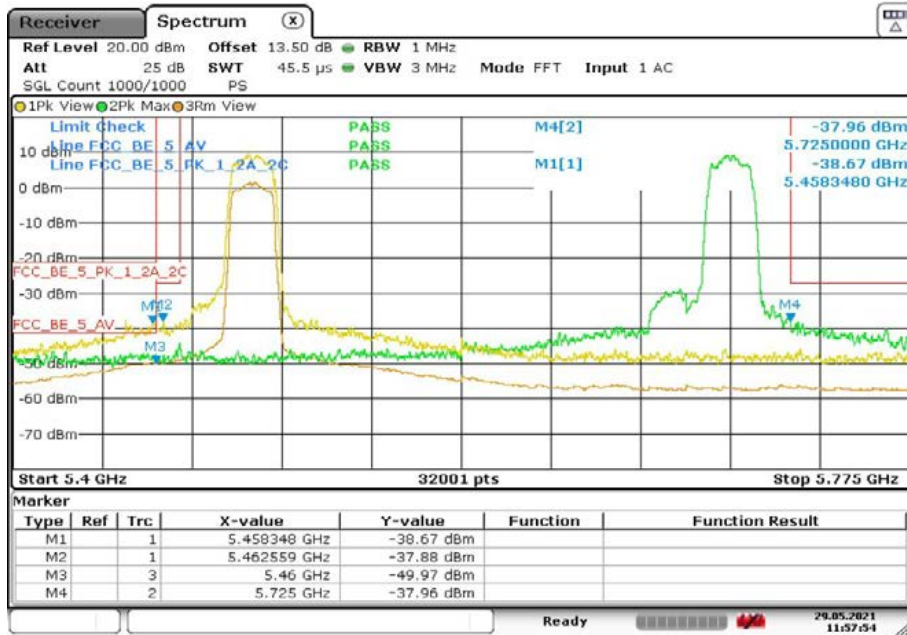

Date: 29.MAY.2021 11:57:53

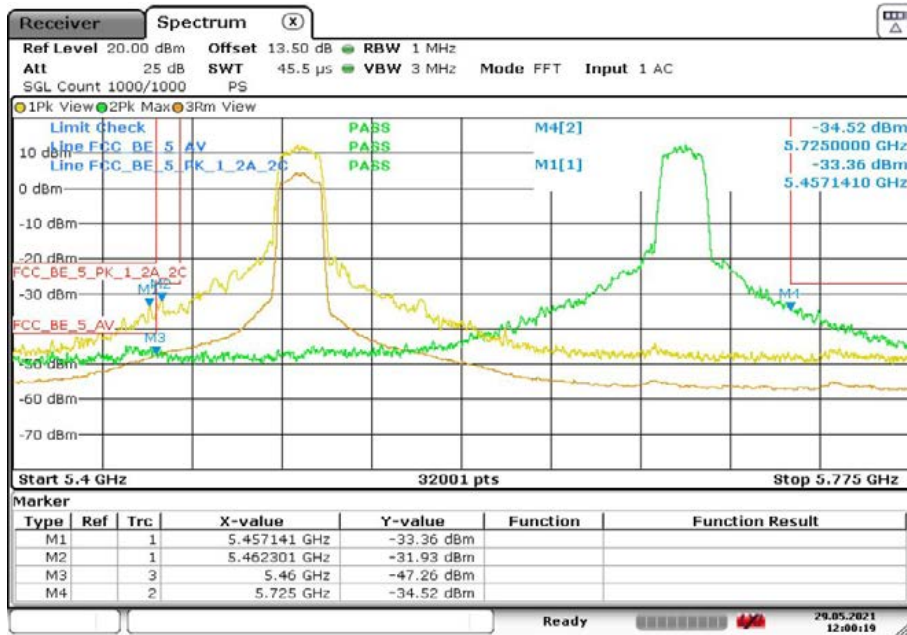

Date: 29.MAY.2021 12:00:19

Radio Technology = WLAN ac 20 MHz MIMO, Subband = U-NII-3
(S01_AF01)

Antenna 0

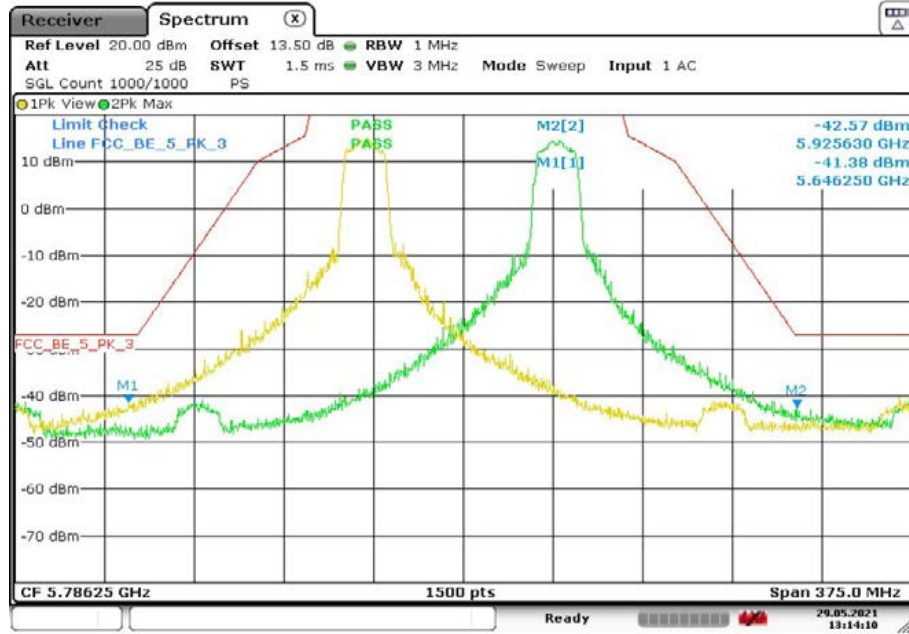

Date: 29.MAY.2021 13:14:10

Antenna 1

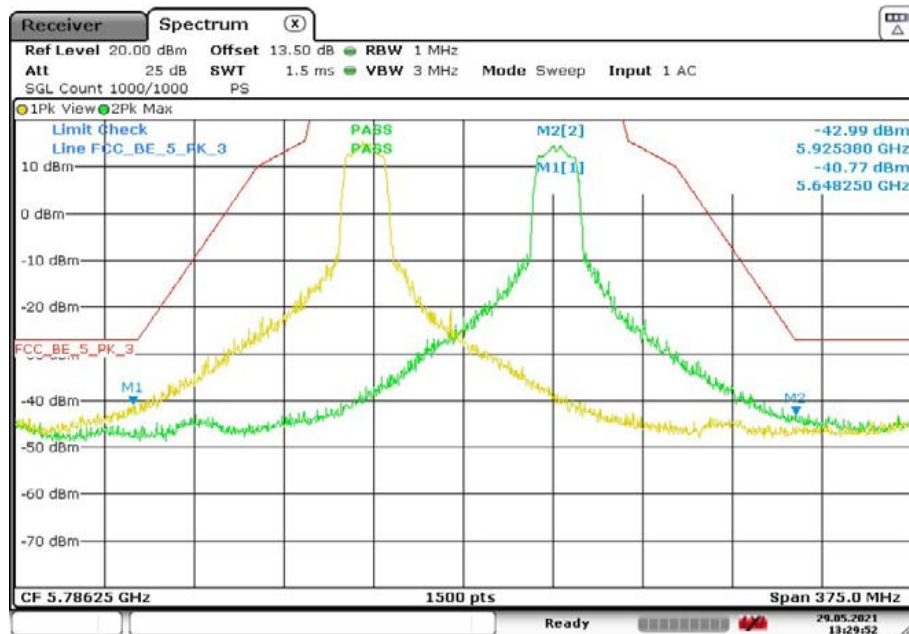

Date: 29.MAY.2021 13:29:53

Radio Technology = WLAN ac 40 MHz MIMO, Subband = U-NII-1/2A (S01_AE01)

Antenna 0

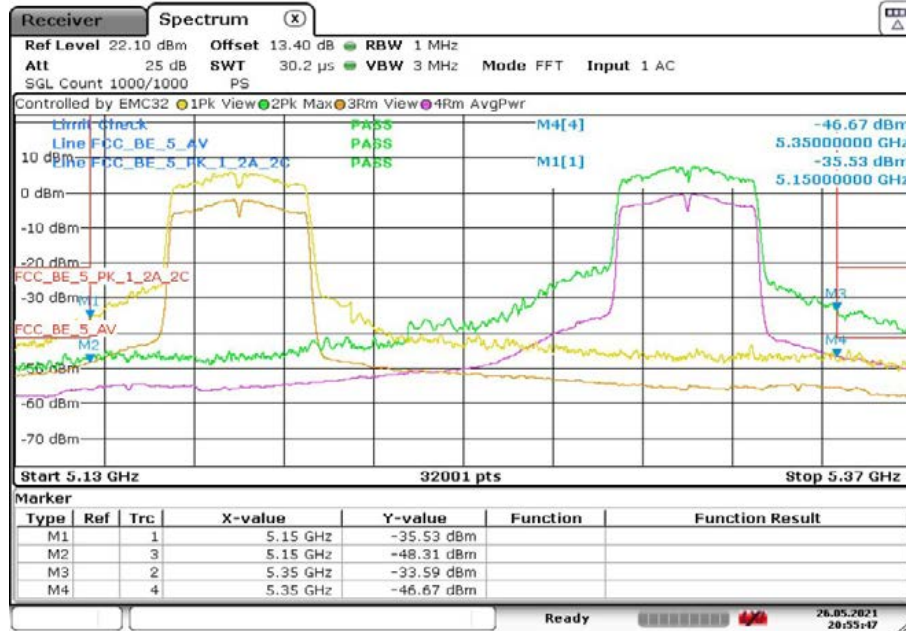

Date: 26.MAY.2021 20:55:47

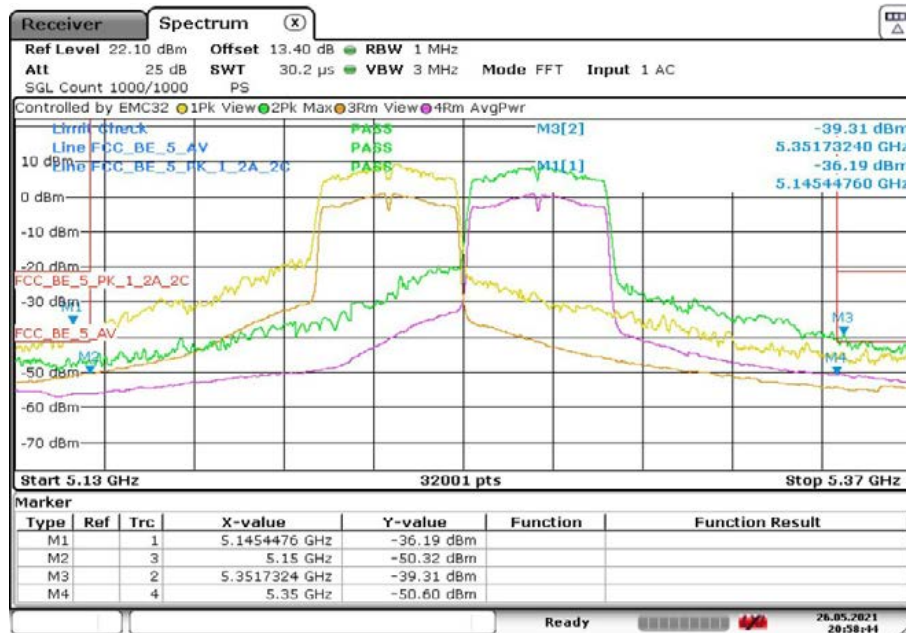

Date: 26.MAY.2021 20:58:44

Antenna 1

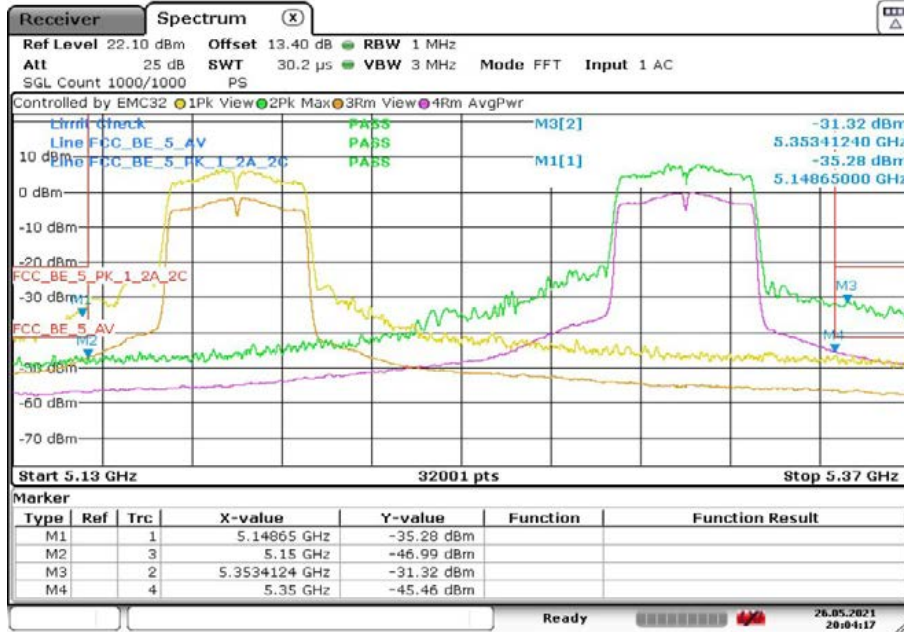

Date: 26.MAY.2021 20:04:17

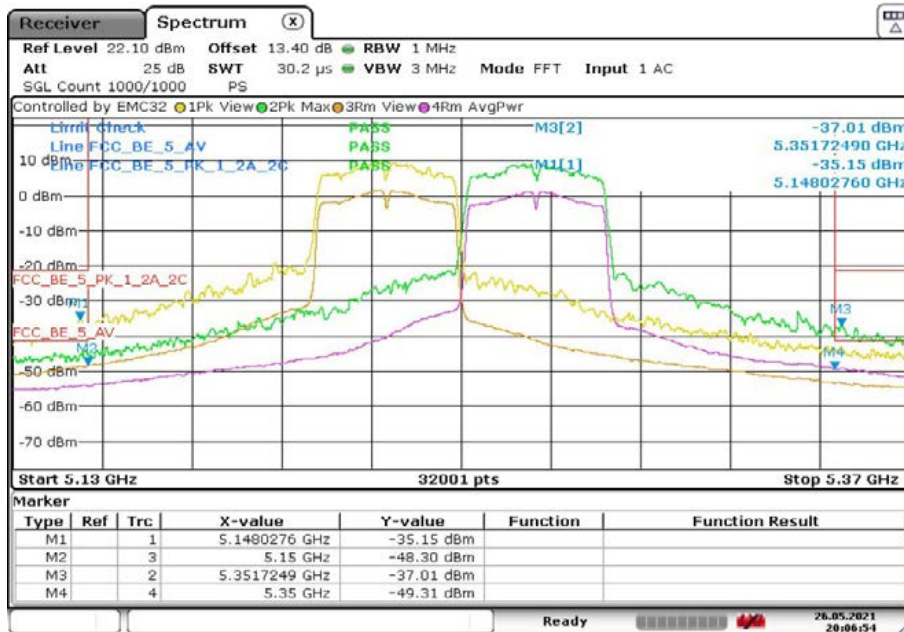

Date: 26.MAY.2021 20:06:54

Radio Technology = WLAN ac 40 MHz MIMO, Subband = U-NII-2C (S01_AF01)

Antenna 0

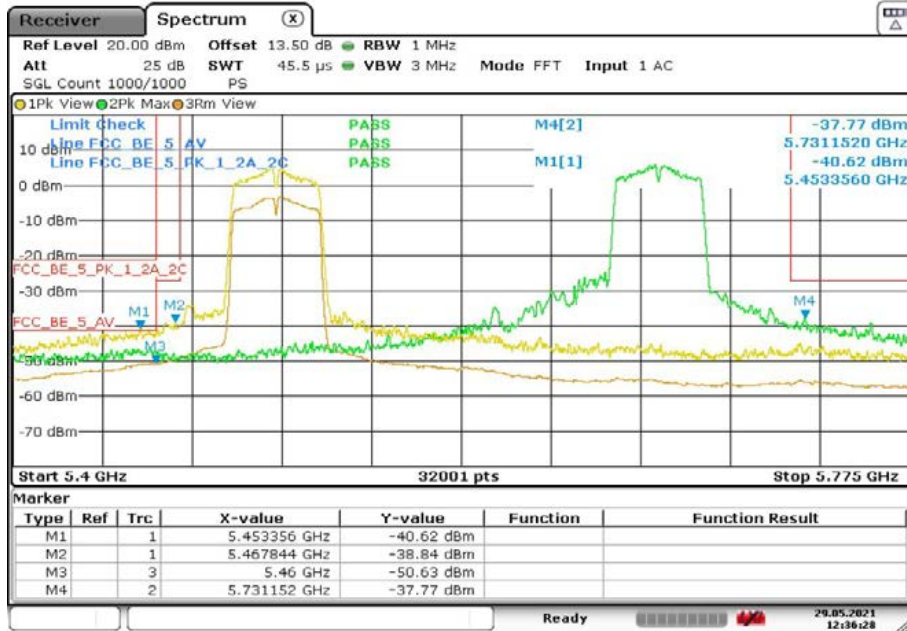

Date: 29.MAY.2021 12:36:28

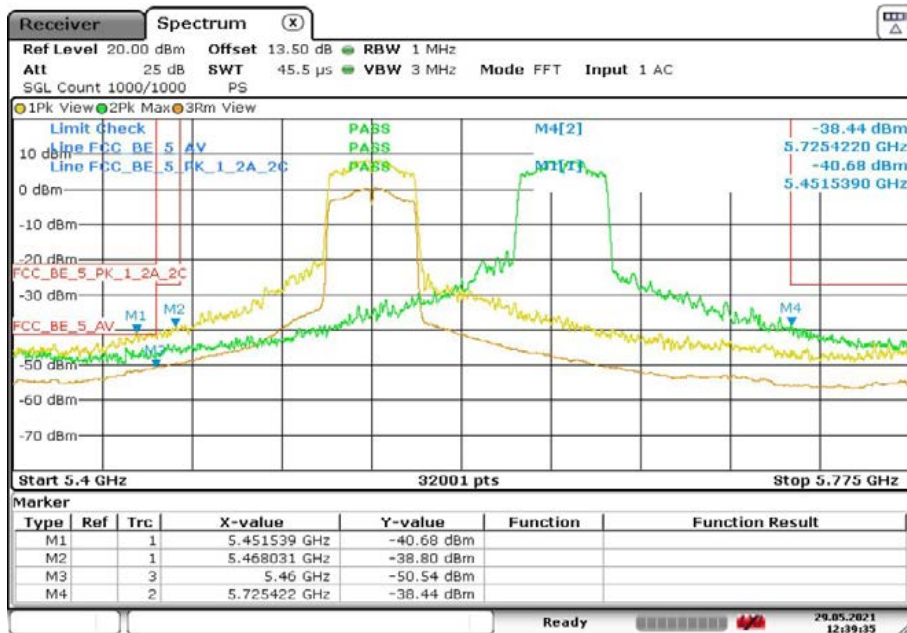

Date: 29.MAY.2021 12:39:35

Antenna 1

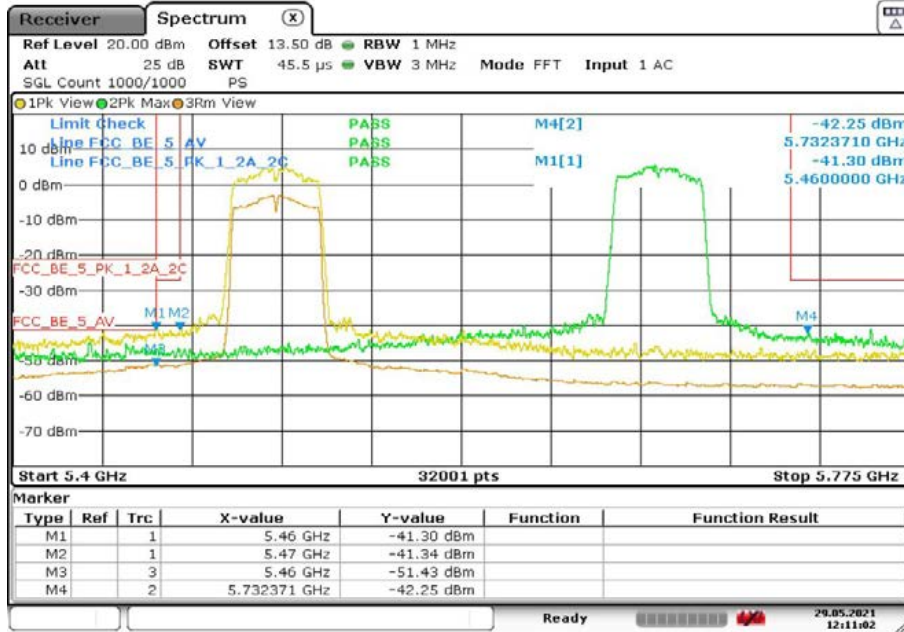

Date: 29.MAY.2021 12:11:01

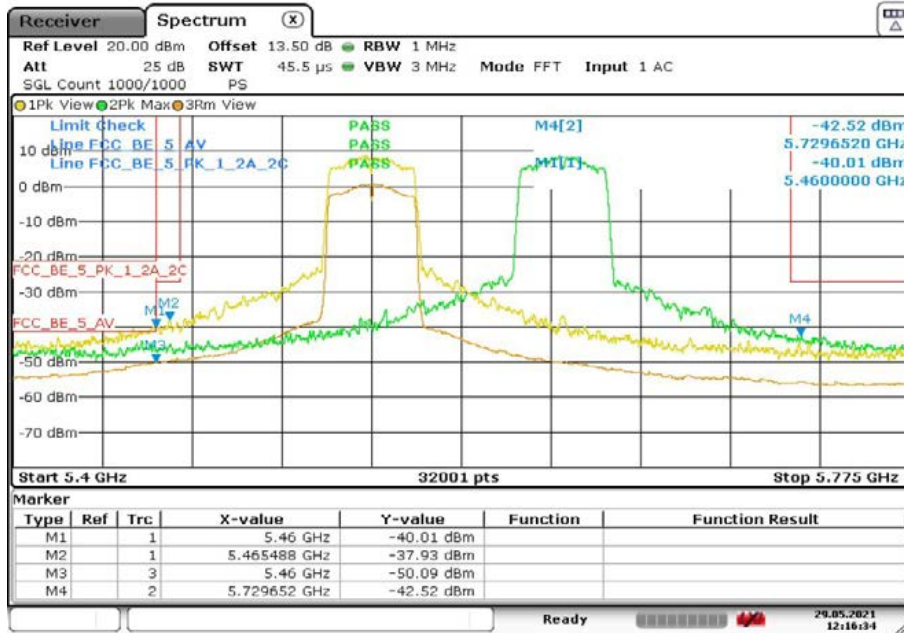

Date: 29.MAY.2021 12:16:35

Radio Technology = WLAN ac 40 MHz MIMO, Subband = U-NII-3
(S01_AF01)

Antenna 0

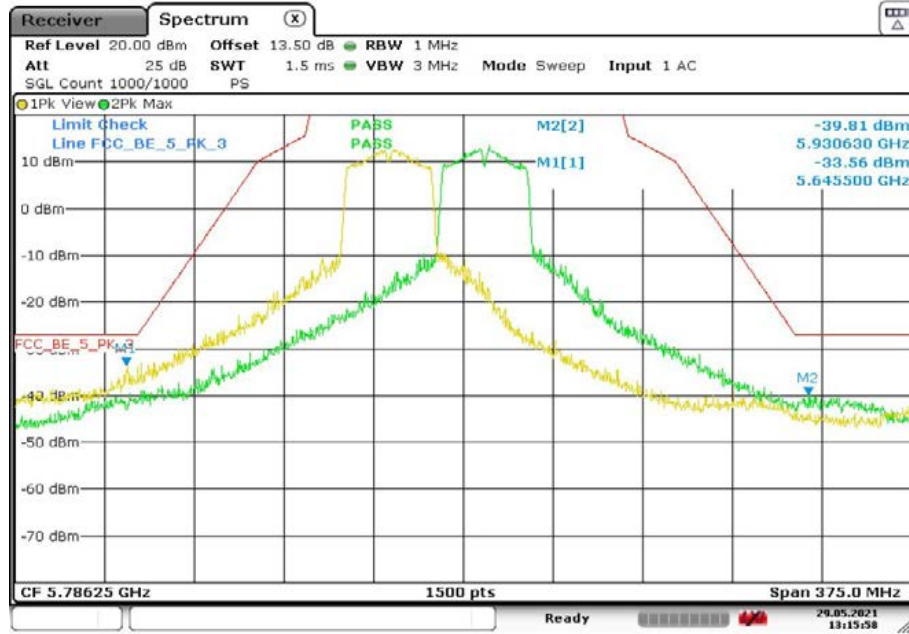

Date: 29.MAY.2021 13:15:59

Antenna 1

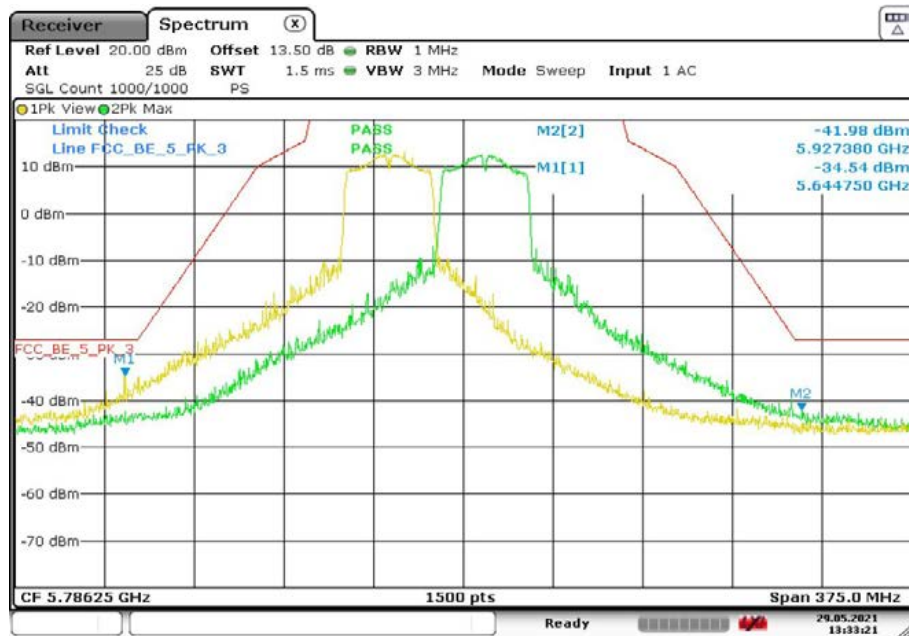

Date: 29.MAY.2021 13:33:22

Radio Technology = WLAN ac 80 MHz MIMO, Subband = U-NII-1/2A (S01_AE01)

Antenna 0

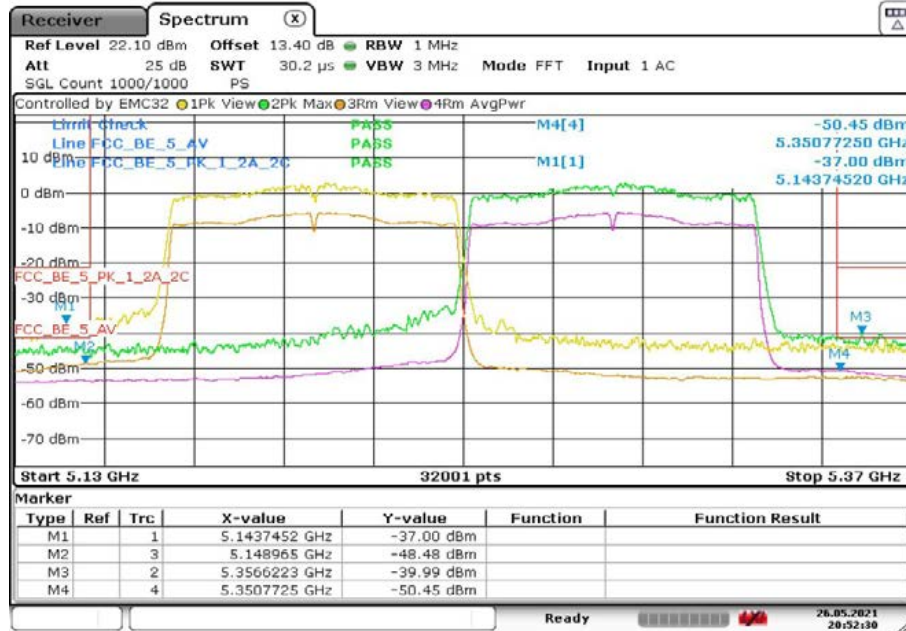

Date: 26.MAY.2021 20:52:30

Antenna 1

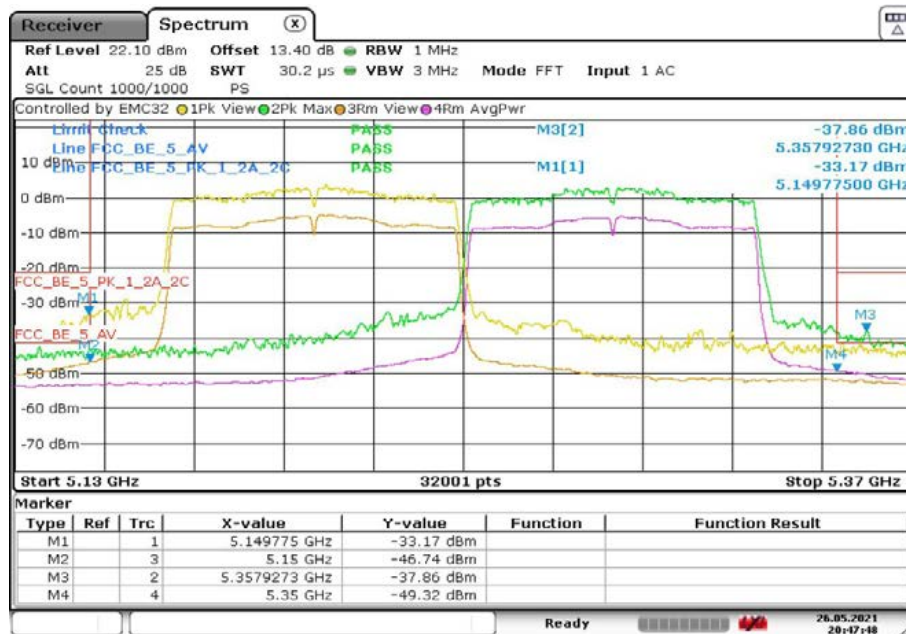

Date: 26.MAY.2021 20:47:48

Radio Technology = WLAN ac 80 MHz MIMO, Subband = U-NII-2C (S01_AF01)

Antenna 0

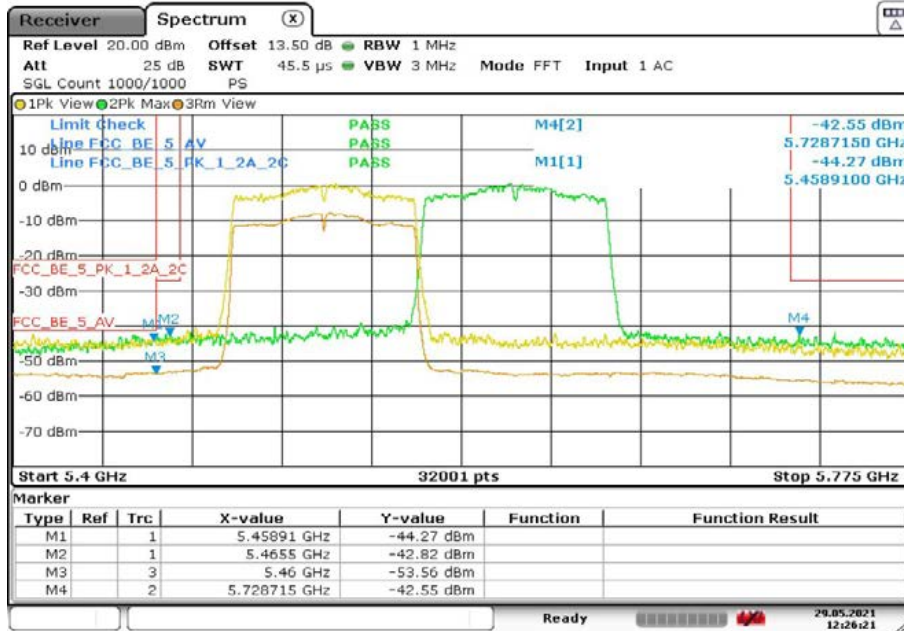

Date: 29.MAY.2021 12:26:21

Antenna 1

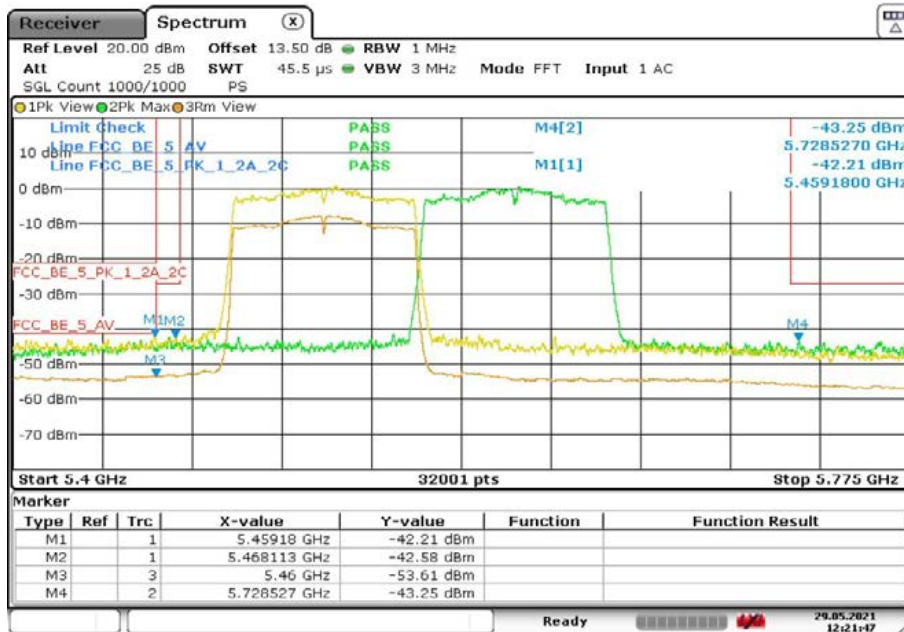

Date: 29.MAY.2021 12:21:47

Radio Technology = WLAN ac 80 MHz MIMO, Subband = U-NII-3
(S01_AF01)

Antenna 0



Antenna 1

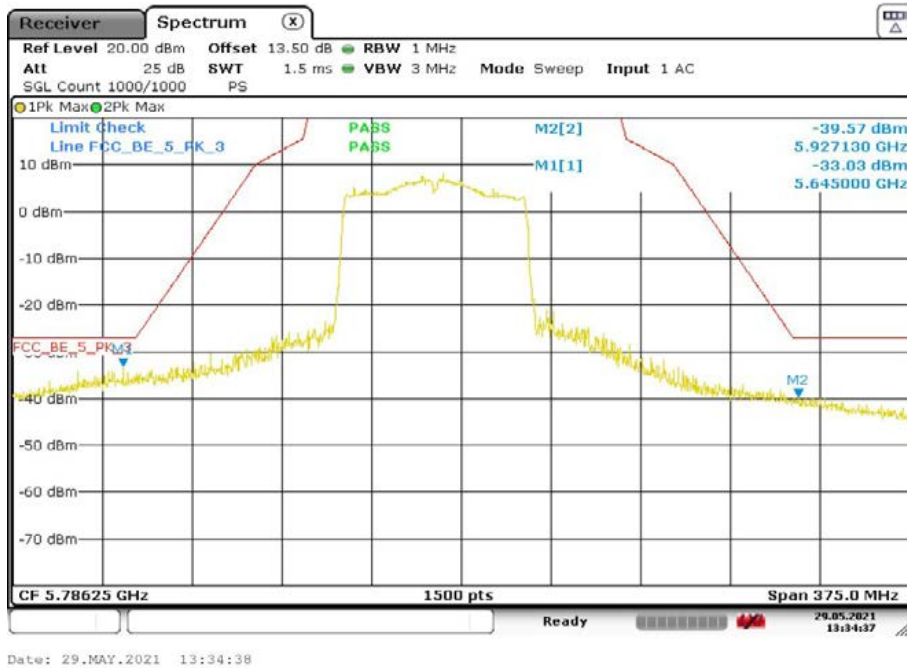

5.4.5 TEST EQUIPMENT USED

- R&S TS8997

5.5 UNDESIRABLE EMISSIONS; GENERAL FIELD STRENGTH LIMITS

Standard **FCC Part 15 Subpart E**

The test was performed according to:
ANSI C63.10

5.5.1 TEST DESCRIPTION

The test set-up was made in accordance to the general provisions of ANSI C63.10 in a typical installation configuration. The measurements were performed according the following sub-chapters of ANSI C63.10:

- < 30 MHz: Chapter 6.4
- 30 MHz – 1 GHz: Chapter 6.5
- > 1 GHz: Chapter 6.6 (procedure according 6.6.5 used)

The measurement procedure is implemented into the EMI test software EMC32 from R&S. Exploratory tests are performed at 3 orthogonal axes to determine the worst-case orientation of a body-worn or handheld EUT. The final test on all kind of EUTs is also performed at 3 axes. A pre-check is performed while the EUT is powered.

Below 1 GHz:

The Equipment Under Test (EUT) was set up on a non-conductive table in the semi-anechoic chamber. The influence of the EUT support table that is used between 30–1000 MHz was evaluated.

1. Measurement up to 30 MHz

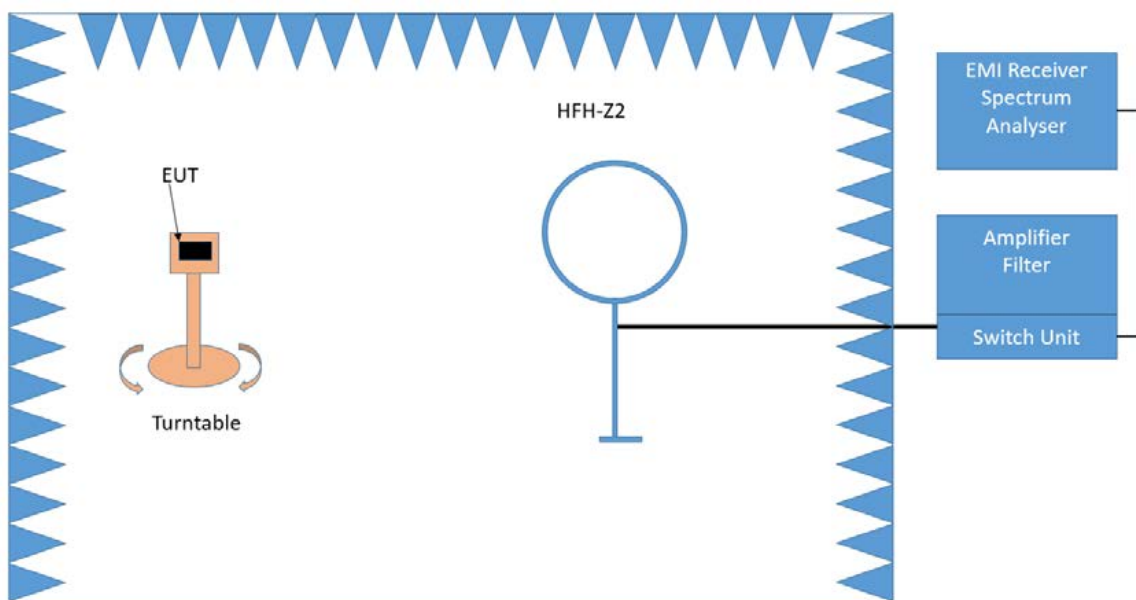

Test Setup; Spurious Emission Radiated (SAC), 9 kHz – 30 MHz

The Loop antenna HFH2-Z2 is used.

Step 1: pre measurement

- Anechoic chamber
- Antenna distance: 3 m
- Detector: Peak-Maxhold
- Frequency range: 0.009 - 0.15 MHz and 0.15 - 30 MHz
- Frequency steps: 0.05 kHz and 2.25 kHz
- IF-Bandwidth: 0.2 kHz and 9 kHz
- Measuring time / Frequency step: 100 ms (FFT-based)

Intention of this step is, to determine the radiated EMI-profile of the EUT. Afterwards the relevant emissions for the final measurement are identified.

Step 2: final measurement

For the relevant emissions determined in step 1, an additional measurement with the following settings will be performed. Intention of this step is to find the maximum emission level.

- Open area test site
- Antenna distance: according to the Standard
- Detector: Quasi-Peak
- Frequency range: 0.009 - 30 MHz
- Frequency steps: measurement at frequencies detected in step 1
- IF-Bandwidth: 0.2 - 10 kHz
- Measuring time / Frequency step: 1 s

2. Measurement above 30 MHz and up to 1 GHz

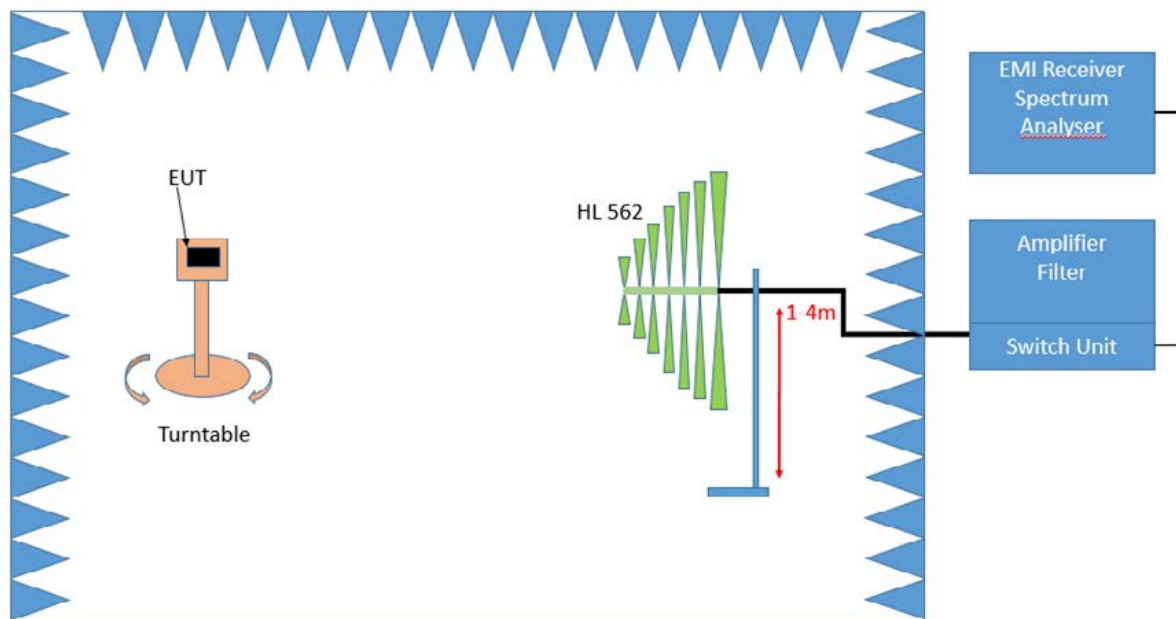

Test Setup; Spurious Emission Radiated (SAC), 30 MHz- 1GHz

Step 1: Preliminary scan

This is a preliminary test to identify the highest amplitudes relative to the limit.

Settings for step 1:

- Antenna distance: 3 m
- Detector: Peak-Maxhold / Quasipeak (FFT-based)
- Frequency range: 30 - 1000 MHz
- Frequency steps: 30 kHz
- IF-Bandwidth: 120 kHz
- Measuring time / Frequency step: 100 ms

- Turntable angle range: -180° to 90°
- Turntable step size: 90°
- Height variation range: 1 – 4 m
- Height variation step size: 1.5 m
- Polarisation: Horizontal + Vertical

Intention of this step is, to determine the radiated EMI-profile of the EUT. Afterwards the relevant emissions for the final measurement are identified.

Step 2: Adjustment measurement

In this step the accuracy of the turntable azimuth and antenna height will be improved. This is necessary to find out the maximum value of every frequency.

For each frequency, which was determined the turntable azimuth and antenna height will be adjusted. The turntable azimuth will slowly vary by 360° around this value. During this action, the value of emission is continuously measured. The turntable azimuth at the highest emission will be recorded and adjusted. In this position, the antenna height will also slowly vary between 1 and 4 m. During this action, the value of emission is also continuously measured. The antenna height of the highest emission will also be recorded and adjusted.

- Detector: Peak – Maxhold
- Measured frequencies: in step 1 determined frequencies
- IF – Bandwidth: 120 kHz
- Measuring time: 100 ms
- Turntable angle range: 360°
- Height variation range: 1 – 4 m
- Antenna Polarisation: max. value determined in step 1

Step 3: Final measurement with QP detector

With the settings determined in step 2, the final measurement will be performed:

EMI receiver settings for step 3:

- Detector: Quasi-Peak (< 1 GHz)
- Measured frequencies: in step 1 determined frequencies
- IF – Bandwidth: 120 kHz
- Measuring time: 1 s

After the measurement a plot will be generated which contains a diagram with the results of the preliminary scan and a chart with the frequencies and values of the results of the final measurement.

Above 1 GHz:

The Equipment Under Test (EUT) was set up on a non-conductive support (tilt device) at 1.5 m height in the fully-anechoic chamber.

All steps were performed with one height (1.5 m) of the receiving antenna only.

3. Measurement 1 GHz up to 26.5 GHz

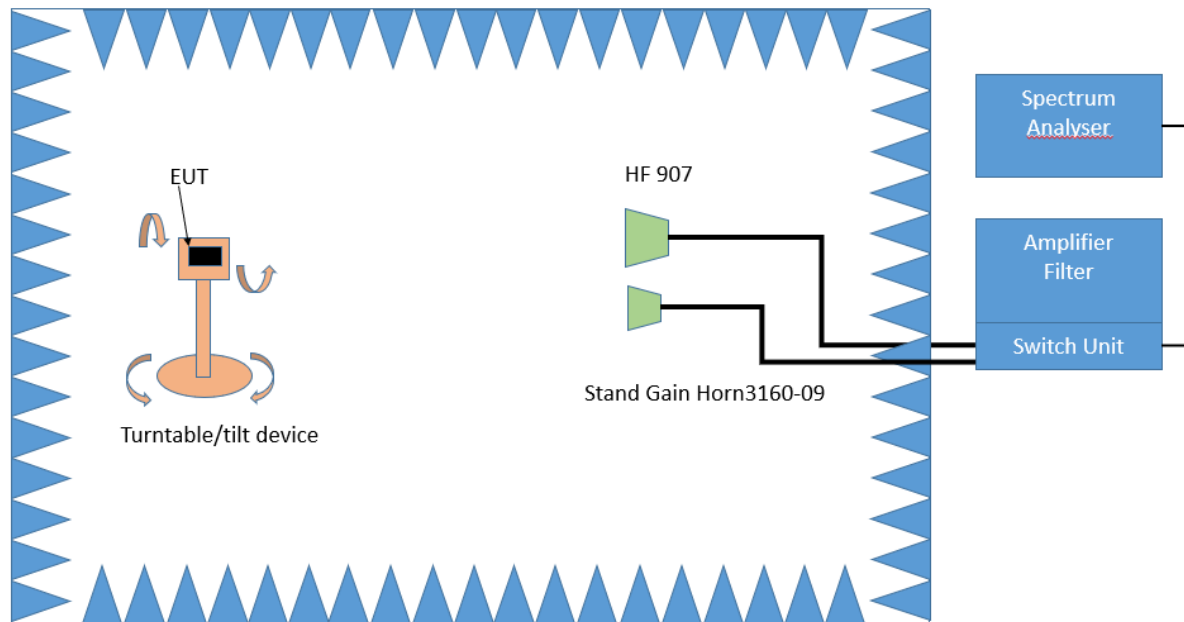

Test Setup; Spurious Emission Radiated (FAC), 1 GHz-26.5 GHz

Step 1:

The Equipment Under Test (EUT) was set up on a non-conductive support (tilt device) at 1.5 m height in the fully-anechoic chamber.

All steps were performed with one height (1.5 m) of the receiving antenna only.

The EUT is turned during the preliminary measurement across the elevation axis, with a step size of 90 °.

The turn table step size (azimuth angle) for the preliminary measurement is 45 °.

Step 2:

Due to the fact, that in this frequency range the test is performed in a fully anechoic room, the height scan of the receiving antenna instep 2 is omitted. Instead of this, a maximum search with a step size $\pm 45^\circ$ for the elevation axis is performed.

The turn table azimuth will slowly vary by $\pm 22.5^\circ$.

The elevation angle will slowly vary by $\pm 45^\circ$

EMI receiver settings (for all steps):

- Detector: Peak, Average
- IF Bandwidth = 1 MHz

Step 3:

Spectrum analyser settings for step 3:

- Detector: Peak / Average
- Measured frequencies: in step 1 determined frequencies
- IF – Bandwidth: 1 MHz
- Measuring time: 1 s

4. Measurement above 26.5 GHz up to 40 GHz

The following modifications, compared to the frequency range 1 GHz – 26.5 GHz, apply to the measurement procedure for the frequency range above 26.5 GHz:

- Measurement distance: 1m

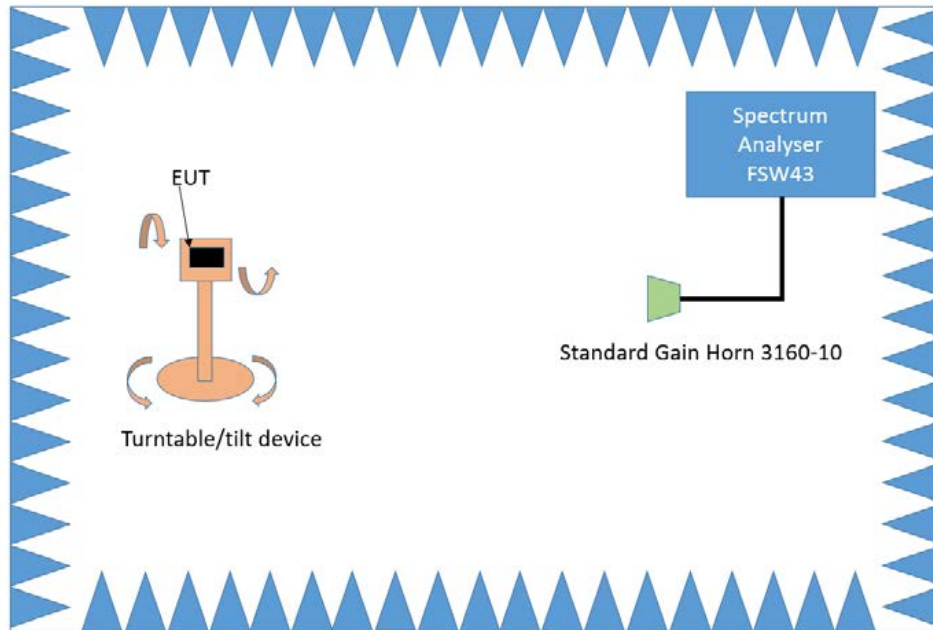

Test Setup; Spurious Emission Radiated (FAC), 26.5 – 40 GHz

5.5.2 TEST REQUIREMENTS / LIMITS

A) FCC

FCC Part 15 Subpart E, §15.407 (b)(1)

For transmitters operating in the 5150–5250 MHz band:

Limit: –27 dBm/MHz EIRP outside of the band 5150–5350 MHz.

FCC Part 15 Subpart E, §15.407 (b)(2)

For transmitters operating in the 5250–5350 MHz band:

Limit: –27 dBm/MHz EIRP outside of the band 5150–5350 MHz.

FCC Part 15 Subpart E, §15.407 (b)(3)

For transmitters operating in the 5470–5725 MHz band:

Limit: –27 dBm/MHz EIRP outside of the band 5470–5725 MHz.

FCC Part 15 Subpart E, §15.407 (b)(4)

For transmitters operating in the 5725–5850 MHz band:

Limit: –27 dBm/MHz at 75 MHz or more above or below the band edge
 increasing linearly to 10 dBm/MHz at 25 MHz above or below the band edge
 increasing linearly to 15.6 dBm/MHz at 5 MHz above or below the band edge
 increasing linearly to 27 dBm/MHz at the band edge.

B) IC

Different frequency bands and limits apply, as compared to the FCC requirements.

RSS-247, 6.2.1.2, Emissions outside the band 5150-5250 MHz, indoor operation only:
Limit: -27 dBm/MHz EIRP outside of the band 5150-5250 MHz.

RSS-247, 6.2.2.2, Emissions outside the band 5250-5350 MHz:
Limit: -27 dBm/MHz EIRP outside of the band 5250-5350 MHz.

RSS-247, 6.2.3.2, Emissions outside the bands 5470-5600 MHz and 5650-5725 MHz:
Limit: -27 dBm/MHz EIRP outside of the band 5470-5725 MHz.
However, devices with bandwidth overlapping the band edge of 5725 MHz can meet the emission limit of -27 dBm/MHz e.i.r.p. at 5850 MHz instead of 5725 MHz.
Note: No operation is permitted for the frequency range 5600-5650 MHz.

RSS-247, 6.2.4.2, Emissions outside the band 5725-5850 MHz:

- 27 dBm/MHz at frequencies from the band edges decreasing linearly to 15.6 Bm/MHz at 5 MHz above or below the band edges;
- 15.6 dBm/MHz at 5 MHz above or below the band edges decreasing linearly to 10 dBm/MHz at 25 MHz above or below the band edges;
- 10 dBm/MHz at 25 MHz above or below the band edges decreasing linearly to -27 dBm/MHz at 75 MHz above or below the band edges; and
- 27 dBm/MHz at frequencies more than 75 MHz above or below the band edges.

C) FCC & IC

FCC Part 15 Subpart E, §15.405
The provisions of §§ 15.203 and 15.205 are included.

§15.407 (b)(6)
Unwanted emissions below 1 GHz must comply with the general field strength limits set forth in § 15.209.

§15.407 (b)(7)
The provisions of §15.205 apply to intentional radiators operating under this section

FCC Part 15, Subpart C, §15.209, Radiated Emission Limits

Frequency in MHz	Limit ($\mu\text{V}/\text{m}$)	Measurement distance (m)	Limits ($\text{dB}\mu\text{V}/\text{m}$)
0.009 - 0.49	2400/F(kHz)@300m	3	(48.5 - 13.8)@300m
0.49 - 1.705	24000/F(kHz)@30m	3	(33.8 - 23.0)@30m
1.705 - 30	30@30m	3	29.5@30m

The measured values are corrected with an inverse linear distance extrapolation factor (40 dB/decade) according FCC 15.31 (2).

Frequency in MHz	Limit ($\mu\text{V}/\text{m}$)	Measurement distance (m)	Limits ($\text{dB}\mu\text{V}/\text{m}$)
30 - 88	100@3m	3	40.0@3m
88 - 216	150@3m	3	43.5@3m
216 - 960	200@3m	3	46.0@3m
960 - 26000	500@3m	3	54.0@3m
26000 - 40000	500@3m	1	54.0@3m

The measured values above 26 GHz are corrected with an inverse linear distance extrapolation factor (20 dB/decade).

§15.35(b) ..., there is also a limit on the radio frequency emissions, as measured using instrumentation with a peak detector function, corresponding to 20 dB above the maximum permitted average limit....

Used conversion factor:

- Limit (dBµV/m) = 20 log (Limit (µV/m)/1µV/m)
- Limit (dBµV/m) = EIRP [dBm] - 20 log (d [m]) + 104.8

Limit types (in result tables on next page):

RB – Emissions falls into a “Restricted Band” according FCC §§15.205 and 15.209 *)

UE – “Undesirable Emission Limit” according FCC §15.407

BE-RB – Band Edge Limit basing on “Restricted Band Limits”

BE-UE – Band Edge Limit basing on “Undesirable Emission Limit”

*) Below 1 GHz the limits of §15.209 are applied for all frequencies.

5.5.3 TEST PROTOCOL

Ambient temperature: 22–26 °C
 Air Pressure: 1002–1024 hPa
 Humidity: 32–44 %
 WLAN a-Mode; 20 MHz; 6 Mbit/s
 Applied duty cycle correction (AV): 0 dB

Ch. No.	Ch. Center Freq. [MHz]	Spurious Freq. [MHz]	Spurious Level [dBµV/m]	Detector	RBW [kHz]	Limit [dBµV/m]	Margin [dB]	Limit Type
36	5180	-	-	Peak	-	-	>6	-

Remark: Only the worst case of the original certification was repeated in the range 1-26 GHz.

5.5.4 MEASUREMENT PLOTS

Radio Technology = WLAN a, Operating Frequency = low, Measurement range = 1GHz - 26GHz, Subband = U-NII-1 (S02_AF01)

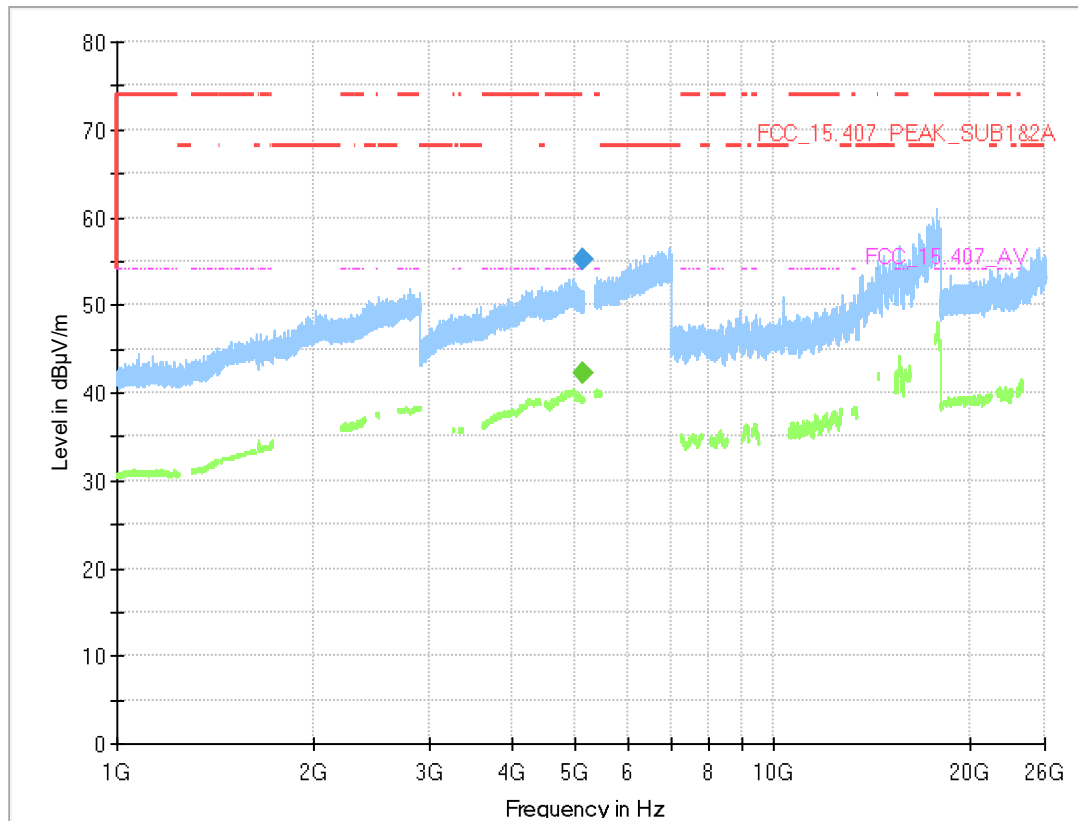

Final_Result

Frequency (MHz)	MaxPeak (dBµV/m)	CAverage (dBµV/m)	Limit (dBµV/m)	Margin (dB)	Meas. Time (ms)	Bandwidth (kHz)	Height (cm)	Pol	Azimuth (deg)	Elevation (deg)	Corr. (dB/m)
5148.050	---	42.3	54.00	11.70	1000.0	1000.000	150.0	V	-127.0	97.0	13.2
5148.050	55.2	---	74.00	18.78	1000.0	1000.000	150.0	H	-124.0	-12.0	13.2

Plot of initial certification:

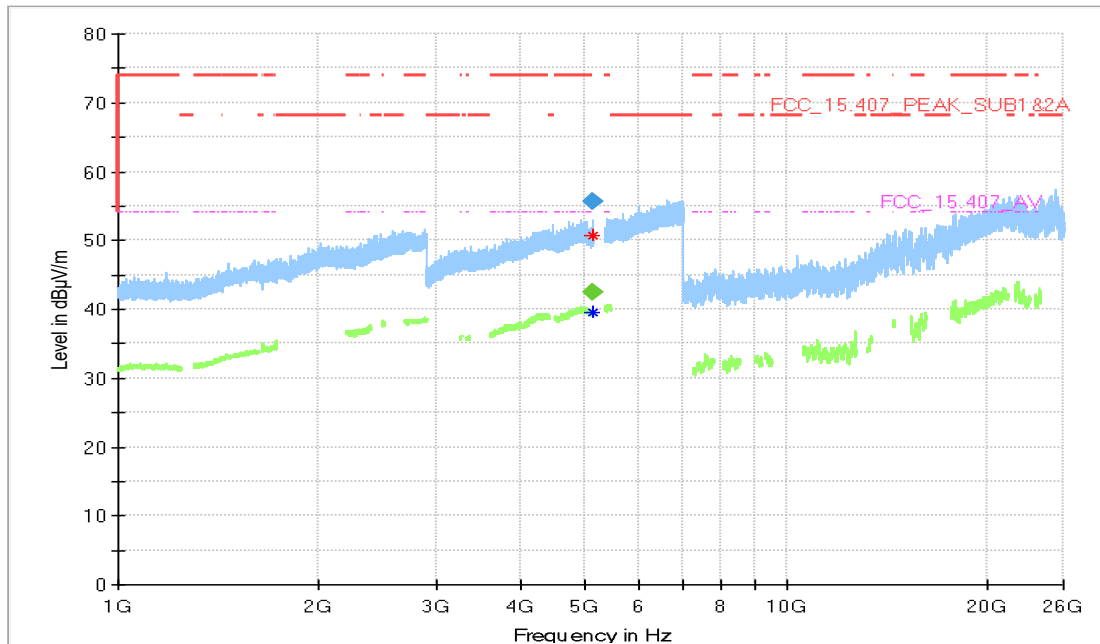

Final_Result

Frequency (MHz)	MaxPeak (dBµV)	CAverage (dBµV)	Limit (dBµV /m)	Margin (dB)	Meas. Tim	Bandwidth (kHz)	Height (cm)	Pol	Azimuth (deg)	Elevation (deg)
5149.188	55.5	---	74.00	18.4	1000	1000.0	150.	H	-	-12.0
5149.675	---	42.3	54.00	11.6	1000	1000.0	150.	V	37.0	-12.0

5.5.5 TEST EQUIPMENT USED

- Radiated Emissions

6 TEST EQUIPMENT

- 1 R&S TS8997
2.4 and 5 GHz Bands Conducted Test Lab

Ref.No.	Device Name	Description	Manufacturer	Serial Number	Last Calibration	Calibration Due
1.1	FSV30	Signal Analyzer 10 Hz - 30 GHz	Rohde & Schwarz	103005	2020-05	2022-05
1.2	Opus10 THI (8152.00)	T/H Logger 15	Lufft Mess- und Regeltechnik GmbH	13985	2019-06	2021-06
1.3	ESR7	EMI Receiver / Spectrum Analyzer	Rohde & Schwarz	101424	2021-01	2023-01
1.4	Opus10 THI (8152.00)	T/H Logger 14	Lufft Mess- und Regeltechnik GmbH	13993	2019-06	2021-06
1.5	OSP120	Contains Power Meter and Switching Unit OSP-B157W8	Rohde & Schwarz	101158	2018-05	2021-05

- 2 Radiated Emissions
Lab to perform radiated emission tests

Ref.No.	Device Name	Description	Manufacturer	Serial Number	Last Calibration	Calibration Due
2.1	MFS	Rubidium Frequency Normal MFS	Datum GmbH	002	2020-11	2021-11
2.2	Opus10 TPR (8253.00)	T/P Logger 13	Lufft Mess- und Regeltechnik GmbH	13936	2019-05	2021-05
2.3	AMF-7D00101800-30-10P-R	Broadband Amplifier 100 MHz - 18 GHz	Miteq			
2.4	ASP 1.2/1.8-10 kg	Antenna Mast	Maturo GmbH	-		
2.5	Anechoic Chamber 03	FAR, 8.80m x 4.60m x 4.05m (l x w x h)	Albatross Projects	P26971-647-001-PRB	2021-04	2023-04
2.6	Opus10 THI (8152.00)	T/H Logger 10	Lufft Mess- und Regeltechnik GmbH	12488	2019-06	2021-06
2.7	JS4-18002600-32-5P	Broadband Amplifier 18 GHz - 26 GHz	Miteq	849785		
2.8	FSW 43	Spectrum Analyzer	Rohde & Schwarz	103779	2019-02	2021-08
2.9	3160-09	Standard Gain / Pyramidal Horn Antenna 26.5 GHz	EMCO Elektronik GmbH	00083069		
2.10	WHKX 7.0/18G-8SS	High Pass Filter	Wainwright Instruments GmbH	09		
2.11	JS4-00102600-42-5A	Broadband Amplifier 30 MHz - 26 GHz	Miteq	619368		
2.12	TT 1.5 WI	Turn Table	Maturo GmbH	-		

Ref.No.	Device Name	Description	Manufacturer	Serial Number	Last Calibration	Calibration Due
2.13	HL 562 ULTRALOG	Biconical-log- per Antenna (30 MHz - 3 GHz)	Rohde & Schwarz GmbH & Co. KG	100609	2019-05	2022-05
2.14	JUN-AIR Mod. 6- 15	Air Compressor	JUN-AIR Deutschland GmbH	612582		
2.15	JS4-00101800- 35-5P	Broadband Amplifier 30 MHz - 18 GHz	Miteq	896037		
2.16	AS 620 P	Antenna Mast (pneumatic polarisation)	HD GmbH	620/37		
2.17	TD1.5-10kg	EUT Tilt Device (Rohacell)	Maturo GmbH	TD1.5- 10kg/024/37907 09		
2.18	HF 907-2	Double-ridged horn	Rohde & Schwarz	102817	2019-04	2022-04
2.19	PAS 2.5 - 10 kg	Antenna Mast	Maturo GmbH	-		
2.20	AFS42- 00101800-25-S- 42	Broadband Amplifier 25 MHz - 18 GHz	Miteq	2035324		
2.21	HF 907	Double-ridged horn	Rohde & Schwarz	102444	2018-07	2021-07

The calibration interval is the time interval between "Last Calibration" and "Calibration Due"

7 ANTENNA FACTORS, CABLE LOSS AND SAMPLE CALCULATIONS

This chapter contains the antenna factors with their corresponding path loss of the used measurement path for all antennas as well as the insertion loss of the LISN.

7.1 LISN R&S ESH3-Z5 (150 KHZ – 30 MHZ)

Frequency MHz	Corr. dB	LISN insertion loss ESH3- Z5 dB	cable loss (incl. 10 dB atten- uator) dB
0.15	10.1	0.1	10.0
5	10.3	0.1	10.2
7	10.5	0.2	10.3
10	10.5	0.2	10.3
12	10.7	0.3	10.4
14	10.7	0.3	10.4
16	10.8	0.4	10.4
18	10.9	0.4	10.5
20	10.9	0.4	10.5
22	11.1	0.5	10.6
24	11.1	0.5	10.6
26	11.2	0.5	10.7
28	11.2	0.5	10.7
30	11.3	0.5	10.8

Sample calculation

$$U_{\text{LISN}} (\text{dB } \mu\text{V}) = U (\text{dB } \mu\text{V}) + \text{Corr. (dB)}$$

U = Receiver reading

LISN Insertion loss = Voltage Division Factor of LISN

Corr. = sum of single correction factors of used LISN, cables, switch units (if used)

Linear interpolation will be used for frequencies in between the values in the table.

7.2 ANTENNA R&S HFH2-Z2 (9 KHZ – 30 MHZ)

Frequency MHz	AF HFH-Z2) dB (1/m)	Corr. dB	cable loss 1 (inside chamber) dB	cable loss 2 (outside chamber) dB	cable loss 3 (switch unit) dB	cable loss 4 (to receiver) dB	distance corr. (-40 dB/ decade) dB	d _{Limit} (meas. distance (limit) m	d _{used} (meas. distance (used) m
0.009	20.50	-79.6	0.1	0.1	0.1	0.1	-80	300	3
0.01	20.45	-79.6	0.1	0.1	0.1	0.1	-80	300	3
0.015	20.37	-79.6	0.1	0.1	0.1	0.1	-80	300	3
0.02	20.36	-79.6	0.1	0.1	0.1	0.1	-80	300	3
0.025	20.38	-79.6	0.1	0.1	0.1	0.1	-80	300	3
0.03	20.32	-79.6	0.1	0.1	0.1	0.1	-80	300	3
0.05	20.35	-79.6	0.1	0.1	0.1	0.1	-80	300	3
0.08	20.30	-79.6	0.1	0.1	0.1	0.1	-80	300	3
0.1	20.20	-79.6	0.1	0.1	0.1	0.1	-80	300	3
0.2	20.17	-79.6	0.1	0.1	0.1	0.1	-80	300	3
0.3	20.14	-79.6	0.1	0.1	0.1	0.1	-80	300	3
0.49	20.12	-79.6	0.1	0.1	0.1	0.1	-80	300	3
0.490001	20.12	-39.6	0.1	0.1	0.1	0.1	-40	30	3
0.5	20.11	-39.6	0.1	0.1	0.1	0.1	-40	30	3
0.8	20.10	-39.6	0.1	0.1	0.1	0.1	-40	30	3
1	20.09	-39.6	0.1	0.1	0.1	0.1	-40	30	3
2	20.08	-39.6	0.1	0.1	0.1	0.1	-40	30	3
3	20.06	-39.6	0.1	0.1	0.1	0.1	-40	30	3
4	20.05	-39.5	0.2	0.1	0.1	0.1	-40	30	3
5	20.05	-39.5	0.2	0.1	0.1	0.1	-40	30	3
6	20.02	-39.5	0.2	0.1	0.1	0.1	-40	30	3
8	19.95	-39.5	0.2	0.1	0.1	0.1	-40	30	3
10	19.83	-39.4	0.2	0.1	0.2	0.1	-40	30	3
12	19.71	-39.4	0.2	0.1	0.2	0.1	-40	30	3
14	19.54	-39.4	0.2	0.1	0.2	0.1	-40	30	3
16	19.53	-39.3	0.3	0.1	0.2	0.1	-40	30	3
18	19.50	-39.3	0.3	0.1	0.2	0.1	-40	30	3
20	19.57	-39.3	0.3	0.1	0.2	0.1	-40	30	3
22	19.61	-39.3	0.3	0.1	0.2	0.1	-40	30	3
24	19.61	-39.3	0.3	0.1	0.2	0.1	-40	30	3
26	19.54	-39.3	0.3	0.1	0.2	0.1	-40	30	3
28	19.46	-39.2	0.3	0.1	0.3	0.1	-40	30	3
30	19.73	-39.1	0.4	0.1	0.3	0.1	-40	30	3

Sample calculation

$$E \text{ (dB } \mu\text{V/m)} = U \text{ (dB } \mu\text{V)} + AF \text{ (dB 1/m)} + Corr. \text{ (dB)}$$

U = Receiver reading

AF = Antenna factor

Corr. = sum of single correction factors of used cables, switch unit, distance correction, amplifier (if applicable)

distance correction = $-40 * \text{LOG} (d_{\text{Limit}} / d_{\text{used}})$

Linear interpolation will be used for frequencies in between the values in the table.

Table shows an extract of values

7.3 ANTENNA R&S HL562 (30 MHZ – 1 GHZ)

($d_{Limit} = 3\text{ m}$)

Frequency	AF R&S HL562	Corr.
MHz	dB (1/m)	dB
30	18.6	0.6
50	6.0	0.9
100	9.7	1.2
150	7.9	1.6
200	7.6	1.9
250	9.5	2.1
300	11.0	2.3
350	12.4	2.6
400	13.6	2.9
450	14.7	3.1
500	15.6	3.2
550	16.3	3.5
600	17.2	3.5
650	18.1	3.6
700	18.5	3.6
750	19.1	4.1
800	19.6	4.1
850	20.1	4.4
900	20.8	4.7
950	21.1	4.8
1000	21.6	4.9

cable loss 1 (inside chamber)	cable loss 2 (outside chamber)	cable loss 3 (switch unit)	cable loss 4 (to receiver)	distance corr. (-20 dB/ decade)	d_{Limit} (meas. distance (limit))	d_{used} (meas. distance (used))
dB	dB	dB	dB	dB	m	m
0.29	0.04	0.23	0.02	0.0	3	3
0.39	0.09	0.32	0.08	0.0	3	3
0.56	0.14	0.47	0.08	0.0	3	3
0.73	0.20	0.59	0.12	0.0	3	3
0.84	0.21	0.70	0.11	0.0	3	3
0.98	0.24	0.80	0.13	0.0	3	3
1.04	0.26	0.89	0.15	0.0	3	3
1.18	0.31	0.96	0.13	0.0	3	3
1.28	0.35	1.03	0.19	0.0	3	3
1.39	0.38	1.11	0.22	0.0	3	3
1.44	0.39	1.20	0.19	0.0	3	3
1.55	0.46	1.24	0.23	0.0	3	3
1.59	0.43	1.29	0.23	0.0	3	3
1.67	0.34	1.35	0.22	0.0	3	3
1.67	0.42	1.41	0.15	0.0	3	3
1.87	0.54	1.46	0.25	0.0	3	3
1.90	0.46	1.51	0.25	0.0	3	3
1.99	0.60	1.56	0.27	0.0	3	3
2.14	0.60	1.63	0.29	0.0	3	3
2.22	0.60	1.66	0.33	0.0	3	3
2.23	0.61	1.71	0.30	0.0	3	3

($d_{Limit} = 10\text{ m}$)

30	18.6	-9.9
50	6.0	-9.6
100	9.7	-9.2
150	7.9	-8.8
200	7.6	-8.6
250	9.5	-8.3
300	11.0	-8.1
350	12.4	-7.9
400	13.6	-7.6
450	14.7	-7.4
500	15.6	-7.2
550	16.3	-7.0
600	17.2	-6.9
650	18.1	-6.9
700	18.5	-6.8
750	19.1	-6.3
800	19.6	-6.3
850	20.1	-6.0
900	20.8	-5.8
950	21.1	-5.6
1000	21.6	-5.6

0.29	0.04	0.23	0.02	-10.5	10	3
0.39	0.09	0.32	0.08	-10.5	10	3
0.56	0.14	0.47	0.08	-10.5	10	3
0.73	0.20	0.59	0.12	-10.5	10	3
0.84	0.21	0.70	0.11	-10.5	10	3
0.98	0.24	0.80	0.13	-10.5	10	3
1.04	0.26	0.89	0.15	-10.5	10	3
1.18	0.31	0.96	0.13	-10.5	10	3
1.28	0.35	1.03	0.19	-10.5	10	3
1.39	0.38	1.11	0.22	-10.5	10	3
1.44	0.39	1.20	0.19	-10.5	10	3
1.55	0.46	1.24	0.23	-10.5	10	3
1.59	0.43	1.29	0.23	-10.5	10	3
1.67	0.34	1.35	0.22	-10.5	10	3
1.67	0.42	1.41	0.15	-10.5	10	3
1.87	0.54	1.46	0.25	-10.5	10	3
1.90	0.46	1.51	0.25	-10.5	10	3
1.99	0.60	1.56	0.27	-10.5	10	3
2.14	0.60	1.63	0.29	-10.5	10	3
2.22	0.60	1.66	0.33	-10.5	10	3
2.23	0.61	1.71	0.30	-10.5	10	3

Sample calculation

$$E \text{ (dB } \mu\text{V/m)} = U \text{ (dB } \mu\text{V)} + \text{AF (dB 1/m)} + \text{Corr. (dB)}$$

U = Receiver reading

AF = Antenna factor

Corr. = sum of single correction factors of used cables, switch unit, distance correction, amplifier (if applicable)

distance correction = $-20 * \text{LOG}(d_{Limit}/d_{used})$

Linear interpolation will be used for frequencies in between the values in the table.

Tables show an extract of values.

7.4 ANTENNA R&S HF907 (1 GHZ – 18 GHZ)

Frequency MHz	AF R&S HF907 dB (1/m)	Corr. dB
1000	24.4	-19.4
2000	28.5	-17.4
3000	31.0	-16.1
4000	33.1	-14.7
5000	34.4	-13.7
6000	34.7	-12.7
7000	35.6	-11.0

cable loss 1 (relay + cable inside chamber) dB	cable loss 2 (outside chamber) dB	cable loss 3 (switch unit, atten- uator & pre-amp) dB	cable loss 4 (to receiver) dB
0.99	0.31	-21.51	0.79
1.44	0.44	-20.63	1.38
1.87	0.53	-19.85	1.33
2.41	0.67	-19.13	1.31
2.78	0.86	-18.71	1.40
2.74	0.90	-17.83	1.47
2.82	0.86	-16.19	1.46

Frequency MHz	AF R&S HF907 dB (1/m)	Corr. dB
3000	31.0	-23.4
4000	33.1	-23.3
5000	34.4	-21.7
6000	34.7	-21.2
7000	35.6	-19.8

cable loss 1 (relay inside chamber) dB	cable loss 2 (inside chamber) dB	cable loss 3 (outside chamber) dB	cable loss 4 (switch unit, atten- uator & pre-amp) dB	cable loss 5 (to receiver) dB	used for FCC 15.247
0.47	1.87	0.53	-27.58	1.33	
0.56	2.41	0.67	-28.23	1.31	
0.61	2.78	0.86	-27.35	1.40	
0.58	2.74	0.90	-26.89	1.47	
0.66	2.82	0.86	-25.58	1.46	

Frequency MHz	AF R&S HF907 dB (1/m)	Corr. dB
7000	35.6	-57.3
8000	36.3	-56.3
9000	37.1	-55.3
10000	37.5	-56.2
11000	37.5	-55.3
12000	37.6	-53.7
13000	38.2	-53.5
14000	39.9	-56.3
15000	40.9	-54.1
16000	41.3	-54.1
17000	42.8	-54.4
18000	44.2	-54.7

cable loss 1 (relay inside chamber) dB	cable loss 2 (High Pass) dB	cable loss 3 (pre- amp) dB	cable loss 4 (inside chamber) dB	cable loss 5 (outside chamber) dB	cable loss 6 (to receiver) dB
0.56	1.28	-62.72	2.66	0.94	1.46
0.69	0.71	-61.49	2.84	1.00	1.53
0.68	0.65	-60.80	3.06	1.09	1.60
0.70	0.54	-61.91	3.28	1.20	1.67
0.80	0.61	-61.40	3.43	1.27	1.70
0.84	0.42	-59.70	3.53	1.26	1.73
0.83	0.44	-59.81	3.75	1.32	1.83
0.91	0.53	-63.03	3.91	1.40	1.77
0.98	0.54	-61.05	4.02	1.44	1.83
1.23	0.49	-61.51	4.17	1.51	1.85
1.36	0.76	-62.36	4.34	1.53	2.00
1.70	0.53	-62.88	4.41	1.55	1.91

Sample calculation

$$E \text{ (dB } \mu\text{V/m)} = U \text{ (dB } \mu\text{V)} + \text{AF (dB 1/m)} + \text{Corr. (dB)}$$

U = Receiver reading

AF = Antenna factor

Corr. = sum of single correction factors of used cables, switch unit, distance correction, amplifier (if applicable)

Linear interpolation will be used for frequencies in between the values in the table.

Tables show an extract of values.

7.5 ANTENNA EMCO 3160-09 (18 GHZ – 26.5 GHZ)

Frequency MHz	AF EMCO 3160-09 dB (1/m)	Corr. dB
18000	40.2	-23.5
18500	40.2	-23.2
19000	40.2	-22.0
19500	40.3	-21.3
20000	40.3	-20.3
20500	40.3	-19.9
21000	40.3	-19.1
21500	40.3	-19.1
22000	40.3	-18.7
22500	40.4	-19.0
23000	40.4	-19.5
23500	40.4	-19.3
24000	40.4	-19.8
24500	40.4	-19.5
25000	40.4	-19.3
25500	40.5	-20.4
26000	40.5	-21.3
26500	40.5	-21.1

cable loss 1 (inside chamber) dB	cable loss 2 (pre- amp) dB	cable loss 3 (inside chamber) dB	cable loss 4 (switch unit) dB	cable loss 5 (to receiver) dB
0.72	-35.85	6.20	2.81	2.65
0.69	-35.71	6.46	2.76	2.59
0.76	-35.44	6.69	3.15	2.79
0.74	-35.07	7.04	3.11	2.91
0.72	-34.49	7.30	3.07	3.05
0.78	-34.46	7.48	3.12	3.15
0.87	-34.07	7.61	3.20	3.33
0.90	-33.96	7.47	3.28	3.19
0.89	-33.57	7.34	3.35	3.28
0.87	-33.66	7.06	3.75	2.94
0.88	-33.75	6.92	3.77	2.70
0.90	-33.35	6.99	3.52	2.66
0.88	-33.99	6.88	3.88	2.58
0.91	-33.89	7.01	3.93	2.51
0.88	-33.00	6.72	3.96	2.14
0.89	-34.07	6.90	3.66	2.22
0.86	-35.11	7.02	3.69	2.28
0.90	-35.20	7.15	3.91	2.36

Sample calculation

$$E \text{ (dB } \mu\text{V/m)} = U \text{ (dB } \mu\text{V)} + AF \text{ (dB 1/m)} + Corr. \text{ (dB)}$$

U = Receiver reading

AF = Antenna factor

Corr. = sum of single correction factors of used cables, switch unit, distance correction, amplifier (if applicable)

Linear interpolation will be used for frequencies in between the values in the table.

Table shows an extract of values.

7.6 ANTENNA EMCO 3160-10 (26.5 GHZ – 40 GHZ)

Frequency GHz	AF EMCO 3160-10 dB (1/m)	Corr. dB	cable loss 1 (inside chamber) dB	cable loss 2 (outside chamber) dB	cable loss 3 (switch unit) dB	cable loss 4 (to receiver) dB	distance corr. (-20 dB/ decade) dB	d _{Limit} (meas. distance (limit) m	d _{used} (meas. distance (used) m
26.5	43.4	-11.2	4.4				-9.5	3	1.0
27.0	43.4	-11.2	4.4				-9.5	3	1.0
28.0	43.4	-11.1	4.5				-9.5	3	1.0
29.0	43.5	-11.0	4.6				-9.5	3	1.0
30.0	43.5	-10.9	4.7				-9.5	3	1.0
31.0	43.5	-10.8	4.7				-9.5	3	1.0
32.0	43.5	-10.7	4.8				-9.5	3	1.0
33.0	43.6	-10.7	4.9				-9.5	3	1.0
34.0	43.6	-10.6	5.0				-9.5	3	1.0
35.0	43.6	-10.5	5.1				-9.5	3	1.0
36.0	43.6	-10.4	5.1				-9.5	3	1.0
37.0	43.7	-10.3	5.2				-9.5	3	1.0
38.0	43.7	-10.2	5.3				-9.5	3	1.0
39.0	43.7	-10.2	5.4				-9.5	3	1.0
40.0	43.8	-10.1	5.5				-9.5	3	1.0

Sample calculation

$E \text{ (dB } \mu\text{V/m)} = U \text{ (dB } \mu\text{V)} + \text{AF (dB 1/m)} + \text{Corr. (dB)}$

U = Receiver reading

AF = Antenna factor

Corr. = sum of single correction factors of used cables, switch unit, distance correction, amplifier (if applicable)

Linear interpolation will be used for frequencies in between the values in the table.

distance correction = $-20 * \text{LOG} (d_{\text{Limit}} / d_{\text{used}})$

Linear interpolation will be used for frequencies in between the values in the table.

Table shows an extract of values.

8 MEASUREMENT UNCERTAINTIES

Test Case	Parameter	Uncertainty
AC Power Line	Power	± 3.4 dB
Field Strength of spurious radiation	Power	± 5.5 dB
6 dB / 26 dB / 99% Bandwidth	Power Frequency	± 2.9 dB ± 11.2 kHz
Conducted Output Power	Power	± 2.2 dB
Band Edge Compliance	Power Frequency	± 2.2 dB ± 11.2 kHz
Frequency Stability	Frequency	± 25 Hz
Power Spectral Density	Power	± 2.2 dB

The measurement uncertainties for all parameters are calculated with an expansion factor (coverage factor) $k = 1.96$. This means, that the true value is in the corresponding interval with a probability of 95 %.

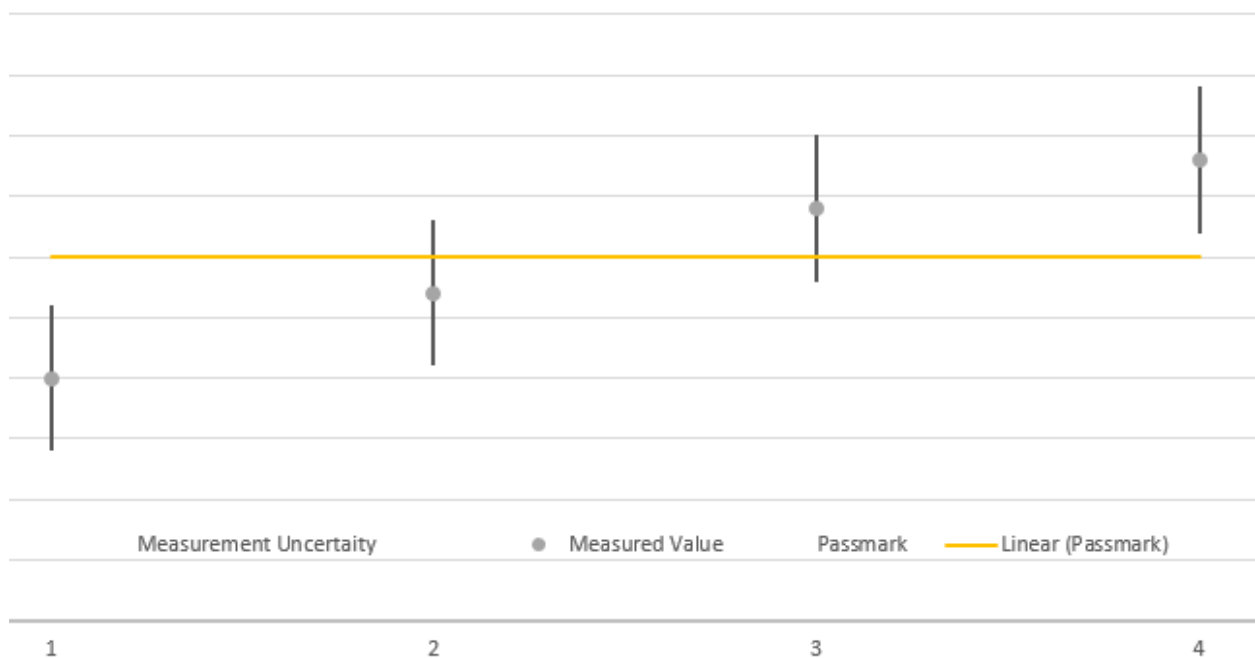

The verdicts in this test report are given according the above diagram:

Case	Measured Value	Uncertainty Range	Verdict
1	below pass mark	below pass mark	Passed
2	below pass mark	within pass mark	Passed
3	above pass mark	within pass mark	Failed
4	above pass mark	above pass mark	Failed

That means, the laboratory applies, as decision rule (see ISO/IEC 17025:2017), the so called shared risk principle.

9 PHOTO REPORT

Please see separate photo report.