

4.8 BAND EDGE

Standard **FCC Part 15 Subpart E**

4.8.1 RADIATED MEASUREMENTS (ANTENNA PORTS TERMINATED WITH 50 OHM)

The test was performed according to:
ANSI C63.10

4.8.1.1 Test Description

Please see test description for the test case "UNDESIRABLE EMISSIONS"

4.8.1.2 Test Requirements / Limits

For band edges connected to a restricted band, the limits are specified in Section 15.209(a)
FCC Part 15, Subpart C, §15.209, Radiated Emission Limits

Frequency in MHz	Limit ($\mu\text{V}/\text{m}$)	Measurement distance (m)	Limits ($\text{dB}\mu\text{V}/\text{m}$)
0.009 – 0.49	2400/F(kHz)@300m	3	(48.5 – 13.8)@300m
0.49 – 1.705	24000/F(kHz)@30m	3	(33.8 – 23.0)@30m
1.705 – 30	30@30m	3	29.5@30m

The measured values are corrected with an inverse linear distance extrapolation factor (40 dB/decade) according FCC 15.31 (2).

Frequency in MHz	Limit ($\mu\text{V}/\text{m}$)	Measurement distance (m)	Limits ($\text{dB}\mu\text{V}/\text{m}$)
30 – 88	100@3m	3	40.0@3m
88 – 216	150@3m	3	43.5@3m
216 – 960	200@3m	3	46.0@3m
960 - 26000	500@3m	3	54.0@3m
26000 - 40000	500@3m	1	54.0@3m

The measured values above 26 GHz are corrected with an inverse linear distance extrapolation factor (20 dB/decade).

§15.35(b) ..., there is also a limit on the radio frequency emissions, as measured using instrumentation with a peak detector function, corresponding to 20 dB above the maximum permitted average limit....

Used conversion factor: $\text{Limit (dB}\mu\text{V}/\text{m)} = 20 \log (\text{Limit } (\mu\text{V}/\text{m})/1\mu\text{V}/\text{m})$

4.8.1.3 Test Protocol

Ambient temperature: 22 - 23 °C
 Air Pressure: 1012 - 1019 hPa
 Humidity: 36 - 37 %

Core 0

WLAN a-Mode; 20 MHz; 6 Mbit/s
 Applied duty cycle correction (AV): 0 dB

U-NII-Subband	Ch. No.	Ch. Center Freq. [MHz]	Band Edge Freq. [MHz]	Spurious Level [dBμV/m]	Detector	RBW [kHz]	Limit [dBμV/m]	Margin [dB]	Limit Type	FCC /IC?
1	36	5180	5150.0	59.2	PEAK	1000	74.0	14.8	BE-RB	FCC&IC
	36	5180	5150.0	46.4	AV	1000	54.0	7.6	BE-RB	FCC&IC
2A	64	5320	5350.0	60.0	PEAK	1000	74.0	14.0	BE-RB	FCC&IC
	64	5320	5350.0	46.6	AV	1000	54.0	7.4	BE-RB	FCC&IC
2C	100	5500	5460.0	60.7	PEAK	1000	74.0	13.3	BE-RB	FCC&IC
	100	5500	5460.0	47.0	AV	1000	54.0	7.0	BE-RB	FCC&IC
	100	5500	5470.0	59.9	PEAK	1000	68.0	8.1	BE-UE	FCC&IC
	140	5700	5725.0	60.0	PEAK	1000	68.0	8.0	BE-UE	FCC&IC
3	149	5745	5725.0	65.2	PEAK	1000	78.0	12.8	BE-UE	FCC&IC
	165	5825	5850.0	61.0	PEAK	1000	78.0	17.0	BE-UE	FCC&IC

WLAN n-Mode; 20 MHz; MCS0
 Applied duty cycle correction (AV): 0 dB

U-NII-Subband	Ch. No.	Ch. Center Freq. [MHz]	Band Edge Freq. [MHz]	Spurious Level [dBμV/m]	Detector	RBW [kHz]	Limit [dBμV/m]	Margin [dB]	Limit Type	FCC /IC?
1	36	5180	5150.0	58.9	PEAK	1000	74.0	15.1	BE-RB	FCC&IC
	36	5180	5150.0	46.3	AV	1000	54.0	7.7	BE-RB	FCC&IC
2A	64	5320	5350.0	59.7	PEAK	1000	74.0	14.3	BE-RB	FCC&IC
	64	5320	5350.0	46.8	AV	1000	54.0	7.2	BE-RB	FCC&IC
2C	100	5500	5460.0	60.1	PEAK	1000	74.0	13.9	BE-RB	FCC&IC
	100	5500	5460.0	46.9	AV	1000	54.0	7.1	BE-RB	FCC&IC
	100	5500	5470.0	59.4	PEAK	1000	68.0	8.6	BE-UE	FCC&IC
	140	5700	5725.0	59.9	PEAK	1000	68.0	8.1	BE-UE	FCC&IC
3	149	5745	5725.0	65.1	PEAK	1000	78.0	12.9	BE-UE	FCC&IC
	165	5825	5850.0	60.6	PEAK	1000	78.0	17.4	BE-UE	FCC&IC

WLAN n-Mode; 40 MHz; MCS 0
 Applied duty cycle correction (AV): 0 dB

U-NII-Subband	Ch. No.	Ch. Center Freq. [MHz]	Band Edge Freq. [MHz]	Spurious Level [dBμV/m]	Detector	RBW [kHz]	Limit [dBμV/m]	Margin [dB]	Limit Type	FCC /IC?
1	38	5190	5150.0	59.5	PEAK	1000	74.0	14.5	BE-RB	FCC&IC
	38	5190	5150.0	46.2	AV	1000	54.0	7.8	BE-RB	FCC&IC
2A	62	5310	5350.0	57.7	PEAK	1000	74.0	16.3	BE-RB	FCC&IC
	62	5310	5350.0	44.3	AV	1000	54.0	9.7	BE-RB	FCC&IC
2C	102	5510	5460.0	58.0	PEAK	1000	74.0	16.0	BE-RB	FCC&IC
	102	5510	5460.0	44.9	AV	1000	54.0	9.1	BE-RB	FCC&IC
	102	5510	5470.0	56.0	PEAK	1000	68.0	12.0	BE-UE	FCC&IC
	134	5670	5725.0	59.7	PEAK	1000	68.0	8.3	BE-UE	FCC&IC
3	151	5755	5725.0	68.1	PEAK	1000	78.0	9.9	BE-UE	FCC&IC
	159	5795	5850.0	60.2	PEAK	1000	78.0	17.8	BE-UE	FCC&IC

WLAN ac-Mode; 80 MHz; MCS 0
 Applied duty cycle correction (AV): 0 dB

U-NII-Subband	Ch. No.	Ch. Center Freq. [MHz]	Band Edge Freq. [MHz]	Spurious Level [dBμV/m]	Detector	RBW [kHz]	Limit [dBμV/m]	Margin [dB]	Limit Type	FCC /IC?
1	42	5210	5150.0	58.5	PEAK	1000	74.0	15.5	BE-RB	FCC&IC
	42	5210	5150.0	46.3	AV	1000	54.0	7.7	BE-RB	FCC&IC
2A	58	5290	5350.0	59.1	PEAK	1000	74.0	14.9	BE-RB	FCC&IC
	58	5290	5350.0	46.7	AV	1000	54.0	7.3	BE-RB	FCC&IC
2C	106	5530	5460.0	60.0	PEAK	1000	74.0	14.0	BE-RB	FCC&IC
	106	5530	5460.0	47.0	AV	1000	54.0	7.0	BE-RB	FCC&IC
	106	5530	5470.0	59.9	PEAK	1000	68.0	8.1	BE-UE	FCC&IC
3	155	5775	5725.0	64.4	PEAK	1000	78.0	13.6	BE-UE	FCC&IC
	155	5775	5850.0	61.4	PEAK	1000	78.0	16.6	BE-UE	FCC&IC

Core 1

WLAN a-Mode; 20 MHz; 6 Mbit/s
 Applied duty cycle correction (AV): 0 dB

U-NII-Subband	Ch. No.	Ch. Center Freq. [MHz]	Band Edge Freq. [MHz]	Spurious Level [dBμV/m]	Detector	RBW [kHz]	Limit [dBμV/m]	Margin [dB]	Limit Type	FCC /IC?
1	36	5180	5150.0	59.5	PEAK	1000	74.0	14.5	BE-RB	FCC&IC
	36	5180	5150.0	46.1	AV	1000	54.0	7.9	BE-RB	FCC&IC
2A	64	5320	5350.0	59.8	PEAK	1000	74.0	14.2	BE-RB	FCC&IC
	64	5320	5350.0	46.7	AV	1000	54.0	7.3	BE-RB	FCC&IC
2C	100	5500	5460.0	59.4	PEAK	1000	74.0	14.6	BE-RB	FCC&IC
	100	5500	5460.0	46.9	AV	1000	54.0	7.1	BE-RB	FCC&IC
	100	5500	5470.0	59.7	PEAK	1000	68.0	8.3	BE-UE	FCC&IC
	140	5700	5725.0	60.0	PEAK	1000	68.0	8.0	BE-UE	FCC&IC
3	149	5745	5725.0	60.0	PEAK	1000	78.0	18.0	BE-UE	FCC&IC
	165	5825	5850.0	60.6	PEAK	1000	78.0	17.4	BE-UE	FCC&IC

WLAN n-Mode; 20 MHz; MCS0
 Applied duty cycle correction (AV): 0 dB

U-NII-Subband	Ch. No.	Ch. Center Freq. [MHz]	Band Edge Freq. [MHz]	Spurious Level [dBμV/m]	Detector	RBW [kHz]	Limit [dBμV/m]	Margin [dB]	Limit Type	FCC /IC?
1	36	5180	5150.0	59.6	PEAK	1000	74.0	14.4	BE-RB	FCC&IC
	36	5180	5150.0	46.4	AV	1000	54.0	7.6	BE-RB	FCC&IC
2A	64	5320	5350.0	59.5	PEAK	1000	74.0	14.5	BE-RB	FCC&IC
	64	5320	5350.0	46.7	AV	1000	54.0	7.3	BE-RB	FCC&IC
2C	100	5500	5460.0	60.4	PEAK	1000	74.0	13.6	BE-RB	FCC&IC
	100	5500	5460.0	47.1	AV	1000	54.0	6.9	BE-RB	FCC&IC
	100	5500	5470.0	61.1	PEAK	1000	68.0	6.9	BE-UE	FCC&IC
	140	5700	5725.0	60.2	PEAK	1000	68.0	7.8	BE-UE	FCC&IC
3	149	5745	5725.0	60.3	PEAK	1000	78.0	17.7	BE-UE	FCC&IC
	165	5825	5850.0	61.2	PEAK	1000	78.0	16.8	BE-UE	FCC&IC

WLAN n-Mode; 40 MHz; MCS 0
Applied duty cycle correction (AV): 0 dB

U-NII-Subband	Ch. No.	Ch. Center Freq. [MHz]	Band Edge Freq. [MHz]	Spurious Level [dBμV/m]	Detector	RBW [kHz]	Limit [dBμV/m]	Margin [dB]	Limit Type	FCC /IC?
1	38	5190	5150.0	59.5	PEAK	1000	74.0	14.5	BE-RB	FCC&IC
	38	5190	5150.0	46.3	AV	1000	54.0	7.7	BE-RB	FCC&IC
2A	62	5310	5350.0	59.9	PEAK	1000	74.0	14.1	BE-RB	FCC&IC
	62	5310	5350.0	46.6	AV	1000	54.0	7.4	BE-RB	FCC&IC
2C	102	5510	5460.0	59.8	PEAK	1000	74.0	14.2	BE-RB	FCC&IC
	102	5510	5460.0	47.1	AV	1000	54.0	6.9	BE-RB	FCC&IC
	102	5510	5470.0	60.3	PEAK	1000	68.0	7.7	BE-UE	FCC&IC
	134	5670	5725.0	60.5	PEAK	1000	68.0	7.5	BE-UE	FCC&IC
3	151	5755	5725.0	63.2	PEAK	1000	78.0	14.8	BE-UE	FCC&IC
	159	5795	5850.0	57.1	PEAK	1000	78.0	20.9	BE-UE	FCC&IC

WLAN ac-Mode; 80 MHz; MCS 0
Applied duty cycle correction (AV): 0 dB

U-NII-Subband	Ch. No.	Ch. Center Freq. [MHz]	Band Edge Freq. [MHz]	Spurious Level [dBμV/m]	Detector	RBW [kHz]	Limit [dBμV/m]	Margin [dB]	Limit Type	FCC /IC?
1	42	5210	5150.0	59.3	PEAK	1000	74.0	14.7	BE-RB	FCC&IC
	42	5210	5150.0	46.2	AV	1000	54.0	7.8	BE-RB	FCC&IC
2A	58	5290	5350.0	59.7	PEAK	1000	74.0	14.3	BE-RB	FCC&IC
	58	5290	5350.0	46.6	AV	1000	54.0	7.4	BE-RB	FCC&IC
2C	106	5530	5460.0	60.5	PEAK	1000	74.0	13.5	BE-RB	FCC&IC
	106	5530	5460.0	47.0	AV	1000	54.0	7.0	BE-RB	FCC&IC
	106	5530	5470.0	59.8	PEAK	1000	68.0	8.2	BE-UE	FCC&IC
3	155	5775	5725.0	60.4	PEAK	1000	78.0	17.6	BE-UE	FCC&IC
	155	5775	5850.0	61.4	PEAK	1000	78.0	16.6	BE-UE	FCC&IC

Remark: Please see next sub-clause for the measurement plot.

4.8.1.4 Measurement Plot (showing the highest value, "worst case")

Radio Technology = WLAN a 20 MHz, Channel 100, Core 0
(S01_3_AB01)

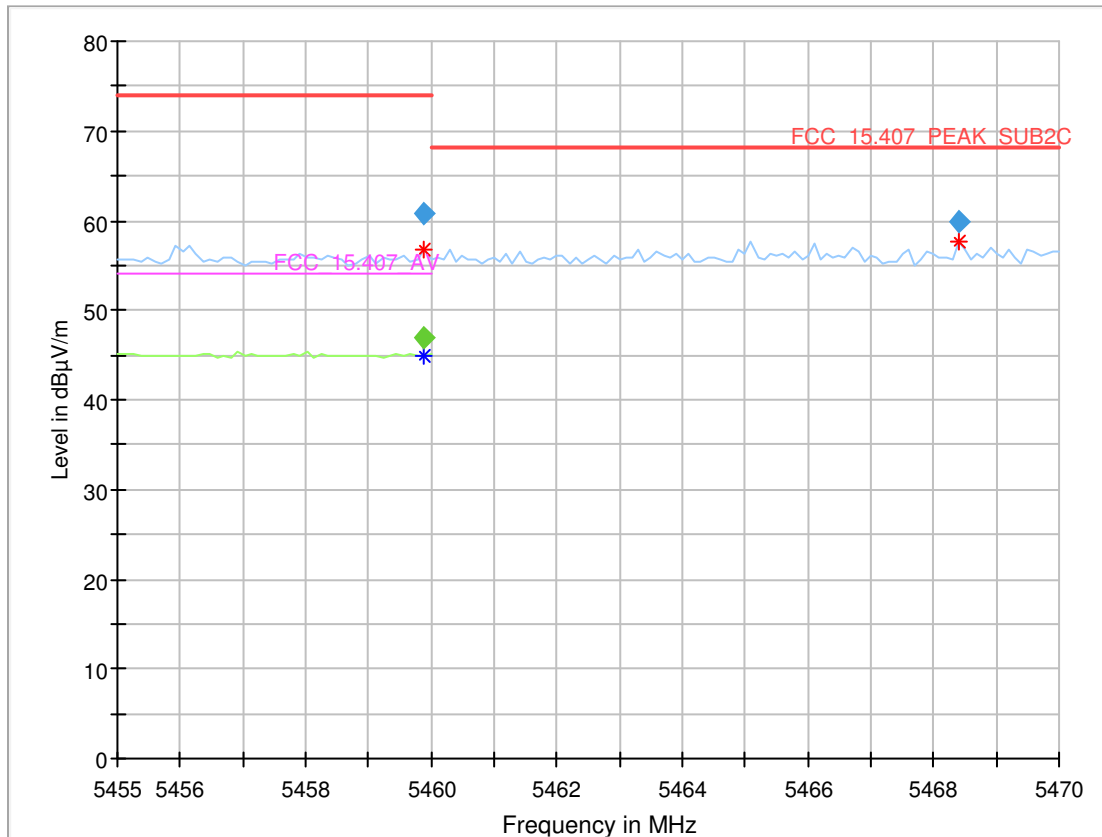

Critical_Freqs

Frequency (MHz)	MaxPeak (dBµV/m)	Average (dBµV/m)	Limit (dBµV/m)	Margin (dB)	Meas. Time (ms)	Bandwidth (kHz)	Height (cm)	Pol	Azimuth (deg)	Elevation (deg)
5459.890000	56.84	---	74.00	17.16	---	---	150.0	V	2.0	-9.0
5459.890000	---	44.86	54.00	9.14	---	---	150.0	H	-98.0	15.2
5468.400000	57.68	---	68.20	10.52	---	---	150.0	H	128.0	82.4

Final_Result

Frequency (MHz)	MaxPeak (dBµV/m)	CAverage (dBµV/m)	Limit (dBµV/m)	Margin (dB)	Meas. Time (ms)	Bandwidth (kHz)	Height (cm)	Pol	Azimuth (deg)	Elevation (deg)
5459.890000	60.73	---	74.00	13.27	1000.0	1000.000	150.0	V	2.0	-9.1
5459.890000	---	47.00	54.00	7.00	1000.0	1000.000	150.0	H	-98.0	15.2
5468.400000	59.91	---	68.20	8.29	1000.0	1000.000	150.0	H	128.0	82.0

4.8.2 CONDUCTED MEASUREMENTS AT ANTENNA PORT

The test was performed according to:

ANSI C63.10

4.8.2.1 Test Description

Please see test description for the test case "UNDESIRABLE EMISSIONS"

Band Edge measurement

Settings:

- Detector: Peak, RMS
- Trace: Max Hold, Average (Power Average)
- IF Bandwidth = 1 MHz

Measurements may have also been performed separately, as only Peak, Max Hold or only RMS, Power averaging. See also measurement plots.

4.8.2.2 Test Requirements / Limits

Please see test description for the test case "UNDESIRABLE EMISSIONS"

4.8.2.3 Test Protocol

Ambient temperature: 20–25 °C
Air Pressure: 981–1026 hPa
Humidity: 34–44 %

WLAN a-Mode; 20 MHz; 6Mbps									
U-NII-Subband	Ch. No.	Ch. Center Freq. [MHz]	Band Edge Freq. [MHz]	Spurious Level Core 0 [dBµV/m]	Spurious Level Core 1 [dBµV/m]	Detector	RBW [kHz]	Limit [dBµV/m]	Min. Margin [dB]
1	36	5180	5150.0	67.3	66.4	PEAK	1000	74.0	6.7
	36	5180	5150.0	48.1	48.7	AV	1000	54.0	5.3
	40	5200	5150.0	62.5	64.1	PEAK	1000	74.0	9.9
	40	5200	5150.0	48.3	49.9	AV	1000	54.0	4.1
2A	60	5300	5350.0	62.1	62.8	PEAK	1000	74.0	11.2
	60	5300	5350.0	48.4	50.4	AV	1000	54.0	3.6
	64	5320	5350.0	64.3	68.5	PEAK	1000	74.0	5.5
	64	5320	5350.0	48.8	50.3	AV	1000	54.0	3.7
2C	100	5500	5460.0	60.9	63.7	PEAK	1000	74.0	10.3
	100	5500	5460.0	48.8	48.6	AV	1000	54.0	5.2
	100	5500	5470.0	65.6	65.5	PEAK	1000	68.0	2.4
	104	5520	5460.0	61.0	64.6	PEAK	1000	74.0	9.4
	104	5520	5460.0	49.6	50.7	AV	1000	54.0	3.3
	104	5520	5470.0	66.3	66.1	PEAK	1000	68.0	1.7
	136	5680	5725.0	65.4	63.3	PEAK	1000	68.0	2.6
	140	5700	5725.0	67.0	65.0	PEAK	1000	68.0	1.0
3	149	5745	5725.0	55.2	56.0	PEAK	1000	78.0	22.0
	165	5825	5850.0	54.3	57.3	PEAK	1000	78.0	20.7

WLAN n-Mode; 20 MHz; MCS0										
U-NII-Subband	Ch. No.	Ch. Center Freq. [MHz]	Band Edge Freq. [MHz]	Spurious Level Core 0 [dBµV/m]	Spurious Level Core 1 [dBµV/m]	Spurious Level Core 0 + 1 [dBµV/m]	Detector	RBW [kHz]	Limit [dBµV/m]	Margin [dB]
1	36	5180	5150.0	65.0	69.6	70.9	PEAK	1000	74.0	3.1
	36	5180	5150.0	47.6	49.1	51.4	AV	1000	54.0	2.6
	40	5200	5150.0	63.1	66.7	68.3	PEAK	1000	74.0	5.7
	40	5200	5150.0	47.3	50.5	52.2	AV	1000	54.0	1.8
2A	60	5300	5350.0	63.5	66.4	68.2	PEAK	1000	74.0	5.8
	60	5300	5350.0	48.8	50.6	52.8	AV	1000	54.0	1.2
	64	5320	5350.0	67.1	66.3	69.7	PEAK	1000	74.0	4.3
	64	5320	5350.0	48.4	49.7	52.1	AV	1000	54.0	1.9
2C	100	5500	5460.0	67.9	65.6	69.9	PEAK	1000	74.0	4.1
	100	5500	5460.0	49.4	48.5	52.0	AV	1000	54.0	2.0
	100	5500	5470.0	63.3	63.0	66.2	PEAK	1000	68.0	1.8
	104	5520	5460.0	60.2	63.1	64.9	PEAK	1000	74.0	9.1
	104	5520	5460.0	48.4	50.9	52.8	AV	1000	54.0	1.2
	104	5520	5470.0	63.7	66.0	68.0	PEAK	1000	68.0	0.0
	136	5680	5725.0	64.7	64.7	67.7	PEAK	1000	68.0	0.3
	140	5700	5725.0	63.2	60.7	65.1	PEAK	1000	68.0	2.9
3	149	5745	5725.0	55.3	57.6	59.6	PEAK	1000	78.0	18.4
	165	5825	5850.0	54.3	55.2	57.8	PEAK	1000	78.0	20.2

WLAN n-Mode; 40 MHz; MCS0										
U-NII-Subband	Ch. No.	Ch. Center Freq. [MHz]	Band Edge Freq. [MHz]	Spurious Level Core 0 [dBµV/m]	Spurious Level Core 1 [dBµV/m]	Spurious Level Core 0 + 1 [dBµV/m]	Detector	RBW [kHz]	Limit [dBµV/m]	Margin [dB]
1	38	5190	5150.0	63.7	65.0	67.4	PEAK	1000	74.0	6.6
	38	5190	5150.0	45.5	46.8	49.2	AV	1000	54.0	4.8
	46	5230	5150.0	60.3	62.8	64.7	PEAK	1000	74.0	9.3
	46	5230	5150.0	44.7	46.8	48.9	AV	1000	54.0	5.1
2A	54	5270	5350.0	59.7	62.7	64.5	PEAK	1000	74.0	9.5
	54	5270	5350.0	45.3	46.9	49.2	AV	1000	54.0	4.8
	62	5310	5350.0	57.7	61.8	63.2	PEAK	1000	74.0	10.8
	62	5310	5350.0	46.4	46.0	49.2	AV	1000	54.0	4.8
2C	102	5510	5460.0	68.8	67.2	71.1	PEAK	1000	74.0	2.9
	102	5510	5460.0	48.4	48.1	51.3	AV	1000	54.0	2.7
	102	5510	5470.0	60.0	60.0	63.0	PEAK	1000	68.0	5.0
	110	5550	5460.0	61.2	61.2	64.2	PEAK	1000	74.0	9.8
	110	5550	5460.0	49.1	47.9	51.6	AV	1000	54.0	2.4
	110	5550	5470.0	64.6	62.4	66.6	PEAK	1000	68.0	1.4
	126	5630	5725.0	58.2	57.7	61.0	PEAK	1000	68.0	7.0
	134	5670	5725.0	63.5	60.3	65.2	PEAK	1000	68.0	2.8
3	151	5755	5725.0	63.7	62.6	66.2	PEAK	1000	78.0	11.8
	159	5795	5850.0	56.6	54.4	58.6	PEAK	1000	78.0	19.4

WLAN ac-Mode; 80 MHz; MCS0										
U-NII-Subband	Ch. No.	Ch. Center Freq. [MHz]	Band Edge Freq. [MHz]	Spurious Level Core 0 [dBµV/m]	Spurious Level Core 1 [dBµV/m]	Spurious Level Core 0 + 1 [dBµV/m]	Detector	RBW [kHz]	Limit [dBµV/m]	Margin [dB]
1	38	5190	5150.0	60.3	61.6	64.0	PEAK	1000	74.0	10.0
	38	5190	5150.0	45.4	45.9	48.7	AV	1000	54.0	5.3
2A	54	5270	5350.0	60.3	61.0	63.7	PEAK	1000	74.0	10.3
	54	5270	5350.0	45.9	46.1	49.0	AV	1000	54.0	5.0
2C	106	5530	5460.0	63.3	61.8	65.6	PEAK	1000	74.0	8.4
	106	5530	5460.0	47.6	47.0	50.3	AV	1000	54.0	3.7
	106	5530	5470.0	64.6	63.6	67.1	PEAK	1000	68.0	0.9
	122	5610	5725.0	57.9	54.6	59.6	PEAK	1000	68.0	8.4
3	151	5755	5725.0	64.7	65.4	68.1	PEAK	1000	78.0	9.9
	159	5795	5850.0	58.7	58.0	61.4	PEAK	1000	78.0	16.6

1) Integration method used.

Remark: Please see next sub-clause for the measurement plot.

4.8.2.4 Measurement Plot (showing the highest value, "worst case")

Radio Technology = WLAN a 20 MHz
(S01_3_AA01)

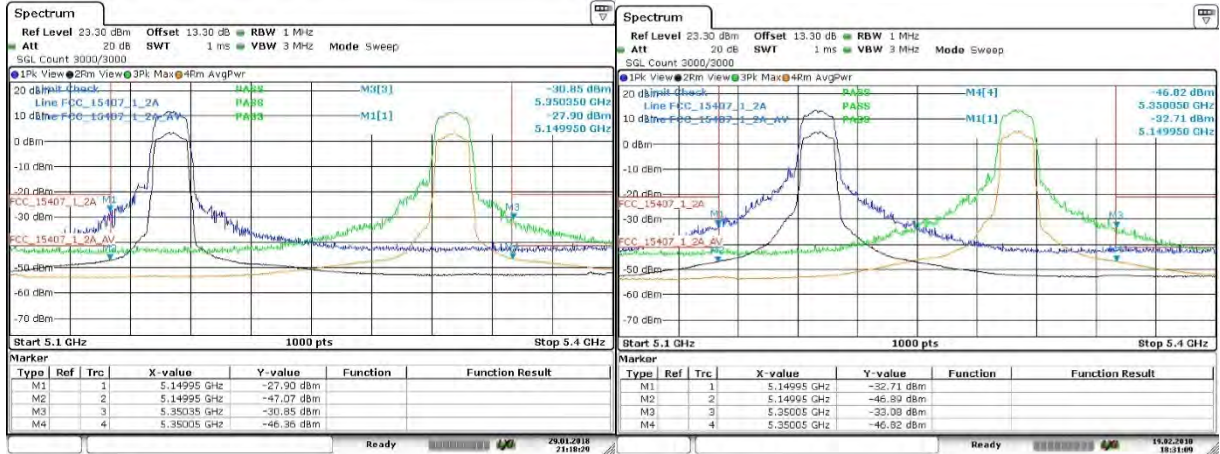

Core 0 Band 1/2A lowest / highest

Core 0 Band 1/2A 2nd lowest / highest

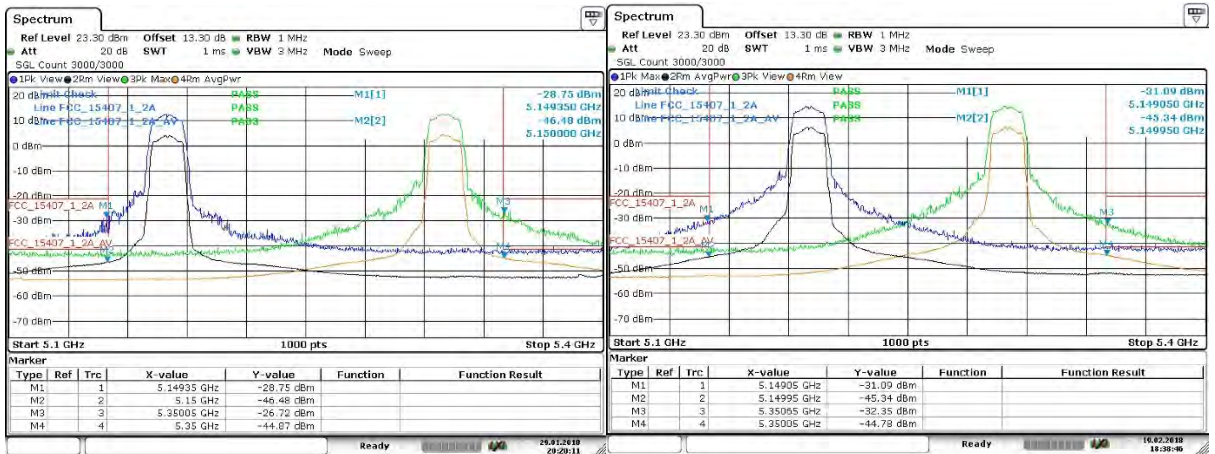

Core 1 Band 1/2A lowest / highest

Core 1 Band 1/2A 2nd lowest / highest

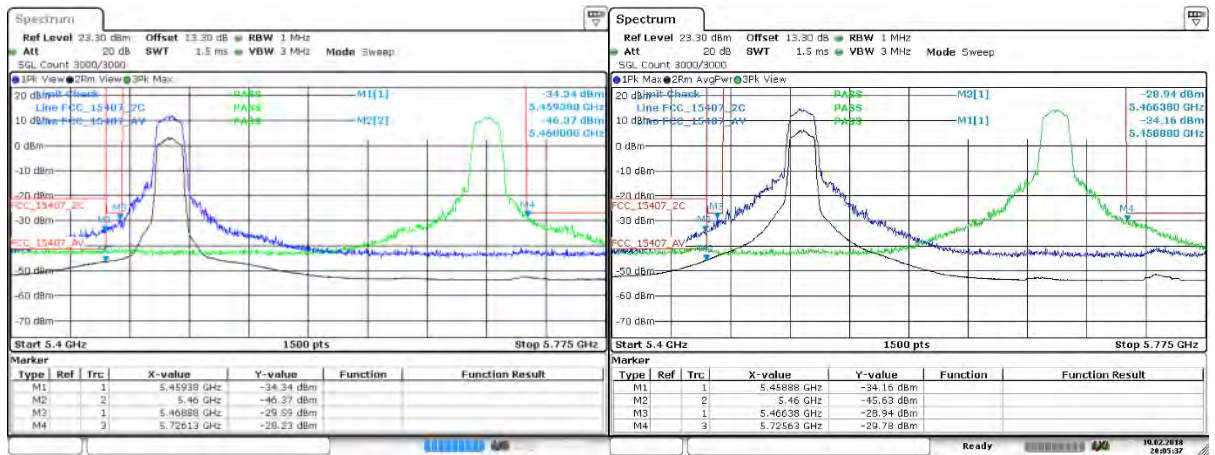

Core 0 Band 2C lowest / highest

Core 0 Band 2C 2nd lowest / highest

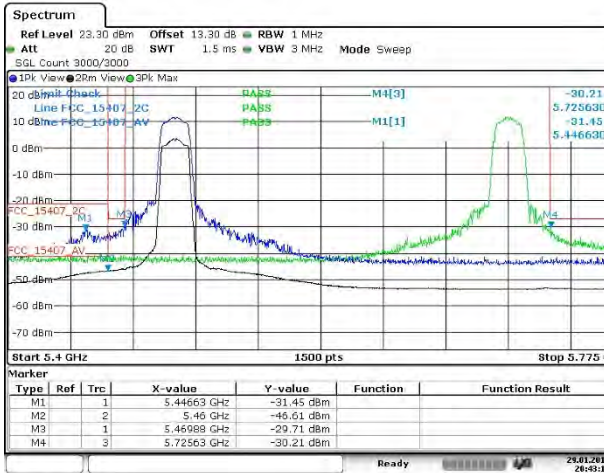

Date: 29 JAN 2018 20:43:16

Core 1 Band 2C lowest / highest

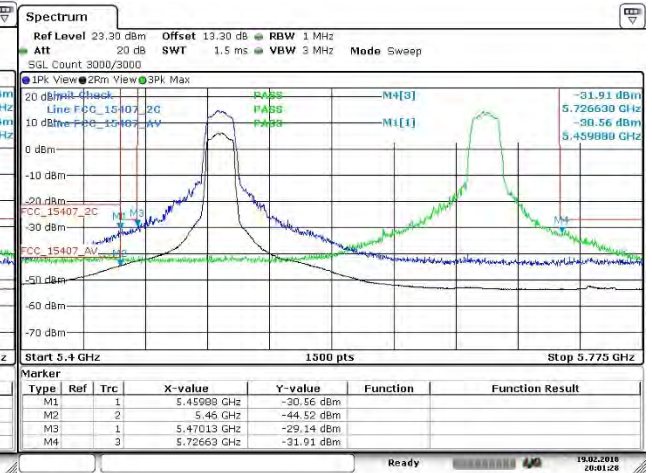

Date: 19 FEB 2018 20:01:29

Core 1 Band 2C 2nd lowest / highest

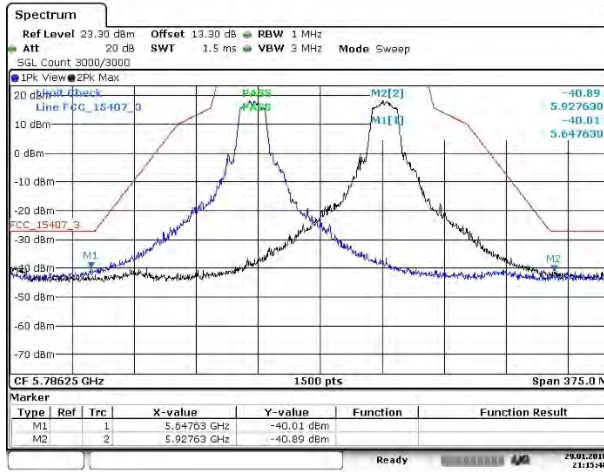

Date: 29 JAN 2018 21:15:49

Core 0 Band 3 lowest / highest

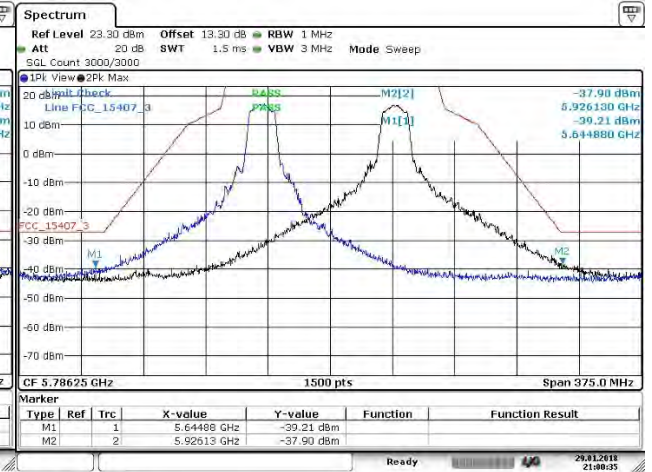

Date: 29 JAN 2018 21:00:35

Core 1 Band 3 lowest / highest

Radio Technology = WLAN n 20 MHz
(S01_3_AA01)

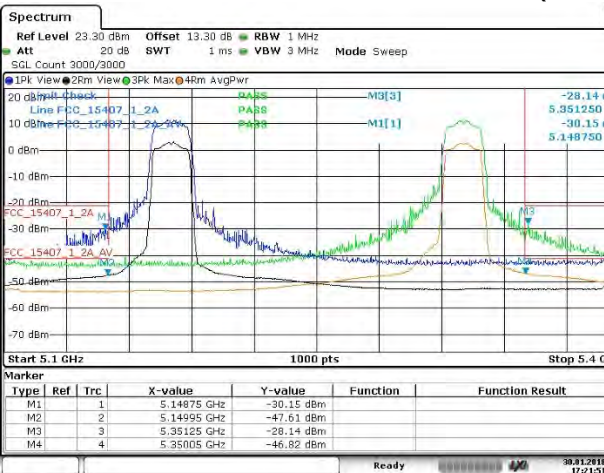

Date: 30 JAN 2018 17:21:51

Core 0 Band 1/2A lowest / highest

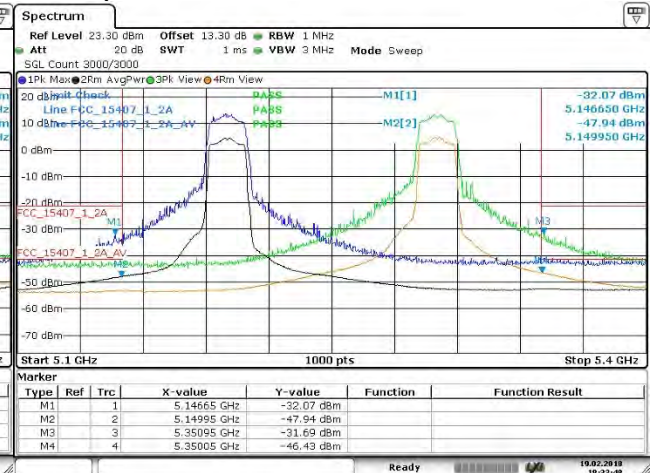

Date: 19 FEB 2018 18:33:49

Core 0 Band 1/2A 2nd lowest / highest

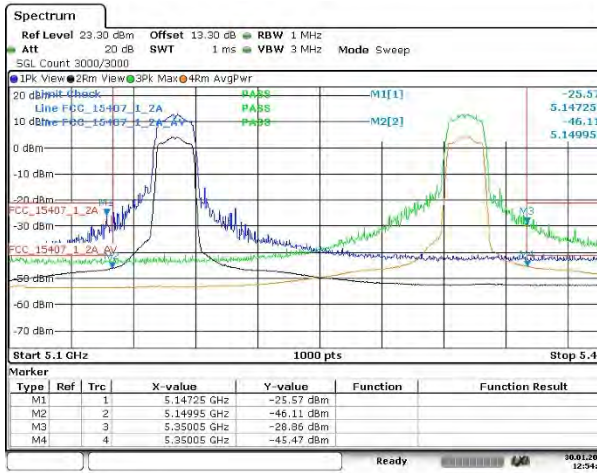

Core 1 Band 1/2A lowest / highest

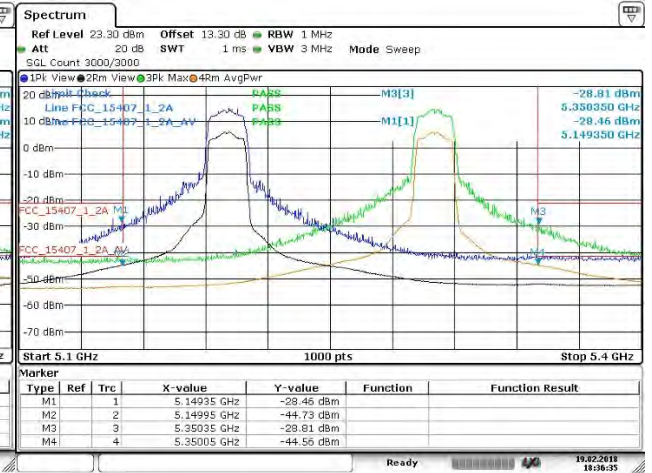

Core 1 Band 1/2A 2nd lowest / highest

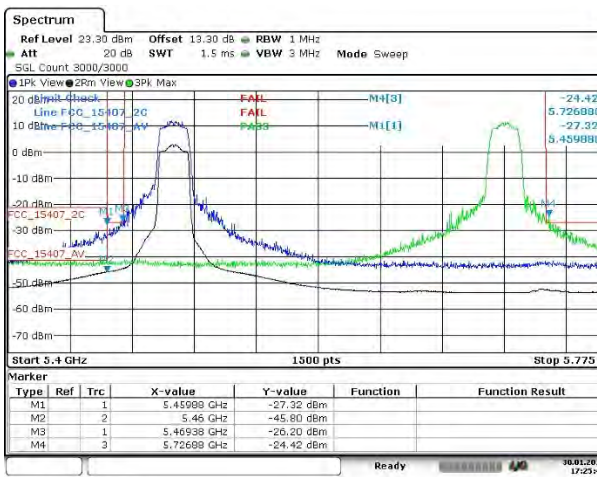

Core 0 Band 2C lowest / highest

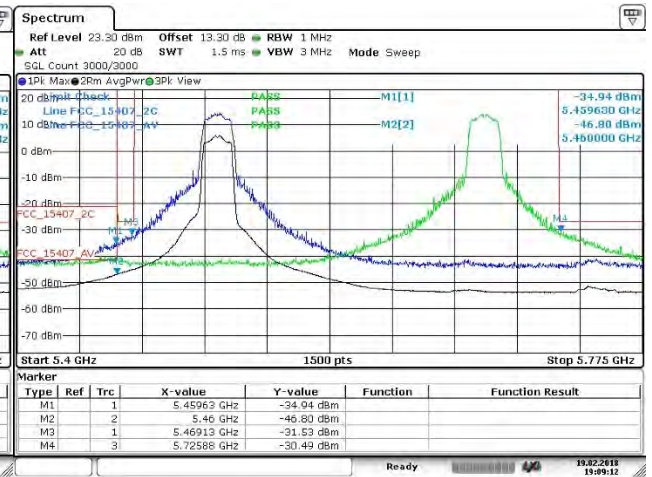

Core 0 Band 2C 2nd lowest / highest

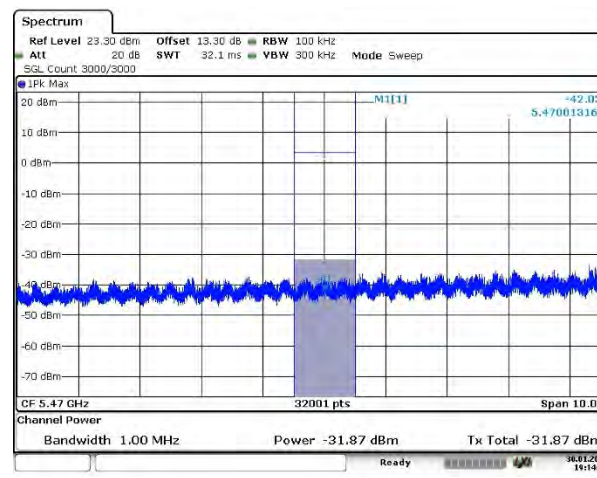

Core 0 Band 2C lowest integration method

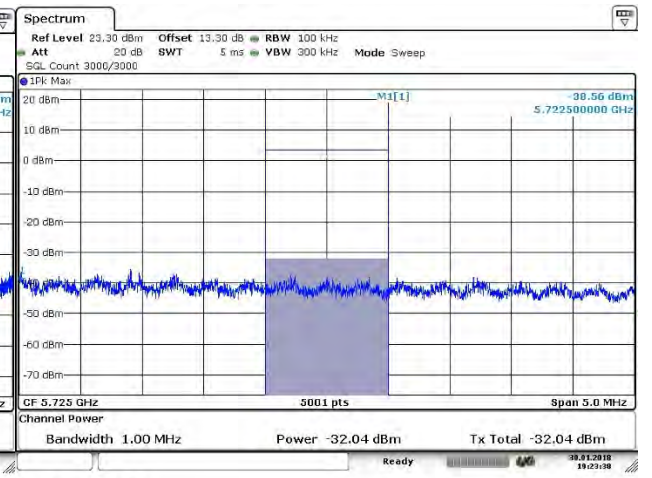

Core 0 Band 2C highest integration method

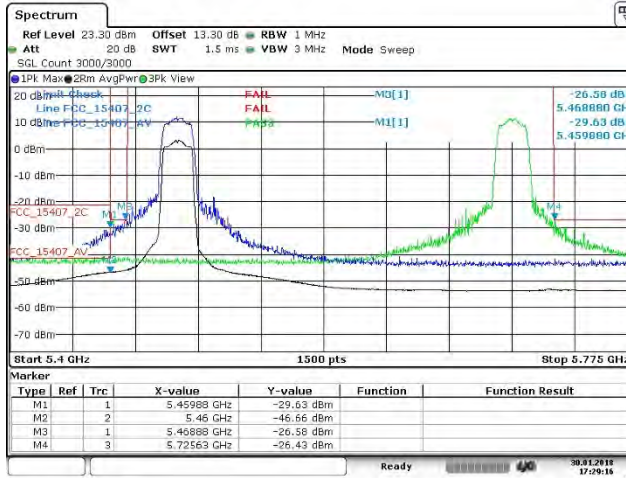

Core 1 Band 2C lowest / highest

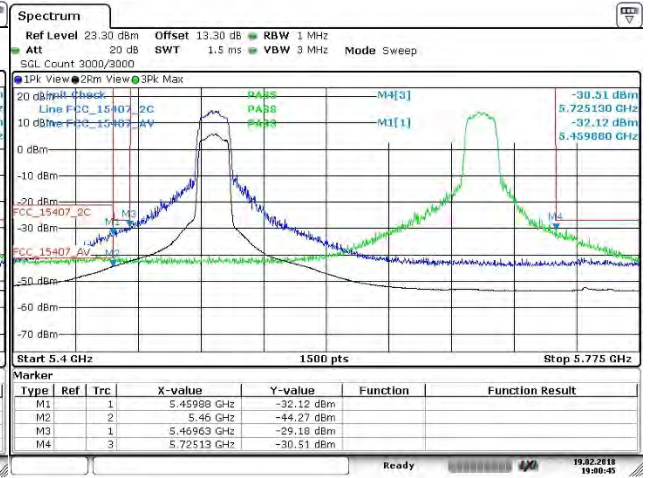

Core 1 Band 2C 2nd lowest / highest

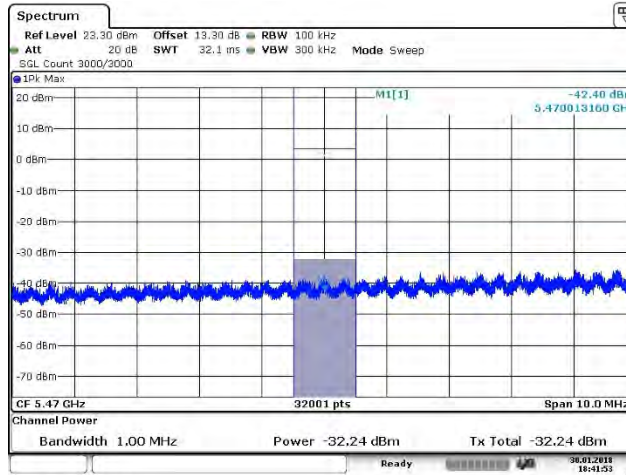

Core 1 Band 2C lowest integration method

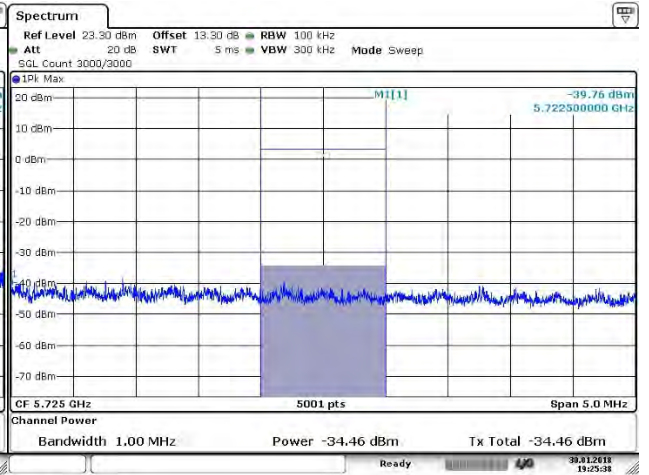

Core 1 Band 2C highest integration method

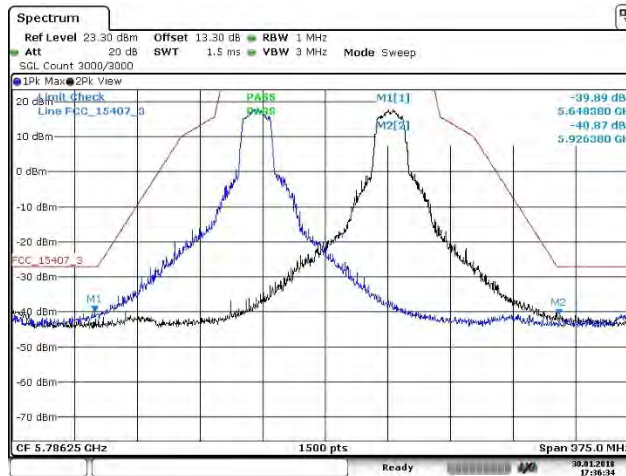

Core 0 Band 3 lowest / highest

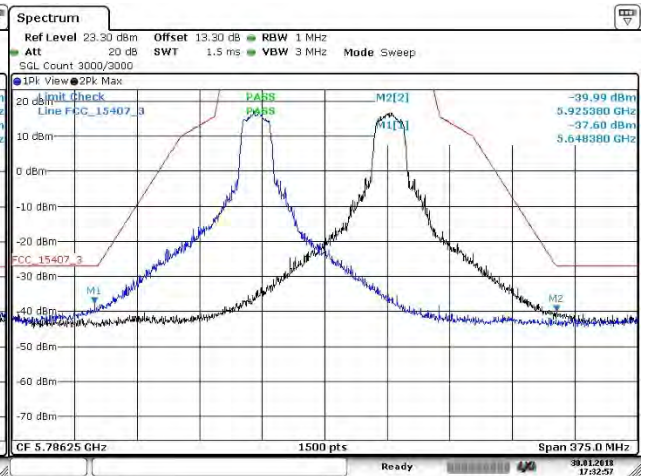

Core 1 Band 3 lowest / highest

Radio Technology = WLAN n 40 MHz (S01_3_AA01)

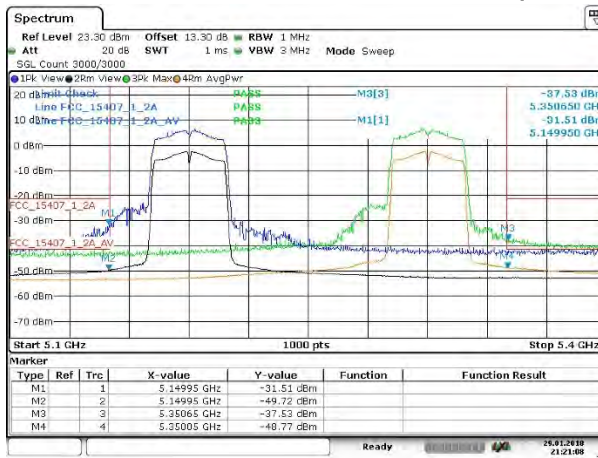

Core 0 Band 1/2A lowest / highest

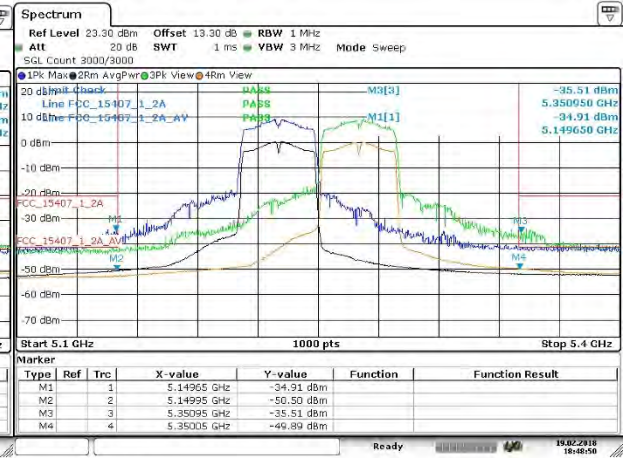

Core 0 Band 1/2A 2nd lowest / highest

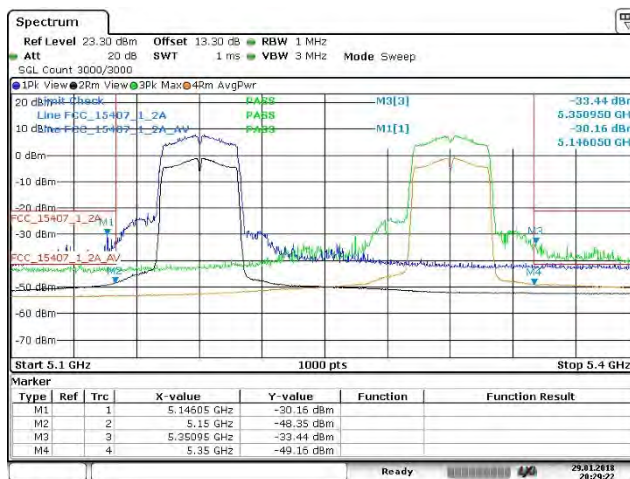

Core 1 Band 1/2A lowest / highest

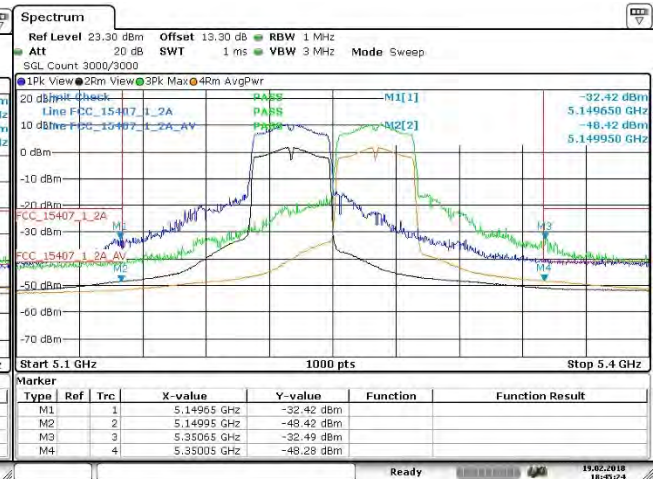

Core 1 Band 1/2A 2nd lowest / highest

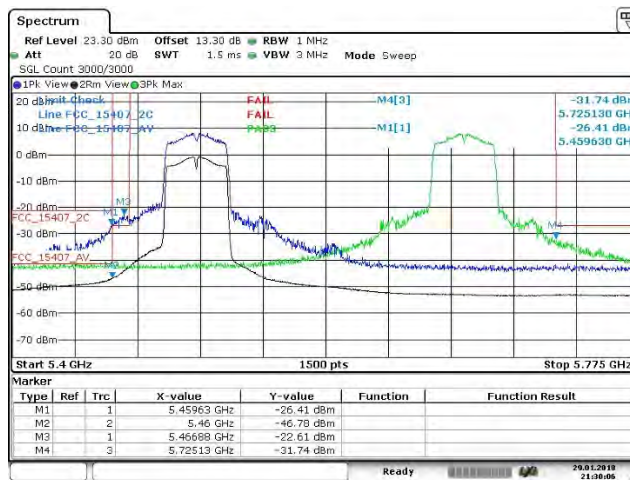

Core 0 Band 2C lowest / highest

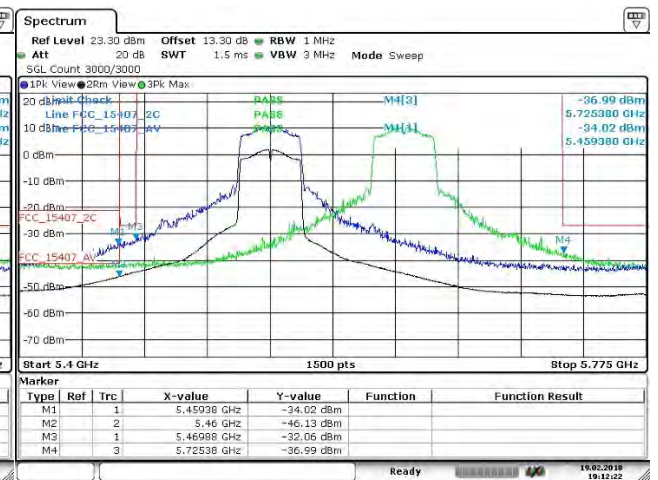

Core 0 Band 2C 2nd lowest / highest

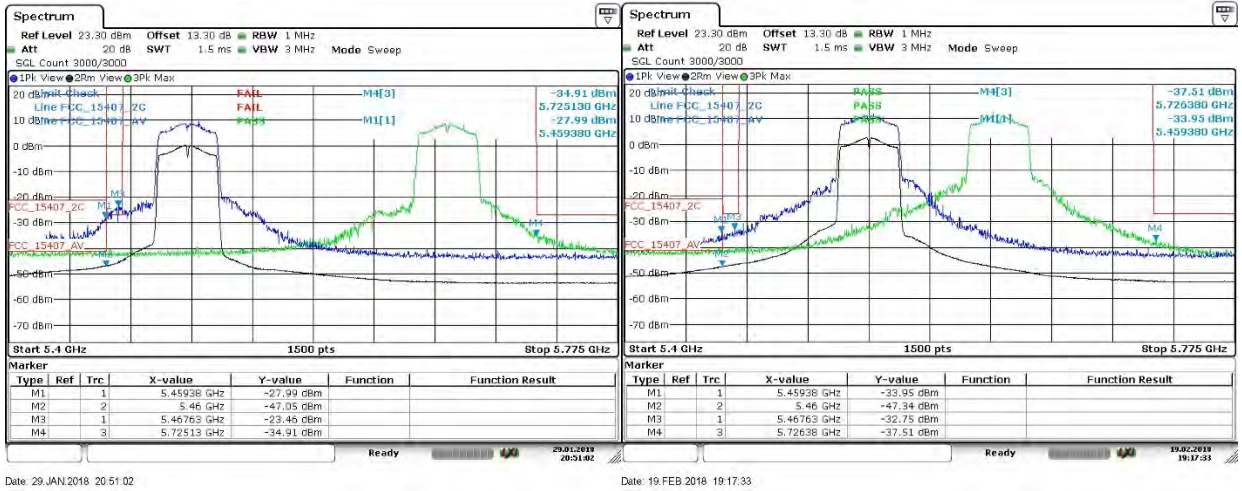

Core 1 Band 2C lowest / highest

Core 1 Band 2C 2nd lowest / highest

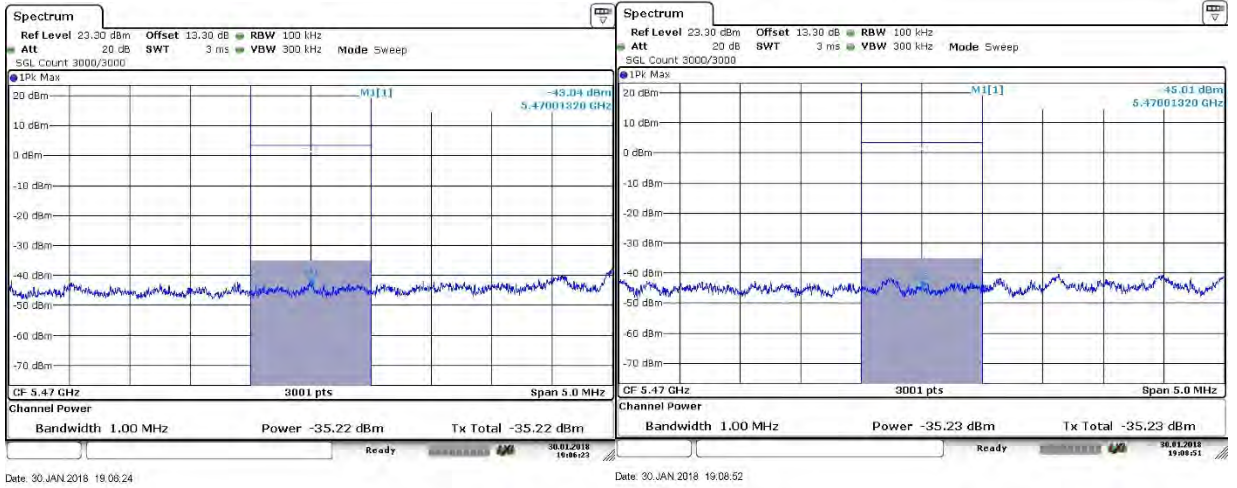

Core 0 Band 2C lowest integration method

Core 1 Band 2C lowest integration method

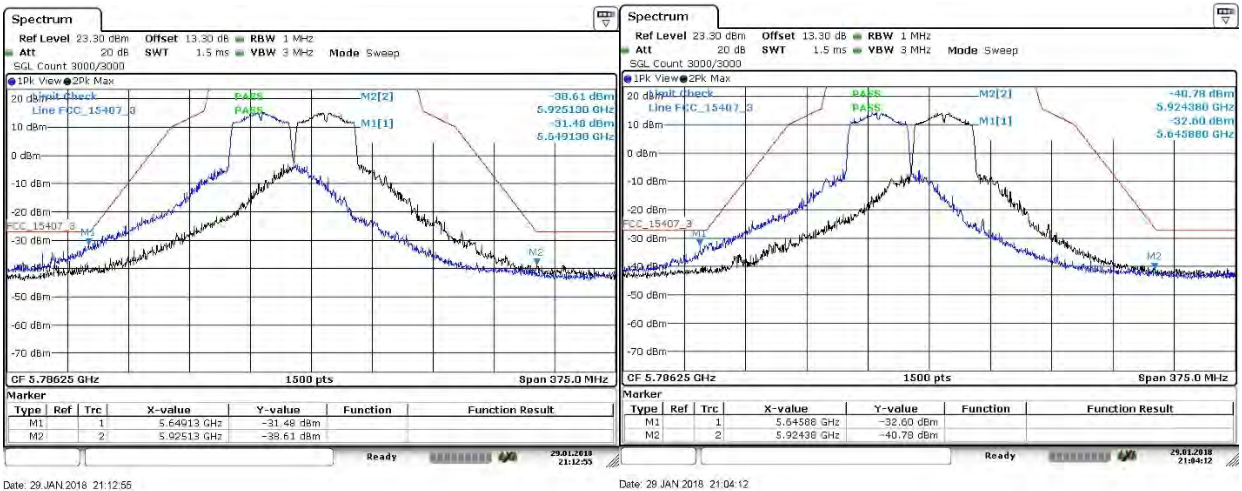

Core 0 Band 3 lowest / highest

Core 1 Band 3 lowest / highest

Radio Technology = WLAN ac 80 MHz (S01_3_AA01)

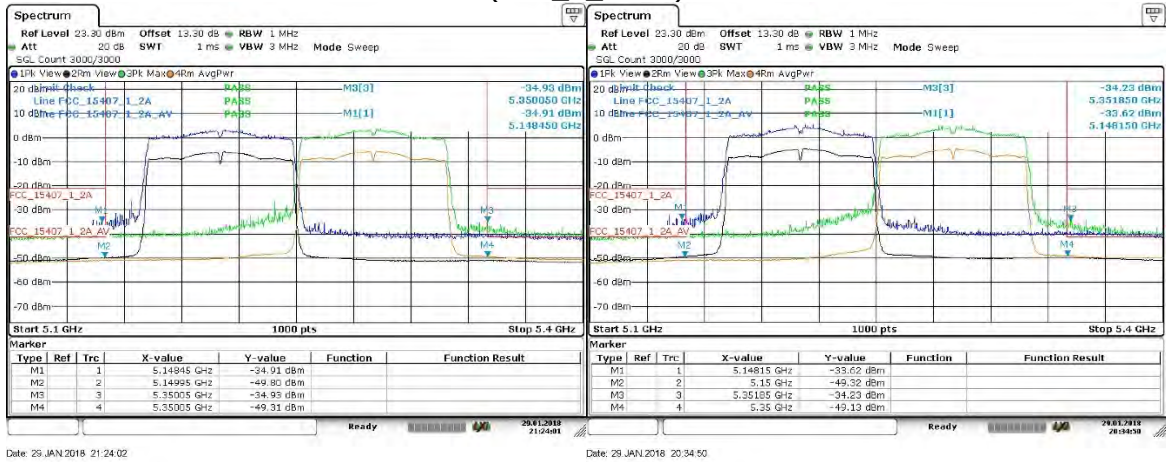

Core 0 Band 1/2A lowest / highest

Core 1 Band 1/2A lowest / highest

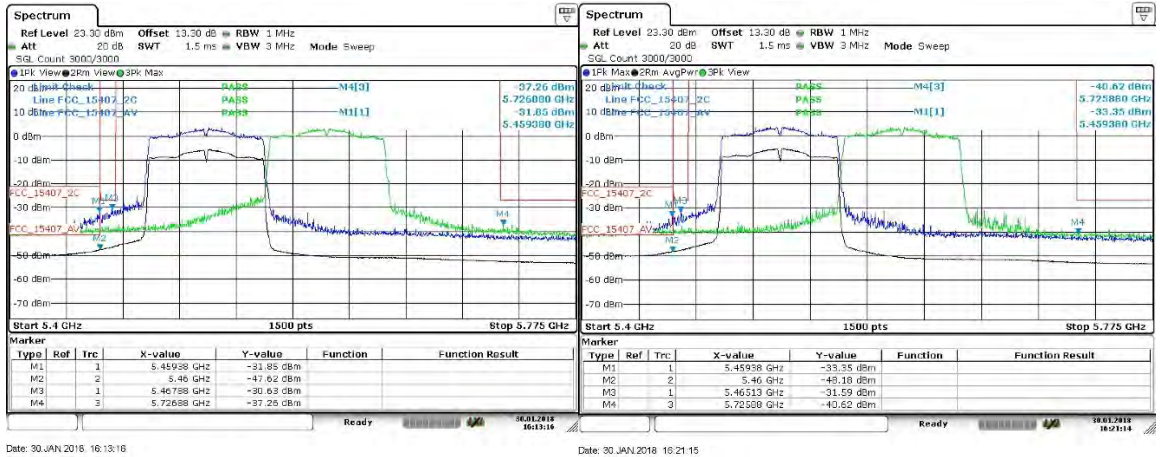

Core 0 Band 2C lowest / highest

Core 1 Band 2C lowest / highest



Core 0 Band 3 lowest / highest

Core 1 Band 3 lowest / highest

4.8.3 TEST EQUIPMENT USED

- Radiated Emissions
- R&S TS8997

4.9 DYNAMIC FREQUENCY SELECTION

Standard **FCC Part 15 Subpart E**

The test was performed according to:
ANSI C63.10

4.9.1 TEST DESCRIPTION

The Equipment Under Test (EUT) was set up in a shielded room for the DFS measurements. Since the EUT is a slave device without radar detection, it was connected to another device acting as master with radar detection.

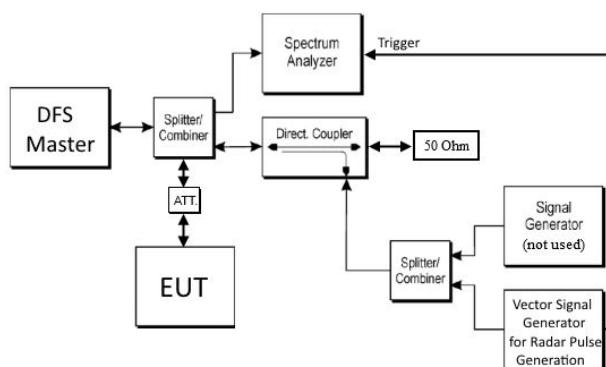

After setting up a connection to the Master using the maximum supported bandwidth of the EUT, a radar pulse of type 0 was sent from the vector signal generator.

At the same time the spectrum analyser is triggered by the vector signal generator and a trace is recorded:

Analyzer settings:

- Resolution Bandwidth (RBW): 3 MHz
- Video Bandwidth (VBW): 3 MHz
- Trace: Clear/Write
- Sweeps: Single Sweep
- Sweptime: 20 s
- Detector: Peak
- Trigger: External

In addition to the plot also the trace data is recorded to calculate the Channel Closing Time.

Afterwards the test is repeated with a sweep time of 32 minutes to monitor the Non-occupancy period.

4.9.2 TEST REQUIREMENTS / LIMITS

Limits according KDB 905462 D02 UNII DFS Compliance Procedures New Rules

Parameter	Value
<i>Non-occupancy period</i>	Minimum 30 minutes
<i>Channel Availability Check Time</i>	60 seconds
<i>Channel Move Time</i>	10 seconds See Note 1.
<i>Channel Closing Transmission Time</i>	200 milliseconds + an aggregate of 60 milliseconds over remaining 10 second period. See Notes 1 and 2.
<p>Note 1: <i>Channel Move Time</i> and the <i>Channel Closing Transmission Time</i> should be performed with Radar Type 0. The measurement timing begins at the end of the Radar Type 0 burst.</p> <p>Note 2: The <i>Channel Closing Transmission Time</i> is comprised of 200 milliseconds starting at the beginning of the <i>Channel Move Time</i> plus any additional intermittent control signals required to facilitate a <i>Channel</i> move (an aggregate of 60 milliseconds) during the remainder of the 10 second period. The aggregate duration of control signals will not count quiet periods in between transmissions.</p>	

4.9.3 TEST PROTOCOL

Ambient temperature: 24 °C
Air Pressure: 1002 hPa
Humidity: 30 %

WLAN ac-Mode; 80 MHz						
Ch. No.	Ch. Center Freq. [MHz]	Aggregate Transmission Time from 200 ms to 10 s after end of radar pulse [ms]	Limit [ms]	Margin [ms]	Channel move time within 10 s	Transmissions within Non-occupancy period
106	5530	4.7	60.0	55.3	yes	none

Remark: Please see next sub-clause for the measurement plot.

4.9.4 MEASUREMENT PLOT (SHOWING THE HIGHEST VALUE, "WORST CASE")

(S01_3_AA01)

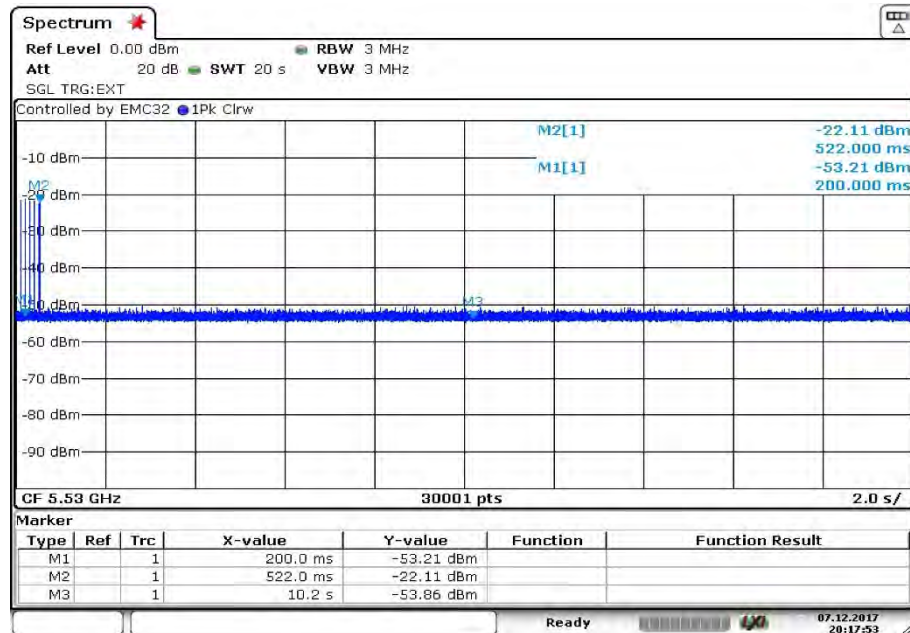

Date: 7.DEC.2017 20:17:53

Channel Closing Time

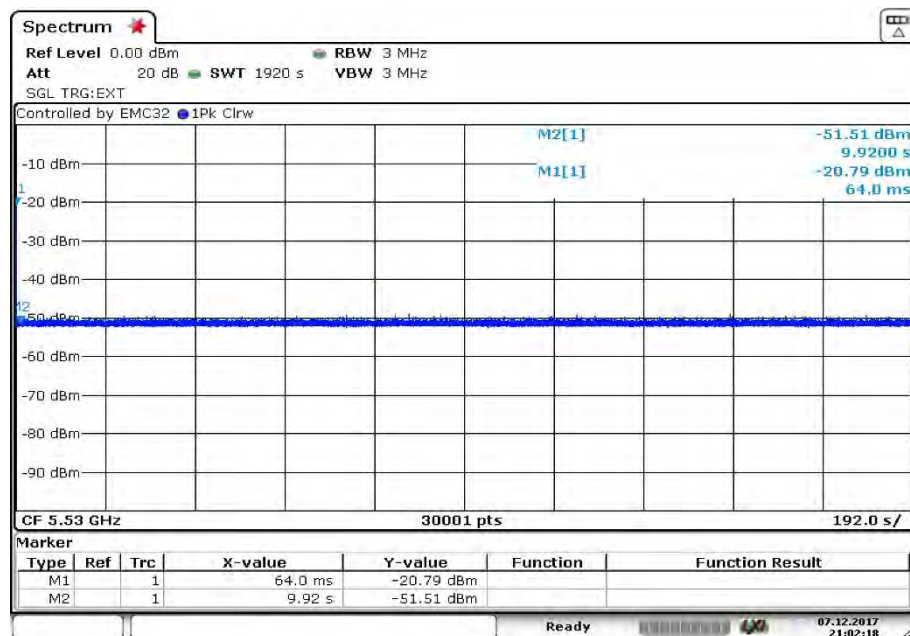

Date: 7.DEC.2017 21:02:19

Non Occupancy Period

4.9.5 TEST EQUIPMENT USED

- R&S TS8997

5 TEST EQUIPMENT

1 R&S TS8997
EN300328/301893 Test Lab

Ref.No.	Device Name	Description	Manufacturer	Serial Number	Last Calibration	Calibration Due
1.1	SMB100A	Signal Generator 9 kHz - 6 GHz	Rohde & Schwarz	107695	2017-07	2020-07
1.2	MFS	Rubidium Frequency Standard	Datum-Beverly	5489/001	2017-07	2018-07
1.3	1515 / 93459	Broadband Power Divider SMA (Aux)	Weinschel Associates	LN673		
1.4	FSV30	Signal Analyzer 10 Hz - 30 GHz	Rohde & Schwarz	103005	2016-02	2018-02
1.5	Fluke 177	Digital Multimeter 03 (Multimeter)	Fluke Europe B.V.	86670383	2016-02	2018-02
1.6	VT 4002	Climatic Chamber	Vötsch	58566002150010	2016-03	2018-03
1.7	A8455-4	4 Way Power Divider (SMA)		-		
1.8	Opus10 THI (8152.00)	ThermoHygro Datalogger 03 (Environ)	Lufft Mess- und Regeltechnik GmbH	7482	2017-03	2019-03
1.9	SMBV100A	Vector Signal Generator 9 kHz - 6 GHz	Rohde & Schwarz	259291	2016-10	2019-10
1.10	OSP120	Switching Unit with integrated power meter	Rohde & Schwarz	101158	2016-11	2018-11

2 Radiated Emissions
Lab to perform radiated emission tests

Ref.No.	Device Name	Description	Manufacturer	Serial Number	Last Calibration	Calibration Due
2.1	NRV-Z1	Sensor Head A	Rohde & Schwarz	827753/005	2017-05	2018-05
2.2	MFS	Rubidium Frequency Normal MFS	Datum GmbH	002	2017-10	2018-10
2.3	Opus10 TPR (8253.00)	ThermoAirpressure Datalogger 13 (Environ)	Lufft Mess- und Regeltechnik GmbH	13936	2017-04	2019-04
2.4	Anechoic Chamber	10.58 x 6.38 x 6.00 m ³	Frankonia	none	2016-05	2019-05
2.5	HL 562	Ultralog new biconicals	Rohde & Schwarz	830547/003	2015-06	2018-06
2.6	5HC2700/12750 -1.5-KK	High Pass Filter	Trilithic	9942012		
2.7	ASP 1.2/1.8-10 kg	Antenna Mast	Maturo GmbH	-		

Ref.No.	Device Name	Description	Manufacturer	Serial Number	Last Calibration	Calibration Due
2.8	Fully Anechoic Room	8.80m x 4.60m x 4.05m (l x w x h)	Albatross Projects	P26971-647-001-PRB	2015-06	2018-06
2.9	Fluke 177	Digital Multimeter 03 (Multimeter)	Fluke Europe B.V.	86670383	2016-02	2018-02
2.10	JS4-18002600-32-5P	Broadband Amplifier 18 GHz - 26 GHz	Miteq	849785		
2.11	FSW 43	Spectrum Analyzer	Rohde & Schwarz	103779	2016-12	2018-12
2.12	3160-09	Standard Gain / Pyramidal Horn Antenna 26.5 GHz	EMCO Elektronik GmbH	00083069		
2.13	WHKX 7.0/18G-8SS	High Pass Filter	Wainwright	09		
2.14	4HC1600/12750-1.5-KK	High Pass Filter	Trilithic	9942011		
2.15	Chroma 6404	AC Power Source	Chroma ATE INC.	64040001304		
2.16	JS4-00102600-42-5A	Broadband Amplifier 30 MHz - 26 GHz	Miteq	619368		
2.17	TT 1.5 WI	Turn Table	Maturo GmbH	-		
2.18	HL 562 Ultralog	Log.-per. Antenna	Rohde & Schwarz	100609	2016-04	2019-04
2.19	3160-10	Standard Gain / Pyramidal Horn Antenna 40 GHz	EMCO Elektronik GmbH	00086675		
2.20	5HC3500/18000-1.2-KK	High Pass Filter	Trilithic	200035008		
2.21	HFH2-Z2	Loop Antenna	Rohde & Schwarz	829324/006	2014-11	2017-11
2.22	Opus10 THI (8152.00)	ThermoHygro Datalogger 12 (Environ)	Lufft Mess- und Regeltechnik GmbH	12482	2017-03	2019-03
2.23	ESR 7	EMI Receiver / Spectrum Analyzer	Rohde & Schwarz	101424	2016-11	2018-11
2.24	JS4-00101800-35-5P	Broadband Amplifier 30 MHz - 18 GHz	Miteq	896037		
2.25	AS 620 P	Antenna mast	HD GmbH	620/37		
2.26	Tilt device Maturo (Rohacell)	Antrieb TD1.5-10kg	Maturo GmbH	TD1.5-10kg/024/3790709		
2.27	ESIB 26	Spectrum Analyzer	Rohde & Schwarz	830482/004	2015-12	2017-12
2.28	PAS 2.5 - 10 kg	Antenna Mast	Maturo GmbH	-		
2.29	AM 4.0	Antenna mast	Maturo GmbH	AM4.0/180/11920513		
2.30	HF 907	Double-ridged horn	Rohde & Schwarz	102444	2015-05	2018-05

The calibration interval is the time interval between "Last Calibration" and "Calibration Due"

6 ANTENNA FACTORS, CABLE LOSS AND SAMPLE CALCULATIONS

This chapter contains the antenna factors with their corresponding path loss of the used measurement path for all antennas as well as the insertion loss of the LISN.

6.1 LISN R&S ESH3-Z5 (150 KHZ – 30 MHZ)

Frequency MHz	Corr. dB	LISN insertion loss ESH3- Z5 dB	cable loss (incl. 10 dB atten- uator) dB
0.15	10.1	0.1	10.0
5	10.3	0.1	10.2
7	10.5	0.2	10.3
10	10.5	0.2	10.3
12	10.7	0.3	10.4
14	10.7	0.3	10.4
16	10.8	0.4	10.4
18	10.9	0.4	10.5
20	10.9	0.4	10.5
22	11.1	0.5	10.6
24	11.1	0.5	10.6
26	11.2	0.5	10.7
28	11.2	0.5	10.7
30	11.3	0.5	10.8

Sample calculation

$$U_{\text{LISN}} (\text{dB } \mu\text{V}) = U (\text{dB } \mu\text{V}) + \text{Corr. (dB)}$$

U = Receiver reading

LISN Insertion loss = Voltage Division Factor of LISN

Corr. = sum of single correction factors of used LISN, cables, switch units (if used)

Linear interpolation will be used for frequencies in between the values in the table.

6.3 ANTENNA R&S HL562 (30 MHZ – 1 GHZ)

($d_{Limit} = 3\text{ m}$)

Frequency	AF R&S HL562	Corr.
MHz	dB (1/m)	dB
30	18.6	0.6
50	6.0	0.9
100	9.7	1.2
150	7.9	1.6
200	7.6	1.9
250	9.5	2.1
300	11.0	2.3
350	12.4	2.6
400	13.6	2.9
450	14.7	3.1
500	15.6	3.2
550	16.3	3.5
600	17.2	3.5
650	18.1	3.6
700	18.5	3.6
750	19.1	4.1
800	19.6	4.1
850	20.1	4.4
900	20.8	4.7
950	21.1	4.8
1000	21.6	4.9

cable loss 1 (inside chamber)	cable loss 2 (outside chamber)	cable loss 3 (switch unit)	cable loss 4 (to receiver)	distance corr. (-20 dB/decade)	d_{Limit} (meas. distance (limit))	d_{used} (meas. distance (used))
dB	dB	dB	dB	dB	m	m
0.29	0.04	0.23	0.02	0.0	3	3
0.39	0.09	0.32	0.08	0.0	3	3
0.56	0.14	0.47	0.08	0.0	3	3
0.73	0.20	0.59	0.12	0.0	3	3
0.84	0.21	0.70	0.11	0.0	3	3
0.98	0.24	0.80	0.13	0.0	3	3
1.04	0.26	0.89	0.15	0.0	3	3
1.18	0.31	0.96	0.13	0.0	3	3
1.28	0.35	1.03	0.19	0.0	3	3
1.39	0.38	1.11	0.22	0.0	3	3
1.44	0.39	1.20	0.19	0.0	3	3
1.55	0.46	1.24	0.23	0.0	3	3
1.59	0.43	1.29	0.23	0.0	3	3
1.67	0.34	1.35	0.22	0.0	3	3
1.67	0.42	1.41	0.15	0.0	3	3
1.87	0.54	1.46	0.25	0.0	3	3
1.90	0.46	1.51	0.25	0.0	3	3
1.99	0.60	1.56	0.27	0.0	3	3
2.14	0.60	1.63	0.29	0.0	3	3
2.22	0.60	1.66	0.33	0.0	3	3
2.23	0.61	1.71	0.30	0.0	3	3

($d_{Limit} = 10\text{ m}$)

30	18.6	-9.9
50	6.0	-9.6
100	9.7	-9.2
150	7.9	-8.8
200	7.6	-8.6
250	9.5	-8.3
300	11.0	-8.1
350	12.4	-7.9
400	13.6	-7.6
450	14.7	-7.4
500	15.6	-7.2
550	16.3	-7.0
600	17.2	-6.9
650	18.1	-6.9
700	18.5	-6.8
750	19.1	-6.3
800	19.6	-6.3
850	20.1	-6.0
900	20.8	-5.8
950	21.1	-5.6
1000	21.6	-5.6

0.29	0.04	0.23	0.02	-10.5	10	3
0.39	0.09	0.32	0.08	-10.5	10	3
0.56	0.14	0.47	0.08	-10.5	10	3
0.73	0.20	0.59	0.12	-10.5	10	3
0.84	0.21	0.70	0.11	-10.5	10	3
0.98	0.24	0.80	0.13	-10.5	10	3
1.04	0.26	0.89	0.15	-10.5	10	3
1.18	0.31	0.96	0.13	-10.5	10	3
1.28	0.35	1.03	0.19	-10.5	10	3
1.39	0.38	1.11	0.22	-10.5	10	3
1.44	0.39	1.20	0.19	-10.5	10	3
1.55	0.46	1.24	0.23	-10.5	10	3
1.59	0.43	1.29	0.23	-10.5	10	3
1.67	0.34	1.35	0.22	-10.5	10	3
1.67	0.42	1.41	0.15	-10.5	10	3
1.87	0.54	1.46	0.25	-10.5	10	3
1.90	0.46	1.51	0.25	-10.5	10	3
1.99	0.60	1.56	0.27	-10.5	10	3
2.14	0.60	1.63	0.29	-10.5	10	3
2.22	0.60	1.66	0.33	-10.5	10	3
2.23	0.61	1.71	0.30	-10.5	10	3

Sample calculation

$$E \text{ (dB } \mu\text{V/m)} = U \text{ (dB } \mu\text{V)} + \text{AF (dB 1/m)} + \text{Corr. (dB)}$$

U = Receiver reading

AF = Antenna factor

Corr. = sum of single correction factors of used cables, switch unit, distance correction, amplifier (if applicable)

distance correction = $-20 * \text{LOG} (d_{Limit} / d_{used})$

Linear interpolation will be used for frequencies in between the values in the table.

Tables show an extract of values.

6.4 ANTENNA R&S HF907 (1 GHZ – 18 GHZ)

Frequency MHz	AF R&S HF907 dB (1/m)	Corr. dB
1000	24.4	-19.4
2000	28.5	-17.4
3000	31.0	-16.1
4000	33.1	-14.7
5000	34.4	-13.7
6000	34.7	-12.7
7000	35.6	-11.0

cable loss 1 (relay + cable inside chamber) dB	cable loss 2 (outside chamber) dB	cable loss 3 (switch unit, atten- uator & pre-amp) dB	cable loss 4 (to receiver) dB
0.99	0.31	-21.51	0.79
1.44	0.44	-20.63	1.38
1.87	0.53	-19.85	1.33
2.41	0.67	-19.13	1.31
2.78	0.86	-18.71	1.40
2.74	0.90	-17.83	1.47
2.82	0.86	-16.19	1.46

Frequency MHz	AF R&S HF907 dB (1/m)	Corr. dB
3000	31.0	-23.4
4000	33.1	-23.3
5000	34.4	-21.7
6000	34.7	-21.2
7000	35.6	-19.8

cable loss 1 (relay inside chamber) dB	cable loss 2 (inside chamber) dB	cable loss 3 (outside chamber) dB	cable loss 4 (switch unit, atten- uator & pre-amp) dB	cable loss 5 (to receiver) dB	used for FCC 15.247
0.47	1.87	0.53	-27.58	1.33	
0.56	2.41	0.67	-28.23	1.31	
0.61	2.78	0.86	-27.35	1.40	
0.58	2.74	0.90	-26.89	1.47	
0.66	2.82	0.86	-25.58	1.46	

Frequency MHz	AF R&S HF907 dB (1/m)	Corr. dB
7000	35.6	-57.3
8000	36.3	-56.3
9000	37.1	-55.3
10000	37.5	-56.2
11000	37.5	-55.3
12000	37.6	-53.7
13000	38.2	-53.5
14000	39.9	-56.3
15000	40.9	-54.1
16000	41.3	-54.1
17000	42.8	-54.4
18000	44.2	-54.7

cable loss 1 (relay inside chamber) dB	cable loss 2 (High Pass) dB	cable loss 3 (pre- amp) dB	cable loss 4 (inside chamber) dB	cable loss 5 (outside chamber) dB	cable loss 6 (to receiver) dB
0.56	1.28	-62.72	2.66	0.94	1.46
0.69	0.71	-61.49	2.84	1.00	1.53
0.68	0.65	-60.80	3.06	1.09	1.60
0.70	0.54	-61.91	3.28	1.20	1.67
0.80	0.61	-61.40	3.43	1.27	1.70
0.84	0.42	-59.70	3.53	1.26	1.73
0.83	0.44	-59.81	3.75	1.32	1.83
0.91	0.53	-63.03	3.91	1.40	1.77
0.98	0.54	-61.05	4.02	1.44	1.83
1.23	0.49	-61.51	4.17	1.51	1.85
1.36	0.76	-62.36	4.34	1.53	2.00
1.70	0.53	-62.88	4.41	1.55	1.91

Sample calculation

$$E \text{ (dB } \mu\text{V/m)} = U \text{ (dB } \mu\text{V)} + \text{AF (dB 1/m)} + \text{Corr. (dB)}$$

U = Receiver reading

AF = Antenna factor

Corr. = sum of single correction factors of used cables, switch unit, distance correction, amplifier (if applicable)

Linear interpolation will be used for frequencies in between the values in the table.

Tables show an extract of values.

6.5 ANTENNA EMCO 3160-09 (18 GHZ – 26.5 GHZ)

Frequency MHz	AF EMCO 3160-09 dB (1/m)	Corr. dB	cable loss 1 (inside chamber) dB	cable loss 2 (pre- amp) dB	cable loss 3 (inside chamber) dB	cable loss 4 (switch unit) dB	cable loss 5 (to receiver) dB
18000	40.2	-23.5	0.72	-35.85	6.20	2.81	2.65
18500	40.2	-23.2	0.69	-35.71	6.46	2.76	2.59
19000	40.2	-22.0	0.76	-35.44	6.69	3.15	2.79
19500	40.3	-21.3	0.74	-35.07	7.04	3.11	2.91
20000	40.3	-20.3	0.72	-34.49	7.30	3.07	3.05
20500	40.3	-19.9	0.78	-34.46	7.48	3.12	3.15
21000	40.3	-19.1	0.87	-34.07	7.61	3.20	3.33
21500	40.3	-19.1	0.90	-33.96	7.47	3.28	3.19
22000	40.3	-18.7	0.89	-33.57	7.34	3.35	3.28
22500	40.4	-19.0	0.87	-33.66	7.06	3.75	2.94
23000	40.4	-19.5	0.88	-33.75	6.92	3.77	2.70
23500	40.4	-19.3	0.90	-33.35	6.99	3.52	2.66
24000	40.4	-19.8	0.88	-33.99	6.88	3.88	2.58
24500	40.4	-19.5	0.91	-33.89	7.01	3.93	2.51
25000	40.4	-19.3	0.88	-33.00	6.72	3.96	2.14
25500	40.5	-20.4	0.89	-34.07	6.90	3.66	2.22
26000	40.5	-21.3	0.86	-35.11	7.02	3.69	2.28
26500	40.5	-21.1	0.90	-35.20	7.15	3.91	2.36

Sample calculation

$$E \text{ (dB } \mu\text{V/m)} = U \text{ (dB } \mu\text{V)} + AF \text{ (dB 1/m)} + Corr. \text{ (dB)}$$

U = Receiver reading

AF = Antenna factor

Corr. = sum of single correction factors of used cables, switch unit, distance correction, amplifier (if applicable)

Linear interpolation will be used for frequencies in between the values in the table.

Table shows an extract of values.

6.6 ANTENNA EMCO 3160-10 (26.5 GHZ – 40 GHZ)

Frequency GHz	AF EMCO 3160-10 dB (1/m)	Corr. dB	cable loss 1 (inside chamber) dB	cable loss 2 (outside chamber) dB	cable loss 3 (switch unit) dB	cable loss 4 (to receiver) dB	distance corr. (-20 dB/ decade) dB	d _{Limit} (meas. distance (limit) m	d _{used} (meas. distance (used) m
26.5	43.4	-11.2	4.4				-15.6	3	0.5
27.0	43.4	-11.2	4.4				-15.6	3	0.5
28.0	43.4	-11.1	4.5				-15.6	3	0.5
29.0	43.5	-11.0	4.6				-15.6	3	0.5
30.0	43.5	-10.9	4.7				-15.6	3	0.5
31.0	43.5	-10.8	4.7				-15.6	3	0.5
32.0	43.5	-10.7	4.8				-15.6	3	0.5
33.0	43.6	-10.7	4.9				-15.6	3	0.5
34.0	43.6	-10.6	5.0				-15.6	3	0.5
35.0	43.6	-10.5	5.1				-15.6	3	0.5
36.0	43.6	-10.4	5.1				-15.6	3	0.5
37.0	43.7	-10.3	5.2				-15.6	3	0.5
38.0	43.7	-10.2	5.3				-15.6	3	0.5
39.0	43.7	-10.2	5.4				-15.6	3	0.5
40.0	43.8	-10.1	5.5				-15.6	3	0.5

Sample calculation

$$E \text{ (dB } \mu\text{V/m)} = U \text{ (dB } \mu\text{V)} + AF \text{ (dB 1/m)} + Corr. \text{ (dB)}$$

U = Receiver reading

AF = Antenna factor

Corr. = sum of single correction factors of used cables, switch unit, distance correction, amplifier (if applicable)

Linear interpolation will be used for frequencies in between the values in the table.

distance correction = $-20 * \text{LOG} (d_{\text{Limit}} / d_{\text{used}})$

Linear interpolation will be used for frequencies in between the values in the table.

Table shows an extract of values.

7 SETUP DRAWINGS

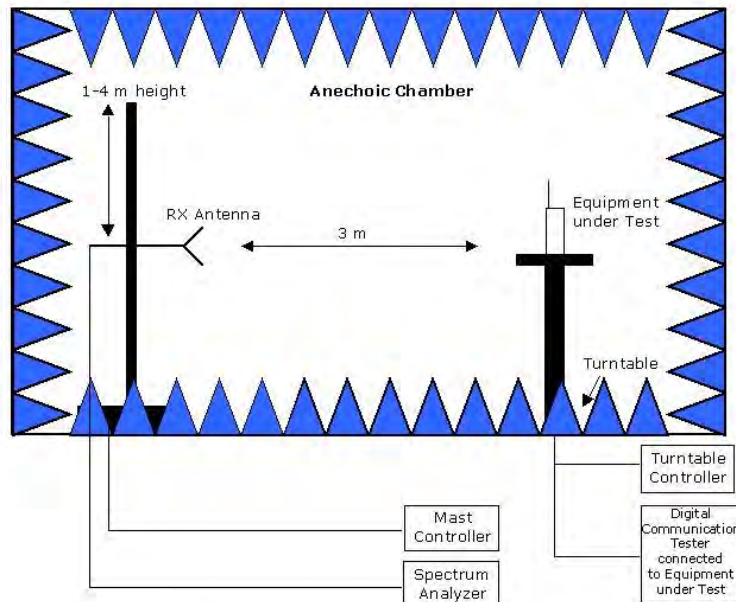

Remark: Depending on the frequency range suitable antenna types, attenuators or preamplifiers are used.

Drawing 1: Setup in the Anechoic chamber. For measurements below 1 GHz the ground was replaced by a conducting groundplane.

8 MEASUREMENT UNCERTAINTIES

Test Case	Parameter	Uncertainty
AC Power Line	Power	± 3.4 dB
Field Strength of spurious radiation	Power	± 5.5 dB
6 dB / 26 dB / 99% Bandwidth	Power Frequency	± 2.9 dB ± 11.2 kHz
Conducted Output Power	Power	± 2.2 dB
Band Edge Compliance	Power Frequency	± 2.2 dB ± 11.2 kHz
Frequency Stability	Frequency	± 25 Hz
Power Spectral Density	Power	± 2.2 dB

9 PHOTO REPORT

Please see separate photo report.