

FCC Measurement/Technical Report on WLAN and Bluetooth Module JODY-W164-27A

FCC ID: XPYJODYW164-07A

IC: 8595A-JODYW16407A

PMN: JODY-W164-27A

HVIN: JODY-W164-27A

Test Report Reference: MDE_UBLOX_2104_FCC_01_rev02

Test Laboratory:

7layers GmbH
Borsigstrasse 11
40880 Ratingen
Germany



Deutsche
Akkreditierungsstelle
D-PL-12140-01-01
D-PL-12140-01-02
D-PL-12140-01-03

Note:

The following test results relate only to the devices specified in this document. This report shall not be reproduced in parts without the written approval of the test laboratory.

7layers GmbH
Borsigstraße 11
40880 Ratingen, Germany
T +49 (0) 2102 749 0
F +49 (0) 2102 749 350

Geschäftsführer/
Managing Directors:
Frank Spiller
Bernhard Retka
Alexandre Norré-Oudard

Registergericht/registered:
Düsseldorf HRB 75554
USt-Id.-Nr./VAT-No. DE203159652
Steuer-Nr./TAX-No. 147/5869/0385

*a Bureau Veritas
Group Company*

www.7layers.com

Table of Contents

1	Applied Standards and Test Summary	3
1.1	Applied Standards	3
1.2	FCC-IC Correlation Table	4
1.3	Measurement Summary	5
2	Revision History / Signatures	7
3	Administrative Data	8
3.1	Testing Laboratory	8
3.2	Project Data	8
3.3	Applicant Data	8
3.4	Manufacturer Data	9
4	Test object Data	10
4.1	General EUT Description	10
4.2	EUT Main components	11
4.3	Ancillary Equipment	11
4.4	Auxiliary Equipment	11
4.5	EUT Setups	12
4.6	Operating Modes / Test Channels	12
4.7	Product labelling	12
5	Test Results	13
5.1	Occupied Bandwidth (6 dB)	13
5.2	Occupied Bandwidth (99%)	19
5.3	Band Edge Compliance Restricted Bands	25
5.4	Transmitter Spurious Radiated Emissions	34
6	Test Equipment	43
7	Antenna Factors, Cable Loss and Sample Calculations	45
7.1	LISN R&S ESH3-Z5 (150 kHz – 30 MHz)	45
7.2	Antenna R&S HFH2-Z2 (9 kHz – 30 MHz)	46
7.3	Antenna R&S HL562 (30 MHz – 1 GHz)	47
7.4	Antenna R&S HF907 (1 GHz – 18 GHz)	48
7.5	Antenna EMCO 3160-09 (18 GHz – 26.5 GHz)	49
7.6	Antenna EMCO 3160-10 (26.5 GHz – 40 GHz)	50
8	Measurement Uncertainties	51
9	Photo Report	52

1 APPLIED STANDARDS AND TEST SUMMARY

1.1 APPLIED STANDARDS

Type of Authorization

Certification for an Intentional Radiator.

Applicable FCC Rules

Prepared in accordance with the requirements of FCC Rules and Regulations as listed in 47 CFR Ch.1 Parts 2 and 15 (10-1-19 Edition). The following subparts are applicable to the results in this test report.

Part 2, Subpart J - Equipment Authorization Procedures, Certification

Part 15, Subpart C – Intentional Radiators

§ 15.201 Equipment authorization requirement

§ 15.207 Conducted limits

§ 15.209 Radiated emission limits; general requirements

§ 15.247 Operation within the bands 902-928 MHz, 2400-2483.5 MHz

Note:

The tests were selected and performed with reference to the FCC Public Notice "Guidance for Compliance Measurements on Digital Transmission System, Frequency Hopping Spread Spectrum System, and Hybrid System Devices Operating under Section 15.247 of the FCC Rules, 558074 D01 15.247 Meas Guidance v05r02, 2019-04-02". ANSI C63.10-2013 is applied.

1.2 FCC-IC CORRELATION TABLE

Correlation of measurement requirements for DTS (e.g. WLAN 2.4 GHz, BT LE) equipment from FCC and IC

DTS equipment

Measurement	FCC reference	IC reference
Conducted emissions on AC Mains	§ 15.207	RSS-Gen Issue 5: 8.8
Occupied bandwidth	§ 15.247 (a) (2)	RSS-247 Issue 2: 5.2 (a)
Peak conducted output power	§ 15.247 (b) (3), (4)	RSS-247 Issue 2: 5.4 (d)
Transmitter spurious RF conducted emissions	§ 15.247 (d)	RSS-Gen Issue 5: 6.13 / 8.9/8.10; RSS-247 Issue 2: 5.5
Transmitter spurious radiated emissions	§ 15.247 (d); § 15.209 (a)	RSS-Gen Issue 5: 6.13 / 8.9/8.10; RSS-247 Issue 2: 5.5
Band edge compliance	§ 15.247 (d)	RSS-247 Issue 2: 5.5
Power density	§ 15.247 (e)	RSS-247 Issue 2: 5.2 (b)
Antenna requirement	§ 15.203 / 15.204	RSS-Gen Issue 5: 8.3
Receiver spurious emissions	-	-

1.3 MEASUREMENT SUMMARY

47 CFR CHAPTER I FCC PART 15 Subpart C §15.247

§ 15.247 (a) (2)

Occupied Bandwidth (6 dB)

The measurement was performed according to ANSI C63.10

Final Result

OP-Mode	Setup	Date	FCC	IC
Radio Technology, Operating Frequency				
Bluetooth LE 1 Mbps, high	S01_AA01	2021-05-06	Passed	Passed
Bluetooth LE 1 Mbps, low	S01_AA01	2021-05-06	Passed	Passed
Bluetooth BDR, high	S01_AA01	2021-05-08	Passed	Passed
Bluetooth BDR, low	S01_AA01	2021-05-08	Passed	Passed
Bluetooth EDR 2, high	S01_AA01	2021-05-08	Passed	Passed
Bluetooth EDR 2, low	S01_AA01	2021-05-08	Passed	Passed
Bluetooth EDR 3, high	S01_AA01	2021-05-08	Passed	Passed
Bluetooth EDR 3, low	S01_AA01	2021-05-08	Passed	Passed
WLAN b, high	S01_AA01	2021-05-06	Passed	Passed
WLAN b, low	S01_AA01	2021-05-06	Passed	Passed
WLAN g, high	S01_AA01	2021-05-06	Passed	Passed
WLAN g, low	S01_AA01	2021-05-06	Passed	Passed
WLAN n 20 MHz, high	S01_AA01	2021-05-06	Passed	Passed
WLAN n 20 MHz, low	S01_AA01	2021-05-06	Passed	Passed

47 CFR CHAPTER I FCC PART 15 Subpart C §15.247

IC RSS-Gen & IC TRC-43; Ch. 6.7 & Ch. 8

Occupied Bandwidth (99%)

The measurement was performed according to ANSI C63.10

Final Result

OP-Mode	Setup	Date	FCC	IC
Radio Technology, Operating Frequency				
Bluetooth BDR, high	S01_AA01	2021-05-06	N/A	Performed
Bluetooth BDR, low	S01_AA01	2021-05-06	N/A	Performed
Bluetooth EDR 2, high	S01_AA01	2021-05-06	N/A	Performed
Bluetooth EDR 2, low	S01_AA01	2021-05-06	N/A	Performed
Bluetooth EDR 3, high	S01_AA01	2021-05-06	N/A	Performed
Bluetooth EDR 3, low	S01_AA01	2021-05-06	N/A	Performed
Bluetooth LE 1 Mbps, high	S01_AA01	2021-05-06	N/A	Performed
Bluetooth LE 1 Mbps, low	S01_AA01	2021-05-06	N/A	Performed
WLAN b, high	S01_AA01	2021-05-06	N/A	Performed
WLAN b, low	S01_AA01	2021-05-06	N/A	Performed
WLAN g, high	S01_AA01	2021-05-06	N/A	Performed
WLAN g, low	S01_AA01	2021-05-06	N/A	Performed
WLAN n 20 MHz, high	S01_AA01	2021-05-06	N/A	Performed
WLAN n 20 MHz, low	S01_AA01	2021-05-06	N/A	Performed

47 CFR CHAPTER I FCC PART 15 § 15.247 (d)
Subpart C §15.247

Band Edge Compliance Restricted Bands Conducted

The measurement was performed according to ANSI C63.10

Final Result

OP-Mode Radio Technology, Operating Frequency, Band Edge	Setup	Date	FCC	IC
Bluetooth BDR, high, high	S01_AA01	2021-04-28	Passed	Passed
Bluetooth EDR 2, high, high	S01_AA01	2021-04-28	Passed	Passed
Bluetooth EDR 3, high, high	S01_AA01	2021-04-28	Passed	Passed
Bluetooth LE 1 Mbps, high, high	S01_AA01	2021-05-08	Passed	Passed
WLAN b, high, high	S01_AA01	2021-04-28	Passed	Passed
WLAN g, high, high	S01_AA01	2021-04-28	Passed	Passed
WLAN n 20 MHz, high, high	S01_AA01	2021-04-28	Passed	Passed

47 CFR CHAPTER I FCC PART 15 Subpart C § 15.247 (d)
§15.247

Transmitter Spurious Radiated Emissions

The measurement was performed according to ANSI C63.10

Final Result

OP-Mode Radio Technology, Operating Frequency, Measurement range	Setup	Date	FCC	IC
Bluetooth BDR, high, 1 GHz - 26 GHz	S02_AA01	2021-06-03	Passed	Passed
WLAN b, high, 1 GHz - 26 GHz	S02_AA01	2021-06-07	Passed	Passed

N/A: Not applicable
N/P: Not performed

2 REVISION HISTORY / SIGNATURES

Report version control			
Version	Release date	Change Description	Version validity
initial	2021-05-19	--	valid
rev01	2021-06-21	Added spot check transmitter radiated spurious emissions	valid
rev02	2021-07-02	Added HVIN/PMN/End of report/ emission designator/ antenna list	valid

COMMENT: This is a delta test report due to hardware change. Not all tests were performed. See test report MDE_UBLOX_1701_FCCd for results of the other test cases, tested with variant 07, on which the variant of this report is based on.



(responsible for accreditation scope)
Dipl.-Ing. Marco Kullik



(responsible for testing and report)
Dipl.-Ing. Daniel Gall

3 ADMINISTRATIVE DATA

3.1 TESTING LABORATORY

Company Name: 7layers GmbH
Address: Borsigstr. 11
40880 Ratingen
Germany

The test facility is accredited by the following accreditation organisation:

Laboratory accreditation no: DAKKS D-PL-12140-01-01 | -02 | -03
FCC Designation Number: DE0015
FCC Test Firm Registration: 929146
ISED CAB Identifier: DE0007; ISED#: 3699A
Responsible for accreditation scope: Dipl.-Ing. Marco Kullik
Report Template Version: 2021-01-13

3.2 PROJECT DATA

Responsible for testing and report: Dipl.-Ing. Daniel Gall
Employees who performed the tests: documented internally at 7Layers
Date of Report: 2021-06-21
Testing Period: 2021-04-28 to 2021-06-07

3.3 APPLICANT DATA

Company Name: u-blox AG
Address: Zürcherstrasse 68
8800 Thalwil
Switzerland
Contact Person: Filip Kruzela

3.4 MANUFACTURER DATA

Company Name: please see Applicant Data

Address:

Contact Person:

4 TEST OBJECT DATA

4.1 GENERAL EUT DESCRIPTION

Kind of Device product description	The EUT is a module supporting WLAN in the 2.4 GHz and 5 GHz bands as well as Bluetooth (BT) 4.2 including Bluetooth Low Energy (BT LE)														
Product name	27A WLAN and Bluetooth Module														
Type	JODY-W164-27A														
Declared EUT data by the supplier															
Voltage Type	DC														
Voltage Level	3.3 V														
Antenna / Gain	Description	Model	S/N:												
	Dipole Antenna	LSR 001-0012	-												
	Dipole Antenna	LSR 001-0009	-												
	PCB Antenna	TE Connectivity 2118060-1	-												
None provided, two external 50 Ohm connectors on evaluation board. Antenna gain used for evaluation of test results: 2 dBi															
Tested Modulation Type and Data Rates	BT: GFSK Modulation, DHx packets (Bluetooth and Bluetooth Low Energy), 1 Mbps n/4 DQPSK Modulation, 2-DHx packets, 2 Mbps 8-DPSK Modulation, 3-DHx packets, 3 Mbps WLAN: Mode b: DSSS Modulation, 1Mbps Mode g/n: OFDM Modulation, 6Mbps / MCS 0 (20 MHz only)														
Specific product description for the EUT	<p>The JODY-W1 is a compact automotive grade module that provides Wi-Fi, Bluetooth, and Bluetooth low energy communication.</p> <p>The JODY-W164-07A module can be operated in the following modes:</p> <p>Wi-Fi (SISO) 802.11ac in 2.4 / 5 GHz real simultaneous dual band Dual-mode Bluetooth v4.2, can be operated fully simultaneous with both Wi-Fi modes</p> <p>It is equipped with two antenna pins connected to two SMA antenna connectors on the evaluation board.</p> <p>Maximum supported band width in 2.4 GHz WLAN mode: 20 MHz, 5 GHz WLAN mode: 80 MHz</p> <table border="1" data-bbox="560 1809 1430 1935"> <thead> <tr> <th>Frequency Band</th> <th>Modulation Method</th> <th>Emission Designators</th> </tr> </thead> <tbody> <tr> <td>2412 - 2462</td> <td>802.11[b]</td> <td>10M1G1D</td> </tr> <tr> <td>2412 - 2462</td> <td>[g]</td> <td>17M7W7D</td> </tr> <tr> <td>2412 - 2462</td> <td>[n]</td> <td>18M6W7D</td> </tr> </tbody> </table>			Frequency Band	Modulation Method	Emission Designators	2412 - 2462	802.11[b]	10M1G1D	2412 - 2462	[g]	17M7W7D	2412 - 2462	[n]	18M6W7D
Frequency Band	Modulation Method	Emission Designators													
2412 - 2462	802.11[b]	10M1G1D													
2412 - 2462	[g]	17M7W7D													
2412 - 2462	[n]	18M6W7D													
EUT ports (connected cables during testing):	DC Power Supply Antenna ports Signal ports														

Special software used for testing	The test modes were set using scripts that were run on a board computer with Linux operating system provided by the applicant.
-----------------------------------	--

4.2 EUT MAIN COMPONENTS

Sample Name	Sample Code	Description
EUT aa01	DE1015139aa01	
Sample Parameter	Value	
Serial No.	M306009C3F494940200	
HW Version	11	
SW Version	SDIO BRAKEPAD release with FW 9.40.112.x. NVRAM jody-w164-07a, 04-12-2018	
Comment		

NOTE: The short description is used to simplify the identification of the EUT in this test report.

4.3 ANCILLARY EQUIPMENT

For the purposes of this test report, ancillary equipment is defined as equipment which is used in conjunction with the EUT to provide operational and control features to the EUT. It is necessary to configure the system in a typical fashion, as a customer would normally use it. But nevertheless Ancillary Equipment can influence the test results.

Device	Details (Manufacturer, Type Model, OUT Code)	Description
Evaluation Board	UBLOX, JODY-W1 EVB Certification board, REV. A, - , -	Board the EUT is mounted to, providing ports to the EUT (DC, Antennas, wired communication)

4.4 AUXILIARY EQUIPMENT

For the purposes of this test report, auxiliary equipment is defined as equipment which is used temporarily to enable operational and control features especially used for the tests of the EUT which is not used during normal operation or equipment that is used during the tests in combination with the EUT but is not subject of this test report. It is necessary to configure the system in a typical fashion, as a customer would normally use it. But nevertheless Auxiliary Equipment can influence the test results.

Device	Details (Manufacturer, Type Model, HW, SW, S/N)	Description
Board Computer	Toradex, Ixora, - , - , -	Computer used for setting test modes and supplying EUT

4.5 EUT SETUPS

This chapter describes the combination of EUTs and equipment used for testing. The rationale for selecting the EUTs, ancillary and auxiliary equipment and interconnecting cables, is to test a representative configuration meeting the requirements of the referenced standards.

Setup	Combination of EUTs	Description and Rationale
S01_AA01	EUT aa01, Evaluation Board, Board Computer,	Conducted measurement setup
S02_AA01	EUT aa01, Evaluation Board,	Radiated measurement setup

4.6 OPERATING MODES / TEST CHANNELS

This chapter describes the operating modes of the EUTs used for testing.

WLAN 20 MHz Test Channels: Channel: Frequency [MHz]	2.4 GHz ISM 2400 - 2483.5 MHz				
	Low ¹⁾		mid	High ¹⁾	
	1	2	6	10	11
	2412	2417	2437	2457	2462

BT Test Channels: Channel: Frequency [MHz]	2.4 GHz ISM 2400 - 2483.5 MHz		
	low	mid	high
	0	39	78
	2402	2441	2480

BT LE Test Channels: Channel: Frequency [MHz]	2.4 GHz ISM 2400 - 2483.5 MHz		
	low	mid	high
	0	19	39
	2402	2440	2480

1) Since in WLAN mode g and n the lowest and highest channels have lower output power than the other channels, additional testing was performed for the second lowest and highest channels in those modes.

4.7 PRODUCT LABELLING

4.7.1 FCC ID LABEL

Please refer to the documentation of the applicant.

4.7.2 LOCATION OF THE LABEL ON THE EUT

Please refer to the documentation of the applicant.

5 TEST RESULTS

5.1 OCCUPIED BANDWIDTH (6 DB)

Standard **FCC Part 15 Subpart C**

The test was performed according to:
ANSI C63.10

5.1.1 TEST DESCRIPTION

The Equipment Under Test (EUT) was set up to perform the occupied bandwidth measurements.

The reference level is the level of the highest amplitude signal observed from the transmitter at either the fundamental frequency or first-order modulation products in all typical modes of operation, including the unmodulated carrier, even if atypical.

The results recorded were measured with the modulation which produce the worst-case (smallest) emission bandwidth.

The EUT was connected to the test system as described in the block diagram below. The complete attenuation of the measurement path is known and considered.

Analyser settings:

- Resolution Bandwidth (RBW): 100 kHz
- Video Bandwidth (VBW): 300 kHz
- Span: Two times nominal bandwidth
- Trace: Maxhold
- Sweeps: Till stable (min. 500, max. 15000)
- Sweeptime: Auto
- Detector: Peak

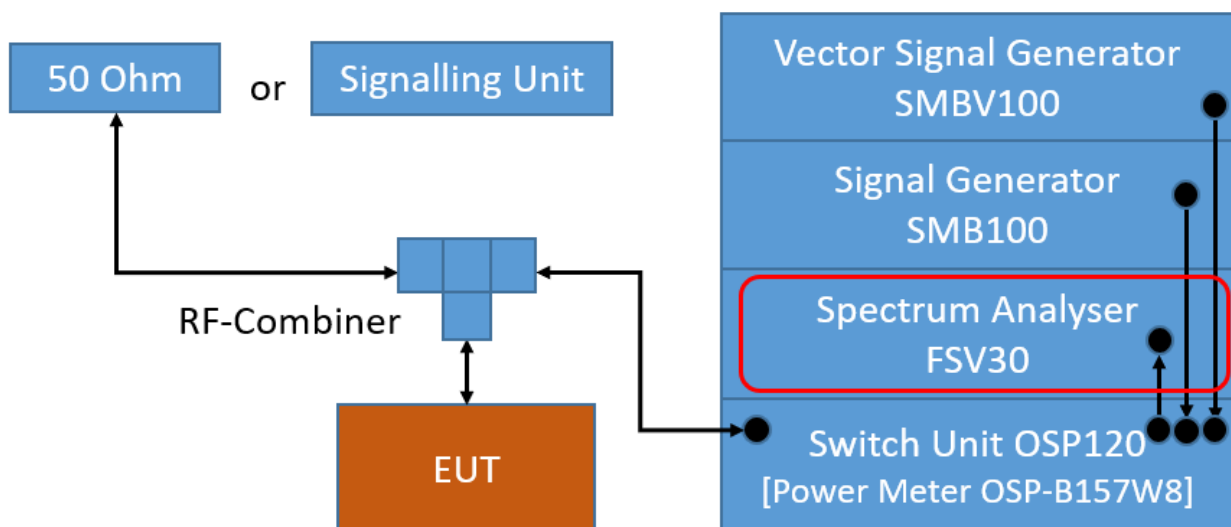

TS8997; Channel Bandwidth

5.1.2 TEST REQUIREMENTS / LIMITS

FCC Part 15, Subpart C, §15.247 (a) (2)

Systems using digital modulation techniques may operate in the 902-928 MHz and 2400-2483.5 MHz bands. The minimum 6 dB bandwidth shall be at least 500 kHz.

5.1.3 TEST PROTOCOL

Ambient temperature: 24 °C
 Air Pressure: 1007 hPa
 Humidity: 28 %
 BT LE 1 Mbit/s

Band / Mode	Channel No.	Frequency [MHz]	6 dB Bandwidth [MHz]	Limit [MHz]	Margin to Limit [MHz]
2.4 GHz ISM	0	2402	0.729	0.5	0.229
	39	2480	0.729	0.5	0.229

BT GFSK (1-DH5)

Band / Mode	Channel No.	Frequency [MHz]	6 dB Bandwidth [MHz]	Limit [MHz]	Margin to Limit [MHz]
2.4 GHz ISM	0	2402	0.505	0.5	0.005
	78	2480	0.505	0.5	0.005

BT π/4 DQPSK (2-DH5)

Band / Mode	Channel No.	Frequency [MHz]	6 dB Bandwidth [MHz]	Limit [MHz]	Margin to Limit [MHz]
2.4 GHz ISM	0	2402	1.040	0.5	0.540
	78	2480	1.099	0.5	0.599

BT 8-DPSK (3-DH5)

Band / Mode	Channel No.	Frequency [MHz]	6 dB Bandwidth [MHz]	Limit [MHz]	Margin to Limit [MHz]
2.4 GHz ISM	0	2402	1.099	0.5	0.599
	78	2480	1.099	0.5	0.599

WLAN b-Mode; 20 MHz; 1 Mbit/s

Band	Channel No.	Frequency [MHz]	6 dB Bandwidth [MHz]	Limit [MHz]	Margin to Limit [MHz]
2.4 GHz ISM	1	2412	7.2	0.5	6.7
	11	2462	7.2	0.5	6.7

WLAN g-Mode; 20 MHz; 6 Mbit/s

Band	Channel No.	Frequency [MHz]	6 dB Bandwidth [MHz]	Limit [MHz]	Margin to Limit [MHz]
2.4 GHz ISM	1	2412	16.2	0.5	15.7
	11	2462	16.1	0.5	15.6

WLAN n-Mode; 20 MHz; MCS0

Band	Channel No.	Frequency [MHz]	6 dB Bandwidth [MHz]	Limit [MHz]	Margin to Limit [MHz]
2.4 GHz ISM	1	2412	17.0	0.5	16.5
	11	2462	16.6	0.5	16.1

Remark: Please see next sub-clause for the measurement plot.

5.1.4 MEASUREMENT PLOT (EXAMPLE PLOT, SHOWING WORST CASE, IF APPLICABLE)

Radio Technology = Bluetooth LE 1 Mbps, Operating Frequency = high (S01_AA01)

6 dB Bandwidth

DUT Frequency (MHz)	Bandwidth (MHz)	Limit Min (MHz)	Limit Max (MHz)	Band Edge Left (MHz)	Band Edge Right (MHz)	Max Level (dBm)	Result
2480.000000	0.728713	0.500000	---	2479.651485	2480.380198	5.7	PASS

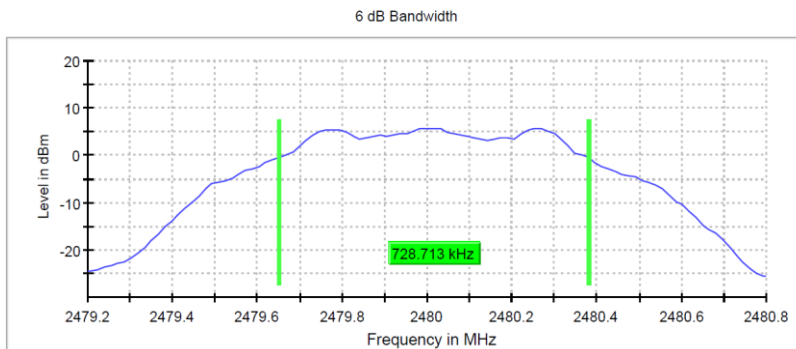

Setting	Instrument Value
Start Frequency	2.47920 GHz
Stop Frequency	2.48080 GHz
Span	1.600 MHz
RBW	100.000 kHz
VBW	300.000 kHz
SweepPoints	101
SweepTime	18.987 μ s
Reference Level	-10.000 dBm
Attenuation	10.000 dB
Detector	MaxPeak
SweepCount	100
Filter	3 dB
Trace Mode	Max Hold
SweepType	FFT
Preamp	off
Stablemode	Trace
Stablevalue	0.50 dB
Run	9 / max. 150
Stable	5 / 5
Max Stable Difference	0.12 dB

Radio Technology = Bluetooth BDR, Operating Frequency = high (S01_AA01)

99 % Bandwidth

DUT Frequency (MHz)	Bandwidth (MHz)	Limit Min (MHz)	Limit Max (MHz)	Band Edge Left (MHz)	Band Edge Right (MHz)	Result
2480.000000	0.885000	---	---	2479.572500	2480.457500	PASS

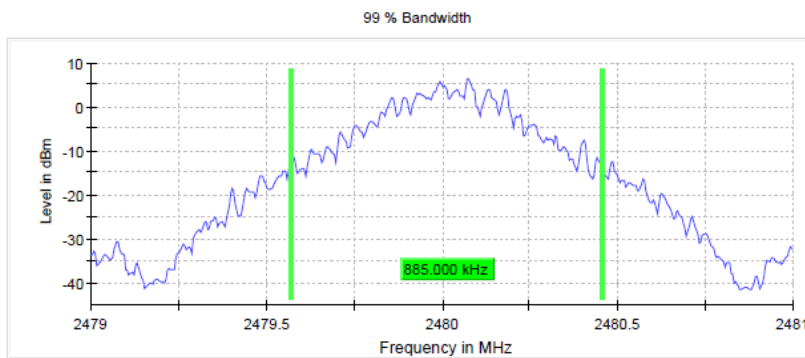

Setting	Instrument Value
Start Frequency	2.47900 GHz
Stop Frequency	2.48100 GHz
Span	2.000 MHz
RBW	10.000 kHz
VBW	30.000 kHz
SweepPoints	400
SweepTime	189.648 μ s
Reference Level	0.000 dBm
Attenuation	20.000 dB
Detector	MaxPeak
SweepCount	500
Filter	3 dB
Trace Mode	Max Hold
SweepType	FFT
Preamp	off
Stablemode	Trace
Stablevalue	0.30 dB
Run	9 / max. 150
Stable	3 / 3
Max Stable Difference	0.25 dB

Radio Technology = Bluetooth EDR2, Operating Frequency = high
(S01_AA01)

99 % Bandwidth

DUT Frequency (MHz)	Bandwidth (MHz)	Limit Min (MHz)	Limit Max (MHz)	Band Edge Left (MHz)	Band Edge Right (MHz)	Result
2480.000000	1.210000	--	--	2479.417500	2480.627500	PASS

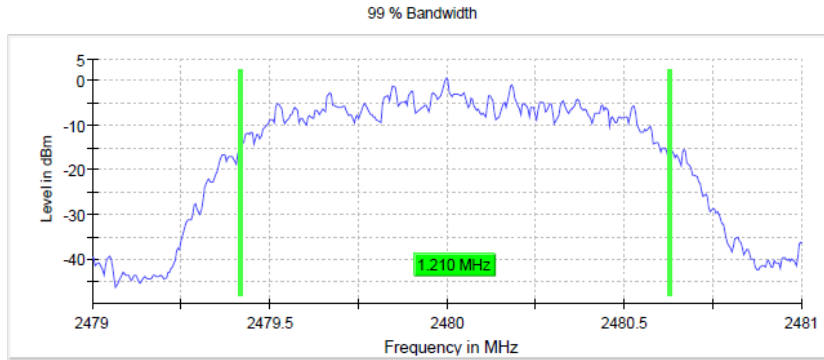

Setting	Instrument Value
Start Frequency	2.47900 GHz
Stop Frequency	2.48100 GHz
Span	2.000 MHz
RBW	10.000 kHz
VBW	30.000 kHz
SweepPoints	400
Sweeptime	189.648 μ s
Reference Level	0.000 dBm
Attenuation	20.000 dB
Detector	MaxPeak
SweepCount	500
Filter	3 dB
Trace Mode	Max Hold
SweepType	FFT
Preamp	off
Stablemode	Trace
Stablevalue	0.30 dB
Run	13 / max. 150
Stable	3 / 3
Max Stable Difference	0.21 dB

Radio Technology = Bluetooth EDR3, Operating Frequency = high
(S01_AA01)

99 % Bandwidth

DUT Frequency (MHz)	Bandwidth (MHz)	Limit Min (MHz)	Limit Max (MHz)	Band Edge Left (MHz)	Band Edge Right (MHz)	Result
2480.000000	1.220000	--	--	2479.402500	2480.622500	PASS

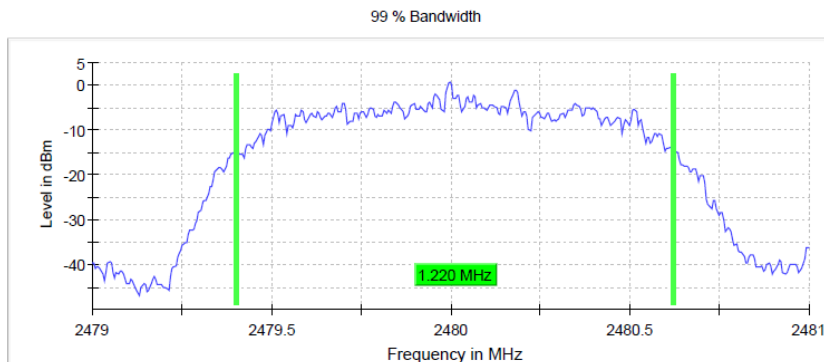

Setting	Instrument Value
Start Frequency	2.47900 GHz
Stop Frequency	2.48100 GHz
Span	2.000 MHz
RBW	10.000 kHz
VBW	30.000 kHz
SweepPoints	400
Sweeptime	189.648 μ s
Reference Level	0.000 dBm
Attenuation	20.000 dB
Detector	MaxPeak
SweepCount	500
Filter	3 dB
Trace Mode	Max Hold
SweepType	FFT
Preamp	off
Stablemode	Trace
Stablevalue	0.30 dB
Run	10 / max. 150
Stable	3 / 3
Max Stable Difference	0.19 dB

Radio Technology = WLAN b, Operating Frequency = high
(S01_AA01)

6 dB Bandwidth

DUT Frequency (MHz)	Bandwidth (MHz)	Limit Min (MHz)	Limit Max (MHz)	Band Edge Left (MHz)	Band Edge Right (MHz)	Max Level (dBm)	Result
2462.000000	7.150000	0.500000	---	2458.425000	2465.575000	8.5	PASS

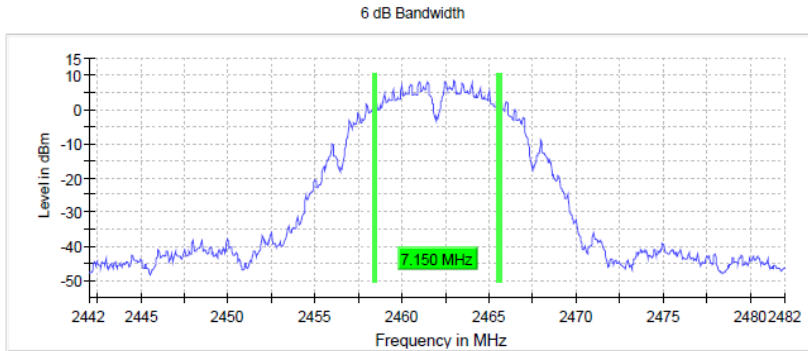

Setting	Instrument Value
Start Frequency	2.44200 GHz
Stop Frequency	2.48200 GHz
Span	40.000 MHz
RBW	100.000 kHz
VBW	300.000 kHz
SweepPoints	800
Sweeptime	56.836 μs
Reference Level	0.000 dBm
Attenuation	20.000 dB
Detector	MaxPeak
SweepCount	100
Filter	3 dB
Trace Mode	Max Hold
Sweeptype	FFT
Preamp	off
Stablemode	Trace
Stablevalue	0.50 dB
Run	18 / max. 150
Stable	5 / 5
Max Stable Difference	0.00 dB

Radio Technology = WLAN g, Operating Frequency = high
(S01_AA01)

6 dB Bandwidth

DUT Frequency (MHz)	Bandwidth (MHz)	Limit Min (MHz)	Limit Max (MHz)	Band Edge Left (MHz)	Band Edge Right (MHz)	Max Level (dBm)	Result
2462.000000	16.100000	0.500000	---	2454.075000	2470.175000	0.3	PASS

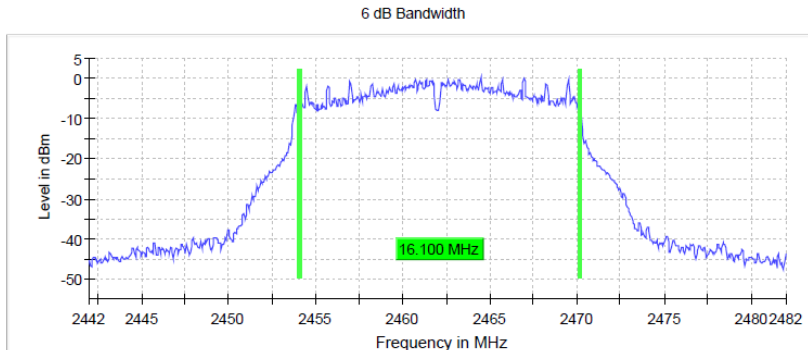

Setting	Instrument Value
Start Frequency	2.44200 GHz
Stop Frequency	2.48200 GHz
Span	40.000 MHz
RBW	100.000 kHz
VBW	300.000 kHz
SweepPoints	800
Sweeptime	56.836 μs
Reference Level	0.000 dBm
Attenuation	20.000 dB
Detector	MaxPeak
SweepCount	100
Filter	3 dB
Trace Mode	Max Hold
Sweeptype	FFT
Preamp	off
Stablemode	Trace
Stablevalue	0.50 dB
Run	31 / max. 150
Stable	5 / 5
Max Stable Difference	0.36 dB

Radio Technology = WLAN n 20 MHz, Operating Frequency = high
(S01_AA01)

6 dB Bandwidth

DUT Frequency (MHz)	Bandwidth (MHz)	Limit Min (MHz)	Limit Max (MHz)	Band Edge Left (MHz)	Band Edge Right (MHz)	Max Level (dBm)	Result
2462.000000	16.600000	0.500000	---	2454.175000	2470.775000	0.2	PASS

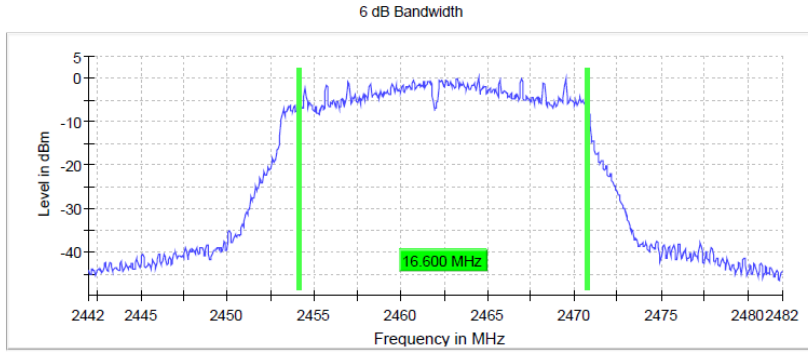

Setting	Instrument Value
Start Frequency	2.44200 GHz
Stop Frequency	2.48200 GHz
Span	40.000 MHz
RBW	100.000 kHz
VBW	300.000 kHz
SweepPoints	800
Sweeptime	56.836 µs
Reference Level	0.000 dBm
Attenuation	20.000 dB
Detector	MaxPeak
SweepCount	100
Filter	3 dB
Trace Mode	Max Hold
Sweeptype	FFT
Preamp	off
Stablemode	Trace
Stablevalue	0.50 dB
Run	67 / max. 150
Stable	5 / 5
Max Stable Difference	0.00 dB

5.1.5 TEST EQUIPMENT USED

- R&S TS8997

5.2 OCCUPIED BANDWIDTH (99%)

Standard **FCC Part 15 Subpart C**

The test was performed according to:
ANSI C63.10

5.2.1 TEST DESCRIPTION

The Equipment Under Test (EUT) was set up to perform the occupied bandwidth measurements.

The reference level is the level of the highest amplitude signal observed from the transmitter at either the fundamental frequency or first-order modulation products in all typical modes of operation, including the unmodulated carrier, even if atypical.

The EUT was connected to the test system as described in the block diagram below. The complete attenuation of the measurement path is known and considered.

Analyser settings:

- Resolution Bandwidth (RBW): 1 to 5 % of the OBW
- Video Bandwidth (VBW): ≥ 3 times the RBW
- Span: 1.5 to 5 times the OBW
- Trace: Maxhold
- Sweeps: Till stable (min. 500, max. 75000)
- Sweeptime: Auto
- Detector: Peak

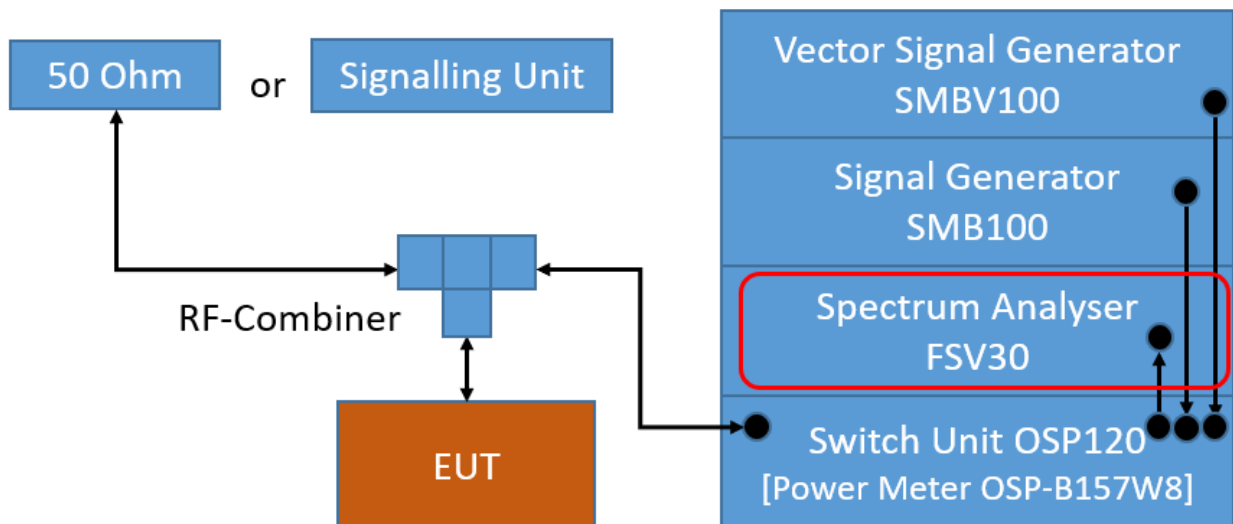

TS8997; Channel Bandwidth

5.2.2 TEST REQUIREMENTS / LIMITS

No applicable limit:

5.2.3 TEST PROTOCOL

Ambient temperature: 24 °C
 Air Pressure: 1007 hPa
 Humidity: 28 %
 BT GFSK (1-DH5)

Band	Channel No.	Frequency [MHz]	99 % Bandwidth [MHz]
2.4 GHz ISM	0	2402	0.885
	78	2480	0.885

BT π/4 DQPSK (2-DH5)

Band	Channel No.	Frequency [MHz]	99 % Bandwidth [MHz]
2.4 GHz ISM	0	2402	1.205
	78	2480	1.210

BT 8-DPSK (3-DH5)

Band	Channel No.	Frequency [MHz]	99 % Bandwidth [MHz]
2.4 GHz ISM	0	2402	1.210
	78	2480	1.220

BT LE 1 Mbit/s

Band	Channel No.	Frequency [MHz]	99 % Bandwidth [MHz]
2.4 GHz ISM	0	2402	1.050
	39	2480	1.050

WLAN b-Mode; 20 MHz; 1 Mbit/s

Band	Channel No.	Frequency [MHz]	99 % Bandwidth [MHz]
2.4 GHz ISM	1	2412	10.3
	11	2462	10.1

WLAN g-Mode; 20 MHz; 6 Mbit/s

Band	Channel No.	Frequency [MHz]	99 % Bandwidth [MHz]
2.4 GHz ISM	1	2412	16.5
	11	2462	16.5

WLAN n-Mode; 20 MHz; MCS0

Band	Channel No.	Frequency [MHz]	99 % Bandwidth [MHz]
2.4 GHz ISM	1	2412	17.7
	11	2462	17.7

Remark: Please see next sub-clause for the measurement plot.

5.2.4 MEASUREMENT PLOT (EXAMPLE PLOT, SHOWING WORST CASE, IF APPLICABLE)

Radio Technology = Bluetooth BDR, Operating Frequency = high (S01_AA01)

99 % Bandwidth

DUT Frequency (MHz)	Bandwidth (MHz)	Limit Min (MHz)	Limit Max (MHz)	Band Edge Left (MHz)	Band Edge Right (MHz)	Result
2480.000000	0.885000	---	---	2479.572500	2480.457500	PASS

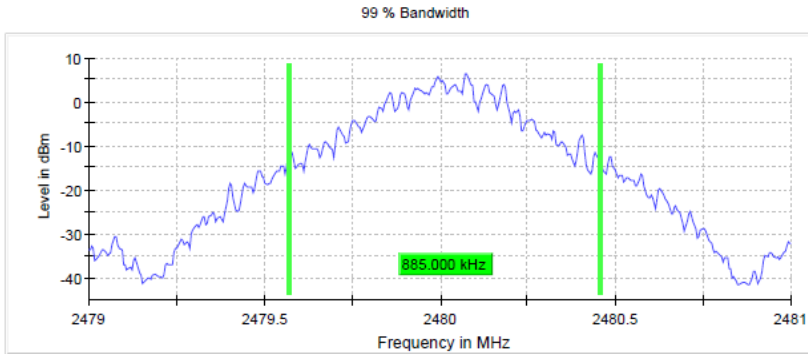

Setting	Instrument Value
Start Frequency	2.47900 GHz
Stop Frequency	2.48100 GHz
Span	2.000 MHz
RBW	10.000 kHz
VBW	30.000 kHz
SweepPoints	400
Sweeptime	189.648 μ s
Reference Level	0.000 dBm
Attenuation	20.000 dB
Detector	MaxPeak
SweepCount	500
Filter	3 dB
Trace Mode	Max Hold
Sweeptype	FFT
Preamp	off
Stablemode	Trace
Stablevalue	0.30 dB
Run	9 / max. 150
Stable	3 / 3
Max Stable Difference	0.25 dB

Radio Technology = Bluetooth EDR 2, Operating Frequency = high (S01_AA01)

99 % Bandwidth

DUT Frequency (MHz)	Bandwidth (MHz)	Limit Min (MHz)	Limit Max (MHz)	Band Edge Left (MHz)	Band Edge Right (MHz)	Result
2480.000000	1.210000	---	---	2479.417500	2480.627500	PASS

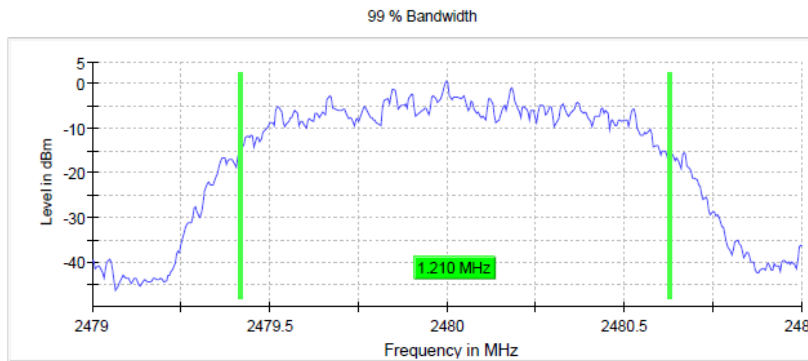

Setting	Instrument Value
Start Frequency	2.47900 GHz
Stop Frequency	2.48100 GHz
Span	2.000 MHz
RBW	10.000 kHz
VBW	30.000 kHz
SweepPoints	400
Sweeptime	189.648 μ s
Reference Level	0.000 dBm
Attenuation	20.000 dB
Detector	MaxPeak
SweepCount	500
Filter	3 dB
Trace Mode	Max Hold
Sweeptype	FFT
Preamp	off
Stablemode	Trace
Stablevalue	0.30 dB
Run	13 / max. 150
Stable	3 / 3
Max Stable Difference	0.21 dB

Radio Technology = Bluetooth EDR 3, Operating Frequency = high
(S01_AA01)

99 % Bandwidth

DUT Frequency (MHz)	Bandwidth (MHz)	Limit Min (MHz)	Limit Max (MHz)	Band Edge Left (MHz)	Band Edge Right (MHz)	Result
2480.000000	1.220000	---	---	2479.402500	2480.622500	PASS

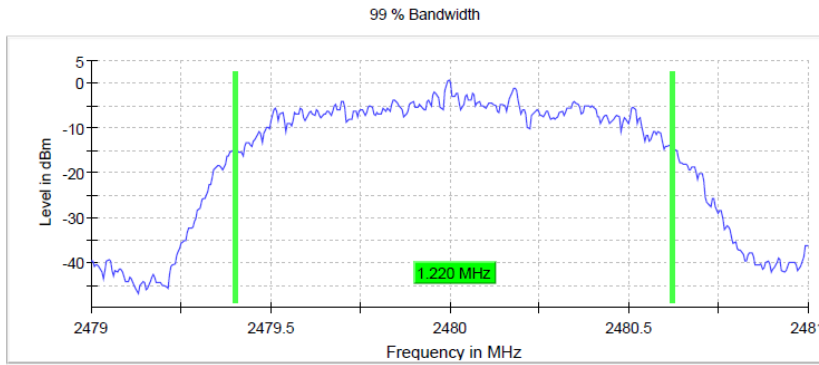

Setting	Instrument Value
Start Frequency	2.47900 GHz
Stop Frequency	2.48100 GHz
Span	2.000 MHz
RBW	10.000 kHz
VBW	30.000 kHz
SweepPoints	400
Sweeptime	189.648 μs
Reference Level	0.000 dBm
Attenuation	20.000 dB
Detector	MaxPeak
SweepCount	500
Filter	3 dB
Trace Mode	Max Hold
SweepType	FFT
Preamp	off
Stablemode	Trace
Stablevalue	0.30 dB
Run	10 / max. 150
Stable	3 / 3
Max Stable Difference	0.19 dB

Radio Technology = Bluetooth LE 1 Mbps, Operating Frequency = high
(S01_AA01)

99 % Bandwidth

DUT Frequency (MHz)	Bandwidth (MHz)	Limit Min (MHz)	Limit Max (MHz)	Band Edge Left (MHz)	Band Edge Right (MHz)	Result
2480.000000	1.050000	---	---	2479.505000	2480.555000	PASS

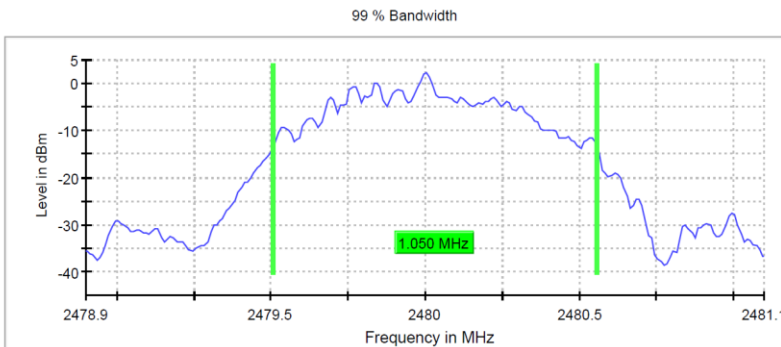

Setting	Instrument Value
Start Frequency	2.47890 GHz
Stop Frequency	2.48110 GHz
Span	2.200 MHz
RBW	20.000 kHz
VBW	100.000 kHz
SweepPoints	220
Sweeptime	94.727 μs
Reference Level	-10.000 dBm
Attenuation	10.000 dB
Detector	MaxPeak
SweepCount	100
Filter	3 dB
Trace Mode	Max Hold
SweepType	FFT
Preamp	off
Stablemode	Trace
Stablevalue	0.30 dB
Run	9 / max. 150
Stable	3 / 3
Max Stable Difference	0.25 dB

Radio Technology = WLAN b, Operating Frequency = low
(S01_AA01)

99 % Bandwidth

DUT Frequency (MHz)	Bandwidth (MHz)	Limit Min (MHz)	Limit Max (MHz)	Band Edge Left (MHz)	Band Edge Right (MHz)	Result
2412.000000	10.300000	--	--	2406.850000	2417.150000	PASS

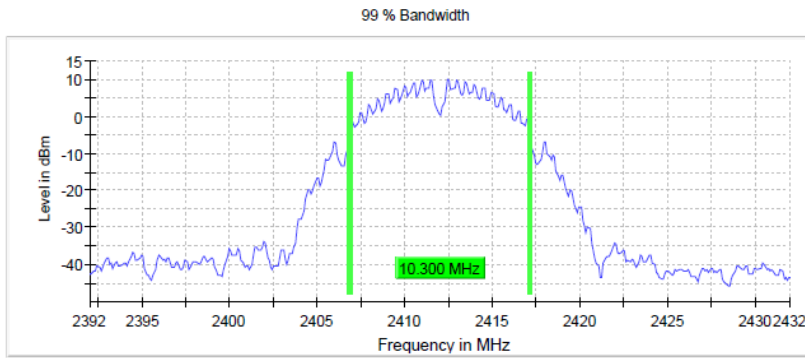

Setting	Instrument Value
Start Frequency	2.39200 GHz
Stop Frequency	2.43200 GHz
Span	40.000 MHz
RBW	200.000 kHz
VBW	1.000 MHz
SweepPoints	400
Sweeptime	28.477 μ s
Reference Level	0.000 dBm
Attenuation	20.000 dB
Detector	MaxPeak
SweepCount	100
Filter	3 dB
Trace Mode	Max Hold
SweepType	FFT
Preamp	off
Stablemode	Trace
Stablevalue	0.30 dB
Run	4 / max. 150
Stable	3 / 3
Max Stable Difference	0.12 dB

Radio Technology = WLAN g, Operating Frequency = high
(S01_AA01)

99 % Bandwidth

DUT Frequency (MHz)	Bandwidth (MHz)	Limit Min (MHz)	Limit Max (MHz)	Band Edge Left (MHz)	Band Edge Right (MHz)	Result
2462.000000	16.500000	--	--	2453.750000	2470.250000	PASS

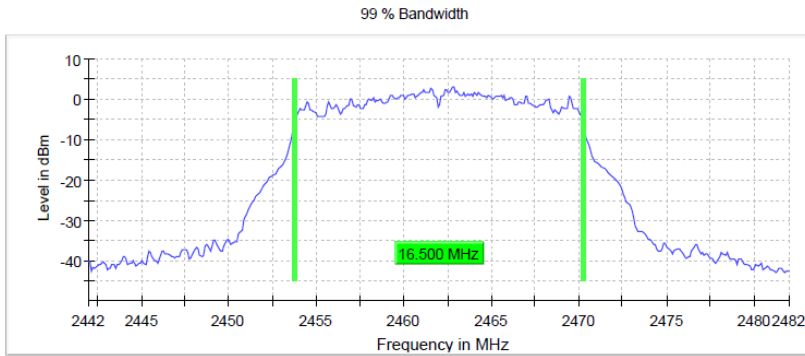

Setting	Instrument Value
Start Frequency	2.44200 GHz
Stop Frequency	2.48200 GHz
Span	40.000 MHz
RBW	200.000 kHz
VBW	1.000 MHz
SweepPoints	400
Sweeptime	28.477 μ s
Reference Level	0.000 dBm
Attenuation	20.000 dB
Detector	MaxPeak
SweepCount	100
Filter	3 dB
Trace Mode	Max Hold
SweepType	FFT
Preamp	off
Stablemode	Trace
Stablevalue	0.30 dB
Run	43 / max. 150
Stable	3 / 3
Max Stable Difference	0.11 dB

Radio Technology = WLAN n 20 MHz, Operating Frequency = high
(S01_AA01)

99 % Bandwidth

DUT Frequency (MHz)	Bandwidth (MHz)	Limit Min (MHz)	Limit Max (MHz)	Band Edge Left (MHz)	Band Edge Right (MHz)	Result
2462.000000	17.700000	---	---	2453.150000	2470.850000	PASS

Setting	Instrument Value
Start Frequency	2.44200 GHz
Stop Frequency	2.48200 GHz
Span	40.000 MHz
RBW	200.000 kHz
VBW	1.000 MHz
SweepPoints	400
SweepTime	28.477 μs
Reference Level	0.000 dBm
Attenuation	20.000 dB
Detector	MaxPeak
SweepCount	100
Filter	3 dB
Trace Mode	Max Hold
SweepType	FFT
Preamplifier	off
Stablemode	Trace
Stablevalue	0.30 dB
Run	42 / max. 150
Stable	3 / 3
Max Stable Difference	0.13 dB

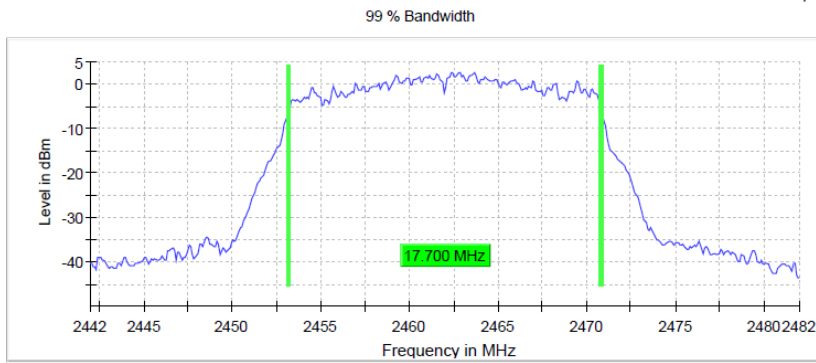

5.2.5 TEST EQUIPMENT USED

- R&S TS8997

5.3 BAND EDGE COMPLIANCE RESTRICTED BANDS

Standard **FCC Part 15 Subpart C**

The test was performed according to:
ANSI C63.10

5.3.1 TEST DESCRIPTION

The Equipment Under Test (EUT) was set up to perform the spurious emissions measurements. The EUT was connected to spectrum analyzer via a short coax cable with a known loss.

Analyzer settings:

- Frequency range: 2370 – 2500 MHz
- Resolution Bandwidth (RBW): 1000 kHz
- Video Bandwidth (VBW): 3000 kHz
- Trace: Maxhold, Average Power
- Sweeps: 1000
- Sweep Time: coupled
- Detector: Peak, RMS

The reference value for the measurement of the spurious RF conducted emissions is determined during the test "band edge compliance conducted". This value is used to calculate the 20 dBc limit.

For the conducted emissions in restricted bands the Value is measured in dBm and then converted to dB μ V/m as given in KDB 558074:

1. Measure the conducted output power in dBm.
2. Add the maximum antenna gain in dBi
3. Add the appropriate ground reflection factor
6 dB for frequencies \leq 30 MHz;
4.7 dB for frequencies between 30 MHz and 1000 MHz, inclusive; and
0 dB for frequencies $>$ 1000 MHz).
4. Convert the resulting EIRP level to an equivalent electric field strength level using the following relationship:

$$E = \text{EIRP} - 20 \log D + 104.8$$

Where E is the electric field strength in dB μ V/m,
EIRP is the equivalent isotropically radiated power in dBm
D is the specified measurement distance in m

Value [dB μ V/m] = Measured value [dBm] + Maximum Antenna Gain [dBi] + Ground reflection factor - 20 log D + 104.8

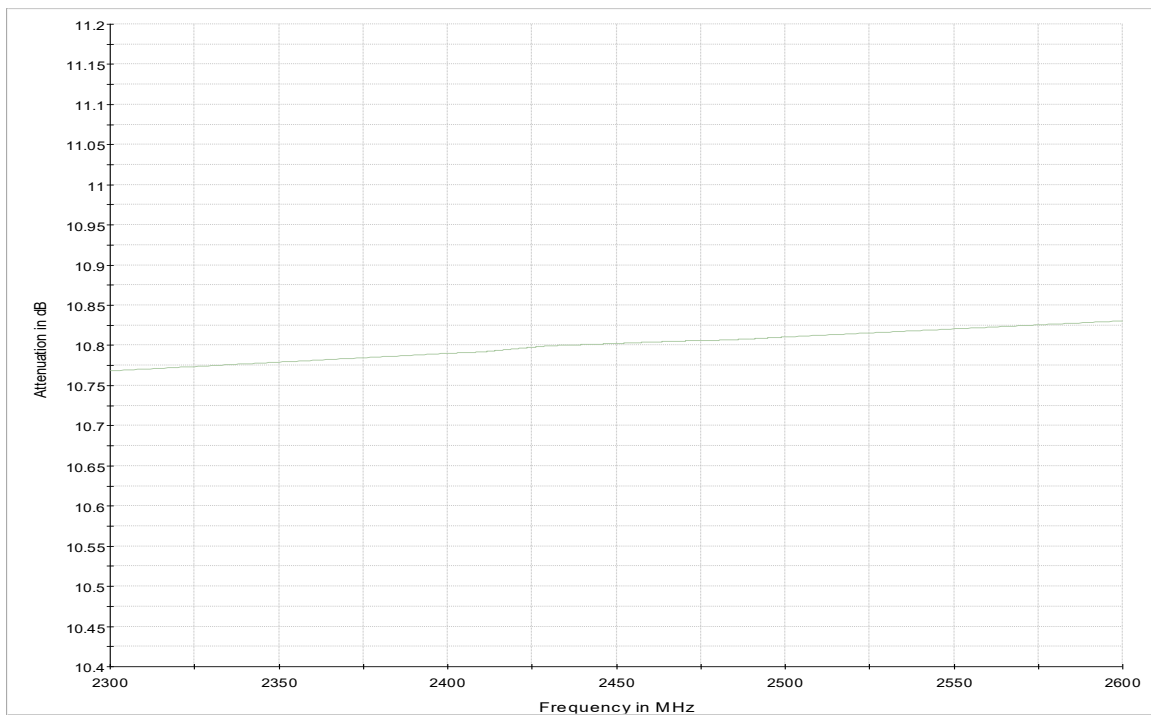
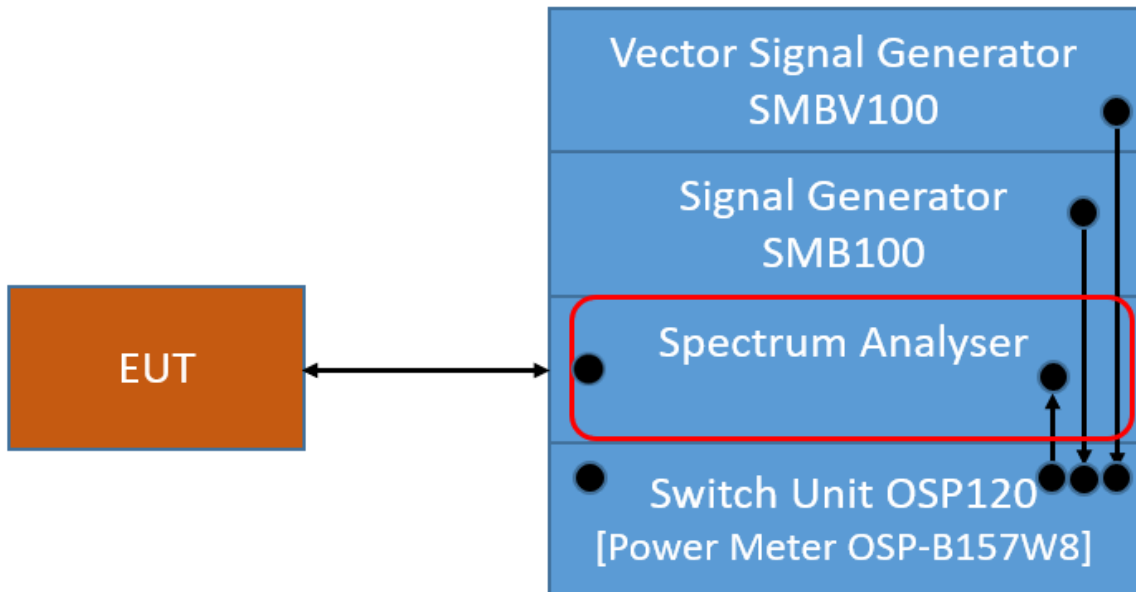

5.3.2 TEST REQUIREMENTS / LIMITS

For band edges connected to a restricted band, the limits are specified in Section 15.209(a)

FCC Part 15, Subpart C, §15.209, Radiated Emission Limits

Frequency in MHz	Limit ($\mu\text{V}/\text{m}$)	Measurement distance (m)	Limits ($\text{dB}\mu\text{V}/\text{m}$)
0.009 – 0.49	2400/F(kHz)@300m	3	(48.5 – 13.8)@300m
0.49 – 1.705	24000/F(kHz)@30m	3	(33.8 – 23.0)@30m
1.705 – 30	30@30m	3	29.5@30m

The measured values are corrected with an inverse linear distance extrapolation factor (40 dB/decade) according FCC 15.31 (2).

Frequency in MHz	Limit ($\mu\text{V}/\text{m}$)	Measurement distance (m)	Limits ($\text{dB}\mu\text{V}/\text{m}$)
30 – 88	100@3m	3	40.0@3m
88 – 216	150@3m	3	43.5@3m
216 – 960	200@3m	3	46.0@3m
960 - 26000	500@3m	3	54.0@3m
26000 - 40000	500@3m	1	54.0@3m

The measured values above 26 GHz are corrected with an inverse linear distance extrapolation factor (20 dB/decade).

§15.35(b) ..., there is also a limit on the radio frequency emissions, as measured using instrumentation with a peak detector function, corresponding to 20 dB above the maximum permitted average limit....

Used conversion factor: $\text{Limit (dB}\mu\text{V}/\text{m)} = 20 \log (\text{Limit } (\mu\text{V}/\text{m})/1\mu\text{V}/\text{m})$

5.3.3 TEST PROTOCOL

Ambient temperature: 27 °C
 Air Pressure: 993 hPa
 Humidity: 28 %
 BT GFSK (1-DH5)
 Applied duty cycle correction (AV): 0 dB

Ch. No.	Ch. Center Freq. [MHz]	Band Edge Freq. [MHz]	Spurious Level [dBµV/m]	Detector	RBW [kHz]	Limit [dBµV/m]	Margin to Limit [dB]
0	2402	2390	46.5	PEAK	1000	74.0	27.5
0	2402	2390	37.8	AV	1000	54.0	16.2
78	2480	2483.5	56.2	PEAK	1000	74.0	17.8
78	2480	2483.5	43.7	AV	1000	54.0	10.3

BT n/4 DQPSK (2-DH5)
 Applied duty cycle correction (AV): 0 dB

Ch. No.	Ch. Center Freq. [MHz]	Band Edge Freq. [MHz]	Spurious Level [dBµV/m]	Detector	RBW [kHz]	Limit [dBµV/m]	Margin to Limit [dB]
0	2402	2390	45.7	PEAK	1000	74.0	28.3
0	2402	2390	37.2	AV	1000	54.0	16.8
78	2480	2483.5	50.9	PEAK	1000	74.0	23.2
78	2480	2483.5	41.5	AV	1000	54.0	12.5

BT 8-DPSK (3-DH5)
 Applied duty cycle correction (AV): 0 dB

Ch. No.	Ch. Center Freq. [MHz]	Band Edge Freq. [MHz]	Spurious Level [dBµV/m]	Detector	RBW [kHz]	Limit [dBµV/m]	Margin to Limit [dB]
0	2402	2390	45.7	PEAK	1000	74.0	28.3
0	2402	2390	37.5	AV	1000	54.0	16.5
78	2480	2483.5	55.4	PEAK	1000	74.0	18.6
78	2480	2483.5	42.5	AV	1000	54.0	11.5

BT LE 1 Mbit/s
 Applied duty cycle correction (AV): 0 dB

Ch. No.	Ch. Center Freq. [MHz]	Band Edge Freq. [MHz]	Spurious Level [dBµV/m]	Detector	RBW [kHz]	Limit [dBµV/m]	Margin to Limit [dB]
0	2402	2390	46.3	PEAK	1000	74.0	27.7
0	2402	2390	36.8	AV	1000	54.0	17.2
39	2480	2483.5	53.4	PEAK	1000	74.0	20.6
39	2480	2483.5	39.5	AV	1000	54.0	14.5

WLAN b-Mode; 20 MHz; 1 Mbit/s
 Applied duty cycle correction (AV): 0 dB

Ch. No.	Ch. Center Freq. [MHz]	Band Edge Freq. [MHz]	Spurious Level [dBµV/m]	Detector	RBW [kHz]	Limit [dBµV/m]	Margin to Limit [dB]
1	2412	2390	54.9	PEAK	1000	74.0	19.1
1	2412	2390	48.3	AV	1000	54.0	5.7
11	2462	2483.5	43.0	PEAK	1000	74.0	31.0
11	2462	2483.5	45.8	AV	1000	54.0	8.2

WLAN g-Mode; 20 MHz; 6 Mbit/s
 Applied duty cycle correction (AV): 0 dB

Ch. No.	Ch. Center Freq. [MHz]	Band Edge Freq. [MHz]	Spurious Level [dBµV/m]	Detector	RBW [kHz]	Limit [dBµV/m]	Margin to Limit [dB]
1	2412	2390	63.2	PEAK	1000	74.0	10.8
1	2412	2390	50.3	AV	1000	54.0	3.8
11	2462	2483.5	59.5	PEAK	1000	74.0	14.5
11	2462	2483.5	47.5	AV	1000	54.0	6.5
2	2417	2390	58.5	PEAK	1000	74.0	15.5
2	2417	2390	45.3	AV	1000	54.0	8.7
10	2457	2483.5	63.8	PEAK	1000	74.0	10.2
10	2457	2483.5	49.2	AV	1000	54.0	4.8

WLAN n-Mode; 20 MHz; MCS0
 Applied duty cycle correction (AV): 0 dB

Ch. No.	Ch. Center Freq. [MHz]	Band Edge Freq. [MHz]	Spurious Level [dBμV/m]	Detector	RBW [kHz]	Limit [dBμV/m]	Margin to Limit [dB]
1	2412	2390	60.0	PEAK	1000	74.0	14.0
1	2412	2390	50.5	AV	1000	54.0	3.5
11	2462	2483.5	62.1	PEAK	1000	74.0	11.9
11	2462	2483.5	48.1	AV	1000	54.0	5.9
2	2417	2390	59.3	PEAK	1000	74.0	14.7
2	2417	2390	49.1	AV	1000	54.0	4.9
10	2457	2483.5	61.2	PEAK	1000	74.0	12.8
10	2457	2483.5	49.5	AV	1000	54.0	4.5

Remark: Please see next sub-clause for the measurement plot.

5.3.4 MEASUREMENT PLOT (EXAMPLE PLOT, SHOWING WORST CASE, IF APPLICABLE)

Radio Technology = Bluetooth BDR
 (S01_AA01)

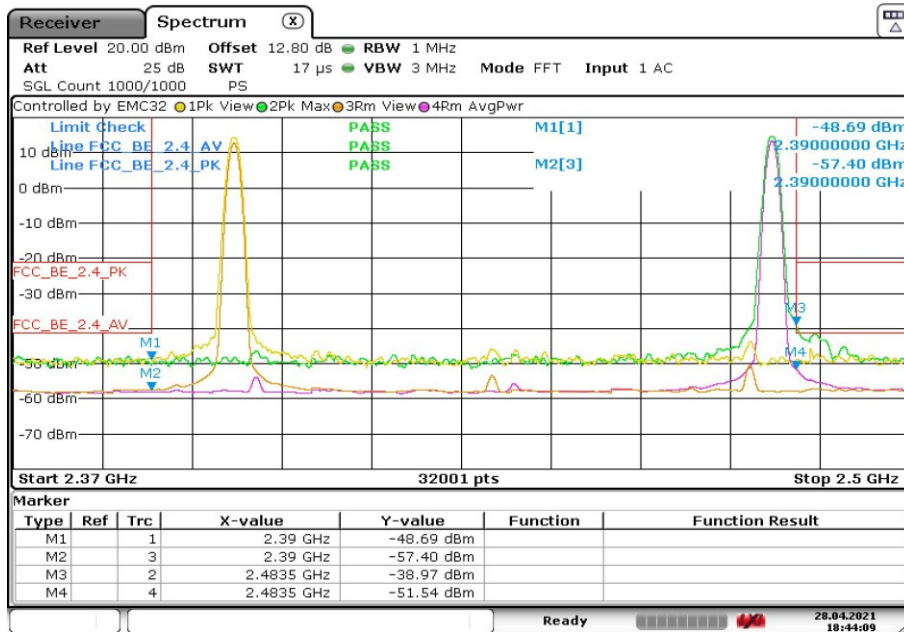

Result plot includes 2 dBi antenna gain

Radio Technology = Bluetooth EDR 2 (S01_AA01)

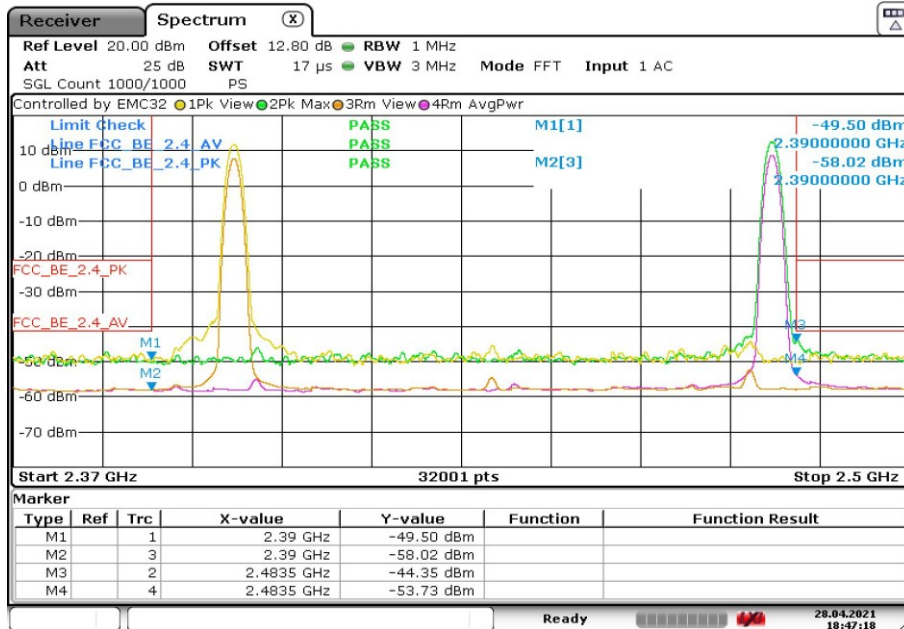

Date: 28.APR.2021 18:47:18

Result plot includes 2 dBi antenna gain

Radio Technology = Bluetooth EDR 3 (S01_AA01)

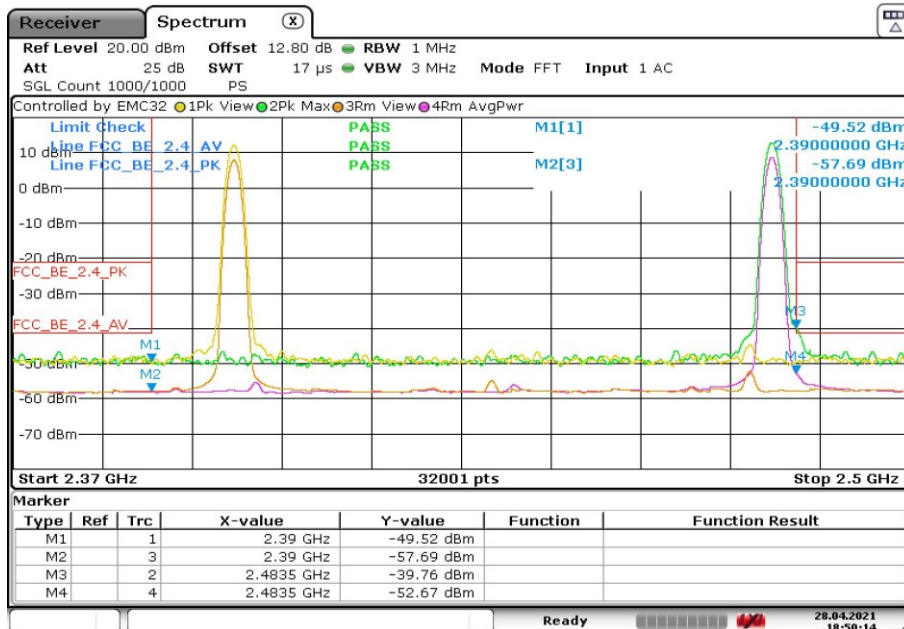

Date: 28.APR.2021 18:50:13

Result plot includes 2 dBi antenna gain

Radio Technology = Bluetooth LE 1 Mbps (S01_AA01)

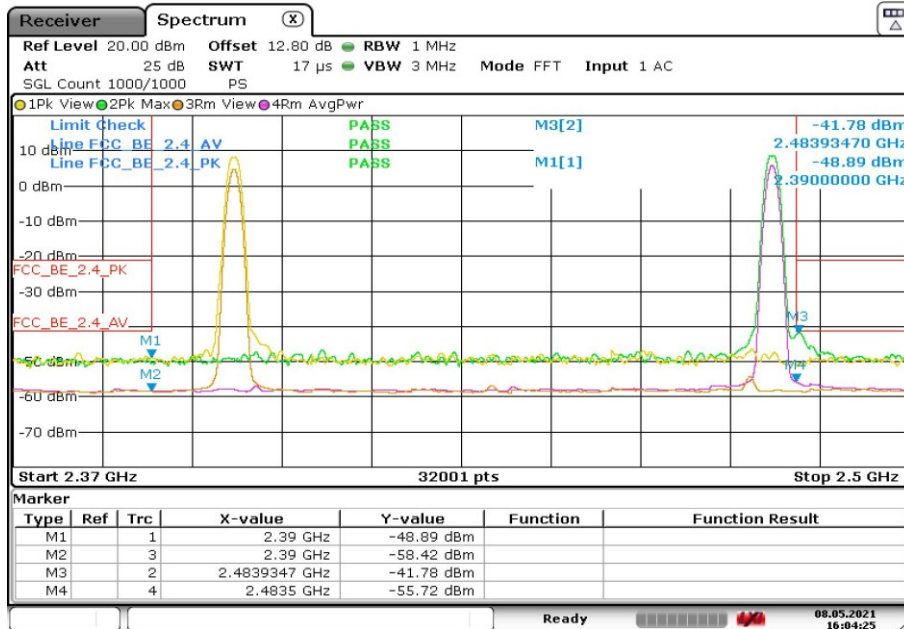

Date: 8.MAY.2021 16:04:25

Result plot includes 2 dBi antenna gain

Radio Technology = WLAN b (S01_AA01)

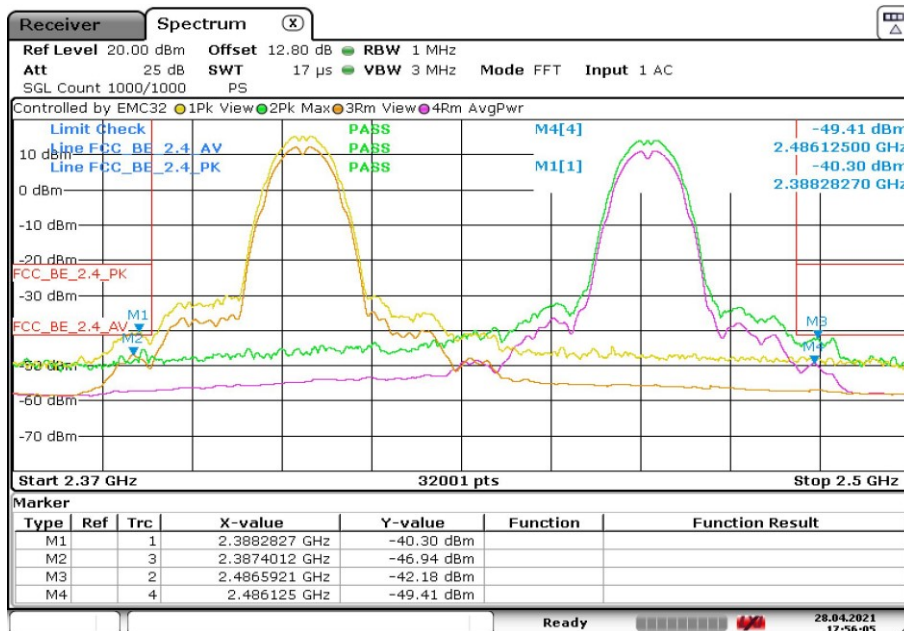

Date: 28.APR.2021 17:56:05

Result plot includes 2 dBi antenna gain

Radio Technology = WLAN g
(S01_AA01)

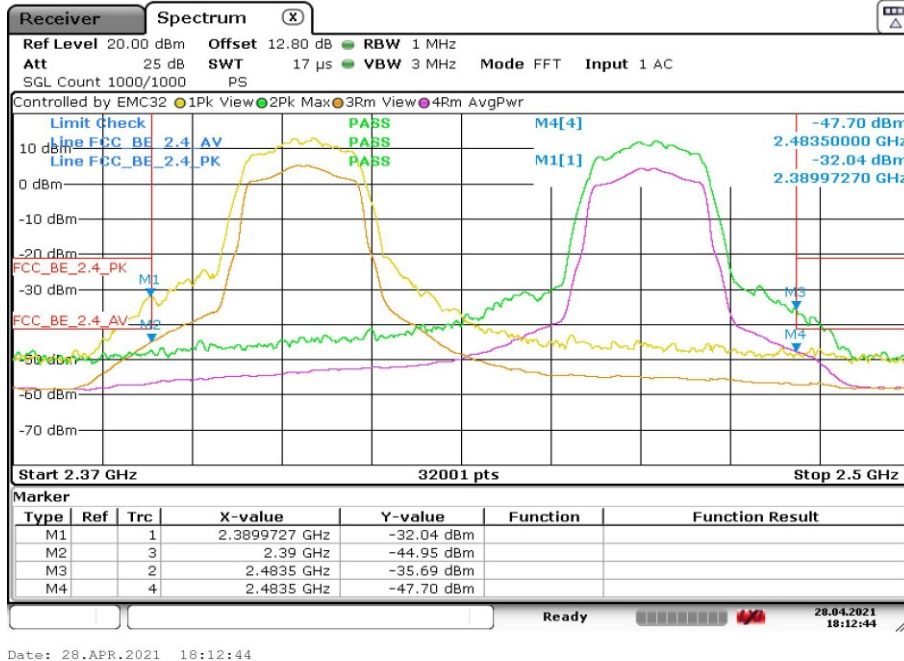

Date: 28.APR.2021 18:12:44

Result plot includes 2 dBi antenna gain

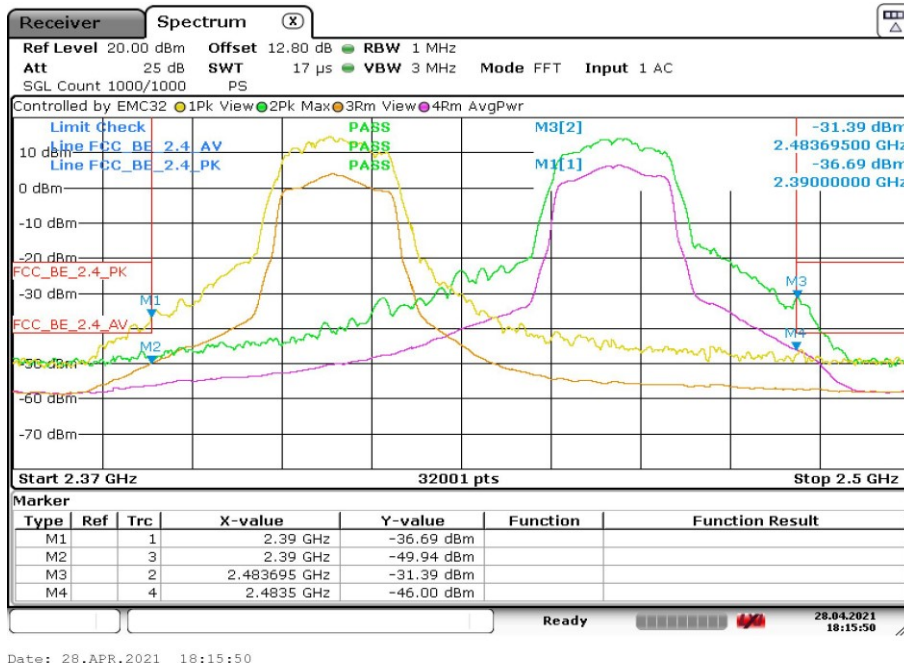

Date: 28.APR.2021 18:15:50

Result plot includes 2 dBi antenna gain

Radio Technology = WLAN n 20 MHz
(S01_AA01)

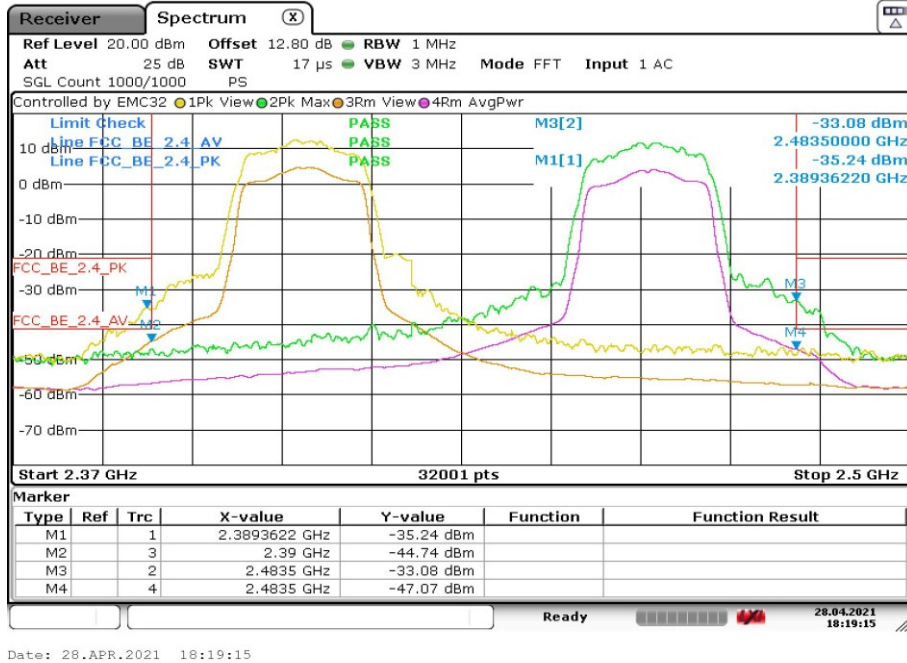

Result plot includes 2 dBi antenna gain

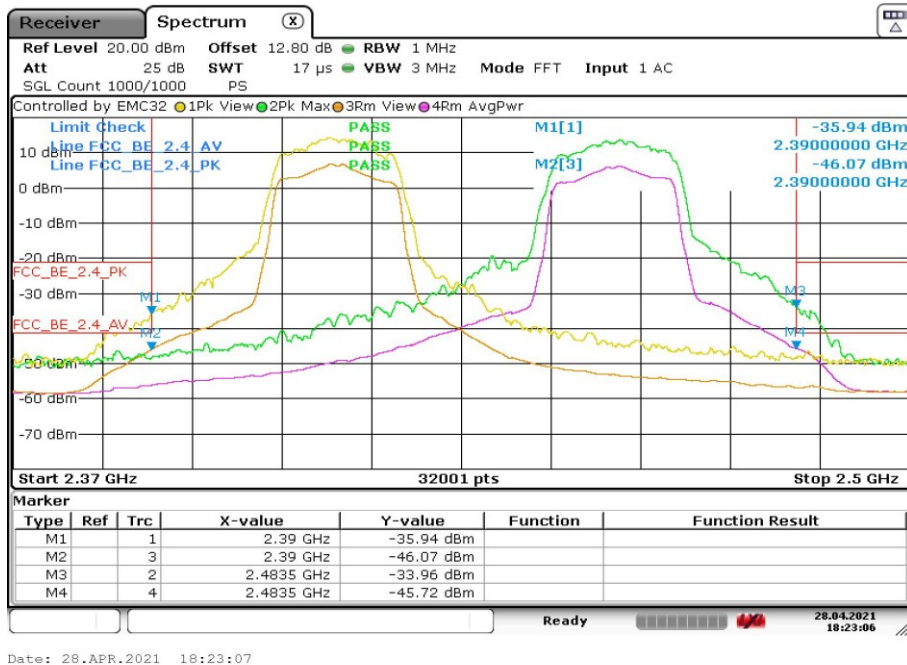

Result plot includes 2 dBi antenna gain

5.3.5 TEST EQUIPMENT USED

- R&S TS8997

5.4 TRANSMITTER SPURIOUS RADIATED EMISSIONS

Standard **FCC Part 15 Subpart C**

The test was performed according to:
ANSI C63.10

5.4.1 TEST DESCRIPTION

The test set-up was made in accordance to the general provisions of ANSI C63.10 in a typical installation configuration. The measurements were performed according the following sub-chapters of ANSI C63.10:

- < 30 MHz: Chapter 6.4
- 30 MHz – 1 GHz: Chapter 6.5
- > 1 GHz: Chapter 6.6 (procedure according 6.6.5 used)

The measurement procedure is implemented into the EMI test software EMC32 from R&S. Exploratory tests are performed at 3 orthogonal axes to determine the worst-case orientation of a body-worn or handheld EUT. The final test on all kind of EUTs is also performed at 3 axes. A pre-check is performed while the EUT is powered.

Below 1 GHz:

The Equipment Under Test (EUT) was set up on a non-conductive table in the semi-anechoic chamber. The influence of the EUT support table that is used between 30–1000 MHz was evaluated.

1. Measurement up to 30 MHz

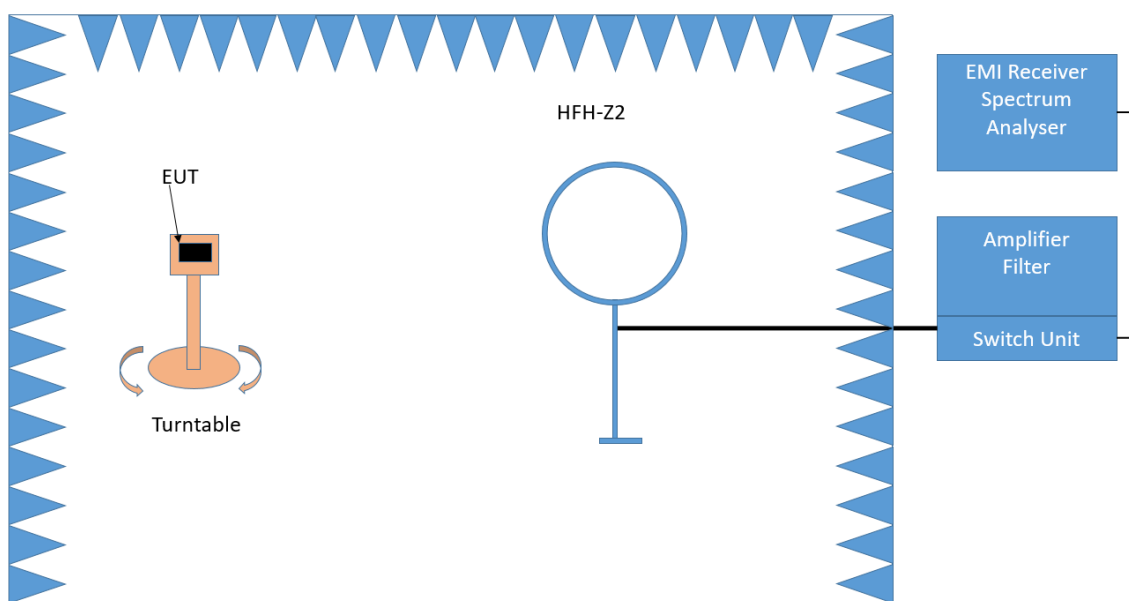

Test Setup; Spurious Emission Radiated (SAC), 9 kHz – 30 MHz

The Loop antenna HFH2-Z2 is used.

Step 1: pre measurement

- Anechoic chamber
- Antenna distance: 3 m
- Antenna height: 1 m
- Detector: Peak-Maxhold
- Frequency range: 0.009 - 0.15 MHz and 0.15 - 30 MHz
- Frequency steps: 0.05 kHz and 2.25 kHz
- IF-Bandwidth: 0.2 kHz and 9 kHz
- Measuring time / Frequency step: 100 ms (FFT-based)

Intention of this step is, to determine the radiated EMI-profile of the EUT. Afterwards the relevant emissions for the final measurement are identified.

Step 2: final measurement

For the relevant emissions determined in step 1, an additional measurement with the following settings will be performed. Intention of this step is to find the maximum emission level.

- Detector: Quasi-Peak (9 kHz - 150 kHz, Peak / Average 150 kHz- 30 MHz)
- Frequency range: 0.009 - 30 MHz
- Frequency steps: measurement at frequencies detected in step 1
- IF-Bandwidth: 0.2 - 10 kHz
- Measuring time / Frequency step: 1 s

2. Measurement above 30 MHz and up to 1 GHz

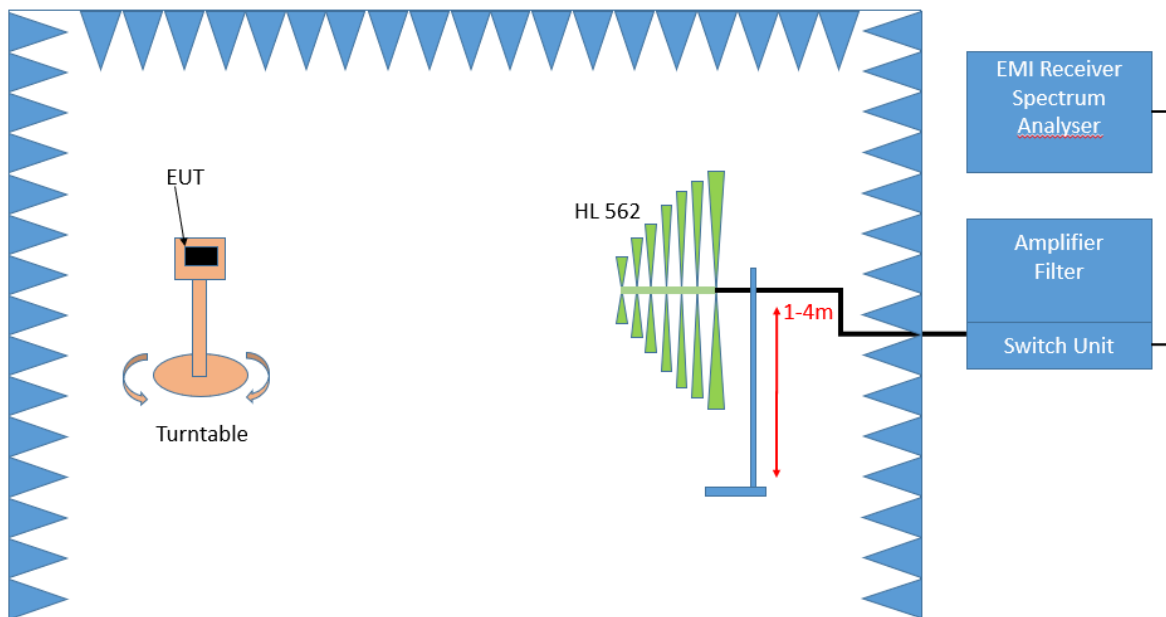

Test Setup; Spurious Emission Radiated (SAC), 30 MHz- 1GHz

Step 1: Preliminary scan

This is a preliminary test to identify the highest amplitudes relative to the limit.

Settings for step 1:

- Antenna distance: 3 m
- Detector: Peak-Maxhold / Quasipeak (FFT-based)
- Frequency range: 30 - 1000 MHz
- Frequency steps: 30 kHz
- IF-Bandwidth: 120 kHz
- Measuring time / Frequency step: 100 ms
- Turntable angle range: -180° to 90°
- Turntable step size: 90°

- Height variation range: 1 – 4 m
- Height variation step size: 1.5 m
- Polarisation: Horizontal + Vertical

Intention of this step is, to determine the radiated EMI-profile of the EUT. Afterwards the relevant emissions for the final measurement are identified.

Step 2: Adjustment measurement

In this step the accuracy of the turntable azimuth and antenna height will be improved. This is necessary to find out the maximum value of every frequency.

For each frequency, which was determined the turntable azimuth and antenna height will be adjusted. The turntable azimuth will slowly vary by 360°. During this action, the value of emission is continuously measured. The turntable azimuth at the highest emission will be recorded and adjusted. In this position, the antenna height will also slowly vary between 1 and 4m. During this action, the value of emission is also continuously measured. The antenna height of the highest emission will also be recorded and adjusted.

- Detector: Peak – Maxhold
- Measured frequencies: in step 1 determined frequencies
- IF – Bandwidth: 120 kHz
- Measuring time: 100 ms
- Turntable angle range: 360 °
- Height variation range: 1 – 4 m
- Antenna Polarisation: max. value determined in step 1

Step 3: Final measurement with QP detector

With the settings determined in step 2, the final measurement will be performed:

EMI receiver settings for step 3:

- Detector: Quasi-Peak (< 1 GHz)
- Measured frequencies: in step 1 determined frequencies
- IF – Bandwidth: 120 kHz
- Measuring time: 1 s

After the measurement a plot will be generated which contains a diagram with the results of the preliminary scan and a chart with the frequencies and values of the results of the final measurement.

Above 1 GHz:

The Equipment Under Test (EUT) was set up on a non-conductive support (tilt device) at 1.5 m height in the fully-anechoic chamber.

All steps were performed with one height (1.5 m) of the receiving antenna only.

3. Measurement above 1 GHz

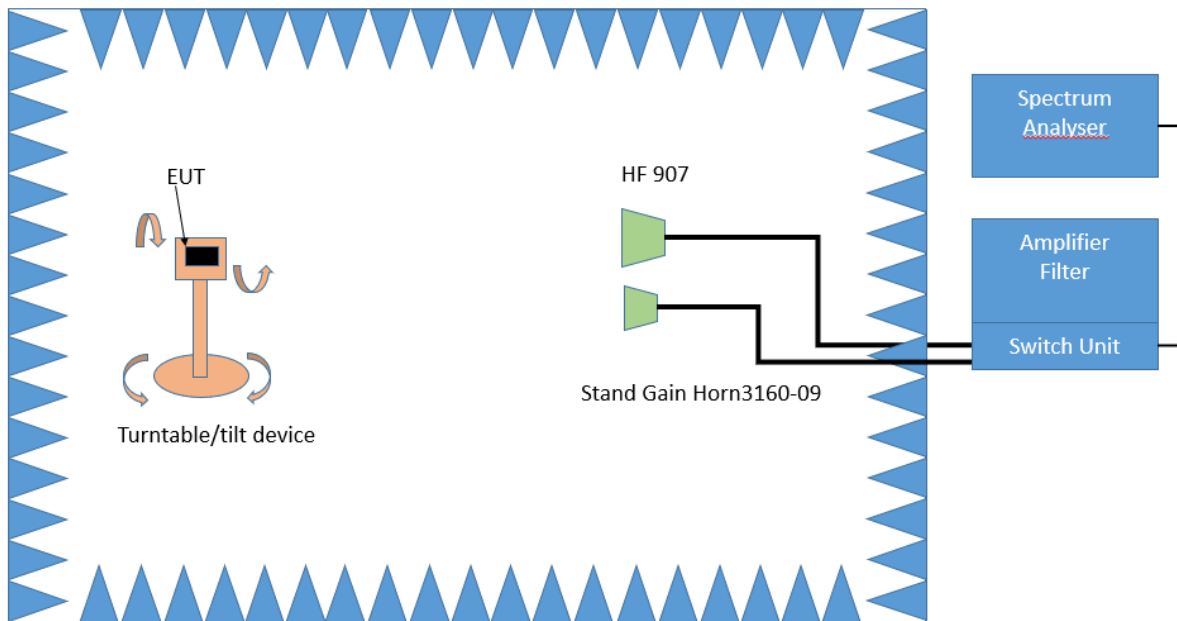

Test Setup; Spurious Emission Radiated (FAC), 1 GHz-26.5 GHz

Step 1:

The EUT is turned during the preliminary measurement across the elevation axis, with a step size of 90 °.

The turn table step size (azimuth angle) for the preliminary measurement is 45 °.

Spectrum analyser settings:

- Detector: Peak, Average
- RBW = 1 MHz
- VBW = 3 MHz

Step 2:

The turn table azimuth will slowly vary by $\pm 22.5^\circ$.

The elevation angle will slowly vary by $\pm 45^\circ$

Spectrum analyser settings:

- Detector: Peak

Step 3:

Spectrum analyser settings for step 3:

- Detector: Peak / CISPR Average
- Measured frequencies: in step 1 determined frequencies
- RBW = 1 MHz
- VBW = 3 MHz
- Measuring time: 1 s

5.4.2 TEST REQUIREMENTS / LIMITS

FCC Part 15, Subpart C, §15.247 (d)

... In addition, radiated emissions which fall in the restricted bands, as defined in Section 15.205(a), must also comply with the radiated emission limits specified in Section 15.209(a) (see Section 15.205(c)).

FCC Part 15, Subpart C, §15.209, Radiated Emission Limits

Frequency in MHz	Limit (µV/m)	Measurement distance (m)	Limits (dBµV/m)
0.009 – 0.49	2400/F(kHz)@300m	3	(48.5 – 13.8)@300m
0.49 – 1.705	24000/F(kHz)@30m	3	(33.8 – 23.0)@30m
1.705 – 30	30@30m	3	29.5@30m

The measured values are corrected with an inverse linear distance extrapolation factor (40 dB/decade) according FCC 15.31 (2).

Frequency in MHz	Limit (µV/m)	Measurement distance (m)	Limits (dBµV/m)
30 – 88	100@3m	3	40.0@3m
88 – 216	150@3m	3	43.5@3m
216 – 960	200@3m	3	46.0@3m
960 - 26000	500@3m	3	54.0@3m
26000 - 40000	500@3m	1	54.0@3m

The measured values above 26 GHz are corrected with an inverse linear distance extrapolation factor (20 dB/decade).

§15.35(b) ..., there is also a limit on the radio frequency emissions, as measured using instrumentation with a peak detector function, corresponding to 20 dB above the maximum permitted average limit....

Used conversion factor: $\text{Limit (dB}\mu\text{V/m)} = 20 \log (\text{Limit } (\mu\text{V/m})/1\mu\text{V/m})$

5.4.3 TEST PROTOCOL

Ambient temperature: 25 - 28 °C
 Air Pressure: 1006 - 1017 hPa
 Humidity: 34 - 43 %

BT GFSK (1-DH1)								
Applied duty cycle correction (AV): 0 dB								
Ch. No.	Ch. Center Freq. [MHz]	Spurious Freq. [MHz]	Spurious Level [dBµV/m]	Detector	RBW [kHz]	Limit [dBµV/m]	Margin to Limit [dB]	Limit Type
78	2480	---	---	---	---	---	---	RB

WLAN b-Mode; 20 MHz; 1 Mbit/s								
Applied duty cycle correction (AV): 0 dB								
Ch. No.	Ch. Center Freq. [MHz]	Spurious Freq. [MHz]	Spurious Level [dBµV/m]	Detector	RBW [kHz]	Limit [dBµV/m]	Margin to Limit [dB]	Limit Type
11	2462	---	---	---	---	---	---	RB

Remark: Please see next sub-clause for the measurement plot.

5.4.4 MEASUREMENT PLOT

Radio Technology = Bluetooth BDR, Operating Frequency = high, Measurement range = 1 GHz - 26 GHz
(S02_AA01)

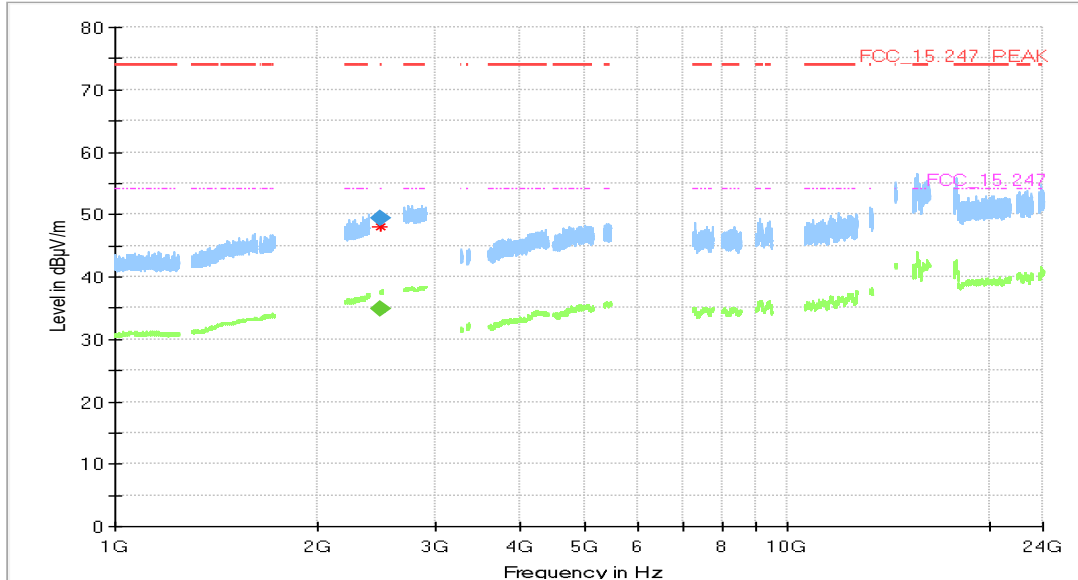

Final Result

Frequency (MHz)	MaxPeak (dBµV/m)	CAverage (dBµV/m)	Limit (dBµV/m)	Margin (dB)	Meas. Time (ms)	Bandwidth (kHz)	Height (cm)	Pol	Azimuth (deg)	Elevation (deg)	Corr. (dB/m)
2483.500	---	35.0	54.00	19.03	1000.0	1000.000	150.0	V	-55.0	-3.0	5.4
2483.665	49.4	---	74.00	24.56	1000.0	1000.000	150.0	V	71.0	-15.0	5.4

Plot original certification:

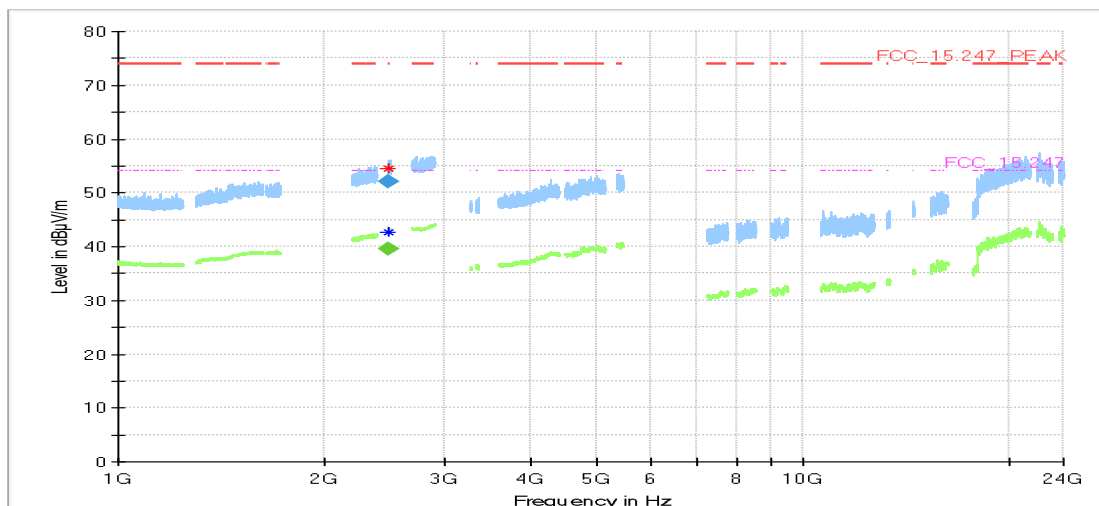

Final Result

Frequency (MHz)	MaxPeak (dBµV/m)	CAverage (dBµV/m)	Limit (dBµV/m)	Margin (dB)	Meas. Time (ms)	Bandwidth (kHz)	Height (cm)	Pol	Azimuth (deg)	Elevation (deg)
2484.655000	---	39.47	54.00	14.53	1000.0	1000.000	150.0	H	151.0	14.8
2484.655000	52.13	---	74.00	21.87	1000.0	1000.000	150.0	V	-130.0	14.7

Radio Technology = WLAN b, Operating Frequency = high, Measurement range = 1 GHz - 26 GHz (S02_AA01)

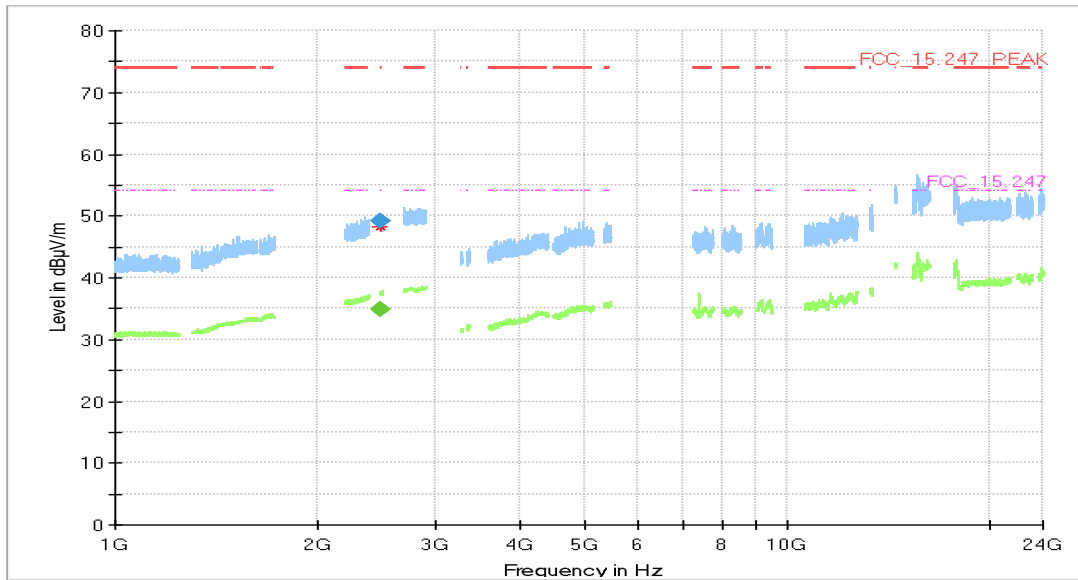

Final Result

Frequency (MHz)	MaxPeak (dBµV/m)	CAverage (dBµV/m)	Limit (dBµV/m)	Margin (dB)	Meas. Time (ms)	Bandwidth (kHz)	Height (cm)	Pol	Azimuth (deg)	Elevation (deg)	Corr. (dB/m)
2483.500	---	35.0	54.00	19.03	1000.0	1000.000	150.0	V	-188.0	-12.0	5.4
2484.160	49.3	---	74.00	24.75	1000.0	1000.000	150.0	H	153.0	95.0	5.4

Plot original certification:

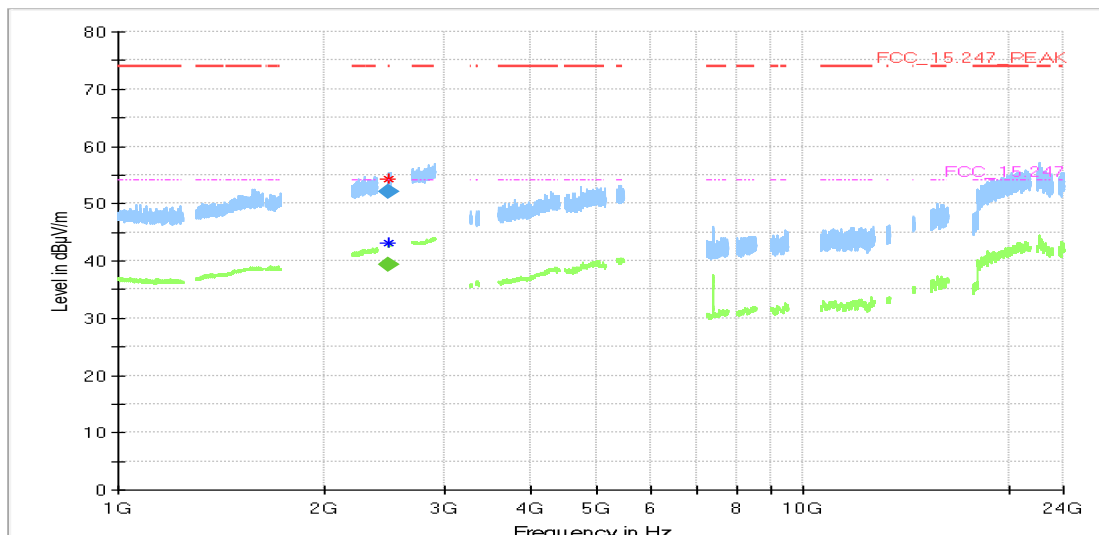

Final Result

Frequency (MHz)	MaxPeak (dBµV/m)	CAverage (dBµV/m)	Limit (dBµV/m)	Margin (dB)	Meas. Time (ms)	Bandwidth (kHz)	Height (cm)	Pol	Azimuth (deg)	Elevation (deg)
2483.665000	52.02	---	74.00	21.98	1000.0	1000.000	150.0	H	20.0	-15.2
2484.077500	---	39.23	54.00	14.77	1000.0	1000.000	150.0	V	79.0	15.2

5.4.5 TEST EQUIPMENT USED

- Radiated Emissions

6 TEST EQUIPMENT

- 1 R&S TS8997
2.4 and 5 GHz Bands Conducted Test Lab

Ref.No.	Device Name	Description	Manufacturer	Serial Number	Last Calibration	Calibration Due
1.1	SMB100A	Signal Generator 9 kHz - 6 GHz	Rohde & Schwarz	107695	2020-08	2023-08
1.2	EX520	Digital Multimeter 12	Extech Instruments Corp	05157876	2020-04	2022-04
1.3	FSV30	Signal Analyzer 10 Hz - 30 GHz	Rohde & Schwarz	103005	2020-05	2022-05
1.4	Opus10 THI (8152.00)	T/H Logger 15	Lufft Mess- und Regeltechnik GmbH	13985	2019-06	2021-06
1.5	NGSM 32/10	Power Supply	Rohde & Schwarz GmbH & Co. KG	3456	2020-01	2022-01
1.6	Temperature Chamber KWP 120/70	Temperature Chamber Weiss 01	Weiss	59226012190010	2020-05	2022-05
1.7	SMB100A	Signal Generator 100 kHz - 40 GHz	Rohde & Schwarz Vertriebs-GmbH	181486	2019-11	2021-11
1.8	Temperature Chamber VT 4002	Temperature Chamber Vötsch 03	Vötsch	58566002150010	2020-05	2022-05
1.9	Opus10 THI (8152.00)	T/H Logger 14	Lufft Mess- und Regeltechnik GmbH	13993	2019-06	2021-06
1.10	SMBV100A	Vector Signal Generator 9 kHz - 6 GHz	Rohde & Schwarz	259291	2019-11	2022-11
1.11	OSP120	Contains Power Meter and Switching Unit OSP-B157W8	Rohde & Schwarz	101158	2018-05	2021-05

- 2 Radiated Emissions
Lab to perform radiated emission tests

Ref.No.	Device Name	Description	Manufacturer	Serial Number	Last Calibration	Calibration Due
2.1	MFS	Rubidium Frequency Normal MFS	Datum GmbH	002	2020-11	2021-11
2.2	Opus10 TPR (8253.00)	T/P Logger 13	Lufft Mess- und Regeltechnik GmbH	13936	2019-05	2021-05
2.3	AMF-7D00101800-30-10P-R	Broadband Amplifier 100 MHz - 18 GHz	Miteq			
2.4	ASP 1.2/1.8-10 kg	Antenna Mast	Maturo GmbH	-		
2.5	Anechoic Chamber 03	FAR, 8.80m x 4.60m x 4.05m (l x w x h)	Albatross Projects	P26971-647-001-PRB	2021-04	2023-04
2.6	Opus10 THI (8152.00)	T/H Logger 10	Lufft Mess- und Regeltechnik GmbH	12488	2019-06	2021-06

Ref.No.	Device Name	Description	Manufacturer	Serial Number	Last Calibration	Calibration Due
2.7	JS4-18002600-32-5P	Broadband Amplifier 18 GHz - 26 GHz	Miteq	849785		
2.8	FSW 43	Spectrum Analyzer	Rohde & Schwarz	103779	2019-02	2021-08
2.9	3160-09	Standard Gain / Pyramidal Horn Antenna 26.5 GHz	EMCO Electronic GmbH	00083069		
2.10	WHKX 7.0/18G-8SS	High Pass Filter	Wainwright Instruments GmbH	09		
2.11	JS4-00102600-42-5A	Broadband Amplifier 30 MHz - 26 GHz	Miteq	619368		
2.12	TT 1.5 WI	Turn Table	Maturo GmbH	-		
2.13	HL 562 ULTRALOG	Biconical-log-per Antenna (30 MHz - 3 GHz)	Rohde & Schwarz GmbH & Co. KG	100609	2019-05	2022-05
2.14	JUN-AIR Mod. 6-15	Air Compressor	JUN-AIR Deutschland GmbH	612582		
2.15	5HC3500/18000-1.2-KK	High Pass Filter	Trilithic	200035008		
2.16	JS4-00101800-35-5P	Broadband Amplifier 30 MHz - 18 GHz	Miteq	896037		
2.17	AS 620 P	Antenna Mast (pneumatic polarisation)	HD GmbH	620/37		
2.18	TD1.5-10kg	EUT Tilt Device (Rohacell)	Maturo GmbH	TD1.5-10kg/024/3790709		
2.19	HF 907-2	Double-ridged horn	Rohde & Schwarz	102817	2019-04	2022-04
2.20	PAS 2.5 - 10 kg	Antenna Mast	Maturo GmbH	-		
2.21	AFS42-00101800-25-S-42	Broadband Amplifier 25 MHz - 18 GHz	Miteq	2035324		
2.22	HF 907	Double-ridged horn	Rohde & Schwarz	102444	2018-07	2021-07

The calibration interval is the time interval between "Last Calibration" and "Calibration Due"

7 ANTENNA FACTORS, CABLE LOSS AND SAMPLE CALCULATIONS

This chapter contains the antenna factors with their corresponding path loss of the used measurement path for all antennas as well as the insertion loss of the LISN.

7.1 LISN R&S ESH3-Z5 (150 KHZ – 30 MHZ)

Frequency MHz	Corr. dB	LISN insertion loss ESH3- Z5 dB	cable loss (incl. 10 dB atten- uator) dB
0.15	10.1	0.1	10.0
5	10.3	0.1	10.2
7	10.5	0.2	10.3
10	10.5	0.2	10.3
12	10.7	0.3	10.4
14	10.7	0.3	10.4
16	10.8	0.4	10.4
18	10.9	0.4	10.5
20	10.9	0.4	10.5
22	11.1	0.5	10.6
24	11.1	0.5	10.6
26	11.2	0.5	10.7
28	11.2	0.5	10.7
30	11.3	0.5	10.8

Sample calculation

$$U_{\text{LISN}} (\text{dB } \mu\text{V}) = U (\text{dB } \mu\text{V}) + \text{Corr. (dB)}$$

U = Receiver reading

LISN Insertion loss = Voltage Division Factor of LISN

Corr. = sum of single correction factors of used LISN, cables, switch units (if used)

Linear interpolation will be used for frequencies in between the values in the table.

7.2 ANTENNA R&S HFH2-Z2 (9 KHZ – 30 MHZ)

Frequency MHz	AF HFH-Z2) dB (1/m)	Corr. dB	cable loss 1 (inside chamber) dB	cable loss 2 (outside chamber) dB	cable loss 3 (switch unit) dB	cable loss 4 (to receiver) dB	distance corr. (-40 dB/ decade) dB	d _{Limit} (meas. distance (limit) m	d _{used} (meas. distance (used) m
0.009	20.50	-79.6	0.1	0.1	0.1	0.1	-80	300	3
0.01	20.45	-79.6	0.1	0.1	0.1	0.1	-80	300	3
0.015	20.37	-79.6	0.1	0.1	0.1	0.1	-80	300	3
0.02	20.36	-79.6	0.1	0.1	0.1	0.1	-80	300	3
0.025	20.38	-79.6	0.1	0.1	0.1	0.1	-80	300	3
0.03	20.32	-79.6	0.1	0.1	0.1	0.1	-80	300	3
0.05	20.35	-79.6	0.1	0.1	0.1	0.1	-80	300	3
0.08	20.30	-79.6	0.1	0.1	0.1	0.1	-80	300	3
0.1	20.20	-79.6	0.1	0.1	0.1	0.1	-80	300	3
0.2	20.17	-79.6	0.1	0.1	0.1	0.1	-80	300	3
0.3	20.14	-79.6	0.1	0.1	0.1	0.1	-80	300	3
0.49	20.12	-79.6	0.1	0.1	0.1	0.1	-80	300	3
0.490001	20.12	-39.6	0.1	0.1	0.1	0.1	-40	30	3
0.5	20.11	-39.6	0.1	0.1	0.1	0.1	-40	30	3
0.8	20.10	-39.6	0.1	0.1	0.1	0.1	-40	30	3
1	20.09	-39.6	0.1	0.1	0.1	0.1	-40	30	3
2	20.08	-39.6	0.1	0.1	0.1	0.1	-40	30	3
3	20.06	-39.6	0.1	0.1	0.1	0.1	-40	30	3
4	20.05	-39.5	0.2	0.1	0.1	0.1	-40	30	3
5	20.05	-39.5	0.2	0.1	0.1	0.1	-40	30	3
6	20.02	-39.5	0.2	0.1	0.1	0.1	-40	30	3
8	19.95	-39.5	0.2	0.1	0.1	0.1	-40	30	3
10	19.83	-39.4	0.2	0.1	0.2	0.1	-40	30	3
12	19.71	-39.4	0.2	0.1	0.2	0.1	-40	30	3
14	19.54	-39.4	0.2	0.1	0.2	0.1	-40	30	3
16	19.53	-39.3	0.3	0.1	0.2	0.1	-40	30	3
18	19.50	-39.3	0.3	0.1	0.2	0.1	-40	30	3
20	19.57	-39.3	0.3	0.1	0.2	0.1	-40	30	3
22	19.61	-39.3	0.3	0.1	0.2	0.1	-40	30	3
24	19.61	-39.3	0.3	0.1	0.2	0.1	-40	30	3
26	19.54	-39.3	0.3	0.1	0.2	0.1	-40	30	3
28	19.46	-39.2	0.3	0.1	0.3	0.1	-40	30	3
30	19.73	-39.1	0.4	0.1	0.3	0.1	-40	30	3

Sample calculation

$$E \text{ (dB } \mu\text{V/m)} = U \text{ (dB } \mu\text{V)} + AF \text{ (dB 1/m)} + Corr. \text{ (dB)}$$

U = Receiver reading

AF = Antenna factor

Corr. = sum of single correction factors of used cables, switch unit, distance correction, amplifier (if applicable)

distance correction = $-40 * \text{LOG} (d_{\text{Limit}} / d_{\text{used}})$

Linear interpolation will be used for frequencies in between the values in the table.

Table shows an extract of values

7.3 ANTENNA R&S HL562 (30 MHz – 1 GHz)

($d_{Limit} = 3\text{ m}$)

Frequency	AF R&S HL562	Corr.
MHz	dB (1/m)	dB
30	18.6	0.6
50	6.0	0.9
100	9.7	1.2
150	7.9	1.6
200	7.6	1.9
250	9.5	2.1
300	11.0	2.3
350	12.4	2.6
400	13.6	2.9
450	14.7	3.1
500	15.6	3.2
550	16.3	3.5
600	17.2	3.5
650	18.1	3.6
700	18.5	3.6
750	19.1	4.1
800	19.6	4.1
850	20.1	4.4
900	20.8	4.7
950	21.1	4.8
1000	21.6	4.9

cable loss 1 (inside chamber)	cable loss 2 (outside chamber)	cable loss 3 (switch unit)	cable loss 4 (to receiver)	distance corr. (-20 dB/decade)	d_{Limit} (meas. distance (limit))	d_{used} (meas. distance (used))
dB	dB	dB	dB	dB	m	m
0.29	0.04	0.23	0.02	0.0	3	3
0.39	0.09	0.32	0.08	0.0	3	3
0.56	0.14	0.47	0.08	0.0	3	3
0.73	0.20	0.59	0.12	0.0	3	3
0.84	0.21	0.70	0.11	0.0	3	3
0.98	0.24	0.80	0.13	0.0	3	3
1.04	0.26	0.89	0.15	0.0	3	3
1.18	0.31	0.96	0.13	0.0	3	3
1.28	0.35	1.03	0.19	0.0	3	3
1.39	0.38	1.11	0.22	0.0	3	3
1.44	0.39	1.20	0.19	0.0	3	3
1.55	0.46	1.24	0.23	0.0	3	3
1.59	0.43	1.29	0.23	0.0	3	3
1.67	0.34	1.35	0.22	0.0	3	3
1.67	0.42	1.41	0.15	0.0	3	3
1.87	0.54	1.46	0.25	0.0	3	3
1.90	0.46	1.51	0.25	0.0	3	3
1.99	0.60	1.56	0.27	0.0	3	3
2.14	0.60	1.63	0.29	0.0	3	3
2.22	0.60	1.66	0.33	0.0	3	3
2.23	0.61	1.71	0.30	0.0	3	3

($d_{Limit} = 10\text{ m}$)

30	18.6	-9.9
50	6.0	-9.6
100	9.7	-9.2
150	7.9	-8.8
200	7.6	-8.6
250	9.5	-8.3
300	11.0	-8.1
350	12.4	-7.9
400	13.6	-7.6
450	14.7	-7.4
500	15.6	-7.2
550	16.3	-7.0
600	17.2	-6.9
650	18.1	-6.9
700	18.5	-6.8
750	19.1	-6.3
800	19.6	-6.3
850	20.1	-6.0
900	20.8	-5.8
950	21.1	-5.6
1000	21.6	-5.6

0.29	0.04	0.23	0.02	-10.5	10	3
0.39	0.09	0.32	0.08	-10.5	10	3
0.56	0.14	0.47	0.08	-10.5	10	3
0.73	0.20	0.59	0.12	-10.5	10	3
0.84	0.21	0.70	0.11	-10.5	10	3
0.98	0.24	0.80	0.13	-10.5	10	3
1.04	0.26	0.89	0.15	-10.5	10	3
1.18	0.31	0.96	0.13	-10.5	10	3
1.28	0.35	1.03	0.19	-10.5	10	3
1.39	0.38	1.11	0.22	-10.5	10	3
1.44	0.39	1.20	0.19	-10.5	10	3
1.55	0.46	1.24	0.23	-10.5	10	3
1.59	0.43	1.29	0.23	-10.5	10	3
1.67	0.34	1.35	0.22	-10.5	10	3
1.67	0.42	1.41	0.15	-10.5	10	3
1.87	0.54	1.46	0.25	-10.5	10	3
1.90	0.46	1.51	0.25	-10.5	10	3
1.99	0.60	1.56	0.27	-10.5	10	3
2.14	0.60	1.63	0.29	-10.5	10	3
2.22	0.60	1.66	0.33	-10.5	10	3
2.23	0.61	1.71	0.30	-10.5	10	3

Sample calculation

$$E \text{ (dB } \mu\text{V/m)} = U \text{ (dB } \mu\text{V)} + \text{AF (dB 1/m)} + \text{Corr. (dB)}$$

U = Receiver reading

AF = Antenna factor

Corr. = sum of single correction factors of used cables, switch unit, distance correction, amplifier (if applicable)

distance correction = $-20 * \text{LOG} (d_{Limit} / d_{used})$

Linear interpolation will be used for frequencies in between the values in the table.

Tables show an extract of values.

7.4 ANTENNA R&S HF907 (1 GHZ – 18 GHZ)

Frequency	AF R&S HF907	Corr.
MHz	dB (1/m)	dB
1000	24.4	-19.4
2000	28.5	-17.4
3000	31.0	-16.1
4000	33.1	-14.7
5000	34.4	-13.7
6000	34.7	-12.7
7000	35.6	-11.0

cable loss 1 (relay + cable inside chamber)	cable loss 2 (outside chamber)	cable loss 3 (switch unit, attenuator & pre-amp)	cable loss 4 (to receiver)
dB	dB	dB	dB
0.99	0.31	-21.51	0.79
1.44	0.44	-20.63	1.38
1.87	0.53	-19.85	1.33
2.41	0.67	-19.13	1.31
2.78	0.86	-18.71	1.40
2.74	0.90	-17.83	1.47
2.82	0.86	-16.19	1.46

Frequency	AF R&S HF907	Corr.
MHz	dB (1/m)	dB
3000	31.0	-23.4
4000	33.1	-23.3
5000	34.4	-21.7
6000	34.7	-21.2
7000	35.6	-19.8

cable loss 1 (relay inside chamber)	cable loss 2 (inside chamber)	cable loss 3 (outside chamber)	cable loss 4 (switch unit, attenuator & pre-amp)	cable loss 5 (to receiver)	used for FCC 15.247
dB	dB	dB	dB	dB	
0.47	1.87	0.53	-27.58	1.33	
0.56	2.41	0.67	-28.23	1.31	
0.61	2.78	0.86	-27.35	1.40	
0.58	2.74	0.90	-26.89	1.47	
0.66	2.82	0.86	-25.58	1.46	

Frequency	AF R&S HF907	Corr.
MHz	dB (1/m)	dB
7000	35.6	-57.3
8000	36.3	-56.3
9000	37.1	-55.3
10000	37.5	-56.2
11000	37.5	-55.3
12000	37.6	-53.7
13000	38.2	-53.5
14000	39.9	-56.3
15000	40.9	-54.1
16000	41.3	-54.1
17000	42.8	-54.4
18000	44.2	-54.7

cable loss 1 (relay inside chamber)	cable loss 2 (High Pass)	cable loss 3 (pre-amp)	cable loss 4 (inside chamber)	cable loss 5 (outside chamber)	cable loss 6 (to receiver)
dB	dB	dB	dB	dB	dB
0.56	1.28	-62.72	2.66	0.94	1.46
0.69	0.71	-61.49	2.84	1.00	1.53
0.68	0.65	-60.80	3.06	1.09	1.60
0.70	0.54	-61.91	3.28	1.20	1.67
0.80	0.61	-61.40	3.43	1.27	1.70
0.84	0.42	-59.70	3.53	1.26	1.73
0.83	0.44	-59.81	3.75	1.32	1.83
0.91	0.53	-63.03	3.91	1.40	1.77
0.98	0.54	-61.05	4.02	1.44	1.83
1.23	0.49	-61.51	4.17	1.51	1.85
1.36	0.76	-62.36	4.34	1.53	2.00
1.70	0.53	-62.88	4.41	1.55	1.91

Sample calculation

$$E \text{ (dB } \mu\text{V/m)} = U \text{ (dB } \mu\text{V)} + \text{AF (dB 1/m)} + \text{Corr. (dB)}$$

U = Receiver reading

AF = Antenna factor

Corr. = sum of single correction factors of used cables, switch unit, distance correction, amplifier (if applicable)

Linear interpolation will be used for frequencies in between the values in the table.

Tables show an extract of values.

7.5 ANTENNA EMCO 3160-09 (18 GHZ – 26.5 GHZ)

Frequency MHz	AF EMCO 3160-09 dB (1/m)	Corr. dB
18000	40.2	-23.5
18500	40.2	-23.2
19000	40.2	-22.0
19500	40.3	-21.3
20000	40.3	-20.3
20500	40.3	-19.9
21000	40.3	-19.1
21500	40.3	-19.1
22000	40.3	-18.7
22500	40.4	-19.0
23000	40.4	-19.5
23500	40.4	-19.3
24000	40.4	-19.8
24500	40.4	-19.5
25000	40.4	-19.3
25500	40.5	-20.4
26000	40.5	-21.3
26500	40.5	-21.1

cable loss 1 (inside chamber) dB	cable loss 2 (pre- amp) dB	cable loss 3 (inside chamber) dB	cable loss 4 (switch unit) dB	cable loss 5 (to receiver) dB
0.72	-35.85	6.20	2.81	2.65
0.69	-35.71	6.46	2.76	2.59
0.76	-35.44	6.69	3.15	2.79
0.74	-35.07	7.04	3.11	2.91
0.72	-34.49	7.30	3.07	3.05
0.78	-34.46	7.48	3.12	3.15
0.87	-34.07	7.61	3.20	3.33
0.90	-33.96	7.47	3.28	3.19
0.89	-33.57	7.34	3.35	3.28
0.87	-33.66	7.06	3.75	2.94
0.88	-33.75	6.92	3.77	2.70
0.90	-33.35	6.99	3.52	2.66
0.88	-33.99	6.88	3.88	2.58
0.91	-33.89	7.01	3.93	2.51
0.88	-33.00	6.72	3.96	2.14
0.89	-34.07	6.90	3.66	2.22
0.86	-35.11	7.02	3.69	2.28
0.90	-35.20	7.15	3.91	2.36

Sample calculation

$$E \text{ (dB } \mu\text{V/m)} = U \text{ (dB } \mu\text{V)} + AF \text{ (dB 1/m)} + Corr. \text{ (dB)}$$

U = Receiver reading

AF = Antenna factor

Corr. = sum of single correction factors of used cables, switch unit, distance correction, amplifier (if applicable)

Linear interpolation will be used for frequencies in between the values in the table.

Table shows an extract of values.

7.6 ANTENNA EMCO 3160-10 (26.5 GHZ – 40 GHZ)

Frequency GHz	AF EMCO 3160-10 dB (1/m)	Corr. dB	cable loss 1 (inside chamber) dB	cable loss 2 (outside chamber) dB	cable loss 3 (switch unit) dB	cable loss 4 (to receiver) dB	distance corr. (-20 dB/ decade) dB	d _{Limit} (meas. distance (limit) m	d _{used} (meas. distance (used) m
26.5	43.4	-11.2	4.4				-9.5	3	1.0
27.0	43.4	-11.2	4.4				-9.5	3	1.0
28.0	43.4	-11.1	4.5				-9.5	3	1.0
29.0	43.5	-11.0	4.6				-9.5	3	1.0
30.0	43.5	-10.9	4.7				-9.5	3	1.0
31.0	43.5	-10.8	4.7				-9.5	3	1.0
32.0	43.5	-10.7	4.8				-9.5	3	1.0
33.0	43.6	-10.7	4.9				-9.5	3	1.0
34.0	43.6	-10.6	5.0				-9.5	3	1.0
35.0	43.6	-10.5	5.1				-9.5	3	1.0
36.0	43.6	-10.4	5.1				-9.5	3	1.0
37.0	43.7	-10.3	5.2				-9.5	3	1.0
38.0	43.7	-10.2	5.3				-9.5	3	1.0
39.0	43.7	-10.2	5.4				-9.5	3	1.0
40.0	43.8	-10.1	5.5				-9.5	3	1.0

Sample calculation

$$E \text{ (dB } \mu\text{V/m)} = U \text{ (dB } \mu\text{V)} + \text{AF (dB 1/m)} + \text{Corr. (dB)}$$

U = Receiver reading

AF = Antenna factor

Corr. = sum of single correction factors of used cables, switch unit, distance correction, amplifier (if applicable)

Linear interpolation will be used for frequencies in between the values in the table.

distance correction = $-20 * \text{LOG} (d_{\text{Limit}} / d_{\text{used}})$

Linear interpolation will be used for frequencies in between the values in the table.

Table shows an extract of values.

8 MEASUREMENT UNCERTAINTIES

Test Case	Parameter	Uncertainty
AC Power Line	Power	± 3.4 dB
Field Strength of spurious radiation	Power	± 5.5 dB
6 dB / 26 dB / 99% Bandwidth	Power Frequency	± 2.9 dB ± 11.2 kHz
Conducted Output Power	Power	± 2.2 dB
Band Edge Compliance	Power Frequency	± 2.2 dB ± 11.2 kHz
Frequency Stability	Frequency	± 25 Hz
Power Spectral Density	Power	± 2.2 dB

The measurement uncertainties for all parameters are calculated with an expansion factor (coverage factor) $k = 1.96$. This means, that the true value is in the corresponding interval with a probability of 95 %.

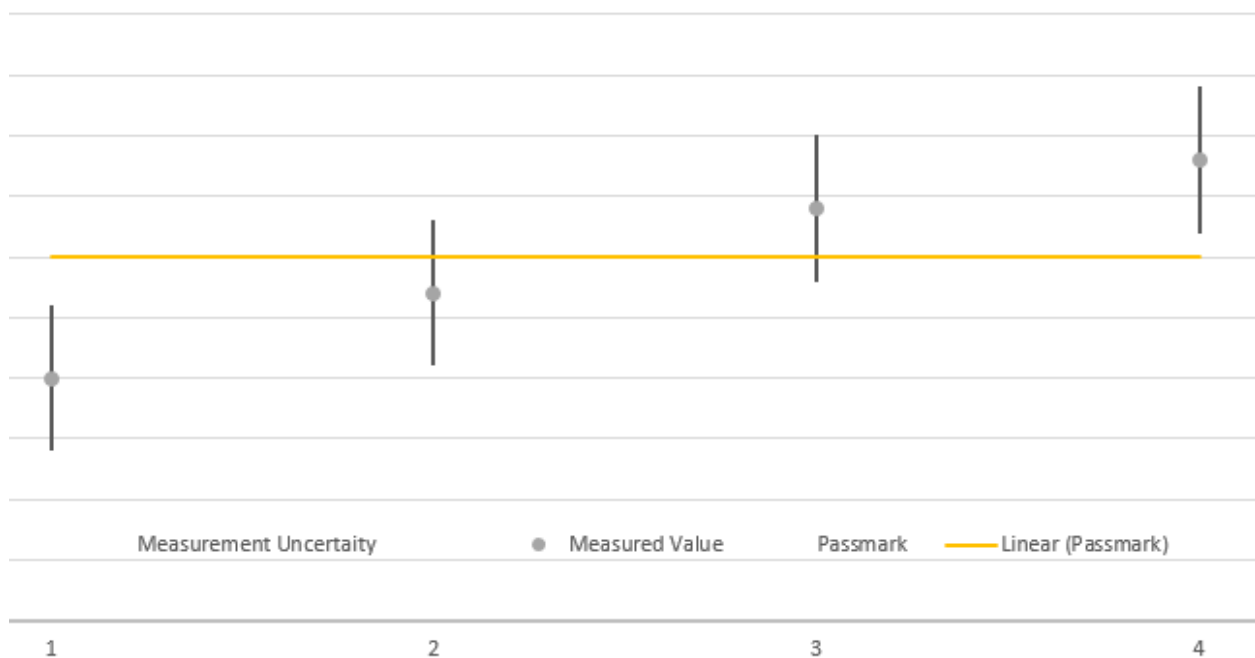

The verdicts in this test report are given according the above diagram:

Case	Measured Value	Uncertainty Range	Verdict
1	below pass mark	below pass mark	Passed
2	below pass mark	within pass mark	Passed
3	above pass mark	within pass mark	Failed
4	above pass mark	above pass mark	Failed

That means, the laboratory applies, as decision rule (see ISO/IEC 17025:2017), the so called shared risk principle.

9 PHOTO REPORT

Please see separate photo report.

End of report