

Specification

Part No. : **GW.59.3153**

Product Name : 2.4GHz/5.1~5.85GHz 3dBi Screw mount Dipole
Antenna

Description : RP-SMA Male Straight Connector
Hinged
IP-65
TPU Housing
Length 156mm
RoHS Compliant



1. Introduction

The GW.59 dipole RP-SMA plug mount antenna is ideal for 2.4GHz/5.15~5.85GHz wireless applications such as Bluetooth and Wireless LAN. At 156mm in length omni-directional 3dBi gain across all bands ensures constant reception and transmission. The antenna structure is designed for robust handling and the housing is made with TPU giving superior environmental reliability and a quality finish. The antenna can be rotated 90 degrees on the base hinge for ease of placement.

Many module manufacturers specify peak gain limits for any antennas that are to be connected to that module. Those peak gain limits are based on free-space conditions. In practice, the peak gain of an antenna tested in free-space can degrade by at least 1 or 2dBi when put inside a device. So ideally you should go for a slightly higher peak gain antenna than mentioned on the module specification to compensate for this effect, giving you better performance.

Upon testing of any of our antennas with your device and a selection of appropriate layout, integration technique, or cable, Taoglas can make sure any of our antennas' peak gain will be below the peak gain limits. Taoglas can then issue a specification and/or report for the selected antenna in your device that will clearly show it complying with the peak gain limits, so you can be assured you are meeting regulatory requirements for that module.

For example, a module manufacturer may state that the antenna must have less than 2dBi peak gain, but you don't need to select an embedded antenna that has a peak gain of less than 2dBi in free-space. This will give you a less optimized solution. It is better to go for a slightly higher free-space peak gain of 3dBi or more if available. Once that antenna gets integrated into your device, performance will degrade below this 2dBi peak gain due to the effects of GND plane, surrounding components, and device housing. If you want to be absolutely sure, contact Taoglas and we will test.

Choosing a Taoglas antenna with a higher peak gain than what is specified by the module manufacturer and enlisting our help will ensure you are getting the best performance possible without exceeding the peak gain limits.

It is better not to select an embedded antenna with very low free-space peak gain (<2dBi) directly, as this antenna would have worse performance in your device, and lead to compromised performance compared to using a Taoglas antenna.

2. Specification Table

Parameter	GSM Band	
Frequency	2.4 ~ 2.5GHz,	5.15 ~ 5.85GHz
Peak Gain (dBi)*	2.37	2.93
Average Gain (dBi)*	-1.21	-1.32
Efficiency (%)*	75	73
Return Loss (dB)*	- 10 dB Maximum	
Radiation	Omni-directional	
Polarization	Linear Vertical	
Power Handling	1W	
Impedance	50 Ω	
MECHANICAL		
Cable	RG-178 Coaxial Cable	
Antenna Cover	TPE	
Antenna Base	PC & PBT	
Color	Black	
Connector	RP-SMA(M)	
IP rating	IP65	
ENVIRONMENTAL		
Operation Temperature	-40°C ~ + 85°C	
Storage Temperature	-40°C ~ + 85°C	

*The antenna was measured in free space.

3. Antenna Characteristics

3.1. Return Loss

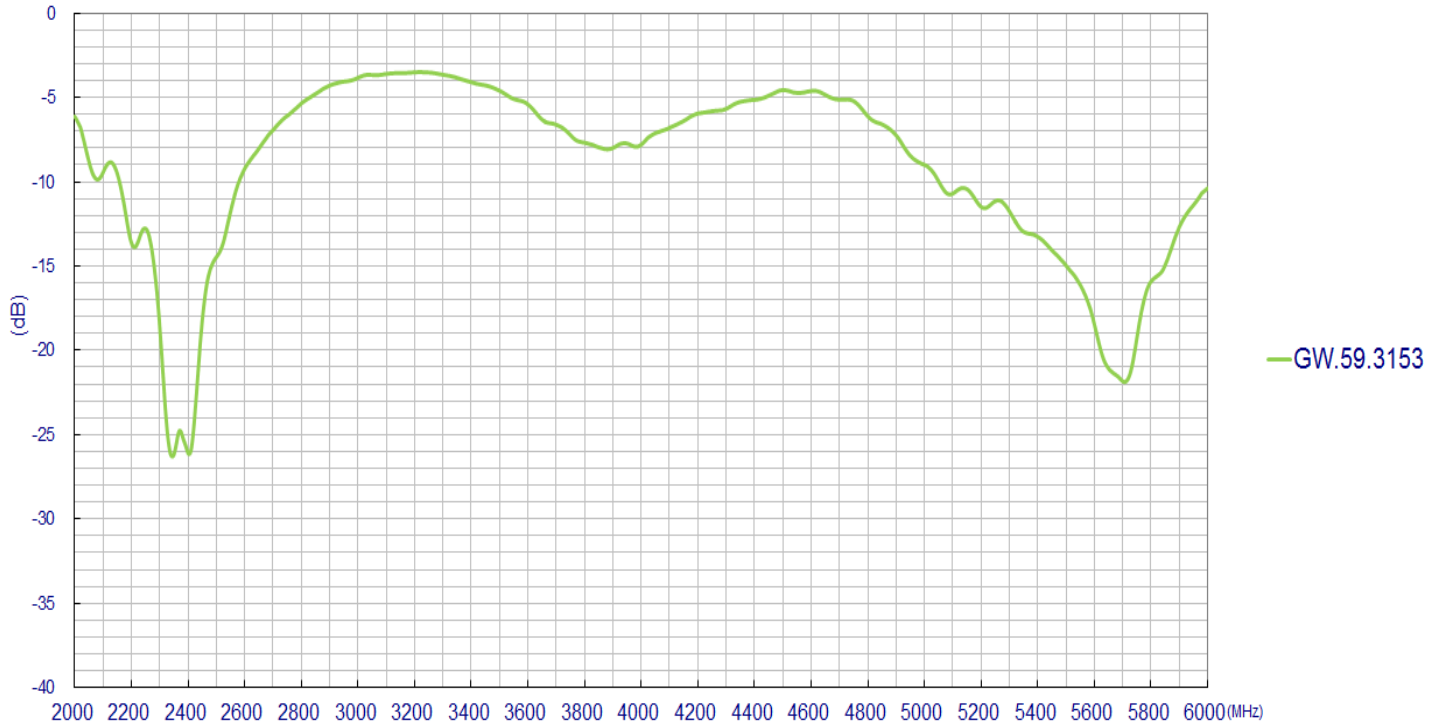

3.2. Peak Gain

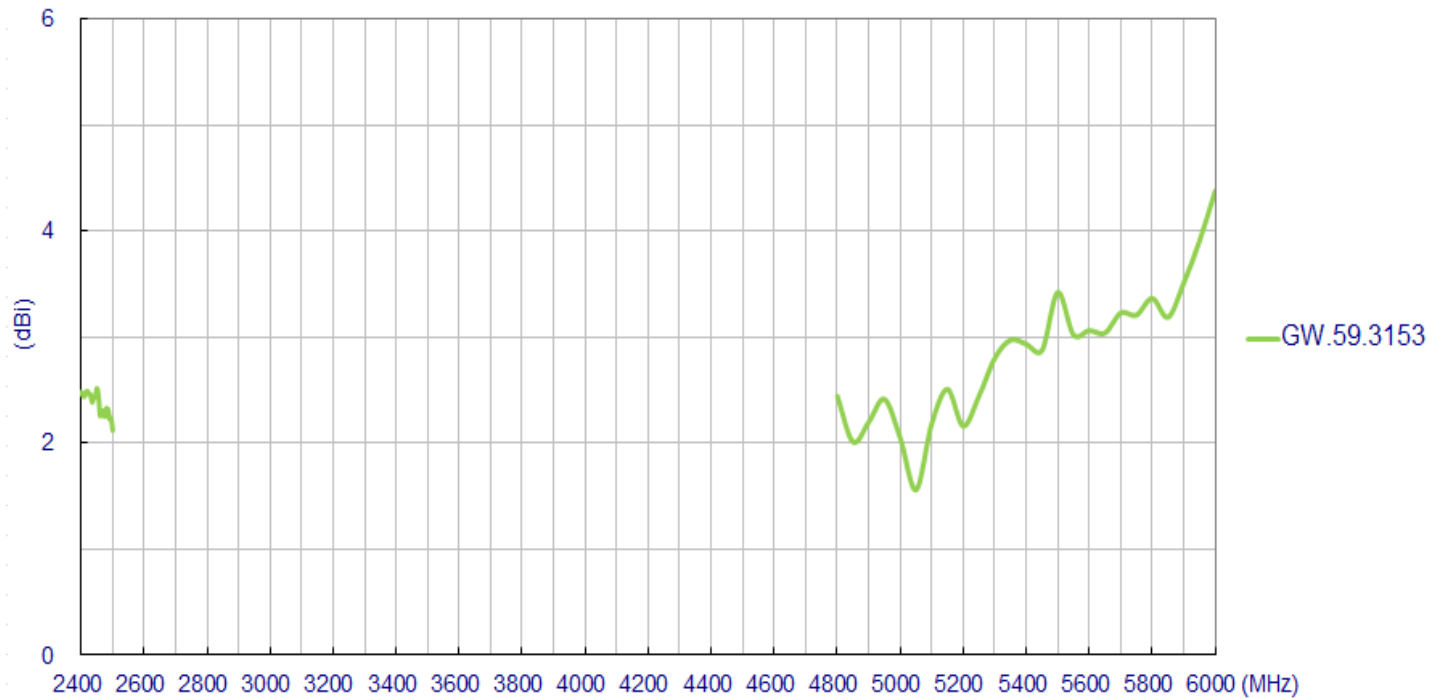

3.3. Average Gain

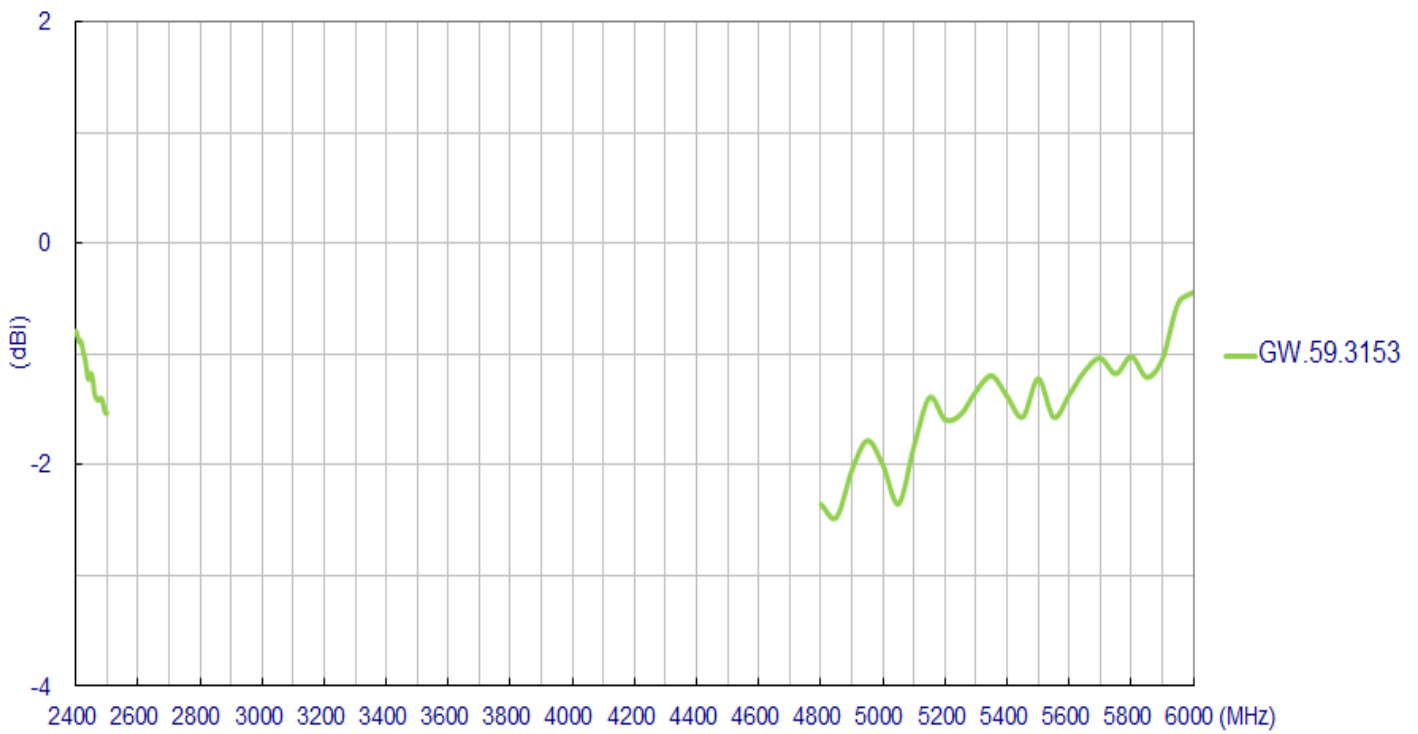

3.4. Efficiency

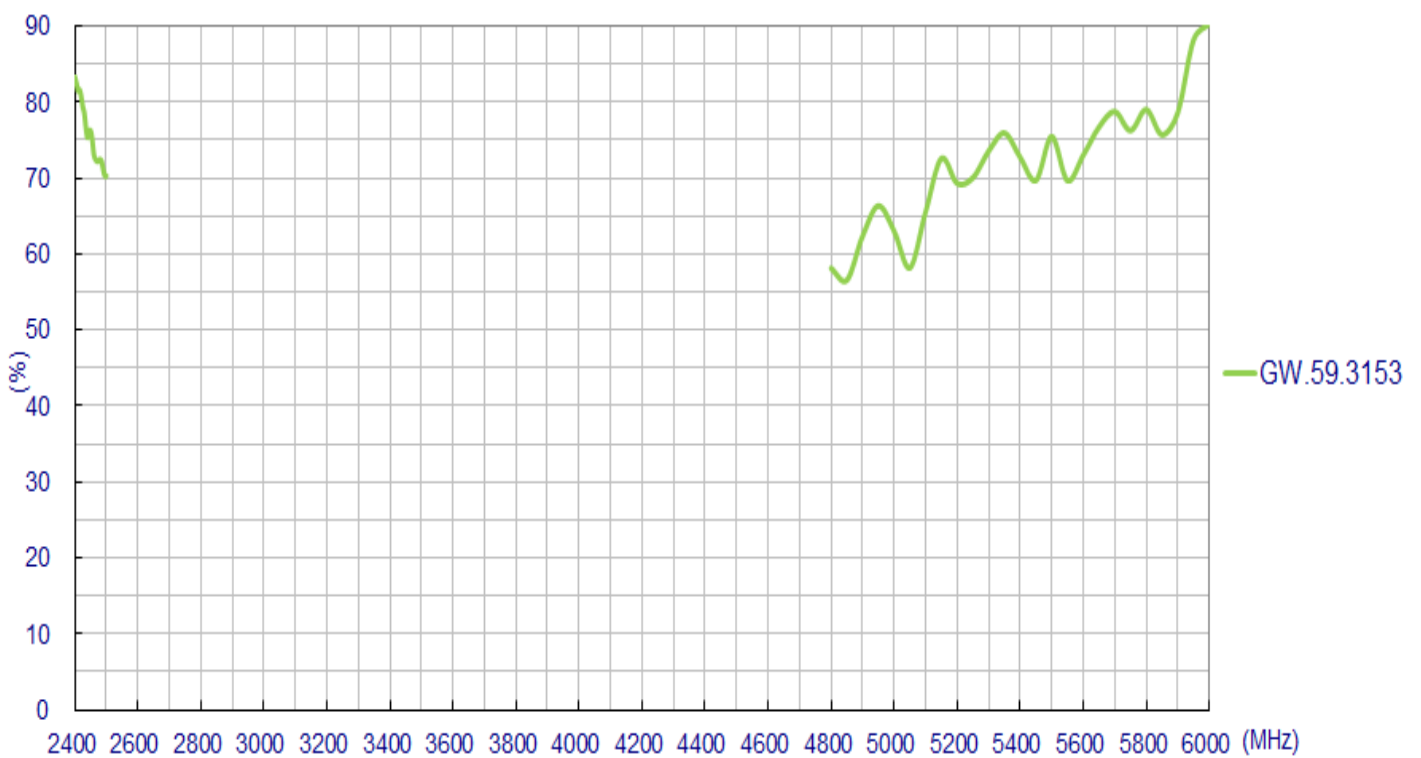

4. Radiation Patterns

The antenna radiation pattern was measured in ETS Anechoic Chamber. The testing setup is as below. The antenna was measured in free space.



XY Plane

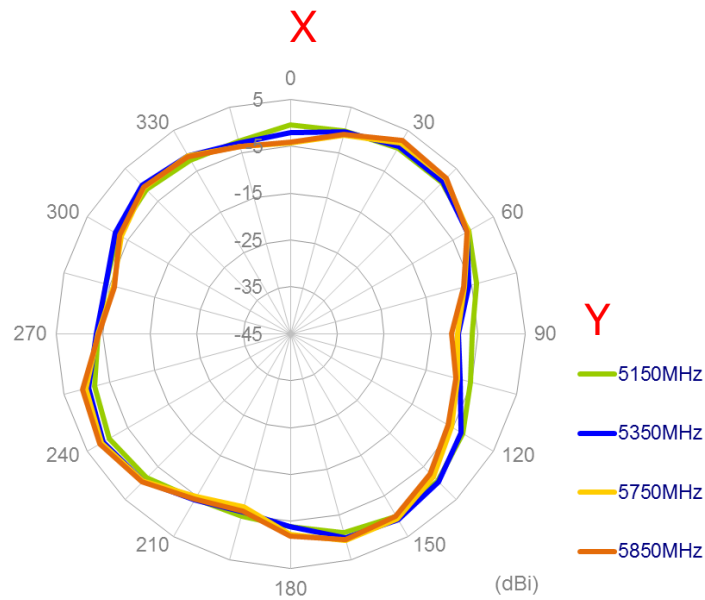
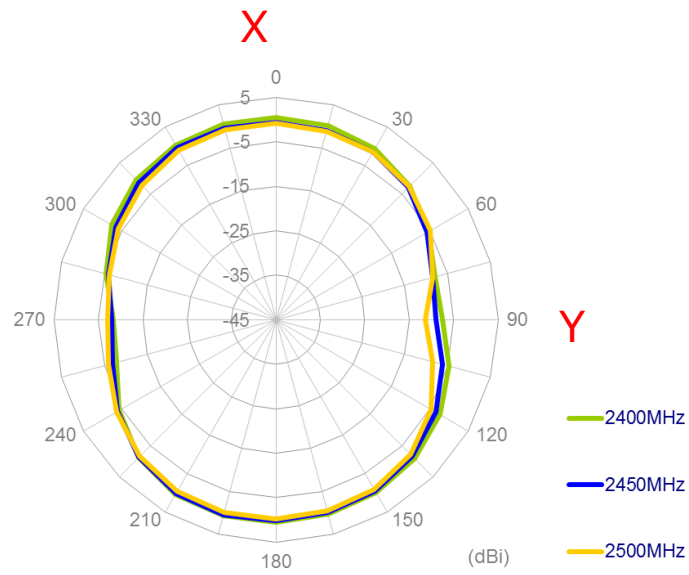

XZ Plane

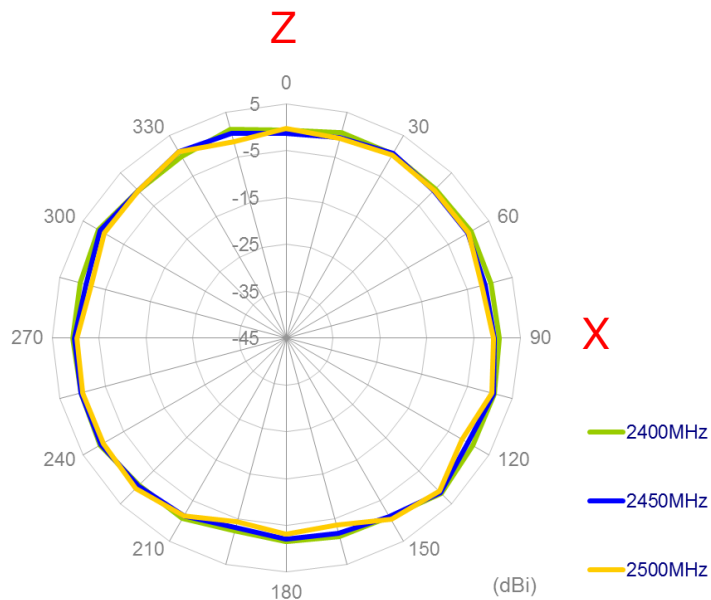

Z

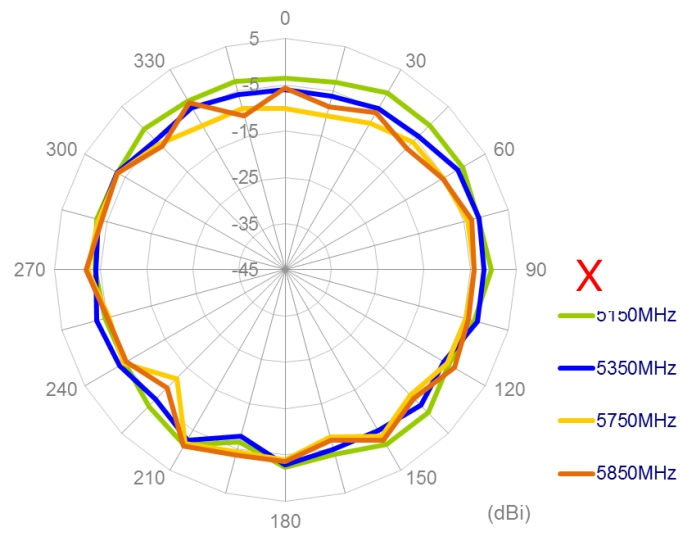

YZ Plane

Z

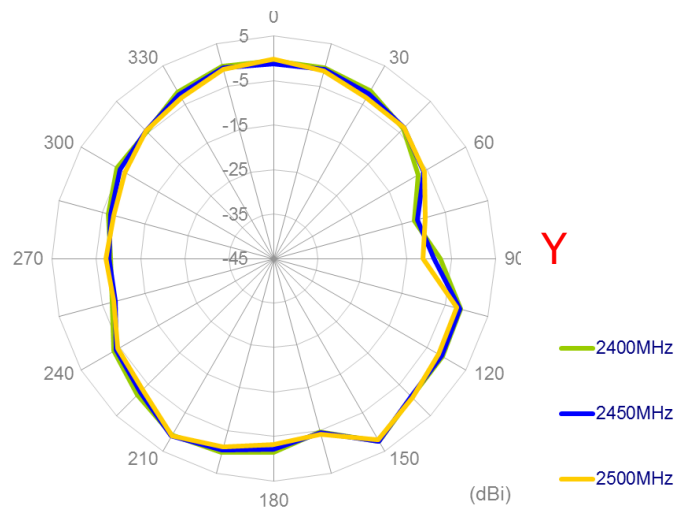

Z

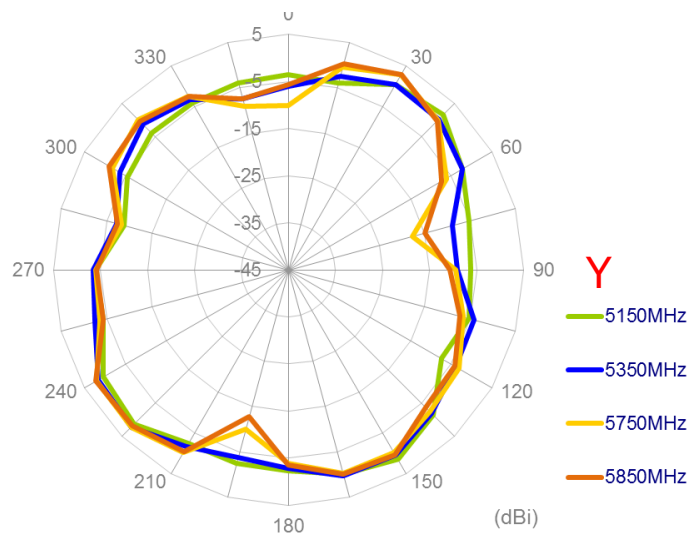

4. Drawing (Unit: mm)

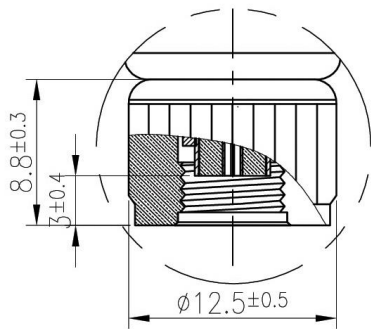

Detail A
Scale:2:1

Name	Material	Finish	QTY
1 Housing	TPEE	Black	1
2 Base Top	ABS	Black	1
3 Base Bottom	PC+PBT	Black	1
4 SMA(M)RP	Brass	Black	1

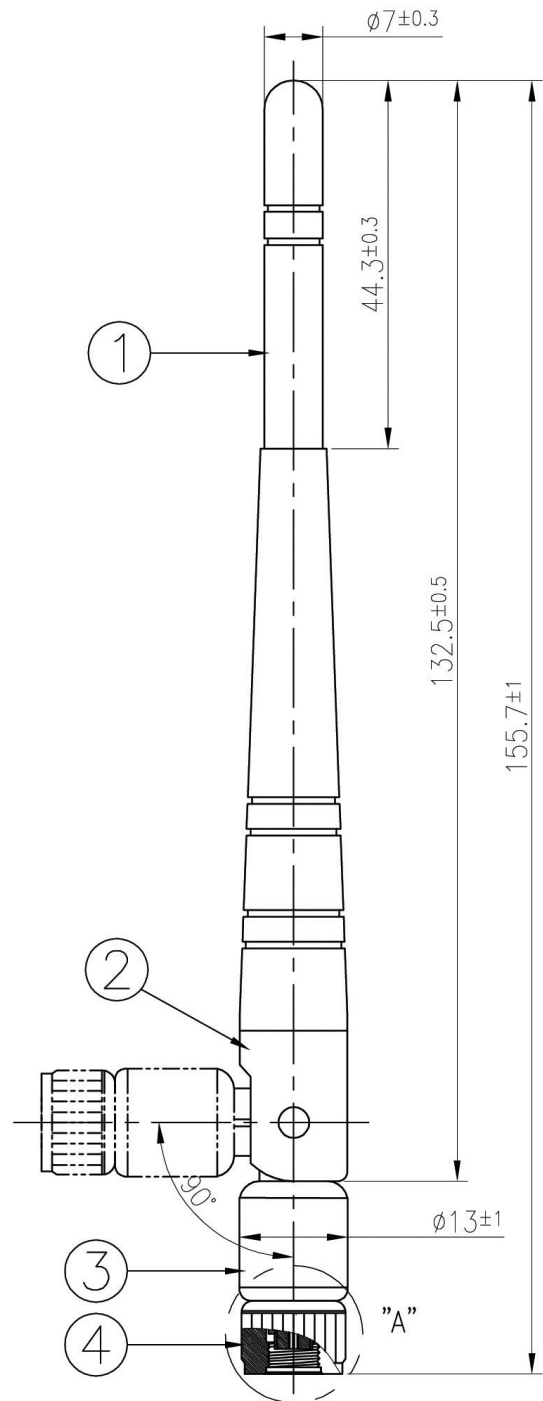

5. Application Note

5.1. GW.59 antenna measurement setup as shown the below ,(40mmx60mm PCB board)

On the short side



Antenna straight



Antenna R/A

On the long side



Antenna straight

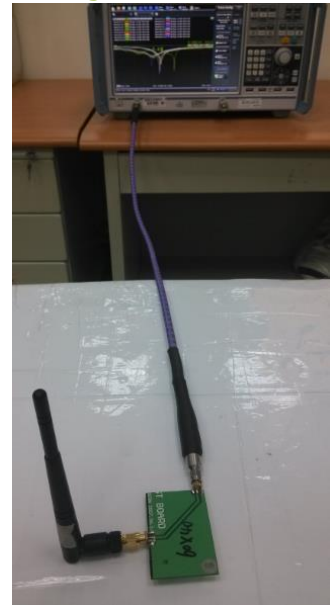

Antenna R/A

On the 30cmX30cm ground plane



Antenna straight



Antenna R/A

On the 50cmX50cm ground plane



Antenna straight

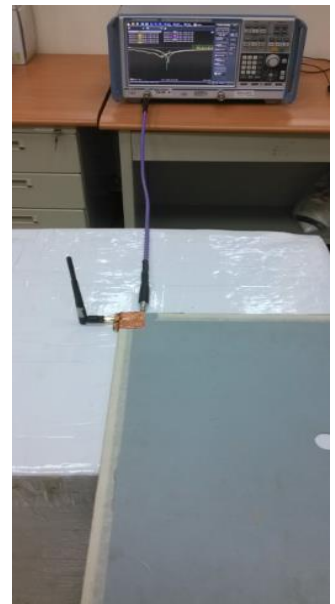

Antenna R/A

5.2. Return Loss when antenna setup on different conditions

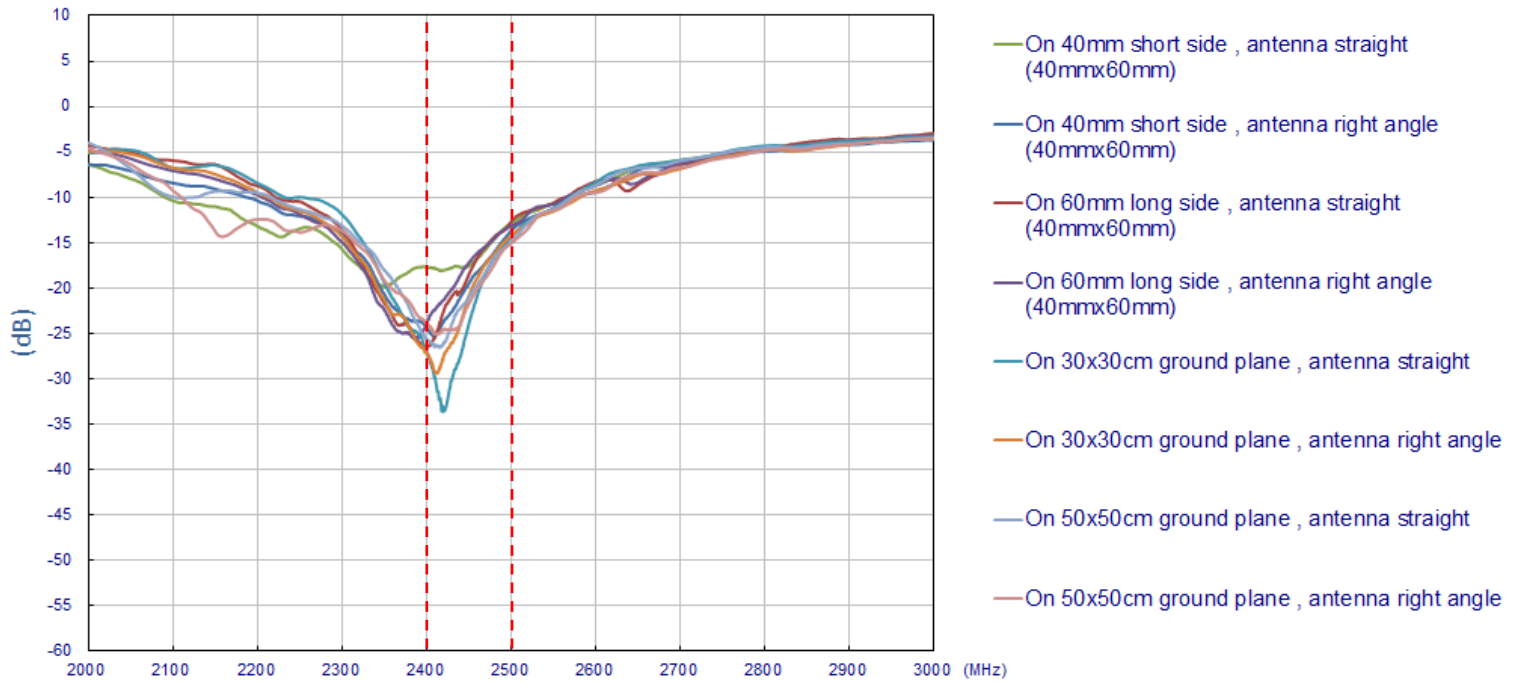

5.3. GW.59 antenna measurement,(40mmx100mm PCB board)

On the short side

On the long side

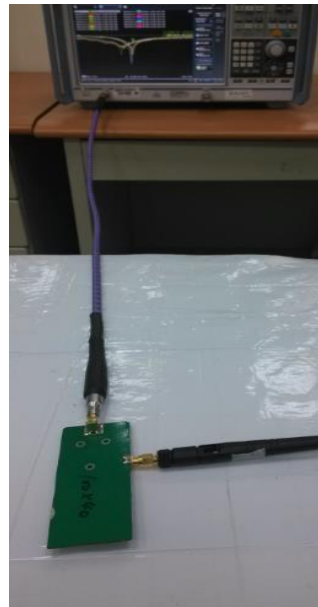

Antenna straight

Antenna R/A

Antenna straight

Antenna R/A

5.4. Return Loss when antenna setup on different conditions

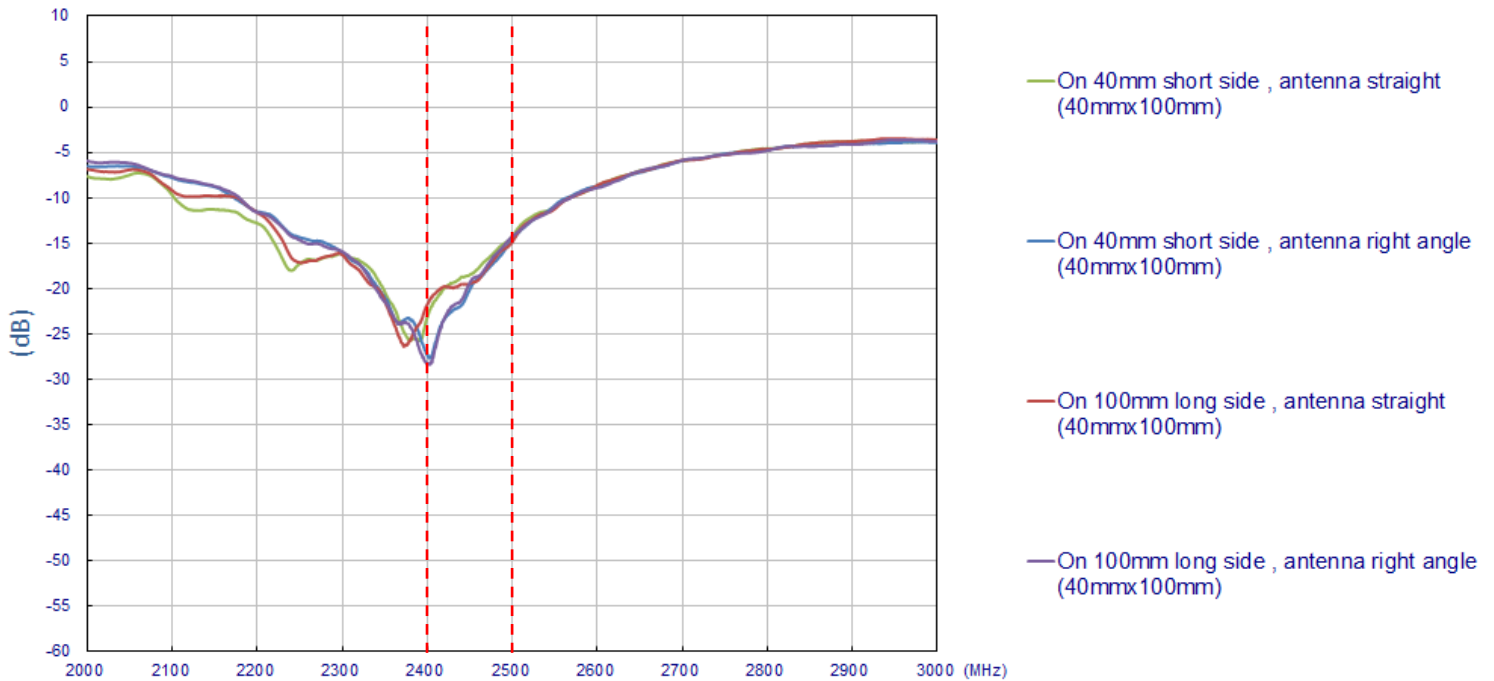

5.5. GW.59 antenna measurement,(90mmx150mm PCB board)

On the short side

On the long side

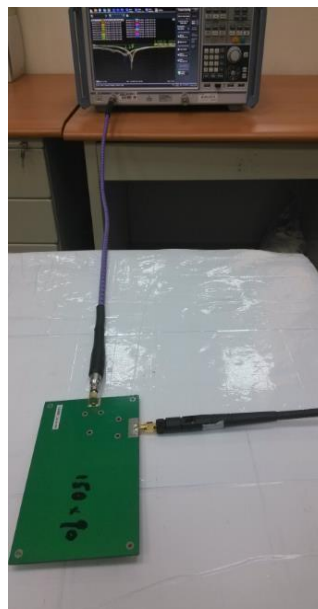
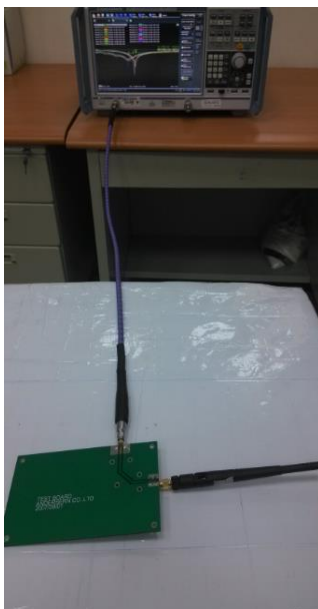

Antenna straight

Antenna R/A

Antenna straight

Antenna R/A

5.6. Return Loss when antenna setup on different conditions

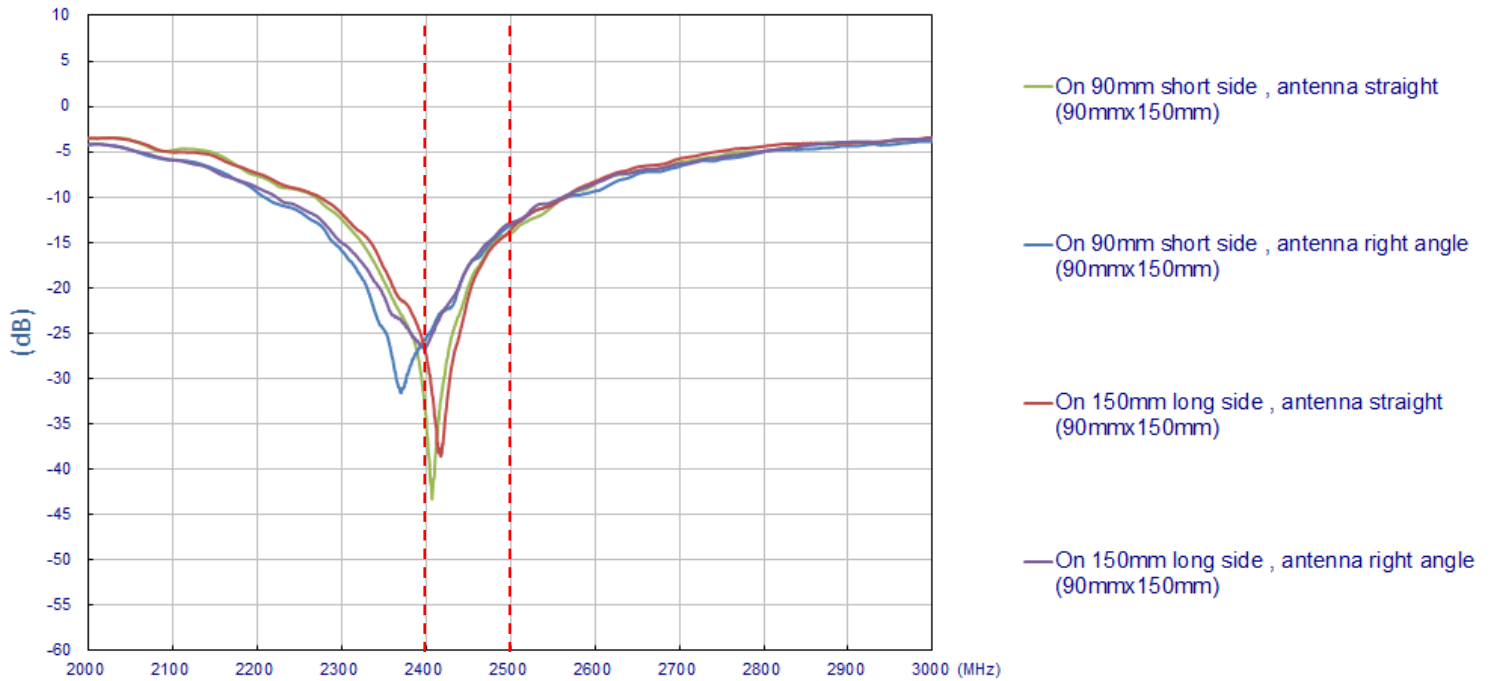

6. Packaging

10 pcs GW.59.3153 per PE Bag
 Bag Dimensions - 260 x 150 mm
 Weight - 175g

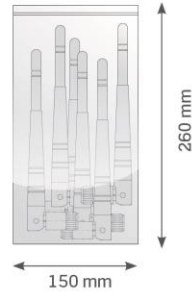

100 pcs GW.59.3153 per Large PE Large Bag
 Bag Dimensions - 430 x 250 mm
 Weight - 1.78kg

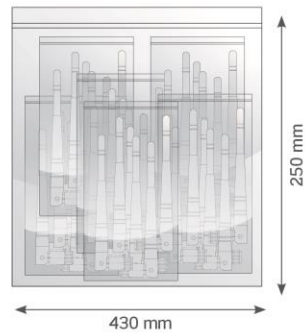

400 pcs GW.59.3153 per carton
 Carton - 360 x 310 x 160mm
 Weight - 7.6Kg

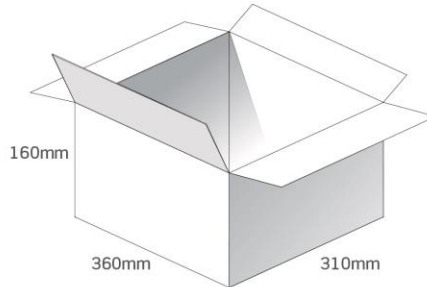

Pallet Dimensions 120 x 100 x 148cm
 72 Cartons per Pallet
 9 Cartons per layer
 8 Layers

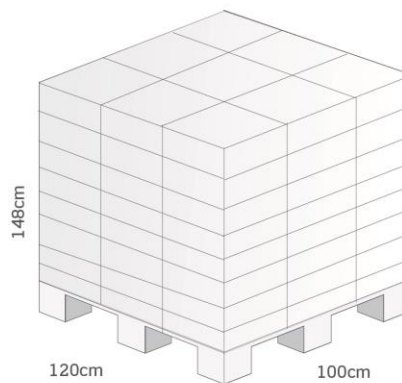

Taoglas makes no warranties based on the accuracy or completeness of the contents of this document and reserves the right to make changes to specifications and product descriptions at any time without notice. Taoglas reserves all rights to this document and the information contained herein.

Reproduction, use or disclosure to third parties without express permission is strictly prohibited.

Copyright © Taoglas Ltd.