

BMD-360

Stand-alone Bluetooth 5.1 low energy and IEEE 802.15.4 module

Data sheet



Abstract

This technical data sheet describes the BMD-360 stand-alone Bluetooth® low energy and IEEE 802.15.4 module. The OEMs can embed their own application on top of the integrated Bluetooth low energy stack using Nordic SDK integrated development environment (IDE).

Document information

Title	BMD-360	
Subtitle	Stand-alone Bluetooth 5.1 low energy and IEEE 802.15.4 module	
Document type	Data sheet	
Document number	UBX-19039466	
Revision and date	R03	21-Oct-2019
Disclosure restriction		

Product status	Corresponding content status	
Functional sample	Draft	For functional testing. Revised and supplementary data will be published later.
In development / Prototype	Objective specification	Target values. Revised and supplementary data will be published later.
Engineering sample	Advance information	Data based on early testing. Revised and supplementary data will be published later.
Initial production	Early production information	Data from product verification. Revised and supplementary data may be published later.
Mass production / End of life	Production information	Document contains the final product specification.

This document applies to the following products:

Product name	Type number	PCN reference	Product status
BMD-360	BMD-360-A-R-00	N/A	Engineering Sample

u-blox or third parties may hold intellectual property rights in the products, names, logos and designs included in this document. Copying, reproduction, modification or disclosure to third parties of this document or any part thereof is only permitted with the express written permission of u-blox.

The information contained herein is provided "as is" and u-blox assumes no liability for its use. No warranty, either express or implied, is given, including but not limited to, with respect to the accuracy, correctness, reliability and fitness for a particular purpose of the information. This document may be revised by u-blox at any time without notice. For the most recent documents, visit www.u-blox.com.

Copyright © u-blox AG.

Contents

Document information	2
Contents	3
1 Functional description	5
1.1 Features	5
1.2 Applications	5
1.3 Block diagram	6
1.4 Radio performance	6
2 Pin definition	8
2.1 Pin assignment.....	8
2.2 Peripheral pin assignments	9
3 Electrical specifications	10
3.1 Absolute maximum ratings	10
3.2 Operating conditions	10
3.3 General purpose I/O	10
3.4 Module reset	11
3.5 Debug and programming.....	11
3.6 Clocks	11
3.6.1 32.768 kHz crystal (LFXO) (preliminary).....	12
3.6.2 32.768 kHz clock source comparison	12
4 Firmware	13
4.1 Factory image	13
4.2 SoftDevices	13
4.2.1 S113	13
4.2.2 IEEE 802.15.4 (Thread and Zigbee)	13
4.3 Bluetooth address.....	13
5 Mechanical specifications	14
5.1 Dimensions.....	14
5.2 Recommended PCB land pads	14
5.3 Module marking.....	15
6 RF design notes	16
6.1 Recommended RF layout and ground plane.....	16
6.2 Mechanical enclosure.....	16
7 Antenna patterns	17
7.1 X-Y plane	17
7.2 Y-Z plane.....	18
7.3 Z-X plane	18
8 BMD-360 evaluation development kit	19
9 Qualification and approvals	20
9.1 United States (FCC) (pending approval)	20
9.1.1 Labeling and user information requirements	20

9.1.2 RF exposure	21
9.2 Canada (ISED) (pending approval).....	21
9.2.1 Labeling and user information requirements	21
9.2.2 RF exposure	22
9.3 Europe (CE-RED) (pending approval)	22
9.3.1 Labeling and user information requirements	22
9.4 Australia / New Zealand (RCM) (pending approval).....	22
9.5 Bluetooth qualification (pending)	23
10 Environmental.....	24
10.1 RoHS	24
10.2 REACH	24
10.3 California proposition 65 (P65)	24
11 Product handling.....	25
11.1 Packaging	25
11.2 Reel packaging.....	25
11.3 Carrier tape dimensions	25
11.4 Moisture sensitivity level.....	25
11.5 Reflow soldering	26
12 Labeling and ordering information	27
12.1 Batch Label.....	27
12.2 Multipack label.....	27
12.3 Ordering information.....	28
13 Life support and other high-risk use warning	29
Related documents	30
Revision history	30
Contact.....	31

1 Functional description

The BMD-360 is a powerful, highly flexible, ultra-low power Bluetooth 5.1 and IEEE 802.15.4 (Thread and Zigbee) module based on the nRF52811 SoC from Nordic Semiconductor. With an Arm® Cortex® M4 CPU, embedded 2.4GHz transceiver, and integrated antenna, it provides a complete RF solution with no additional RF design, allowing faster time to market. Providing full use of the nRF52811's capabilities and peripherals, the BMD-360 can power demanding applications, while simplifying designs and reducing BOM costs. Angle of Arrival (AoA) and Angle of Departure (AoD) features of Bluetooth 5.1 are supported. With an internal DC-DC converter and intelligent power control, the BMD-360 provides class-leading power efficiency, enabling ultra-low power sensitive applications. Regulatory pre-approvals reduce the burden to enter the market. As a drop-in replacement for the BMD-300/301/330, the BMD-360 completes the BMD-300 Series lineup with an optimized peripheral set that is attractive for a wide range of cost-sensitive applications.

1.1 Features

- Based on the Nordic Semiconductor nRF52811 SoC
- Bluetooth 5.1 2M PHY, 1M PHY, Coded PHY (long range), CSA #2, AoA, AoD
- IEEE 802.15.4 with Thread and Zigbee support
- Complete RF solution with an integrated DC-DC converter
- Nordic Semiconductor SoftDevice ready
- Over-the-Air (OTA) firmware updates
- No external components required
- Arm® Cortex®-M4 32-bit processor
- 192 kB embedded flash memory
- 24 kB RAM
- -40 °C to +85 °C Temperature Range
- 32 General Purpose I/O Pins
- 12-bit/200 KSPS ADC
- Serial Wire Debug (SWD)
- SPI Master/Slave (8 Mbps)
- 2-wire Master/Slave (I2C compatible)
- Footprint compatible with BMD-300, BMD-301, BMD-330, BMD-340, and BMD-341
- UART (w/ CTS/RTS and DMA)
- Temperature sensor
- 20 channel CPU independent Programmable Peripheral Interconnect (PPI)
- Quadrature Demodulator (QDEC)
- 128-bit AES HW encryption
- 3 x 32 bit Timer / Counter
- 2 x 24 bit Real-Time Counter (RTC)
- Dimensions: 14 x 9.8 x 1.9mm

1.2 Applications

- Beacons – iBeacon™, Eddystone, AltBeacon, AoA, AoD
- Low-Power Sensors
- Fitness devices
- Wearables
- Climate Control
- Lighting
- Safety and Security
- Home Appliances

- Access Control
- Internet of Things
- Home Health Care
- Advanced Remote Controls
- Smart Energy Management
- Low-Power Sensor Networks
- Interactive Entertainment
- Key Fobs
- Environmental Monitoring
- Hotel Automation
- Office Automation

1.3 Block diagram

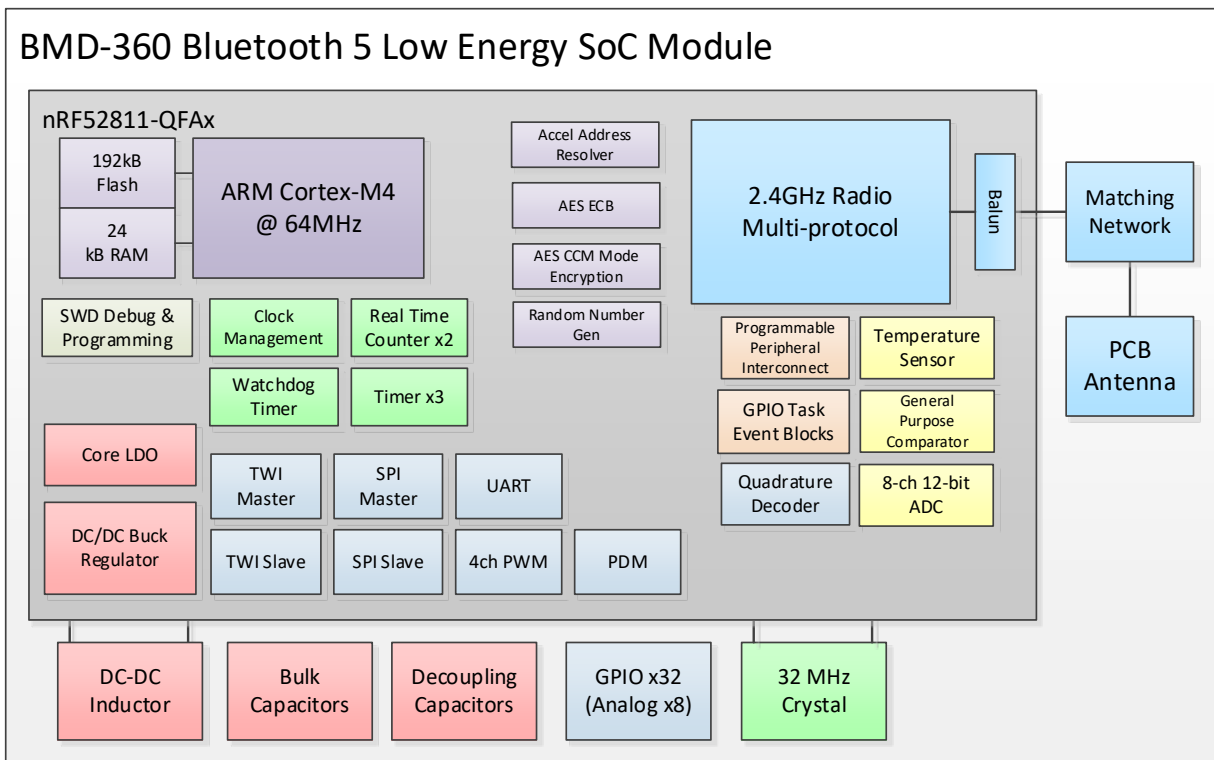

Figure 1: Block diagram of BMD-360

1.4 Radio performance

Detail	Description
Bluetooth	
Bluetooth version	Bluetooth 5 Low Energy, Peripheral (S113), 2M PHY, 1M PHY, Coded PHY, CSA #2, AoA/AoD
Bluetooth security	AES-128
LE connections	Concurrent peripheral roles (S113)
IEEE 802.15.4	
Thread stack	OpenThread, Thread 1.1 compatible
Thread security	AES-128
Zigbee stack	Zigbee 3.0 compatible
Radio	
Frequency	2.360 GHz to 2.500 GHz

Detail	Description
Modulations	GFSK at 1 Mbps and 2 Mbps, QPSK at 250 Kbps
Receiver sensitivity	-97 dBm (Bluetooth low energy 1M mode), -104 dBm (Coded PHY mode)
Antenna	Integrated (3 dBi peak)
Current consumption	
TX only @ +4 dBm, 0 dBm @ 3V, DCDC enabled	7.0 mA, 4.6 mA
TX only @ +4 dBm, 0 dBm	15.4 mA, 10.1 mA
RX only @ 1 Mbps @ 3V, DCDC enabled	4.6 mA
RX only @ 1 Mbps	10.0 mA
RX only @ 2 Mbps @ 3V, DCDC enabled	5.2 mA
RX only @ 2 Mbps	11.2 mA
CPU @ 64 MHz from flash, from RAM	4.2 mA, 4.0 mA
CPU @ 64 MHz from flash, from RAM @ 3 V, DCDC enabled	2.2 mA, 2.1 mA
System Off, On	0.3 μ A, 0.6 μ A
Additional current for RAM retention	30 nA / 4 KB block
Dimensions	
BMD-360	Length: 14.0 mm \pm 0.3mm
	Width: 9.8 mm \pm 0.3mm
	Height: 1.9 mm \pm 0.1mm
Hardware	
Interfaces	SPI Master/Slave x 2 UART Two-Wire Master/Slave (I2C) GPIO x 32 PWM PDM
Power supply	1.7 V to 3.6 V
Temperature range	-40 $^{\circ}$ C to +85 $^{\circ}$ C
Certifications	
USA (FCC) (Pending)	FCC part 15.247 modular certification FCC ID: XPYBMD360
Canada (IC) (Pending)	Industry Canada RSS-247 modular certification IC: 8595A-BMD360
Europe (CE) (Pending)	EN 60950-1: A2:2013 3.1 (a): Health and Safety of the User EN 301 489-1 V2.1.1 & 3.1 (b): Electromagnetic Compatibility EN 301 489-17 V3.1.1 EN 300 328 V2.1.1 3.2: Effective use of spectrum allocated
Australia / New Zealand (RCM) (Pending)	AS/NZS 4268:2017, Radio equipment and systems – Short range devices
Bluetooth (Pending)	BMD-360 BT5 RF-PHY Component (Tested) – DID: Pending; QDID: Pending
Export	
BMD-360	ECCN: 5A992.C, Exception 740.17(b)(1) HTS: 8473.30.1180
Nordic Semiconductor nRF52810	nRF52811 Product Specification nRF5 Software Development Kit

2 Pin definition

2.1 Pin assignment

The BMD-360 shares an identical pin-out with the BMD-300, BMD-301, and BMD-330. This pin-out is also a subset of the BMD-340/341 footprint, allowing a single design to support any of these modules.

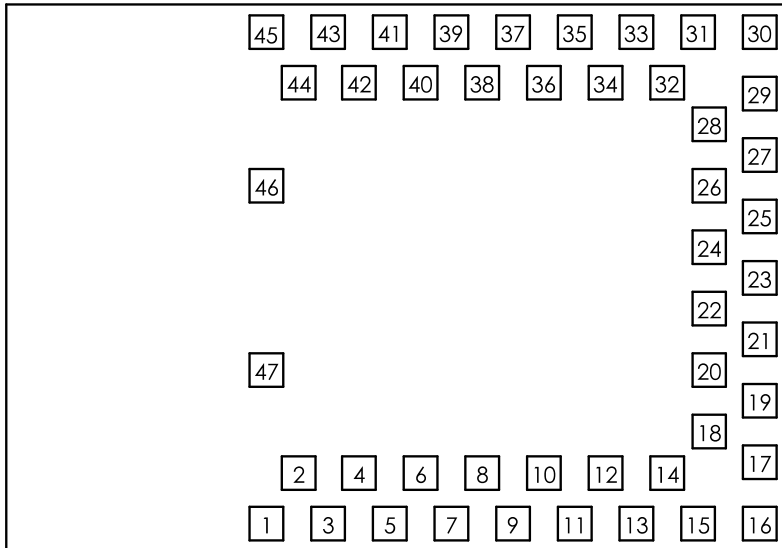

Figure 2: BMD-360 Pin assignment (Top view)

No.	Name	I/O	Description	nRF52 pin	Remarks
1	GND	Power	Electrical Ground		
2	GND	Power	Electrical Ground		
3	GND	Power	Electrical Ground		
4	GND	Power	Electrical Ground		
5	GND	Power	Electrical Ground		
6	P0.25	I/O	GPIO	P0.25	Standard drive, low frequency I/O only
7	P0.26	I/O	GPIO	P0.26	Standard drive, low frequency I/O only
8	P0.27	I/O	GPIO	P0.27	Standard drive, low frequency I/O only
9	P0.28	I/O	GPIO/AIN4	P0.28	Pin is analog capable, standard drive, low frequency GPIO only
10	P0.29	I/O	GPIO/AIN5	P0.29	Pin is analog capable, standard drive, low frequency GPIO only
11	P0.30	I/O	GPIO/AIN6	P0.30	Pin is analog capable
12	P0.31	I/O	GPIO/AIN7	P0.31	Pin is analog capable
13	P0.00	I/O	GPIO/XTAL1 (32.768 kHz)	P0.00	
14	P0.01	I/O	GPIO/XTAL2 (32.768 kHz)	P0.01	
15	P0.02	I/O	GPIO/AIN0	P0.02	Pin is analog capable
16	GND	Power	Electrical Ground		
17	VCC	Power	1.7 V to 3.6 V	VDD	An internal 4.7 μ F bulk capacitor is included on the module. However, it is good design practice to add additional bulk capacitance as required for your application, i.e. those with heavy GPIO usage and/or current draw.
18	GND	Power	Electrical Ground		

No.	Name	I/O	Description	nRF52 pin	Remarks
19	P0.03	I/O	GPIO/AIN1	P0.03	Pin is analog capable
20	P0.04	I/O	GPIO/AIN2	P0.04	Pin is analog capable
21	P0.05	I/O	GPIO/AIN3	P0.05	Pin is analog capable
22	P0.06	I/O	GPIO	P0.06	
23	P0.07	I/O	GPIO	P0.07	
24	P0.08	I/O	GPIO	P0.08	
25	P0.09	I/O	GPIO	P0.09	
26	P0.10	I/O	GPIO	P0.10	
27	P0.11	I/O	GPIO	P0.11	
28	P0.12	I/O	GPIO	P0.12	
29	GND	Power	Electrical Ground		
30	GND	Power	Electrical Ground		
31	P0.13	I/O	GPIO	P0.13	
32	P0.14	I/O	GPIO	P0.14	
33	P0.15	I/O	GPIO	P0.15	
34	P0.16	I/O	GPIO	P0.16	
35	P0.17	I/O	GPIO	P0.17	
36	P0.18	I/O	GPIO	P0.18	
37	P0.19	I/O	GPIO	P0.19	
38	P0.20	I/O	GPIO	P0.20	
39	P0.21	I/O	GPIO/RESET_N	P0.21	
40	P0.22	I/O	GPIO	P0.22	
41	P0.23	I/O	GPIO	P0.23	
42	P0.24	I/O	GPIO	P0.24	
43	SWCLK	I	SWD Clock	SWDCLK	
44	SWDIO	I/O	SWD IO	SWDIO	
45	GND	Power	Electrical Ground		
46	GND	Power	Electrical Ground		
47	GND	Power	Electrical Ground		

Table 1: BMD-360 pin-out

2.2 Peripheral pin assignments

The peripherals within the BMD-360 may be assigned to nearly any of the GPIO pins through the application. There are some restrictions called out by the nRF52811 product specification. See the Remarks in Table 1. Also note that certain peripherals are assigned to particular pins, such the analog inputs.

3 Electrical specifications

Stressing the device above one or more of the ratings listed in the Absolute maximum rating section may cause permanent damage. These are stress ratings only. Operating the module at these or at any conditions other than those specified in the Operating conditions section of this document should be avoided. Exposure to absolute maximum rating conditions for extended periods may affect device reliability.

Operating condition ranges define those limits within which the functionality of the device is guaranteed. Where application information is given, it is advisory only and does not form part of the specification.

3.1 Absolute maximum ratings

Symbol	Description	Min	Max	Unit
V_{CC_MAX}	Voltage on supply pin	-0.3	3.9	V
V_{IO_MAX}	Voltage on GPIO pins ($V_{CC} > 3.6V$)	-0.3	3.9	V
V_{IO_MAX}	Voltage on GPIO pins ($V_{CC} \leq 3.6V$)	-0.3	$V_{CC} + 0.3 V$	V
T_s	Storage Temperature Range	-40	125	°C

Table 2: Absolute maximum ratings

The product is not protected against overvoltage or reversed voltages. If necessary, voltage spikes exceeding the power supply voltage specification, given in table above, must be limited to values within the specified boundaries by using appropriate protection devices.

3.2 Operating conditions

Unless otherwise specified, all operating condition specifications are at an ambient temperature of 25 °C and a supply voltage of 3.3 V.

Operation beyond the specified operating conditions is not recommended and extended exposure beyond them may affect device reliability.

Symbol	Parameter	Min	Typ.	Max	Unit
V_{CC}	Operating supply voltage	1.7	3.0	3.6	V
T_{R_VCC}	Supply rise time (0 V to 1.7 V)	-	-	60	ms
T_A	Operating Ambient Temperature Range	-40	25	85	°C

Table 3: Operating conditions

3.3 General purpose I/O

The general purpose I/O is organized as one port enabling access and control of the 32 available GPIO pins through one port. Each GPIO can be accessed individually with the following user configurable features:

- Input/output direction
- Output drive strength
- Internal pull-up and pull-down resistors
- Wake-up from high- or low-level triggers on all pins
- Trigger interrupt on all pins

- All pins can be used by the PPI task/event system; the maximum number of pins that can be interfaced through the PPI at the same time is limited by the number of GPIOTE channels
- All pins can be individually configured to carry serial interface or quadrature demodulator signals

Symbol	Parameter	Min.	Typ.	Max.	Unit
V_{IH}	Input High Voltage	$0.7 \times VCC$	-	VCC	V
V_{IL}	Input Low Voltage	GND	-	$0.3 \times VCC$	V
V_{OH}	Output High Voltage	$VCC - 0.4$	-	VCC	V
V_{OL}	Output Low Voltage	GND	-	$GND + 0.4$	V
R_{PU}	Pull-up Resistance	11	13	16	k Ω
R_{PD}	Pull-down Resistance	11	13	16	k Ω

Table 4: GPIO

3.4 Module reset

GPIO pin P0.21 may be used for a hardware reset. In order to utilize P0.21 as a hardware reset, the UICR registers PSELRESET[0] and PSELRESET[1] must be set alike, to the value of 0x7FFFFFFF15. When P0.21 is programmed as RESET, the internal pull-up is automatically enabled. Nordic Semiconductor example applications and development kits program P0.21 as RESET.

3.5 Debug and programming



The BMD-360 series supports the two pin Serial Wire Debug (SWD) interface and offers flexible and powerful mechanism for non-intrusive debugging of program code. Breakpoints, single stepping, and instruction trace capture of code execution flow are part of this support.

The BMD-360 also supports ETM and ITM trace. The trace data from the ETM and the ITM is sent to an external debugger via a 4-bit wide parallel trace port. In addition to parallel trace, the TPIU supports serial trace via the Serial Wire Output (SWO) trace protocol.

3.6 Clocks

The BMD-360 requires two clocks, a high frequency clock and a low frequency clock. The high frequency clock is provided on-module by a high-accuracy 32 MHz crystal as required by the nRF52811 for radio operation.

The low frequency clock can be provided internally by an RC oscillator or synthesized from the fast clock, or externally by a 32.768 kHz crystal. An external crystal provides the lowest power consumption and greatest accuracy. Using the internal RC oscillator with calibration provides acceptable performance for Bluetooth low energy applications at a reduced cost and slight increase in power consumption.

-  The ANT protocol requires the use of an external crystal.
-  $f_{TOL_LFXO_BLE}$ and $f_{TOL_LFXO_ANT}$ are the maximum allowed for Bluetooth low energy and ANT applications. Actual tolerance depends on the crystal used.

3.6.1 32.768 kHz crystal (LFXO) (preliminary)

Symbol	Parameter	Typ.	Max.	Unit
F_{NOM_LFXO}	Crystal frequency	32.768	-	kHz
$F_{TOL_LFXO_BLE}$	Frequency tolerance, Bluetooth low energy applications	-	±500	ppm
$f_{TOL_LFXO_ANT}$	Frequency Tolerance, ANT applications	-	±50	ppm
C_{L_LFXO}	Load Capacitance	-	12.5	pF
C_{O_LFXO}	Shunt Capacitance	-	2	pF
R_{S_LFXO}	Equivalent series resistance	-	100	kΩ
C_{pin}	Input Capacitance on XL1 & XL2 pads	4	-	pF

Table 5: 32.768 kHz Crystal (LFXO)

3.6.2 32.768 kHz clock source comparison

Symbol	Parameter	Min.	Typ.	Max.	Unit
$f_{TOL_LFXO_BLE}$	Frequency Tolerance, 32.768 kHz Crystal Oscillator (Bluetooth low energy Stack)	-	-	±250	ppm
$f_{TOL_LFXO_ANT}$	Frequency Tolerance, 32.768 kHz Crystal Oscillator (ANT Stack)	-	-	±50	ppm
f_{TOL_LFRC}	Frequency Tolerance, 32.768 kHz RC Oscillator	-	-	±2	%
$f_{TOL_CAL_LFRC}$	Frequency tolerance, 32.768 kHz RC after calibration	-	-	±500	ppm
f_{TOL_LFSYNT}	Frequency Tolerance, 32.768 kHz Synthesized Oscillator	-	-	±8	ppm

Table 6 – 32.768 kHz Clock source comparison

4 Firmware

u-blox recommends that projects for the BMD-360 utilize [Nordic Semiconductor's SDK, DFU, and examples](#) and the nRF52811 tools for any new development. This will allow access to the very latest Bluetooth support from Nordic Semiconductor and provide an ongoing path as new features are released.

4.1 Factory image

The BMD-360 module is not loaded with a factory firmware image.

4.2 SoftDevices

Nordic Semiconductor protocol stacks are known as SoftDevices. SoftDevices are pre-compiled, pre-linked binary files. SoftDevices can be programmed in nRF52 series SoCs and are downloadable from the Nordic Semiconductor website. The BMD-360 with the nRF52811 SoC supports the S113 (Bluetooth low energy Peripheral) SoftDevices.

4.2.1 S113

The S113 SoftDevice is a Bluetooth low energy peripheral protocol stack solution. It supports up to four peripheral connections with an additional broadcaster role running concurrently. The S113 SoftDevice integrates a Bluetooth low energy Controller and Host and provides a full and flexible API for building Bluetooth low energy nRF52 System on Chip (SoC) solutions.

4.2.2 IEEE 802.15.4 (Thread and Zigbee)

IEEE 802.15.4 based protocols, such as Thread and Zigbee, on the BMD-360 are not implemented using a SoftDevice. Nordic Semiconductor provides an IEEE 802.15.4 compliant MAC stack which does not require a SoftDevice to be loaded to operate. Nordic Semiconductor also provides pre-compiled Thread and Zigbee stacks. See the [Nordic Semiconductor SDK](#) for more information on developing applications that utilize IEEE 802.15.4. Both allow for concurrent operation with Bluetooth low energy SoftDevices.

4.3 Bluetooth address

The BMD-360 modules are preprogrammed from the factory with a unique public Bluetooth address stored in the UICR. The Bluetooth address is the Organizationally Unique Identifier (94:54:93) combined with the six characters that are printed on a 2D barcode and in human-readable text on the module label, as described in section 5.3.

UICR Register	Address	Description
NRF_UICR + 0x80	0x10001080	Bluetooth_addr [0] (0xCC)
NRF_UICR + 0x81	0x10001081	Bluetooth_addr [1] (0xBB)
NRF_UICR + 0x82	0x10001082	Bluetooth_addr [2] (0xAA)
NRF_UICR + 0x83	0x10001083	Bluetooth_addr [3] (0xEB)
NRF_UICR + 0x84	0x10001084	Bluetooth_addr [4] (0x1D)
NRF_UICR + 0x85	0x10001085	Bluetooth_addr [5] (0x6C)

Table 7: Bluetooth address

5 Mechanical specifications

5.1 Dimensions

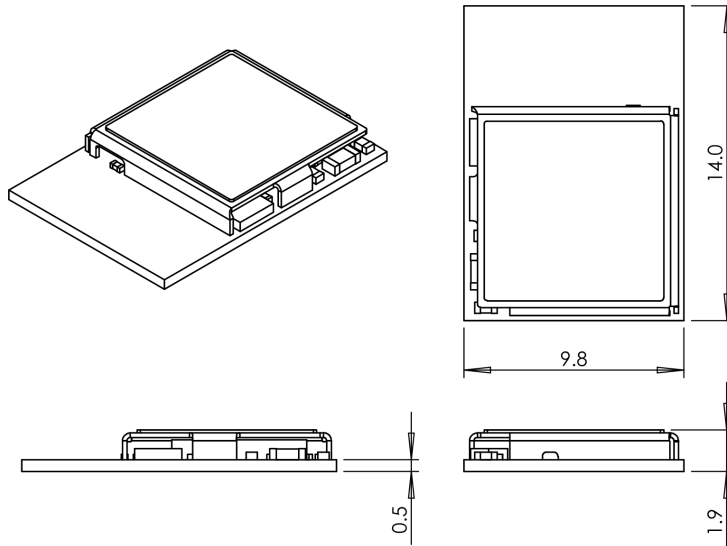

Figure 3: BMD-360 mechanical drawing

5.2 Recommended PCB land pads

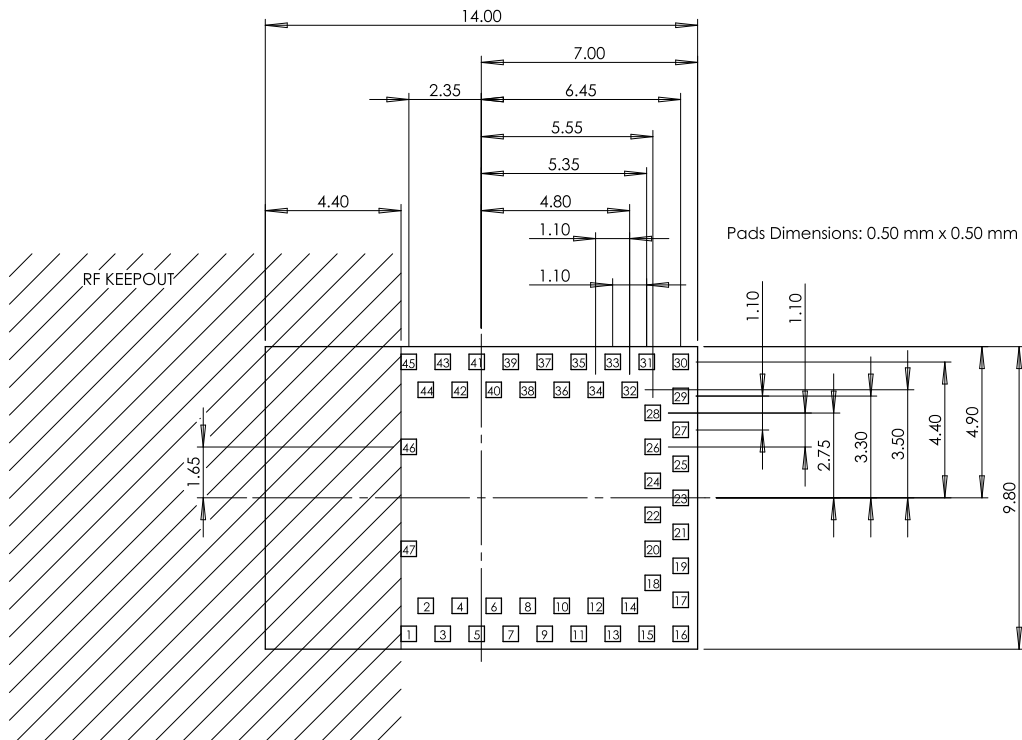

Figure 4: Recommended PCB land pads

The RF Keep-out area extends vertically to the board edge.

5.3 Module marking

The labels of the BMD-360 modules include important product information as described in this section.

Figure 5 illustrates the label of the BMD-360 modules, which includes the u-blox logo, product version, product name, Bluetooth address, and certification numbers.

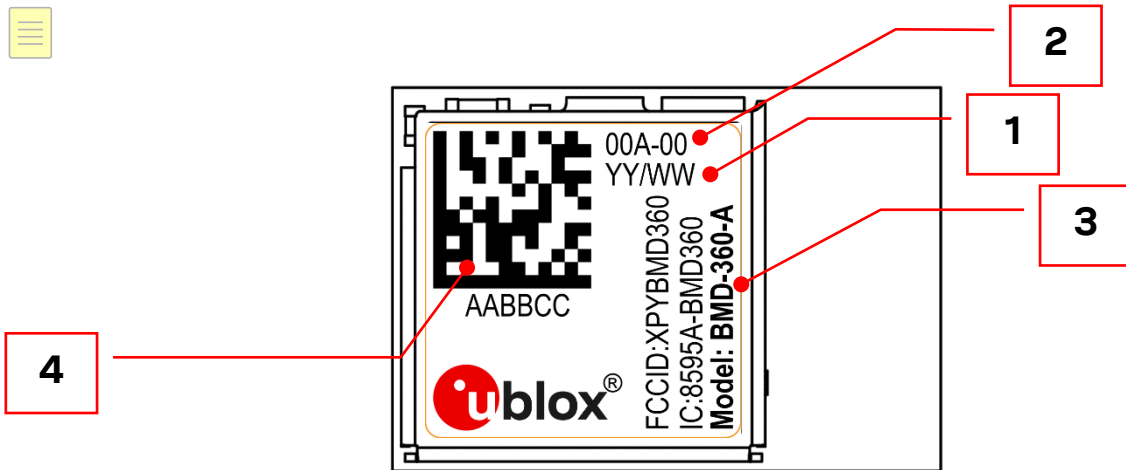

Figure 5: Module marking

Reference	Description
1	Date of unit production (year/week)
2	Product version
3	Product name
4	Data Matrix (QR code) with unique serial number of six alphanumeric symbols, also in human-readable form. The full Bluetooth address consists of the IEEE OUI (94:54:93) with the six symbols appended: 94:54:93:AA:BB:CC

Table 8: BMD-360 label description

6 RF design notes

6.1 Recommended RF layout and ground plane

For the BMD-360, the integrated antenna requires a suitable ground plane to radiate effectively.

The area under and extending out from the antenna portion of the module should be kept clear of copper and other metal. The module should be placed at the edge of the PCB with the antenna edge facing out. Reducing the ground plane from that shown in Figure 6 will reduce the effective radiated power. For example, a 27 mm x 29 mm board (about the size of a coin cell) has approximately 3dB lower output than the BMD-360 Evaluation Board.

These RF guidelines for the BMD-360 are the same as the BMD-300 module. Designs incorporating the BMD-300 will have similar RF performance with the BMD-360 module.

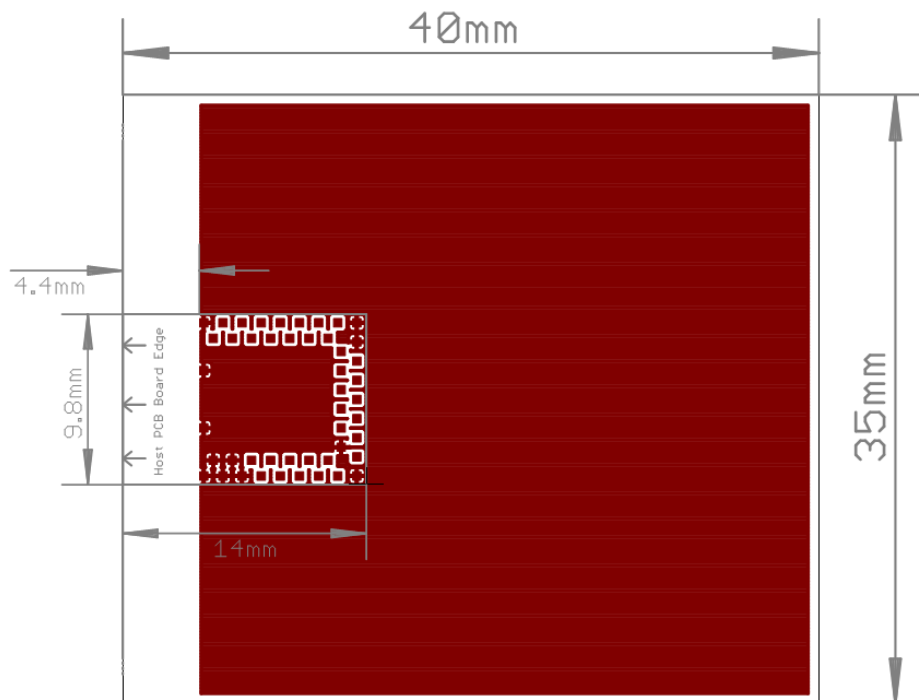

Figure 6: Recommended RF layout and ground plane for BMD-360

6.2 Mechanical enclosure

Care should be taken when designing and placing the BMD-360 module into an enclosure. Metal should be kept clear from the antenna area, both above and below. Any metal around the module can negatively impact RF performance.

The module is designed and tuned for the antenna and RF components to be in free air. Any potting, epoxy fill, plastic over-molding, or conformal coating can negatively impact RF performance and must be evaluated by the customer.

7 Antenna patterns

Antenna patterns are based on the BMD-300 Evaluation Kit with a ground plane size of 82 mm x 56 mm. The BMD-300 module was replaced with a BMD-360 module. The X-Y-Z orientation is shown in Figure 7:

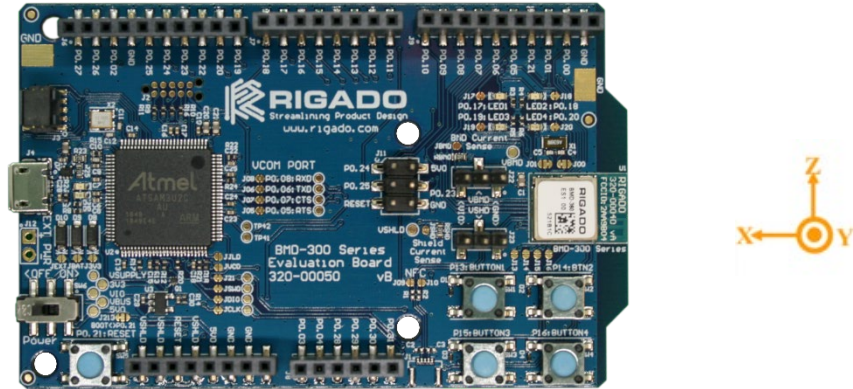

Figure 7: BMD-360 Evaluation kit X-Y-Z orientation

7.1 X-Y plane

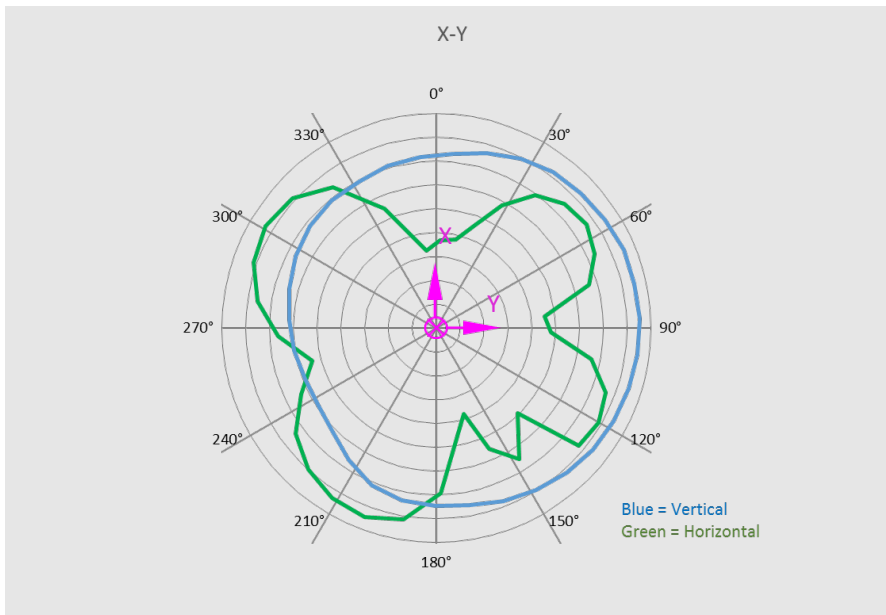

Figure 8: X-Y Plane Antenna Pattern

The outer-most ring is +5 dB. Each division is -5 dB

7.2 Y-Z plane

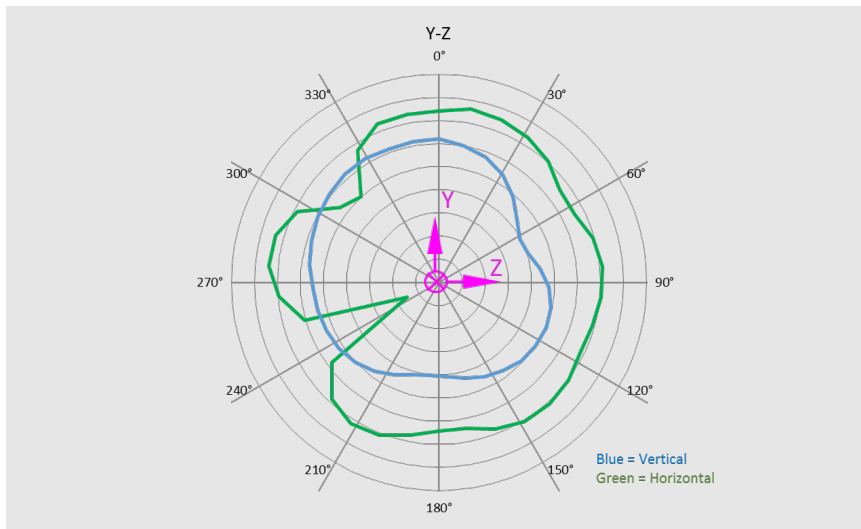

Figure 9: Y-Z Plane Antenna Pattern

The outer-most ring is +5 dB. Each division is -5 dB.

7.3 Z-X plane

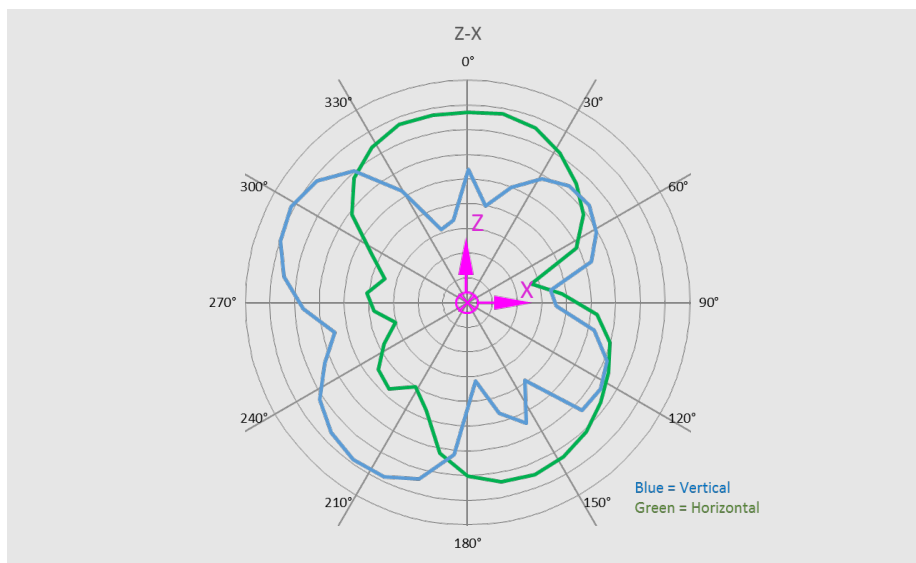

Figure 10: Z-X Plane Antenna Pattern

The outer-most ring is +5 dB. Each division is -5 dB.

8 BMD-360 evaluation development kit

The BMD-360-EVAL is a full featured evaluation board that provides a complete I/O pin out to headers, on-board programming and debugging, 32.768 kHz crystal, power & virtual COM port over USB, four user LEDs, and four user buttons. The evaluation boards also provide the option to be powered from a CR2032 coin cell battery and have current sense resistors and headers to allow for convenient current measurements. An Arduino Uno R3 style header is provided for easy prototyping of additional functions. The evaluation boards also support programming off-board BMD-300 Series modules.

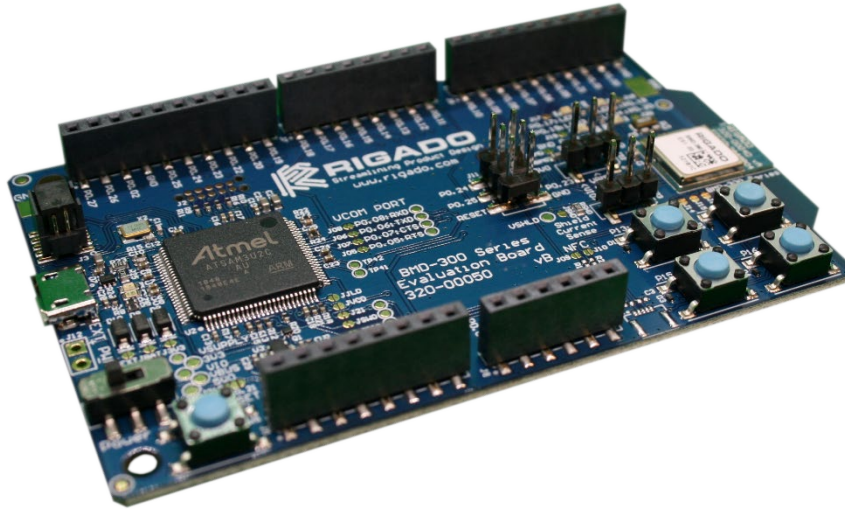



Figure 11: BMD-360 evaluation board

9 Qualification and approvals

9.1 United States (FCC) (pending approval)

The BMD-360 module has received Federal Communications Commission (FCC) CFR47 Telecommunications, Part 15 Subpart C “Intentional Radiators” modular approval in accordance with Parts 15.212 and 15.247. The modular approval allows the end user to integrate the module into a finished product without obtaining subsequent and separate FCC approvals for intentional radiation, provided no changes or modifications are made to the module circuitry. Changes or modifications could void the user’s authority to operate the equipment. The end user must comply with all of the instructions provided by the Grantee, which indicate installation and/or operating conditions necessary for compliance.

The finished product is required to comply with all applicable FCC equipment authorizations regulations, requirements and equipment functions not associated with the transmitter module portion. For example, compliance must be demonstrated to regulations for other transmitter components within the host product; to requirements for unintentional radiators (Part 15 Subpart B “Unintentional Radiators”), such as digital devices, computer peripherals, radio receivers, etc.; and to additional authorization requirements for the non-transmitter functions on the transmitter module (that is, Verification, or Declaration of Conformity) (for example, transmitter modules may also contain digital logic functions) as appropriate.

-  Modification to this product will void the users’ authority to operate this equipment.
-  The OEM is still responsible for verifying end product compliance with FCC Part 15, subpart B limits for unintentional radiators through an accredited test facility.
KDB 996369 D03 sections 2.4 (limited module procedures) and 2.5 (trace antenna designs) are not applicable to the BMD-360.

9.1.1 Labeling and user information requirements

The BMD-360 is assigned the FCC ID number: XPYBMD360

If the FCC ID is not visible when the module is installed inside another device, then the outside of the finished product into which the module is installed must also display a label referring to the enclosed module. This exterior label can use the following or similar wording:

Contains FCC ID: XPYBMD360

In addition to marking the product with the appropriate FCC ID, the end product shall bear the following statement in a conspicuous location on the device ([FCC Rules, Title 47, Subchapter A, Part 15, Subpart B, Chapter §15.19](#)):

This device complies with part 15 of the FCC Rules. Operation is subject to the following two conditions: (1) This device may not cause harmful interference, and (2) this device must accept any interference received, including interference that may cause undesired operation.

When the device is so small or for such use that it is impracticable to label it with the statement specified above in a font that is four-point or larger, and the device does not have a display that can show electronic labeling, then the information required by this paragraph shall be placed in the user manual and must also either be placed on the device packaging or on a removable label attached to the device.

The user manual may also require specific information based on the digital device classification. Refer to the [FCC Rules, Title 47, Subchapter A, Part 15, Subpart B, Chapter §15.105](#) for specific wording of these notices.

9.1.2 RF exposure

All transmitters regulated by FCC must comply with RF exposure requirements. [KDB 447498 General RF Exposure Guidance](#) provides guidance in determining whether proposed or existing transmitting facilities, operations or devices comply with limits for human exposure to Radio Frequency (RF) fields adopted by the Federal Communications Commission (FCC).

This module is approved for installation into mobile and/or portable host platforms and must not be co-located or operating in conjunction with any other antenna or transmitter except in accordance with FCC multi-transmitter guidelines. End users must be provided with transmitter operating conditions for satisfying RF Exposure compliance.

9.2 Canada (ISED) (pending approval)

The BMD-360 module is certified for use in Canada under Innovation, Science and Economic Development Canada (ISED) Radio Standards Specification (RSS) RSS-247 Issue 2 and RSSGen.

9.2.1 Labeling and user information requirements

The BMD-360 is assigned the IC ID number: 8595A-BMD360

Labeling Requirements for the Host Device (from Section 3.2.1, RSS-Gen, Issue 3, December 2010): The host device shall be properly labeled to identify the module within the host device. The Industry Canada certification label of a module shall be clearly visible at all times when installed in the host device, otherwise the host device must be labeled to display the Industry Canada certification number of the module, preceded by the words “Contains transmitter module”, or the word “Contains”, or similar wording expressing the same meaning, as follows:

Contains transmitter module IC: 8595A-BMD360

User Manual Notice for License-Exempt Radio Apparatus (from Section 7.1.3 RSS-Gen, Issue 3, December 2010): User manuals for license-exempt radio apparatus shall contain the following or equivalent notice in a conspicuous location in the user manual or alternatively on the device or both:

This device contains licence-exempt transmitter(s)/receiver(s) that comply with Innovation, Science and Economic Development Canada's licence-exempt RSS(s). Operation is subject to the following two conditions:

1. This device may not cause interference.
2. This device must accept any interference, including interference that may cause undesired operation of the device.

L'émetteur/récepteur exempt de licence contenu dans le présent appareil est conforme aux CNR d'Innovation, Sciences et Développement économique Canada applicables aux appareils radio exempts de licence.

L'exploitation est autorisée aux deux conditions suivantes :

1. L'appareil ne doit pas produire de brouillage;
2. L'appareil doit accepter tout brouillage radioélectrique subi, même si le brouillage est susceptible d'en compromettre le fonctionnement.

Transmitter Antenna (from Section 7.1.2 RSS-Gen, Issue 3, December 2010): User manuals for transmitters shall display the following notice in a conspicuous location:

Under Industry Canada regulations, this radio transmitter may only operate using an antenna of a type and maximum (or lesser) gain approved for the transmitter by Industry Canada. To reduce potential radio interference to other users, the antenna type and its gain should be so chosen that the equivalent isotropically radiated power (e.i.r.p.) is not more than that necessary for successful communication.

Conformément à la réglementation d'Industrie Canada, le présent émetteur radio peut fonctionner avec une antenne d'un type et d'un gain maximal (ou inférieur) approuvé pour l'émetteur par Industrie Canada. Dans le but de réduire les risques de brouillage radioélectrique à l'intention des autres utilisateurs, il faut choisir le type d'antenne et son gain de sorte que la

puissance isotrope rayonnée équivalente (p.i.r.e.) ne dépasse pas l'intensité nécessaire à l'établissement d'une communication satisfaisante.

9.2.2 RF exposure

All transmitters regulated by IC must comply with RF exposure requirements listed in RSS-102 - Radio Frequency (RF) Exposure Compliance of Radio communication Apparatus (All Frequency Bands). This module is approved for installation into mobile and/or portable host platforms and must not be co-located or operating in conjunction with any other antenna or transmitter except in accordance with Industry Canada's multi-transmitter guidelines. End users must be provided with transmitter operating conditions for satisfying RF Exposure compliance.

9.3 Europe (CE-RED) (pending approval)

The BMD-360 is a Radio Equipment Directive assessed radio module that is CE compliant and have been manufactured and tested with the intention of being integrated into a final product.

The BMD-360 has been tested to current Radio Equipment Directives

- EN 60950-1: 2006 + A11: 2009 + A1: 2010 + A12: 2011 + A2: 2013
- ETSI EN 300 328 V 2.1.1
- ETSI EN 301 489-1 V2.1.1
- ETSI EN 301 489-17 V3.1.1

The Radio Equipment Directive – Compliance Association (RED-CA) provides guidance on modular devices at the RED-CA website: <http://www.redca.eu/Pages/Documents%201.htm>.

9.3.1 Labeling and user information requirements

The label on the final products which contain a BMD-360 module must follow CE marking requirements. The “R&TTE Compliance Association Technical Guidance Note 01” provides guidance on final product CE marking.

9.4 Australia / New Zealand (RCM) (pending approval)

The BMD-360 has been tested to comply with the AS/NZS 4268:2017, Radio equipment and systems – Short range devices – Limits and methods of measurement. The report may be obtained from your local FAE, and may be used as evidence in obtaining permission to use the Regulatory Compliance Mark (RCM).

Information on registration as a Responsible Party, license and labeling requirements may be found at the following websites:

Australia: <http://www.acma.gov.au/theACMA/radiocommunications-short-range-devices-standard-2004>

New Zealand: <http://www.rsm.govt.nz/compliance>

Only Australian-based and New Zealand-based companies who are registered may be granted permission to use the RCM. An Australian-based or New Zealand-based agent or importer may also register as a Responsible Party to use the RCM on behalf of a company not in Australia or New Zealand.

9.5 Bluetooth qualification (pending)

The Bluetooth SIG maintains the Bluetooth Specification, and ensures that products are properly tested and comply with the Bluetooth license agreements. Companies that list products with the Bluetooth SIG are required to be members of the SIG and submit the listed fees. Refer to this link for details: <https://www.bluetooth.com/develop-with-bluetooth/qualification-listing>

The BMD-360 Bluetooth Low Energy module based on the Nordic Semiconductor nRF52811 is listed as a “Tested Component”, with Qualified Design IDs (QDID) (Pending). This allows an end-product based on a BMD-360 module to inherit the component listings without the need to run through all of the tests again. The end-product will often inherit several QDIDs, and are identified on a “Declaration of Compliance”.

The BMD-360 primarily utilizes the 113 SoftDevice

10 Environmental

10.1 RoHS

The BMD-360 module is in compliance with Directive 2011/65/EU, 2015/863/EU of the European Parliament and the Council on the restriction of the use of certain hazardous substances in electrical and electronic equipment.

10.2 REACH

Rigado's modules listed below do not contain the [201 SVHC \(Substance of Very High Concern\)](#), as defined by Directive EC/1907/2006 Article according to REACH Annex XVII.

10.3 California proposition 65 (P65)

This product can expose you to Nickel (metallic), which is known to the State of California to cause cancer. For more information go to www.P65Warnings.ca.gov. Warnings are not required where the listed chemical is inaccessible to the average user of the end product.

11 Product handling

11.1 Packaging

11.2 Reel packaging

Modules are packaged on 330 mm reels loaded with 1000 modules. Each reel is placed in an antistatic bag with a desiccant pack and humidity card and placed in a 340 x 350 x 65 mm box. An antistatic warning and reel label are adhered to the outside of the bag.

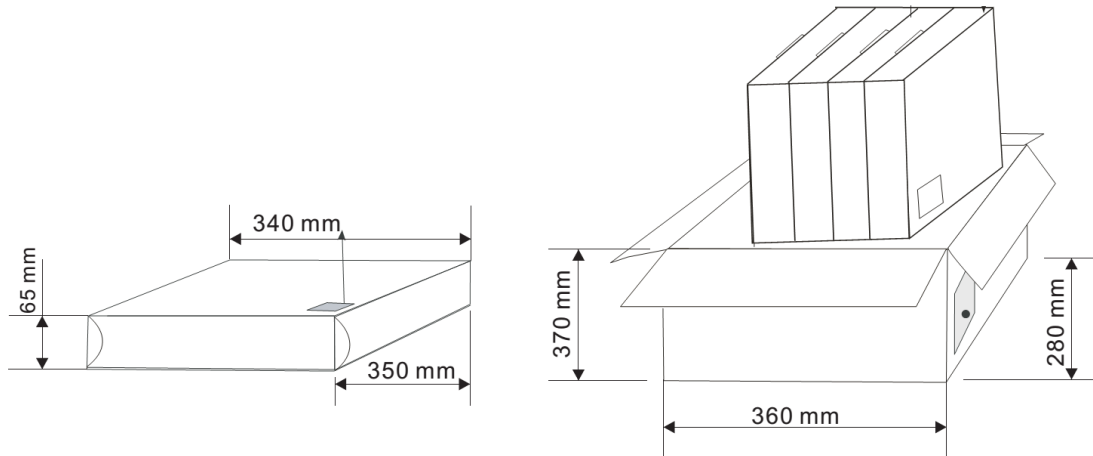
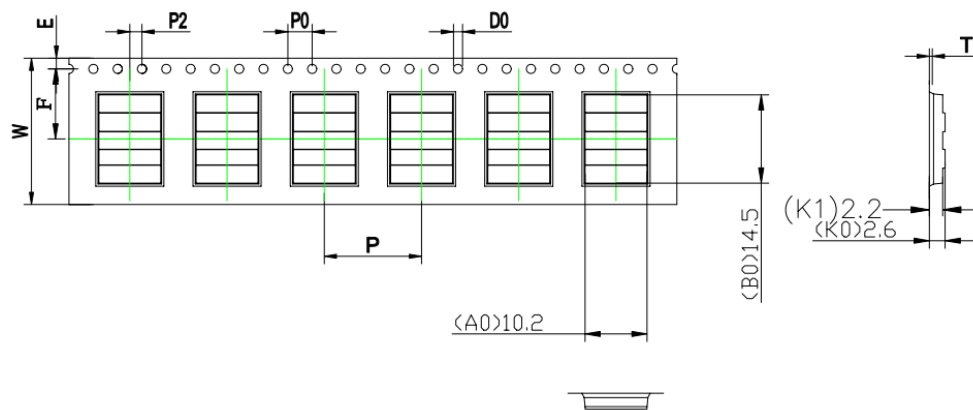

Figure 12 – Reel cartons

11.3 Carrier tape dimensions



ITEM	W	A ₀	B ₀	K ₀	K ₁	P	F	E	D ₀	D ₁	P ₀	P ₂	T
DIM	24.0 ^{+0.30} _{-0.30}	10.2 ^{+0.10} _{-0.10}	14.5 ^{+0.10} _{-0.10}	2.6 ^{+0.10} _{-0.10}	2.2 ^{+0.00} _{-0.00}	16.0 ^{+0.10} _{-0.10}	11.5 ^{+0.10} _{-0.10}	1.75 ^{+0.10} _{-0.10}	1.50 ^{+0.10} _{-0.00}	0.00 ^{+0.10} _{-0.00}	4.00 ^{+0.10} _{-0.10}	2.00 ^{+0.10} _{-0.10}	0.30 ^{+0.05} _{-0.05}
ALTERNATE													

Figure 13 – Carrier tape dimensions

11.4 Moisture sensitivity level

The BMD-360 is rated for MSL 3, 168-hour floor life after opening.

11.5 Reflow soldering

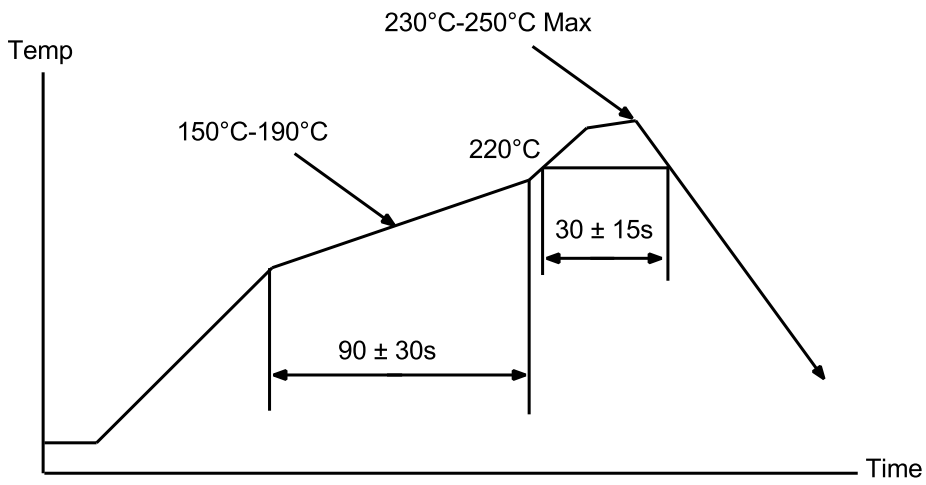

Figure 14: Reflow profile for lead free solder

12 Labeling and ordering information

12.1 Batch Label

Figure 15 shows an example of the layout and contents of the batch label. The label is affixed to reels, sealed bags, and individual packing cartons (inner cartons).



Figure 15: Batch label example

12.2 Multipack label

Figure 16 shows an example of the layout and contents of the multipack label. The label is affixed to shipping parcels (outer cartons).



Figure 16: Multipack label example

12.3 Ordering information

Ordering Code	Product
BMD-360-A-R	BMD-360 module, Rev A, Tape & Reel, 1000 piece multiples
BMD-360-Evaluation kit	BMD-360 Evaluation Kit w/ SEGGER J-Link-OB debug probe

Table 9: Product ordering codes

13 Life support and other high-risk use warning

This product is not designed nor intended for use in a life support device or system, nor for use in other fault-intolerant, hazardous or other environments requiring fail-safe performance, such as any application in which the failure or malfunction of the product could lead directly or indirectly to death, bodily injury, or physical or property damage (collectively, “High-Risk Environments”).

 u-blox expressly disclaims any express or implied warranty of fitness for use in high-risk environments.

The customer using this product in a High-Risk Environment agrees to indemnify and defend u-blox from and against any claims and damages arising out of such use.

Related documents

- [1] Nordic Semiconductor, [nRF52811 Product Specification](#)
- [2] Nordic Semiconductor, [nRF5 Software Development Kit](#)

 For regular updates to u-blox documentation and to receive product change notifications, register on our homepage (www.u-blox.com).

Revision history

Revision	Date	Name	Comments
0.5	15-Apr-2019		Preliminary release for engineering.
0.6	01-Jul-2019		Corrected typos. Updated Nordic Semiconductor documentation link. Updated images.
R03	21-Oct-2019		Document converted from Rigado BMD-360 data sheet to u-blox BMD-360 data sheet.

Contact

For complete contact information, visit us at www.u-blox.com.

u-blox Offices

North, Central and South America

u-blox America, Inc.

Phone: +1 703 483 3180
E-mail: info_us@u-blox.com

Regional Office West Coast:

Phone: +1 408 573 3640
E-mail: info_us@u-blox.com

Technical Support:

Phone: +1 703 483 3185
E-mail: support@u-blox.com

Headquarters

Europe, Middle East, Africa

u-blox AG

Phone: +41 44 722 74 44
E-mail: info@u-blox.com
Support: support@u-blox.com

Asia, Australia, Pacific

u-blox Singapore Pte. Ltd.

Phone: +65 6734 3811
E-mail: info_ap@u-blox.com
Support: support_ap@u-blox.com

Regional Office Australia:

Phone: +61 2 8448 2016
E-mail: info_anz@u-blox.com
Support: support_ap@u-blox.com

Regional Office China (Beijing):

Phone: +86 10 68 133 545
E-mail: info_cn@u-blox.com
Support: support_cn@u-blox.com

Regional Office China (Chongqing):

Phone: +86 23 6815 1588
E-mail: info_cn@u-blox.com
Support: support_cn@u-blox.com

Regional Office China (Shanghai):

Phone: +86 21 6090 4832
E-mail: info_cn@u-blox.com
Support: support_cn@u-blox.com

Regional Office China (Shenzhen):

Phone: +86 755 8627 1083
E-mail: info_cn@u-blox.com
Support: support_cn@u-blox.com

Regional Office India:

Phone: +91 80 405 092 00
E-mail: info_in@u-blox.com
Support: support_in@u-blox.com

Regional Office Japan (Osaka):

Phone: +81 6 6941 3660
E-mail: info_jp@u-blox.com
Support: support_jp@u-blox.com

Regional Office Japan (Tokyo):

Phone: +81 3 5775 3850
E-mail: info_jp@u-blox.com
Support: support_jp@u-blox.com

Regional Office Korea:

Phone: +82 2 542 0861
E-mail: info_kr@u-blox.com
Support: support_kr@u-blox.com

Regional Office Taiwan:

Phone: +886 2 2657 1090
E-mail: info_tw@u-blox.com
Support: support_tw@u-blox.com