FCC Test Report

Report No.: AGC00174190603FE04

FCC ID : XPYBMD341
APPLICATION PURPOSE : Original Equipment
PRODUCT DESIGNATION : BMD-341
BRAND NAME : u-blox
MODEL NAME : BMD-341
APPLICANT : u-blox AG
DATE OF ISSUE : Aug. 22, 2019
STANDARD(S) : FCC Part 15.247
REPORT VERSION : V1.0

Attestation of Global Compliance (Shenzhen) Co., Ltd

CAUTION:

This report shall not be reproduced except in full without the written permission of the test laboratory and shall not be quoted out of context.



REPORT REVISE RECORD

Report Version	Revise Time	Issued Date	Valid Version	Notes
V1.0	/	Aug. 22, 2019	Valid	Initial Release



TABLE OF CONTENTS

1. VERIFICATION OF COMPLIANCE 5

2. GENERAL INFORMATION 6

 2.1 PRODUCT DESCRIPTION 6

 2.2. TABLE OF CARRIER FREQUENCIES 6

 2.3 RELATED SUBMITTAL(S)/GRANT(S) 7

 2.4 TEST METHODOLOGY 7

 2.5 SPECIAL ACCESSORIES 7

 2.6 EQUIPMENT MODIFICATIONS 7

3. MEASUREMENT UNCERTAINTY 8

4. DESCRIPTION OF TEST MODES 9

5. SYSTEM TEST CONFIGURATION 10

 5.1 CONFIGURATION OF TESTED SYSTEM 10

 5.2 EQUIPMENT USED IN TESTED SYSTEM 10

 5.3. SUMMARY OF TEST RESULTS 10

6. TEST FACILITY 11

7. PEAK OUTPUT POWER 12

 7.1. MEASUREMENT PROCEDURE 12

 7.2. TEST SET-UP (BLOCK DIAGRAM OF CONFIGURATION) 12

 7.3. LIMITS AND MEASUREMENT RESULT 13

8. 6 DB BANDWIDTH 15

 8.1. MEASUREMENT PROCEDURE 15

 8.2. TEST SET-UP (BLOCK DIAGRAM OF CONFIGURATION) 15

 8.3. LIMITS AND MEASUREMENT RESULTS 15

9. CONDUCTED SPURIOUS EMISSION 17

 9.1. MEASUREMENT PROCEDURE 17

 9.2. TEST SET-UP (BLOCK DIAGRAM OF CONFIGURATION) 17

 9.3. MEASUREMENT EQUIPMENT USED 17

 9.4. LIMITS AND MEASUREMENT RESULT 17

10. MAXIMUM CONDUCTED OUTPUT POWER SPECTRAL DENSITY 22

 10.1 MEASUREMENT PROCEDURE 22

10.2 TEST SET-UP (BLOCK DIAGRAM OF CONFIGURATION).....	22
10.3 MEASUREMENT EQUIPMENT USED	22
10.4 LIMITS AND MEASUREMENT RESULT	22
11. RADIATED EMISSION	24
11.1. MEASUREMENT PROCEDURE	24
11.2. TEST SETUP	25
11.3. LIMITS AND MEASUREMENT RESULT	26
11.4. TEST RESULT	26
12. FCC LINE CONDUCTED EMISSION TEST	36
12.1. LIMITS OF LINE CONDUCTED EMISSION TEST	36
12.2. BLOCK DIAGRAM OF LINE CONDUCTED EMISSION TEST	36
12.3. PRELIMINARY PROCEDURE OF LINE CONDUCTED EMISSION TEST	37
12.4. FINAL PROCEDURE OF LINE CONDUCTED EMISSION TEST	37
12.5. TEST RESULT OF LINE CONDUCTED EMISSION TEST	38
APPENDIX A: PHOTOGRAPHS OF TEST SETUP	40
APPENDIX B: PHOTOGRAPHS OF EUT	42

1. VERIFICATION OF COMPLIANCE

Applicant	u-blox AG
Address	Zürcherstrasse 68, Thalwil, Switzerland, Ch-8800
Manufacturer	u-blox AG
Address	Zürcherstrasse 68, Thalwil, Switzerland, Ch-8800
Factory	u-blox AG
Address	Zürcherstrasse 68, Thalwil, Switzerland, Ch-8800
Product Designation	BMD-341
Brand Name	u-blox
Test Model	BMD-341
Date of test	Jul. 19, 2019 to Aug. 22, 2019
Deviation	None
Condition of Test Sample	Normal
Test Result	Pass
Report Template	AGCRT-US-BLE/RF

We hereby certify that:

The above equipment was tested by Attestation of Global Compliance (Shenzhen) Co., Ltd. The test data, data evaluation, test procedures, and equipment configurations shown in this report were made in accordance with the procedures given in ANSI C63.10 (2013) and the energy emitted by the sample EUT tested as described in this report is in compliance with radiated emission limits of FCC part 15.247.

Prepared By

Draven Li

Draven Li
(Project Engineer) Aug. 22, 2019

Reviewed By

Max Zhang

Max Zhang
(Reviewer) Aug. 22, 2019

Approved By

Forrest Lei

Forrest Lei
(Authorized Officer) Aug. 22, 2019



2.GENERAL INFORMATION

2.1PRODUCT DESCRIPTION

The EUT is designed as a “BMD-341”. It is designed by way of utilizing the GFSK technology to achieve the system operation.

A major technical description of EUT is described as following

Operation Frequency	2.402 GHz to 2.480GHz
RF Output Power	6.743dBm(Max)
Modulation	O-QPSK
Number of channels	40 Channel
Antenna Designation	External Antenna (Comply with requirements of the FCC part 15.203)
Antenna Gain	External Antenna 1: 3.2dBi External Antenna 2: 2.0dBi External Antenna 3: 2.5dBi External Antenna 4: 2.0dBi
Hardware Version	A
Software Version	00_v1.0
Power Supply	DC 3.3V

2.2. TABLE OF CARRIER FREQUENCIES

Frequency Band	Channel Number	Frequency
2400~2483.5MHZ	0	2402MHZ
	1	2404MHZ
	:	:
	38	2478 MHZ
	39	2480 MHZ



2.3 RELATED SUBMITTAL(S)/GRANT(S)

This submittal(s) (test report) is intended for **FCC ID: XPYBMD341** filing to comply with the FCC Part 15.247 requirements.

2.4 TEST METHODOLOGY

Both conducted and radiated testing was performed according to the procedures in ANSI C63.10 (2013). Radiated testing was performed at an antenna to EUT distance 3 meters.

2.5 SPECIAL ACCESSORIES

Refer to section 2.2.

2.6 EQUIPMENT MODIFICATIONS

Not available for this EUT intended for grant.



3. MEASUREMENT UNCERTAINTY

The reported uncertainty of measurement $y \pm U$, where expanded uncertainty U is based on a standard uncertainty multiplied by a coverage factor of $k=2$, providing a level of confidence of approximately 95%.

- Uncertainty of Conducted Emission, $U_c = \pm 3.2$ dB
- Uncertainty of Radiated Emission below 1GHz, $U_c = \pm 3.9$ dB
- Uncertainty of Radiated Emission above 1GHz, $U_c = \pm 4.8$ dB
- Uncertainty of total RF power, conducted, $U_c = \pm 0.8$ dB
- Uncertainty of RF power density, conducted, $U_c = \pm 2.6$ dB
- Uncertainty of spurious emissions, conducted, $U_c = \pm 2.7$ dB
- Uncertainty of Occupied Channel Bandwidth: $U_c = \pm 2$ %



4. DESCRIPTION OF TEST MODES

NO.	TEST MODE DESCRIPTION
1	Low channel TX
2	Middle channel TX
3	High channel TX

Note:

1. Only the result of the worst case was recorded in the report, if no other cases.
2. For Radiated Emission, 3axis were chosen for testing for each applicable mode.
3. The Evaluation Kit is BMD-34X/380 which can set the EUT into the individual test modes.



5. SYSTEM TEST CONFIGURATION

5.1 CONFIGURATION OF TESTED SYSTEM

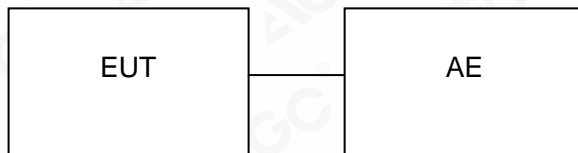

5.2 EQUIPMENT USED IN TESTED SYSTEM

Item	Equipment	Model No.	ID or Specification	Remark
1	BMD-341	BMD-341	XPYBMD341	EUT
2	PC	Xiaomi	Air 13.3	AE
3	Evaluation Kit	RIGADO	BMD-34X/380	AE
4	PC adapter	CDQ02ZM	N/A	AE

5.3. SUMMARY OF TEST RESULTS

FCC RULES	DESCRIPTION OF TEST	RESULT
15.247 (b)(3)	Peak Output Power	Compliant
15.247 (a)(2)	6 dB Bandwidth	Compliant
15.247 (d)	Conducted Spurious Emission	Compliant
15.247 (e)	Maximum Conducted Output Power Density	Compliant
15.209	Radiated Emission	Compliant
15.207	Conducted Emission	Compliant



6. TEST FACILITY

Test Site	Attestation of Global Compliance (Shenzhen) Co., Ltd
Location	1-2/F, Building 19, Junfeng Industrial Park, Chongqing Road, Heping Community, Fuhai Street, Bao'an District, Shenzhen, Guangdong, China
Designation Number	CN1259
FCC Test Firm Registration Number	975832
A2LA Cert. No.	5054.02
Description	Attestation of Global Compliance(Shenzhen) Co., Ltd is accredited by A2LA

TEST EQUIPMENT OF CONDUCTED EMISSION TEST

Equipment	Manufacturer	Model	S/N	Cal. Date	Cal. Due
TEST RECEIVER	R&S	ESPI	101206	Jun. 11, 2019	Jun. 12, 2020
LISN	R&S	ESH2-Z5	100086	Aug. 26, 2019	Aug. 25, 2020

TEST EQUIPMENT OF RADIATED EMISSION TEST

Equipment	Manufacturer	Model	S/N	Cal. Date	Cal. Due
TEST RECEIVER	R&S	ESCI	10096	Jun. 11, 2019	Jun. 12, 2020
EXA Signal Analyzer	Aglient	N9010A	MY53470504	Dec. 20, 2018	Dec. 19, 2019
2.4GHz Fliter	Micro-tronics	087	N/A	Jun. 11, 2019	Jun. 12, 2020
Attenuator	Weinachel Corp	58-30-33	N/A	Jun. 11, 2019	Jun. 12, 2020
Horn antenna	SCHWARZBECK	BBHA 9170	#768	Sep. 21, 2017	Sep. 20, 2020
Active loop antenna (9K-30MHz)	ZHINAN	ZN30900C	18051	Jun. 14, 2018	Jun. 13, 2020
Double-Ridged Waveguide Horn	ETS LINDGREN	3117	00034609	May. 26, 2018	May. 25, 2020
Broadband Preamplifier	ETS LINDGREN	3117PA	00225134	Oct. 25, 2018	Oct. 24, 2019
ANTENNA	SCHWARZBECK	VULB9168	D69250	Sep. 28, 2017	Sep. 27, 2019



7. PEAK OUTPUT POWER

7.1. MEASUREMENT PROCEDURE

For peak power test:

1. Connect EUT RF output port to the Spectrum Analyzer through an RF attenuator
2. $RBW \geq DTS$ bandwidth
3. $VBW \geq 3 * RBW$.
4. $SPAN \geq VBW$.
5. Sweep: Auto.
6. Detector function: Peak.
7. Trace: Max hold.

Allow trace to stabilize. Use the marker-to-peak function to set the marker to the peak of the emission. The indicated level is the peak output power, after any corrections for external attenuators and cables.

7.2. TEST SET-UP (BLOCK DIAGRAM OF CONFIGURATION) PEAK POWER TEST SETUP

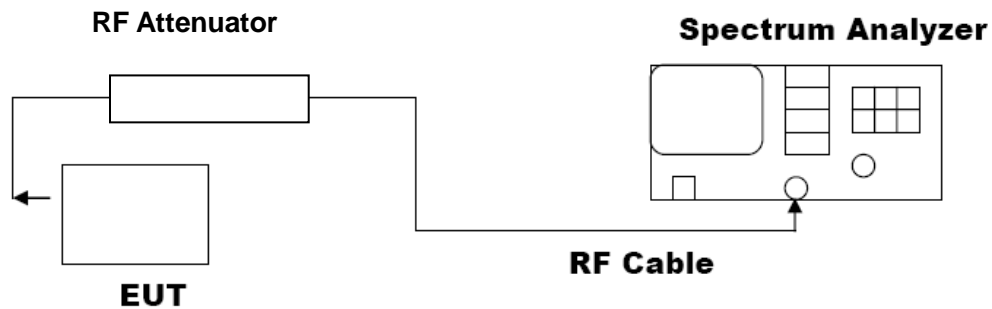

7.3. LIMITS AND MEASUREMENT RESULT

PEAK OUTPUT POWER MEASUREMENT RESULT FOR GFSK MOUDULATION			
Frequency (GHz)	Peak Power (dBm)	Applicable Limits (dBm)	Pass or Fail
2.402	6.743	30	Pass
2.440	6.713	30	Pass
2.480	6.631	30	Pass

CH0

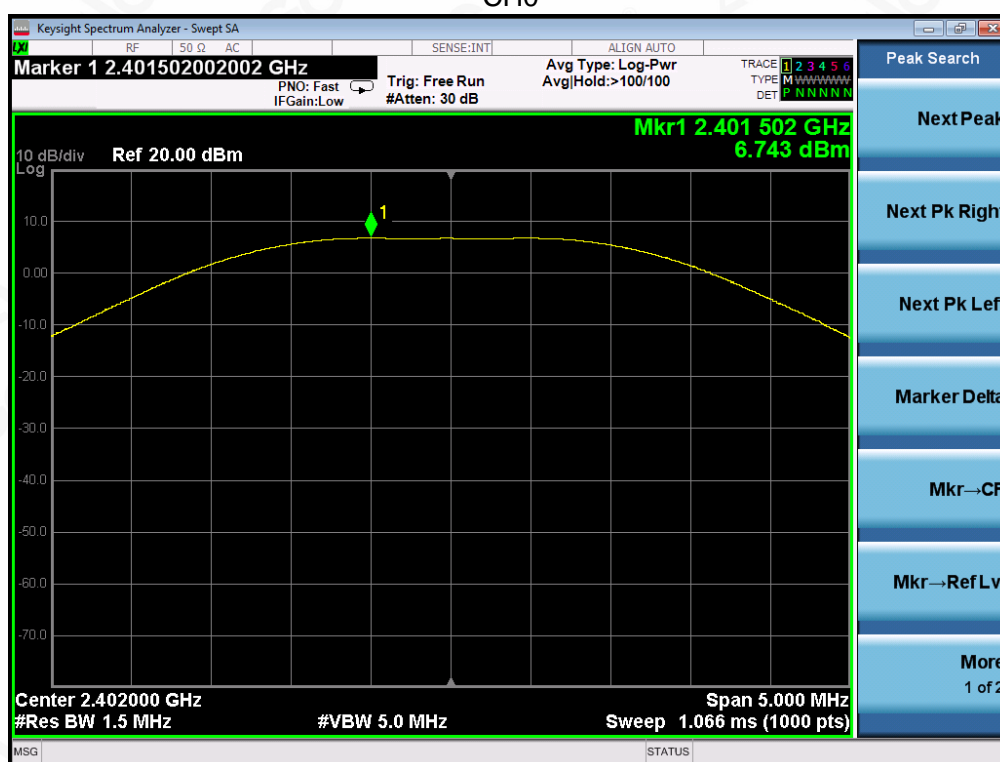

Attestation of Global Compliance

Attestation of Global Compliance(Shenzhen)Co.,Ltd.
Add: 2/F., Building 2, Sanwei Chaxi Industrial Park, Sanwei Community,
Hangcheng Street, Bao'an District, Shenzhen, Guangdong, China
Tel: +86-755 2523 4088 E-mail: agc@agc-cert.com Service Hotline:400 089 2118

CH19



CH39

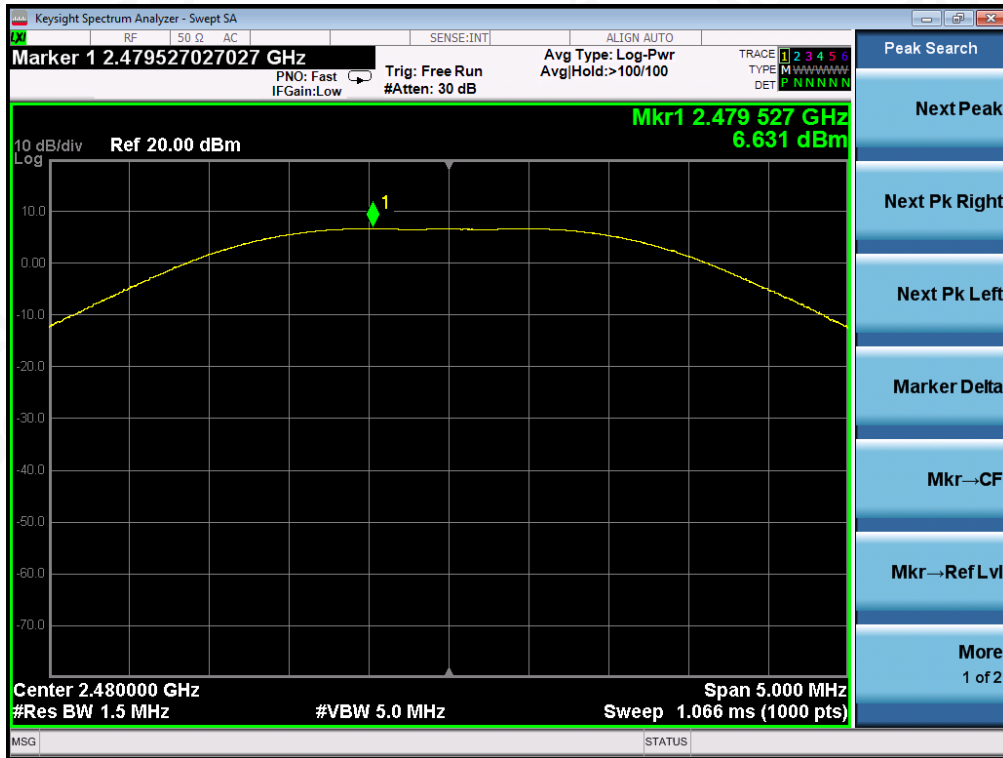

Attestation of Global Compliance

Attestation of Global Compliance(Shenzhen)Co.,Ltd.

Add: 2/F., Building 2, Sanwei Chaxi Industrial Park, Sanwei Community,
Hangcheng Street, Bao'an District, Shenzhen, Guangdong, China

Tel: +86-755 2523 4088

E-mail: agc@agc-cert.com

Service Hotline:400 089 2118

8. 6 DB BANDWIDTH

8.1. MEASUREMENT PROCEDURE

1. Connect EUT RF output port to the Spectrum Analyzer through an RF attenuator
2. Set the EUT Work on the top, the middle and the bottom operation frequency individually.
3. Set SPA Centre Frequency = Operation Frequency, RBW= 100 KHz, VBW $\geq 3 \times$ RBW.
4. Set SPA Trace 1 Max hold, then View.

Note: The EUT was tested according to ANSI C63.10 for compliance to FCC PART 15.247 requirements.

8.2. TEST SET-UP (BLOCK DIAGRAM OF CONFIGURATION)

The same as described in section 7.2.

8.3. LIMITS AND MEASUREMENT RESULTS

LIMITS AND MEASUREMENT RESULT			
Applicable Limits	Applicable Limits		
	Test Data (MHz)		Criteria
>500KHZ	Low Channel	1.219	PASS
	Middle Channel	1.218	PASS
	High Channel	1.221	PASS

TEST PLOT OF BANDWIDTH FOR LOW CHANNEL

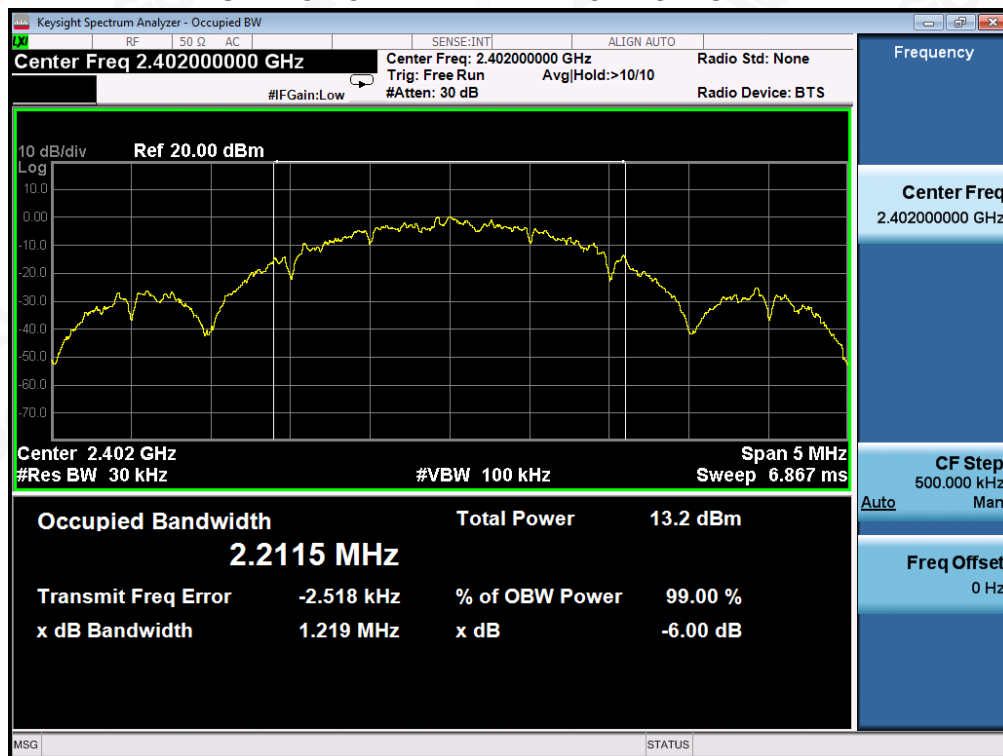

TEST PLOT OF BANDWIDTH FOR MIDDLE CHANNEL

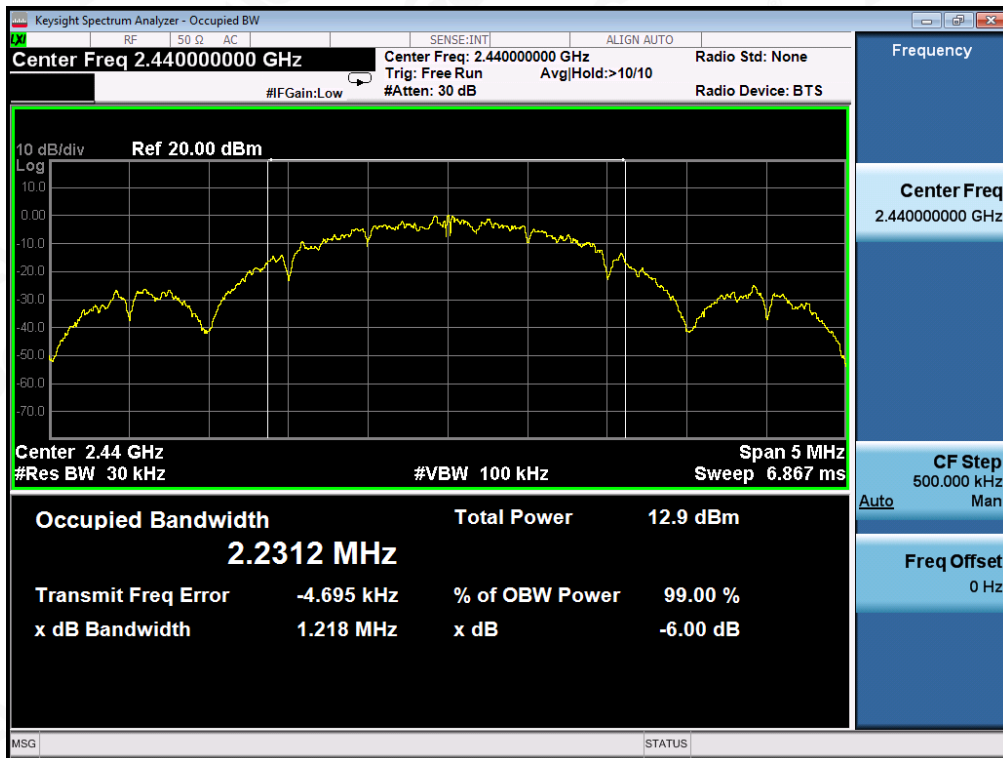

TEST PLOT OF BANDWIDTH FOR HIGH CHANNEL

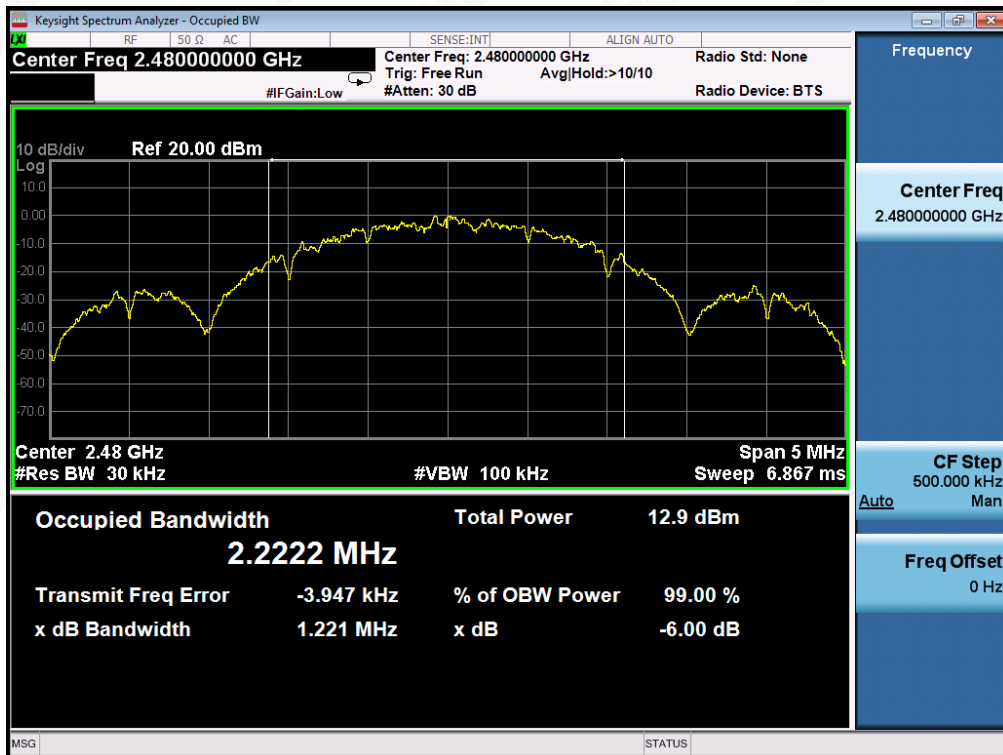

Attestation of Global Compliance

Attestation of Global Compliance(Shenzhen)Co.,Ltd.

Add: 2/F., Building 2, Sanwei Chaxi Industrial Park, Sanwei Community,
Hangcheng Street, Bao'an District, Shenzhen, Guangdong, China

Tel: +86-755 2523 4088

E-mail: agc@agc-cert.com

Service Hotline: 400 089 2118

9. CONDUCTED SPURIOUS EMISSION

9.1. MEASUREMENT PROCEDURE

1. Connect EUT RF output port to the Spectrum Analyzer through an RF attenuator
2. Set the EUT Work on the top, the middle and the bottom operation frequency individually.
3. Set SPA Trace 1 Max hold, then View.

Note: The EUT was tested according to ANSI C63.10 for compliance to FCC PART 15.247 requirements.

9.2. TEST SET-UP (BLOCK DIAGRAM OF CONFIGURATION)

The same as described in section 7.2.

9.3. MEASUREMENT EQUIPMENT USED

The same as described in section 6.

9.4. LIMITS AND MEASUREMENT RESULT

LIMITS AND MEASUREMENT RESULT		
Applicable Limits	Measurement Result	
	Test Data	Criteria
In any 100 KHz Bandwidth Outside the frequency band in which the spread spectrum intentional radiator is operating, the radio frequency power that is produce by the intentional radiator shall be at least 20 dB below that in 100KHz bandwidth within the band that contains the highest level of the desired power.	At least -20dBc than the reference level	PASS



**TEST RESULT FOR ENTIRE FREQUENCY RANGE
O-QPSK MODULATION IN LOW CHANNEL**

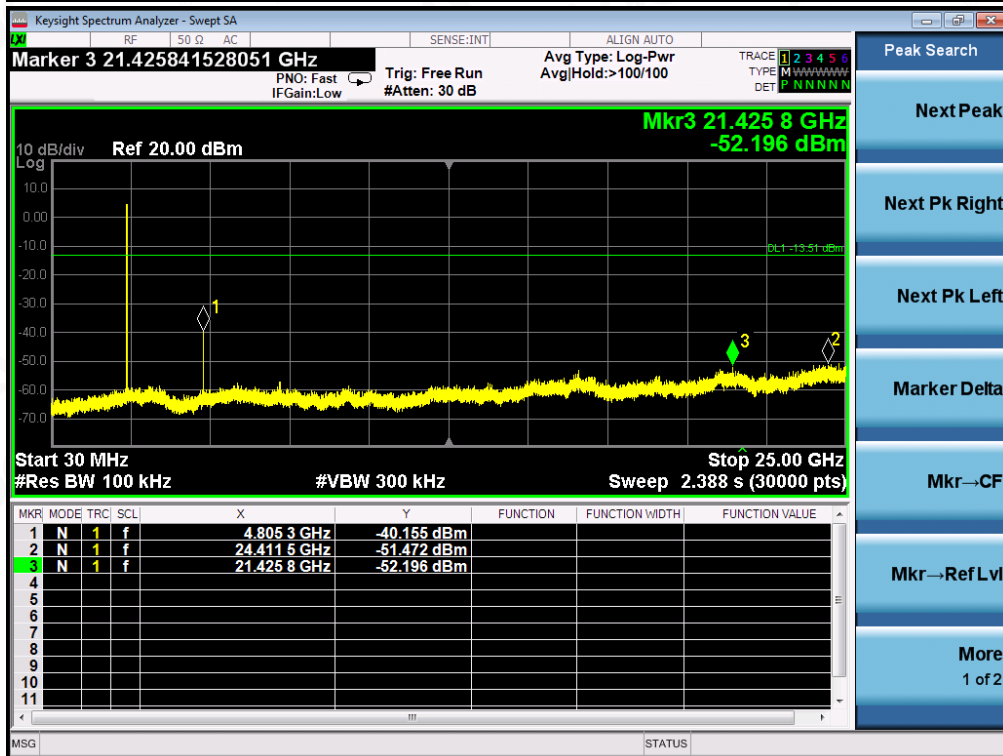
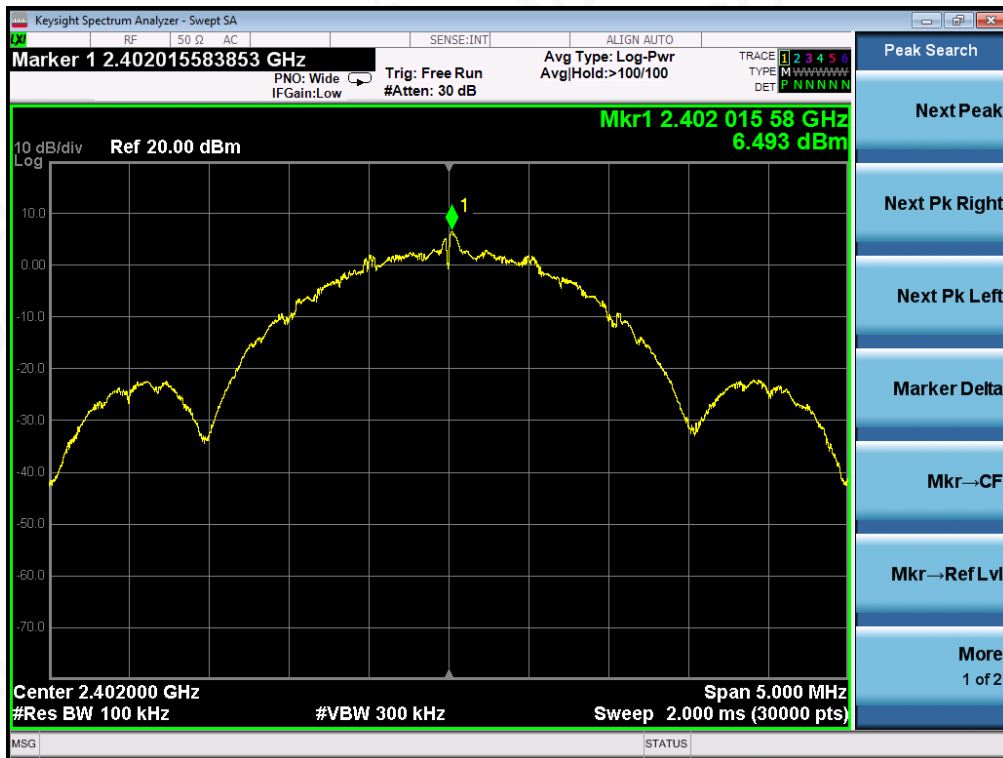

Attestation of Global Compliance

Attestation of Global Compliance(Shenzhen)Co.,Ltd.
Add: 2/F., Building 2, Sanwei Chaxi Industrial Park, Sanwei Community,
Hangcheng Street, Bao'an District, Shenzhen, Guangdong, China
Tel: +86-755 2523 4088 E-mail: agc@agc-cert.com Service Hotline:400 089 2118

O-QPSK MODULATION IN MIDDLE CHANNEL

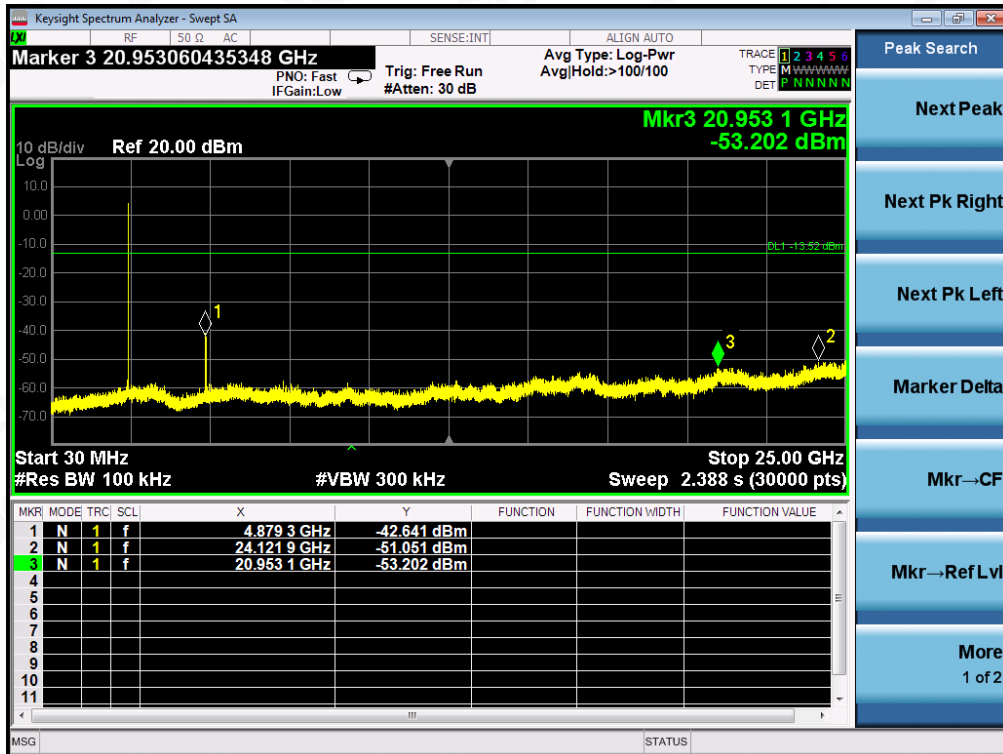
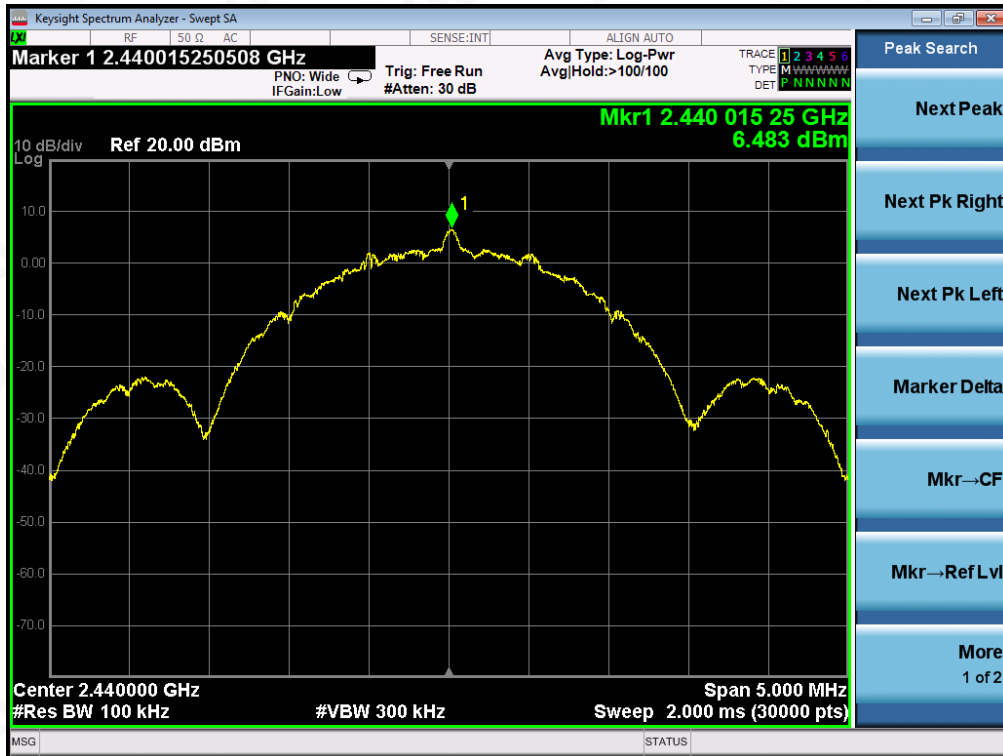

Attestation of Global Compliance

Attestation of Global Compliance(Shenzhen)Co.,Ltd.

Add: 2/F., Building 2, Sanwei Chaxi Industrial Park, Sanwei Community,
Hangcheng Street, Bao'an District, Shenzhen, Guangdong, China

Tel: +86-755 2523 4088

E-mail: agc@agc-cert.com

Service Hotline: 400 089 2118

O-QPSK MODULATION IN HIGH CHANNEL

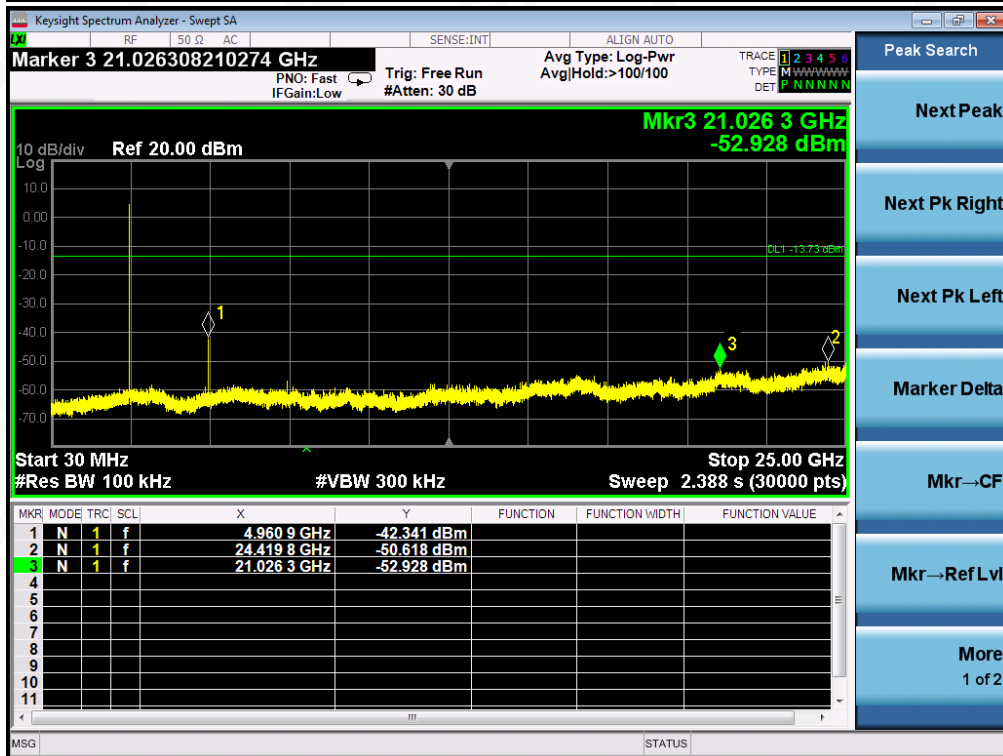
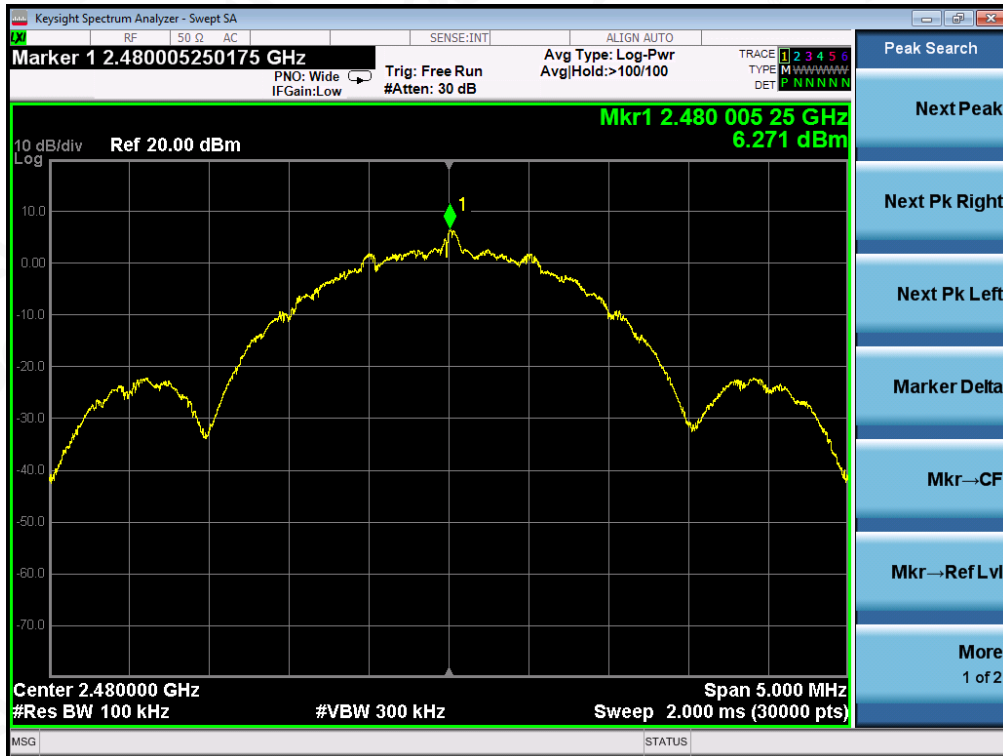

Note: The peak emissions without marker on the above plots are fundamental wave and need not to compare with the limit.



Attestation of Global Compliance

Attestation of Global Compliance(Shenzhen)Co.,Ltd.

Add: 2/F., Building 2, Sanwei Chaxi Industrial Park, Sanwei Community,
Hangcheng Street, Bao'an District, Shenzhen, Guangdong, China

Tel: +86-755 2523 4088

E-mail: agc@agc-cert.com

Service Hotline:400 089 2118

TEST RESULT FOR BAND EDGE O-QPSK MODULATION IN LOW CHANNEL

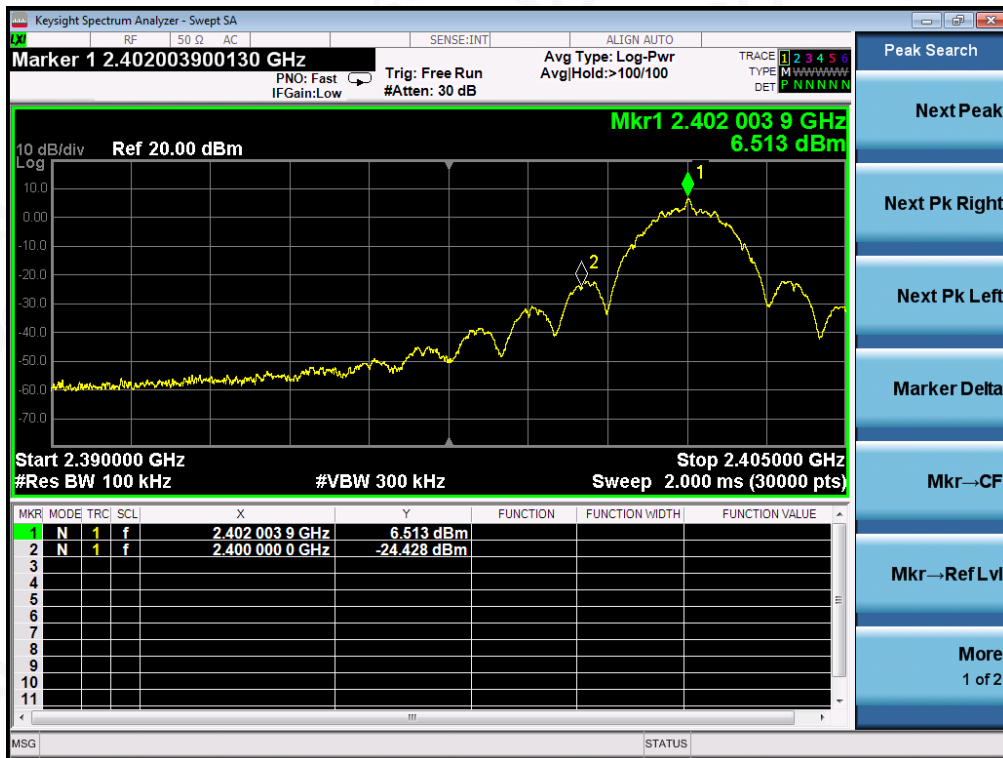

O-QPSK MODULATION IN HIGH CHANNEL



Attestation of Global Compliance

Attestation of Global Compliance(Shenzhen)Co.,Ltd.

Add: 2/F., Building 2, Sanwei Chaxi Industrial Park, Sanwei Community,
Hangcheng Street, Bao'an District, Shenzhen, Guangdong, China

Tel: +86-755 2523 4088 E-mail: agc@agc-cert.com Service Hotline:400 089 2118

TEST PLOT OF SPECTRAL DENSITY FOR MIDDLE CHANNEL



TEST PLOT OF SPECTRAL DENSITY FOR HIGH CHANNEL

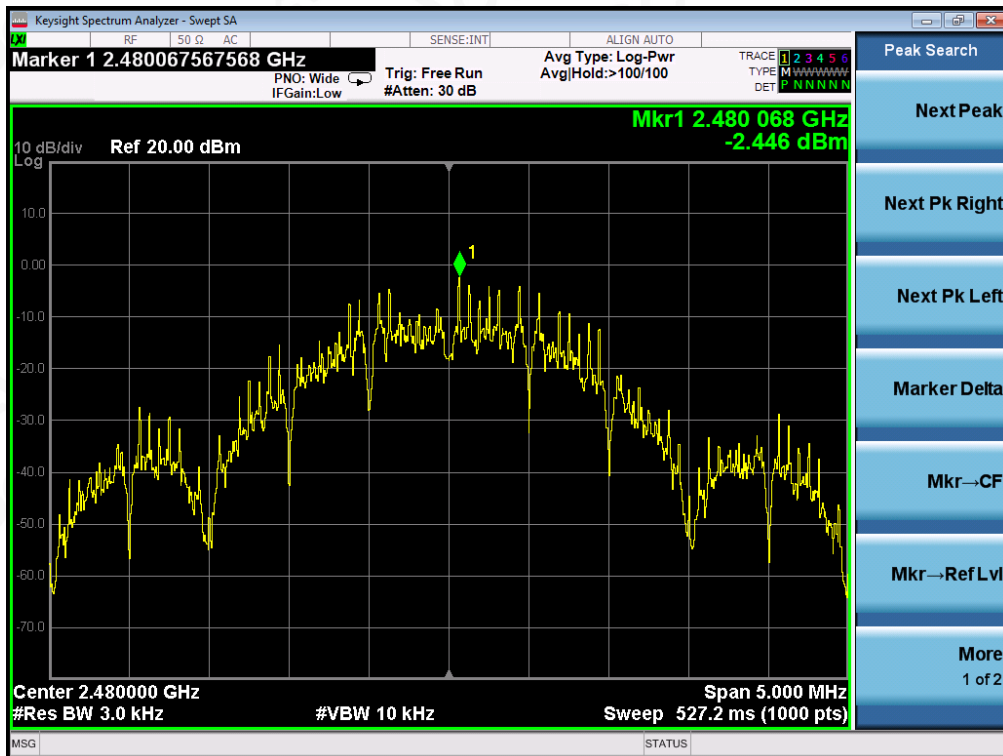

Attestation of Global Compliance

Attestation of Global Compliance(Shenzhen)Co.,Ltd.
Add: 2/F., Building 2, Sanwei Chaxi Industrial Park, Sanwei Community,
Hangcheng Street, Bao'an District, Shenzhen, Guangdong, China
Tel: +86-755 2523 4088 E-mail: agc@agc-cert.com Service Hotline:400 089 2118

11. RADIATED EMISSION

11.1. MEASUREMENT PROCEDURE

1. The EUT was placed on the top of the turntable 0.8 or 1.5 meter above ground. The phase center of the receiving antenna mounted on the top of a height-variable antenna tower was placed 3 meters far away from the turntable.
2. Power on the EUT and all the supporting units. The turntable was rotated by 360 degrees to determine the position of the highest radiation.
3. The height of the broadband receiving antenna was varied between one meter and four meters above ground to find the maximum emissions field strength of both horizontal and vertical polarization.
4. For each suspected emissions, the antenna tower was scan (from 1 M to 4 M) and then the turntable was rotated (from 0 degree to 360 degrees) to find the maximum reading.
5. Set the test-receiver system to Peak or CISPR quasi-peak Detect Function with specified bandwidth under Maximum Hold Mode.
6. For emissions above 1GHz, use 1MHz RBW and 3MHz VBW for peak reading. Place the measurement antenna away from each area of the EUT determined to be a source of emissions at the specified measurement distance, while keeping the measurement antenna aimed at the source of emissions at each frequency of significant emissions, with polarization oriented for maximum response. The measurement antenna may have to be higher or lower than the EUT, depending on the radiation pattern of the emission and staying aimed at the emission source for receiving the maximum signal. The final measurement antenna elevation shall be that which maximizes the emissions. The measurement antenna elevation for maximum emissions shall be restricted to a range of heights of from 1 m to 4 m above the ground or reference ground plane.
7. When the radiated emissions limits are expressed in terms of the average value of the emissions, and pulsed operation is employed, the measurement field strength shall be determined by averaging over one complete pulse train, including blanking intervals, as long as the pulse train does not exceed 0.1 seconds. As an alternative (provided the transmitter operates for longer than 0.1 seconds) or in cases where the pulse train exceeds 0.1 seconds, the measured field strength shall be determined from the average absolute voltage during a 0.1 second interval during which the field strength is at its maximum values.
8. If the emissions level of the EUT in peak mode was 3 dB lower than the average limit specified, then testing will be stopped and peak values of EUT will be reported, otherwise, the emissions which do not have 3 dB margin will be repeated one by one using the quasi-peak method for below 1GHz.
9. For testing above 1GHz, the emissions level of the EUT in peak mode was lower than average limit (that means the emissions level in peak mode also complies with the limit in average mode), then testing will be stopped and peak values of EUT will be reported, otherwise, the emissions will be measured in average mode again and reported.
10. In case the emission is lower than 30MHz, loop antenna has to be used for measurement and the recorded data should be QP measured by receiver. High - Low scan is not required in this case.

11.2. TEST SETUP

Radiated Emission Test-Setup Frequency Below 30MHz

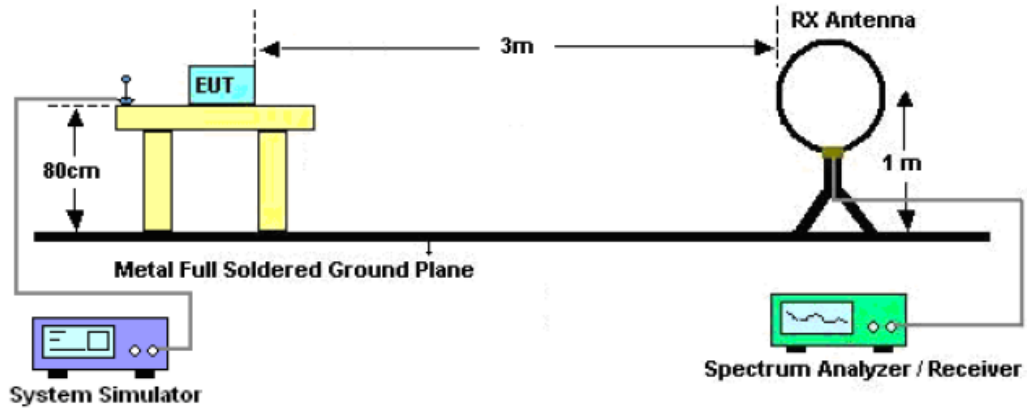

RADIATED EMISSION TEST SETUP 30MHz-1000MHz

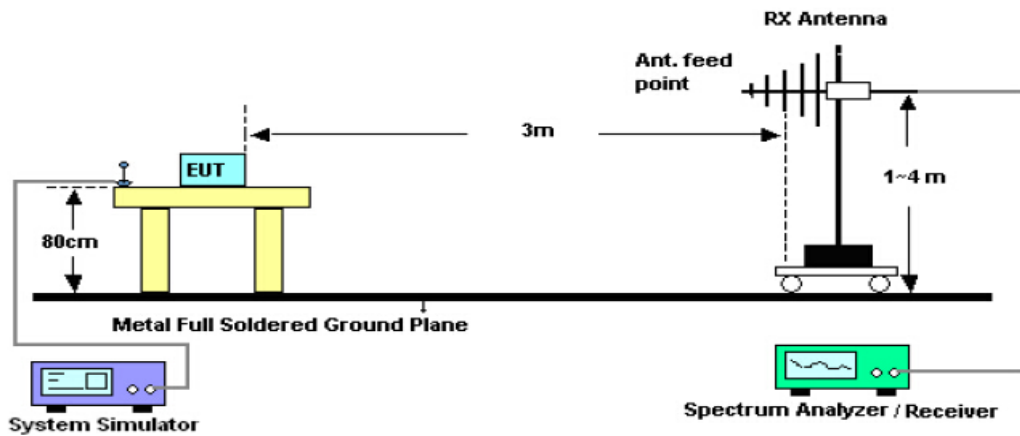

RADIATED EMISSION TEST SETUP ABOVE 1000MHz

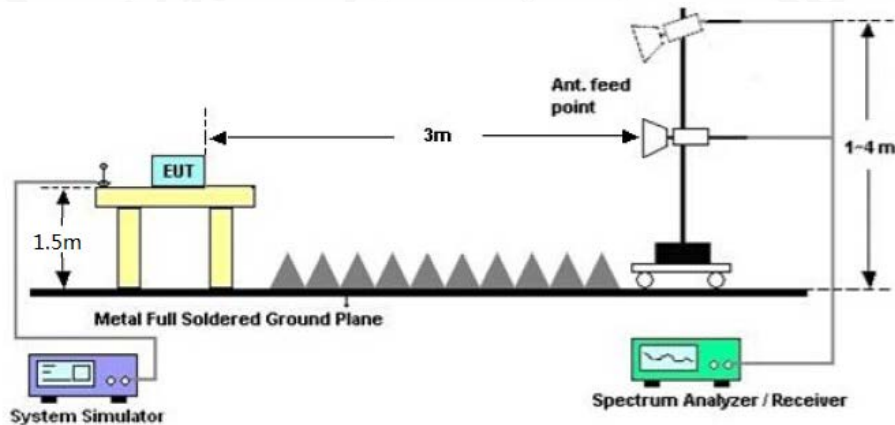

11.3. LIMITS AND MEASUREMENT RESULT

15.209 Limit in the below table has to be followed

Frequencies (MHz)	Field Strength (micorvolts/meter)	Measurement Distance (meters)
0.009~0.490	2400/F(KHz)	300
0.490~1.705	24000/F(KHz)	30
1.705~30.0	30	30
30~88	100	3
88~216	150	3
216~960	200	3
Above 960	500	3

Note: All modes were tested For restricted band radiated emission, the test records reported below are the worst result compared to other modes.

11.4. TEST RESULT

RADIATED EMISSION BELOW 30MHZ

No emission found between lowest internal used/generated frequencies to 30MHz.



RADIATED EMISSION BELOW 1GHZ

EUT	BMD-341	Model Name	BMD-341
Temperature	25° C	Relative Humidity	55.4%
Pressure	960hPa	Test Voltage	Normal Voltage
Test Mode	Mode 1	Antenna	Horizontal

66.9 dBuV/m

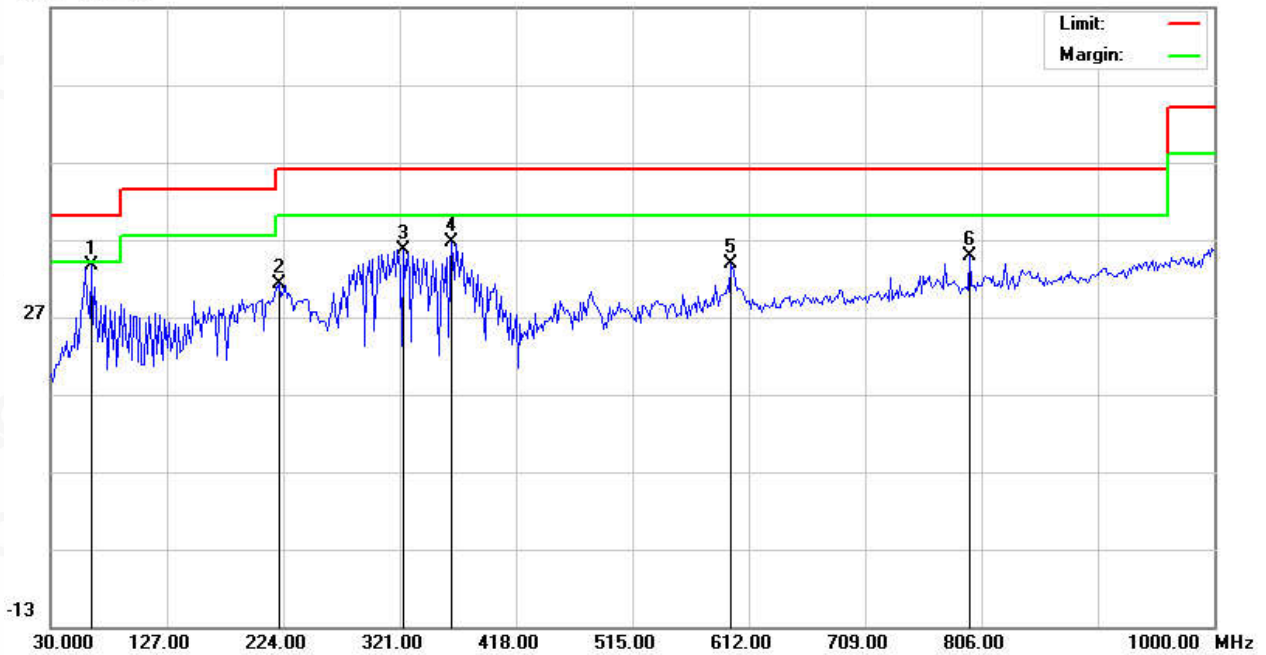

No.	Mk	Freq.	Reading	Factor	Measurement	Limit	Over	Detector	Antenna Height	Table Degree	Comment
		MHz	dBuV	dBuV/m	dBuV/m	dBuV/m	dB		cm	degree	
1	*	63.9500	15.40	18.17	33.57	40.00	-6.43	peak			
2		220.7666	13.95	17.29	31.24	46.00	-14.76	peak			
3		324.2330	15.27	20.32	35.59	46.00	-10.41	peak			
4		364.6499	14.93	21.74	36.67	46.00	-9.33	peak			
5		597.4500	6.86	26.90	33.76	46.00	-12.24	peak			
6		796.2999	4.52	30.33	34.85	46.00	-11.15	peak			

RESULT: PASS



Attestation of Global Compliance

Attestation of Global Compliance(Shenzhen)Co.,Ltd.

Add: 2/F., Building 2, Sanwei Chaxi Industrial Park, Sanwei Community,
Hangcheng Street, Bao'an District, Shenzhen, Guangdong, China

Tel: +86-755 2523 4088

E-mail: agc@agc-cert.com

Service Hotline: 400 089 2118

EUT	BMD-341	Model Name	BMD-341
Temperature	25° C	Relative Humidity	55.4%
Pressure	960hPa	Test Voltage	Normal Voltage
Test Mode	Mode 1	Antenna	Vertical

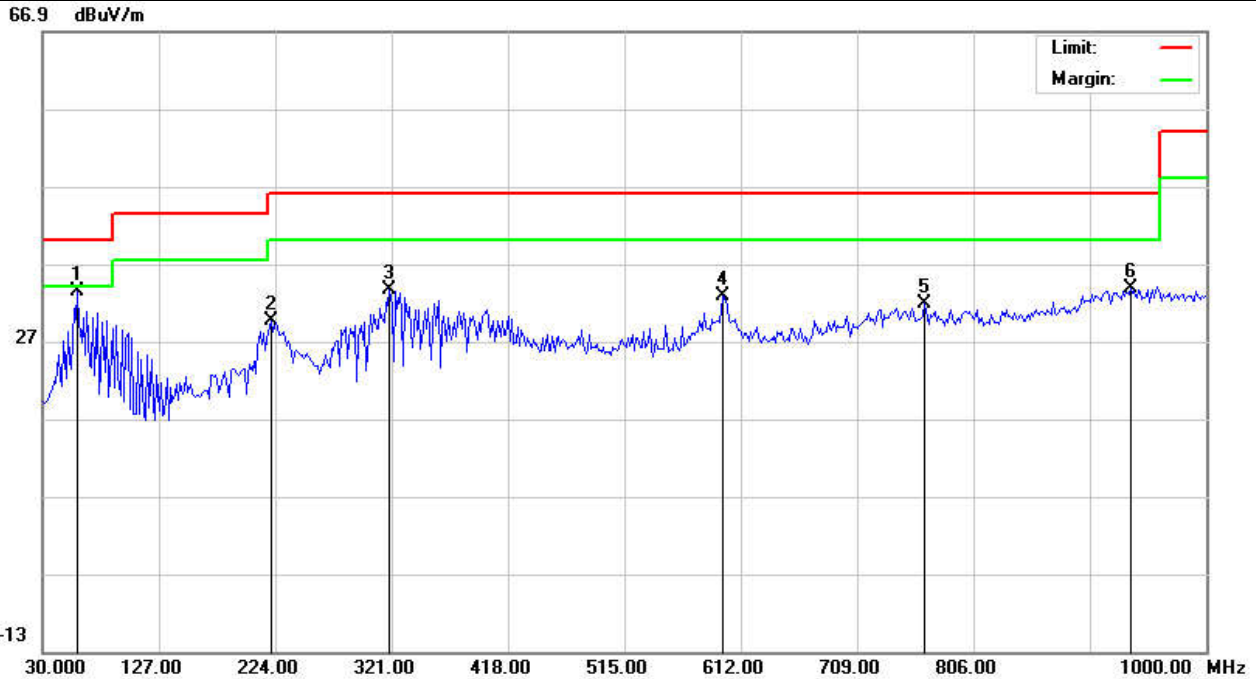

No.	Mk	Freq.	Reading	Factor	Measurement	Limit	Over	Detector	Antenna Height	Table Degree	Comment
		MHz	dBuV	dBuV/m	dBuV/m	dBuV/m	dB		cm	degree	
1	*	59.0998	14.46	18.95	33.41	40.00	-6.59	peak			
2		220.7666	12.27	17.29	29.56	46.00	-16.44	peak			
3		319.3833	13.45	20.15	33.60	46.00	-12.40	peak			
4		597.4500	5.88	26.90	32.78	46.00	-13.22	peak			
5		765.5833	2.19	29.63	31.82	46.00	-14.18	peak			
6		936.9500	1.86	32.02	33.88	46.00	-12.12	peak			

RESULT: PASS

Note:

1. Factor=Antenna Factor + Cable loss, Margin=Measurement-Limit.
2. All test modes had been tested. The mode 1 with external antenna 1 is the worst case and recorded in the report.

RADIATED EMISSION ABOVE 1GHZ

EUT	BMD-341	Model Name	BMD-341
Temperature	25° C	Relative Humidity	55.4%
Pressure	960hPa	Test Voltage	Normal Voltage
Test Mode	Mode 1	Antenna	Horizontal

Frequency (MHz)	Meter Reading (dBµV)	Factor (dB)	Emission Level (dBµV/m)	Limits (dBµV/m)	Margin (dB)	Value Type
4804.024	50.66	0.08	50.74	74.00	-23.26	peak
4804.024	48.03	0.08	48.11	54.00	-5.89	AVG
7206.036	42.84	2.21	45.05	74.00	-28.95	peak
7206.036	39.41	2.21	41.62	54.00	-12.38	AVG

Remark:

Factor = Antenna Factor + Cable Loss – Pre-amplifier.

EUT	BMD-341	Model Name	BMD-341
Temperature	25° C	Relative Humidity	55.4%
Pressure	960hPa	Test Voltage	Normal Voltage
Test Mode	Mode 1	Antenna	Vertical

Frequency (MHz)	Meter Reading (dBµV)	Factor (dB)	Emission Level (dBµV/m)	Limits (dBµV/m)	Margin (dB)	Value Type
4804.024	53.39	0.08	53.47	74.00	-20.53	peak
4804.024	46.99	0.08	47.07	54.00	-6.93	AVG
7206.036	43.83	2.21	46.04	74.00	-27.96	peak
7206.036	42.60	2.21	44.81	54.00	-9.19	AVG

Remark:

Factor = Antenna Factor + Cable Loss – Pre-amplifier.



EUT	BMD-341	Model Name	BMD-341
Temperature	25° C	Relative Humidity	55.4%
Pressure	960hPa	Test Voltage	Normal Voltage
Test Mode	Mode 2	Antenna	Horizontal

Frequency (MHz)	Meter Reading (dBμV)	Factor (dB)	Emission Level (dBμV/m)	Limits (dBμV/m)	Margin (dB)	Value Type
4880.024	51.58	0.14	51.72	74.00	-22.28	peak
4880.024	45.91	0.14	46.05	54.00	-7.95	AVG
7320.036	47.10	2.36	49.46	74.00	-24.54	peak
7320.036	44.69	2.36	47.05	54.00	-6.95	AVG

Remark:

Factor = Antenna Factor + Cable Loss – Pre-amplifier.

EUT	BMD-341	Model Name	BMD-341
Temperature	25° C	Relative Humidity	55.4%
Pressure	960hPa	Test Voltage	Normal Voltage
Test Mode	Mode 2	Antenna	Vertical

Frequency (MHz)	Meter Reading (dBμV)	Factor (dB)	Emission Level (dBμV/m)	Limits (dBμV/m)	Margin (dB)	Value Type
4880.024	51.33	0.14	51.47	74.00	-22.53	peak
4880.024	48.44	0.14	48.58	54.00	-5.42	AVG
7320.036	45.25	2.36	47.61	74.00	-26.39	peak
7320.036	42.75	2.36	45.11	54.00	-8.89	AVG

Remark:

Factor = Antenna Factor + Cable Loss – Pre-amplifier.



EUT	BMD-341	Model Name	BMD-341
Temperature	25° C	Relative Humidity	55.4%
Pressure	960hPa	Test Voltage	Normal Voltage
Test Mode	Mode 3	Antenna	Horizontal

Frequency (MHz)	Meter Reading (dBμV)	Factor (dB)	Emission Level (dBμV/m)	Limits (dBμV/m)	Margin (dB)	Value Type
4960.024	50.49	0.22	50.71	74.00	-23.29	peak
4960.024	47.85	0.22	48.07	54.00	-5.93	AVG
7440.036	45.05	2.64	47.69	74.00	-26.31	peak
7440.036	42.51	2.64	45.15	54.00	-8.85	AVG

Remark:
Factor = Antenna Factor + Cable Loss – Pre-amplifier.

EUT	BMD-341	Model Name	BMD-341
Temperature	25° C	Relative Humidity	55.4%
Pressure	960hPa	Test Voltage	Normal Voltage
Test Mode	Mode 3	Antenna	Vertical

Frequency (MHz)	Meter Reading (dBμV)	Factor (dB)	Emission Level (dBμV/m)	Limits (dBμV/m)	Margin (dB)	Value Type
4960.024	50.55	0.22	50.77	74.00	-23.23	peak
4960.024	47.31	0.22	47.53	54.00	-6.48	AVG
7440.036	44.91	2.64	47.55	74.00	-26.45	peak
7440.036	42.97	2.64	45.61	54.00	-8.39	AVG

Remark:
Factor = Antenna Factor + Cable Loss – Pre-amplifier.

RESULT: PASS

Note:

- Other emissions from 1G to 25 GHz are considered as ambient noise. No recording in the test report.
Factor = Antenna Factor + Cable loss - Amplifier gain, Over=Measure-Limit.
The "Factor" value can be calculated automatically by software of measurement system.
- All external antennas had been tested. The external antenna 1 is the worst case and recorded in the report.



TEST RESULT FOR RESTRICTED BANDS REQUIREMENTS

EUT	BMD-341	Model Name	BMD-341
Temperature	25° C	Relative Humidity	55.4%
Pressure	960hPa	Test Voltage	Normal Voltage
Test Mode	Mode 1	Antenna	Horizontal

PK



AV

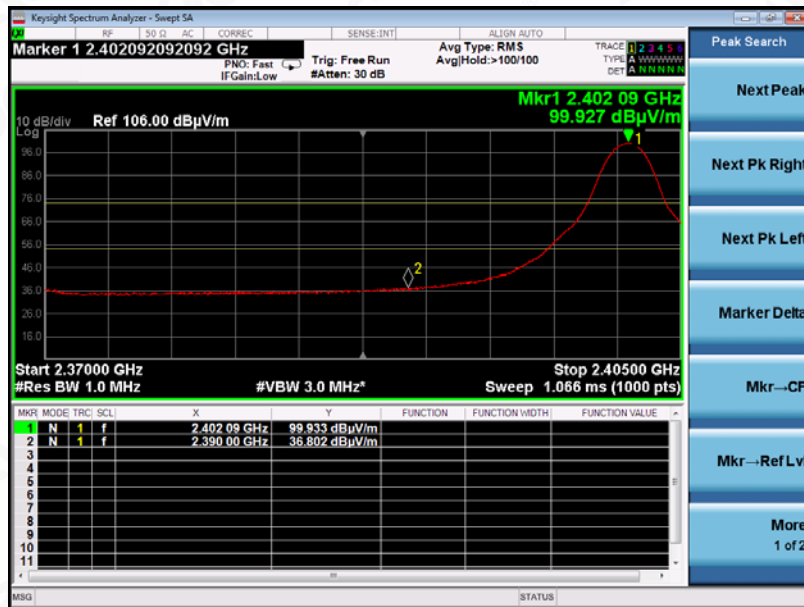

RESULT: PASS



Attestation of Global Compliance

Attestation of Global Compliance(Shenzhen)Co.,Ltd.
Add: 2/F., Building 2, Sanwei Chaxi Industrial Park, Sanwei Community,
Hangcheng Street, Bao'an District, Shenzhen, Guangdong, China
Tel: +86-755 2523 4088 E-mail: agc@agc-cert.com Service Hotline:400 089 2118

EUT	BMD-341	Model Name	BMD-341
Temperature	25° C	Relative Humidity	55.4%
Pressure	960hPa	Test Voltage	Normal Voltage
Test Mode	Mode 1	Antenna	Vertical

PK

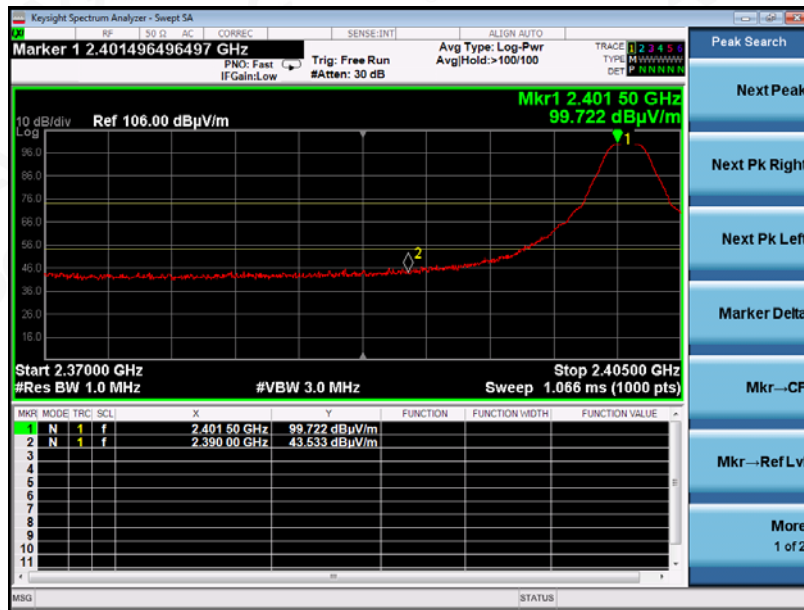

AV

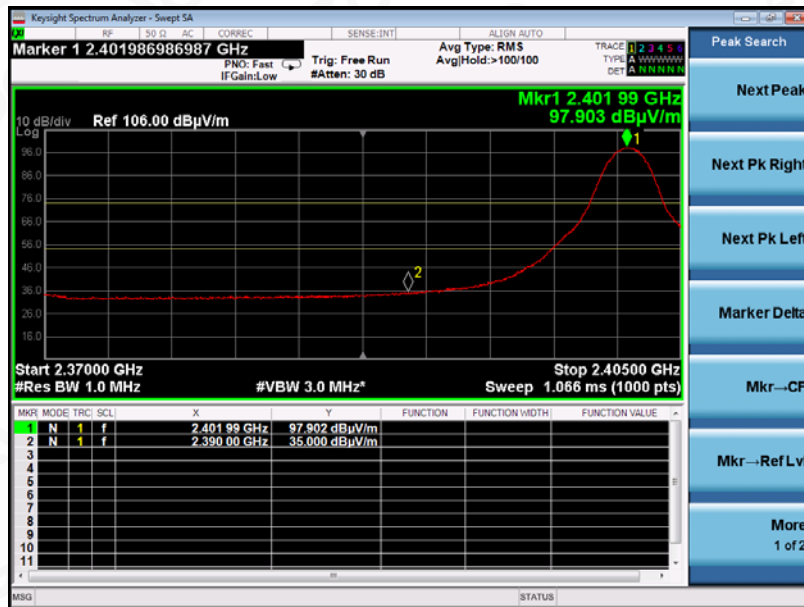

RESULT: PASS



Attestation of Global Compliance

Attestation of Global Compliance(Shenzhen)Co.,Ltd.

Add: 2/F., Building 2, Sanwei Chaxi Industrial Park, Sanwei Community,
Hangcheng Street, Bao'an District, Shenzhen, Guangdong, China

Tel: +86-755 2523 4088

E-mail: agc@agc-cert.com

Service Hotline: 400 089 2118

EUT	BMD-341	Model Name	BMD-341
Temperature	25° C	Relative Humidity	55.4%
Pressure	960hPa	Test Voltage	Normal Voltage
Test Mode	Mode 3	Antenna	Horizontal

PK



AV



RESULT: PASS



Attestation of Global Compliance

Attestation of Global Compliance(Shenzhen)Co.,Ltd.

Add: 2/F., Building 2, Sanwei Chaxi Industrial Park, Sanwei Community,
Hangcheng Street, Bao'an District, Shenzhen, Guangdong, China

Tel: +86-755 2523 4088

E-mail: agc@agc-cert.com

Service Hotline: 400 089 2118

EUT	BMD-341	Model Name	BMD-341
Temperature	25° C	Relative Humidity	55.4%
Pressure	960hPa	Test Voltage	Normal Voltage
Test Mode	Mode 3	Antenna	Vertical

PK

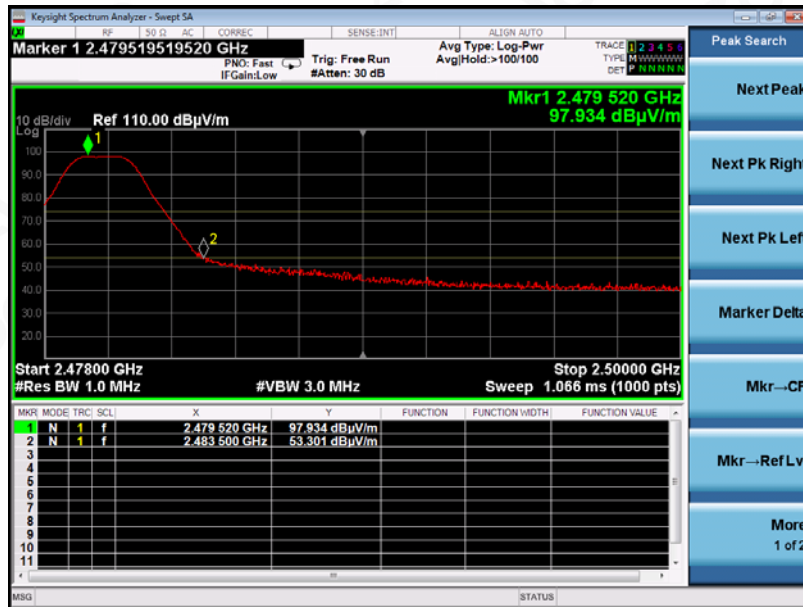

AV



RESULT: PASS

Note:

1. The factor had been edited in the "Input Correction" of the Spectrum Analyzer. So the Amplitude of test plots is equal to Reading level plus the Factor in dB. Use the A dB(μV) to represent the Amplitude. Use the F dB(μV/m) to represent the Field Strength. So A=F.
2. All external antennas had been tested. The external antenna 1 is the worst case and recorded in the report.



Attestation of Global Compliance

Attestation of Global Compliance(Shenzhen)Co.,Ltd.

Add: 2/F., Building 2, Sanwei Chaxi Industrial Park, Sanwei Community,
Hangcheng Street, Bao'an District, Shenzhen, Guangdong, China

Tel: +86-755 2523 4088

E-mail: agc@agc-cert.com

Service Hotline: 400 089 2118

12. FCC LINE CONDUCTED EMISSION TEST

12.1. LIMITS OF LINE CONDUCTED EMISSION TEST

Frequency	Maximum RF Line Voltage	
	Q.P.(dBuV)	Average(dBuV)
150kHz~500kHz	66-56	56-46
500kHz~5MHz	56	46
5MHz~30MHz	60	50

Note:

1. The lower limit shall apply at the transition frequency.
2. The limit decreases linearly with the logarithm of the frequency in the range 0.15 MHz to 0.50 MHz.

12.2. BLOCK DIAGRAM OF LINE CONDUCTED EMISSION TEST

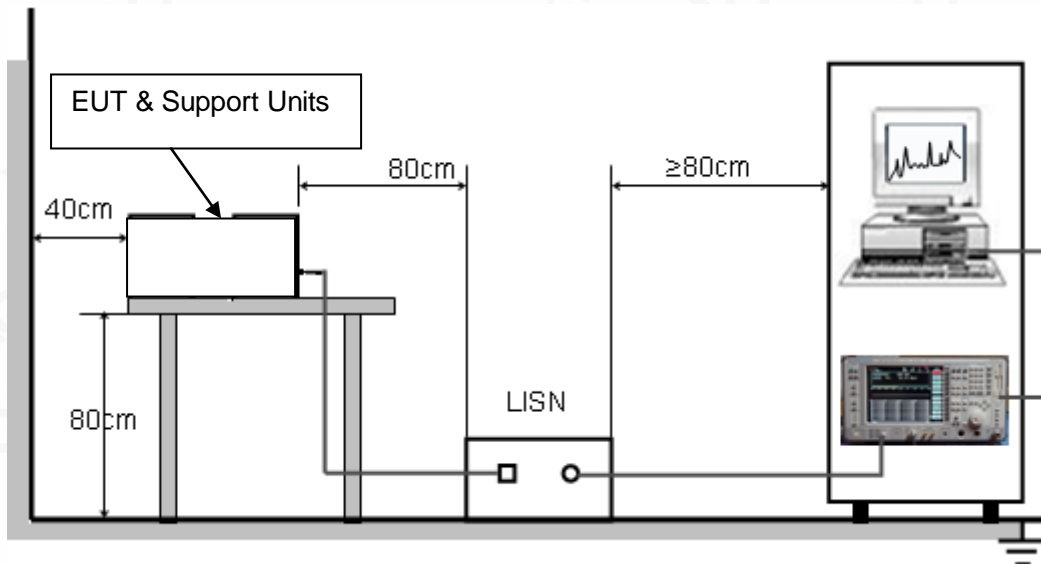

12.3. PRELIMINARY PROCEDURE OF LINE CONDUCTED EMISSION TEST

1. The equipment was set up as per the test configuration to simulate typical actual usage per the user's manual. When the EUT is a tabletop system, a wooden table with a height of 0.8 meters is used and is placed on the ground plane as per ANSI C63.10 (see Test Facility for the dimensions of the ground plane used). When the EUT is a floor-standing equipment, it is placed on the ground plane which has a 3-12 mm non-conductive covering to insulate the EUT from the ground plane.
2. Support equipment, if needed, was placed as per ANSI C63.10.
3. All I/O cables were positioned to simulate typical actual usage as per ANSI C63.10.
4. All support equipments received AC120V/60Hz power from a LISN, if any.
5. The EUT received DC charging voltage by PC which received AC120V/60Hz power by a LISN..
6. The test program was started. Emissions were measured on each current carrying line of the EUT using a spectrum Analyzer / Receiver connected to the LISN powering the EUT. The LISN has two monitoring points: Line 1 (Hot Side) and Line 2 (Neutral Side). Two scans were taken: one with Line 1 connected to Analyzer / Receiver and Line 2 connected to a 50 ohm load; the second scan had Line 1 connected to a 50 ohm load and Line 2 connected to the Analyzer / Receiver.
7. Analyzer / Receiver scanned from 150 kHz to 30MHz for emissions in each of the test modes.
8. During the above scans, the emissions were maximized by cable manipulation.
9. The test mode(s) were scanned during the preliminary test.

Then, the EUT configuration and cable configuration of the above highest emission level were recorded for reference of final testing.

12.4. FINAL PROCEDURE OF LINE CONDUCTED EMISSION TEST

1. EUT and support equipment was set up on the test bench as per step 2 of the preliminary test.
2. A scan was taken on both power lines, Line 1 and Line 2, recording at least the six highest emissions. Emission frequency and amplitude were recorded into a computer in which correction factors were used to calculate the emission level and compare reading to the applicable limit. If EUT emission level was less -2dB to the A.V. limit in Peak mode, then the emission signal was re-checked using Q.P and Average detector.
3. The test data of the worst case condition(s) was reported on the Summary Data page.

12.5. TEST RESULT OF LINE CONDUCTED EMISSION TEST

Line Conducted Emission Test Line 1-L

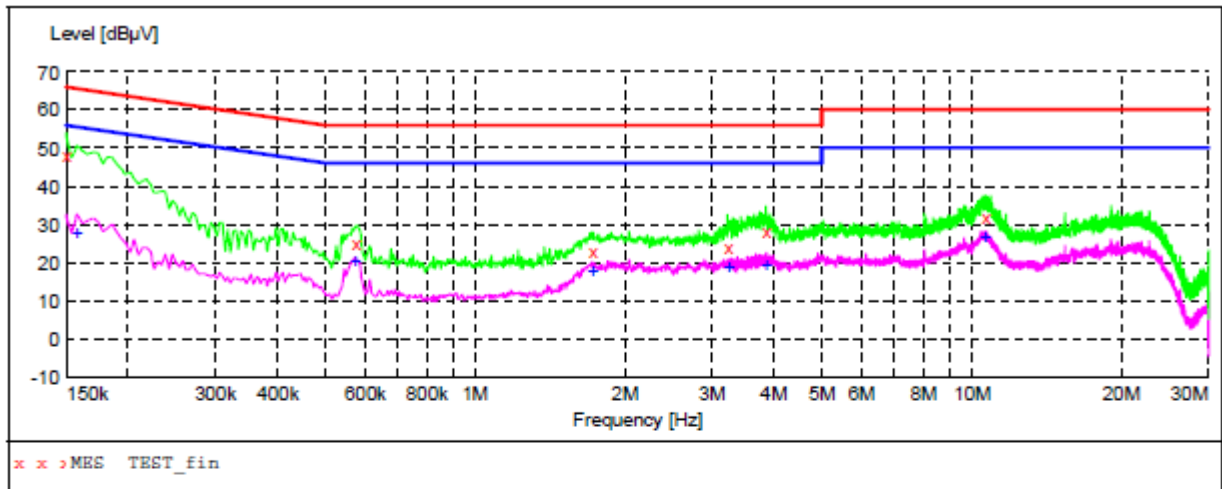

MEASUREMENT RESULT: "TEST_fin"

8/20/2019 5:37PM

Frequency MHz	Level dBµV	Transd dB	Limit dBµV	Margin dB	Detector	Line	PE
0.150000	48.30	10.8	66	17.7	QP	L1	FLO
0.574000	25.10	10.8	56	30.9	QP	L1	FLO
1.726000	23.20	11.5	56	32.8	QP	L1	FLO
3.226000	23.90	11.5	56	32.1	QP	L1	FLO
3.854000	28.10	11.6	56	27.9	QP	L1	FLO
10.674000	32.10	11.9	60	27.9	QP	L1	FLO

MEASUREMENT RESULT: "TEST_fin2"

8/20/2019 5:37PM

Frequency MHz	Level dBµV	Transd dB	Limit dBµV	Margin dB	Detector	Line	PE
0.158000	27.70	10.8	56	27.9	AV	L1	FLO
0.574000	20.20	10.8	46	25.8	AV	L1	FLO
1.726000	17.90	11.5	46	28.1	AV	L1	FLO
3.246000	18.80	11.5	46	27.2	AV	L1	FLO
3.866000	19.30	11.6	46	26.7	AV	L1	FLO
10.650000	26.70	11.9	50	23.3	AV	L1	FLO



Line Conducted Emission Test Line 2-N

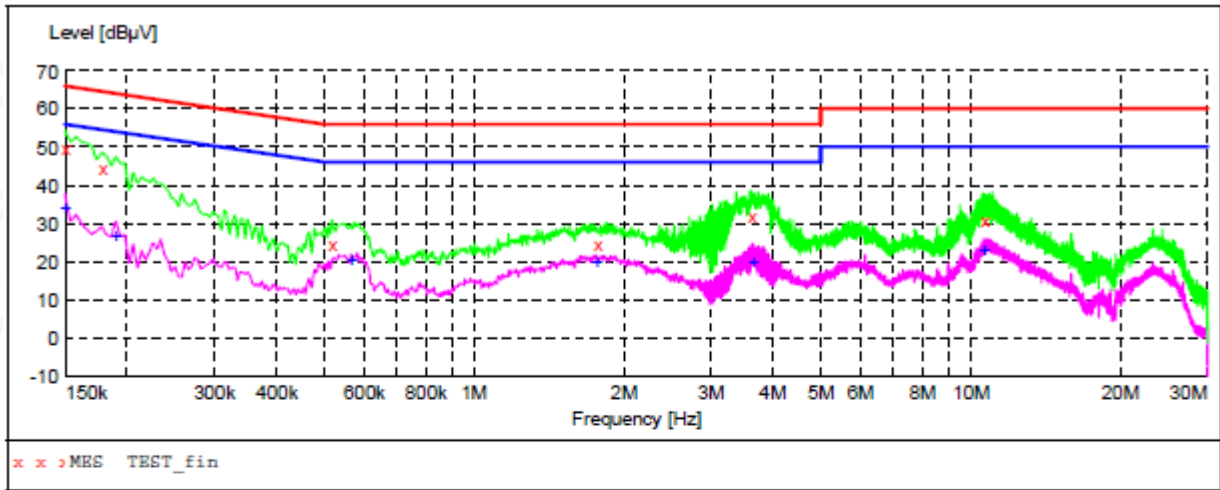

MEASUREMENT RESULT: "TEST_fin"

8/20/2019 5:24PM

Frequency MHz	Level dBuV	Transd dB	Limit dBuV	Margin dB	Detector	Line	PE
0.150000	50.00	10.8	66	16.0	QP	N	FLO
0.178000	44.40	10.9	65	20.2	QP	N	FLO
0.518000	24.40	11.1	56	31.6	QP	N	FLO
1.766000	24.80	11.5	56	31.2	QP	N	FLO
3.626000	31.90	11.6	56	24.1	QP	N	FLO
10.674000	31.10	11.9	60	28.9	QP	N	FLO

MEASUREMENT RESULT: "TEST_fin2"

8/20/2019 5:24PM

Frequency MHz	Level dBuV	Transd dB	Limit dBuV	Margin dB	Detector	Line	PE
0.150000	34.10	10.8	56	21.9	AV	N	FLO
0.190000	26.90	10.9	54	27.1	AV	N	FLO
0.566000	20.30	10.9	46	25.7	AV	N	FLO
1.766000	19.80	11.5	46	26.2	AV	N	FLO
3.650000	19.90	11.6	46	26.1	AV	N	FLO
10.650000	23.30	11.9	50	26.7	AV	N	FLO

RESULT: PASS

Note: All the test modes had been tested, the mode 1 was the worst case. Only the data of the worst case would be record in this test report.



APPENDIX A: PHOTOGRAPHS OF TEST SETUP

RADIATED EMISSION TEST SETUP BELOW 1GHZ

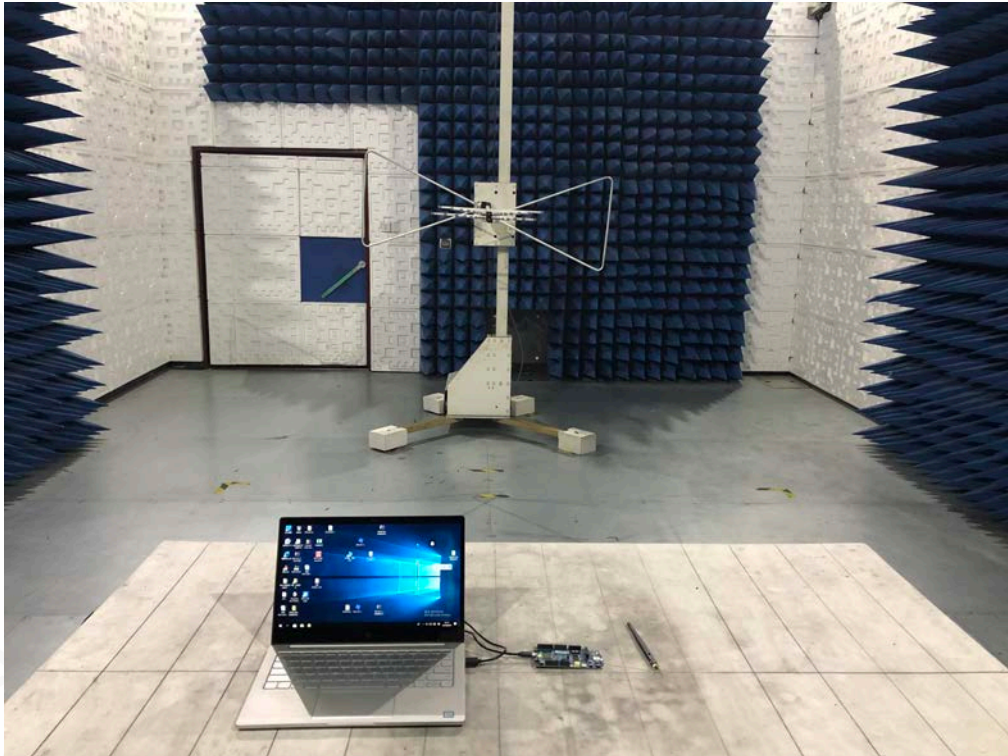

RADIATED EMISSION TEST SETUP ABOVE 1GHZ

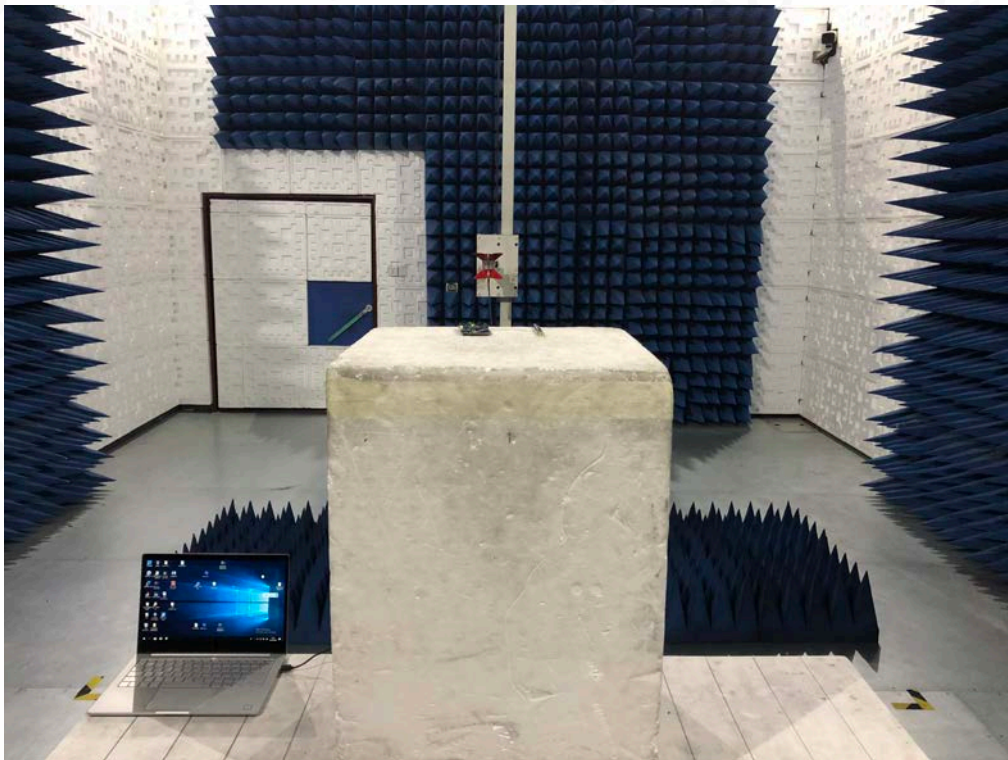

CONDUCTED EMISSION TEST SETUP



APPENDIX B: PHOTOGRAPHS OF EUT

TOP VIEW OF EUT

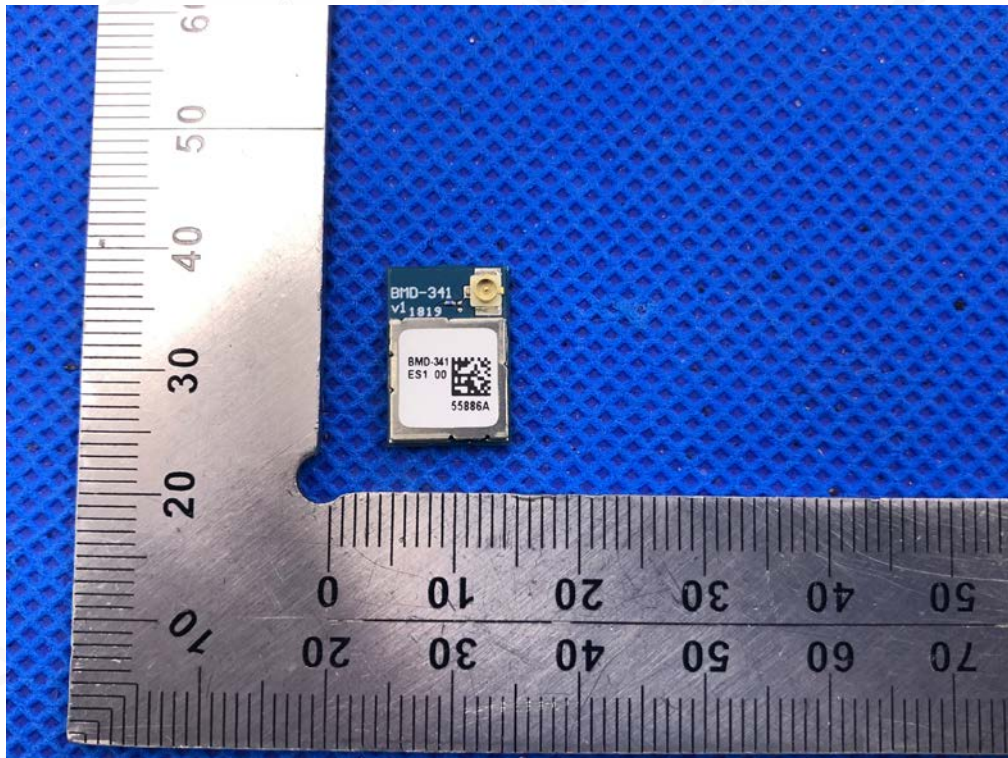

BOTTOM VIEW OF EUT

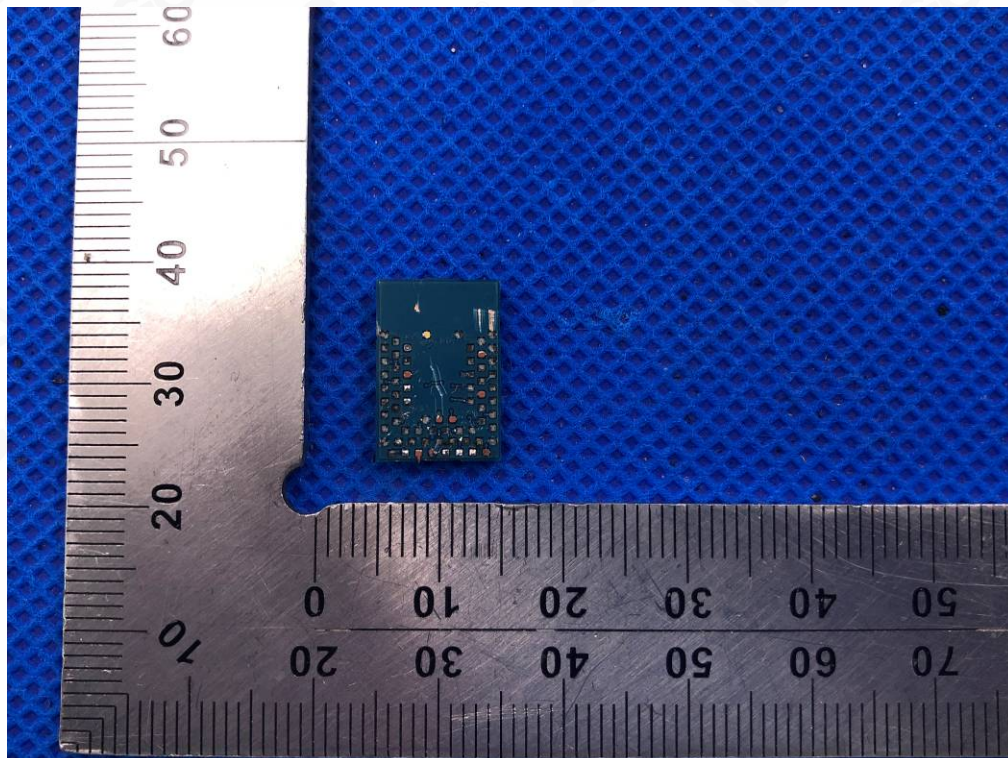

FRONT VIEW OF EUT

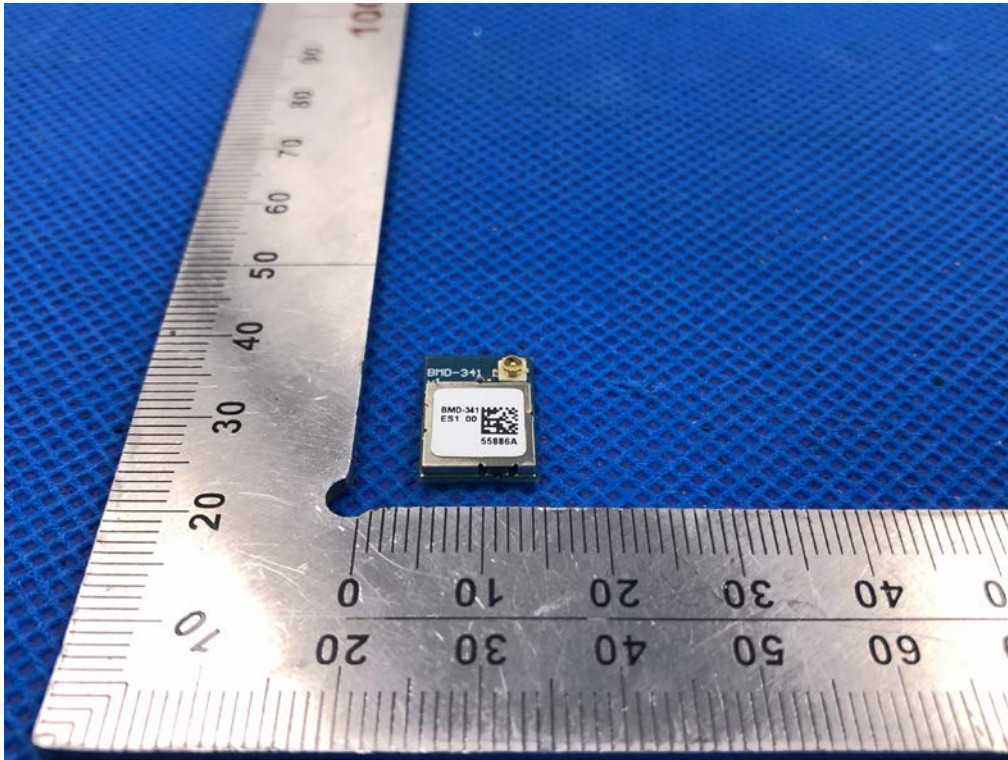

BACK VIEW OF EUT

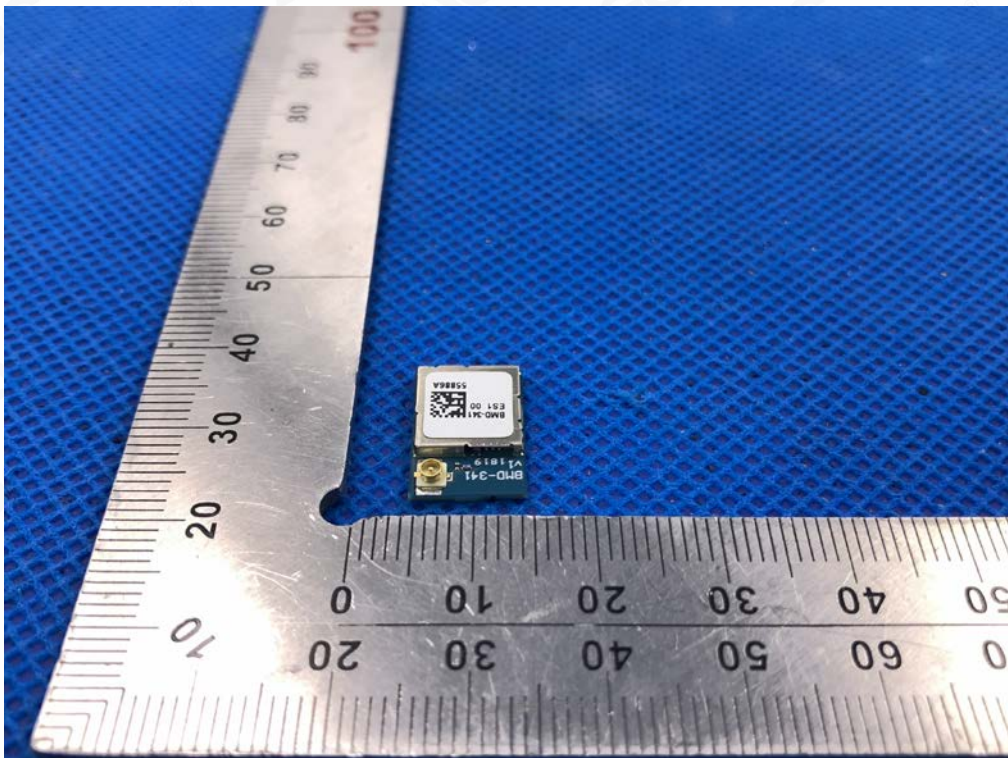

LEFT VIEW OF EUT

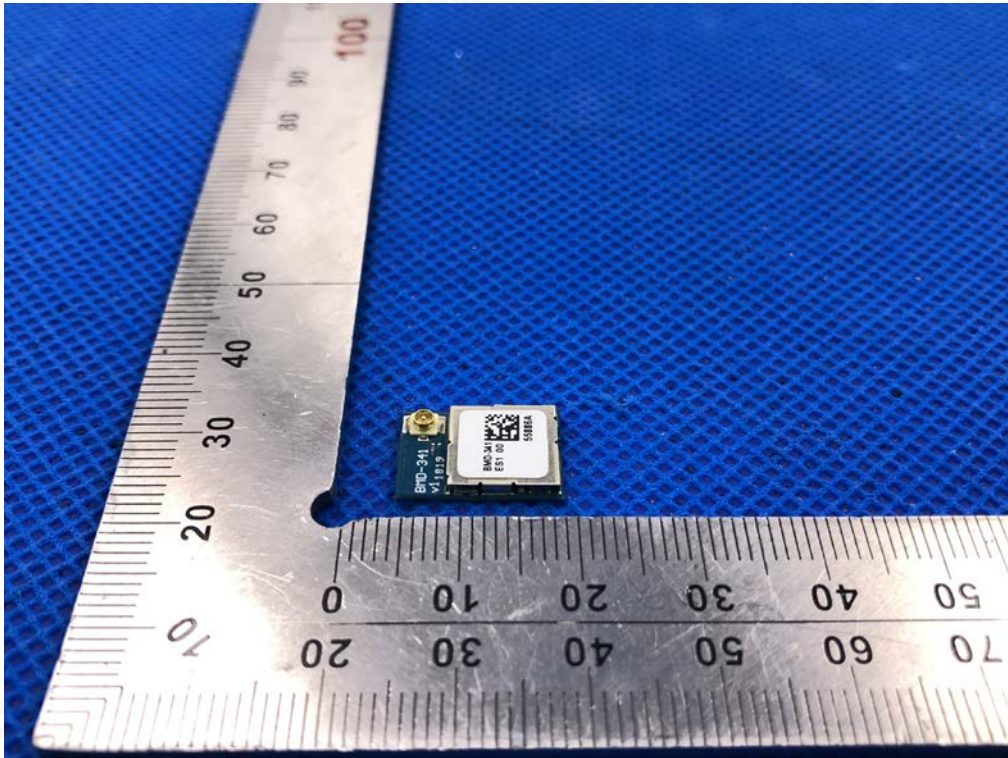

RIGHT VIEW OF EUT

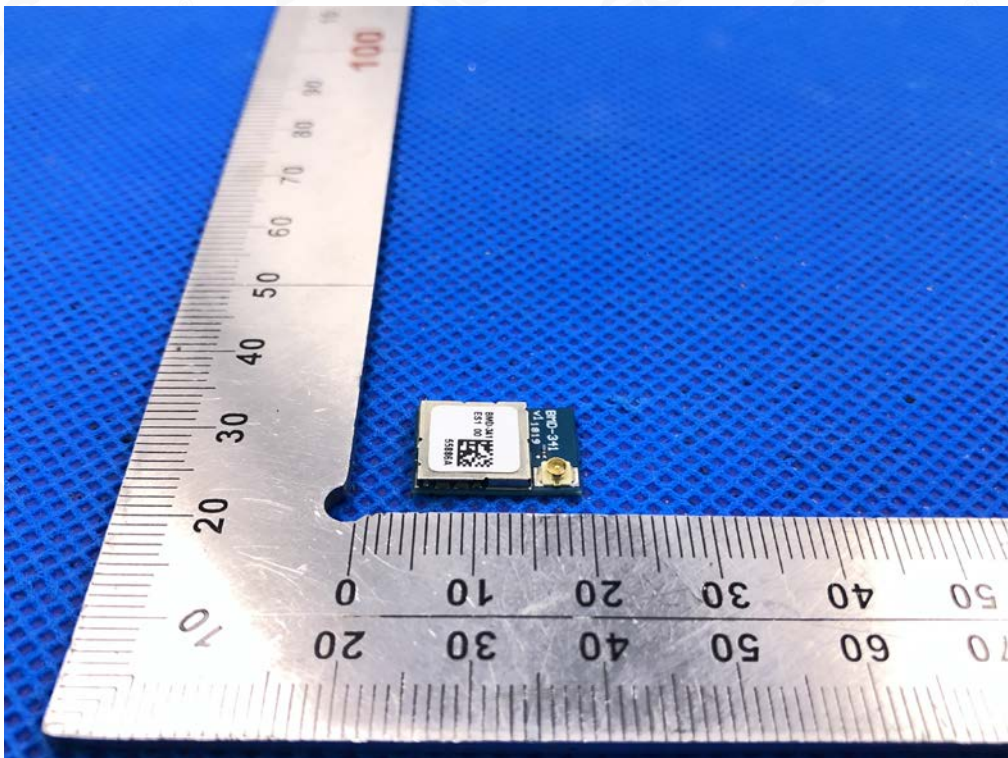

VIEW OF EXTERNAL ANTENNA 1

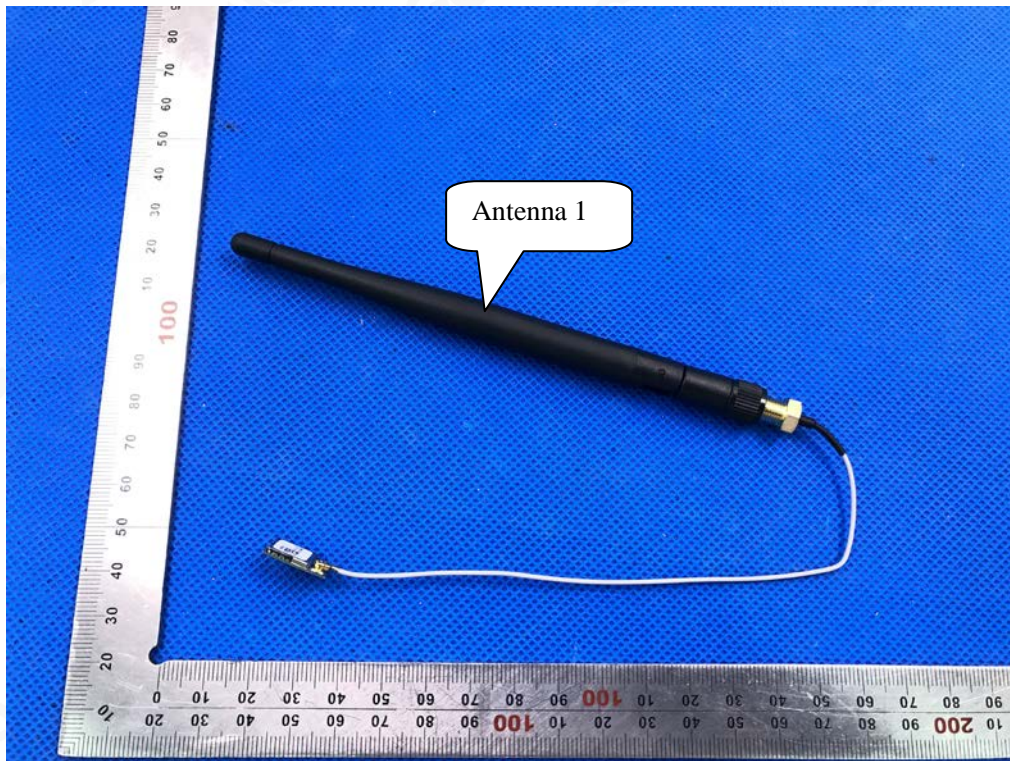

VIEW OF EXTERNAL ANTENNA 2

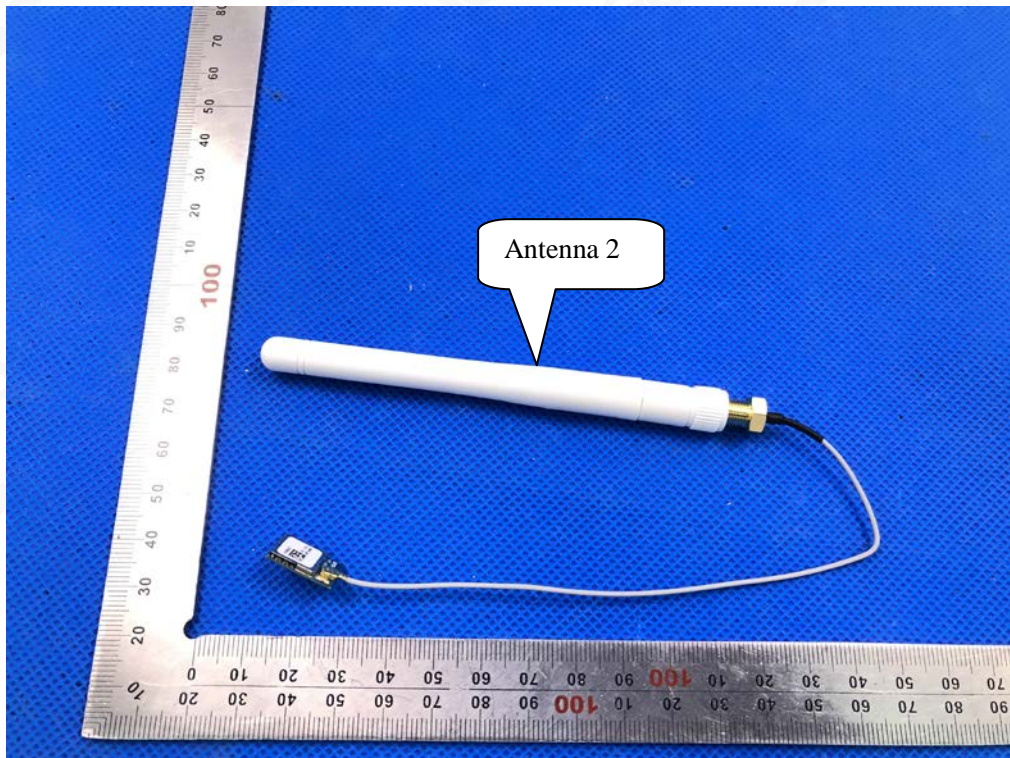

VIEW OF EXTERNAL ANTENNA 3

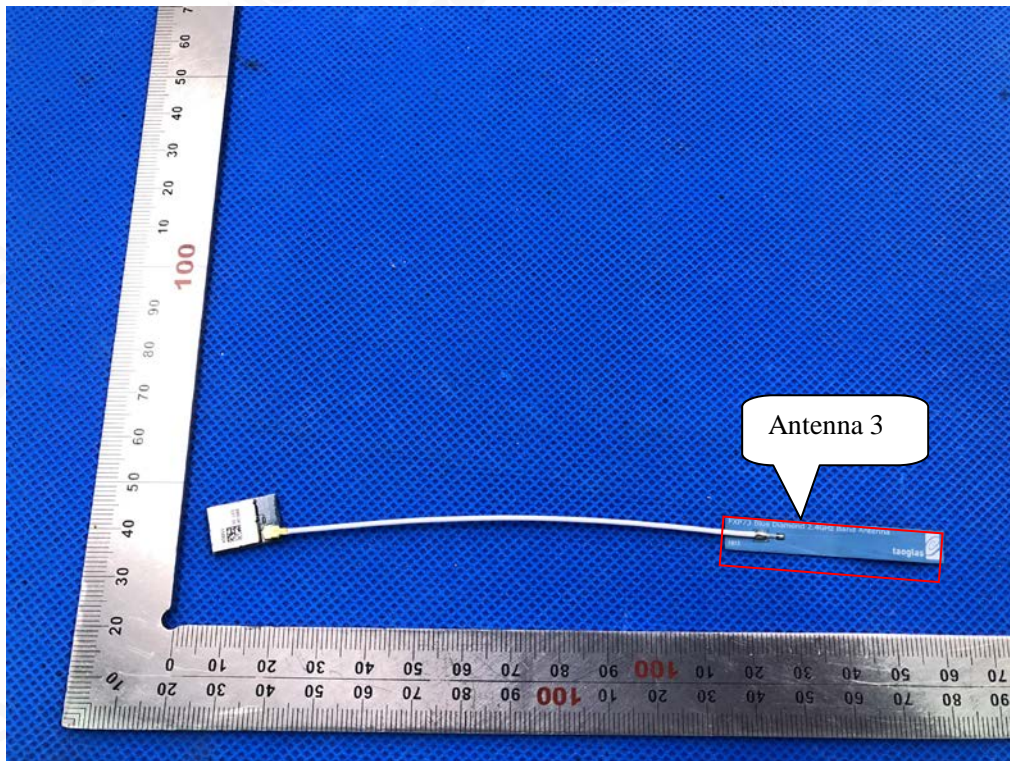

VIEW OF EXTERNAL ANTENNA 4

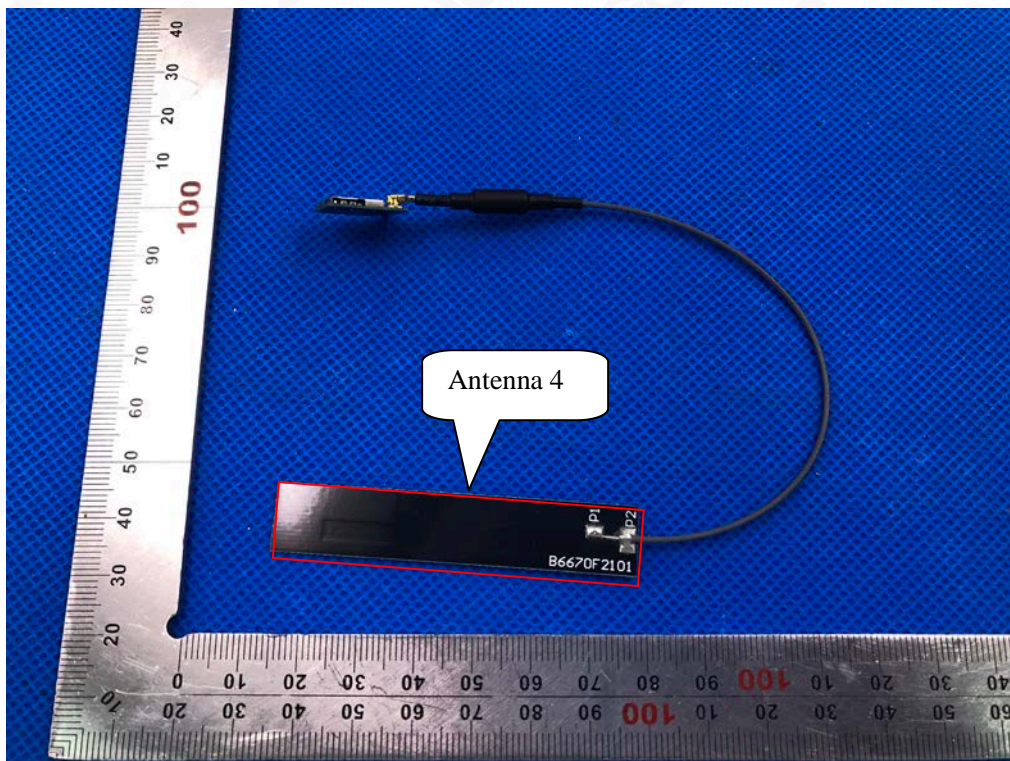

INTERNAL VIEW OF EUT

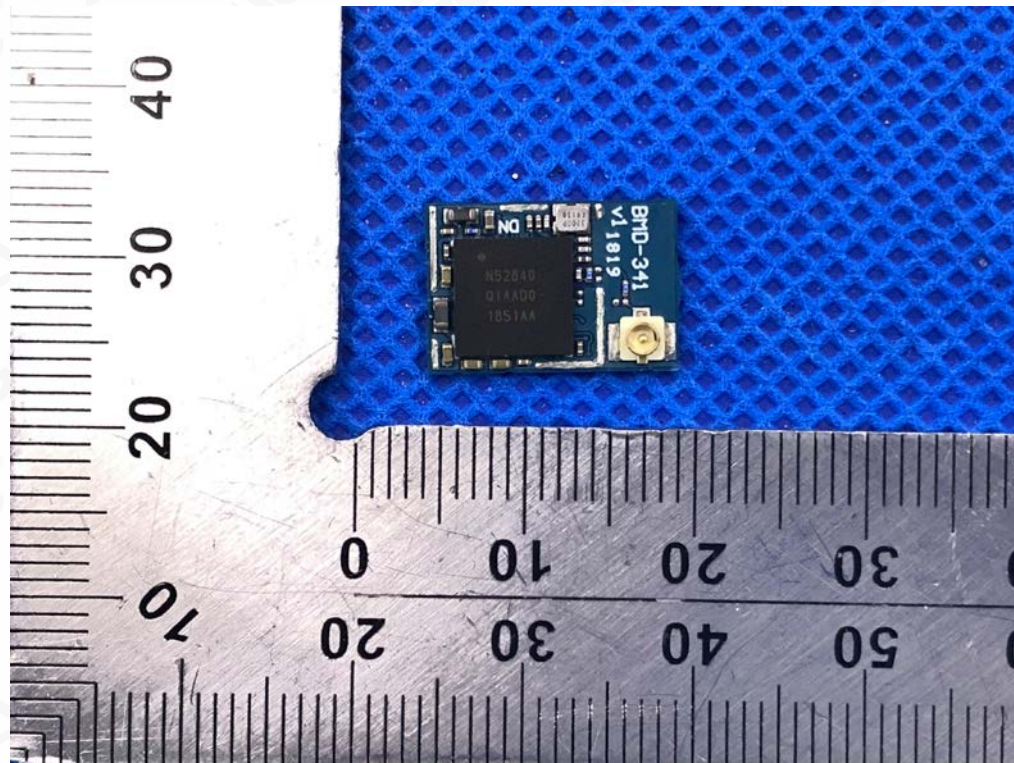

----END OF REPORT----

