

ANNA-B4 series

Stand-alone Bluetooth 5.1 low energy modules System integration manual

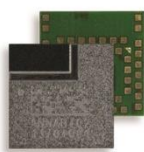

Abstract

This manual provides a functional overview combined with best-practice design guidelines for integrating ANNA-B4 stand-alone Bluetooth® 5.1 low energy modules in customer applications. ANNA-B402 provides an open CPU architecture with a powerful MCU for customer applications, while ANNA-B412 is delivered with pre-flashed u-connectXpress software. Targeted towards hardware and software application engineers, the document describes the hardware design-in, software, component handling, regulatory compliance, and testing of the module. It also includes list of approved external antennas for use with the module.

Document information

| | | |
|------------------------|--|-------------|
| Title | ANNA-B4 series | |
| Subtitle | Stand-alone Bluetooth 5.1 low energy modules | |
| Document type | System integration manual | |
| Document number | UBX-21000517 | |
| Revision and date | R03 | 28-Jan-2022 |
| Disclosure restriction | C1-Public | |

Document status explanation

| | |
|------------------------------|--|
| Draft | For functional testing. Revised and supplementary data will be published later. |
| Objective Specification | Target values. Revised and supplementary data will be published later. |
| Advance Information | Data based on early testing. Revised and supplementary data will be published later. |
| Early Production Information | Data from product verification. Revised and supplementary data may be published later. |
| Production Information | Document contains the final product specification. |

This document applies to the following products:

| Product name |
|--------------|
| ANNA-B412 |
| ANNA-B402 |

 For information about the related hardware, software, and status of listed product types, see also the respective data sheets [\[5\]](#) [\[6\]](#).

u-blox or third parties may hold intellectual property rights in the products, names, logos and designs included in this document. Copying, reproduction, modification or disclosure to third parties of this document or any part thereof is only permitted with the express written permission of u-blox.

The information contained herein is provided "as is" and u-blox assumes no liability for its use. No warranty, either express or implied, is given, including but not limited to, with respect to the accuracy, correctness, reliability and fitness for a particular purpose of the information. This document may be revised by u-blox at any time without notice. For the most recent documents, visit www.u-blox.com.

Copyright © u-blox AG.

Contents

| | |
|---|-----------|
| Document information | 2 |
| Contents | 3 |
| 1 Functional description | 6 |
| 1.1 Overview..... | 6 |
| 1.2 Example applications | 6 |
| 1.3 Product features | 7 |
| 1.4 Block diagrams | 8 |
| 1.5 Product description | 9 |
| 1.5.1 ANNA-B4..... | 9 |
| 1.6 Hardware options..... | 9 |
| 1.7 Software options..... | 9 |
| 1.7.1 Open CPU..... | 10 |
| 1.7.2 u-connectXpress software | 11 |
| 1.8 Pin configurations and functions | 11 |
| 2 System function interfaces | 12 |
| 2.1 Main supply input..... | 12 |
| 2.1.1 Digital I/O interfaces reference voltage (VCC_IO) | 12 |
| 2.2 Antenna interface..... | 12 |
| 2.2.1 ANNA-B4 integrated antenna | 13 |
| 2.2.2 Antenna connected to the antenna pin | 13 |
| 2.3 Module reset | 13 |
| 2.4 Internal temperature sensor..... | 13 |
| 2.5 Low power clock | 14 |
| 2.5.1 Internal oscillator | 14 |
| 2.5.2 External crystal | 14 |
| 2.5.3 External clock source, TCXO..... | 15 |
| 2.5.4 Selecting clock source | 15 |
| 2.6 Serial interfaces | 16 |
| 2.6.1 Universal asynchronous serial interface (UART) | 16 |
| 2.6.2 Serial peripheral interface (SPI) | 17 |
| 2.6.3 I2C interface (open CPU only)..... | 17 |
| 2.7 GPIO pins..... | 17 |
| 2.8 NFC interface..... | 18 |
| 2.8.1 Battery protection | 19 |
| 2.9 Debug interface..... | 19 |
| 2.9.1 Thermal guidelines | 19 |
| 2.10 Reserved pins (RSVD) | 19 |
| 2.11 ANNA-B1 to ANNA-B4 migration | 20 |
| 3 Design-in | 22 |
| 3.1 Overview..... | 22 |

| | | |
|----------|--|-----------|
| 3.2 | Antenna integration guidelines..... | 22 |
| 3.3 | Antenna connected through the RF pin..... | 23 |
| 3.3.1 | RF transmission line design | 24 |
| 3.3.2 | RF connector design | 25 |
| 3.4 | Supply interfaces | 26 |
| 3.4.1 | VCC application circuits | 26 |
| 3.5 | GND pins | 27 |
| 3.6 | General layout guidelines | 27 |
| 3.6.1 | Considerations for schematic design and PCB floor-planning | 27 |
| 3.6.2 | Layout and manufacturing | 27 |
| 3.6.3 | ESD guidelines..... | 28 |
| 3.7 | Design-in checklists | 29 |
| 3.7.1 | Schematic checklist..... | 29 |
| 3.7.2 | Layout checklist..... | 29 |
| 4 | Open CPU software | 30 |
| 4.1 | Zephyr | 30 |
| 4.1.1 | Getting started with Zephyr on the ANNA-B4 module..... | 30 |
| 4.1.2 | Board configuration in Zephyr | 30 |
| 4.1.3 | Building for ANNA-B402 EVK on the Zephyr command-line | 30 |
| 4.2 | Nordic nRF5 SDK | 30 |
| 4.2.1 | Getting started with the Nordic nRF5 SDK..... | 31 |
| 4.2.2 | Create a custom board support file for Nordic nRF5 SDK | 31 |
| 4.2.3 | Adding a board configuration to your project | 33 |
| 4.3 | Definition of Low Frequency clock source | 34 |
| 4.4 | Bluetooth device (MAC) address and other production data | 34 |
| 4.5 | Flashing open CPU software | 35 |
| 4.5.1 | Flashing over the SWD interface..... | 35 |
| 4.5.2 | Flashing over the UART interface | 35 |
| 5 | u-connectXpress software | 38 |
| 5.1 | Flashing ANNA-B412 u-connectXpress software..... | 38 |
| 5.1.1 | Updating over UART..... | 38 |
| 5.2 | Low frequency clock and autosense | 45 |
| 6 | Handling and soldering | 47 |
| 6.1 | ESD handling precautions..... | 47 |
| 6.2 | Packaging, shipping, storage, and moisture preconditioning | 47 |
| 6.3 | Soldering..... | 47 |
| 6.3.1 | Reflow soldering process | 48 |
| 6.3.2 | Cleaning..... | 49 |
| 6.3.3 | Potting and conformal coating | 49 |
| 6.3.4 | Other remarks | 49 |
| 7 | Qualifications and approvals | 50 |
| 7.1 | Country approvals..... | 50 |

| | | |
|----------|--|-----------|
| 7.2 | European Union regulatory compliance | 50 |
| 7.2.1 | Radio Equipment Directive (RED) 2014/53/EU | 50 |
| 7.2.2 | Compliance with the RoHS directive | 50 |
| 7.3 | FCC and IC compliance | 50 |
| | FCC compliance..... | 51 |
| 7.3.2 | RF-exposure statement | 52 |
| 7.3.3 | End product user manual instructions..... | 52 |
| 7.3.4 | End product labeling requirements | 53 |
| 7.3.5 | FCC and IC IDs | 54 |
| 7.3.6 | End product compliance..... | 54 |
| 7.4 | Japan radio equipment compliance..... | 55 |
| 7.4.1 | Compliance statement | 55 |
| 7.4.2 | End product labelling requirement..... | 55 |
| 7.4.3 | End product user manual requirement | 55 |
| 7.5 | NCC Taiwan compliance | 55 |
| 7.5.1 | Taiwan NCC Warning Statement..... | 55 |
| 7.5.2 | Labeling requirements for end product | 55 |
| 7.6 | KCC South Korea compliance..... | 56 |
| 7.7 | Brazil compliance | 56 |
| 7.8 | Australia and New Zealand regulatory compliance | 57 |
| 7.9 | South Africa regulatory compliance | 57 |
| 7.10 | Bluetooth qualification..... | 57 |
| 8 | Pre-approved antennas list..... | 59 |
| 8.1 | Approved antennas | 59 |
| 9 | Product testing | 62 |
| 9.1 | u-blox in-line production testing | 62 |
| 9.2 | OEM manufacturer production test | 63 |
| 9.2.1 | “Go/No go” tests for integrated devices | 63 |
| | Appendix | 64 |
| A | Glossary | 64 |
| B | Antenna reference designs | 66 |
| B.1 | Internal antenna reference design with module at PCB corner | 66 |
| B.2 | Internal antenna reference design with module along PCB edge | 68 |
| B.3 | Reference design for external antennas (U.FL connector) | 69 |
| B.4 | Examples of application ground plane miniaturizations | 70 |
| B.4.1 | Example application 1..... | 71 |
| B.4.2 | Example application 2..... | 73 |
| | Related documentation | 74 |
| | Revision history | 75 |
| | Contact..... | 76 |

1 Functional description

1.1 Overview

The ANNA-B4 series are small, stand-alone Bluetooth 5.1 Low Energy (LE) wireless module that are particularly suited for harsh professional environments.

Based on the Nordic Semiconductor nRF52833 chip that includes an integrated RF core and powerful Arm® Cortex®-M4 with FPU processor, ANNA-B4 operates in all Bluetooth 5.1 modes – as well as 802.15.4 (Thread and Zigbee) and Nordic proprietary modes (ANNA-B402 only).

Featuring Angle of Arrival (AoA) and Angle of Departure (AoD) transceivers, ANNA-B402 supports the Bluetooth 5.1 Direction Finding service. The service can for example be used for indoor positioning, wayfinding, and asset tracking.

ANNA-B4 modules need only a single supply voltage in the range of 1.7–3.6 V and, as the supply voltage level can also be used as the I/O reference level, can be easily integrated into simple, single voltage rail systems. The broad supply voltage range makes ANNA-B4 particularly useful in battery powered systems. To use the USB interface VBUS 5 V supply is required.

With the same physical size and mechanical design as the ANNA-B112 module, ANNA-B4 offers a natural upgrade path for existing ANNA-B1 applications. Four additional pins on ANNA-B4, included to increase the number of supported GPIOs module, can be conveniently accommodated within a common module footprint. ANNA-B4 also extends the operating temperature range to +105 °C, beyond the +85 °C specified for ANNA-B1.

[Table 1](#) describes the various models in the ANNA-B4 series.

| Model | Description |
|-----------|--|
| ANNA-B402 | ANNA-B4 open CPU module, that enables customer applications to run on the built-in Arm® Cortex®-M4 with FPU. Equipped with an integrated chip antenna but can also be used with an external antenna via the antenna pin. |
| ANNA-B412 | ANNA-B4 module with pre-flashed u-connectXpress software application. Equipped with an integrated chip antenna but can also be used with an external antenna via the antenna pin. |

Table 1: ANNA-B4 series models

See also the ANNA-B402 and ANNA-B412 data sheets [\[5\]](#) [\[6\]](#) and ANNA-B402 and ANNA-B412 product summaries [\[3\]](#) [\[4\]](#).

1.2 Example applications

The ANNA-B4 modules are applicable for a wide range of different applications:

- Industrial automation
- Smart buildings and cities
- Low power sensors
- Wireless-connected and configurable equipment
- Point-of-sales
- Health devices
- Real-time Location, RTLS
- Indoor positioning
- Asset tracking
- Wearables

1.3 Product features

| | ANNA-B402 | ANNA-B412 |
|-------------------------------------|----------------------------|-----------------|
| Grade | | |
| Automotive | | |
| Professional | • | • |
| Standard | | |
| Radio | | |
| Chip inside | nRF52833 | nRF52833 |
| Bluetooth qualification | v5.1 | v5.1 |
| Bluetooth low energy | • | • |
| Thread / Zigbee | • | |
| Bluetooth output power EIRP [dBm] * | 9 / 13 | 9 / 13 |
| Max range [meters] * | 600 / 700 | 600 / 700 |
| NFC | • | • |
| Antenna type (see footnotes) | chip / pin | chip / pin |
| Application software | | |
| | Open CPU for embedded apps | u-connectXpress |
| Interfaces | | |
| UART | ♦ | 2 |
| SPI | ♦ | |
| I2C | ♦ | |
| I2S | ♦ | |
| USB | ♦ | |
| PDM and PWM | ♦ | |
| GPIO pins | 33 | 19 |
| AD converters [number of bits] | 12 | |
| Features | | |
| MCU (see footnotes) | M4F | |
| RAM [kB] | 128 | |
| Flash [kB] | 512 | |
| Simultaneous GATT server and client | ♦ | • |
| Throughput [Mbit/s] | 1.4 | 0.8 |
| Maximum Bluetooth connections | 20 | 8 |
| Bluetooth mesh | ♦ | ** |
| Bluetooth long range | | • |
| Direction finding (AoA / AoD) | ♦ | ** |
| FOTA | ♦ | |
| Low Energy Serial Port Service | | • |
| Secure boot | ♦ | • |

pin = Antenna pin

chip = internal chip antenna

* = The different values are for use with internal / external antennas

** = Available on request. Contact us.

M4F = 64 MHz Arm® Cortex-M4 with FPU

♦ = Feature enabled by hardware; support depends on the open CPU application software

Figure 1: ANNA-B4 series main features summary

1.4 Block diagrams

A block diagram of the ANNA-B4x2 module is shown in [Figure 2](#).

Not all interfaces are supported by the u-connectXpress software in ANNA-B412 variants. For information about the interfaces supported specifically in ANNA-B412, see also the ANNA-B412 data sheet [\[6\]](#).

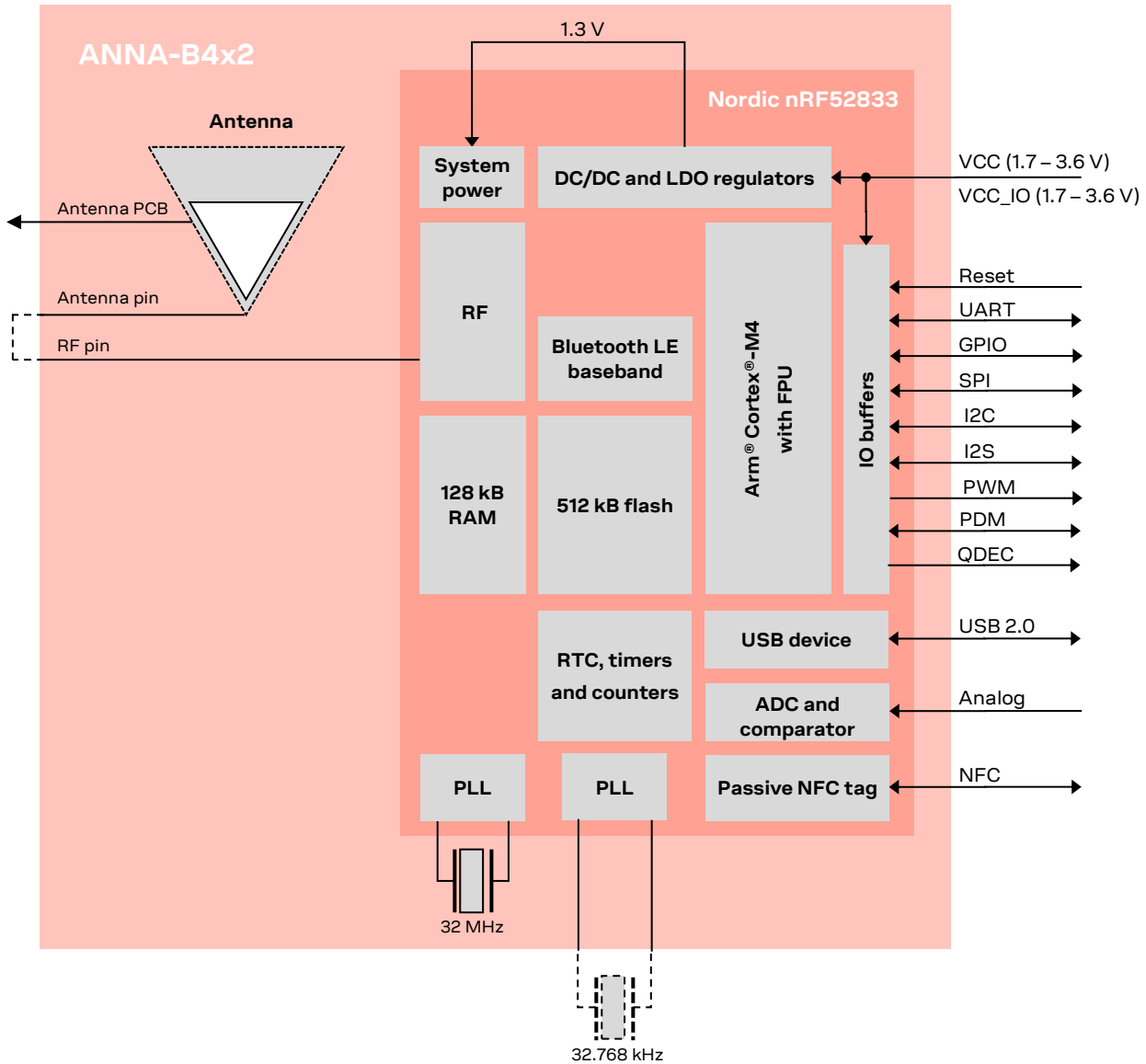

Figure 2: ANNA-B4x2 block diagram

The ANNA-B4 System in Package (SiP) module has an integrated antenna. The “RF pin” can either be connected directly to the adjacent “Antenna pin” to use the internal antenna. Otherwise, it can be routed to an external antenna or antenna connector. When using the internal antenna, a counterpoise trace must be routed on the main PCB and connected to “Antenna PCB” pin.

To achieve the lowest possible power consumption in stand-by mode ANNA-B4 has the possibility to connect an optional external 32.768 kHz LPO crystal or oscillator.

1.5 Product description

1.5.1 ANNA-B4

| Item | ANNA-B402 / ANNA-B412 |
|--|--|
| Bluetooth version | 5.1 |
| Band support | 2.4 GHz, 40 channels |
| Typical conducted output power | +8 dBm |
| Max radiated output power with internal antenna (EIRP) | +9 dBm |
| Max radiated output power with external antenna (EIRP) | +13 dBm (pending certification) |
| RX sensitivity (conducted) | -94 dBm |
| RX sensitivity, long range mode (conducted) | -103 dBm |
| Supported 2.4 GHz radio modes | Bluetooth Low Energy IEEE 802.15.4 (ANNA-B402 only) Proprietary 2.4 GHz modes (ANNA-B402 only) |
| Supported Bluetooth LE data rates | 1 Mbps 2 Mbps 500 kbps 125 kbps |
| Module size | 6.5 x 6.5 x 1.2 mm |

Table 2: ANNA-B4 series characteristics summary

For more information about each module variant, see also the ANNA-B402 [5] and ANNA-B412 [6] data sheets.

1.6 Hardware options

ANNA-B402 and ANNA-B412 modules have identical hardware architecture and design. Both module variants are based on the Nordic Semiconductor nRF52833 System on Chip (SoC).

1.7 Software options

ANNA-B4 modules are integrated with an Arm® Cortex®-M4 application processor with FPU, 512 kB flash memory and 128 kB RAM.

The structure of any software running on either ANNA-B4 module variant includes the following components:

- Radio stack
- Bootloader (optional)
- Application

The fundamental differences in the software implantation of the two module variants include:

- ANNA-B402 modules host the customer application and optional bootloader software, developed using the Nordic SDK, in an open-CPU configuration on the module. See also [Open CPU](#).
- ANNA-B412 modules are pre-flashed with a secure bootloader and u-connectXpress software that interfaces through an AT command interpreter to control customer application software running on host MCUs. See also [u-connectXpress software](#).
- Both module variants include the Nordic S140 SoftDevice Bluetooth Low Energy protocol stack that supports GATT server and client, central and peripheral roles, and multidrop connections.

Figure 3 shows the software architecture and implementation of software components for ANNA-B402 and ANNA-B412 modules.

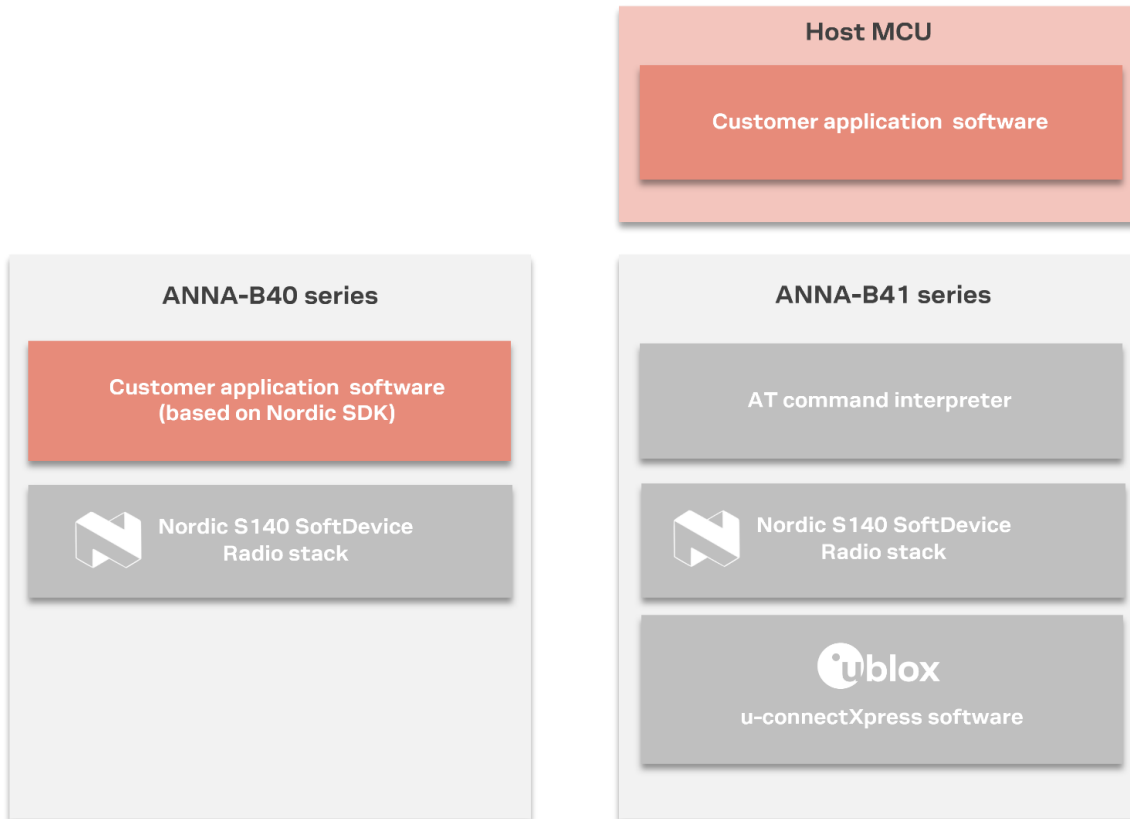

Figure 3: ANNA-B4 software structure

1.7.1 Open CPU

The open CPU architecture of ANNA-B402 series modules allows module integrators to build their own applications. Table 3 describes the possible connectivity and application support for recommended Nordic SDK environments in ANNA-B40 hardware. See also [Open CPU software](#).

| Feature | Support |
|-------------------------|--|
| Development environment | Nordic SDK (including Bluetooth Mesh, HomeKit, AirFuel, IoT, Thread, Zigbee) |
| HW interfaces | 2 x UART |
| | 4 x SPI |
| | 33 x GPIO pins |
| | 8 x ADC channels |
| | 1 x USB |
| | 2 x I2C |
| | 1 x I2S |
| | 4 x PWM |
| | 1 x QDEC |
| Security | Secure boot ready |
| | Secure Simple Pairing |
| | 128-bit AES encryption |
| | Bluetooth low energy secure connections |

Table 3: Open CPU software support

See also [Open CPU software](#).

1.7.2 u-connectXpress software

ANNA-B412 modules are pre-flashed with u-connectXpress and bootloader software, which interfaces through an AT command interpreter to control customer application software running on host MCUs. [Table 4](#) describes the feature support in the u-connectXpress software.

| Feature | Support |
|-------------------------------|---|
| Bluetooth | u-blox Low Energy Serial Port Service (SPS) |
| | GATT server and client using AT commands |
| | Beacons |
| | 1 + 2 Mbit/s modulation |
| | 125 Kbit/s modulation long range functionality |
| | Advertising extensions |
| Configuration over air | Wireless transmission of AT commands to control the module |
| Extended Data Mode™ | For simultaneous AT commands and data, and multiple simultaneous data streams |
| HW interfaces | 2 x UART, 19 x GPIO |
| Configuration | AT commands |
| Support tools | s-center |
| Operating modes | Central role (7 simultaneous links) |
| | Peripheral role (6 simultaneous links) |
| | Simultaneous central and peripheral roles (8 in total, where max 4 as peripheral and max 7 as central) |
| | LE 1M PHY |
| | LE 2M PHY |
| | LE CODED PHY |
| | Advertising extensions |
| | LE data length extension |
| | Bluetooth mesh (Available on request. Contact us.) |
| | Direction finding (AoA / AoD) (Available on request. Contact us.) |
| Security | Secure boot |
| | Secure Simple Pairing |
| | 128-bit AES encryption |
| | Bluetooth low energy secure connections |
| Throughput over UART | 780 Kbit/s |

Table 4: u-connectXpress software support

See also [u-connectXpress software](#).

1.8 Pin configurations and functions

For information about pin configuration and functions, see the ANNA-B402 and ANNA-B412 data sheets [\[5\]](#) [\[6\]](#).

2 System function interfaces

2.1 Main supply input

The power for ANNA-B4 modules is provided through the VCC pins. ANNA-B4 uses an integrated DC/DC converter to transform the supply voltage presented at the **VCC** pin into a stable system core voltage. This makes ANNA-B4 modules compatible for use in battery-powered designs.

The VCC supply can be taken from any of the following sources:

- Switched Mode Power Supply (SMPS)
- Low Drop Out (LDO) regulator
- Battery

When using ANNA-B4 with a battery, it is important that the chosen battery can handle the peak power of the module. In case of battery supply, consider adding extra capacitance on the supply line to avoid capacity degradation. For information about voltage supply requirement and current consumption, see also the respective ANNA-B402 [5] and ANNA-B412 data sheets [6].

2.1.1 Digital I/O interfaces reference voltage (VCC_IO)

On ANNA-B4 modules, the I/O voltage level is the same as the supply voltage and **VCC_IO** is internally connected to the supply input **VCC**.

When using ANNA-B4 with a battery, the I/O voltage level varies with battery output voltage. The battery voltage depends on the battery “state of charge”. Level shifters might be needed to stabilize the voltage – depending on the I/O voltage of the host system and interfacing components.

2.2 Antenna interface

ANNA-B4 is equipped both with an integrated chip antenna and an RF pin. The integrated chip antenna makes ANNA-B4 suitable for a minimum sized application product. The RF pin enables use of other antenna types. This could be either an antenna placed on the main PCB or an external antenna.

ANNA-B4 supports the following antenna types:

- Integrated antenna included in ANNA-B4 SiP. The integrated antenna requires an external counterpoise trace on the main PCB.
- Integrated antenna on the main PCB. Typically, a SMD antenna mounted on the main PCB, which is connected to the ANNA-B4 RF pin through a transmission line.
- External Antenna. Typically, a dipole antenna connected to the ANNA-B4 RF pin through a coaxial cable and U.FL connector on the main PCB.

Table 5 describes how the related pins shall be connected for each antenna solution

| Pin | External antenna, or integrated antenna on main PCB | ANNA-B4 integrated antenna. ANNA-B4 placed in the corner of the main PCB | ANNA-B4 integrated antenna. ANNA-B4 placed along the side of the main PCB |
|-----------------|---|--|---|
| Pin 1 – ANT_PCB | GND* | GND pattern | NC |
| Pin 2 – ANT_GND | GND | NC | GND pattern |
| Pin 3 – ANT_GND | GND | NC | GND pattern |
| Pin 5 – ANT_INT | GND* | Connect to pin 6 – ANT | Connect to pin 6 – ANT |
| Pin 6 – ANT | Connect to antenna or antenna connector | Connect to pin 5 – ANT_INT | Connect to pin 5 – ANT_INT |

*Connect to GND for better layout, not critical for function

Table 5: ANNA-B4 Antenna options

-  When integrating the u-blox reference design into an end-product, the application designer is solely responsible for any unintentional emission levels produced by the end-product.

2.2.1 ANNA-B4 integrated antenna

-  ANNA-B4 is pre-certified with the integrated antenna. To take advantage of this certification, the module must be integrated in strict accordance with the [ANNA-B4 Antenna reference design](#).

When including ANNA-B4 with an integrated antenna into the application design, the reference design must be followed precisely to reach full radiated performance. The reference design defines where to position ANNA on the main PCB and describes how to route the counterpoise antenna trace.

Although an integrated antenna can be placed in either the corner or along the edge of the application board, a corner location offers slightly better antenna performance.

2.2.2 Antenna connected to the antenna pin

This section describes the integration of any antenna connected to the RF pin, external antenna, or integrated antenna on the main PCB.

ANNA-B4 is equipped with an RF pin for connection of an antenna when the antenna integrated in ANNA-B4 is not the preferred antenna option. The RF pin has a nominal characteristic impedance of 50 Ω and must be connected to the antenna through a 50 Ω transmission to reach full performance. In this way, the transmission of incoming and outgoing radio frequency (RF) signals is optimized in the 2.4 GHz frequency band.

Choose an antenna with optimal radiating characteristics for the best electrical performance and overall module functionality. Use either an internal antenna integrated on the main PCB or an external antenna connected to the main PCB through a 50 Ω connector.

When using an external antenna, the PCB-to-RF cable transition must be implemented using either a suitable 50 Ω connector or an RF-signal solder pad (including GND) that is optimized for 50 Ω characteristic impedance.

2.2.2.1 Approved antenna pin designs

ANNA-B4 module is pre-certified together with external antennas. The external antenna is in this design connected to the RF pin via a U.FL connector. The connection between the RF pin and U.FL connector is routed with a 50 ohm transmission line. It is advised to implement this reference design in the application product to save costs and time during the certification process when implementing an external antenna. See also the [Pre-approved antennas list](#).

This reference design is described in Appendix [B.3](#).

The module may be integrated with other antennas. In which case, the OEM installer must certify his design with respective regulatory agencies.

2.3 Module reset

ANNA-B4 series is reset by applying a low level on the **RESET_N** input pin, which is normally set high with an internal pull-up. A low logic level on this pin initiates an “external” or “hardware” reset of the module. The prevailing parameter settings at the time of the reset are not saved in the non-volatile memory of the module and a proper network detach is not performed.

2.4 Internal temperature sensor

The radio chip in the ANNA-B4 series module contains a temperature sensor that is primarily used for over-temperature and under-temperature shutdown.

-  As the temperature sensor is embedded in the radio chip, any intensive processing can cause extra heat and impact the measurement accuracy. An external sensor is required if more accurate monitoring of the surrounding area is necessary.

2.5 Low power clock

ANNA-B4 uses a 32.768 kHz low power clock to enable different power modes: active, sleep, and standby. For further information about power modes, see also the ANNA-B412 data sheet [\[6\]](#).

The clock can be generated from either of the following internal or external clock sources:

- Internal oscillator
- External crystal
- External clock source, TCXO

The u-connectXpress software automatically senses the clock input and uses the source from the external crystal – if one is available. Otherwise, the software uses the source from the internal oscillator. This automatic sense functionality adds some additional time during startup (~1 s).

To get the lowest possible current consumption of the ANNA-B4 module in sleep mode, an external crystal or external clock source is needed. If an external crystal or external clock source is not connected, the internal oscillator must be used instead. The lower accuracy of the internal oscillator means that the module must perform a calibration at specific intervals, which causes the current consumption to increase in sleep mode.

For further information about the different hardware options for the low-power clock source and the implications those choices have on both the cost and performance of the ANNA-B4 module, see also [Internal oscillator](#), [External crystal](#), [External clock source, TCXO](#), and [Selecting clock source](#).

-  For practical guidance on how to configure the oscillator on nRF5 open CPU modules, see the related application note [\[8\]](#).

-  An external crystal is also required by some third-party software, like Wirepas Massive.

2.5.1 Internal oscillator

When using the internal oscillator, clock pins **XL_1** and **XL_2** should be connected to ground, as shown in [Figure 4](#).

-  To ensure +/-250 ppm clock stability, open-CPU application software must be configured to check the calibration of the internal oscillator at least once every 8 seconds. This configuration is fixed in u-connectXpress software.

-  The use of an internal oscillator with ANNA-B4 can minimize the Bill of Materials (BOM) and reduce the associated production costs of the end product. But, it can also increase power consumption in standby mode.

2.5.2 External crystal

ANNA-B4 has two input pins for connecting an external crystal as the source for the low-power clock. The use of an external crystal allows ANNA-B4 to run with the lowest overall power consumption.

Figure 4 shows the low-power clock components used on the EVK-ANNA-B4 evaluation board.

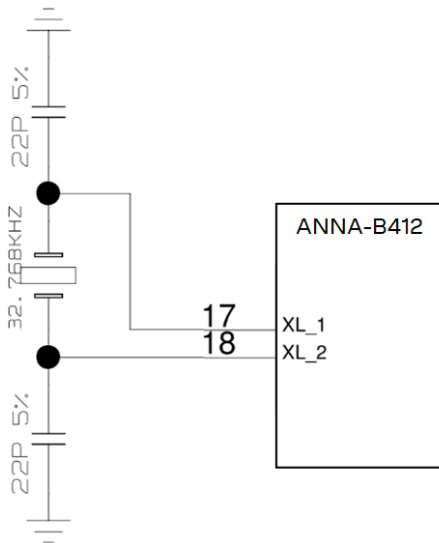

Figure 4: Connecting ANNA-B412 to an external crystal oscillator

| Component | Value | Note |
|--------------------|---------------------|----------------------------------|
| Crystal oscillator | 32.768 kHz (20 ppm) | EPSON FC-12M used on ANNA-B4 EVK |
| Capacitors | 22 pF | |

Table 6: Components used on the EVK-ANNA-B4 EVK evaluation board

2.5.3 External clock source, TCXO

An external clock can be supplied from various sources, including a temperature-compensated crystal oscillator (TCXO) or host CPU. The clock signal can be either low-swing or full-swing.

The electrical parameters for a suitable low-swing clock are described in Table 7.

| Pin name | Parameter | Min | Typ | Max | Unit | Remarks |
|----------|---|-----|-----|------|------|---|
| XL1 | Input characteristic: Peak to Peak amplitude | 200 | | 1000 | mV | Input signal must not swing outside supply rails. |
| XL2 | - | - | | - | - | Connect to GND |

Table 7: Electrical parameters for a low-swing clock

The electrical parameters for a suitable full-swing clock are described in Table 8.

| Pin name | Parameter | Min | Typ | Max | Unit | Remarks |
|----------|---|---------|-----|---------|------|-------------------------------------|
| XL1 | Input characteristic: Low-level input | 0 | | 0.3*VCC | V | |
| | Input characteristic: high-level input | 0.7*VCC | | VCC | V | |
| XL2 | - | - | - | - | - | Connect to GND or leave unconnected |

Table 8: Electrical parameters for a full-swing clock

2.5.4 Selecting clock source

With reference to the electrical parameters described in Table 8, note that the choice of clock source is invariably a tradeoff between the current consumption and BOM count of the application design. When using an internal oscillator, the expected increase in current consumption is dependent on the software settings and the surrounding application environment.

Depending on the software settings, the internal oscillator itself adds ~400 nA to the current consumption and the calibration of the oscillator adds another ~1 μA . The standby current of ANNA-B4 then increases from 2.2 μA to 3.6 μA , which is an increase of ~60%. For information about the possible settings using open CPU software, see also the application note RC oscillator configuration for nRF5 open CPU modules [8].

 Low Frequency Clock settings are fixed for use with u-connectXpress software.

For applications where only the active mode is used, and the module never or rarely is in standby, the increase of current is negligible.

If the application is expected to be in standby for longer periods of time and it is powered from a battery, it might be worth adding an external crystal.

Table 9 shows the average current consumption for a beacon advertising at different intervals, when using an external crystal oscillator versus when using the internal oscillator. The use case shown here is based on an advertisement event (4.7 ms) that is broadcast with +4 dBm output power, 31 bytes, and 3.3 V payload.

| Advertise interval | External crystal oscillator | Internal oscillator | Increase in current |
|--------------------|-----------------------------|---------------------|---------------------|
| 1 s | 18 μA | 19.5 μA | 8 % |
| 10 s | 3.8 μA | 5.2 μA | 37 % |
| 60 s | 2.4 μA | 3.9 μA | 63 % |

Table 9: Average current consumption with/without external low power crystal (theoretical calculations)

2.6 Serial interfaces

The pin mapping of the supported interfaces is dependent on whether ANNA-B4 is used with u-connectXpress software or an open CPU based application. See also the ANNA-B402 [5] and ANNA-B412 [6] data sheets.

2.6.1 Universal asynchronous serial interface (UART)

ANNA-B4 series modules provide a Universal Asynchronous Serial Interface (UART) for data communication.

The following UART signals are available:

- Data lines (**RXD** as input, **TXD** as output)
- Hardware flow control lines (**CTS** as input, **RTS** as output)
- **DSR** and **DTR** are used to set and indicate system modes

The UART can be used as a 4-wire UART with hardware flow control or 2-wire UART with only **TXD** and **RXD**. In 2-wire mode, **CTS** should be connected to GND on the ANNA-B4 module.

The bootloader delivered with the product, either u-connectXpress bootloader or the Nordic DFU bootloader for open CPU modules, can be used to upgrade the software over the UART interface.

See also [Flashing over the UART interface](#) and [Flashing ANNA-B412 u-connectXpress software](#).

The u-connectXpress software adds the **DSR** and **DTR** pins to the UART interface. These pins are not used as originally intended but are used instead to control the state of the ANNA-B412 module.

Depending on the configuration of u-connectXpress, the **DSR** can be used to:

- Enter command mode
- Disconnect and/or toggle connectable status
- Enable/disable the rest of the UART interface
- Enter/wake up from the sleep mode

For more information about the UART interface characteristics, see also the ANNA-B402 and ANNA-B412 data sheet [5] and [6].

| Interface | Default configuration |
|-----------|--|
| COM port | 115200 baud, 8 data bits, no parity, 1 stop bit, hardware flow control |

Table 10: Default settings for the COM port while using the u-connectXpress software

It is advisable to make the UART available as either test points or as available through a connected header for software upgrade.

The IO level of the UART follows the VCC voltage and can subsequently in the range of 1.8–3.6 V. If you are connecting the ANNA-B4 module to a host with a different voltage on the UART interface, a level shifter should be used.

2.6.2 Serial peripheral interface (SPI)

The ANNA-B4 series supports up to four serial peripheral interfaces that can operate in both master and slave modes with a maximum serial clock frequency of 8 MHz in both these modes.

The SPI interfaces use the four following signals:

- SCLK
- MOSI
- MISO
- CS

When using the SPI interface in master mode, it is possible to use GPIOs as additional Chip Select (CS) signals to allow addressing of multiple slaves.

2.6.3 I2C interface (open CPU only)

The Inter-Integrated Circuit (I2C) interfaces can be used to transfer or receive data on a 2-wire bus network. The ANNA-B4 series contains up to two I2C bus interfaces and can operate as both master and slave using both standard (100 kbps) and fast (400 kbps) transmission speeds. The interface uses the **SCL** signal to clock instructions and data on the **SDL** signal.

External pull up resistors are required for the I2C interface. The value of the pull-up resistor should be selected depending on the speed and capacitance of the bus.

2.7 GPIO pins

ANNA-B4 series modules can provide up to 33 pins, which can be configured as general-purpose input or output. Eight GPIO pins are capable of handling analog functionality. All pins are capable of handling interrupt.

| Function | Description | Default ANNA-B4 pin | Configurable GPIOs |
|--------------------------|--|---------------------|--------------------|
| General purpose input | Digital input with configurable edge detection and interrupt generation. | | Any |
| General purpose output | Digital output with configurable drive strength, pull-up, pull-down, open-source, open-drain and/or slew rate. | | Any |
| Pin disabled | Pin is disconnected from input buffers and output drivers. | All* | Any |
| Timer/ counter | High precision time measurement between two pulses/ Pulse counting with interrupt/event generation. | | Any |
| Interrupt/ Event trigger | Interrupt/event trigger to the software application/ Wake up event. | | Any |

| Function | Description | Default ANNA-B4 pin | Configurable GPIOs |
|------------------------------|---|---------------------|--------------------|
| ADC input | 8/10/12-bit analog to digital converter | | Any analog |
| Analog comparator input | Compare two voltages, capable of generating wake-up events and interrupts | | Any analog |
| PWM output | Output complex pulse width modulation waveforms | | Any |
| Connection status indication | Indicates if a Bluetooth LE connection is maintained | BLUE** | Any |

* = If left unconfigured ** = If using u-connectXpress software. For pin number, see also the ANNA-B412 data sheet [6].

Table 11: GPIO custom functions configuration

2.8 NFC interface

Figure 5 shows some important aspects of the NFC antenna design, where:

- The NFC antenna coil must be connected differentially between the **NFC1** and **NFC2** pins of the device.
- Two external capacitors should be used to tune the resonance of the antenna circuit to 13.56 MHz.

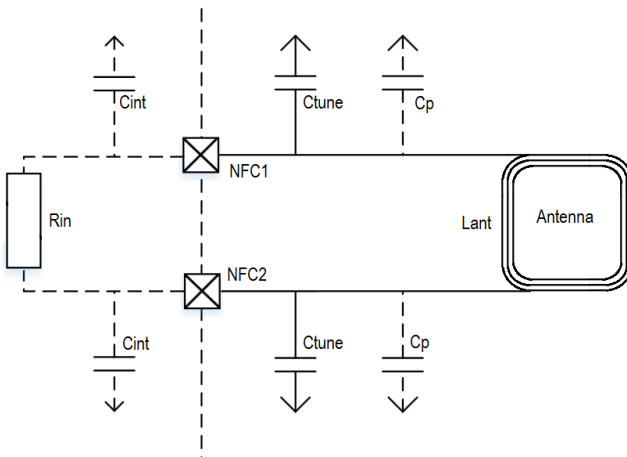

Figure 5: NFC antenna design

The value of the required tuning capacitors (C_{tune}) is calculated with the two equations shown below. An antenna inductance of $L_{ant} = 2 \mu\text{H}$ gives tuning capacitors in the range of 130 pF on each pin. For good performance, match the total capacitance on NFC1 and NFC2.

$$C'_{tune} = \frac{1}{(2\pi \times 13.56 \text{ MHz})^2 L_{ant}} \text{ where } C'_{tune} = \frac{1}{2} \times (C_p + C_{int} + C_{tune})$$

$$C_{tune} = \frac{2}{(2\pi \times 13.56 \text{ MHz})^2 L_{ant}} - C_p - C_{int}$$

- As the pins for the NFC interface in ANNA-B402 series modules can be used as normal GPIOs, it is important that all NFC pins are correctly configured in the software. Connecting an NFC antenna to pins that are configured for GPIO might damage the module. In ANNA-B412 series modules, NFC pins are always set to "NFC mode".

ANNA-B4 modules have been tested with a 3 x 3 cm PCB trace antenna, so it is advisable to keep these measurements as closely as possible to antenna design. You can still use a smaller or larger antenna if it is tuned to resonate at 13.56 MHz. To comply with European regulatory demands, the NFC antenna must be placed in such a way that the space between the ANNA-B4 module and the remote NFC transmitter is always within three meters during transmission.

2.8.1 Battery protection

If the antenna is exposed to a strong NFC field, parasitic diodes and unintended ESD structures can cause the current to flow in the opposite direction of the supply.

If the battery used does not tolerate a return current, protect the battery with a series diode placed between the battery and the device.

2.9 Debug interface

ANNA-B402 modules support Serial Wire debug (SWD) and Serial Wire Viewer, but not JTAG debug.

When designing your application with the ANNA-B402, the SWD interface (pins **SWDCLK** and **SWDIO**) to the module should ideally be made available in the application design.

So that ANNA-B402 can be flashed over the UART or SWD interface, the module is preloaded with bootloader software that is without security. A debug connector to the module is also useful during the software development.

For security reasons, the debug interface should be disabled to prevent the upload or download of insecure software – or software that has not been validated.

Figure 6 shows the pinout of the 10-pin, 50 mil pitch connector used on the EVK-ANNA-B402. This compact debug header can also be used on a host board design. Keep in mind that the **GND** and **VDD_IO** references are needed for the SWD interface to work.

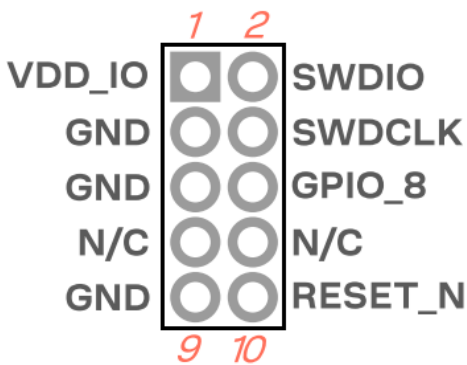

Figure 6: Cortex debug connector pin out for SWD

2.9.1 Thermal guidelines

ANNA-B4 series modules have been successfully tested from $-40\text{ }^{\circ}\text{C}$ to $+105\text{ }^{\circ}\text{C}$. ANNA-B4 modules are low-power devices that generate only a small amount of heat during operation. A good grounding should nonetheless be observed for temperature relief during high ambient temperatures.

2.10 Reserved pins (RSVD)

Do not connect any reserved (**RSVD**) pins. The reserved pins can be allocated for future interfaces and functionality.

2.11 ANNA-B1 to ANNA-B4 migration

ANNA-B4 is pin compatible with ANNA-B1 and provides a simple migration path for upgrading applications with the extra features that ANNA-B4 modules deliver, including, increased memory, increased output power, coded physical layer (PHY), higher operating temperature range, and u-connectXpress secure-boot software.

Figure 7 shows the footprints of the u-connectXpress ANNA-B112 and ANNA-B412 modules. Although the pin assignments vary, the positioning of the pin are identical.

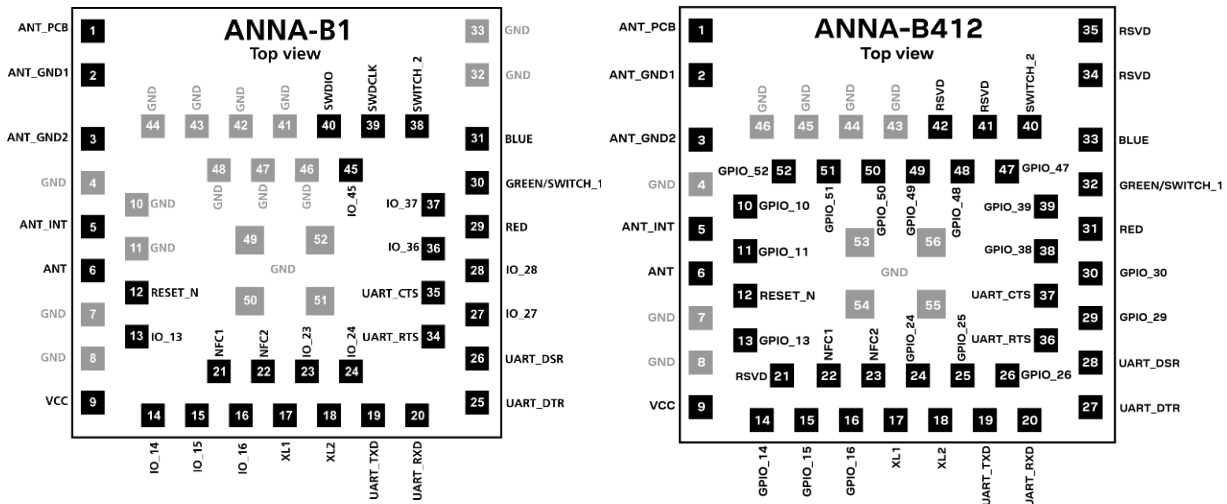
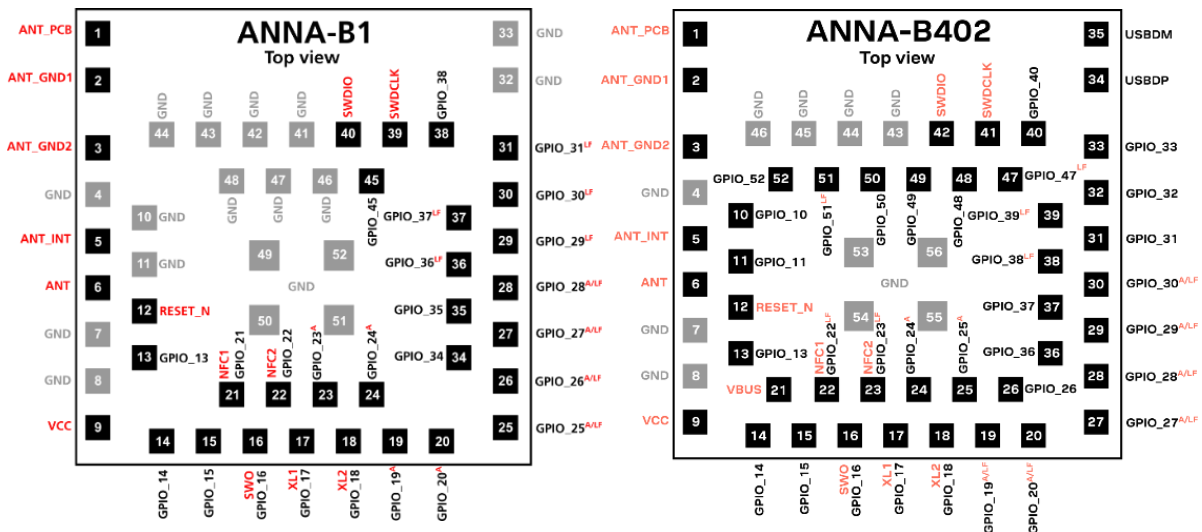

Figure 7: ANNA-B112 u-connectXpress footprint and ANNA-B412 u-connectXpress footprint

Figure 8 shows the footprints of the open CPU ANNA-B112 and ANNA-B402 modules. Although the pin assignments vary, the positioning of the pin are identical.



A = Analog function capable pin LF = Low Frequency, low drive I/O only
 Signals that are highlighted in red are locked to a specific pin, the grey pins are GND pins.

Figure 8: ANNA-B112 open CPU footprint and ANNA-B402 open CPU footprint

Consider the following when migrating from ANNA-B1 to ANNA-B4; that is, mounting an ANNA-B4 module onto a PCB originally designed for ANNA-B1:

- The USB interface on open CPU, ANNA-B40 modules is not accessible as **USBDP** and **USBDM** signals on pins 34 and 35 are both connected to GND.
- ANNA-B4 pins **GPIO_10**, **GPIO_11**, **GPIO_49**, **GPIO_50**, and **GPIO_51** cannot be used. These signals are connected to GND and must be configured as inputs.
- **VBUS** on pin 21 is an additional pad. It is unconnected.
- The Serial Wire Debug (SWD) signals **SWDIO** and **SWDCLK** available on the open CPU modules have the same physical location on ANNA-B4 as they do on ANNA-B1. However, the pin numbering of the two differs: On ANNA-B4 these signals are on pins 41 and 42. On ANNA-B1 they are on pins 39 and 40.
- Check that the power supply can meet the higher current requirements for ANNA-B4.
- Check the PCB to make sure that there is no risk for short circuits under the additional pins (21, 26, 47, and 52) on ANNA-B4. Remember that the solder mask is not a true insulator.

Consider the following when designing a PCB prepared for the interchangeable placement of ANNA-B1 and ANNA-B4:

- All GND pins on ANNA-B1 and ANNA-B4 modules must be grounded regardless of whether these have another function on the other module (ANNA-B4). These pins must then be configured as inputs.
- The USB interface supported in ANNA-B402 open-CPU modules is not accessible since **USBDP** (D+) and **USBDM** (D-) are connected to GND.
- The SWD interface supported on ANNA-B102 and ANNA-B402 open CPU modules is connected to the same physical pins on both variants. Route this to a connector or test point (TP).
- Implement a power supply capable of sourcing the higher current requirements of ANNA-B4 modules.

 The u-connectXpress software supported on ANNA-B412 modules includes secure-boot functionality. The SWD interface is not available.

 When migrating open CPU software to ANNA-B402 it is necessary to recompile the software with the correct pin definition, base port and SoftDevice.

 Although the pin numbering for ANNA-B1 is different than that on ANNA-B4, the physical placement of all common pins is the same.

 Although ANNA-B1 and ANNA-B4 are pin compatible, it is advisable to revise the layout of the application PCB to match ANNA-B4 footprint. This ensures that all required pads for the migration upgrade to ANNA-B4 are available. If this for any reason is not viable, review the PCB layout to ensure that no top layer traces interfere with the additional pads included on ANNA-B4.

3 Design-in

3.1 Overview

All application circuits must be properly designed, but there are several points that require special attention during the application design. A list of these points, in order of importance, follows:

- Select appropriate antenna type and part.
- Antenna circuit affects the RF compliance of the device integrating the module with applicable certification schemes. Follow the schematic and layout reference design recommendations provided in this document.
- Select appropriate power supply source and bypass capacitors and carefully route the power supply nets.
- The power supply circuit might impact the performance of the module. Follow the schematic and layout design recommendations for [Supply interfaces](#).
- Analog signals are sensitive to noise and should be routed away from high frequency signals.
- High speed interfaces might be a source of noise and can affect compliance with regulatory standards for radiated emissions. For correct schematic and layout design, see also [Universal asynchronous serial interface \(UART\)](#) and [General layout guidelines](#).
- System functions like **RESET_N**, **I2C**, **GPIO**, and other system input and output pins, require an accurate design that can ensure that the voltage level is well defined during module boot.
- Other pins also require an accurate design to ensure proper functionality.
- Make sure not to exceed the electrical specification for any pin.
- When upgrading an existing application design for ANNA-B1 to ANNA-B4, follow the guidelines for [ANNA-B1 to ANNA-B4 migration](#).

3.2 Antenna integration guidelines

When deciding which antenna concept to implement it is advisable to consider the following guidelines:

- The antenna design process should begin at the start of the whole product design process. Self-made PCBs and antenna assembly are useful in estimating overall efficiency and radiation pattern of the intended design.
- Use antennas designed by an antenna manufacturer providing the best possible return loss (or VSWR).
- Provide a ground plane large enough according to the related integrated antenna requirements. The ground plane of the application PCB may be reduced to a minimum size not smaller than one quarter of wavelength of the minimum frequency the applicable frequency band, however overall antenna efficiency may benefit from larger ground planes.
Proper placement of the antenna and its surroundings is critical for antenna performance. Avoid placing the antenna close to conductive or RF-absorbing parts such as metal objects, ferrite sheets and so on as they may absorb part of the radiated power or shift the resonant frequency of the antenna or affect the antenna radiation pattern.
- It is highly recommended to strictly follow the detailed and specific guidelines provided by the antenna manufacturer regarding correct installation and deployment of the antenna system, including PCB layout and matching circuitry.
- Further to the custom PCB and product restrictions, antennas may require tuning/matching to comply with all the applicable required certification schemes. It is recommended to consult the antenna manufacturer for the design-in guidelines and plan the validation activities on the final prototypes like tuning/matching and performance measures. See [Table 12](#).

- RF section may be affected by noise sources like hi-speed digital buses. Avoid placing the antenna close to high buses or consider taking specific countermeasures like metal shields or ferrite sheets to reduce the interference.
 - External antennas, such as linear monopole antennas:
 - Choose a module integration that supports an external antenna if the product includes a metal product enclosure.
 - External antennas do not impose any physical restrictions on the design of the PCB where the module is mounted.
 - Radiation performance depends mostly on the type of antenna used in the application product. Choose antennas that provide an optimal radiating performance in each operating band.
 - RF cables must be carefully selected to keep insertion losses to an absolute minimum. Low-quality or long cables introduce additional insertion losses. Large insertion losses reduce the radiation performance.
 - A high quality 50 Ω coaxial connector provides proper PCB-to-RF-cable transition.
- ⚠** Take care of interaction between co-located RF systems like LTE sidebands on 2.4 GHz band. Transmitted power may interfere or disturb the performance of the module.
- ⚠** To avoid invalidating the compliance and pre-certification of u-blox modules with the various regulatory bodies, use only external antennas included in the [Pre-approved antennas list](#). Reference design source files are available from u-blox on request.

3.3 Antenna connected through the RF pin

Follow the guidelines when selecting either an external antenna or an internal antenna mounted on the main PCB.

[Table 12](#) summarizes the requirements for the antenna RF interface.

| Item | Requirements | Remarks |
|-----------------|--|---|
| Impedance | 50 Ω nominal characteristic impedance | The impedance of the antenna RF connection must match the 50 Ω impedance of the Antenna pin. |
| Frequency Range | 2400 - 2500 MHz | Bluetooth low energy. |
| Return Loss | $S_{11} < -10$ dB (VSWR < 2:1) recommended $S_{11} < -6$ dB (VSWR < 3:1) acceptable | The return loss or S_{11} . As a parameter of the of the standing waves ratio (VSWR) measurement, S_{11} refers to the amount of reflected power. This parameter indicates how well the primary antenna RF connection matches the 50 Ω characteristic impedance of the ANT pin. |
| Efficiency | > -1.5 dB (> 70%) recommended > -3.0 dB (> 50%) acceptable | The radiation efficiency is the ratio of the radiated power to the power delivered to the antenna input; the efficiency is a measure of how well an antenna receives or transmits. |
| Maximum Gain | Refer to Section 7 | The maximum antenna gain must not exceed the value specified in type approval documentation to comply with the radiation exposure limits specified by regulatory agencies. Although higher gain antennas can be used, these must be evaluated and/or certified. See also Pre-approved antennas list . |

Table 12: Summary of antenna interface (ANT) requirements

When selecting antennas, the following recommendations should be observed:

- Select antennas that provide optimal return loss (or VSWR) over all operating frequencies.
- Select antennas that provide optimal efficiency over all operating frequencies.
- Select antennas that provide an appropriate gain (that is, combined antenna directivity and efficiency), so that the electromagnetic field radiation intensity does not exceed the regulatory limits specified in some countries (like the FCC in the United States for example).

3.3.1 RF transmission line design

RF transmission lines, such as those that connect from the RF pin to the antenna or antenna connector, must be designed with a characteristic impedance of $50\ \Omega$.

Figure 9 shows the design options and the most important parameters for designing a transmission line on a PCB:

- Microstrip: track separated with dielectric material and coupled to a single ground plane.
- Coplanar microstrip: track separated with dielectric material and coupled to both the ground plane and side conductor.
- Stripline: track separated by dielectric material and sandwiched between two parallel ground planes.

A coplanar microstrip is the most common configuration for a printed circuit board (PCB).

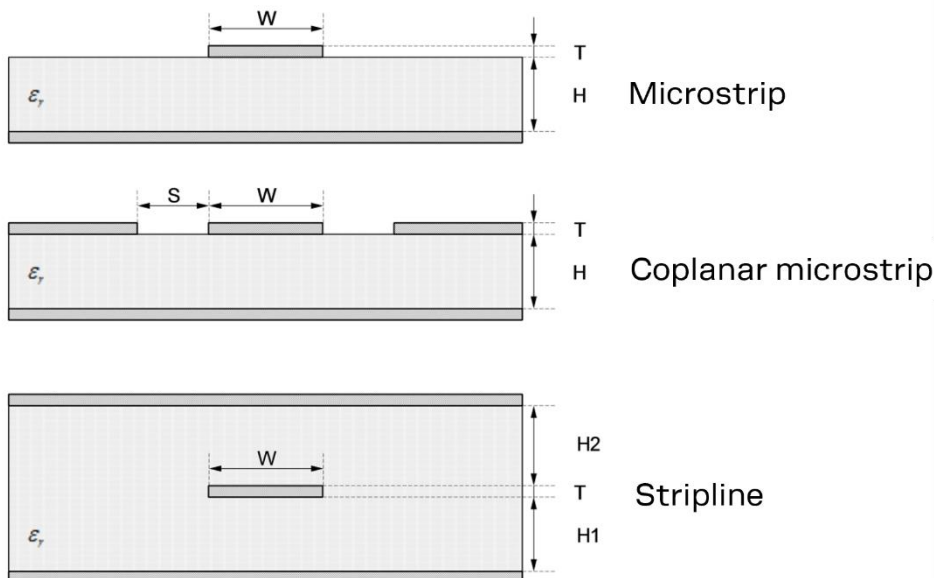

Figure 9: Transmission line trace design

Follow these recommendations to design a $50\ \Omega$ transmission line correctly:

- Designers must provide enough clearance from surrounding traces and ground in the same layer. In general, the trace to ground clearance should be at least twice that of the trace width. The transmission line should also be “guarded” by the ground plane area on each side.
- In the first iteration, calculate the characteristic impedance using tools provided by the layout software. Ask the PCB manufacturer to provide the final values usually calculated using dedicated software and production stack-ups. It is sometimes possible to request an impedance test coupon on side of the panel to measure the real impedance of the traces.
- Although FR-4 dielectric material can result in high losses at high frequencies, it can still be an appropriate choice for RF designs. In which case, aim to:
 - Minimize RF trace lengths to reduce dielectric losses.
 - If traces longer than few centimeters are needed, use a coaxial connector and cable to reduce losses.
 - For good impedance control over the PCB manufacturing process, design the stack-up with wide $50\ \Omega$ traces with width of at least $200\ \mu\text{m}$.
 - To make the trace less lossy and to have better impedance control the trace shall be made wide. This is achieved by increasing the distance to reference GND by clearing copper in the inner layers closest under the trace.

- Contact the PCB manufacturer for specific tolerance of controlled impedance traces. As FR-4 material exhibits poor thickness stability it gives less control of impedance over the trace width.
- For PCBs with components larger than 0402 and dielectric thickness below 200 μm, add a keep-out; that is, some clearance (void area) on the ground reference layer below any pin on the RF transmission lines. This helps to reduce the parasitic capacitance to ground.
- Route RF traces with smooth shapes try not to exceed 45° bends and avoid acute angles. The transmission lines width and spacing to GND must be uniform.
- Add GND stitching vias around transmission lines.
- Provide a sufficient number of vias on the adjacent metal layer. Include a solid metal connection between the adjacent metal layer on the PCB stack-up to the main ground layer.
- To avoid crosstalk between RF traces and Hi-impedance or analog signals, route RF transmission lines as far from noise sources (like switching supplies and digital lines) and any other sensitive circuit.
- Avoid stubs on the transmission lines. Any component on the transmission line should be placed with the connected pin located over the trace. Also avoid any unnecessary components on RF traces.

3.3.2 RF connector design

If an external antenna is required, the designer should consider using a proper RF connector. The designer must verify the compatibility between plugs and receptacles used in the design.

Based on the declarations of the respective manufacturers, [Table 13](#) suggests some RF connector plugs that can be used by designers to connect RF coaxial cables.

| Manufacturer | Series | Remarks |
|-------------------------------|---|-------------|
| Hirose | U.FL® Ultra Small Surface Mount Coaxial Connector | Recommended |
| I-PEX | MHF® Micro Coaxial Connector | |
| Tyco | UMCC® Ultra-Miniature Coax Connector | |
| Amphenol RF | AMC® Amphenol Micro Coaxial | |
| Lighthouse Technologies, Inc. | IPX ultra micro-miniature RF connector | |

Table 13: U.FL compatible plug connector

The Hirose U.FL-R-SMT RF receptacles (or similar parts) require a suitably mated RF plug from the same connector series. Due to wide usage of this connector, several manufacturers offer compatible equivalents. The RF plug is normally available as a cable assembly. Different types of cable assembly are available; the user should select the cable assembly best suited to the application.

The key characteristics of the cable assembly include:

- RF plug type: select U.FL or equivalent
- Nominal impedance: 50 Ω
- Cable thickness: Typically, 0.8 mm to 1.37 mm. Select thicker cables to minimize insertion loss.
- Cable length: Standard length is typically 100 mm or 200 mm; custom lengths may be available on request. Select shorter cables to minimize insertion loss.
- RF connector on the other side of the cable: for example another U.FL (for board-to-board connection) or SMA (for panel mounting)

Note that SMT connectors are typically rated for a limited number of insertion cycles. In addition, the RF coaxial cable may be relatively fragile compared to other types of cables. To increase application ruggedness, connect U.FL connector to a more robust connector such as SMA fixed on panel.

 A de-facto standard for SMA connectors suggests that the use of reverse polarity connectors (RP-SMA) on Wi-Fi and Bluetooth end products can deter end users from replacing the antenna with higher gain types that exceed regulatory limits.

Observe the following recommendations for a proper layout of the connector:

- Strictly follow the connector layout recommended by the manufacturer.
- SMA Pin-Through-Hole connectors require GND keep-out (void clearance area) on all layers around the central pin up to the annular pads of the four GND posts.
- U.FL surface mounted connectors require non-conductive traces (void clearance area) in the area below the connector between the GND land pads.
- If the RF pad size of the connector is wider than the microstrip, remove the GND layer beneath the RF connector to minimize the stray capacitance and retain a 50 Ω RF line resistance. To reduce the parasitic capacitance to ground for example, the active pad of the U.F.L connector must include, at the very least, a GND keep-out (void clearance area) on the first inner layer.

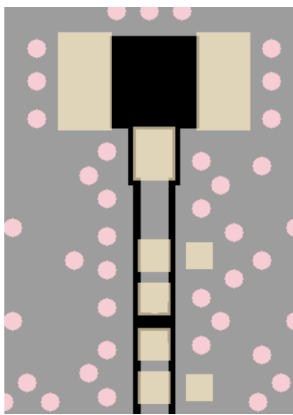



Figure 10: U.F.L connector layout example with pi-matching components placed on top of microstrip

3.4 Supply interfaces

3.4.1 VCC application circuits

The SMPS is the ideal choice when the available primary supply source has a more than moderately higher voltage than the operating supply of the module. The use of SMPS provides the best power efficiency for the overall application and minimizes current drawn from the main supply source. Customers are advised to perform power and thermal budgets to find the solution that is best suited for their full application.

 When using SMPS, ensure that AC voltage ripple at switching frequency is kept as low as possible. The layout shall be implemented to minimize impact of high frequency ringing.

The use of an LDO linear regulator is convenient for a main supply with a relatively low voltage, where the typical 85-90% efficiency of the switching regulator only provides minimal current saving. As linear regulators dissipate a considerable amount of energy, these are not recommended for stepping down high voltages. The benefit of an LDO source over SMPS is that an LDO is simpler to integrate and does not generate switching noise. However, with a larger voltage difference the superior efficiency of an SMPS converter provides less heat dissipation and longer operating time in battery-powered products.

The overall DC/DC efficiency of an SMPS depends on the current consumption during the active and idle states of the specific application. Although some DC/DC converters provide high efficiency with extremely light loads, their efficiency typically worsens when idle current drops below a few mA and reduces the battery life.

As a contingency against “latch up”, include an over-current limiter to protect the module from electrical over stress (EOS). An LDO or SMPS will serve this purpose.

3.4.1.1 Battery

In battery powered devices ensure that the battery capacity match the application and that it can deliver the peak current required by the module.

For further information about current consumption and other performance data, see also the electrical specifications provided in the respective data sheet [\[5\]](#) [\[6\]](#).

3.5 GND pins

Good connection of the module GND pins, with a solid ground layer on the main PCB, is required for module stability and correct RF performance. A good ground connection significantly reduces EMC issues and provides a thermal heat sink for the module.

3.6 General layout guidelines

Best schematic and layout practices are described in this section.

3.6.1 Considerations for schematic design and PCB floor-planning

- Low frequency signals are generally not critical to the layout and designers should focus on the higher speed buses. One exception to this general rule is when high impedance traces, such as signals driven by weak pull resistors, might be affected by crosstalk. For these and similar traces, a supplementary isolation of 4w (four times the line width) from other buses is recommended.
- Verify which interface bus requires termination and add series resistor terminations to these buses.
- Carefully consider the placement of the module with respect to antenna position and host processor.
- Verify the controlled impedance dimensions of the selected PCB stack-up. The PCB manufacturer might be able to provide test coupons.
- Verify that the power supply design and power sequence are compliant with module specifications, as described in the module’s data sheet.

 Take particular care not to place components close to the antenna area and follow the recommendations from the antenna manufacturer to determine the safe distance between the antenna and any other part of the system. Designers should also maximize the distance between the antenna and high-frequency buses, like DDRs and related components, or consider the use of an optional metal shield to reduce the potential interference picked up by the module antenna.

3.6.2 Layout and manufacturing

- An optimized module placement provides for better RF performance.
- Bypass capacitors should be placed as close as possible to the module. Prioritize the placement of capacitors with the least capacitance so that these are closest to module pads. The supply rails must be routed through the capacitors from the power supply to the supply pad on the module.
- Avoid stubs and through-hole vias on high-speed signals which might adversely affect signal quality.

- Verify the recommended maximum signal skew for differential pairs and length matching of buses.
- Minimize the routing length. Ensure that the maximum allowable length for high-speed buses is not exceeded. Longer traces generally degrade signal performance.
- Track impedance matched traces. Consult with your PCB manufacturer early in the project for proper stack-up definition.
- Separate the RF and digital sections of the board.
- Ground splitting is not allowed under the module.
- Minimize the bus length to reduce potential EMI issues from digital buses.
- All traces (including low speed or DC traces) must couple with a reference plane (GND or power); Hi-speed buses should be referenced against the ground plane. If any ground reference needs to be changed, an adequate number of GND vias must be added in the area that the layer is switched. This is necessary to provide a low impedance path between the two GND layers for the return current.
- Hi-Speed buses are not allowed to change reference plane. If changes in the reference plane are unavoidable, capacitors must be added in the transition area of the reference planes. This is necessary to ensure that a low impedance return path exists through the different reference planes.
- Following the “3w rule”, keep traces at a distance no less than three times that of its own width from the routing edge of the ground plane.
- For EMC purposes and the need to shield against any potential radiation, it is advisable to add GND stitching vias around the edge of the PCB. Traces on the PCB peripheral are not recommended.

3.6.3 ESD guidelines

Device immunity against Electrostatic Discharge (ESD) is a requirement for Electromagnetic Compatibility (EMC) conformance and use of the CE marking for products intended for sale in Europe. To bear the CE mark, all application products integrating u-blox modules must be conformance tested in accordance with the R&TTE Directive (99/5/EC), EMC Directive (89/336/EEC), and Low Voltage Directive (73/23/EEC) issued by the Commission of the European Community.

Compliance with the above directives also implies conformity to the following European norms for device ESD immunity: ESD testing standard CENELEC EN 61000-4-2 and radio equipment standards ETSI EN 301 489-1, ETSI EN 301 489-7, ETSI EN 301 489-24. The ESD immunity requirements for each of these standards are summarized in [Table 14](#).

The ESD immunity test is performed at the enclosure port, which is defined by ETSI EN 301 489-1 as the physical boundary through which the electromagnetic field radiates. If the device implements an integral antenna, the enclosure port is seen as all-insulating and includes conductive surfaces to house the device. If the device implements a removable antenna, the antenna port can be separated from the enclosure port. The antenna port includes the antenna element and its interconnecting cable surfaces.

Any extension of the ESD immunity test to the whole device is dependent on the device classification, as defined by ETSI EN 301 489-1. Applicability of the ESD immunity test to the related device ports, or the interconnecting cables to auxiliary equipment, depends on the device-accessible interfaces and manufacturer requirements, as defined by ETSI EN 301 489-1.

Contact discharges are performed on conductive surfaces, while air discharges are performed on insulating surfaces. Indirect contact discharges are performed on the measurement setup horizontal and vertical coupling planes as defined in CENELEC EN 61000-4-2.

 The terms “integral antenna”, “removable antenna”, “antenna port”, “device classification” used in the context of this guideline are defined in ETSI EN 301 489-1. The terms “contact discharge” and “air discharge” are defined in CENELEC EN 61000 4-2.

Table 14 describes the ESD immunity requirements as defined by CENELEC EN 61000-4-2, ETSI EN 301 489-1, ETSI EN 301 489-7, ETSI EN 301 489-24.

| Application | Category | Immunity level |
|---|----------------------------|----------------|
| All exposed surfaces of the radio equipment and ancillary equipment in a representative configuration | Indirect Contact Discharge | * ±8 kV |

*Tested on ANNA-B4 evaluation board.

Table 14: Electromagnetic Compatibility ESD immunity requirements

ANNA-B4 is manufactured with consideration to specific standards that minimize the occurrence of ESD events; the highly automated process complies with IEC61340-5-1 (STM5.2-1999 Class M1 devices) standard, and designers should subsequently implement proper measures to protect any pin that might be exposed to the end user from ESD events.

Compliance with the standard protection level specified in EN61000-4-2 is achieved by including ESD protection close to any areas that are accessible to the end user.

3.7 Design-in checklists

3.7.1 Schematic checklist

- Are the module pins properly numbered and designated on the schematic, as shown in the pin list of the respective data sheet [5] [6].
- Power supply design complies with the voltage supply requirement, as described in the respective ANNA-B402 [5] and ANNA-B412 data sheets [6].
- Adequate bypassing is present in front of the power pins, as described in the respective ANNA-B402 [5] and ANNA-B412 data sheets [6].
- Each signal group is consistent with its own power rail supply or proper signal translation has been provided, as described in the respective ANNA-B402 [5] and ANNA-B412 data sheets [6].
- When using an external antenna, provide a pi-filter in front of it for final matching.

3.7.2 Layout checklist

- PCB stack-up and controlled impedance traces follow the recommendations given by the PCB manufacturer. See [RF transmission line design](#).
- All pins are properly connected, and the footprint follows u-blox recommendations for pin design. See the solder mask information in the ANNA-B402 [5] and ANNA-B412 data sheets [6].
- Proper clearance has been provided between RF section and digital section.
- Proper isolation has been provided between Antennas for co-location RF systems.
- Bypass capacitors are placed close to the module. See [Layout and manufacturing](#).
- Low impedance power path or power plane has been provided to the module.
- Controlled impedance traces are properly implemented on the layout (both RF and digital) and follow PCB manufacturer recommendations. See [RF transmission line design](#).
- 50 Ω RF traces and connectors follow the rules described in [Antenna interface](#).
- Antenna design has been reviewed by the antenna manufacturer. See [Antenna integration guidelines](#)
- Proper grounding has been provided to the module for low impedance return path. See [Layout and manufacturing](#).
- Reference plane skipping has been minimized for high frequency busses.
- All traces and planes are routed inside the area defined by the main ground plane.
- u-blox has reviewed and approved the PCB¹.

¹ This is applicable only for end-products based on u-blox reference designs.

4 Open CPU software

ANNA-B40 series modules are used in an open CPU configuration allows customer applications to be developed in a Nordic SDK environment in the ANNA-B4 module.

4.1 Zephyr

Zephyr [20] is a widely adopted open-source Real Time Operating System (RTOS) that is supported on a multitude of chipsets, including the nRF52833 chip in the ANNA-B4 module. The Zephyr project is supported by the Linux Foundation.

Nordic Semiconductor provides the nRF Connect SDK for development using the Zephyr OS, but it is also possible to use a command-line environment.

4.1.1 Getting started with Zephyr on the ANNA-B4 module

Follow the procedure below to get started with Zephyr:

1. Install the Toolchain Manager from the *nRF Connect for Desktop* application and from there install the nRF Connect SDK. For more information, see the nRF Connect SDK [24].
2. If a command line environment is preferred, see the Getting Started section on the Zephyr website [21].

4.1.2 Board configuration in Zephyr

The Zephyr OS is similar to Linux in many respects. It uses a similar structure of `make` files and config files as the Linux kernel and also uses a device tree file to set up the pin mapping for your board.

An example configuration for EVK-ANNA-B402 is available in the Zephyr distribution or from the u-blox open CPU github repository [25].

Copy the configuration to the `<install directory>/zephyr/boards/arm` folder and build the project from your preferred environment.

4.1.3 Building for ANNA-B402 EVK on the Zephyr command-line

To build and flash the Zephyr “blinky” example for the ANNA-B4 EVK, move to the Zephyr folder in your installation and on the shell prompt enter:

```
~/zephyrproject/zephyr$ west build -b ubx_evkannab4_nrf52833 samples/basic/blinky
~/zephyrproject/zephyr$ west flash
```

4.2 Nordic nRF5 SDK

The Nordic nRF5 SDK includes a broad selection of drivers and libraries that provide a rich development environment for a broad range of devices and applications. The SDK is delivered in zip container file for easy installation.

The SDK comes with support for the SEGGER Embedded Studio, Keil microcontroller development kit, IAR embedded workbench IDE, as well as a GCC compiler that supports many platforms and languages.

-  The nRF5 SDK is in maintenance mode by Nordic Semiconductor and will receive updates as needed. For new projects Nordic Semiconductor recommend using nRF Connect SDK (see Zephyr).

4.2.1 Getting started with the Nordic nRF5 SDK

When working with the Nordic nRF5 SDK on the ANNA-B4 series module, follow the procedure below to get started with the Nordic Semiconductor toolchain and examples:

1. Download and install the [nRF Connect](#) that includes an embedded Programmer app for programming over SWD
2. Download and install the latest [SEGGER embedded studio](#).
3. Download and extract the latest [nRF5-SDK](#).

 When installing the SDK, be sure not to include any space characters in the file path. Keep the folder structure intact. The examples in the SDK use relative folder references.

4. Read SDK release notes and check the nRF5 SDK documentation available from the Nordic Semiconductor Infocenter.

4.2.1.1 Nordic tools

For further information and links to all Nordic tools, as well as the supported compilers, see [Nordic software and tools](#).

4.2.1.2 Support – Nordic development forum

For support on questions related to the development of software using the Nordic nRF5 DK, check out the Nordic [DevZone](#) forum.

4.2.2 Create a custom board support file for Nordic nRF5 SDK

The predefined hardware boards included in the Nordic nRF5 SDK are designed for Nordic development boards only. To add support for a custom board, create a support file with the name `custom_board.h` and save this to one of the folders:

- `<SDK folder>/components/boards` to be valid for all examples, or
- `<SDK folder>/examples/<project>/pca10100/<softdevice>/config` (valid for this project only).

 Given folder paths are consistent with the file structure for the Nordic nRF5 SDK version 17.0.0.

An example of what a custom board support file could look like for the EVK-ANNA-B402 can be found in the u-blox short range GitHub repository [17].

The custom board can then be selected by adding a define of the symbol `BOARD_CUSTOM` to your build.

Follow the procedure outlined below to add the `BOARD_CUSTOM` define statement in SEGGER Embedded Studio:

1. Right-click the Project in “Project Explorer”.
2. Select **Options...**

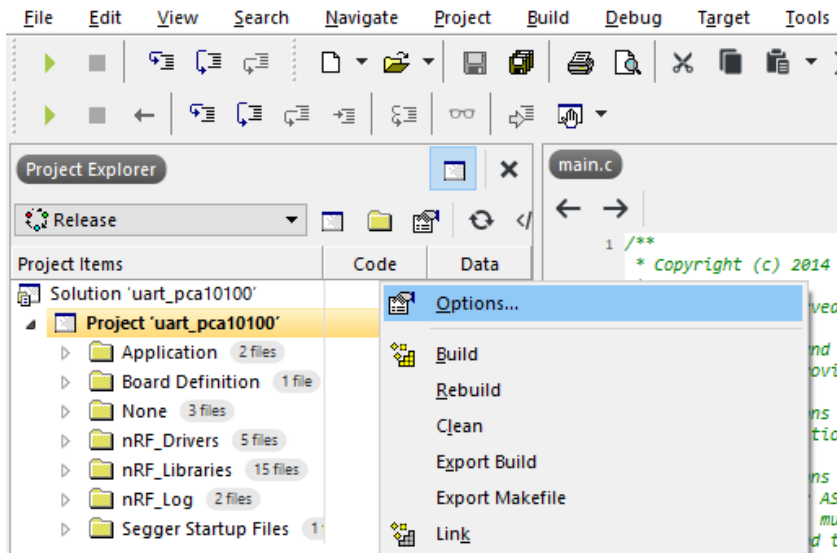

Figure 11: Selecting project options for modifying the Define statement in SEGGER Embedded Studio

3. Select the **Common** configuration.
4. Select the **Code / Preprocessor**.
5. Select the **Preprocessor Definitions**.

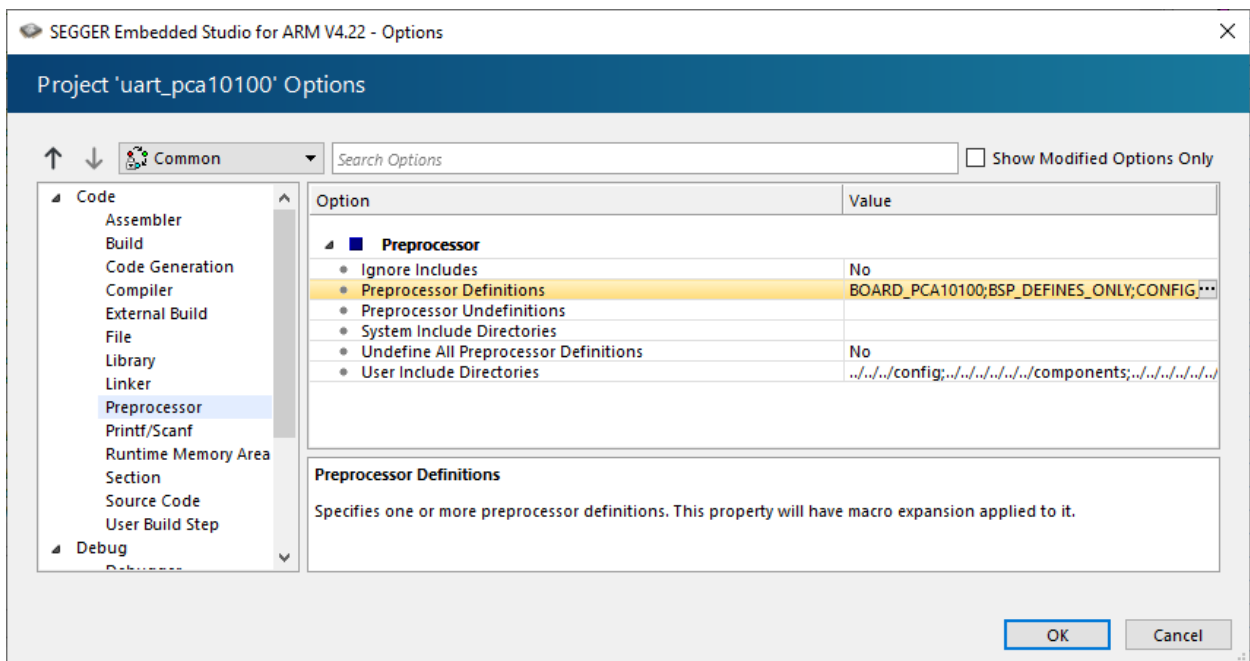

Figure 12: Project options for modifying the Define statement in SEGGER Embedded Studio

- Modify the “BOARD_” definition to define the BOARD_CUSTOM.

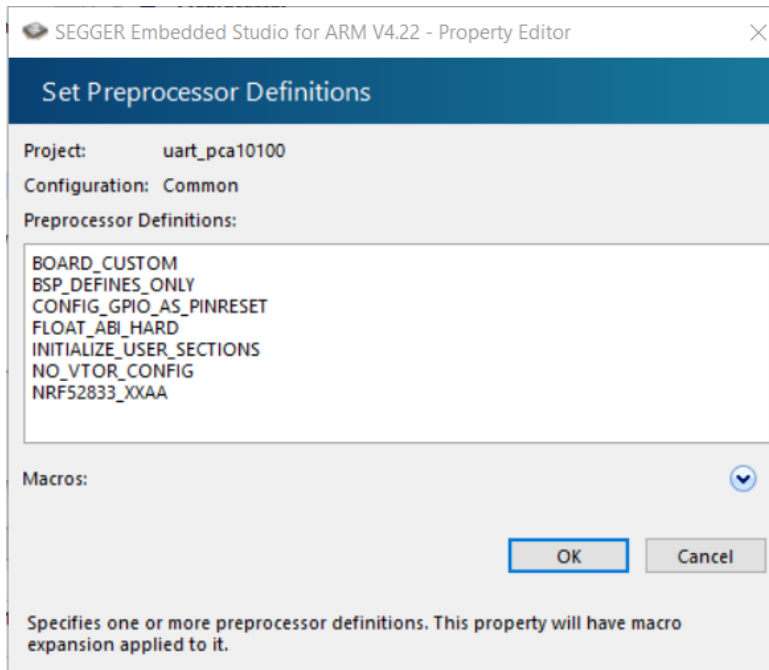

Figure 13: Pre-processor options for modifying the Define statement in SEGGER Embedded Studio

4.2.3 Adding a board configuration to your project

Another flexible way of adding a board to your project can be to add a new build configuration to your Segger Studio project and then use this to select the correct board file for your build. By adding several configurations, you can build for several targets from the same Segger Studio project. For example, your custom board and a u-blox EVK for testing your code on different platforms.

- Add a build configuration in the Segger Studio project.

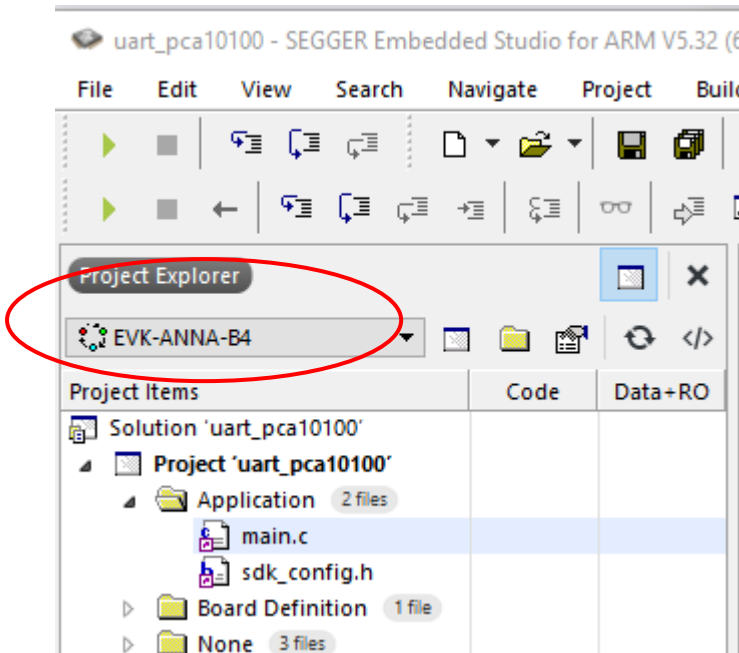

Figure 14: Add a build configuration to Segger Studio

- Configure the build configuration to use your board definition. Remember to undefine the configuration for the original board, assuming you are basing your project on an example from the Nordic nRF5 SDK.

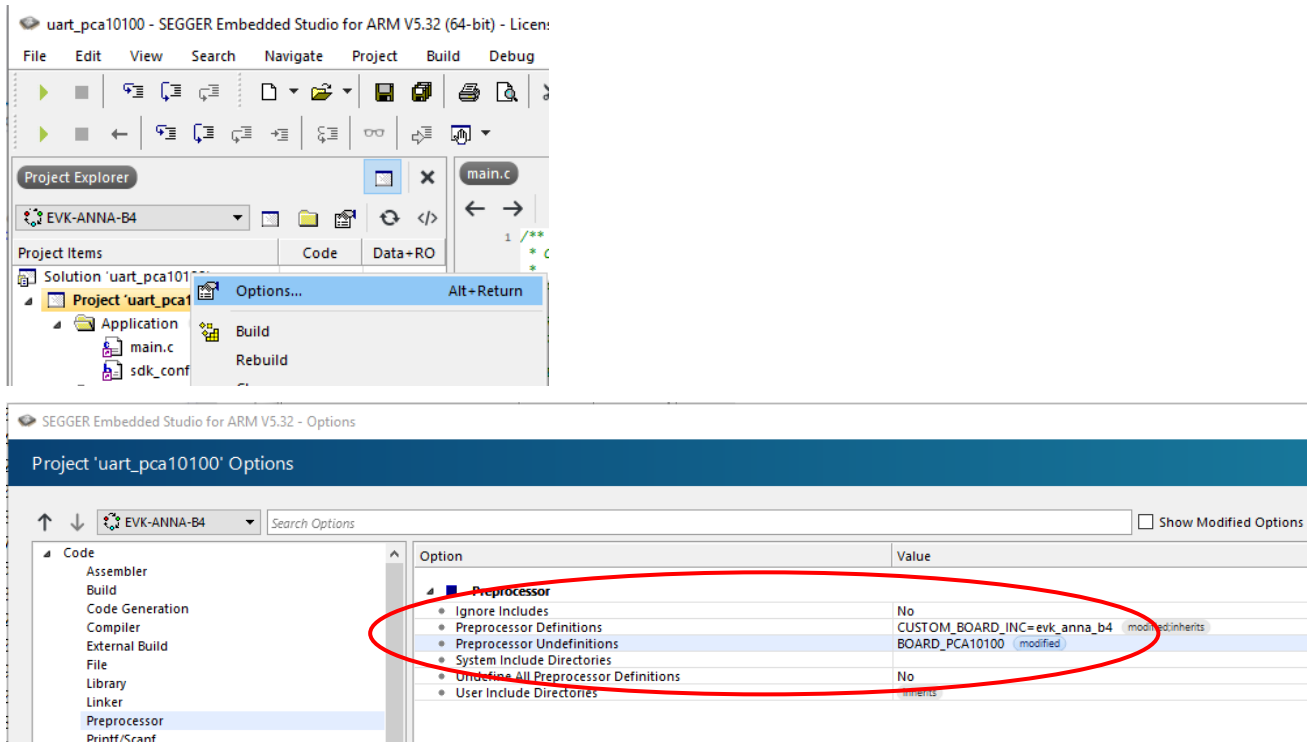

Figure 15: Configure the build configuration

The build is now configured for use with your custom board file.

4.3 Definition of Low Frequency clock source

ANNA-B4 modules are delivered without an external low frequency crystal oscillator (LFXO). To configure the software correctly for your configuration, follow the steps in the RC oscillator configuration application note [8].

EVK-ANNA-B402 is delivered with an external low frequency crystal oscillator mounted.

4.4 Bluetooth device (MAC) address and other production data

The open CPU (ANNA-B402) variant of the ANNA-B4 modules are provided with a unique, public Bluetooth device (MAC) address programmed. If required, this address can be used by the customer application.

The MAC address is programmed in the `CUSTOMER[0]` and `CUSTOMER[1]` registers in the UICR of the nRF52833 chip. The address can be read and written for example, using Segger J-Link utilities or the `nrfjprog` utility from Nordic.

```
$ nrfjprog.exe --memrd 0x10001080 --n 8
```

The memory area can be saved. If the flash is erased, the memory can also be reinstated using the `savebin` and `loadbin` utilities in the Segger J-link tool suite.

The UICR memory area also holds serial number and other information that can be valuable to save.

Use the following `nrfjprog` command options to save the whole memory area:

```
$ nrfjprog.exe --readuicr uicr.hex
...
$ nrfjprog.exe --program uicr.hex
```

 If the bootloader supplied with the module is not used for open CPU development, the UICR register cannot be saved this way. This is because the UICR registers that hold the start address of the bootloader confuse the boot process. In these instances, the MAC address must be written separately.



For additional information about saving and using the public Bluetooth device address, see also the application note [\[16\]](#).

4.5 Flashing open CPU software

ANNA-B402 open CPU modules can be flashed using various utility programs over the SWD or UART interface.

4.5.1 Flashing over the SWD interface

To flash ANNA-B402 modules over the Serial Wire Debug (SWD) interface an external debugger must be connected to the SWD interface of the module. Third-party tools, like J-Link Commander, J-Flash, nRF Command Line Utilities or nRF Connect Programmer, are used to flash the module.

-  SEGGER J-Link BASE external debugger works with ANNA-B402 modules.
-  EVK-ANNA-B402 incorporates an onboard debugger, which means that it can be flashed without an external debugger.
-  Always make a note of your Bluetooth device address before starting the flashing procedure. As flashing the software can erase the original u-blox Bluetooth device address, this address might need to be reinstated. The Bluetooth device address can be re-written manually or with the use of a script. See also [Bluetooth device \(MAC\) address and other production data](#).

4.5.2 Flashing over the UART interface

To be able to flash ANNA-B402 over the UART interface, the module is pre-loaded with the bootloader based on DFU examples included in the Nordic Semiconductor nRF5 SDK. The bootloader is accessed using Nordic Semiconductor flash tools like [nRF util](#).

[Table 15](#) shows the memory layout of the module as delivered from factory. The memory regions that are shaded are flashed in the factory.

| Usage | S140 SoftDevice version 7.0.x |
|-----------------------|-------------------------------|
| Bootloader settings | 0x0007F000 - 0x80000 |
| MBR parameter storage | 0x7E000 - 0x7F000 |
| Bootloader | 0x72000 - 0x7E000 |
| Application | 0x27000 - 0x72000 |
| SoftDevice | 0x1000 - 0x27000 |
| MBR | 0x0 - 0x1000 |

Table 15: Flash layout of the ANNA-B402 that includes the S140 SoftDevice

Memory sizes can vary depending on the SoftDevice radio stack software running on the module. In the nRF Connect Programmer, drag and drop the hex files you want to program into the GUI and then flash them to the module using the GUI.

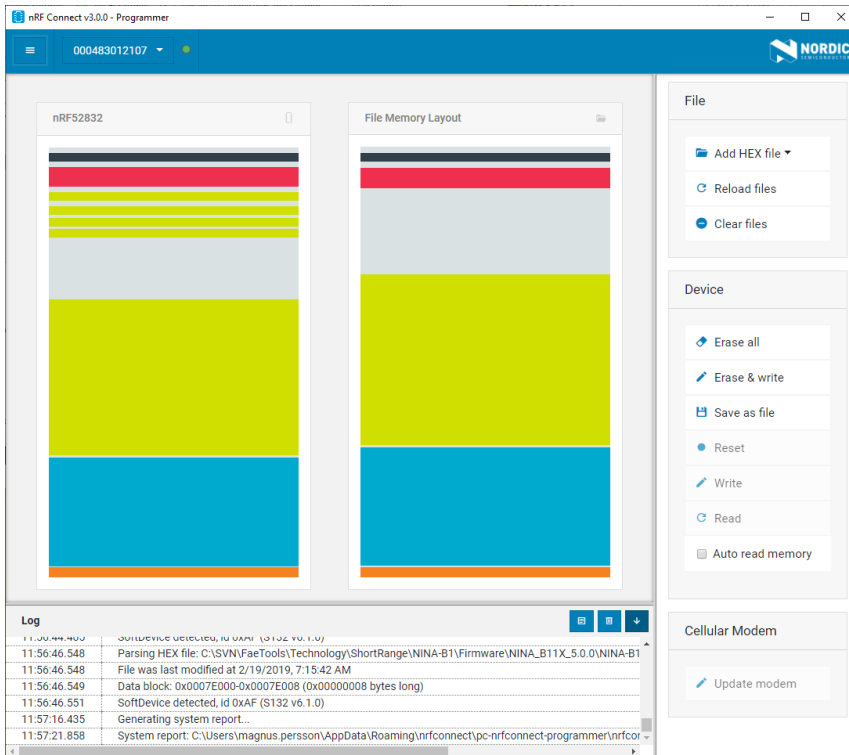

Figure 16: Selecting hex files in nRF Connect Programmer

4.5.2.1 Building applications to be flashed using the bootloader

To flash an application to the module without destroying the master boot record (MBR) pre-flashed in the factory, the start address in flash must be revised to `0x27000` (for applications with S140 SoftDevice) or `0x1000` (applications without SoftDevice). In a similar way to how the `BOARD_CUSTOM` flag was set in [Create a custom board support file for Nordic SDK](#), the start address can be changed by modifying the `FLASH_START` macro in the nRF5 SDK. In **Project Options**, select `FLASH_START` placement macro to revise the address, as shown in Figure 17.

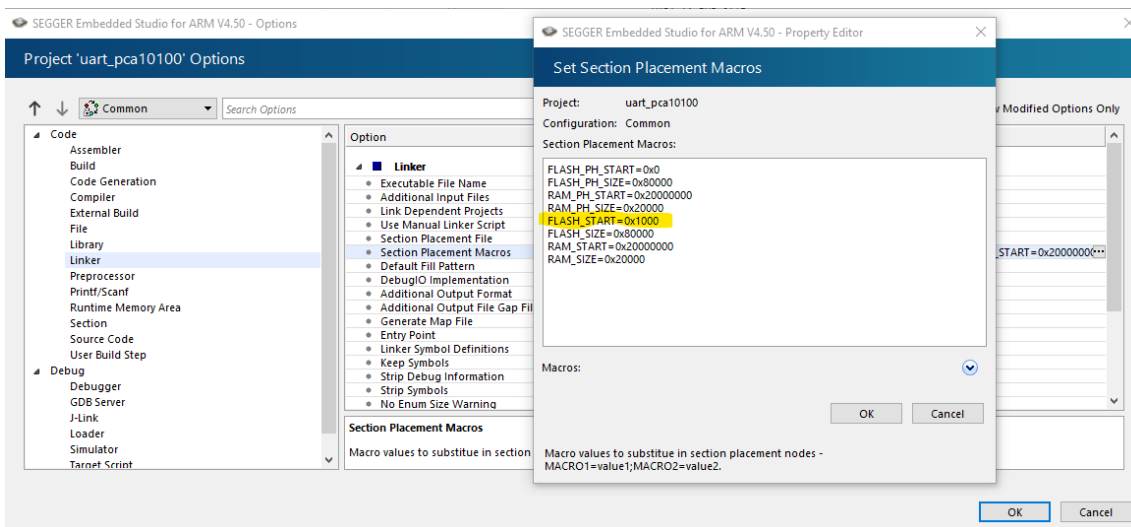

Figure 17: Setting the FLASH_START macro



Also reduce the `FLASH_SIZE` to fit the application below the bootloader.

4.5.2.2 Preparing the Device Firmware Update (DFU) package

The package has a special DFU package format. You use `nrfutil` to generate the DFU package.

Use the following command options for an application that does not use SoftDevice:

```
nrfutil pkg generate --hw-version 52 --sd-req 0x00 --application-version 0 --application
app.hex app.zip
```

Use the following command options for an application with SoftDevice:

```
nrfutil pkg generate --hw-version 52 --sd-req 0xCA --sd-id 0xCA --softdevice
s140_nrf52_7.0.1_softdevice.hex --application-version 0 --application app.hex sd_app.zip
```

4.5.2.3 Flashing the DFU package

The generated DFU package is flashed to the module using the following `nrfutil` command options:

```
nrfutil dfu serial -pkg app.zip -p COM95 -b 115200 -fc 1
```

 When the DFU package is flashed for the first time there is no application to boot, which causes the bootloader to automatically stop in DFU mode. On subsequent reboots, you need to stop the bootloader in DFU mode by driving **SWITCH_2** low during startup.

4.5.2.4 Hardware prerequisites for using the bootloader

To use the pre-flashed bootloader the hardware pins for **UART** and **SWITCH_2** must be mapped according to [Table 16](#). This is the same pin mapping that is used on the EVK-ANNA-B4 and used in the u-connectXpress software.

| Signal | Pin mapping (nRF pin number) |
|---------------------|------------------------------|
| UART_RX | IO_20 (P0.02) |
| UART_TX | IO_19 (P0.03) |
| UART_CTS (optional) | IO_37 (P0.22) |
| UART_RTS (optional) | IO_36 (P0.16) |
| SWITCH_2 | IO_40 (P0.15) |

Table 16: Pin mapping used by bootloader

The **UART_CTS** and **UART_RTS** (flow control signals) are optional but u-blox recommends using flow control over the UART.

5 u-connectXpress software

ANNA-B412 modules come pre-flashed with u-connectXpress and a secure bootloader software.

To ensure that the module only boots with the original u-blox software, the secure bootloader initiates a signature verification on the flashed software binary before it is booted.

ANNA-B412 u-connectXpress software can be re-flashed over the UART interface, using AT commands or the s-center client software available from the u-blox website.

5.1 Flashing ANNA-B412 u-connectXpress software

New versions of ANNA-B41 u-connectXpress software can be flashed to the module over the UART interface. See also [Updating software with s-center](#) and [Updating software with AT commands](#).

The following pins should be made available as either headers or test points to flash the module:

- **UART** (RX, TX)
- **RESET_N**
- **SWITCH_1** and **SWITCH_2**

5.1.1 Updating over UART

ANNA-B41 u-connectXpress software includes the bootloader for flashing ANNA-B4 over the UART interface. The software is available for download at www.u-blox.com.

Distributed in a single ZIP container, the software includes two separate binary files and one JSON file that includes the software label, software description, file name, version, flash address, image size, image id, file permissions, and signature file reference for the SoftDevice and ConnectivitySoftware applications:

- **Java Script Object Notation:**
ANNA-B41X-CF-<version>.json. For example: ANNA-B41X-CF-1.0.json
- **ConnectivitySoftware:**
ANNA-B41X-SW-x.y.z-<build>.bin. For example: ANNA-B41X-SW-1.0.0-001.bin
- **SoftDevice:**
ANNA-S140-SD-a.b.c.bin. For example, ANNA-S140-SD-7.2.0.bin

Signature files (ANNA-B41X-SI-x.x.x-xxx.txt and ANNA-S140-SI-x.x.x-xxx.txt) for each of the binaries are also included in the container.

5.1.1.1 Updating software with s-center

-  To update ANNA-B41 u-connectXpress requires s-center software version 6.0.0 or later. See also the s-center user guide [\[19\]](#).

Procedure

1. Connect the supplied serial cable from the J8 connector on EVK-ANNA-B41 to the USB port your computer. For further information about setting up EVK-ANNA-B41, see also EVK-ANNA-B4 user guide [\[7\]](#).
2. Download the latest version of the s-center and u-connectXpress software from u-blox [Product Resources](#).
3. Start s-center and choose "USB Serial Port (COMx)" in the drop-down "COM Port" menu. All other dialog settings are set to default.
4. Select **Open Port**. A series of AT commands and response are shown in the "Console Window".

5. Select **Tools** > **Software Update**.

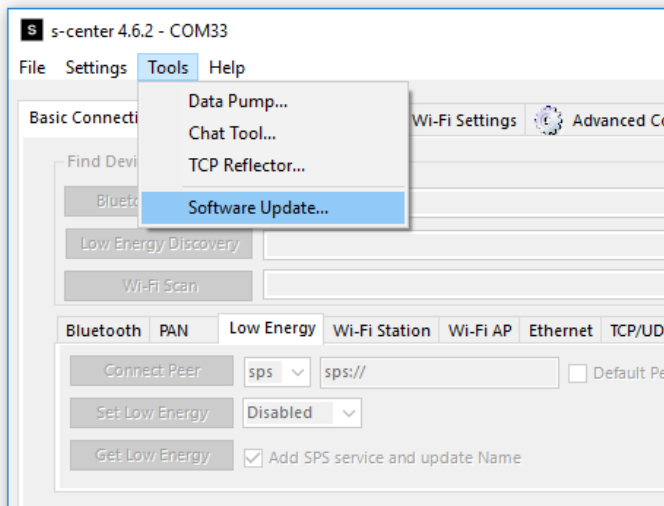

Figure 18: Software update

6. Check that the correct COM port is shown in “Settings”. **Select File** and choose the ANNA-B41X-CF-<version>.json file from the unzipped u-connectXpress container.

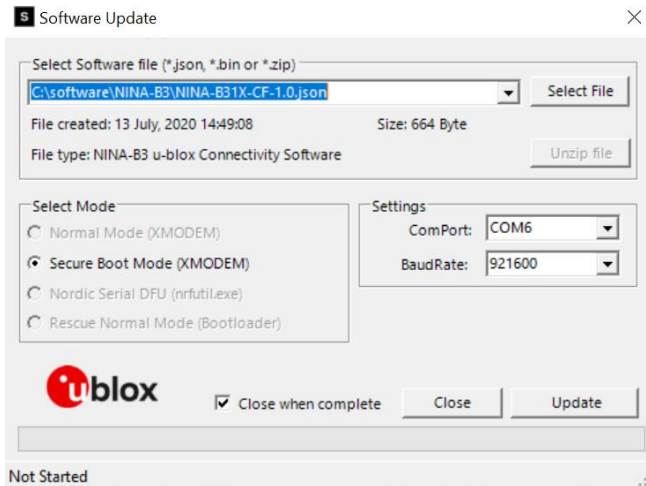

Figure 19: Select software file

7. Select **Update**. The module then reboots using the secure bootloader and flashing of both the SoftDevice and application starts automatically.

5.1.1.2 Updating software with AT commands

You can send AT commands to ANNA-B41 to execute certain tasks over the serial interface, using open-source terminal emulator software that supports XMODEM, like TeraTerm or ExtraPuTTY. Alternatively, you can send all AT commands described in this section using the s-center software in AT mode. The examples given in this procedure have been created and tested on EVK-ANNA-B41 using TeraTerm. See also the u-connectXpress AT command manual [1] and Bootloader protocol specification [18].

The bootloader must be running when the software is “sent” to the module. You start the bootloader using either:

- AT commands
- Pressing the SW1 and SW2 buttons simultaneously during a module reset (initiated by setting **RESET_N** low). See also [Module reset](#).

In contrast to the s-center configuration, UART hardware flow is not used for updating software using AT commands. The file download uses standard XMODEM-CRC16 protocol and 128 bytes packets.

Prerequisites

As a prerequisite to updating software using AT commands, you must open the JSON file included in the download container and make note of the defined values to be parsed with the update command. You also need to copy the signatures given in the related txt files, as shown in [Figure 21](#). This information is needed during the install. The defined values to include in the command, together with the signature file (ANNA-B41X-SI-x.x.x-xxx.txt), are shown in [Figure 20](#).

```
[
  {
    "Label": "ConnectivitySoftware",
    "Description": "ANNA-B41X u-blox connectivity software",
    "File": "ANNA-B41X-SW-1.0.0-003.bin",
    "Version": "ANNA-B41X-SW-1.0.0-003",
    "Address": "0x27000",
    "Size": "0x37AC0",
    "Id": "0x0",
    "Permissions": "rwx",
    "SignatureFile": "ANNA-B41X-SI-1.0.0-003.txt"
  },
  {
    "Label": "SoftDevice",
    "Description": "S140 softdevice from Nordic for ANNA-NRF",
    "File": "ANNA-S140-SD-7.2.0.bin",
    "Version": "ANNA-S140-SD-7.2.0",
    "Address": "0x0",
    "Size": "0x26634",
    "Id": "0x1",
    "Permissions": "rw",
    "SignatureFile": "ANNA-S140-SI-7.2.0.txt"
  }
]
```

Figure 20: Defined values for ConnectivitySoftware and SoftDevice as shown in the JSON file

```
VuxKhg6iB9eApM6g/PLVc4QwpXUDR9D8Ea8zVss2Jn6Y6vz2hQB8mfGwmXRZS9EoAZdkwO7C1KCoMcKC/baB/HnA
DDQo5oS/Z9TdmfBoQMN+AvJCirAe6AUW9M8jAQsc7w7mpANDqBJZs1AjmlQs+6uhSBItWZlMxBq7JsvBK6EMgEyu
Zv4DjBePQHxQJgA+5KUoLSwi4jvBdwSKoAZXzE1CgTDFPIybwjNz1k2yuBg2VjmyHUVblcGGalzoJR5CaB6xb6vP
QOntKmuVtycQz4wIZUs+xKftC+W4btjxNghjmnJ3cbj+YmiWgy5qBPEBizX/oUqhFjAHm4rfz7JK6Q==
```

Figure 21: Typical ConnectivitySoftware and SoftDevice signature file

Command syntax

You use the software update command `AT+UFWUPD` with following syntax to update both the u-connectXpress and SoftDevice software.

```
AT+UFWUPD=<mode>,<baud_rate>[,<id>,<size>,<signature>,<name>,<flags>]
```

The defined values for each parameter are shown in [Table 17](#).

| Parameter | Type | Description |
|-------------|------------|---|
| <mode> | Enumerator | Download mode: 0: Update mode for the ConnectivitySoftware through the serial port 1: Bootloader mode for update of the SoftDevice through the serial port. |
| <baud rate> | Enumerator | Baud rate in bits per second: 115200 (default), 230400, 460800, or 921600 |
| <id> | Integer | ID number of the software image. |

| Parameter | Type | Description |
|-------------|---------|--|
| <size> | Integer | Size of the firmware image. Enter the size integer for the respective software as defined in the ANNA-B41X-SI-x.x.x-xxx.txt file. Shown in hex format in the JSON file but must entered as bytes in decimal notation in the command. |
| <signature> | String | RSA signature of the firmware image as base64-encoded string. Enter the 344-character text string defined in the ANNA-B41X-SI-x.x.x-xxx.txt file. |
| <name> | String | The name of the firmware. Maximum string length is 22. |
| <flags> | String | Permissions for using the firmware image. Permission flags are marked in UNIX style: "rwx" is the default flag for the u-connectXpress software. "rw" is the default flag for other binary images. |

Table 17: Defined values for update parameters

5.1.1.2.1 Setting up the serial port

You can send AT text commands to ANNA-B41 to execute tasks using open-source terminal emulator software that supports XMODEM like Tera Term or ExtraPuTTY. Alternatively, you can send all AT commands described in this section using the s-center software in AT mode. See also the s-center user guide [19].

Procedure

The examples in this procedure have been created and tested on EVK-ANNA-B41 using TeraTerm.

1. Connect the supplied serial cable from the J8 connector on EVK-ANNA-B41 to the USB port your computer. For further information about setting up EVK-ANNA-B41, see also EVK-ANNA-B4 user guide [7].
2. Download and unzip the latest u-connectXpress software from u-blox [Product Resources](#).
3. Discover the COM port number for the USB Serial Port on your computer (MS Windows: **Start>Device Manager>Ports**). See also “Setting up the evaluation board” in the EVK-ANNA-B4 user guide [7].
4. Start your chosen terminal emulator and open the connection to the USB serial port (COMx).

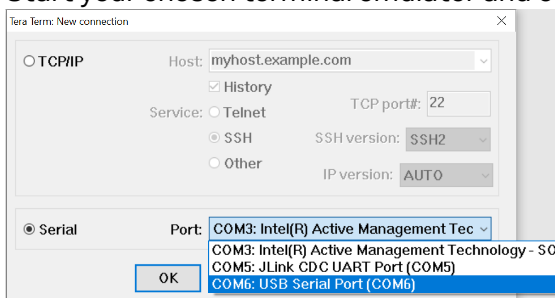
Figure 22: New connection

5. Setup the serial port and connection. Set “Speed” to 115200 with all other parameters set to default. Select **New setting**.

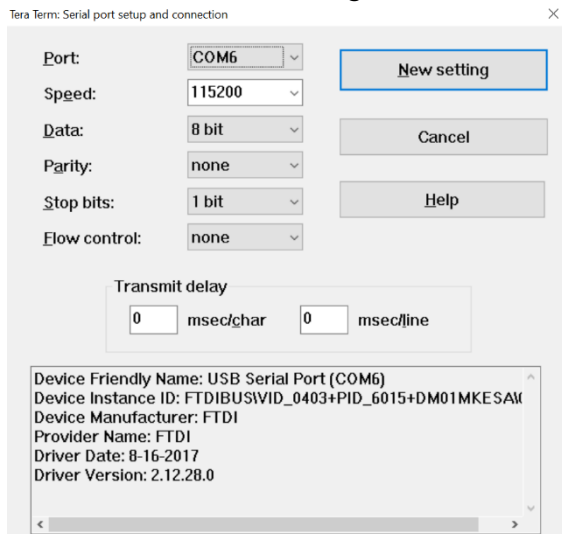

Figure 23: Serial port setup and connection

5.1.1.2.2 Updating u-connectXpress connectivity software only

You can send AT text commands to ANNA-B41 to execute tasks using open-source terminal emulator software that supports XMODEM, like TeraTerm or ExtraPuTTY. Alternatively, you can send all AT commands described in this section using the s-center software in AT mode. See also the s-center user guide [19].

Procedure

The examples in this procedure have example parameters, please check your SW for appropriate values.

1. Setup the serial port connection. See also [Setting up the serial port](#).
2. Enter Software version identification `AT+GMR` command to find out the current version of your u-connectXpress software.

```
AT+GMR
"1.0.0-003"
OK
```

3. Prepare the module to accept a binary file for download and start the bootloader at the appropriate baud rate. Enter the Update software `AT+UFWUPD` command together with the ConnectivitySoftware values defined in the `ANNA-B41X-CF-<version>.json` file and the signature in the `ANNA-B41X-SI-x.x.x-xxx.txt` file. The bootloader must be running when the software is “sent” to the module in the next step. Note particularly that `<mode>=0`, `<name>=ConnectivitySoftware`, and `<flags>=rwx`. See also [Prerequisites](#) and [Command syntax](#).

```
AT+UFWUPD=0,115200,0,228032,
VuxKhg6iB9eApM6g/PLVc4QwpXUDR9D8Ea8zVss2Jn6Y6vz2hQB8mfGwmXRZS9EoAZdkw07C1KCoMcKC/baB
/HnADDQo5oS/Z9TdmfBoQMN+AvJCirAe6AUW9M8jAQsc7w7mpANDqBJZslAjmlQs+6uhSBItWZlMxBq7JsvB
K6EMgEyuZv4DjBePQHxQJgA+5KUoLSwi4jvBdwSKoAZXzE1CgTDFPIybwjNz1k2yuBg2VjmyHUVblcGGalzo
JR5CaB6xb6vPQOntKmuVtycQz4wIZUs+xKfTC+W4btjxNghjmNJ3cbj+YmiWgy5qBPBEbZx/oUqhFjAHm4rf
z7JK6Q==,ConnectivitySoftware,rwx
```

ANNA-B4 returns a series of “c” characters for as long as the bootloader is running.

```
cccccccccccccccccccccccccccc
```

4. While the bootloader is running, send the u-connectXpress ANNA-B41X-SW-1.0.0-0.003.bin file to ANNA-B4. The file is sent using XMODEM protocol.
5. Once the binary file has been sent, ANNA-B41 displays the greeting text +STARTUP. Enter the Software version identification AT+GMR command again to make sure that the latest software version is now installed.

```
+STARTUP
AT+GMR
"3.0.0-005"
OK
```

5.1.1.2.3 Updating both the SoftDevice and u-connectXpress connectivity software

The SoftDevice is updated with AT commands using dual-banked approach, and as a SoftDevice update overwrites the application currently flashed in the module it is also necessary to flash the ConnectivitySoftware application after the SoftDevice update.

 You can send AT text commands to ANNA-B41 to execute tasks using open-source terminal emulator software that supports XMODEM, like Tera Term or ExtraPuTTY. Alternatively, you can send all AT commands described in this section using the s-center software in AT mode. See also the s-center user guide [19].

Procedure

1. Setup the serial port connection. See also [Setting up the serial port](#).
2. Prepare ANNA-B41 to accept the SoftDevice binary file for download at the defined baud rate. Enter the Update software AT+UFWUPD command together with the SoftDevice values <mode> and <baudrate> defined in the ANNA-B41X-CF-<version>.json file. Note particularly that <mode>=1.

```
AT+UFWUPD=1,115200
>
```

3. Enter the configuration action command "1" to list all firmware images and check the current version of your SoftDevice.

```
> 1

image_id          00
image_name        ConnectivitySoftware
image_addr        00027000
size              00037AC0
permissions       rwx-----
signature         JmpKUQY4DUjZ3n2+8n4U3BIic6epNvLf5g6/XBIArr7G3F+vhXEo+TDz1mlTodjpwRQXrAQz
                  eWScw+2siBk9NQ68FEUx4yfonQA8vNzFkhsr94HEE+oEFiq0zRda9UffOyxybr7nKThyaJvI
                  WGHIBPdsh9+hWmKgGBuLRAEfmKTKzWFvYcYhOBR/NydD/xA9bDVcZVzNRAbdhaf1+L4JVkXr
                  roSSUCT+q0PF4NtyWelSXDPBdHHsd5lOCbQ/epWW0NJF/7OcJrRw7pi7w/Hrq8+3VdZGFbpS
                  C8o9pGWVjTuhTh+bYD6Ex0sGkR/zdMYz/g+lTfZ/UmQBB0clZ0lSsQ==

image_id          01
image_name        SoftDevice
image_addr        00000000
size              00026634
permissions       rw-----
signature
```

```
hvp9N/xYu2l89lbe4fPjEHG1FEqthNqicxnnSHWRw4sKXFus8dPB4sx0PmHhrvcTSXwAySlT
5trpmpQ90u6BmXTdj4k/ReBB8afFlS8RxDqDRvji8rifhxprzJK2I9yfYsbVL4ptpD+XJQv+
NPRvncpxcixJ/+HuLAlggkfwLeFsd2LQUL/9kbEEbqD6lSzM+/q3eiNI8Bhj/mXuu28VVCs
EpX0qQ2kmodFfrWoLaqXUs7VUGbXYP0KsnYxQneaw96svj1xC1v85TdPLgdR2pKERLpOsbK0
1QPhYxN3wpm63W8Fz7uNFMvIxx9aYI3yHPHr9WSLzevMPfcJ0gsjAg==
OK>
```

4. Store the SoftDevice signature. Enter the configuration action command `s` together with the SoftDevice values for `<imageid>` `<signature>` defined in the ANNA-B41X-CF-`<version>`.json file and ANNA-B41X-SI-x.x.x-xxx.txt signature file. Note particularly that the `<image id>` of the SoftDevice is 1.

```
> s 1
hvp9N/xYu2l89lbe4fPjEHG1FEqthNqicxnnSHWRw4sKXFus8dPB4sx0PmHhrvcTSXwAySlT5trpmpQ90u6B
mXTdj4k/ReBB8afFlS8RxDqDRvji8rifhxprzJK2I9yfYsbVL4ptpD+XJQv+NPRvncpxcixJ/+HuLAlggkfw
bLeFsd2LQUL/9kbEEbqD6lSzM+/q3eiNI8Bhj/mXuu28VVCsEpX0qQ2kmodFfrWoLaqXUs7VUGbXYP0KsnYx
Qneaw96svj1xC1v85TdPLgdR2pKERLpOsbK01QPhYxN3wpm63W8Fz7uNFMvIxx9aYI3yHPHr9WSLzevMPfcJ
0gsjAg==
OK
>
```

5. Prepare the bootloader to accept a file transfer using XMODEM protocol. Enter the configuration action command `x` together with the SoftDevice values `<imageaddress>`, `<imagesize>` `<imagename>`, `<permissions>` and `<imageid>` defined in the ANNA-B41X-CF-`<version>`.json file.

```
> x 0 0x26634 SoftDevice rw 1
```

ANNA-B41 returns a series of 'C' characters for as long as the bootloader is running.

```
CCCCCCCCCCCCCCCCCCCCCCCCCCCC
```

6. While the bootloader is running, send the SoftDevice ANNA-S140-SD-x.x.bin file to ANNA-B4. The file is sent using XMODEM protocol.

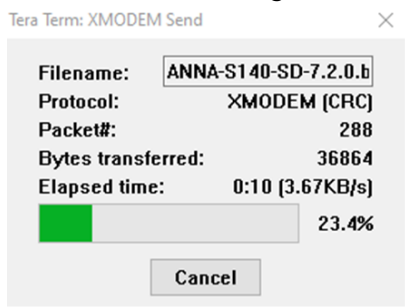

ANNA-B41 displays the greeting text `+STARTUP` once the binary file has been sent.

7. Having flashed the SoftDevice, you now flash the connectivity software in the same way. To initially store the signature of the connectivity software, enter the configuration action command `s` together with the ConnectivitySoftware values `<imageid>` `<signature>` defined in the ANNA-B41X-CF-`<version>`.json file and signature in the ANNA B41X-SI-x.x.x-xxx.txt file.

```
s 0
JmpKUQY4DUjZ3n2+8n4U3BIic6epNvLf5g6/XBIArr7G3F+vhXEo+TDz1mlTodjPWrQXrAQzeWScw+2siBk9
NQ68FEUx4yfonQA8vNzFkhsr94HEE+oEFiq0zRda9UffOyxybr7nKThyaJvIWGHIBPdsh9+hWmKgGBuLRAEf
mKTKzWfvYcYhOBR/NydD/xA9bDvcZVzNRAbdhaf1+L4JVkXrroSSUCT+q0PF4NtyWelSXDPbdHHsd5lOCbQ/
epWWONJF/7OcJrRw7pi7w/Hrq8+3VdZGFbpSC8o9pGWVjTuhTh+bYD6Ex0sGkR/zdMYz/g+1TfZ/UmQBB0cl
Z0lSsQ==
>
```

- Prepare the bootloader to accept a file transfer using XMODEM protocol. Enter the configuration action command “x” with the ConnectivitySoftware values <imageaddress>, <imagesize>, <imagenamename> <permissions>, and <imageid> defined in the ANNA-B41X-CF-<version>.json file.

```
> x 0x27000 0x37AC0 ConnectivitySoftware rwx 0
```

ANNA-B41 returns a series of ‘C’ characters for as long as the bootloader is running.

```
CCCCCCCCCCCCCCCCCCCCCCCCCCCC
```

- While the bootloader is running, send the u-connectXpress ANNA-B41X-SW-1.0.0-0.001.bin file to ANNA-B41. The file is sent using XMODEM protocol.

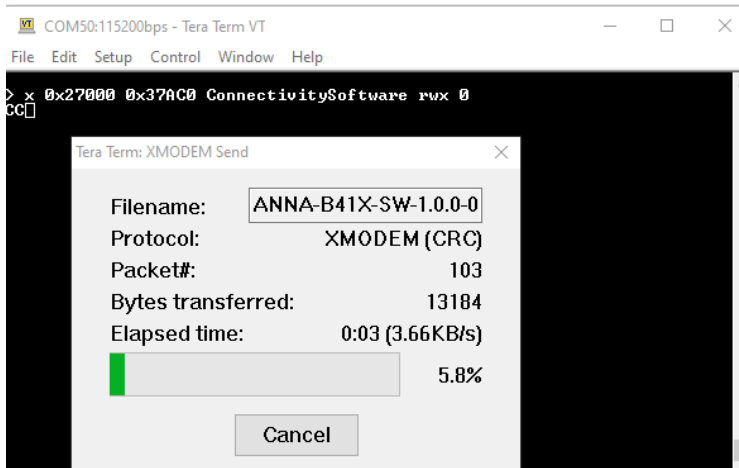

- Set the connectivity software as the startup image. Once the binary file has been sent, enter the configuration action command “f” with the ConnectivitySoftware value <imageid> defined in the ANNA-B41X-CF-<version>.json file.

```
> f 0
OK
>
```

- Enter the configuration action command “q” to reset and start the module with the newly flashed software.



```
> q
+STARTUP
```

For further information about bootloader commands and their parameter syntax, see also the u-connectXpress bootloader protocol specification [18] and u-connectXpress AT commands manual [1].

5.2 Low frequency clock and autosense

A low frequency clock is required by the radio block and is used for power saving. The low frequency clock can be provided internally by an RC oscillator, synthesized from the fast clock, or sourced externally by a 32.768 kHz crystal. ANNA-B41 u-connectXpress software has an autosense functionality to detect whether an external low frequency crystal oscillator is mounted on the host board. For more information, see also the respective data sheets [5] [6].

- EVK ANNA-B4 is delivered with a mounted external low frequency crystal oscillator. For more information, see also the EVK-ANNA-B4 user guide [7].

-  If an external crystal or TCXO is mounted, the u-connectXpress software settings require a crystal accuracy of 20 ppm or better.
-  If no external crystal or TCXO is mounted, the u-connectXpress software uses the internal RC oscillator with the settings of a calibration timer interval of 4 s and minimum calibration of 2 calibration intervals. This ensures that a calibration is performed at least once every 8 seconds and for changes of temperature above 0.5 °C every 4 seconds. See also the nRF52833 product specification [\[26\]](#).

6 Handling and soldering

- ⚠** ANNA-B4 series modules are Electrostatic Sensitive Devices that demand the observance of special handling precautions against static damage. Failure to observe these precautions can result in severe damage to the product.

6.1 ESD handling precautions

- ⚠** As the risk of electrostatic discharge in the RF transceivers and patch antennas of the module is of particular concern, standard ESD safety practices are prerequisite. See also [Figure 24](#).

Consider also:

- When connecting test equipment or any other electronics to the module (as a standalone or PCB-mounted device), the first point of contact must always be to local GND.
- Before mounting an antenna patch, connect the device to ground.
- When handling the RF pin, do not touch any charged capacitors. Be especially careful when handling materials like patch antennas (~10 pF), coaxial cables (~50-80 pF/m), soldering irons, or any other materials that can develop charges.
- To prevent electrostatic discharge through the RF input, do not touch any exposed antenna area. If there is any risk of the exposed antenna being touched in an unprotected ESD work area, be sure to implement proper ESD protection measures in the design.
- When soldering RF connectors and patch antennas to the RF pin on the receiver, be sure to use an ESD-safe soldering iron (tip).

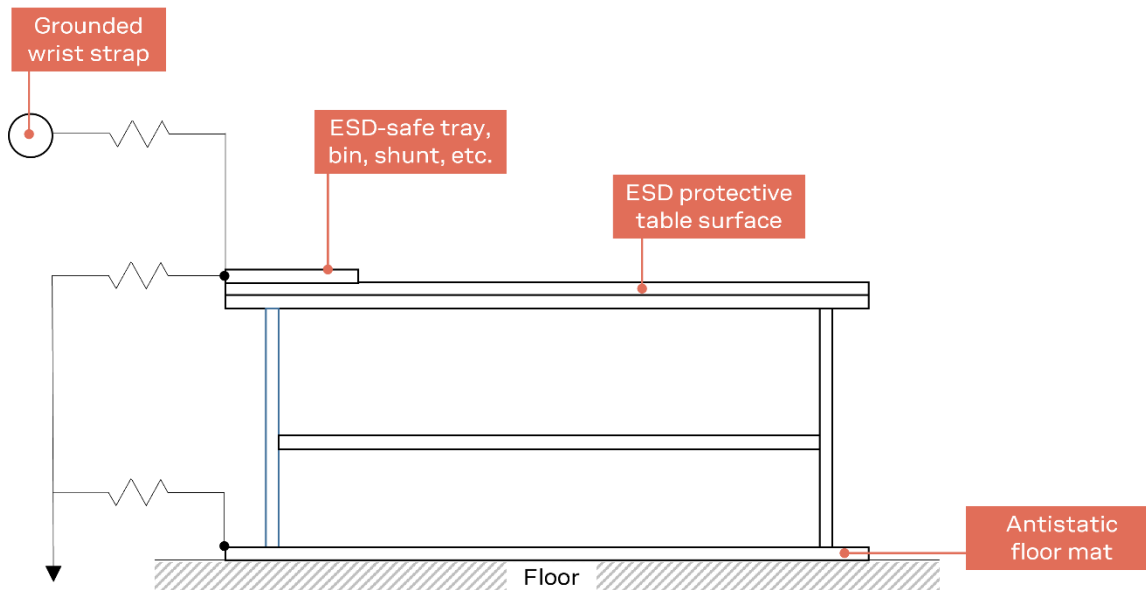

Figure 24: Standard workstation setup for safe handling of ESD-sensitive devices

6.2 Packaging, shipping, storage, and moisture preconditioning

For information pertaining to reels, tapes or trays, moisture sensitivity levels (MSL), shipment and storage, as well as drying for preconditioning, refer to the ANNA-B4 data sheet [\[5\]](#)[\[6\]](#) and Packaging information reference guide [\[22\]](#).

6.3 Soldering

- 🔧** No natural rubbers, hygroscopic materials, or materials containing asbestos are employed.

6.3.1 Reflow soldering process

ANNA-B4 modules are surface mounted devices supplied in a Land Grid Array (LGA) package with gold-plated solder lands. The modules are manufactured in a lead-free process with lead-free soldering paste.

The thickness of solder resist between the top side of host PCB and the bottom side of ANNA-B4 must be considered for the soldering process.

ANNA-B4 modules are compatible with the industrial reflow profile for common SAC type RoHS solders. No-clean soldering paste is strongly recommended.

The reflow profile is dependent on the thermal mass over the entire area of the fully populated host PCB, the heat transfer efficiency of the oven, and the type of solder paste that is used. The optimal soldering profile that is used must be trimmed for each case depending on the specific soldering process and layout of the host PCB.

⚠ The target parameter values shown in [Table 18](#) are only general guidelines for a Pb-free process and all given values are tentative and subject to change. For further information, see also the JEDEC J-STD-020C standard [\[9\]](#).

| Process parameter | | Unit | Value |
|-------------------|-------------------------------------|------|-------|
| Pre-heat | Ramp up rate to $T_{S\text{MIN}}$ | K/s | 3 |
| | $T_{S\text{MIN}}$ | °C | 150 |
| | $T_{S\text{MAX}}$ | °C | 200 |
| | t_s (from 25 °C) | s | 110 |
| | t_s (Pre-heat) | s | 60 |
| Peak | T_L | °C | 217 |
| | t_L (time above T_L) | s | 60 |
| | T_P (absolute max) | °C | 245 |
| | t_P (time above $T_P - 5$ °C) | s | 10 |
| Cooling | Ramp-down from T_L (absolute max) | K/s | 6 |
| General | $T_{\text{to peak}}$ | s | 300 |
| | Allowed reflow soldering cycles | - | 2 |

Table 18: Recommended reflow profiles

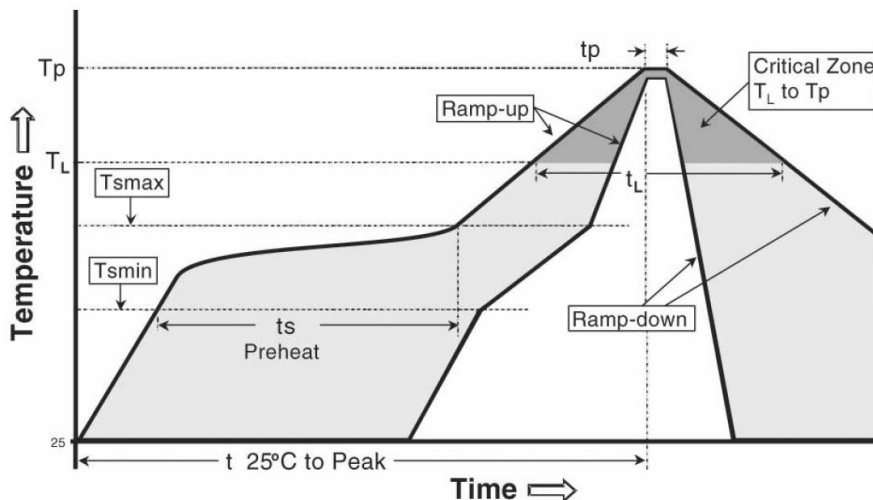

Figure 25: Reflow profile

🔧 The lower value of T_P and slower ramp down rate (2–3 °C/sec) is preferred.

6.3.2 Cleaning

Cleaning the module is not recommended.

Residues underneath the module cannot be easily removed with a washing process.

- Cleaning with water will lead to capillary effects where water is absorbed in the gap between the baseboard and the module. The combination of residues of soldering flux and encapsulated water leads to short circuits or resistor-like interconnections between neighboring pads. Water will also damage the label and the ink-jet printed text.
- Cleaning with alcohol or other organic solvents can result in soldering flux residues flooding into areas that are not accessible for post-wash inspections. The solvent will also damage the label and the ink-jet printed text.
- Ultrasonic cleaning will permanently damage the module and the crystal oscillators in particular. For best results use a "no clean" soldering paste and circumvent the need for a cleaning stage after the soldering process.

6.3.3 Potting and conformal coating

If potting or conformal coating is required, the ANNA-B4 mold characteristics in [Table 19](#) should be considered. If the antenna and/or antenna trace is covered by the potting or coating, it may affect the RF characteristics of the module. This might also affect the certification of the module, and the antenna will most likely be classified as a new antenna requiring recertification. The customer is strongly advised to qualify the potting / coating process in combination with the u-blox module.

 Hardware failure analysis requires that it is possible to remove the potting / coating.

 Failures related to the use of potting / coating are not covered by warranty.

| Parameter | Unit | Value |
|------------------|------|-------|
| Shrinkage | % | 0.17 |
| Modulus (25 °C) | MPa | 20000 |
| Modulus (260 °C) | MPa | 500 |

Table 19: ANNA-B4 mold parameters

6.3.4 Other remarks

- Only a single wave soldering process is allowed for boards populated with the module.
- Boards with combined through-hole technology (THT) components and surface-mount technology (SMT) devices might require THT components to be wave soldered.
- Miniature Wave Selective Solder processes are preferred over traditional wave soldering processes.
- Hand soldering is not recommended.
- Rework is not recommended.
- The modules contain components that are sensitive to Ultrasonic Waves. Use of any ultrasonic processes, like cleaning and welding, might damage the module. Use of ultrasonic processes on an end product integrating this module will void the warranty.

7 Qualifications and approvals

 Approval for the ANNA-B4 module series is currently pending. For further information about the current approval status, see [Country approvals](#).

7.1 Country approvals

The ANNA-B4 module series is certified for use in the following countries/regions:

- Europe (RED) *
- USA (FCC) *
- Canada (ISED) *
- Japan (MIC) *
- Taiwan (NCC) *
- South Korea (KCC) *
- Brazil (ANATEL) *
- Australia and New Zealand (ACMA) *
- South Africa (ICASA) *

* Country approval for ANNA-B4 module series is pending

7.2 European Union regulatory compliance

 **Approvals are pending**

For information about the regulatory compliance of ANNA-B4 series modules against requirements and provisions in the European Union, see also the ANNA-B4 Declaration of Conformity [\[23\]](#).

7.2.1 Radio Equipment Directive (RED) 2014/53/EU

The ANNA-B4 series modules comply with the essential requirements and other relevant provisions of Radio Equipment Directive (RED) 2014/53/EU.

7.2.2 Compliance with the RoHS directive

The ANNA-B4 series modules comply with the Directive 2011/65/EU (EU RoHS 2) and its amendment Directive (EU) 2015/863 (EU RoHS 3).

7.3 FCC and IC compliance







 **Approvals are pending**

This device complies with Part 15 of the FCC Rules and with ISED license-exempt RSS standard(s).

FCC compliance

ANNA-B4 modules are for OEM integrations only. The end product must be professionally installed in such manner that only the authorized antennas can be used.

Three variants of antenna reference designs are available for ANNA-B4 and one of these must be followed for compliance with the ANNA-B4 FCC/IISED modular approval (see Appendix B for details). Two of the reference designs show different variants of implementing internal antenna and one describes how to implement external antenna connector (U.FL. connector).

-  ANNA-B4 series modules are intended for OEM integrators only. End-products that include u-blox modules must be professionally installed in such a way that only the authorized antennas included in the [Pre-approved antennas list](#) can be used.
-  If the antenna connector is easily accessible to the end-user, only Reversed Polarity SMA connectors are allowed in the final end user product.
-  The details of the module implementation in the host device (end-product) should remain confidential. Integrators are reminded not to share the module installation instructions to the end-user of the end-product (host device).
-  Any changes or modifications NOT explicitly APPROVED by u-blox AG may invalidate compliance with FCC rules part 15 and subsequently void the user's authority to operate the equipment.
-  Any changes to hardware, hosts, or co-location configuration may require new radiated emission and SAR evaluation and/or testing.
-  The end-product manufacturer (OEM integrator) is responsible for verifying the end-product compliance with FCC Part 15, subpart B limits for unintentional radiators through an accredited test facility.

7.3.1.1 FCC statement

This device complies with Part 15 of the FCC Rules. Operation is subject to the following two conditions:

1. This device may not cause harmful interference, and
2. This device must accept any interference received, including interference that may cause undesired operation.

This equipment has been tested and found to comply with the limits for a Class B digital device, pursuant to Part 15 of the FCC Rules. These limits are designed to provide reasonable protection against harmful interference in a residential installation. This equipment generates, uses and can radiate radio frequency energy and, if not installed and used in accordance with the instructions, may cause harmful interference to radio communications. However, there is no guarantee that the interference will not occur in a particular installation. If this equipment does cause harmful interference to radio or television reception, which can be determined by turning the equipment off and on, the user is encouraged to correct the interference using either one or more of the following measures:

- Reorient or relocate the receiving antenna
- Increase the separation between the equipment and receiver
- Connect the equipment into an outlet on a circuit different from that to which the receiver is connected.
- Consult the dealer or an experienced radio/TV technician for help.

7.3.2 RF-exposure statement

7.3.2.1 ISED Compliance

This equipment complies with the requirements of IC RSS-102 issue 5 radiation exposure limits set forth for an uncontrolled environment.

-  Having a separation distance of minimum 20 mm between the user and/or bystander and the antenna and /or radiating element ensures that the output power (EIRP.) of ANNA-B5 is below the SAR evaluation Exemption limits defined in RSS-102 issue 5 (Canadian market limits).

7.3.2.2 FCC Compliance

This device complies with the FCC radiation exposure limits set forth for an uncontrolled environment.

-  The maximum output power of ANNA-B4 is below the SAR test exclusion limits presented in KDB 447498 D01v06 applicable for separation distances between 0 mm and 5 mm. Therefore, SAR evaluation is not needed.





KDB 996369 D03 section 2.4 (limited module procedures) is not applicable to the ANNA-B4 series modules.

KDB 996369 D03 section 2.5 (trace antenna designs) is not applicable to the ANNA-B4 series modules.

7.3.3 End product user manual instructions

7.3.3.1 ISED Compliance

The ANNA-B4 module is certified for use in Canada under Innovation, Science and Economic Development Canada (ISED) Radio Standards Specification (RSS) RSS-247 Issue 2 and RSSGen. The host product shall be properly labelled to identify the modules within the host product.

-  The final host device, into which this RF Module is integrated" has to be labeled with an auxiliary label stating the IC of the RF Module, such as" Contains transmitter module IC: 8595A-ANNAB4
-  Le périphérique hôte final, dans lequel ce module RF est intégré "doit être étiqueté avec une étiquette auxiliaire indiquant le CI du module RF, tel que" Contient le module émetteur IC: 8595A-ANNAB4
-  This device contains licence-exempt transmitter(s)/receiver(s) that comply with Innovation, Science and Economic Development Canada's licence-exempt RSS(s). Operation is subject to the following two conditions:
 - (1) This device may not cause interference.
 - (2) This device must accept any interference, including interference that may cause undesired operation of the device.
-  L'émetteur/récepteur exempt de licence contenu dans le présent appareil est conforme aux CNR d'Innovation, Sciences et Développement économique Canada applicables aux appareils radio exempts de licence. L'exploitation est autorisée aux deux conditions suivantes :
 - (1) L' appareil ne doit pas produire de brouillage;
 - (2) L' appareil doit accepter tout brouillage radioélectrique subi, même si le brouillage est susceptible d' en compromettre le fonctionnement.

7.3.4 End product labeling requirements

7.3.4.1 ISED Compliance

The host product shall be properly labelled to identify the modules within the host product. The Innovation, Science and Economic Development Canada certification label of a module shall be clearly visible at all times when installed in the host product; otherwise, the host product must be labelled to display the Innovation, Science and Economic Development Canada certification number for the module, preceded by the word “Contains” or similar wording expressing the same meaning, as shown in [Figure 26](#).

Le produit hôte devra être correctement étiqueté, de façon à permettre l'identification des modules qui s'y trouvent.

L'étiquette d'homologation d'un module d'Innovation, Sciences et Développement économique Canada devra être posée sur le produit hôte à un endroit bien en vue, en tout temps. En l'absence d'étiquette, le produit hôte doit porter une étiquette sur laquelle figure le numéro d'homologation du module d'Innovation, Sciences et Développement économique Canada, précédé du mot « contient », ou d'une formulation similaire allant dans le même sens et qui va comme suit:

| |
|---|
| This device contains FCC ID: XPYNINAB4 IC: 8595A-ANNAB4 |
|---|

Figure 26: Example of an end product label

7.3.4.2 FCC Compliance

For an end product that uses the ANNA-B4 modules, there must be a label containing, at least, the information shown in [Figure 26](#).

The label must be affixed on an exterior surface of the end product such that it will be visible upon inspection in compliance with the modular approval guidelines developed by the FCC.

 In accordance with 47 CFR § 15.19, the end product shall bear the following statement in a conspicuous location on the device:

"This device complies with Part 15 of the FCC Rules. Operation is subject to the following two conditions;

- (1) this device may not cause harmful interference, and*
- (2) this device must accept any interference received, including interference that may cause undesired operation."*

When the device is so small or for such use that it is not practicable to place the statement above on it, the information shall be placed in a prominent location in the instruction manual or pamphlet supplied to the user or, alternatively, shall be placed on the container in which the device is marketed.

In case, where the final product will be installed in locations where the end-user is not able to see the FCC ID and/or this statement, the FCC ID and the statement shall also be included in the end product manual.

The following statement must be included in the end-user manual or guide:

Changes or modifications to this unit not expressly approved by the party responsible for compliance could void the user's authority to operate the equipment.

This equipment has been tested and found to comply with the limits for a Class B digital device, pursuant to part 15 of the FCC Rules. These limits are designed to provide reasonable protection against harmful interference in a residential installation. This equipment generates uses and can radiate radio frequency energy and, if not installed and used in accordance with the instructions, may cause harmful interference to radio communications. However, there is no guarantee that interference will not occur in a particular installation. If this equipment does cause harmful interference to radio or television reception, which can be determined by turning the equipment off and on, the user is encouraged to try to correct the interference by one or more of the following measures:

- Reorient or relocate the receiving antenna.
- Increase the separation between the equipment and receiver.
- Connect the equipment into an outlet on a circuit different from that to which the receiver is connected.
- Consult the dealer or an experienced radio/TV technician for help.

7.3.5 FCC and IC IDs

| Model | FCC ID | IC |
|-----------|-------------------|------------------|
| ANNA-B402 | FCC ID: XPYANNAB4 | IC: 8595A-ANNAB4 |
| ANNA-B412 | FCC ID: XPYANNAB4 | IC: 8595A-ANNAB4 |

Table 20: FCC ID and IC for the ANNA-B4 modules

7.3.6 End product compliance

7.3.6.1 General requirements

- Any changes to hardware, hosts or co-location configuration may require new radiated emission and SAR evaluation and/or testing.
- Only authorized antenna(s) may be used.
- Any notification to the end user about how to install or remove the integrated radio module is NOT allowed.
- The modular transmitter approval of ANNA-B4 does not exempt the end product from being evaluated against applicable regulatory demands. The evaluation of the end product shall be performed with the ANNA-B4 module installed and operating in a way that reflects the intended end product use case. The upper frequency measurement range of the end product evaluation is the 5th harmonic of 2.4 GHz as declared in 47 CFR Part 15.33 (b)(1).
- The following requirements apply to all products that integrate a radio module:
 - Subpart B - UNINTENTIONAL RADIATORS
To verify that the composite device of host and module complies with the requirements of FCC part 15B the integrator shall perform sufficient measurements using ANSI 63.4-2014.
 - Subpart C - INTENTIONAL RADIATORS
It is required that the integrator carry out sufficient verification measurements using ANSI 63.10-2013 to validate that the fundamental and out of band emissions of the transmitter part of the composite device complies with the requirements of FCC part 15C.
- When the items listed above are fulfilled the host manufacturer can use the authorization procedures presented in Table 1 of 47 CFR Part 15.101.

7.3.6.2 Co-location (simultaneous transmission)

If the module is to be co-located with another transmitter, additional measurements for simultaneous transmission are required.

7.4 Japan radio equipment compliance

Approvals are pending

7.4.1 Compliance statement

ANNA-B4 series modules comply with the Japanese Technical Regulation Conformity Certification of Specified Radio Equipment (ordinance of MPT N°. 37, 1981), Article 2, Paragraph 1:

- Item 19 "2.4 GHz band wide band low power data communication system".

7.4.2 End product labelling requirement

End products based on ANNA-B4 series modules and targeted for distribution in Japan must be affixed with a label with the "Giteki" marking, as shown in [Figure 27](#). The marking must be visible for inspection.



Figure 27: Giteki mark and ANNA-B4 MIC certification number

7.4.3 End product user manual requirement

As the MIC ID is not included on the ANNA-B4 marking, the end product manufacturer must include a copy of the ANNA-B4 Japan Radio Certificate in the end product technical documentation.

7.5 NCC Taiwan compliance

Approvals are pending

7.5.1 Taiwan NCC Warning Statement

- 經型式認證合格之低功率射頻電機，非經許可，公司、商號或使用者均不得擅自變更頻率、加大功率或變更原設計之特性及功能。
- 低功率射頻電機之使用不得影響飛航安全及干擾合法通信；經發現有干擾現象時，應立即停用，並改善至無干擾時方得繼續使用。前項合法通信，指依電信法規定作業之無線電通信。低功率射頻電機須忍受合法通信或工業、科學及醫療用電波輻射性電機設備之干擾。

Statement translation:

- Without permission granted by the NCC, any company, enterprise, or user is not allowed to change frequency, enhance transmitting power, or alter original characteristic as well as performance to an approved low power radio-frequency device.
- The low power radio-frequency devices shall not influence aircraft security and interfere legal communications; If any interference is found or suspected, the user shall immediately cease operating the equipment until the interference has been prevented. The said legal communications means radio communications is operated in compliance with the Telecommunications Act. The low power radio-frequency devices must be susceptible with the interference from legal communications or ISM radio wave radiated devices.

7.5.2 Labeling requirements for end product

End products based on ANNA-B4 series modules and targeted for distribution in Taiwan must carry labels with the textual and graphical elements shown below.

Contains Transmitter Module

內含發射器模組:  xxxxxxxxyyyyyyy

Other wording can be used, but only if the meaning of original messaging remains unchanged. The label must be physically attached to the product and made clearly visible for inspection.

7.6 KCC South Korea compliance

Approvals are pending

ANNA-B4 series modules are certified by the Korea Communications Commission (KCC).

End products based on ANNA-B4 series modules and targeted for distribution in South Korea must carry labels containing the KCC logo and certification number, as shown below. This information must also be included in the product user manuals.



 The height of the KCC logo must be at least 5 mm.

7.7 Brazil compliance

Approvals are pending

End products based on ANNA-B4 series modules and targeted for distribution in Brazil must carry labels that include the Anatel logo, ANNA-B4 Homologation number: xxxxx-xx-yyyyy and a statement claiming that the device may not cause harmful interference but must accept it (Resolution No 506).



“Este equipamento opera em caráter secundário, isto é, não tem direito a proteção contra interferência prejudicial, mesmo de estações do mesmo tipo, e não pode causar interferência a sistemas operando em caráter primário.”

Statement translation:

“This equipment operates on a secondary basis and, consequently, must accept harmful interference, including from stations of the same kind, and may not cause harmful interference to systems operating on a primary basis.”

When the device is so small or for such use that it is not practicable to place the statement above on the label, the information shall be placed in a prominent location in the instruction manual or pamphlet supplied to the user or, alternatively, shall be placed on the container in which the device is marketed.

In cases where the final product is to be installed in locations where the end user is unable to see the Anatel logo, ANNA-B4 Homologation number and/or statement, these graphical and textual elements must be included in the end product manual.

7.8 Australia and New Zealand regulatory compliance

Approvals are pending



ANNA-B4 modules are compliant with the standards made by the Australian Communications and Media Authority (ACMA).

The modules are compliant with AS/NZS 4268:2012 standard – Radio equipment and systems – Short range devices – Limits and methods of standard measurement. The test reports for ANNA-B4 modules can be used as part of the product certification and compliance folder. [Contact](#) your local support team for more information.

To meet the overall Australian and/or New Zealand end product compliance standards, the integrator must create a compliance folder containing all the relevant compliance test reports such as RF, EMC, electrical safety and DoC (Declaration of Conformity). It is the responsibility of the integrator to know what is required in the compliance folder for ACMA compliance.

For more information on Australia compliance, refer to the Australian Communications and Media Authority web site <http://www.acma.gov.au/>.

For more information on New Zealand compliance, refer to the New Zealand Radio Spectrum Management Group web site www.rsm.govt.nz.

7.9 South Africa regulatory compliance

Approvals are pending

ANNA-B4 series modules are compliant and certified by the Independent Communications Authority of South Africa (ICASA). End products that are made available for sale or lease or supplied in any other manner in South Africa shall have a legible label permanently affixed to its exterior surface. The label shall include the ICASA logo and the ICASA issued license number, as shown in the figure below. The minimum width and height of the ICASA logo shall be 3 mm. The approval labels must be purchased by the customer's local representative directly from the approval authority ICASA.

A sample of a ANNA-B4 ICASA label is shown below:



More information on registration as a Responsible Integrator and labeling requirements can be found at the following website:

Independent Communications Authority of South Africa (ICASA) web site - <https://www.icasa.org.za>

7.10 Bluetooth qualification

Approvals are pending



ANNA-B4 module series modules have been qualified as an end product in accordance with the Bluetooth 5.1 specification.

| Product type | QD ID | Listing date |
|--------------|-------|--------------|
| End product | TBD | TBD |

Table 21: ANNA-B4 series Bluetooth qualified design ID

8 Pre-approved antennas list

This chapter lists the external antennas that are pre-approved for use together with ANNA-B4 series modules.

Note that not all antennas are approved for use in all markets/regions.

This radio transmitter [IC: 8595A-ANNAB4] has been approved by Innovation, Science and Economic Development Canada to operate with the antenna types listed below, with the maximum permissible gain indicated. Antenna types not included in this list that have a gain greater than the maximum gain indicated for any type listed are strictly prohibited for use with this device.

Cet émetteur radio [IC: 8595A-ANNAB4] a été approuvé par Innovation, Sciences et Développement économique Canada pour fonctionner avec les types d'antenne énumérés ci-dessous, avec le gain maximal admissible indiqué. Les types d'antenne non inclus dans cette liste qui ont un gain supérieur au gain maximum indiqué pour tout type répertorié sont strictement interdits pour une utilisation avec cet appareil.

Approvals are pending

8.1 Approved antennas

| AT1608-A2R4NAA - ANNA-B4 internal antenna | |
|---|--|
| Gain | +0.5 dBi |
| Comment | Internal antenna on ANNA-B4. The internal antenna should not be mounted inside a metal enclosure. |
| Approval | FCC, IC, RED, MIC, NCC, KCC, ANATEL, ACMA and ICASA |



| FXP75.07.0045B | |
|----------------|--|
| Manufacturer | Taoglas |
| Gain | +2.5 dBi |
| Impedance | 50 Ω |
| Size | 5.9 x 4.1 x 0.24 mm |
| Type | Patch, Flexfilm |
| Connector | U.FL. |
| Cable length | 45 mm |
| Comment | For best performance, this antenna should be attached to a plastic enclosure or part. It should be mounted on a U.FL connector and not inside a metal enclosure. For more information, see antenna data sheet. |
| Approval | FCC, IC, RED, MIC, NCC, KCC, ANATEL, ACMA and ICASA |



| FXP74.07.0100A | |
|----------------|---------------------|
| Manufacturer | Taoglas |
| Gain | +4.0 dBi |
| Impedance | 50 Ω |
| Size | 47.0 x 7.0 x 0.1 mm |
| Type | Patch, Flexfilm |

| | |
|--------------|---|
| Connector | U.FL. |
| Cable length | 100 mm |
| Comment | Should be attached to a plastic enclosure or part for best performance. For more information, see antenna data sheet. Should not be mounted inside a metal enclosure. To be mounted on a U.FL connector. |
| Approval | FCC, IC, RED, MIC, KCC, ANATEL, ACMA and ICASA |



PC17.07.0070A

| | |
|--------------|--|
| Manufacturer | Taoglas |
| Gain | +0.9 dBi |
| Impedance | 50 Ω |
| Size | 24.0 x11.0x 0.8 mm |
| Type | Patch, PCB |
| Connector | U.FL. |
| Cable length | 70 mm |
| Comment | For best performance, this antenna should be attached to a plastic enclosure or part. It should be mounted on a U.FL connector and not inside a metal enclosure. For more information, see antenna data sheet. |
| Approval | FCC, IC, RED, MIC, NCC, KCC, ANATEL, ACMA and ICASA |



FXP72.07.0053A

| | |
|--------------|--|
| Manufacturer | Taoglas |
| Gain | +5.0 dBi |
| Impedance | 50 Ω |
| Size | 31.0 x 31.0 x 0.1 mm |
| Type | Patch, Flexfilm |
| Connector | U.FL. |
| Cable length | 53 mm |
| Comment | For best performance, this antenna should be attached to a plastic enclosure or part. It should be mounted on a U.FL connector and not inside a metal enclosure. For more information, see antenna data sheet. |
| Approval | FCC, IC, RED, MIC, KCC, ANATEL, ACMA and ICASA |

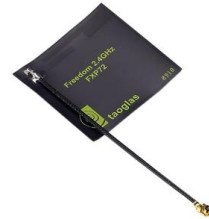

9 Product testing

9.1 u-blox in-line production testing

As part of our focus on high quality products, u-blox maintain stringent quality controls throughout the production process. This means that all units in our manufacturing facilities are fully tested and that any identified defects are carefully analyzed to improve future production quality.

The Automatic test equipment (ATE) deployed in u-blox production lines logs all production and measurement data – from which a detailed test report for each unit can be generated. [Figure 28](#) shows the ATE typically used during u-blox production.

u-blox in-line production testing includes:

- Digital self-tests (firmware download, MAC address programming)
- Measurement of voltages and currents
- Functional tests (host interface communication)
- Digital I/O tests
- Measurement and calibration of RF characteristics in all supported bands, including RSSI calibration, frequency tuning of reference clock, calibration of transmitter power levels, etc.
- Verification of Wi-Fi and Bluetooth RF characteristics after calibration, like modulation accuracy, power levels, and spectrum, are checked to ensure that all characteristics are within tolerance when the calibration parameters are applied.



Figure 28: Automatic test equipment for module test

9.2 OEM manufacturer production test

As all u-blox products undergo thorough in-series production testing prior to delivery, OEM manufacturers do not need to repeat any firmware tests or measurements that might otherwise be necessary to confirm RF performance. Testing over analog and digital interfaces is also unnecessary during an OEM production test.

OEM manufacturer testing should ideally focus on:

- Module assembly on the device; it should be verified that:
 - Soldering and handling process did not damage the module components
 - All module pins are well soldered on application board
 - There are no short circuits between pins
- Component assembly on the device; it should be verified that:
 - Communication with host controller can be established
 - The interfaces between module and device are working
 - Overall RF performance test of the device including antenna

In addition to this testing, OEMs can also perform other dedicated tests to check the device. For example, the measurement of module current consumption in a specified operating state can identify a short circuit if the test result deviates that from that taken against a “Golden Device”.

The standard operational module firmware and test software on the host can be used to perform functional tests (communication with the host controller, check interfaces) and perform basic RF performance testing. Special manufacturing firmware can also be used to perform more advanced RF performance tests.

9.2.1 “Go/No go” tests for integrated devices

A “Go/No go” test compares the signal quality of the Device under Test (DUT) with that of “Golden Device” in a location with a known signal quality. This test can be performed after establishing a connection with an external device.

A very simple test can be performed by just scanning for a known Bluetooth low energy device and checking that the signal level (Received Signal Strength Indicator (RSSI)) is acceptable.

 Tests of this kind may be useful as a “go/no go” test but are not appropriate for RF performance measurements.

Go/No go tests are suitable for checking communication between the host controller and the power supply. The tests can also confirm that all components on the DUT are well soldered.

A basic RF functional test of the device that includes the antenna can be performed with standard Bluetooth low energy devices configured as remote stations. In this scenario, the device containing ANNA-B4 and the antennas should be arranged in a fixed position inside an RF shield box. The shielding prevents interference from other possible radio devices to ensure stable test results.

Appendix

A Glossary

| Abbreviation | Definition |
|--------------|---|
| ABS | Acrylonitrile butadiene styrene |
| ADC | Analog to Digital Converter |
| ATE | Automatic Test Equipment |
| LE | Bluetooth Low Energy |
| CTS | Clear To Send |
| DCX | Data/Command Signal |
| DFU | Device Firmware Update |
| DDR | Dual-Data Rate |
| DUT | Device Under Test |
| EMC | Electro Magnetic Compatibility |
| EMI | Electro Magnetic Interference |
| ESD | Electro Static Discharge |
| FCC | Federal Communications Commission |
| GATT | Generic ATtribute profile |
| GND | Ground |
| GPIO | General Purpose Input/Output |
| I2C | Inter-Integrated Circuit |
| I2S | Inter-IC sound interface |
| IDE | Integrated Development Environment |
| IEEE | Institute of Electrical and Electronics Engineers |
| LDO | Low Drop Out |
| LED | Light-Emitting Diode |
| MAC | Media Access Control |
| MISO | Master Input, Slave Output |
| MOSI | Master Output, Slave Input |
| MSL | Moisture Sensitivity Level |
| NFC | Near Field Communication |
| NSMD | Non Solder Mask Defined |
| PCB | Printed Circuit Board |
| PIFA | Planar Inverted-F Antenna |
| PC | Polycarbonate |
| QDEC | Quadrature DECoder |
| QSPI | Quad Serial Peripheral Interface |
| RF | Radio Frequency |
| RoHS | Restriction of Hazardous Substances |
| RSSI | Received Signal Strength Indicator |
| RTS | Request to Send |
| RXD | Receive Data |
| SCL | Signal Clock |
| SWD | Serial Wire Debug |
| SDL | Specification and Description Language |

| Abbreviation | Definition |
|--------------|--|
| SMA | SubMiniature version A |
| SMD | Solder Mask Defined |
| SMPS | Switching Mode Power Supply |
| SMT | Surface-Mount Technology |
| SPI | Serial Peripheral Interface |
| SWD | Serial Wire Debug |
| Thread | Networking protocol for Internet of Things (IoT) "smart" home automation devices to communicate on a local wireless mesh network |
| THT | Through-Hole Technology |
| TRP | Total Radio Power |
| TXD | Transmit Data |
| UART | Universal Asynchronous Receiver/Transmitter |
| UICR | User Information Configuration Registers |
| USB | Universal Serial Bus |
| VCC | IC power-supply pin |
| VSWR | Voltage Standing Wave Ratio |
| Zigbee | Open standard protocol, full-stack solution for a majority of large smart home ecosystem providers |

Table 22: Explanation of the abbreviations and terms used

B Antenna reference designs

Designers can take full advantage of the ANNA-B4 Single-Modular Transmitter certification approval by integrating the u-blox reference design into their products. This approach requires compliance with the following rules:

- Only listed antennas can be used. For the list of approved antennas, see section [Approved antennas](#).
- Schematics and parts used in the design must be identical to those used in the u-blox reference design. RF components may show different behavior at the frequencies of interest due to different construction and parasitic; use only parts validated by u-blox for the antenna matching.
- PCB layout must be identical to that provided by u-blox. Implement one of the reference designs included in this section or [contact](#) u-blox.
- The designer must use the stack-up provided by u-blox. RF traces on the carrier PCB are part of the certified design.

Three different reference designs are available:

- Design the internal antenna with the module in the corner of the PCB
- Design the internal antenna with the module along the edge of the PCB
- Include an external antenna into the design with a short trace to a U.FL connector

B.1 Internal antenna reference design with module at PCB corner

When using the ANNA-B4 together with this antenna reference design, the circuit trace layout must be made in strict compliance with the instructions below.

This section describes where the critical copper traces are positioned on the reference design. It is important not to route any traces in any layer in the antenna strip clearance area.

Figure 29 shows the top-layer for the corner version of the internal antenna reference design. Traces and vias for other signals not present.

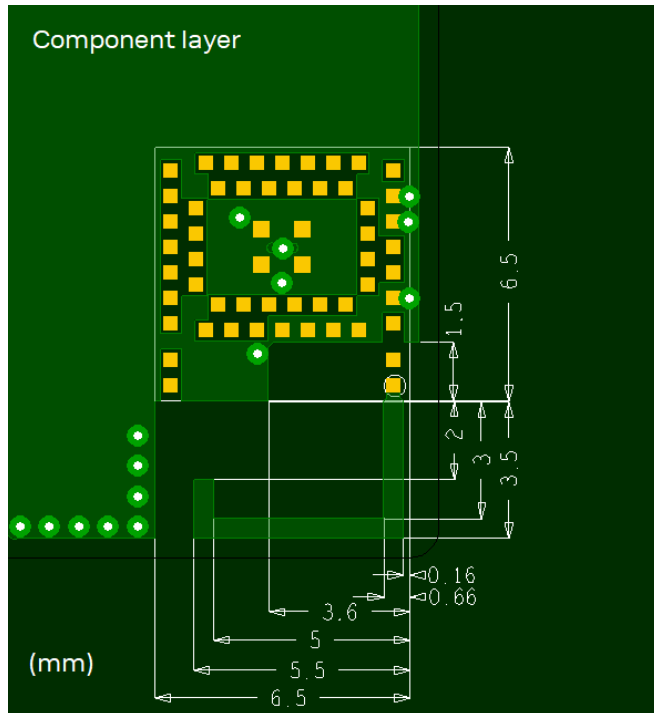

Figure 29: Reference design for internal antenna, corner version, top layer

Figure 30 shows the other layers for the corner version of the internal antenna reference design. Trace vias for other signals are not present.

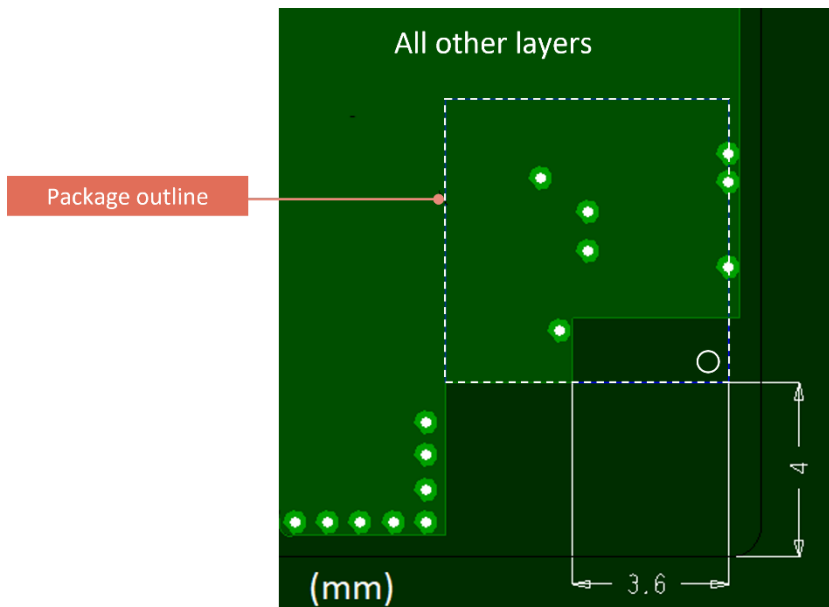

Figure 30: Reference design for internal antenna, corner version, other layer

B.2 Internal antenna reference design with module along PCB edge

When using the ANNA-B4 together with this antenna reference design, the circuit trace layout must be made in strict compliance with the instructions below. This section describes where the critical copper traces are positioned on the reference design.

Figure 31 shows the top layer for the edge version of the internal antenna reference design.

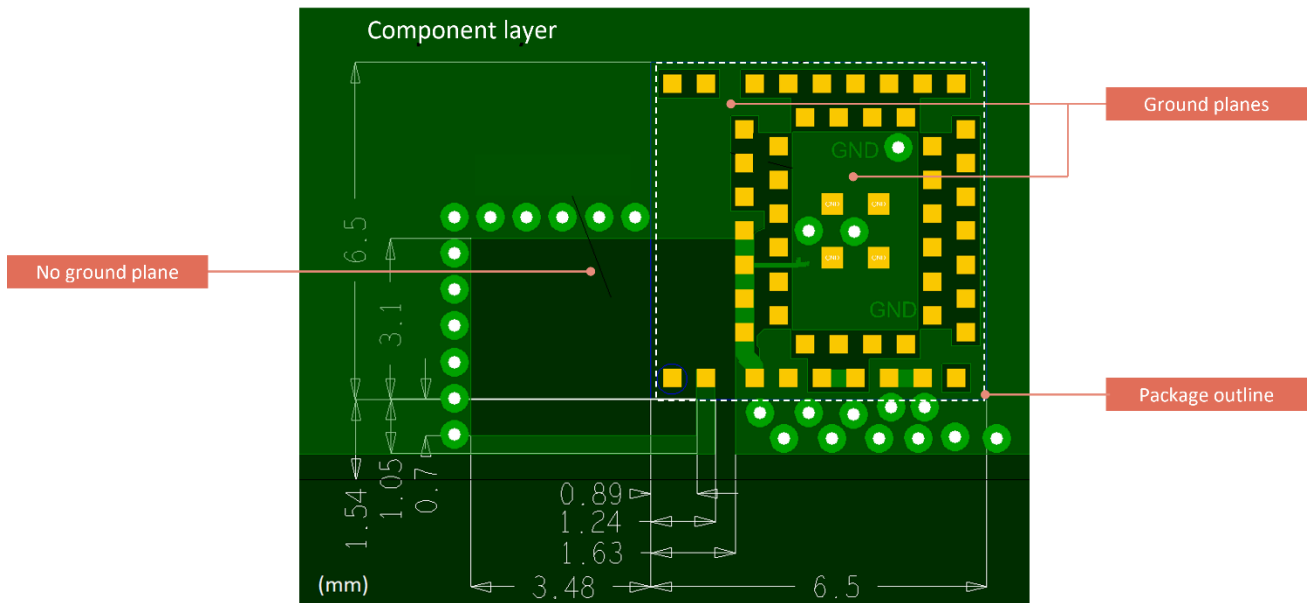

Figure 31: Reference design for internal antenna, edge version, top layer

Figure 32 shows the GND layers for the edge version of the internal antenna reference design.

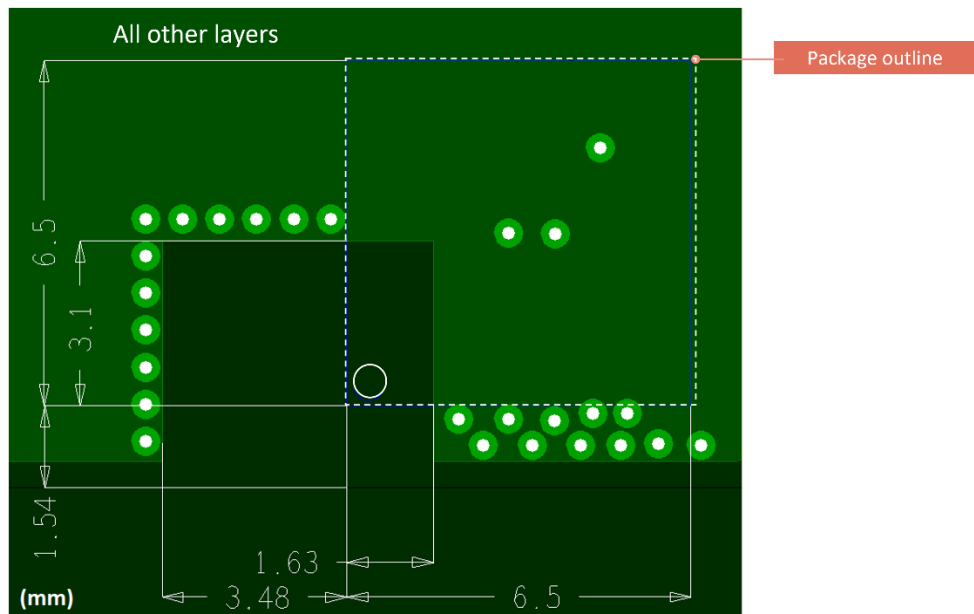

Figure 32: Reference design for internal antenna, edge version, GND layers

B.3 Reference design for external antennas (U.FL connector)

When using the ANNA-B4 together with this antenna reference design, the circuit trace layout must be made in strict compliance with the instructions below. This section describes where the critical components and copper traces are positioned on the reference design.

All the components placed on each RF trace must be kept as shown in the reference design. The reference design uses a micro coaxial connector that is connected to the external antenna using a 50 Ω pigtail cable.

| Part | Manufacturer | Description |
|------------------|--------------|--|
| U.FL-R-SMT-1(10) | Hirose | Coaxial Connector, 0 – 6 GHz, for external antenna |

Table 23: U.FL connector used in the ANNA-B4 reference design

Figure 33 shows the top layer of the external antenna reference design. Note that the top left-hand pads, pins 34 and 35 (USB DP and USB DM), should not be connected to GND on ANNA-B4.

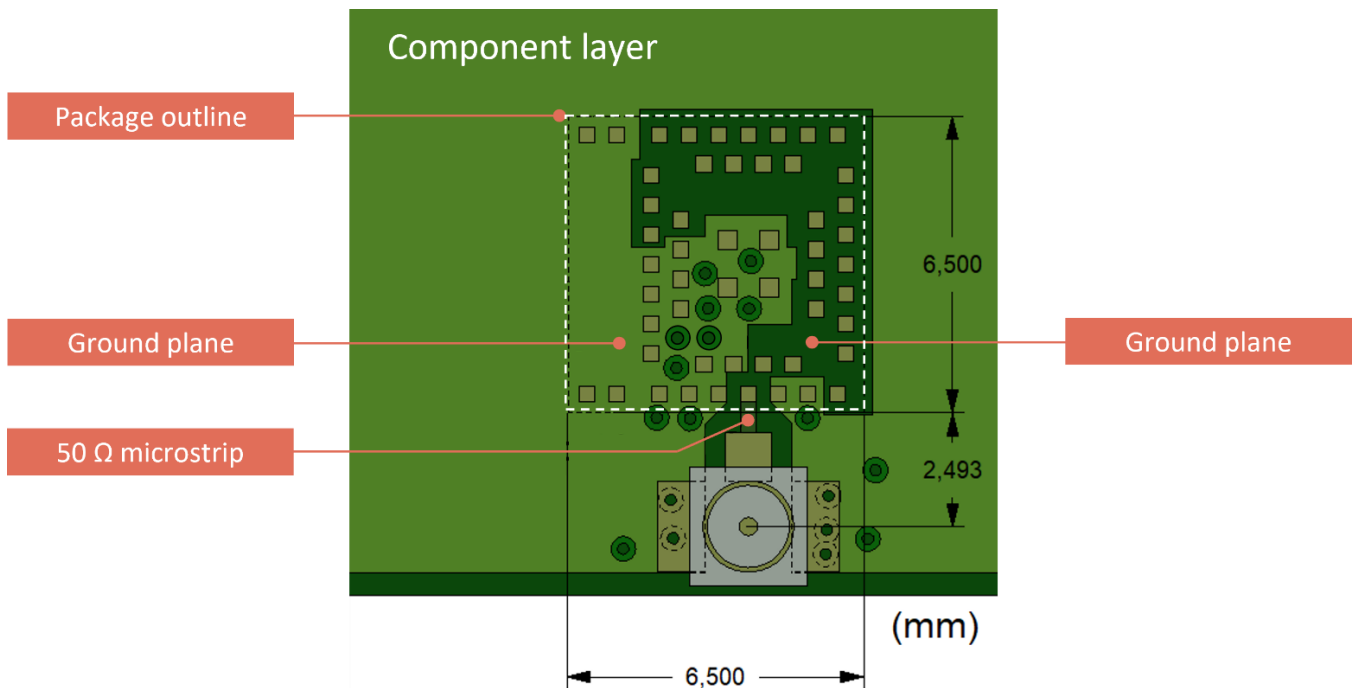

Figure 33: Top-layer reference design for external antenna

Figure 34 shows the GND layer of the external antenna reference design.

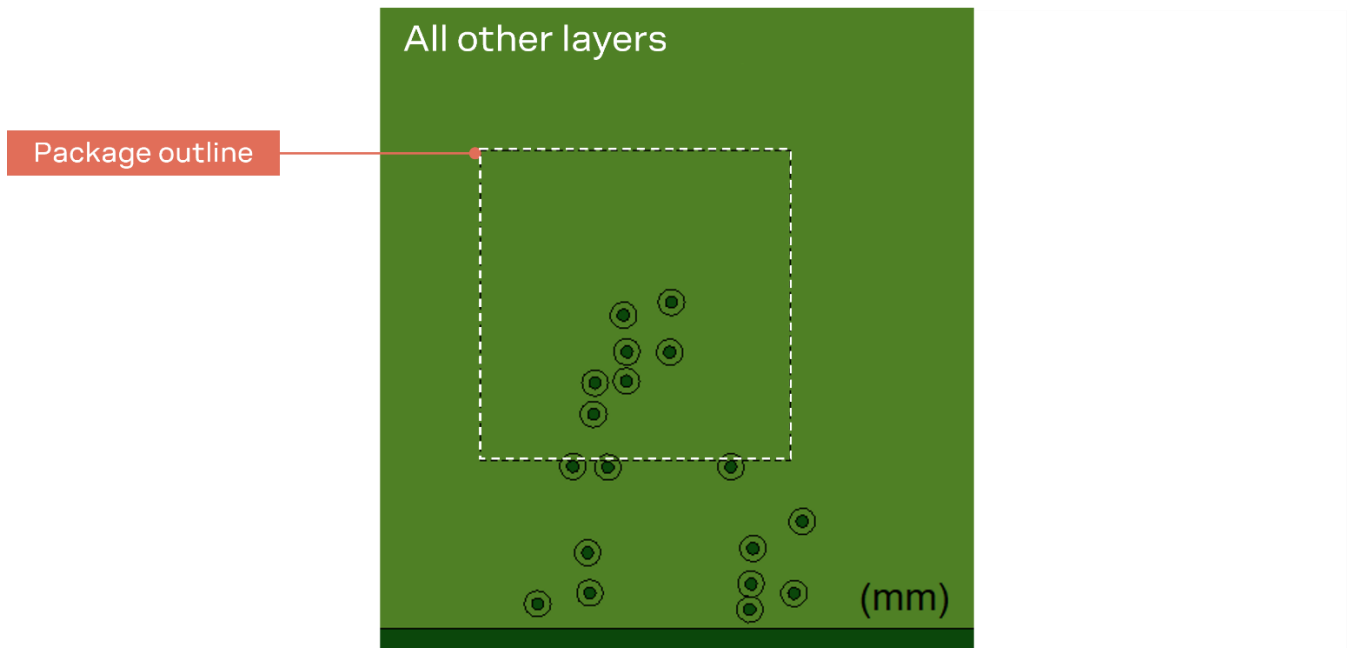

Figure 34: GND layer reference design for external antenna

The 50 Ω coplanar microstrip dimensions used in the reference design are described in Figure 35 and Table 24. The GND plane beneath the RF trace must be filled.

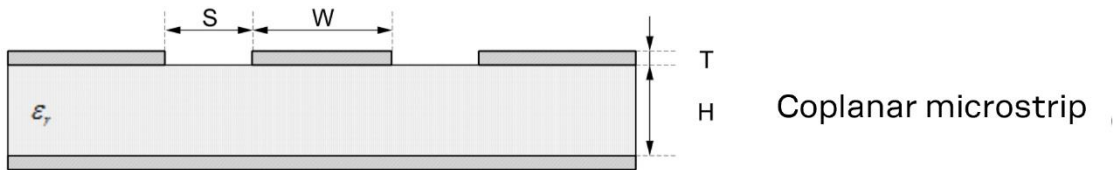

Figure 35: Coplanar microstrip dimension specification

| Item | Value |
|--------------|--|
| T | Solder mask: 20 +/- 10 μm Copper film and plating/surface coating: 35 +/- 15 μm |
| ϵ_r | 3.77 +/- 0.5 |

Table 24: Coplanar micro-strip specification

B.4 Examples of application ground plane miniaturizations

As the antenna characteristics are dependent on the dimensions of the PCB, especially for small-sized PCBs, the physical size of the PCB must be carefully considered to ensure a sufficient antenna performance for each application.

The following examples show the achievable antenna performance for reduced PCB sizes. The antenna is ideally characterized with a full 3D test in an RF diagnostic chamber. If this is not feasible, an in-door test of the application in a multipath faded environment is often sufficient to confirm the performance and behavior of the product. Optional range measurements can also be taken with an open-field, line of sight, to confirm the antenna gain and efficiency.

In most cases, a spheric 3D antenna radiation pattern is ideal for products operating in environments where multipath fading occurs.

ANNA-B4 has an identical antenna integration as ANNA-B1 and the below study of antenna gain is also applicable on ANNA-B4. However, the higher output power (+8 dBm) of ANNA-B4 needs to be added to the TRP measurements shown in [Figure 37](#) and [Table 25](#) and also considered when comparing operating range which are based on ANNA-B1 (+4 dBm).

B.4.1 Example application 1

The C8_1 board with ANNA-B1 module in the corner, mounted to the left as shown in [Figure 36](#) is an example that shows what can be achieved by shrinking the board size.

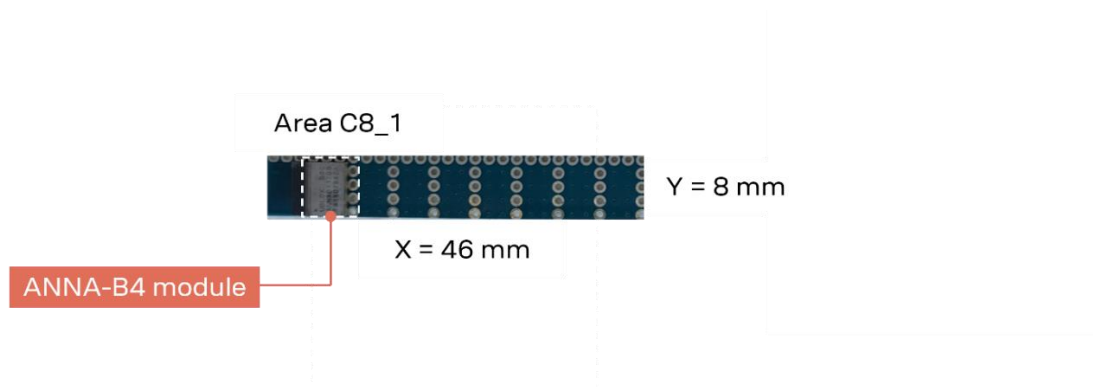

Figure 36: Ground plane miniaturization example

[Figure 37](#) shows the correlation between the total radiated power (TRP) and PCB length in wavelengths (x). The C8_1 board radiates a peak power of -5.67 dBm when it has a length is 0.75 wavelengths and width of 0.14 wavelengths, which corresponds to a physical size of 46 mm and 8 mm respectively. Additionally, the TRP patterns of the C8_1 board illustrates a nice round even shape as shown in [Table 25](#).

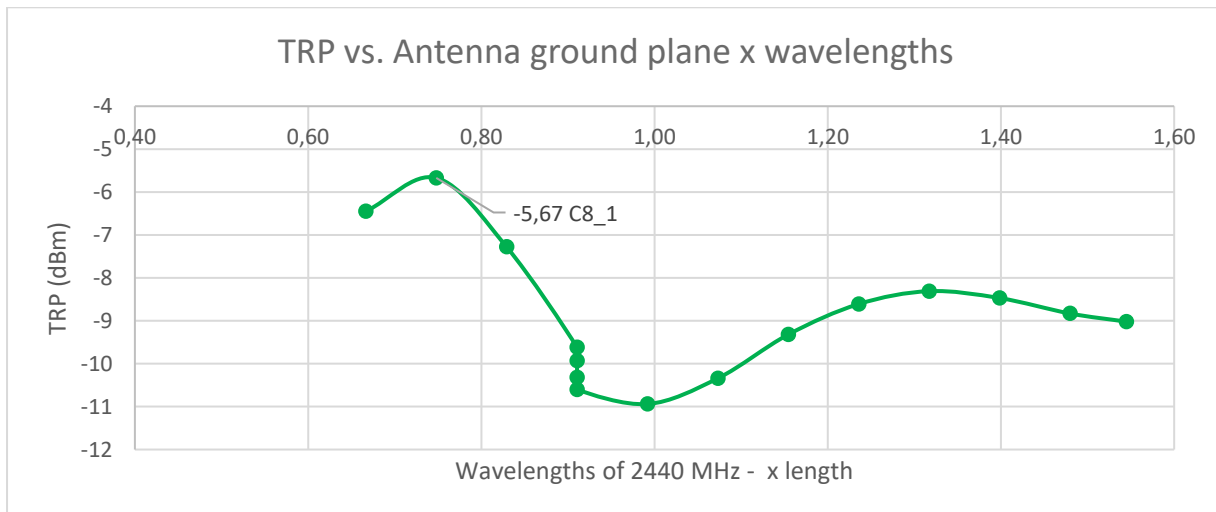
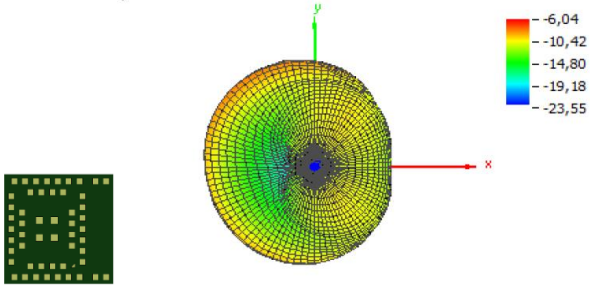

Figure 37: ANNA-B1 peak TRP is reached with the C8_1 PCB with a length equal to ~0.75 wavelengths

[Figure 37](#) shows the total radiated power (TRP) patterns for the PCB. The operating range achieved with this board is ~250 m with ANNA-B1.

Table 25 shows the 3D antenna radiation patterns of the C8_1 PCB. By integrating the graph the Total Radio Power (TRP) is achieved; in this case, -5.67 dBm.

Theta = 0, Phi = 0



Theta = 180, Phi = 0

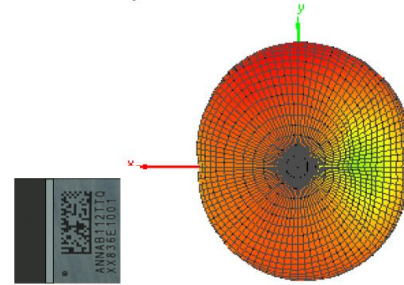

Theta = 90, Phi = 0

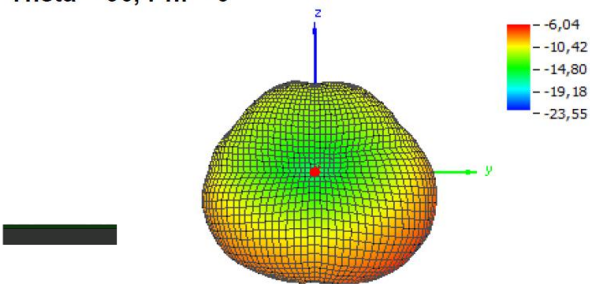

Theta = 90, Phi = 180

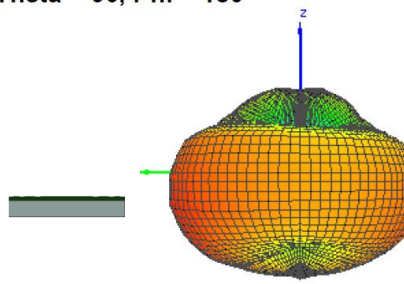

Theta = 90, Phi = 270

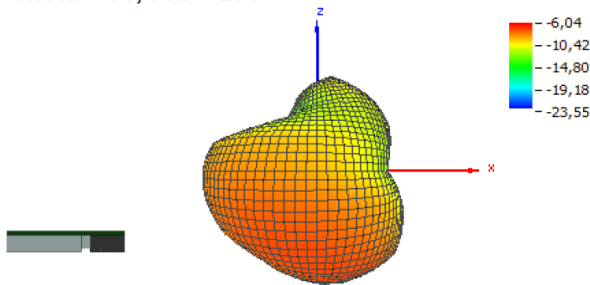

Theta = 90, Phi = 90

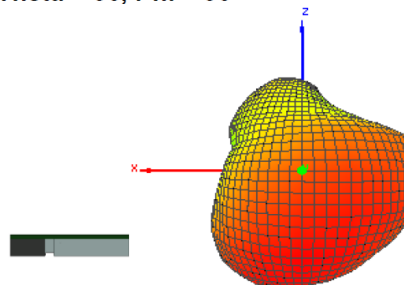

Table 25: 3D antenna radiation patterns for the C8_1 PCB

B.4.2 Example application 2

Figure 38 shows a miniaturized application design used for evaluation of TRP and range. This tiny design with a 7.5 x 12 mm PCB size gives with ANNA-B1 a TRP of -8.4 dBm and ~100 m range. The antenna radiation characteristic of ANNA-B4 and ANNA-B1 is the same however the higher power of ANNA-B4 shall be considered when comparing absolute levels of TRP and range. The 4 dB higher output level of ANNA-B4 will in theory give roughly a bit more than ~150 m range.



Figure 38: A tiny ANNA-B1 application including coin cell battery

Table 26 shows the antenna radiation patterns for the tiny ANNA-B1 module.

Theta = 60, Phi = 45

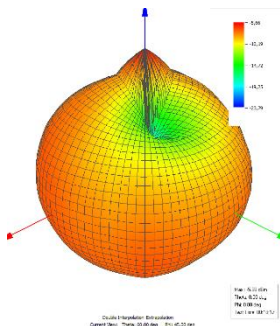

Theta = 1.4, Phi = 189.5

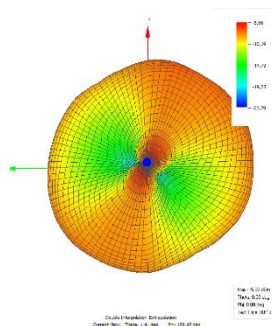



Table 26: Antenna radiation patterns of the tiny ANNA-B1

Related documentation

- [1] u-connectXpress AT commands manual, [UBX-14044127](#)
- [2] u-connectXpress software user guide, [UBX-16024251](#)
- [3] ANNA-B402 product summary, [UBX-20017979](#)
- [4] ANNA-B412 product summary, [UBX-21025292](#)
- [5] ANNA-B402 data sheet, [UBX-20032372](#)
- [6] ANNA-B412 data sheet, [UBX-21028698](#)
- [7] EVK-ANNA-B4 user guide, [UBX-21008123](#)
- [8] RC oscillator configuration for nRF5 open CPU modules, [UBX-20009242](#)
- [9] JEDEC J-STD-020C - Moisture/Reflow Sensitivity Classification for Non Hermetic Solid State Surface Mount Devices
- [10] [IEC EN 61000-4-2](#) - Electromagnetic compatibility (EMC) - Part 4-2: Testing and measurement techniques – Electrostatic discharge immunity test
- [11] ETSI EN 301 489-1 - Electromagnetic compatibility and Radio spectrum Matters (ERM); ElectroMagnetic Compatibility (EMC) standard for radio equipment and services; Part 1: Common technical requirements
- [12] IEC61340-5-1 - Protection of electronic devices from electrostatic phenomena – General requirements
- [13] ETSI EN 60950-1:2006 - Information technology equipment – Safety – Part 1: General requirements
- [14] JESD51 – Overview of methodology for thermal testing of single semiconductor devices
- [15] u-connectXpress user guide, [UBX-16024251](#)
- [16] Using the public IEEE address from UICR, application note [UBX-19055303](#)
- [17] u-blox shortrange open CPU github repository, <https://github.com/u-blox/u-blox-sho-OpenCPU>
- [18] u-connectXpress bootloader protocol specification, [UBX-17065404](#)
- [19] s-center user guide, [UBX-16012261](#)
- [20] Zephyr Project, <https://www.zephyrproject.org/>
- [21] Zephyr Project Documentation, <https://docs.zephyrproject.org>
- [22] Packaging information reference guide, [UBX-14001652](#)
- [23] ANNA-B4 Declaration of Conformity, [UBX-21051032](#)
- [24] nRF Connect SDK page at Nordic Semiconductor, <https://www.nordicsemi.com/Software-and-tools/Software/nRF-Connect-SDK>
- [25] u-blox shortrange open CPU github repository, <https://github.com/u-blox/u-blox-sho-OpenCPU>
- [26] nRF52833 Soc Product Specification:
https://infocenter.nordicsemi.com/index.jsp?topic=%2Fps_nrf52833%2Fkeyfeatures_html5.html

 For product change notifications and regular updates of u-blox documentation, register on our website, www.u-blox.com.

Revision history

| Revision | Date | Name | Comments |
|----------|-------------|------------|--|
| R01 | 19-Oct-2021 | mape, lber | Initial release |
| R02 | 22-Dec-2021 | lber | Restructuring of antenna section. Removed redundant voltage regulator information. Added new chapter to describe ANNA-B1 to ANNA-B4 migration . Revised Product features summary, Design-in checklists , Handling and soldering chapter. |
| R03 | 28-Jan-2022 | mape | Product specifications updated according to Data Sheet R04 (Internal antenna gain, max radiated output power with external antenna, RX sensitivity). Added Zephyr section. Added Low frequency clock autosense information for u-connectXpress. |

Contact

For complete contact information, visit us at www.u-blox.com.

u-blox Offices

North, Central and South America

u-blox America, Inc.

Phone: +1 703 483 3180

E-mail: info_us@u-blox.com

Regional Office West Coast:

Phone: +1 408 573 3640

E-mail: info_us@u-blox.com

Technical Support:

Phone: +1 703 483 3185

E-mail: support_us@u-blox.com

Headquarters

Europe, Middle East, Africa

u-blox AG

Phone: +41 44 722 74 44

E-mail: info@u-blox.com

Support: support@u-blox.com

Asia, Australia, Pacific

u-blox Singapore Pte. Ltd.

Phone: +65 6734 3811

E-mail: info_ap@u-blox.com

Support: support_ap@u-blox.com

Regional Office Australia:

Phone: +61 3 9566 7255

E-mail: info_au@u-blox.com

Support: support_au@u-blox.com

Regional Office China (Beijing):

Phone: +86 10 68 133 545

E-mail: info_cn@u-blox.com

Support: support_cn@u-blox.com

Regional Office China (Chongqing):

Phone: +86 23 6815 1588

E-mail: info_cn@u-blox.com

Support: support_cn@u-blox.com

Regional Office China (Shanghai):

Phone: +86 21 6090 4832

E-mail: info_cn@u-blox.com

Support: support_cn@u-blox.com

Regional Office China (Shenzhen):

Phone: +86 755 8627 1083

E-mail: info_cn@u-blox.com

Support: support_cn@u-blox.com

Regional Office India:

Phone: +91 80 405 092 00

E-mail: info_in@u-blox.com

Support: support_in@u-blox.com

Regional Office Japan (Osaka):

Phone: +81 6 6941 3660

E-mail: info_jp@u-blox.com

Support: support_jp@u-blox.com

Regional Office Japan (Tokyo):

Phone: +81 3 5775 3850

E-mail: info_jp@u-blox.com

Support: support_jp@u-blox.com

Regional Office Korea:

Phone: +82 2 542 0861

E-mail: info_kr@u-blox.com

Support: support_kr@u-blox.com

Regional Office Taiwan:

Phone: +886 2 2657 1090

E-mail: info_tw@u-blox.com

Support: support_tw@u-blox.com