

FCC Test Report (PART 24)

Report No.: RF181120C09D-1

FCC ID: XPY2AGQN4NNN

Test Model: SARA-R410M

Received Date: Mar. 29, 2019

Test Date: Aug. 31 to Sep. 02, 2019

Issued Date: Sep. 20, 2019

Applicant: u-blox-AG

Address: Zuercherstrasse 68 8800 Thalwil, Switzerland

Issued By: Bureau Veritas Consumer Products Services (H.K.) Ltd., Taoyuan Branch
Hsin Chu Laboratory

Lab Address: E-2, No.1, Li Hsin 1st Road, Hsinchu Science Park, Hsinchu City 300,
Taiwan R.O.C.

Test Location: E-2, No.1, Li Hsin 1st Road, Hsinchu Science Park, Hsinchu City 300,
Taiwan R.O.C.

**FCC Registration /
Designation Number:** 723255 / TW2022



This report is for your exclusive use. Any copying or replication of this report to or for any other person or entity, or use of our name or trademark, is permitted only with our prior written permission. This report sets forth our findings solely with respect to the test samples identified herein. The results set forth in this report are not indicative or representative of the quality or characteristics of the lot from which a test sample was taken or any similar or identical product unless specifically and expressly noted. Our report includes all of the tests requested by you and the results thereof based upon the information that you provided to us. You have 60 days from date of issuance of this report to notify us of any material error or omission caused by our negligence, provided, however, that such notice shall be in writing and shall specifically address the issue you wish to raise. A failure to raise such issue within the prescribed time shall constitute your unqualified acceptance of the completeness of this report, the tests conducted and the correctness of the report contents. Unless specific mention, the uncertainty of measurement has been explicitly taken into account to declare the compliance or non-compliance to the specification. The report must not be used by the client to claim product certification, approval, or endorsement by TAF or any government agencies.

Table of Contents

Release Control Record	4
1 Certificate of Conformity	5
2 Summary of Test Results	6
2.1 Measurement Uncertainty	6
2.2 Test Site and Instruments	7
3 General Information	9
3.1 General Description of EUT	9
3.2 Configuration of System under Test	11
3.2.1 Description of Support Units	12
3.3 Test Mode Applicability and Tested Channel Detail	13
3.4 EUT Operating Conditions	15
3.5 General Description of Applied Standards	16
4 Test Types and Results	17
4.1 Output Power Measurement	17
4.1.1 Limits of Output Power Measurement	17
4.1.2 Test Procedures	17
4.1.3 Test Setup	17
4.1.4 Test Results	18
4.2 Modulation characteristics Measurement	26
4.2.1 Limits of Modulation characteristics	26
4.2.2 Test Procedure	26
4.2.3 Test Setup	26
4.2.4 Test Results	27
4.3 Frequency Stability Measurement	28
4.3.1 Limits of Frequency Stability Measurement	28
4.3.2 Test Procedure	28
4.3.3 Test Setup	28
4.3.4 Test Results	29
4.4 Occupied Bandwidth Measurement	30
4.4.1 Test Procedure	30
4.4.2 Test Setup	30
4.4.3 Test Result (-26dB Bandwidth)	31
4.4.4 Test Result (Occupied Bandwidth)	33
4.5 Band Edge Measurement	35
4.5.1 Limits of Band Edge Measurement	35
4.5.2 Test Setup	35
4.5.3 Test Procedures	35
4.5.4 Test Results	36
4.6 Peak to Average Ratio	42
4.6.1 Limits of Peak to Average Ratio Measurement	42
4.6.2 Test Setup	42
4.6.3 Test Procedures	42
4.6.4 Test Results	43
4.7 Conducted Spurious Emissions	45
4.7.1 Limits of Conducted Spurious Emissions Measurement	45
4.7.2 Test Setup	45
4.7.3 Test Procedure	45
4.7.4 Test Results	46
4.8 Radiated Emission Measurement	64
4.8.1 Limits of Radiated Emission Measurement	64
4.8.2 Test Procedure	64
4.8.3 Deviation from Test Standard	64
4.8.4 Test Setup	65

4.8.5 Test Results	66
5 Pictures of Test Arrangements.....	102
Appendix – Information of the Testing Laboratories	103

Release Control Record

Issue No.	Description	Date Issued
RF181120C09D-1	Original release.	Sep. 20, 2019

1 Certificate of Conformity

Product: LTE CAT-M1 modem

Brand: u-blox-AG

Test Model: SARA-R410M

Sample Status: ENGINEERING SAMPLE

Applicant: u-blox-AG

Test Date: Aug. 31 to Sep. 02, 2019

Standards: FCC Part 24, Subpart E

The above equipment has been tested by **Bureau Veritas Consumer Products Services (H.K.) Ltd., Taoyuan Branch**, and found compliance with the requirement of the above standards. The test record, data evaluation & Equipment Under Test (EUT) configurations represented herein are true and accurate accounts of the measurements of the sample's EMC characteristics under the conditions specified in this report.

Prepared by :  _____, **Date:** _____ Sep. 20, 2019
Claire Kuan / Specialist

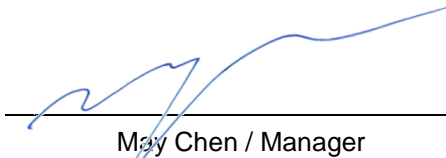
Approved by :  _____, **Date:** _____ Sep. 20, 2019
May Chen / Manager

2 Summary of Test Results

Applied Standard: FCC Part 24 & Part 2			
FCC Clause	Test Item	Result	Remarks
2.1046 24.232	Equivalent Isotropically Radiated Power	PASS	Meet the requirement of limit.
2.1046 24.232(d)	Peak To Average Ratio	PASS	Meet the requirement of limit.
2.1047	Modulation characteristics	PASS	Meet the requirement
2.1055 24.235	Frequency Stability	PASS	Meet the requirement of limit.
2.1049 24.238(b)	Occupied Bandwidth	PASS	Meet the requirement of limit.
24.238(b)	Band Edge Measurements	PASS	Meet the requirement of limit.
2.1051 24.238	Conducted Spurious Emissions	PASS	Meet the requirement of limit.
2.1053 24.238	Radiated Spurious Emissions	PASS	Meet the requirement of limit. Minimum passing margin is -24.24dB at 3703MHz.

NOTE:

- Determining compliance based on the results of the compliance measurement, not taking into account measurement instrumentation uncertainty.
- This report is prepared for FCC Class II permissive change.

2.1 Measurement Uncertainty

Where relevant, the following measurement uncertainty levels have been estimated for tests performed on the EUT as specified in CISPR 16-4-2:

Measurement	Frequency	Expanded Uncertainty (k=2) (±)
Radiated Emissions up to 1 GHz	9kHz ~ 1GHz	3.0 dB
	30MHz ~ 1GHz	5.1 dB
Radiated Emissions above 1 GHz	1GHz ~ 6GHz	5.1 dB
	6GHz ~ 18GHz	5.0 dB
	18GHz ~ 40GHz	5.2 dB

2.2 Test Site and Instruments

For radiated spurious emissions test:

DESCRIPTION & MANUFACTURER	MODEL NO.	SERIAL NO.	CALIBRATED DATE	CALIBRATED UNTIL
Test Receiver Agilent	N9038A	MY50010156	July 17, 2019	July 16, 2020
Pre-Amplifier EMCI	EMC001340	980142	May 30, 2019	May 29, 2020
Loop Antenna Electro-Metrics	EM-6879	264	Jan. 22, 2019	Jan. 21, 2020
RF Cable	NA	LOOPCAB-001	Jan. 14, 2019	Jan. 13, 2020
RF Cable	NA	LOOPCAB-002	Jan. 14, 2019	Jan. 13, 2020
Pre-Amplifier Mini-Circuits	ZFL-1000VH2B	AMP-ZFL-05	Apr. 30, 2019	Apr. 29, 2020
Trilog Broadband Antenna SCHWARZBECK	VULB 9168	9168-361	Nov. 22, 2018	Nov. 21, 2019
RF Cable	8D	966-3-1	Mar. 18, 2019	Mar. 17, 2020
RF Cable	8D	966-3-2	Mar. 18, 2019	Mar. 17, 2020
RF Cable	8D	966-3-3	Mar. 18, 2019	Mar. 17, 2020
Fixed attenuator Mini-Circuits	UNAT-5+	PAD-3m-3-01	Sep. 27, 2018	Sep. 26, 2019
Horn_Antenna SCHWARZBECK	BBHA9120-D	9120D-406	Nov. 25, 2018	Nov. 24, 2019
Pre-Amplifier EMCI	EMC12630SE	980384	Jan. 28, 2019	Jan. 27, 2020
RF Cable	EMC104-SM-SM-1200	160922	Jan. 28, 2019	Jan. 27, 2020
RF Cable	EMC104-SM-SM-2000	180601	June 10, 2019	June 09, 2020
RF Cable	EMC104-SM-SM-6000	180602	June 10, 2019	June 09, 2020
Spectrum Analyzer Keysight	N9030A	MY54490679	July 17, 2019	July 16, 2020
Pre-Amplifier EMCI	EMC184045SE	980387	Jan. 28, 2019	Jan. 27, 2020
Horn_Antenna SCHWARZBECK	BBHA 9170	BBHA9170519	Nov. 25, 2018	Nov. 24, 2019
RF Cable	EMC102-KM-KM-1200	160924	Jan. 28, 2019	Jan. 27, 2020
RF Cable	EMC102-KM-KM-1200	160925	Jan. 28, 2019	Jan. 27, 2020
Software	ADT_Radiated_V8.7.08	NA	NA	NA
Antenna Tower & Turn Table Max-Full	MF-7802	MF780208406	NA	NA
Boresight Antenna Fixture	FBA-01	FBA-SIP01	NA	NA

Note:

1. The calibration interval of the above test instruments is 12 months and the calibrations are traceable to NML/ROC and NIST/USA.
2. The test was performed in 966 Chamber No. 3.
3. Loop antenna was used for all emissions below 30 MHz.
4. Tested Date: Aug. 31, 2019

For other test:

DESCRIPTION & MANUFACTURER	MODEL NO.	SERIAL NO.	CALIBRATED DATE	CALIBRATED UNTIL
Spectrum Analyzer R&S	FSV40	100964	June 04, 2019	June 03, 2020
Spectrum Analyzer Keysight	N9030A	MY54490570	June 19, 2019	June 18, 2020
Power meter Anritsu	ML2495A	1014008	May 13, 2019	May 12, 2020
Power sensor Anritsu	MA2411B	0917122	May 13, 2019	May 12, 2020
Fixed Attenuator Mini-Circuits	MDCS18N-10	MDCS18N-10-01	Apr. 15, 2019	Apr. 14, 2020
AC Power Source Extech Electronics	6205	1440452	NA	NA
DC Power Supply Topward	6603D	795558	NA	NA
Temperature & Humidity Chamber Giant Force	GTH-150-40-SP-AR	MAA0812-008	Jan. 09, 2019	Jan. 08, 2020
True RMS Clamp Meter FLUKE	325	31130711WS	May 21, 2019	May 20, 2020
ESG Vector signal generator Agilent	E4438C	MY45094468/005 506 602 UK6 UNJ	Nov. 19, 2018	Nov. 18, 2019
Mech Switch Absorptive Mini-Circuits	MSP4TA-18+	0140	Feb. 11, 2019	Feb. 10, 2020
FXD ATTEN Mini-Circuits	BW-S3W2+	MN71981	Feb. 11, 2019	Feb. 10, 2020
Software	ADT_RF Test Software V6.6.5.4	NA	NA	NA

- NOTE:**
1. The test was performed in Oven room 2.
 2. The calibration interval of the above test instruments is 12 months and the calibrations are traceable to NML/ROC and NIST/USA.
 3. Tested Date: Sep. 02, 2019

3 General Information

3.1 General Description of EUT

Product	LTE CAT-M1 modem		
Brand	u-blox-AG		
Test Model	SARA-R410M		
Status of EUT	ENGINEERING SAMPLE		
Power Supply Rating	DC 3.3V from host equipment		
Modulation Type	QPSK, 16QAM		
Operating Frequency	LTE Band 2	1850.7MHz ~ 1909.3MHz	
Max. EIRP Power	LTE Band 2 (Channel Bandwidth 1.4MHz)	QPSK: 24.59 dBm 16QAM: 23.58 dBm	
	LTE Band 2 (Channel Bandwidth 3MHz)	QPSK: 24.58 dBm 16QAM: 23.51 dBm	
	LTE Band 2 (Channel Bandwidth 5MHz)	QPSK: 24.68 dBm 16QAM: 23.58 dBm	
	LTE Band 2 (Channel Bandwidth 10MHz)	QPSK: 24.69 dBm 16QAM: 23.58 dBm	
	LTE Band 2 (Channel Bandwidth 15MHz)	QPSK: 25.16 dBm 16QAM: 24.99 dBm	
	LTE Band 2 (Channel Bandwidth 20MHz)	QPSK: 25.25 dBm 16QAM: 25.09 dBm	
	Emission Designator	LTE Band 2 (Channel Bandwidth 1.4MHz)	QPSK: 1M12G7D 16QAM: 1M12D7W
		LTE Band 2 (Channel Bandwidth 3MHz)	QPSK: 1M20G7D 16QAM: 1M14D7W
LTE Band 2 (Channel Bandwidth 5MHz)		QPSK: 1M22G7D 16QAM: 1M16D7W	
LTE Band 2 (Channel Bandwidth 10MHz)		QPSK: 1M16G7D 16QAM: 1M20D7W	
LTE Band 2 (Channel Bandwidth 15MHz)		QPSK: 1M16G7D 16QAM: 1M18D7W	
LTE Band 2 (Channel Bandwidth 20MHz)		QPSK: 1M17G7D 16QAM: 1M20D7W	
Antenna Type		Refer to Note	
Antenna Connector		Refer to Note	
Accessory Device	NA		
Data Cable Supplied	NA		

Note:

1. This report is prepared for FCC Class II permissive change. The difference compared with the Report No.: RF181120C09 design is as the following information:

- ◆ LTE Cat M1 test mode change for LTE Band 2,4,12 adding bandwidth measurements.
- ◆ Antenna trace layout design changed and antenna changed.

2. According to above conditions, all test items need to be performed. And all data were verified to meet the requirements.

3. The antennas provided to the EUT, please refer to the following table:

Antenna No.	Brand	Model	Antenna Net Gain (dBi)	Frequency range	Antenna Type	Connector Type	Cable Length
LTE Antenna	AT&T	95XKAB15.G45	2.7	FDD 2: 1850 MHz to 1910 MHz	IFA	i-pex(MHF)	49.5mm
			3	FDD 4: 1710 MHz to 1755 MHz			
			2	FDD 12: 698 MHz to 716 MHz			

4. The above EUT information is declared by manufacturer and for more detailed features description, please refer to the manufacturer's specifications or User's Manual.

3.2 Configuration of System under Test

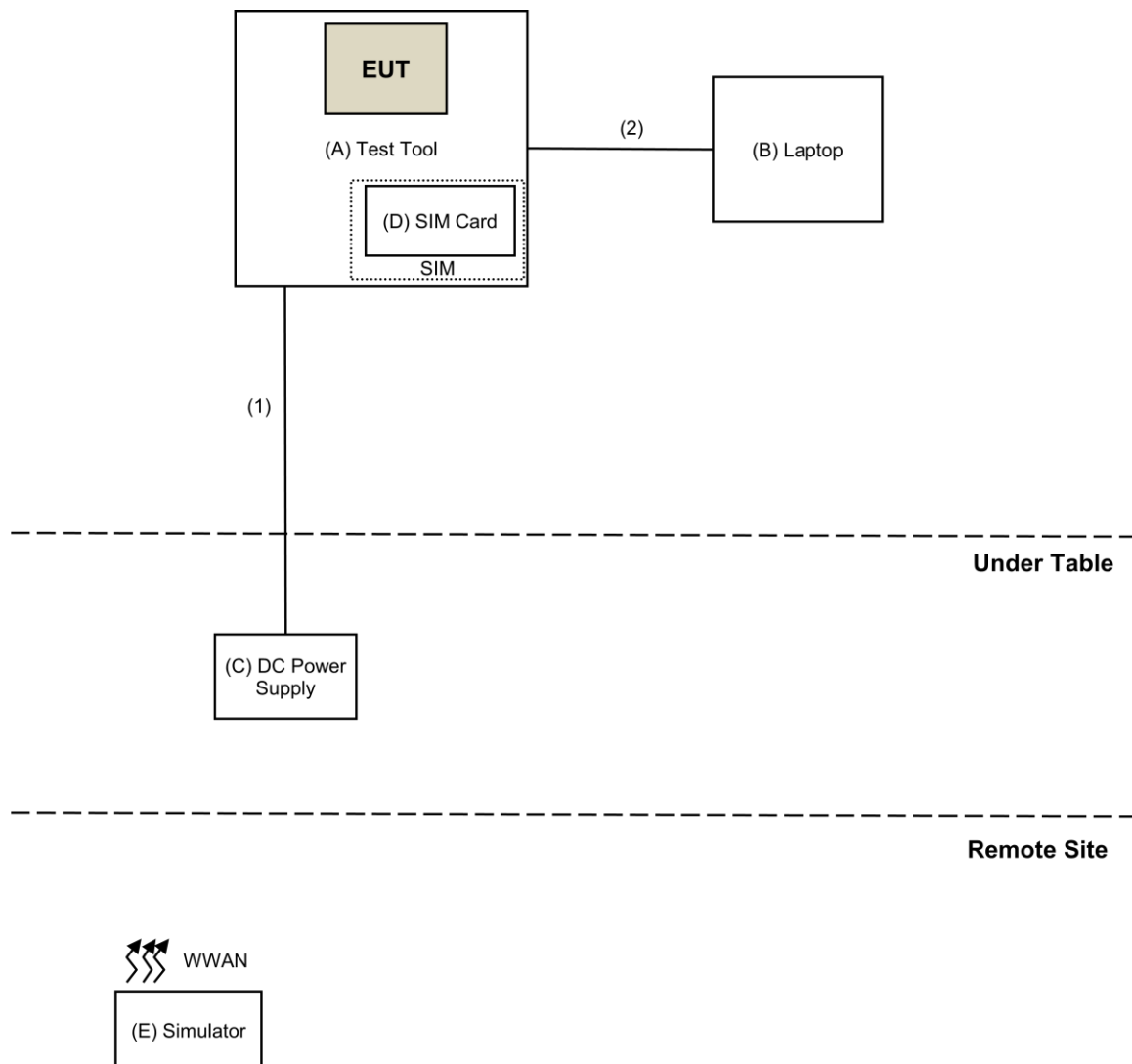

3.2.1 Description of Support Units

The EUT has been tested as an independent unit together with other necessary accessories or support units. The following support units or accessories were used to form a representative test configuration during the tests.

ID	Product	Brand	Model No.	Serial No.	FCC ID	Remarks
A.	Test Tool	NA	NA	NA	NA	Supplied by client
B.	Laptop	Lenovo	80WG	YD025N5Q	NA	Provided by Lab
C.	DC Power Supply	Topward	6603D	795551	NA	Provided by Lab
D.	SIM Card	R&S	CMW-Z04	NA	NA	Provided by Lab
E.	Simulator	Anritsu	MT8820C	6201127458	NA	Provided by Lab

Note:

1. All power cords of the above support units are non-shielded (1.8m).

ID	Descriptions	Qty.	Length (m)	Shielding (Yes/No)	Cores (Qty.)	Remarks
1.	DC Cable	1	1.8	No	0	Provided by Lab
2.	Console Cable	1	0.235	Yes	0	Supplied by client

3.3 Test Mode Applicability and Tested Channel Detail

In the original test report, pre-scan has been conducted to determine the worst-case mode from all possible combinations between available modulations, data rates, XYZ axis and antenna ports
 The worst case was found when positioned on Z-plane. Following channel(s) was (were) selected for the final test as listed below:

LTE Band 2

TEST ITEM	Available Channel	Tested Channel	Channel bandwidth	MODULATION	RB		
					SIZE	offset	Index
EIRP	19957 to 20393	19957, 18900, 19193	1.4MHz	QPSK/16QAM	1	0	0
	19965 to 20385	19965, 18900, 19185	3MHz	QPSK/16QAM	1	0	0
	19975 to 20375	19975, 18900, 19175	5MHz	QPSK/16QAM	1	0	0
	20000 to 20350	20000, 18900, 19150	10MHz	QPSK/16QAM	1	0	0
	20025 to 20325	20025, 18900, 19125	15MHz	QPSK/16QAM	1	0	0
	20050 to 20300	20050, 18900, 19100	20MHz	QPSK/16QAM	1	0	0
Frequency Stability	19957 to 20393	18900	1.4MHz	QPSK	1	0	0
	19965 to 20385	18900	3MHz	QPSK	1	0	0
	19975 to 20375	18900	5MHz	QPSK	1	0	0
	20000 to 20350	18900	10MHz	QPSK	1	0	0
	20025 to 20325	18900	15MHz	QPSK	1	0	0
	20050 to 20300	18900	20MHz	QPSK	1	0	0
Occupied Bandwidth	19957 to 20393	19957, 18900, 19193	1.4MHz	QPSK/16QAM	6	0	0
	19965 to 20385	19965, 18900, 19185	3MHz	QPSK/16QAM	6	0	0
	19975 to 20375	19975, 18900, 19175	5MHz	QPSK/16QAM	6	0	0
	20000 to 20350	20000, 18900, 19150	10MHz	QPSK/16QAM	6	0	0
	20025 to 20325	20025, 18900, 19125	15MHz	QPSK/16QAM	6	0	0
	20050 to 20300	20050, 18900, 19100	20MHz	QPSK/16QAM	6	0	0
Peak to Average Ratio	19957 to 20393	19957, 18900, 19193	1.4MHz	QPSK/16QAM	6	0	0
	19965 to 20385	19965, 18900, 19185	3MHz	QPSK/16QAM	6	0	0
	19975 to 20375	19975, 18900, 19175	5MHz	QPSK/16QAM	6	0	0
	20000 to 20350	20000, 18900, 19150	10MHz	QPSK/16QAM	6	0	0
	20025 to 20325	20025, 18900, 19125	15MHz	QPSK/16QAM	6	0	0
	20050 to 20300	20050, 18900, 19100	20MHz	QPSK/16QAM	6	0	0

TEST ITEM	Available Channel	Tested Channel	Channel bandwidth	MODULATION	RB		
					SIZE	offset	Index
Band Edge	19957 to 20393	19957	1.4MHz	QPSK	1	0	0
		19193			6	0	0
					1	5	0
		6			0	0	
	19965 to 20385	19965	3MHz	QPSK	1	0	0
		19185			6	0	0
					1	5	1
		6			0	1	
	19975 to 20375	19975	5MHz	QPSK	1	0	0
		19175			6	0	0
					1	5	3
		6			0	3	
	20000 to 20350	20000	10MHz	QPSK	1	0	0
		19150			6	0	0
					1	5	7
		6			0	7	
	20025 to 20325	20025	15MHz	QPSK	1	0	0
		19125			6	0	0
					1	5	11
		6			0	11	
	20050 to 20300	20050	20MHz	QPSK	1	0	0
		19100			6	0	0
					1	5	11
		6			0	11	
Conducted Emission	19957 to 20393	19957, 18900, 19193	1.4MHz	QPSK	1	0	0
	19965 to 20385	19965, 18900, 19185	3MHz	QPSK	1	0	0
	19975 to 20375	19975, 18900, 19175	5MHz	QPSK	1	0	0
	20000 to 20350	20000, 18900, 19150	10MHz	QPSK	1	0	0
	20025 to 20325	20025, 18900, 19125	15MHz	QPSK	1	0	0
	20050 to 20300	20050, 18900, 19100	20MHz	QPSK	1	0	0

TEST ITEM	Available Channel	Tested Channel	Channel bandwidth	MODULATION	RB		
					SIZE	offset	Index
Radiated Emission	19957 to 20393	19957, 18900, 19193	1.4MHz	QPSK	1	0	0
	19965 to 20385	19965, 18900, 19185	3MHz	QPSK	1	0	0
	19975 to 20375	19975, 18900, 19175	5MHz	QPSK	1	0	0
	20000 to 20350	20000, 18900, 19150	10MHz	QPSK	1	0	0
	20025 to 20325	20025, 18900, 19125	15MHz	QPSK	1	0	0
	20050 to 20300	20050, 18900, 19100	20MHz	QPSK	1	0	0
Modulation Characteristics	20050 to 20300	18900	20MHz	QPSK/16QAM	6	0	0

NOTE:

All supported modulation types were evaluated. The Worst case of QPSK was selected. Therefore, the Band Edge, Frequency Stability, Condcudeted Emission and Radiated Emission were presented under QPSK mode only.

Test Condition:

Test Item	Environmental Conditions	Input Power (System)	Tested By
EIRP	25deg. C, 60%RH	120Vac, 60Hz	Jyunchun Lin
Frequency Stability	25deg. C, 60%RH	120Vac, 60Hz	Jyunchun Lin
Occupied Bandwidth	25deg. C, 60%RH	120Vac, 60Hz	Jyunchun Lin
Band Edge	25deg. C, 60%RH	120Vac, 60Hz	Jyunchun Lin
Peak to Average Ratio	25deg. C, 60%RH	120Vac, 60Hz	Jyunchun Lin
Condcudeted Emission	25deg. C, 60%RH	120Vac, 60Hz	Jyunchun Lin
Radiated Emission Below 1GHz	25deg. C, 66%RH	120Vac, 60Hz	Robert Cheng
Radiated Emission Above 1GHz	23deg. C, 70%RH	120Vac, 60Hz	Robert Cheng

3.4 EUT Operating Conditions

The communication simulator station system controlled a EUT to export maximum output power under transmission mode and specific channel frequency

3.5 General Description of Applied Standards

The EUT is a RF Product. According to the specifications of the manufacturer, it must comply with the requirements of the following standards:

FCC 47 CFR Part 2

FCC 47 CFR Part 24, Subpart E

KDB 971168 D01 Power Meas License Digital Systems v03r01

ANSI/TIA/EIA-603-E 2016

ANSI 63.26-2015

NOTE: All test items have been performed and recorded as per the above standards.

4 Test Types and Results

4.1 Output Power Measurement

4.1.1 Limits of Output Power Measurement

Mobile / Portable station are limited to 2 watts e.i.r.p.

4.1.2 Test Procedures

Conducted Power Measurement:

The EUT was set up for the maximum power with LTE link data modulation and link up with simulator. Set the EUT to transmit under low, middle and high channel and difference RB size/ RB offset for difference bandwidth record the power level shown on power meter.

EIRP Measurement:

- a. $EIRP = \text{Conducted Output power level} + \text{Antenna gain.}$

4.1.3 Test Setup

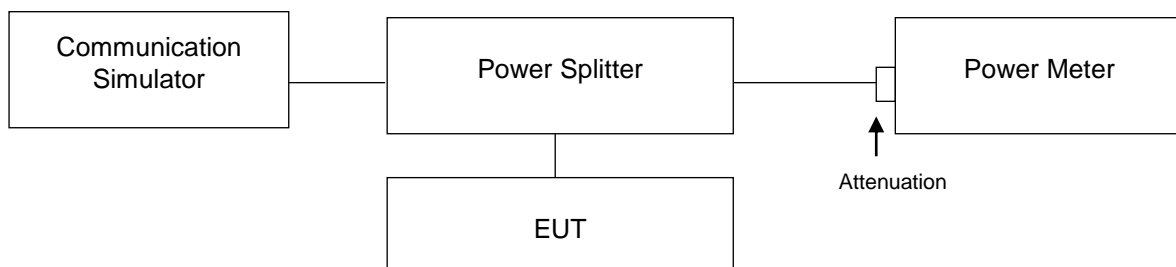

For the actual test configuration, please refer to the attached file (Test Setup Photo).

4.1.4 Test Results

CONDUCTED OUTPUT POWER (dBm)

LTE Band 2

Band / BW	RB Size	RB Offset	RB Index	QPSK			3GPP MPR (dB)
				Low Ch 18607	Mid Ch 18900	High Ch 19193	
				1850.7 MHz	1880 MHz	1909.3 MHz	
2 / 1.4M	1	0	0	21.84	21.55	21.65	0
	1	5	0	21.89	21.58	21.62	0
	3	3	0	20.76	20.80	20.76	1
	6	0	0	20.00	19.89	19.85	2

Band / BW	RB Size	RB Offset	RB Index	16QAM			3GPP MPR (dB)
				Low Ch 18607	Mid Ch 18900	High Ch 19193	
				1850.7 MHz	1880 MHz	1909.3 MHz	
2 / 1.4M	1	0	0	20.88	20.75	20.68	1
	1	5	0	20.74	20.69	20.70	1
	3	0	0	19.81	19.80	19.82	2
	5	0	0	19.89	19.85	19.81	2

Band / BW	RB Size	RB Offset	RB Index	QPSK			3GPP MPR (dB)
				Low Ch 18615	Mid Ch 18900	High Ch 19185	
				1851.5 MHz	1880 MHz	1908.5 MHz	
2 / 3M	1	0	0	21.85	21.71	21.88	0
	1	5	0	21.75	21.80	21.77	0
	1	0	1	21.82	21.80	21.79	0
	1	5	1	21.77	21.69	21.58	0
	3	3	0	20.98	20.65	20.74	1
	3	3	1	20.94	20.65	20.77	1
	6	0	0	20.08	19.95	19.98	2
	6	0	1	19.90	19.80	19.85	2

Band / BW	RB Size	RB Offset	RB Index	16QAM			3GPP MPR (dB)
				Low Ch 18615	Mid Ch 18900	High Ch 19185	
				1851.5 MHz	1880 MHz	1908.5 MHz	
2 / 3M	1	0	0	20.77	20.70	20.81	1
	1	5	0	20.65	20.71	20.68	1
	1	0	1	20.63	20.61	20.55	1
	1	5	1	20.71	20.68	20.70	1
	3	0	0	19.88	19.82	19.81	2
	3	3	1	19.83	19.80	19.82	2
	5	0	0	19.81	19.85	19.85	2
	5	0	1	19.81	19.82	19.82	2

Band / BW	RB Size	RB Offset	RB Index	QPSK			3GPP MPR (dB)
				Low Ch 18625	Mid Ch 19185	High Ch 19175	
				1852.5 MHz	1880 MHz	1907.5 MHz	
2 / 5M	1	0	0	21.98	21.80	21.84	0
	1	5	0	21.84	21.85	21.87	0
	1	0	1	21.86	21.80	21.77	0
	1	5	1	21.89	21.85	21.80	0
	1	0	3	21.79	21.69	21.71	0
	1	5	3	21.77	21.74	21.75	0
	3	0	0	20.85	20.87	20.81	1
	3	3	3	20.95	20.84	20.88	1
	6	0	0	21.04	21.00	21.01	1
	6	0	1	20.98	20.81	20.78	1
	6	0	3	20.83	20.77	20.79	1

Band / BW	RB Size	RB Offset	RB Index	16QAM			3GPP MPR (dB)
				Low Ch 18625	Mid Ch 19185	High Ch 19175	
				1852.5 MHz	1880 MHz	1907.5 MHz	
2 / 5M	1	0	0	20.88	20.78	20.85	1
	1	5	0	20.81	20.75	20.79	1
	1	0	1	20.81	20.75	20.82	1
	1	5	1	20.76	20.75	20.81	1
	1	0	3	20.83	20.80	20.78	1
	1	5	3	20.81	20.79	20.75	1
	3	0	0	20.80	20.71	20.76	1
	3	3	3	20.75	20.72	20.80	1
	5	0	0	19.80	19.81	19.85	2
	5	0	1	19.91	19.85	19.89	2
5	0	3	19.88	19.82	19.80	2	

Band / BW	RB Size	RB Offset	RB Index	QPSK			3GPP MPR (dB)
				Low Ch 18650	Mid Ch 18900	High Ch 19150	
				1855 MHz	1880 MHz	1905 MHz	
2 / 10M	1	0	0	21.98	21.99	21.95	0
	1	5	0	21.94	21.90	21.93	0
	1	0	3	21.95	21.89	21.86	0
	1	5	3	21.85	21.78	21.82	0
	1	0	7	21.87	21.81	21.75	0
	1	5	7	21.81	21.88	21.78	0
	4	0	0	21.80	21.71	21.85	0
	4	2	7	21.82	21.87	21.78	0
	6	0	0	20.88	20.85	20.81	1
	6	0	7	20.76	20.71	20.79	1

Band / BW	RB Size	RB Offset	RB Index	16QAM			3GPP MPR (dB)
				Low Ch 18650	Mid Ch 18900	High Ch 19150	
				1855 MHz	1880 MHz	1905 MHz	
2 / 10M	1	0	0	20.85	20.87	20.81	1
	1	5	0	20.85	20.79	20.76	1
	1	0	3	20.80	20.82	20.88	1
	1	5	3	20.81	20.83	20.87	1
	1	0	7	20.85	20.80	20.79	1
	1	5	7	20.82	20.82	20.80	1
	4	2	0	20.76	20.74	20.81	1
	4	2	7	20.81	20.82	20.79	1
	5	0	0	20.75	20.81	20.76	1
	5	0	7	20.83	20.81	20.84	1

Band / BW	RB Size	RB Offset	RB Index	QPSK			3GPP MPR (dB)
				Low Ch 18675	Mid Ch 18900	High Ch 19125	
				1857.5 MHz	1880 MHz	1902.5 MHz	
2 / 15M	1	0	0	22.46	22.18	22.15	0
	1	5	0	22.32	22.31	22.28	0
	1	0	5	22.31	22.37	22.11	0
	1	5	5	22.27	22.21	22.25	0
	1	0	11	22.24	22.21	22.08	0
	1	5	11	22.31	22.28	22.26	0
	3	0	0	22.18	22.20	22.05	0
	3	3	11	22.18	22.21	22.05	0
	6	0	0	22.21	22.18	22.05	0
	6	0	11	22.21	22.08	22.01	0

Band / BW	RB Size	RB Offset	RB Index	16QAM			3GPP MPR (dB)
				Low Ch 18675	Mid Ch 18900	High Ch 19125	
				1857.5 MHz	1880 MHz	1902.5 MHz	
2 / 15M	1	0	0	22.28	22.21	22.18	0
	1	5	0	22.29	22.25	22.01	0
	1	0	5	22.19	22.24	22.05	0
	1	5	5	22.25	22.18	22.09	0
	1	0	11	22.25	22.18	22.15	0
	1	5	11	22.21	22.15	22.08	0
	3	0	0	22.19	22.16	22.05	0
	3	3	11	22.18	22.20	22.11	0
	5	0	0	22.18	22.11	22.05	0
	5	0	11	22.15	22.08	22.01	0

Band / BW	RB Size	RB Offset	RB Index	QPSK			3GPP MPR (dB)
				Low Ch 18700	Mid Ch 18900	High Ch 19100	
				1860 MHz	1880 MHz	1900 MHz	
2 / 20M	1	0	0	22.55	22.42	22.38	0
	1	5	0	22.36	22.48	22.18	0
	1	0	7	22.48	22.35	22.41	0
	1	5	7	22.45	22.51	22.46	0
	1	0	15	22.40	22.48	22.32	0
	1	5	15	22.36	22.34	22.30	0
	3	0	0	22.31	22.28	22.25	0
	3	3	15	22.35	22.21	22.20	0
	6	0	0	22.35	22.21	22.18	0
	6	0	15	22.28	22.21	22.15	0

Band / BW	RB Size	RB Offset	RB Index	16QAM			3GPP MPR (dB)
				Low Ch 18700	Mid Ch 18900	High Ch 19100	
				1860 MHz	1880 MHz	1900 MHz	
2 / 20M	1	0	0	22.38	22.32	22.21	0
	1	5	0	22.39	22.18	22.25	0
	1	0	7	22.35	22.31	22.21	0
	1	5	7	22.30	22.18	22.24	0
	1	0	15	22.35	22.21	22.20	0
	1	5	15	22.36	22.18	22.31	0
	3	0	0	22.31	22.30	22.18	0
	3	3	15	22.32	22.28	22.20	0
	5	0	0	22.35	22.29	22.21	0
	5	0	15	22.32	22.21	22.19	0

EIRP POWER
LTE Band 2

QPSK			
Band 2 / 1.4M			
Channel No.	FREQUENCY (MHz)	EIRP POWER	
		dBm	mW
18607	1850.7	24.59	287.740
18900	1880	24.28	267.917
19193	1909.3	24.35	272.270
Band 2 / 3M			
Channel No.	FREQUENCY (MHz)	EIRP POWER	
		dBm	mW
18615	1851.5	24.55	285.102
18900	1880	24.50	281.838
19185	1908.5	24.58	287.078
Band 2 / 5M			
Channel No.	FREQUENCY (MHz)	EIRP POWER	
		dBm	mW
18625	1852.5	24.68	293.765
18900	1880	24.55	285.102
19175	1907.5	24.57	286.418
Band 2 / 10M			
Channel No.	FREQUENCY (MHz)	EIRP POWER	
		dBm	mW
18650	1855	24.68	293.765
18900	1880	24.69	294.442
19150	1905	24.65	291.743
Band 2 / 15M			
Channel No.	FREQUENCY (MHz)	EIRP POWER	
		dBm	mW
18675	1857.5	25.16	328.095
18900	1880	25.07	321.366
19125	1902.5	24.98	314.775
Band 2 / 20M			
Channel No.	FREQUENCY (MHz)	EIRP POWER	
		dBm	mW
18700	1860	25.25	334.965
18900	1880	25.21	331.894
19100	1900	25.16	328.095

16QAM			
Band 2 / 1.4M			
Channel No.	FREQUENCY (MHz)	EIRP POWER	
		dBm	mW
18607	1850.7	23.58	228.034
18900	1880	23.45	221.309
19193	1909.3	23.40	218.776
Band 2 / 3M			
Channel No.	FREQUENCY (MHz)	EIRP POWER	
		dBm	mW
18615	1851.5	23.47	222.331
18900	1880	23.41	219.280
19185	1908.5	23.51	224.388
Band 2 / 5M			
Channel No.	FREQUENCY (MHz)	EIRP POWER	
		dBm	mW
18625	1852.5	23.58	228.034
18900	1880	23.50	223.872
19175	1907.5	23.55	226.464
Band 2 / 10M			
Channel No.	FREQUENCY (MHz)	EIRP POWER	
		dBm	mW
18650	1855	23.55	226.464
18900	1880	23.57	227.510
19150	1905	23.58	228.034
Band 2 / 15M			
Channel No.	FREQUENCY (MHz)	EIRP POWER	
		dBm	mW
18675	1857.5	24.99	315.500
18900	1880	24.95	312.608
19125	1902.5	24.88	307.610
Band 2 / 20M			
Channel No.	FREQUENCY (MHz)	EIRP POWER	
		dBm	mW
18700	1860	25.09	322.849
18900	1880	25.02	317.687
19100	1900	25.01	316.957

4.2 Modulation characteristics Measurement

4.2.1 Limits of Modulation characteristics

N/A

4.2.2 Test Procedure

Connect the EUT to Communication Simulator via the antenna connector. The frequency band is set as EUT supported Modulation and Channels, the EUT output is matched with 50 ohm load, the waveform quality and constellation of the EUT was tested.

4.2.3 Test Setup



4.3 Frequency Stability Measurement

4.3.1 Limits of Frequency Stability Measurement

The frequency stability shall be sufficient to ensure that the fundamental emission stays within the authorized frequency block.

4.3.2 Test Procedure

- Device is placed at the oven room. The oven room could control the temperatures and humidity. Power warm up is at least 15 min and power applied should perform before recording frequency error.
- EUT is connected the external power supply to control the DC input power. The test voltage range is from minimum to maximum working voltage. Each step shall be record the frequency error rate.
- The temperature range step is 10 degrees in this test items. All temperature levels shall be hold the ± 0.5 °C during the measurement testing. The each temperature step shall be at least 0.5 hours, consider the EUT could be test under the stability condition.

NOTE: The frequency error was recorded frequency error from the communication simulator.

4.3.3 Test Setup

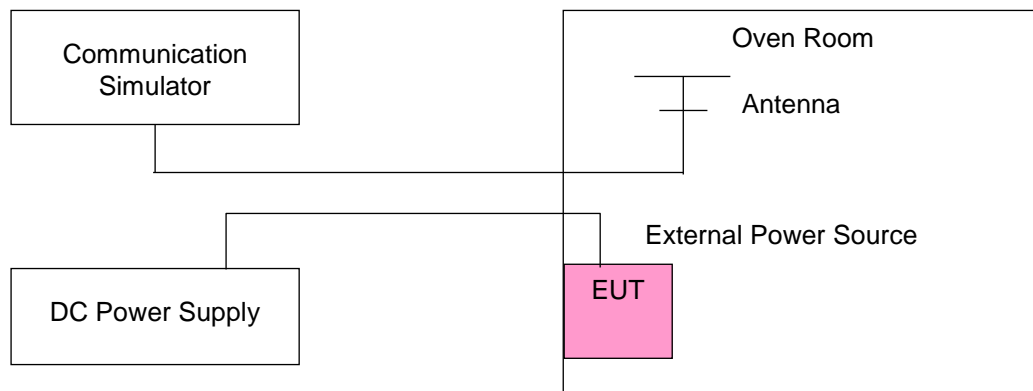

4.3.4 Test Results

LTE Band 2

Frequency Error vs. Voltage

Voltage (Volts)	Frequency Error (MHz)												Limit (MHz)	
	1.4MHz		3MHz		5MHz		10MHz		15MHz		20MHz		Low Edge	High Edge
	Low	High	Low	High	Low	High	Low	High	Low	High	Low	High		
2.8	1850.164	1909.723	1850.177	1909.765	1850.329	1909.810	1850.430	1909.459	1850.760	1909.421	1851.080	1909.040	1850	1910
3.8	1850.164	1909.723	1850.178	1909.766	1850.329	1909.810	1850.430	1909.460	1850.759	1909.419	1851.080	1909.040	1850	1910

Frequency Error vs. Temperature

Temp. (°C)	Frequency Error (MHz)												Limit (MHz)	
	1.4MHz		3MHz		5MHz		10MHz		15MHz		20MHz		Low Edge	High Edge
	Low	High	Low	High	Low	High	Low	High	Low	High	Low	High		
50	1850.163	1909.723	1850.178	1909.765	1850.330	1909.809	1850.430	1909.459	1850.760	1909.421	1851.081	1909.040	1850	1910
40	1850.163	1909.722	1850.177	1909.765	1850.330	1909.810	1850.429	1909.459	1850.760	1909.419	1851.081	1909.040	1850	1910
30	1850.164	1909.723	1850.177	1909.765	1850.329	1909.811	1850.430	1909.461	1850.761	1909.421	1851.081	1909.041	1850	1910
20	1850.163	1909.722	1850.177	1909.765	1850.329	1909.811	1850.431	1909.460	1850.760	1909.420	1851.081	1909.041	1850	1910
10	1850.163	1909.723	1850.177	1909.765	1850.331	1909.811	1850.430	1909.460	1850.761	1909.419	1851.081	1909.041	1850	1910
0	1850.163	1909.723	1850.177	1909.765	1850.331	1909.809	1850.431	1909.461	1850.760	1909.421	1851.081	1909.040	1850	1910
-10	1850.164	1909.721	1850.177	1909.765	1850.331	1909.810	1850.431	1909.460	1850.761	1909.421	1851.080	1909.040	1850	1910
-20	1850.163	1909.722	1850.177	1909.765	1850.329	1909.809	1850.430	1909.459	1850.760	1909.419	1851.080	1909.039	1850	1910
-30	1850.162	1909.721	1850.177	1909.764	1850.330	1909.810	1850.431	1909.460	1850.760	1909.421	1851.079	1909.040	1850	1910

4.4 Occupied Bandwidth Measurement

4.4.1 Test Procedure

All measurements were done at low, middle and high operational frequency range. The communication simulator station system controlled a EUT to export maximum output power under transmission mode and specific channel frequency. The bandwidth of the fundamental frequency was measured by spectrum analyzer with $RBW \geq 1\% \times OBW$ and $VBW \geq 3 \times RBW$.

Occupied Bandwidth Measurement:

Use OBW measurement function of Spectrum analyzer to measure 99 % occupied bandwidth.

26 dB Bandwidth Measurement:

The emission bandwidth is defined as the width of the signal between two points, one below the carrier center frequency and one above the carrier center frequency, outside of which all emission are attenuated at least 26dB below the transmitter power.

4.4.2 Test Setup

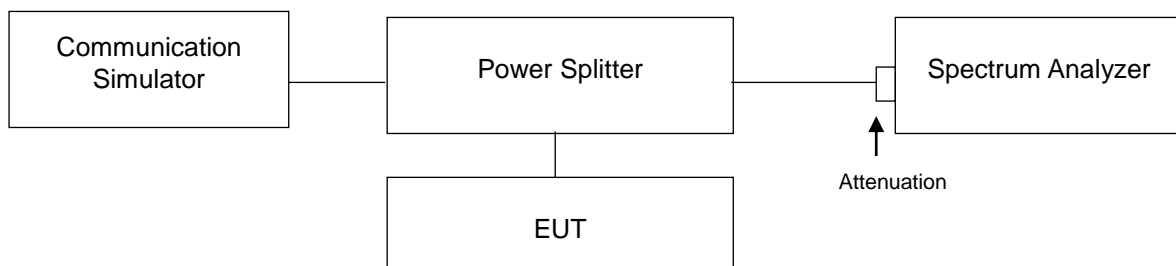

4.4.3 Test Result (-26dB Bandwidth)

LTE Band 2							
Channel Bandwidth 1.4MHz				Channel Bandwidth 3MHz			
Channel	Frequency (MHz)	-26dB Bandwidth (MHz)		Channel	Frequency (MHz)	-26dB Bandwidth (MHz)	
		QPSK	16QAM			QPSK	16QAM
18607	1850.7	1.38	1.32	18615	1851.5	1.75	1.39
18900	1880	1.38	1.30	18900	1880	1.87	1.41
19193	1909.3	1.40	1.33	19185	1908.5	1.91	1.42
Channel Bandwidth 5MHz				Channel Bandwidth 10MHz			
Channel	Frequency (MHz)	-26dB Bandwidth (MHz)		Channel	Frequency (MHz)	-26dB Bandwidth (MHz)	
		QPSK	16QAM			QPSK	16QAM
18625	1852.5	1.63	1.43	18650	1855	1.68	1.75
18900	1880	1.93	1.60	18900	1880	1.72	1.70
19175	1907.5	1.86	1.39	19150	1905	1.73	1.80
Channel Bandwidth 15MHz				Channel Bandwidth 20MHz			
Channel	Frequency (MHz)	-26dB Bandwidth (MHz)		Channel	Frequency (MHz)	-26dB Bandwidth (MHz)	
		QPSK	16QAM			QPSK	16QAM
18675	1857.5	1.68	1.84	18700	1860	1.72	1.59
18900	1880	1.72	1.70	18900	1880	1.67	1.71
19125	1902.5	1.72	1.68	19100	1900	1.88	1.83

Spectrum Plot of Worst Value

1.4MHz / QPSK

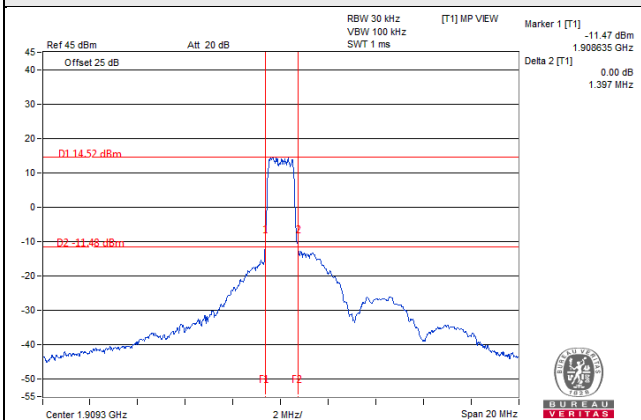

3MHz / QPSK

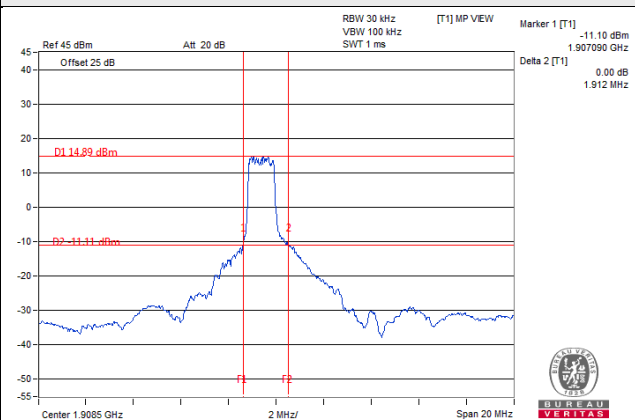

5MHz / QPSK

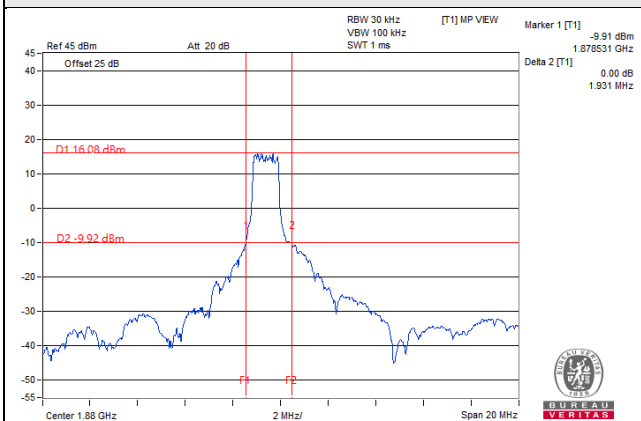

10MHz / 16QAM

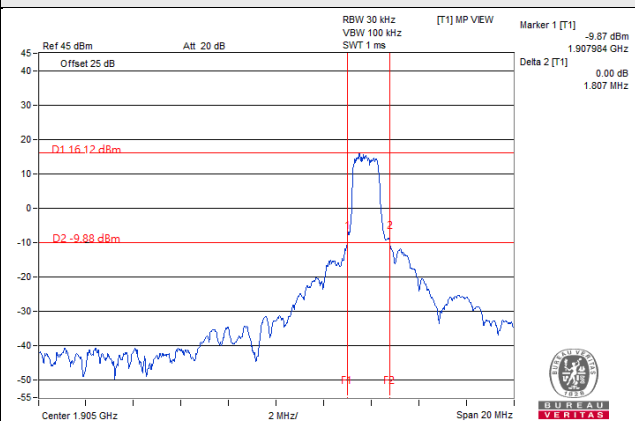

15MHz / 16QAM

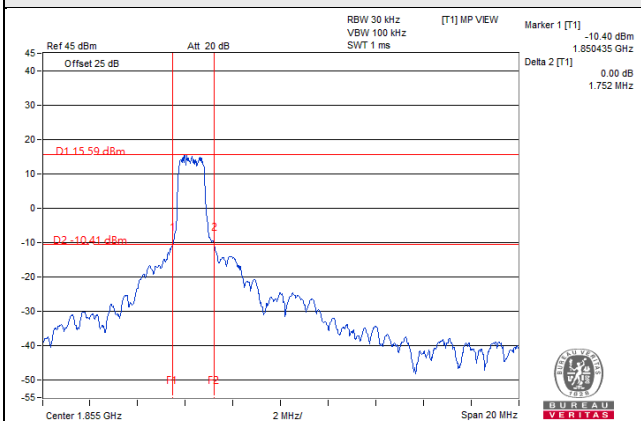

20MHz / QPSK

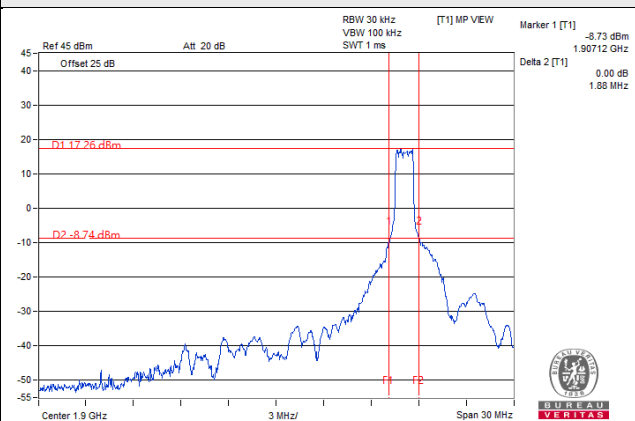

4.4.4 Test Result (Occupied Bandwidth)

LTE Band 2							
Channel Bandwidth 1.4MHz				Channel Bandwidth 3MHz			
Channel	Frequency (MHz)	99% Occupied Bandwidth (MHz)		Channel	Frequency (MHz)	99% Occupied Bandwidth (MHz)	
		QPSK	16QAM			QPSK	16QAM
18607	1850.7	1.12	1.12	18615	1851.5	1.18	1.14
18900	1880	1.12	1.12	18900	1880	1.18	1.14
19193	1909.3	1.12	1.12	19185	1908.5	1.20	1.14
Channel Bandwidth 5MHz				Channel Bandwidth 10MHz			
Channel	Frequency (MHz)	99% Occupied Bandwidth (MHz)		Channel	Frequency (MHz)	99% Occupied Bandwidth (MHz)	
		QPSK	16QAM			QPSK	16QAM
18625	1852.5	1.14	1.14	18650	1855	1.12	1.20
18900	1880	1.22	1.16	18900	1880	1.14	1.14
19175	1907.5	1.18	1.14	19150	1905	1.16	1.20
Channel Bandwidth 15MHz				Channel Bandwidth 20MHz			
Channel	Frequency (MHz)	99% Occupied Bandwidth (MHz)		Channel	Frequency (MHz)	99% Occupied Bandwidth (MHz)	
		QPSK	16QAM			QPSK	16QAM
18675	1857.5	1.14	1.18	18700	1860	1.17	1.14
18900	1880	1.16	1.16	18900	1880	1.14	1.14
19125	1902.5	1.16	1.16	19100	1900	1.14	1.20

Spectrum Plot of Worst Value

1.4MHz / QPSK

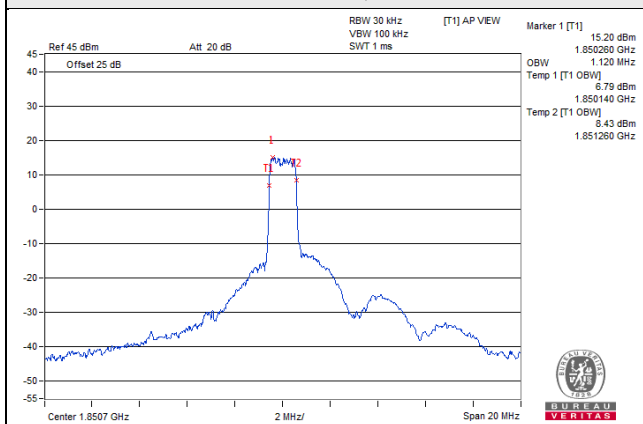

3MHz / QPSK

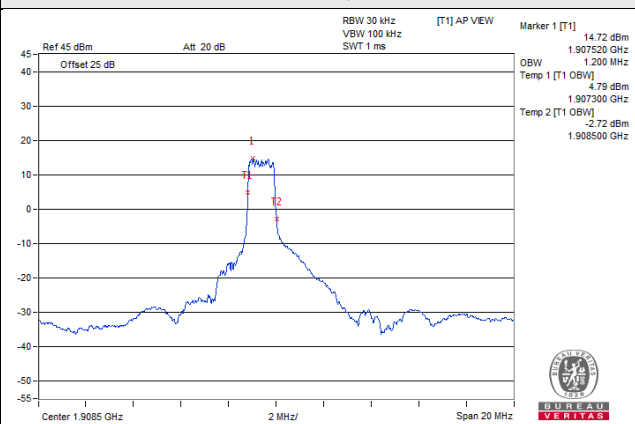

5MHz / QPSK

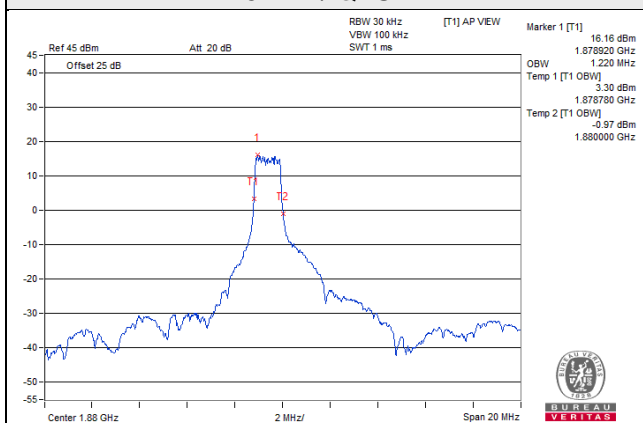

10MHz / 16QAM

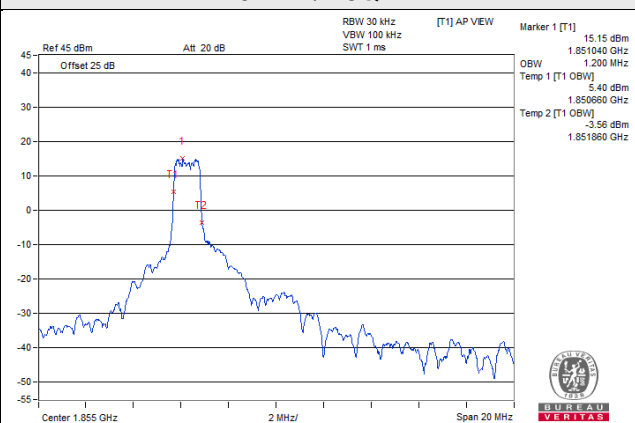

15MHz / 16QAM

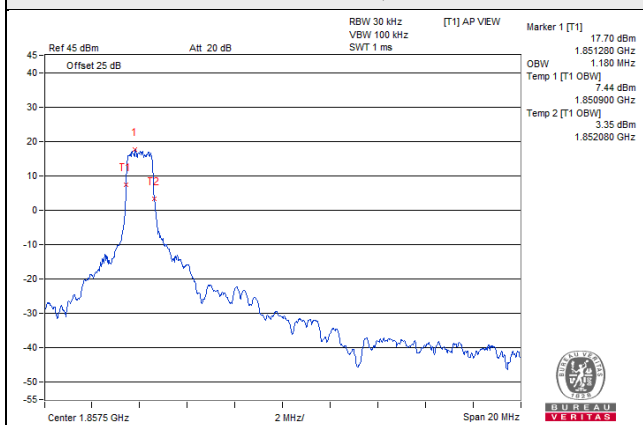

20MHz / 16QAM

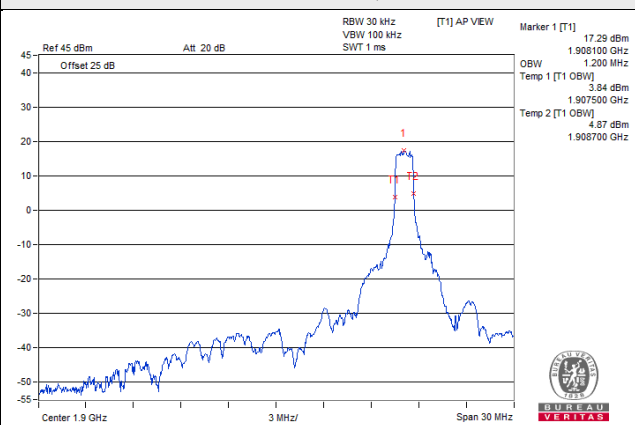

4.5 Band Edge Measurement

4.5.1 Limits of Band Edge Measurement

Power of any emission outside of the authorized operating frequency ranges must be attenuated below the transmitting power (P) by a factor of at least $43 + 10 \log(P)$ dB. In the 1 MHz bands immediately outside and adjacent to the frequency block a resolution bandwidth of at least one percent of the emission bandwidth of the fundamental emission of the transmitter may be employed.

4.5.2 Test Setup

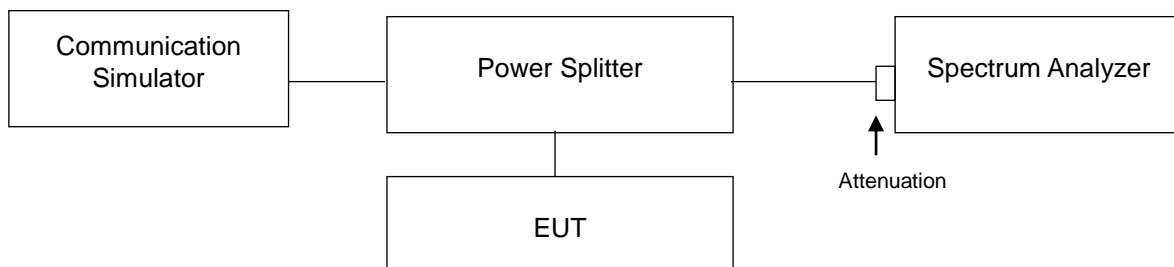

4.5.3 Test Procedures

- a. All measurements were done at low and high operational frequency range.
- b. The center frequency of spectrum is the band edge frequency and RB of the spectrum is $>1\%$ emission bandwidth and VB of the spectrum is $\geq 3 \cdot RB$.
- c. Record the max trace plot into the test report.

4.5.4 Test Results

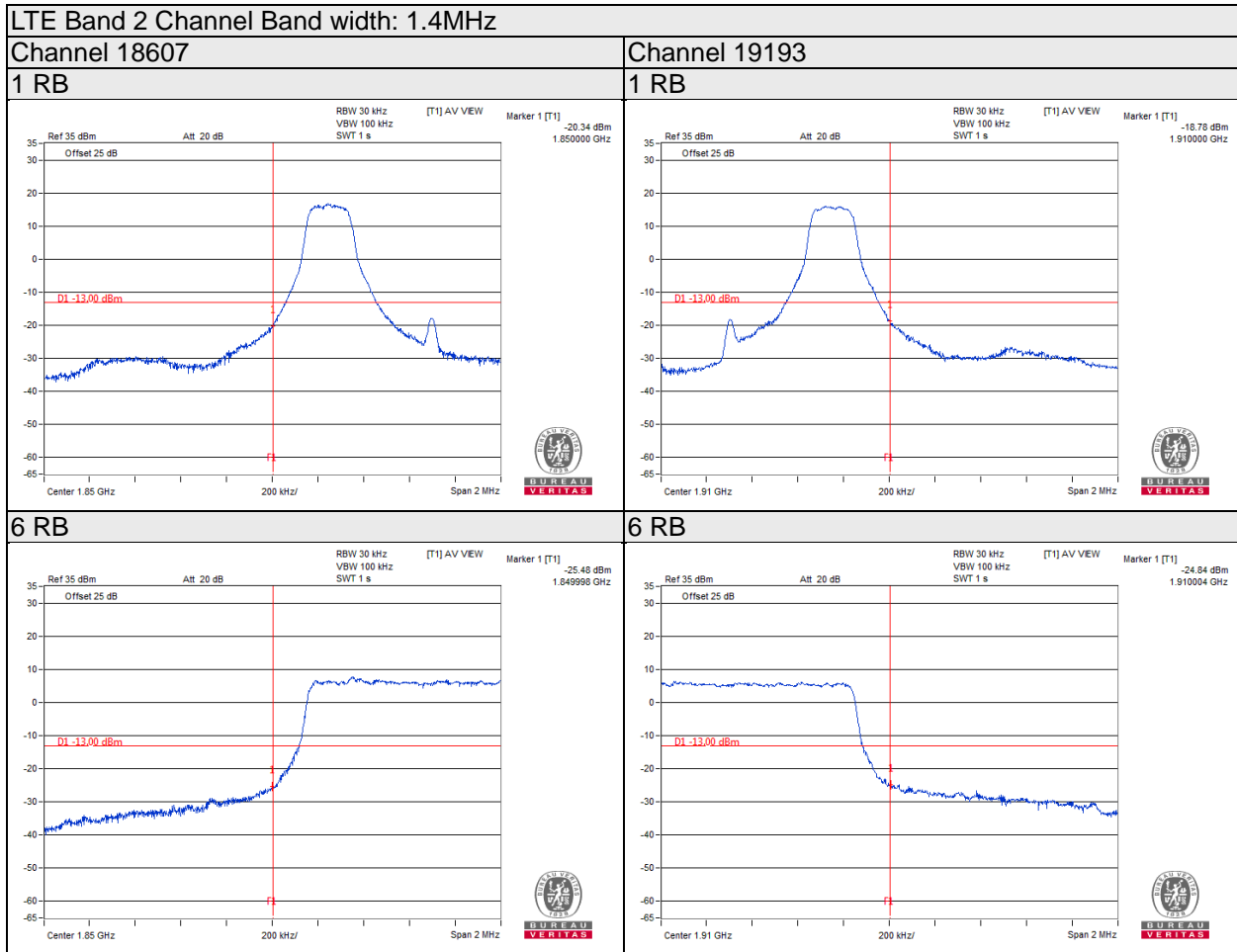

LTE Band 2 Channel Band width: 3MHz

Channel 18615

1 RB

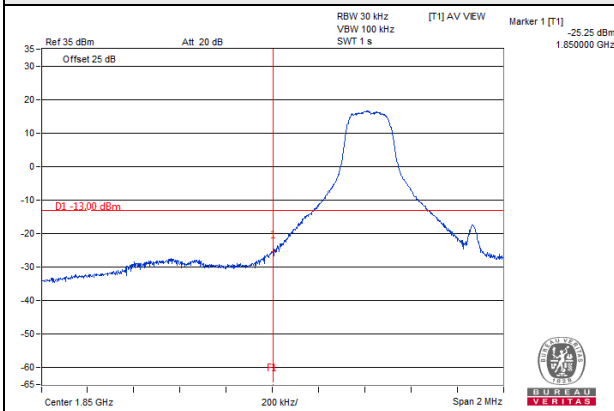

Channel 19185

1 RB

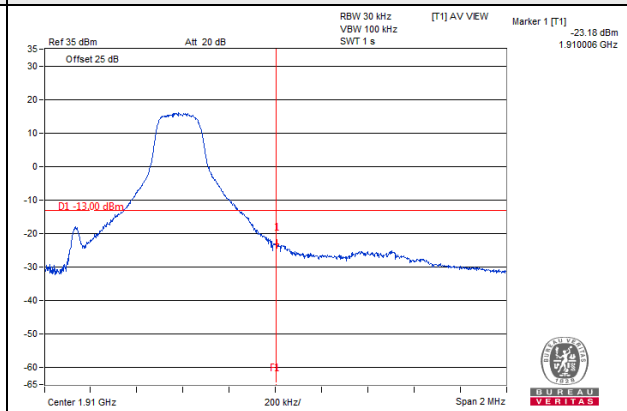

6 RB

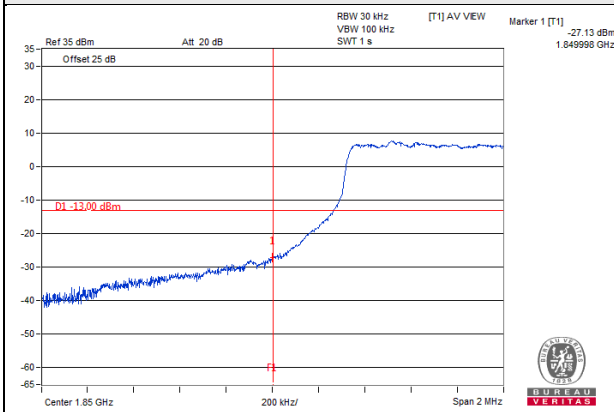

6 RB

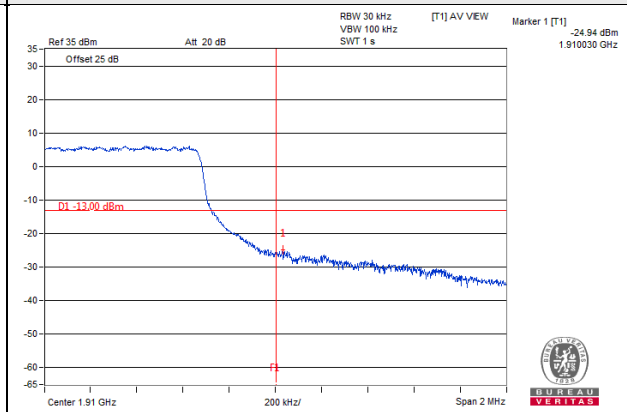

LTE Band 2 Channel Band width: 5MHz

Channel 18625

1 RB

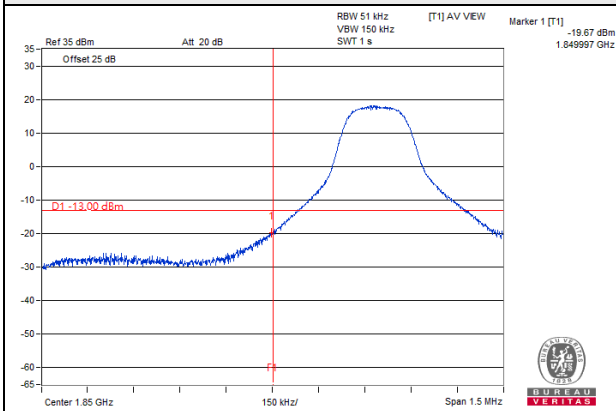

Channel 19175

1 RB

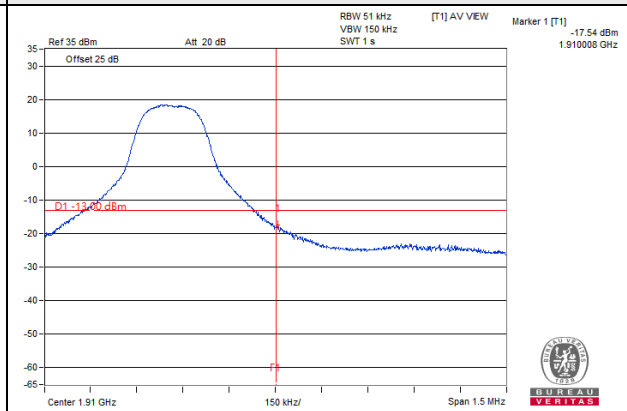

6 RB

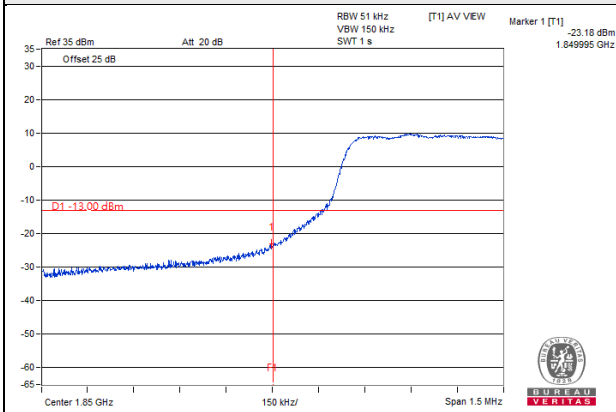

6 RB

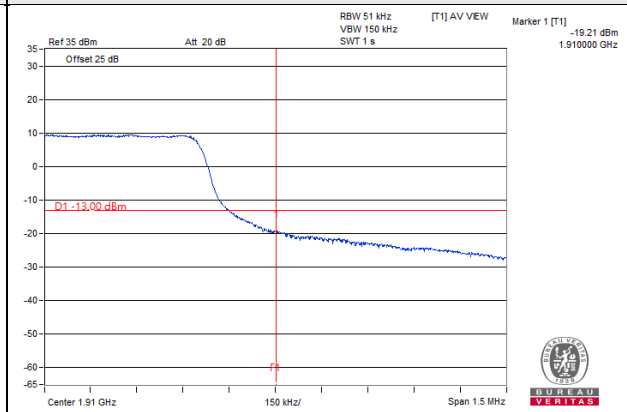

LTE Band 2 Channel Band width: 10MHz

Channel 18650

1 RB

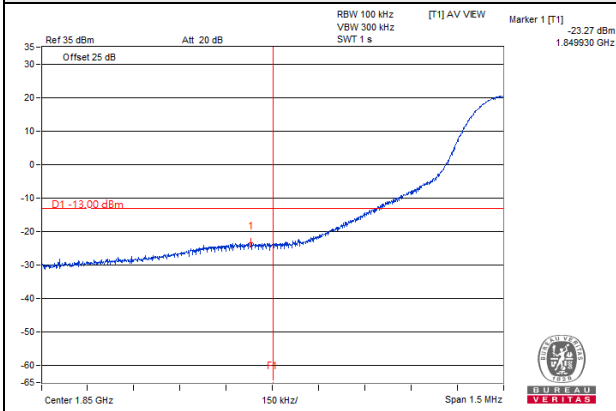

Channel 19150

1 RB

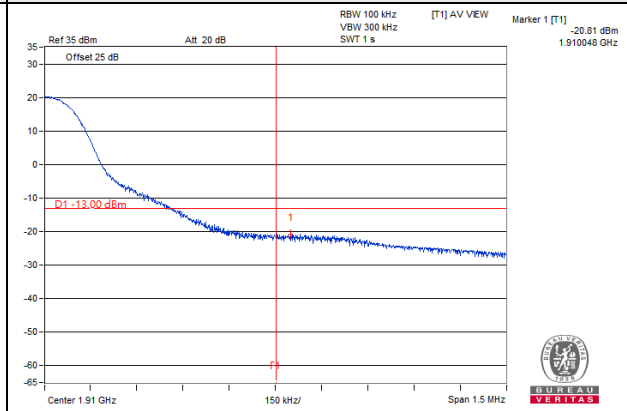

6 RB

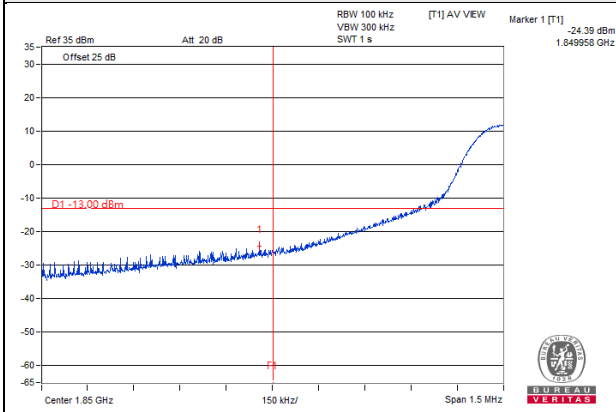

6 RB

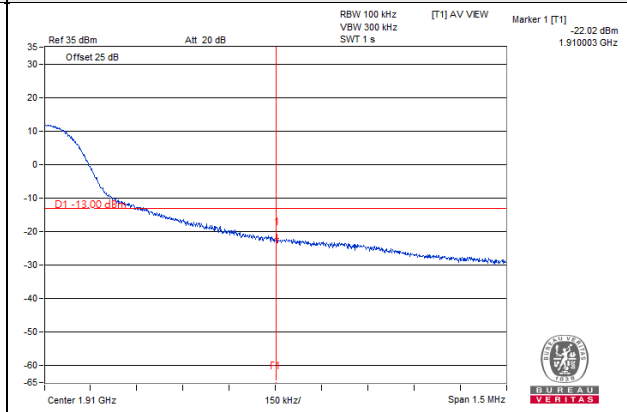

LTE Band 2 Channel Band width: 15MHz

Channel 18675

1 RB

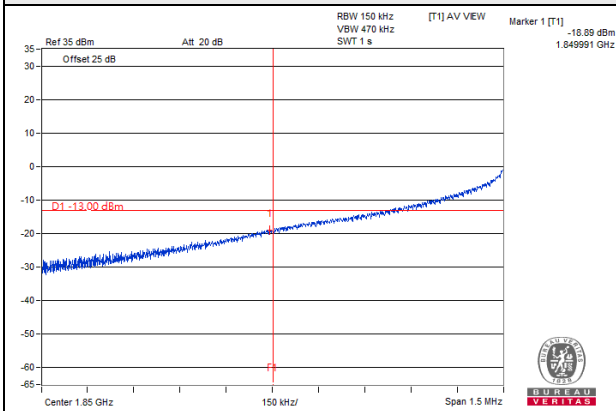

Channel 19125

1 RB

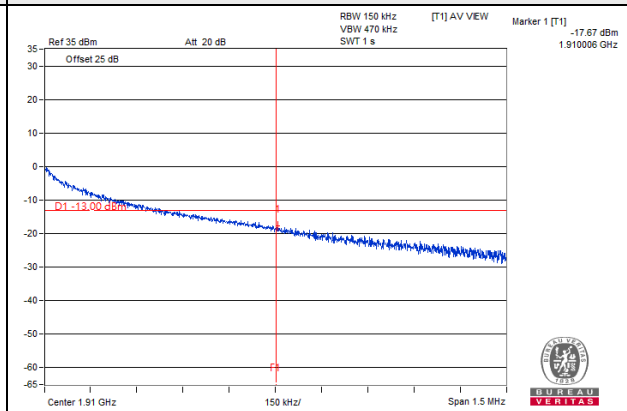

6 RB

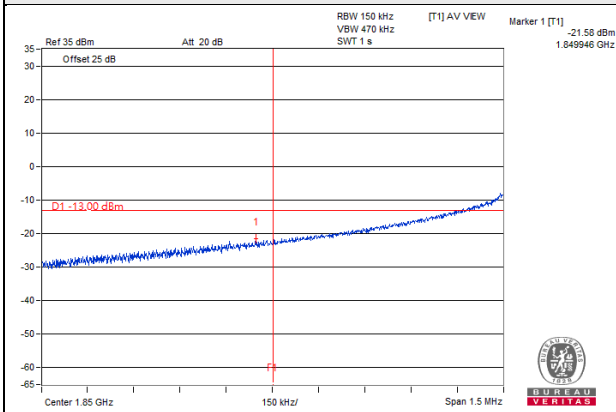

6 RB

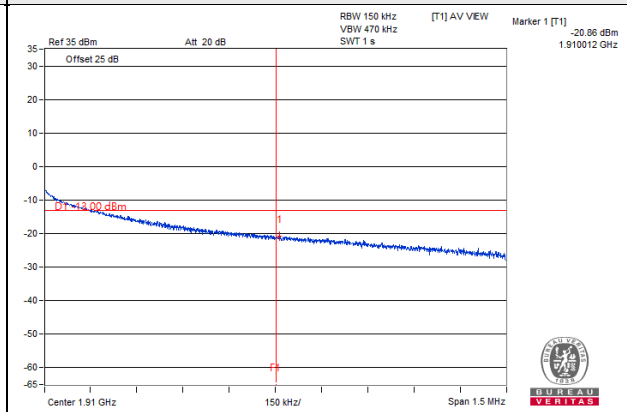

LTE Band 2 Channel Band width: 20MHz

Channel 18700

1 RB

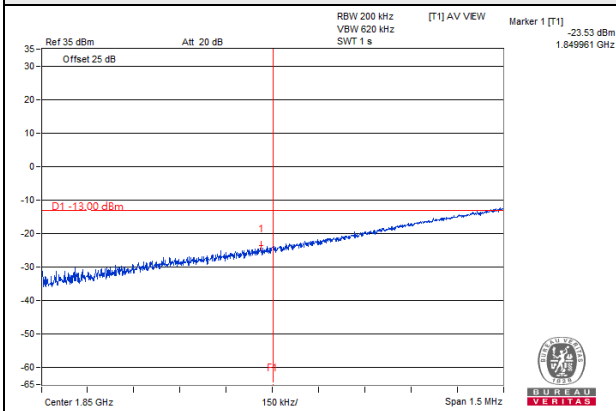

Channel 19100

1 RB

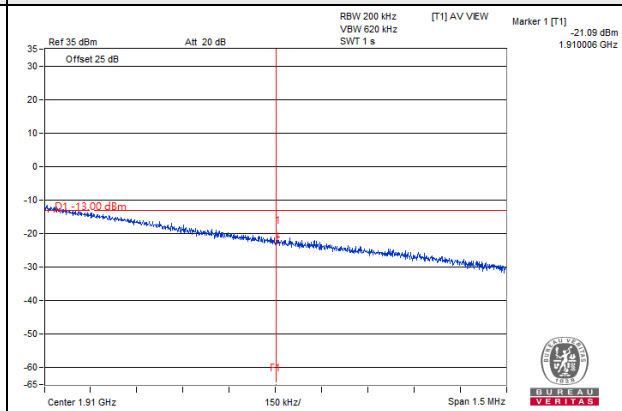

6 RB

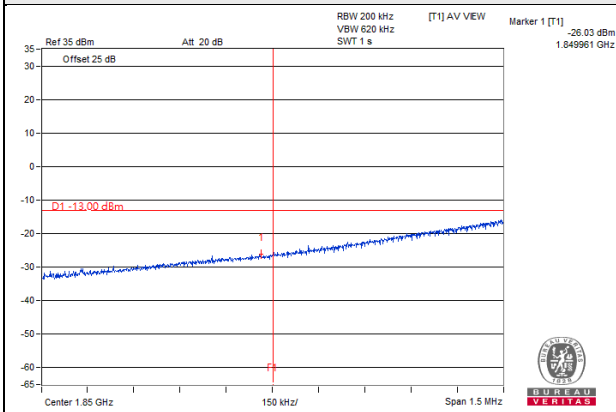

6 RB

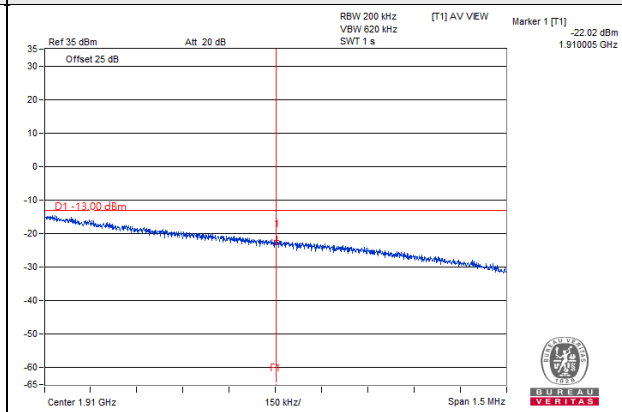

4.6 Peak to Average Ratio

4.5.1 Limits of Peak to Average Ratio Measurement

In measuring transmissions in this band using an average power technique, the peak to-average ratio (PAR) of the transmission may not exceed 13 dB

4.5.2 Test Setup

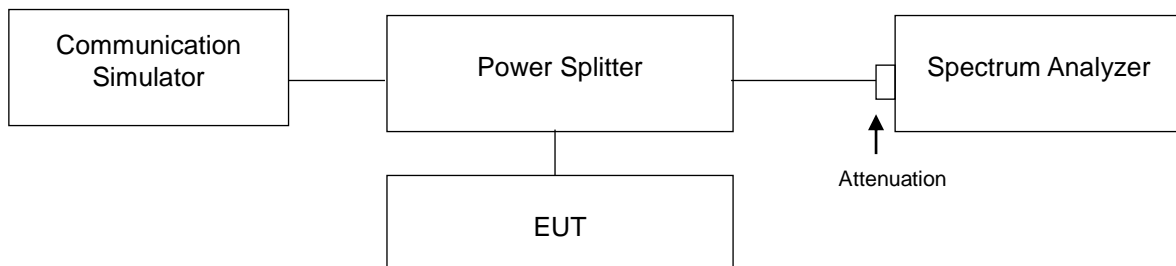

4.5.3 Test Procedures

1. Set resolution/measurement bandwidth \geq signal's occupied bandwidth;
2. Set the number of counts to a value that stabilizes the measured CCDF curve;
3. Record the maximum PAPR level associated with a probability of 0.1%.

4.5.4 Test Results

LTE Band 2							
Channel Bandwidth 1.4MHz				Channel Bandwidth 3MHz			
Channel	Frequency (MHz)	Peak To Average Ratio (dB)		Channel	Frequency (MHz)	Peak To Average Ratio (dB)	
		QPSK	16QAM			QPSK	16QAM
18607	1850.7	5.70	6.35	18615	1851.5	5.21	6.14
18900	1880	5.97	6.58	18900	1880	5.45	6.38
19193	1909.3	6.20	6.85	19185	1908.5	5.71	6.62
Channel Bandwidth 5MHz				Channel Bandwidth 10MHz			
Channel	Frequency (MHz)	Peak To Average Ratio (dB)		Channel	Frequency (MHz)	Peak To Average Ratio (dB)	
		QPSK	16QAM			QPSK	16QAM
18625	1852.5	5.07	5.98	18650	1855	4.94	5.95
18900	1880	5.06	6.10	18900	1880	5.01	6.08
19175	1907.5	5.58	6.54	19150	1905	5.41	6.45
Channel Bandwidth 15MHz				Channel Bandwidth 20MHz			
Channel	Frequency (MHz)	Peak To Average Ratio (dB)		Channel	Frequency (MHz)	Peak To Average Ratio (dB)	
		QPSK	16QAM			QPSK	16QAM
18675	1857.5	4.67	5.47	18700	1860	4.67	5.49
18900	1880	4.85	5.65	18900	1880	4.88	5.96
19125	1902.5	5.18	5.88	19100	1900	5.10	5.81

Spectrum Plot of Worst Value



4.7 Conducted Spurious Emissions

4.7.1 Limits of Conducted Spurious Emissions Measurement

The power of any emission outside of the authorized operating frequency ranges must be attenuated below the transmitting power (P) by a factor of at least $43 + 10 \log(P)$ dB. The emission limit equal to -13dBm .

4.7.2 Test Setup

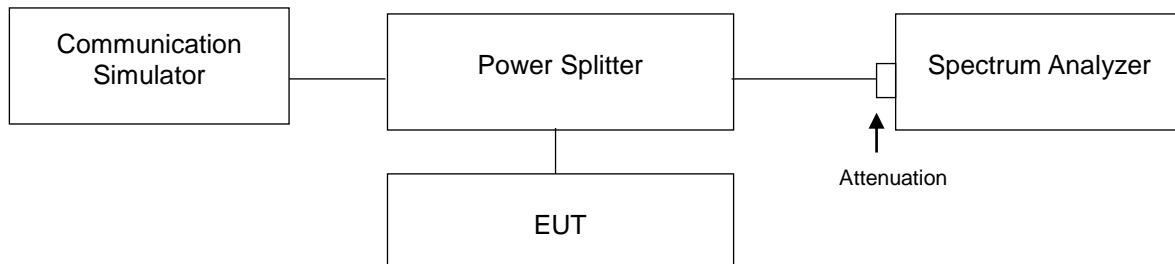

4.7.3 Test Procedure

- a. All measurements were done at low, middle and high operational frequency range.
- b. Measuring frequency range is from 9 kHz to the tenth harmonic of the highest fundamental frequency, it shall be connected to the pad attenuated the carried frequency.

RBW=1MHz and VBW=3MHz is used for conducted emission measurement.

4.7.4 Test Results

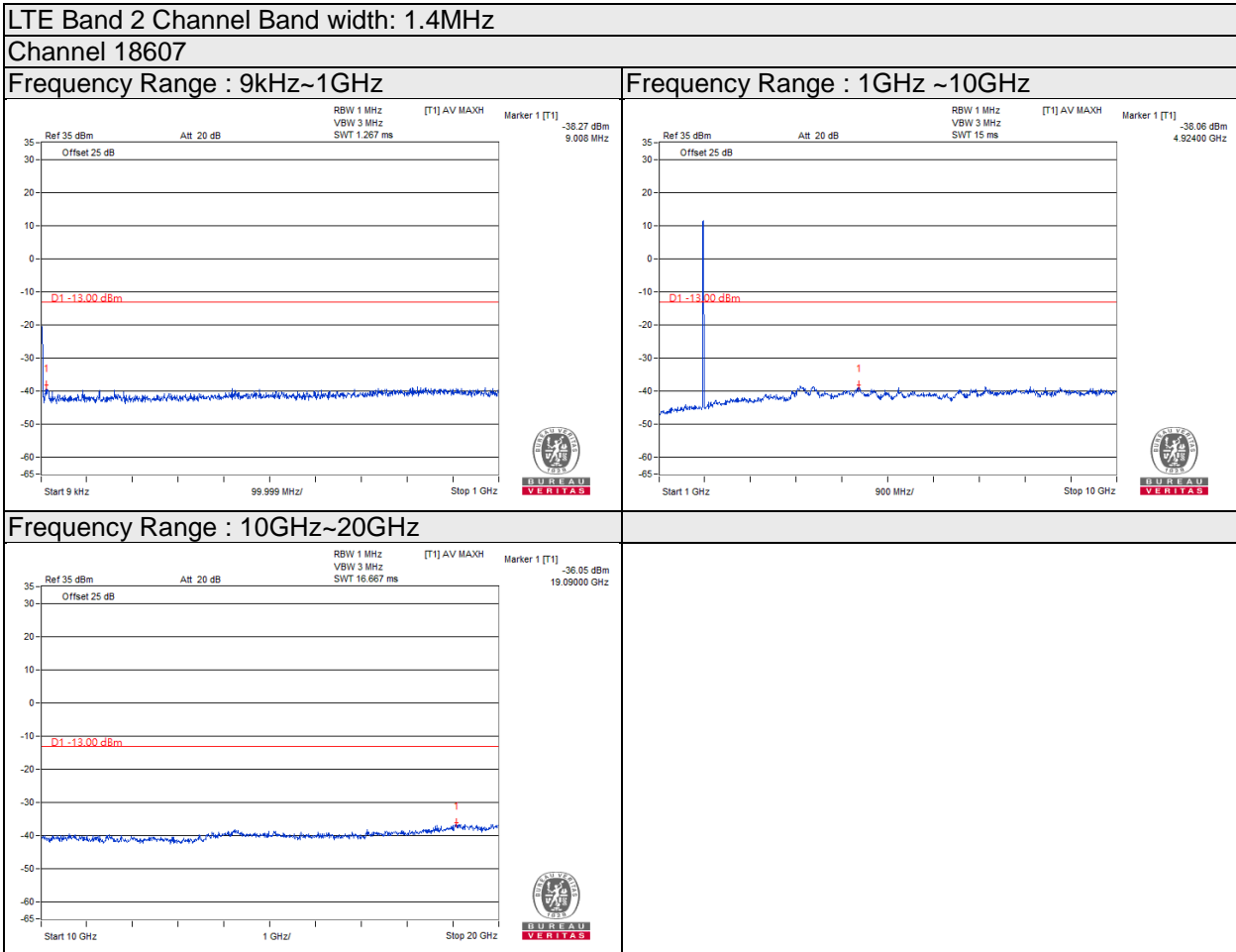

Note: The signal at 9 kHz is IF signal from spectrum analyzer.

LTE Band 2 Channel Band width: 1.4MHz
Channel 18900

Frequency Range : 9kHz~1GHz

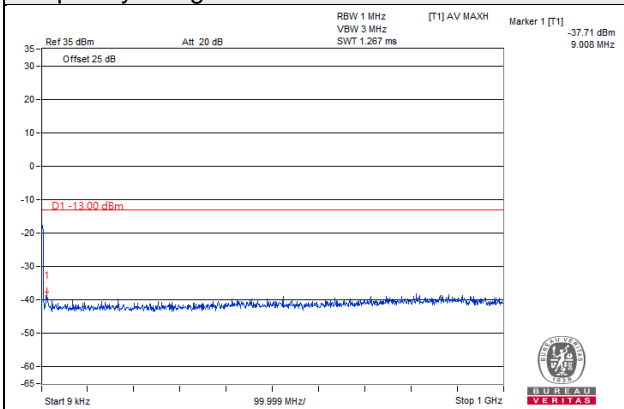

Frequency Range : 1GHz ~10GHz

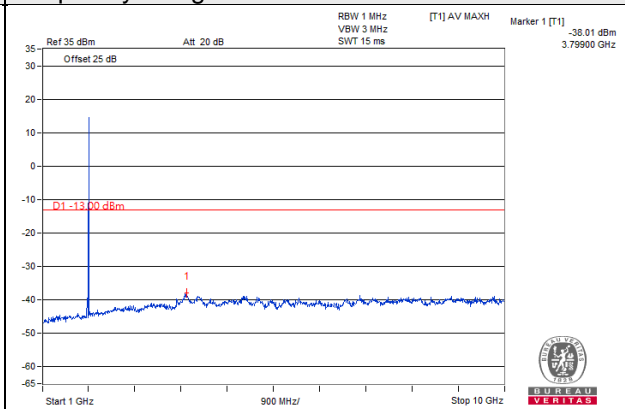

Frequency Range : 10GHz~20GHz

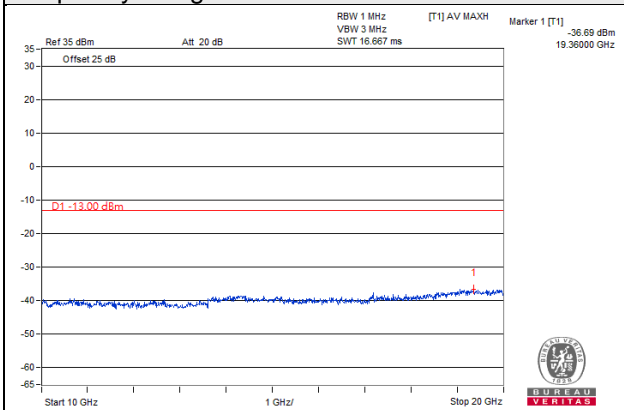

Note: The signal at 9 kHz is IF signal from spectrum analyzer.

LTE Band 2 Channel Band width: 1.4MHz

Channel 19193

Frequency Range : 9kHz~1GHz

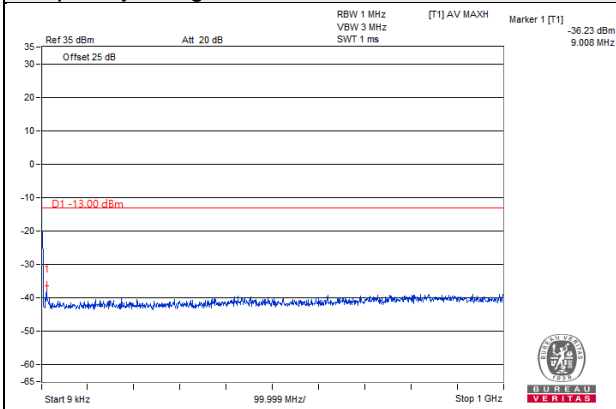

Frequency Range : 1GHz ~10GHz

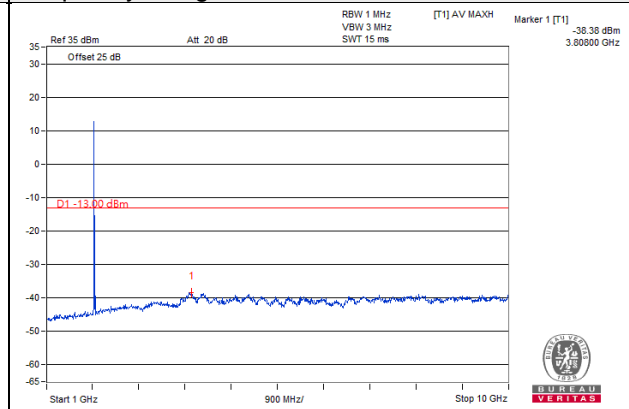

Frequency Range : 10GHz~20GHz

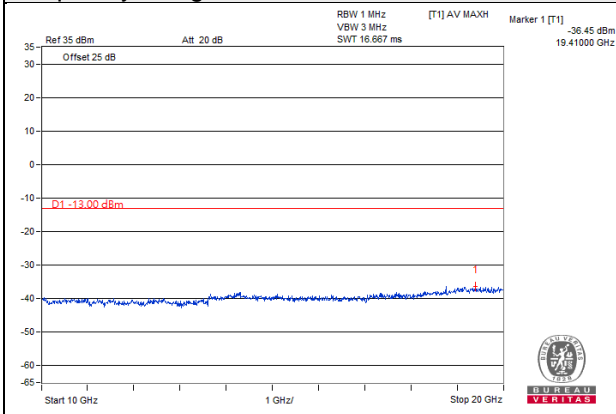

Note: The signal at 9 kHz is IF signal from spectrum analyzer.

LTE Band 2 Channel Band width: 3MHz

Channel 18615

Frequency Range : 9kHz~1GHz

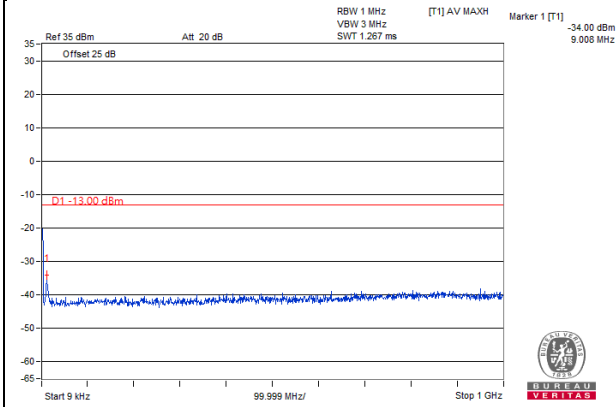

Frequency Range : 1GHz ~10GHz

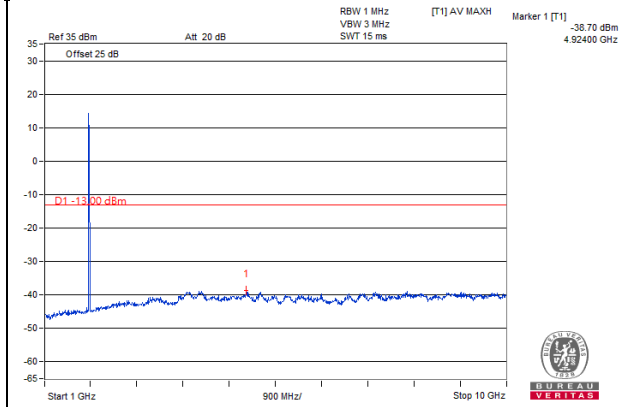

Frequency Range : 10GHz~20GHz

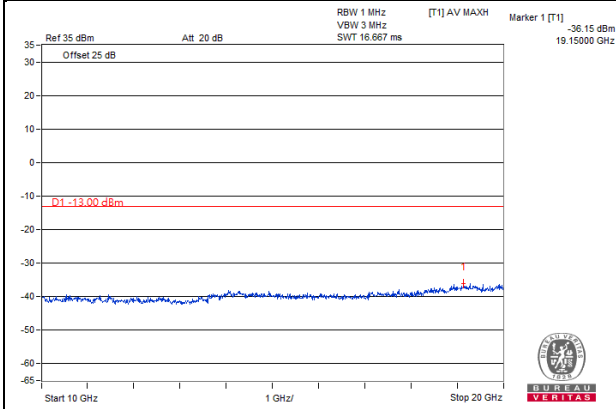

Note: The signal at 9 kHz is IF signal from spectrum analyzer.

LTE Band 2 Channel Band width: 3MHz
Channel 18900

Frequency Range : 9kHz~1GHz

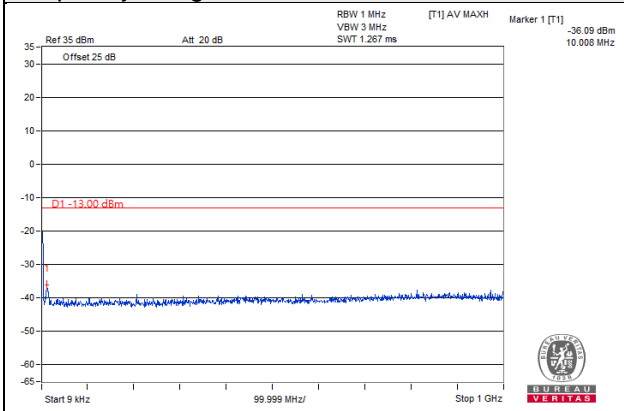

Frequency Range : 1GHz ~10GHz

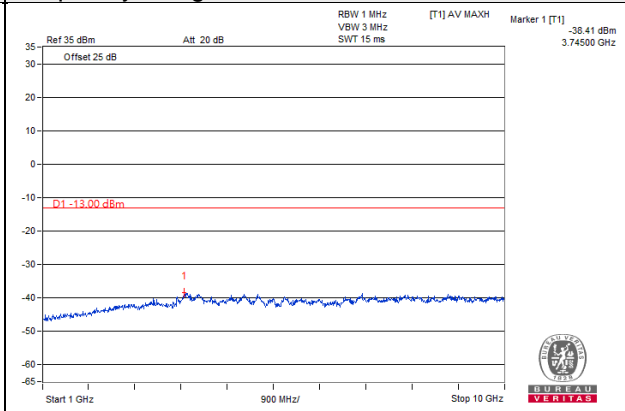

Frequency Range : 10GHz~20GHz

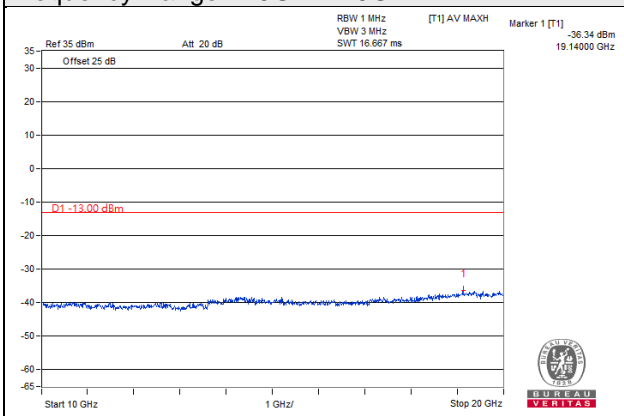

Note: The signal at 9 kHz is IF signal from spectrum analyzer.

LTE Band 2 Channel Band width: 3MHz

Channel 19185

Frequency Range : 9kHz~1GHz

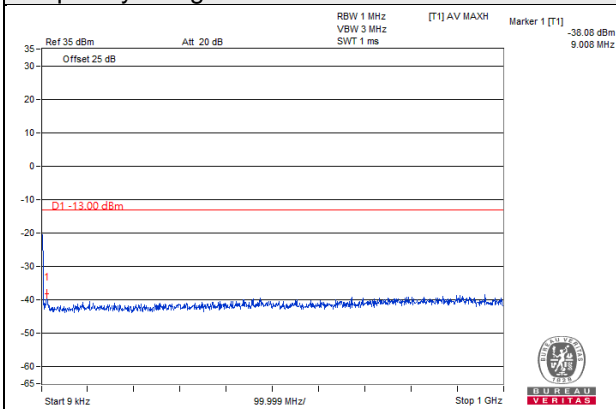

Frequency Range : 1GHz ~10GHz

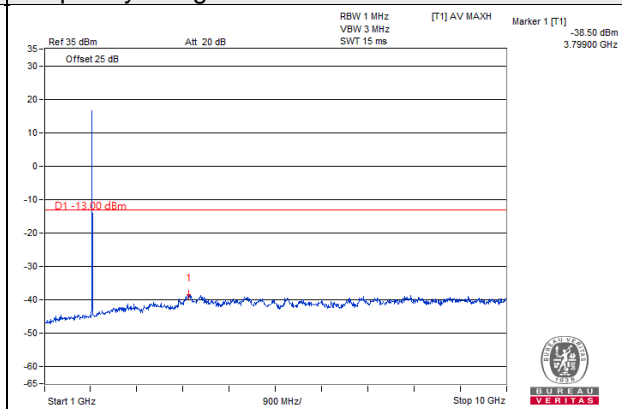

Frequency Range : 10GHz~20GHz

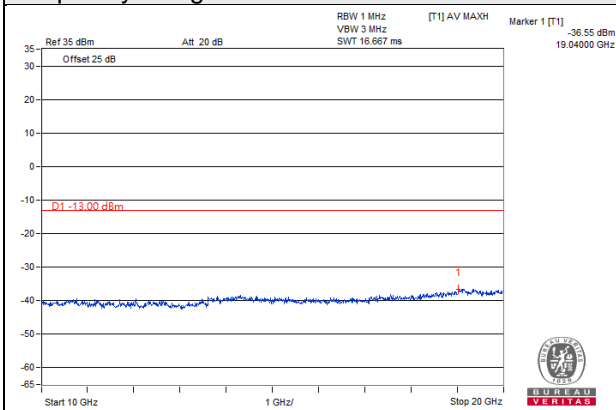

Note: The signal at 9 kHz is IF signal from spectrum analyzer.

LTE Band 2 Channel Band width: 5MHz

Channel 18625

Frequency Range : 9kHz~1GHz

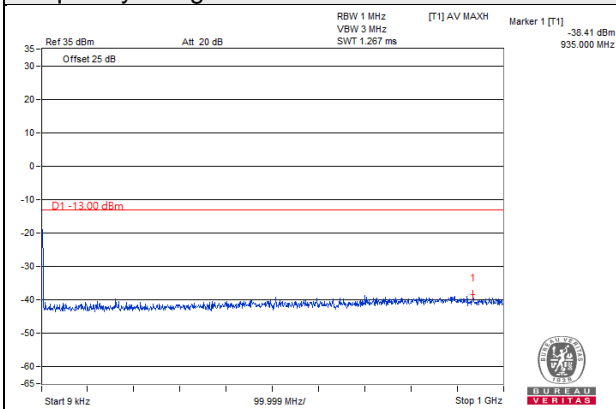

Frequency Range : 1GHz ~10GHz

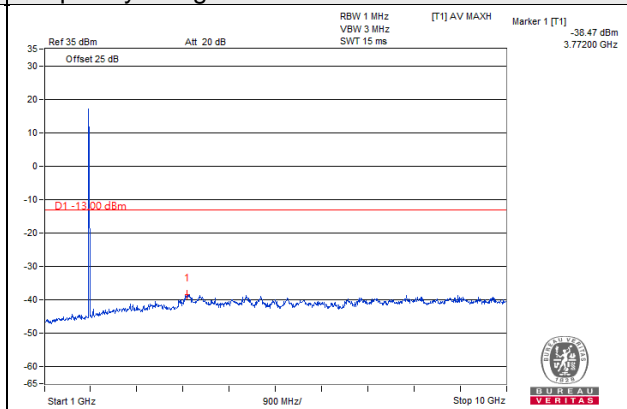

Frequency Range : 10GHz~20GHz

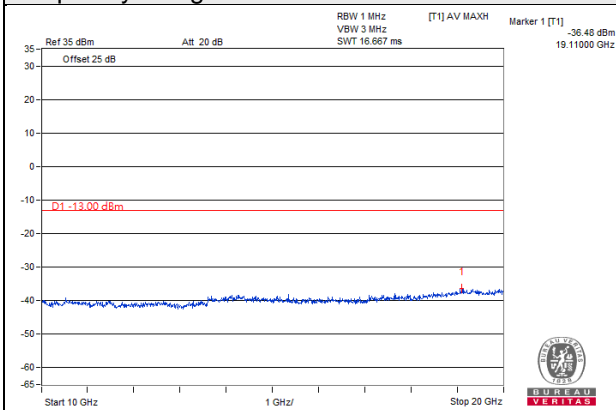

Note: The signal at 9 kHz is IF signal from spectrum analyzer.

LTE Band 2 Channel Band width: 5MHz

Channel 18900

Frequency Range : 9kHz~1GHz

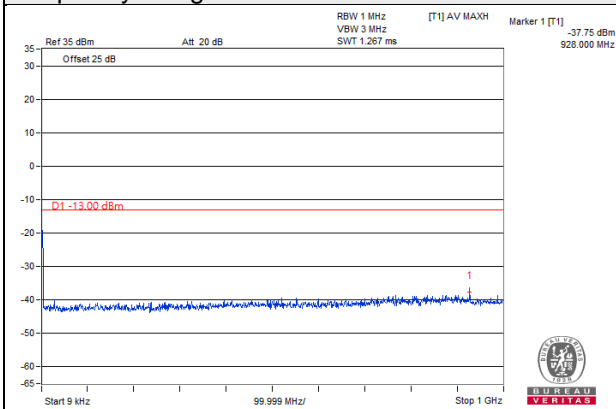

Frequency Range : 1GHz ~10GHz

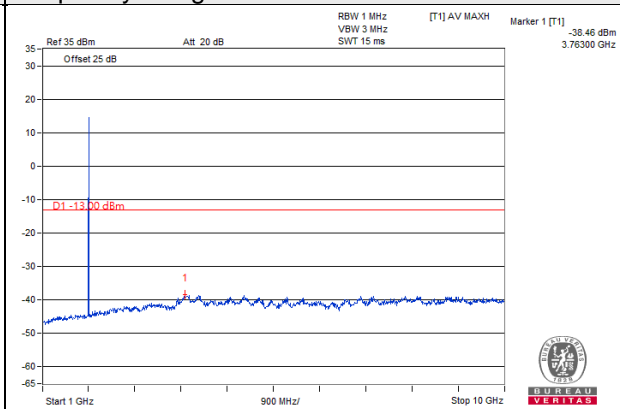

Frequency Range : 10GHz~20GHz

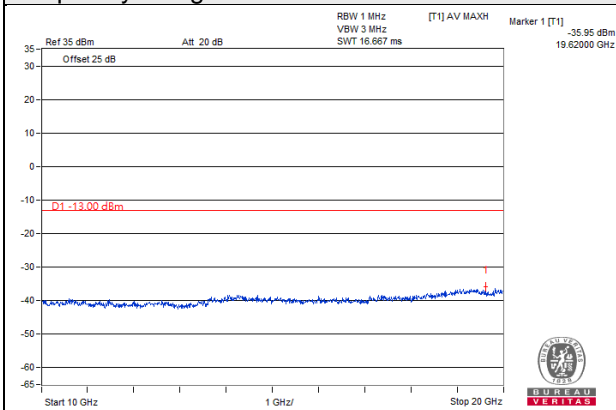

Note: The signal at 9 kHz is IF signal from spectrum analyzer.

LTE Band 2 Channel Band width: 5MHz

Channel 19175

Frequency Range : 9kHz~1GHz

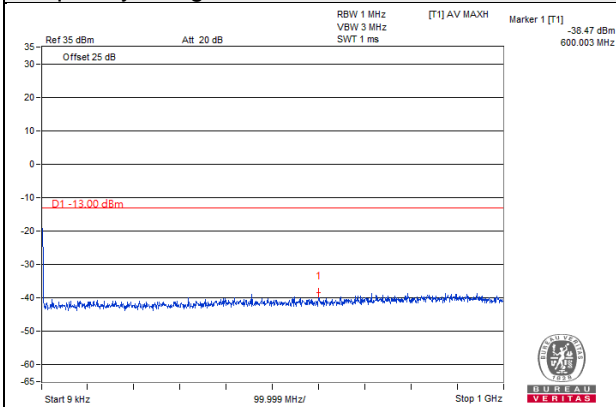

Frequency Range : 1GHz ~10GHz

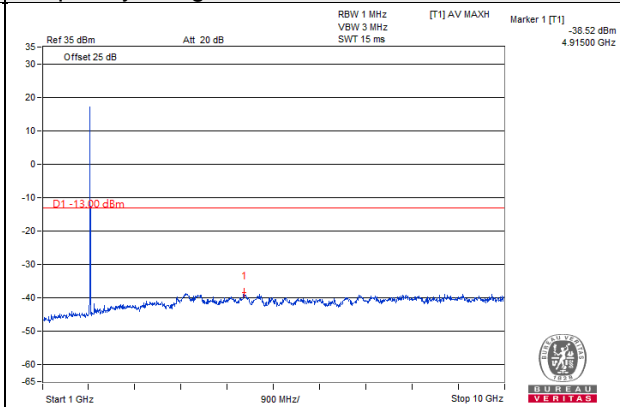

Frequency Range : 10GHz~20GHz

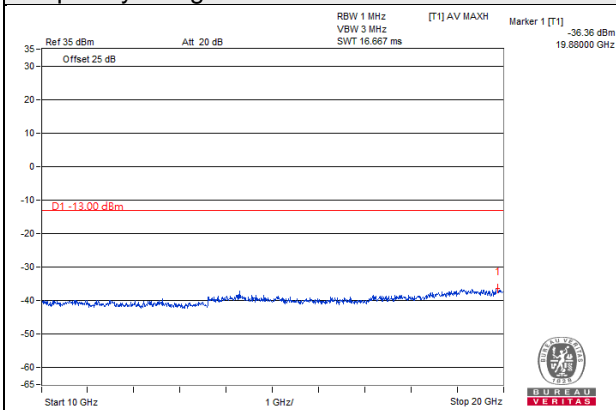

Note: The signal at 9 kHz is IF signal from spectrum analyzer.

LTE Band 2 Channel Band width: 10MHz

Channel 18650

Frequency Range : 9kHz~1GHz

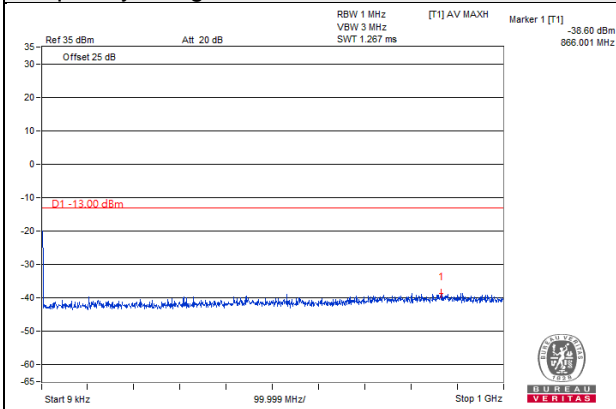

Frequency Range : 1GHz ~10GHz

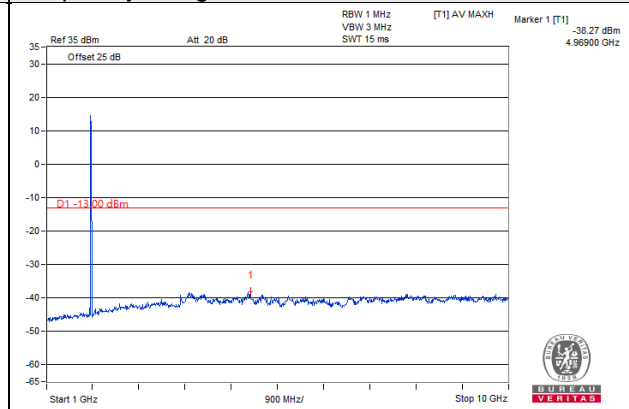

Frequency Range : 10GHz~20GHz

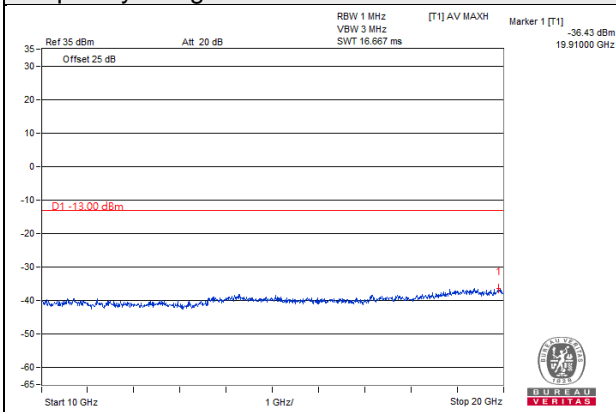

Note: The signal at 9 kHz is IF signal from spectrum analyzer.

LTE Band 2 Channel Band width: 10MHz

Channel 18900

Frequency Range : 9kHz~1GHz

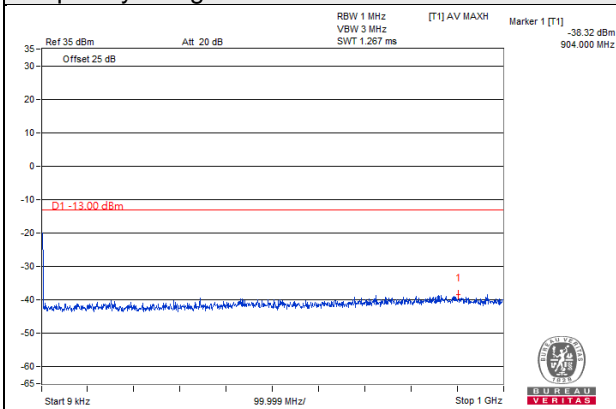

Frequency Range : 1GHz ~10GHz

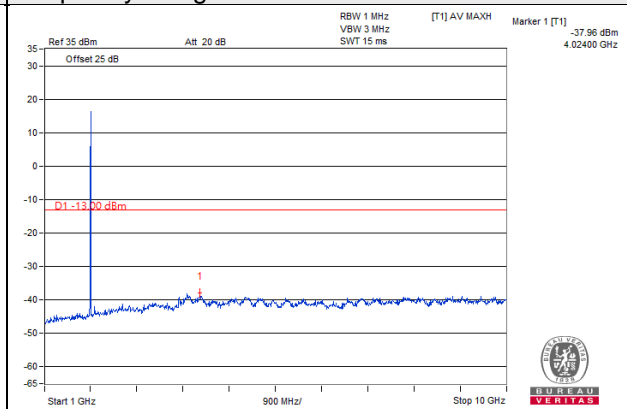

Frequency Range : 10GHz~20GHz

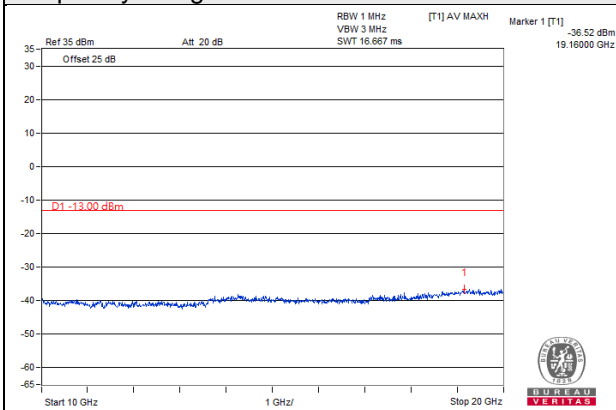

Note: The signal at 9 kHz is IF signal from spectrum analyzer.

LTE Band 2 Channel Band width: 10MHz

Channel 19150

Frequency Range : 9kHz~1GHz

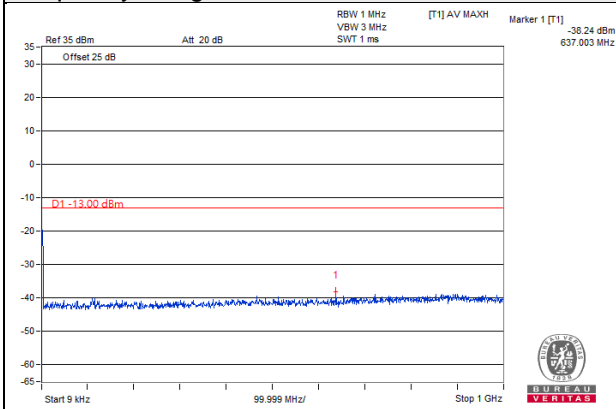

Frequency Range : 1GHz ~10GHz

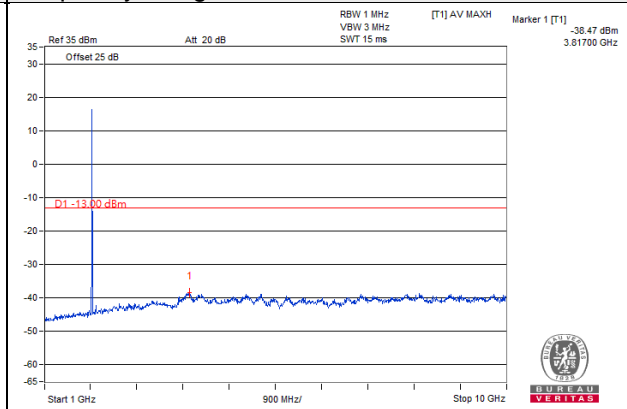

Frequency Range : 10GHz~20GHz

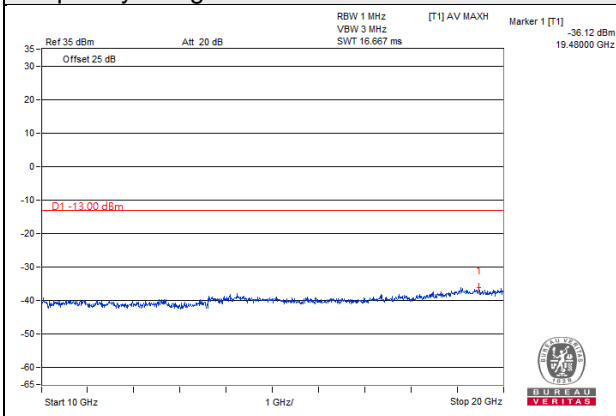

Note: The signal at 9 kHz is IF signal from spectrum analyzer.

LTE Band 2 Channel Band width: 15MHz

Channel 18675

Frequency Range : 9kHz~1GHz

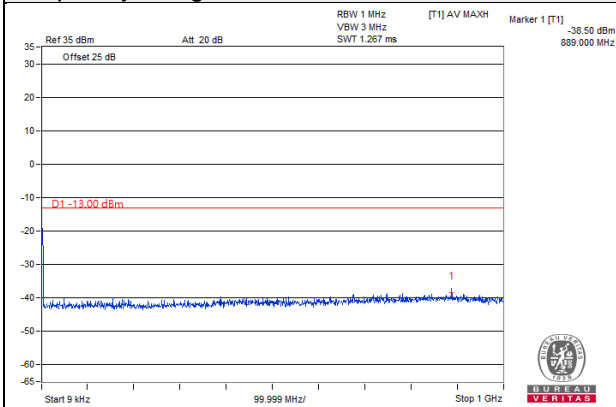

Frequency Range : 1GHz ~10GHz

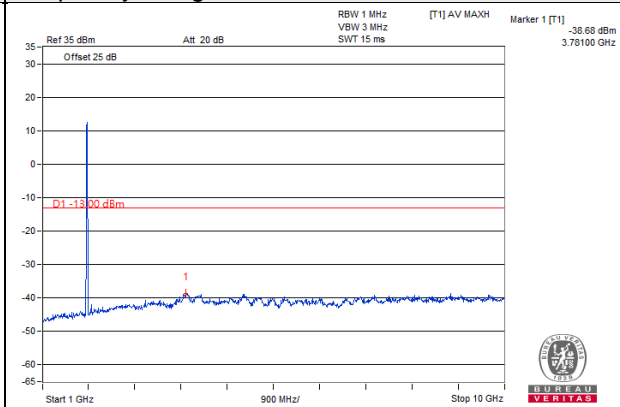

Frequency Range : 10GHz~20GHz

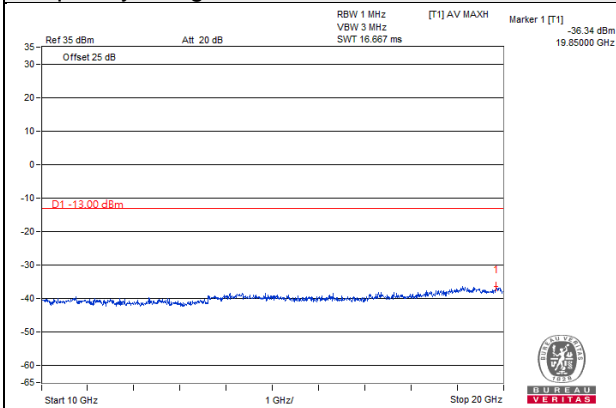

Note: The signal at 9 kHz is IF signal from spectrum analyzer.

LTE Band 2 Channel Band width: 15MHz

Channel 18900

Frequency Range : 9kHz~1GHz

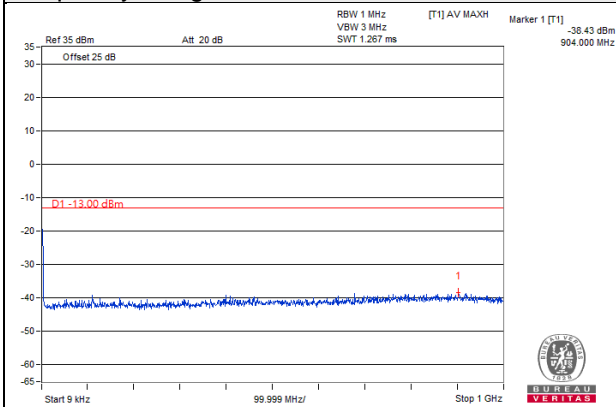

Frequency Range : 1GHz ~10GHz

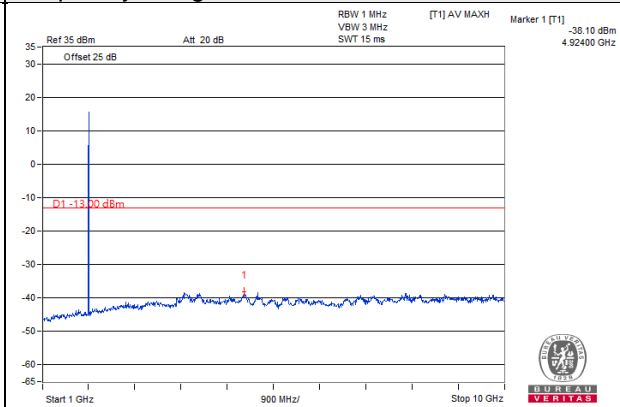

Frequency Range : 10GHz~20GHz

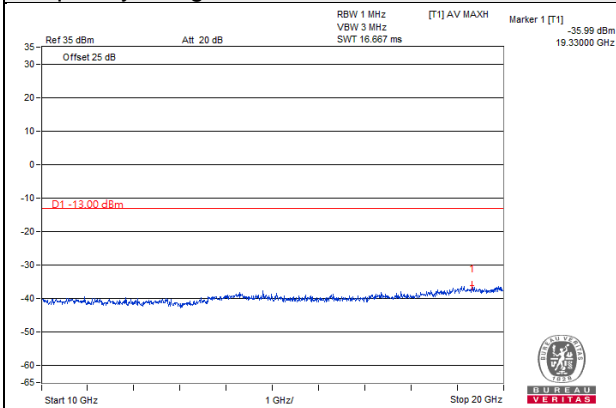

Note: The signal at 9 kHz is IF signal from spectrum analyzer.

LTE Band 2 Channel Band width: 15MHz

Channel 19125

Frequency Range : 9kHz~1GHz

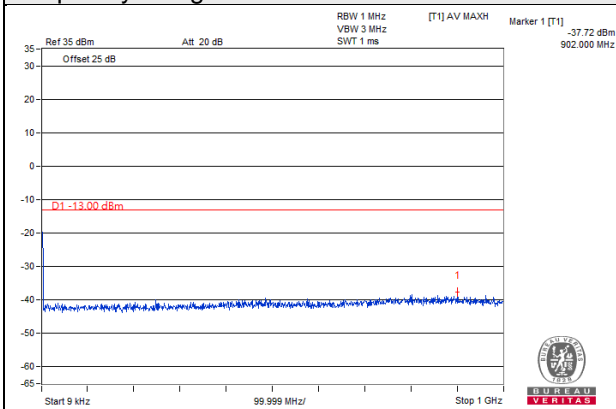

Frequency Range : 1GHz ~10GHz

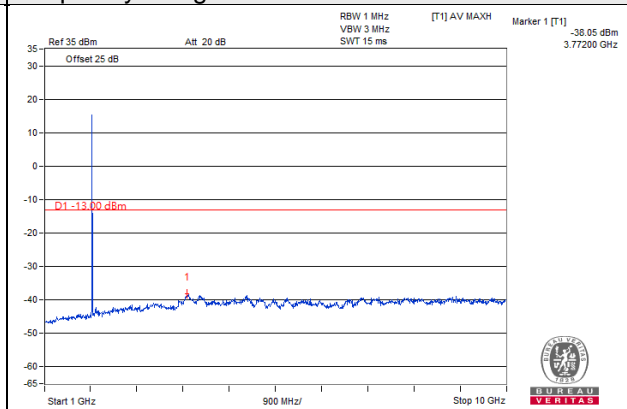

Frequency Range : 10GHz~20GHz

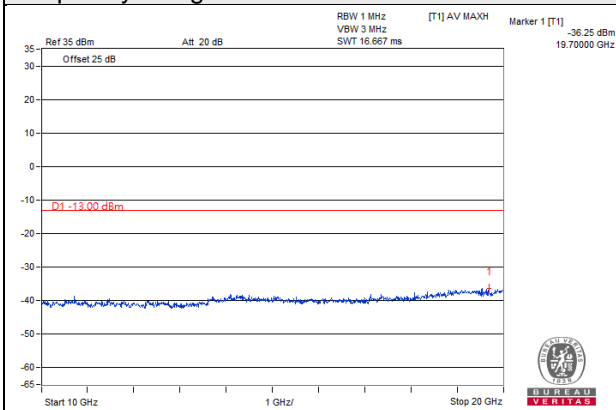

Note: The signal at 9 kHz is IF signal from spectrum analyzer.

LTE Band 2 Channel Band width: 20MHz

Channel 18700

Frequency Range : 9kHz~1GHz

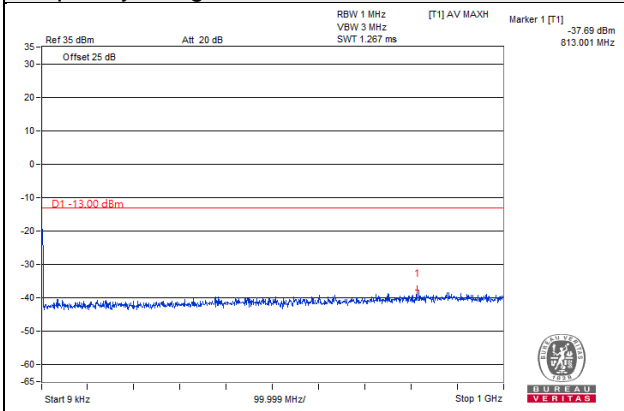

Frequency Range : 1GHz ~10GHz

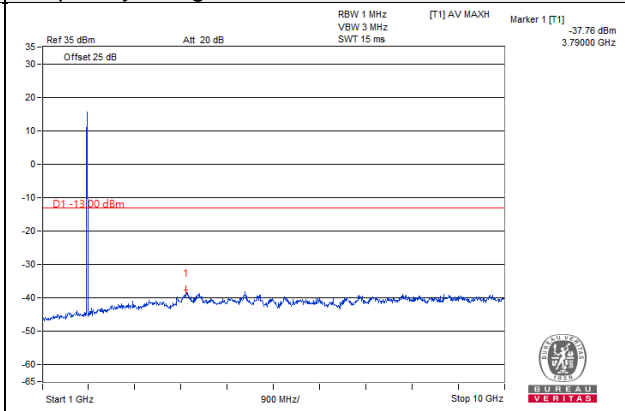

Frequency Range : 10GHz~20GHz

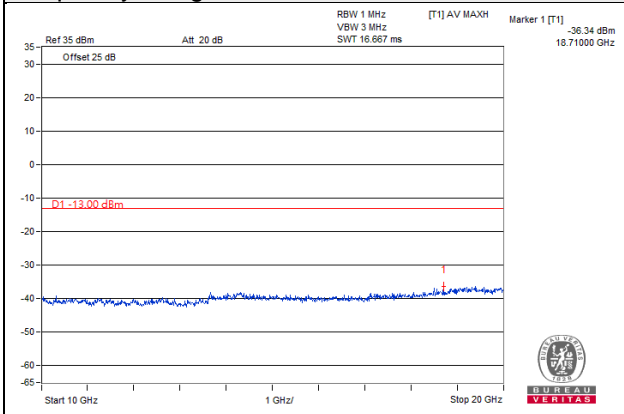

Note: The signal at 9 kHz is IF signal from spectrum analyzer.

LTE Band 2 Channel Band width: 20MHz

Channel 18900

Frequency Range : 9kHz~1GHz

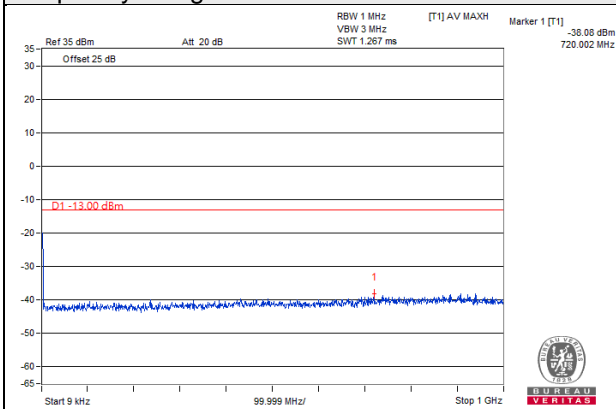

Frequency Range : 1GHz ~10GHz

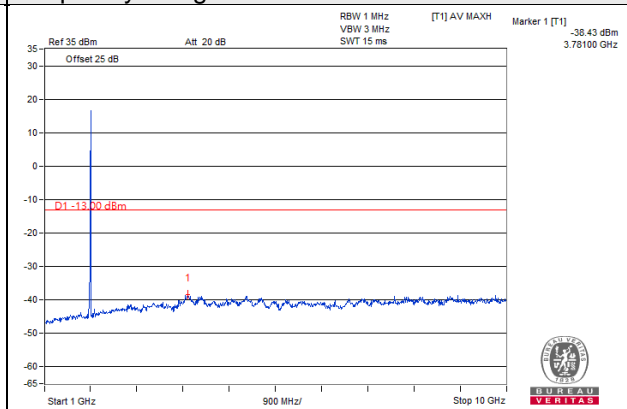

Frequency Range : 10GHz~20GHz

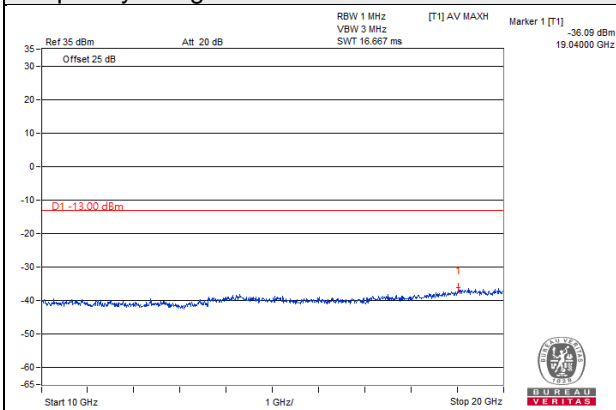

Note: The signal at 9 kHz is IF signal from spectrum analyzer.

LTE Band 2 Channel Band width: 20MHz

Channel 19100

Frequency Range : 9kHz~1GHz

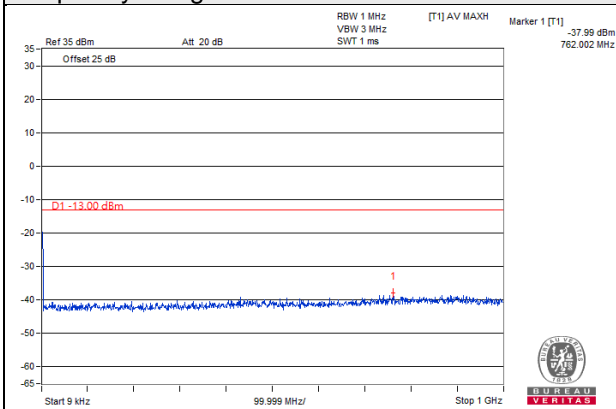

Frequency Range : 1GHz ~10GHz

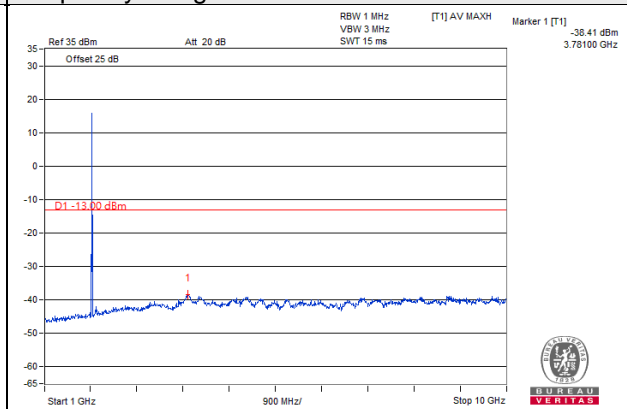

Frequency Range : 10GHz~20GHz

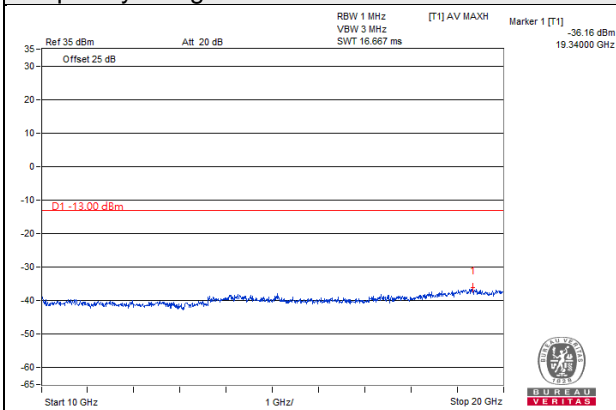

Note: The signal at 9 kHz is IF signal from spectrum analyzer.

4.8 Radiated Emission Measurement

4.8.1 Limits of Radiated Emission Measurement

The power of any emission outside of the authorized operating frequency ranges must be attenuated below the transmitting power (P) by a factor of at least $43 + 10 \log(P)$ dB. The emission limit equal to -13dBm .

4.8.2 Test Procedure

- a. The power was measured with Spectrum Analyzer.
- b. Substitution method is used for EIRP measurement. In the semi-anechoic chamber, EUT placed on the 0.8m/1.5m height of Turn Table, rotated the table around 360 degrees to search the maximum radiation power and receiver antenna shall be rotated vertical and horizontal polarization and moved height from 1m to 4m to find the maximum polar radiated power. The "Read Value" is the spectrum reading the maximum power value.
- c. The substitution antenna is substituted for EUT at the same position and signals generator export the CW signal to the substitution antenna via a TX cable. Rotated the Turn Table and moved receiving antenna to find the maximum radiation power. Adjust output power level of S.G to get a Value of spectrum reading equal to "Read Value " of step b. Record the power level of S.G
- d. $\text{EIRP} = \text{Output power level of S.G} - \text{TX cable loss} + \text{Antenna gain of substitution antenna}$.
- e. ERP power can be calculated form EIRP power by subtracting the gain of dipole, $\text{ERP power} = \text{EIPR power} - 2.15\text{dBi}$.

NOTE: The resolution bandwidth and video bandwidth of test receiver/spectrum analyzer is 1MHz/3MHz.

4.8.3 Deviation from Test Standard

No deviation.

**4.8.4 Test Setup
For Below 1GHz**

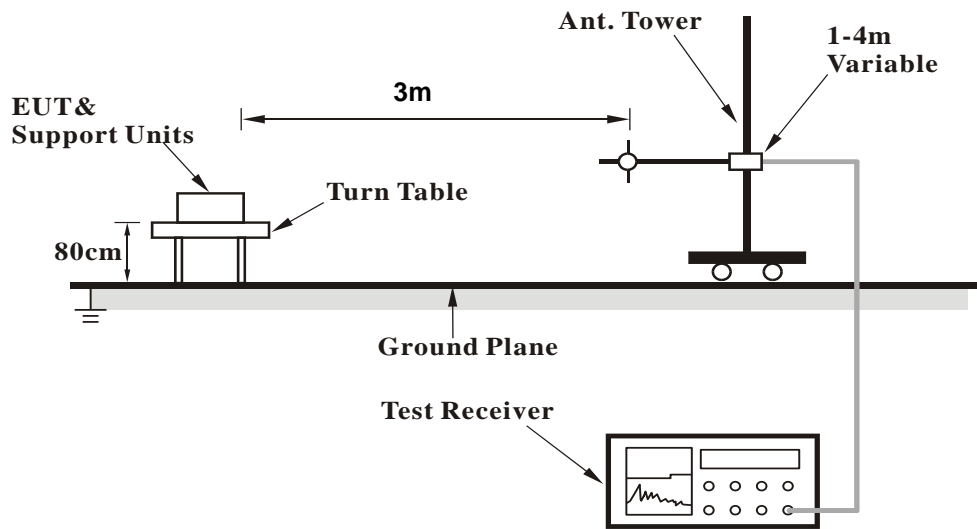

For Above 1GHz:

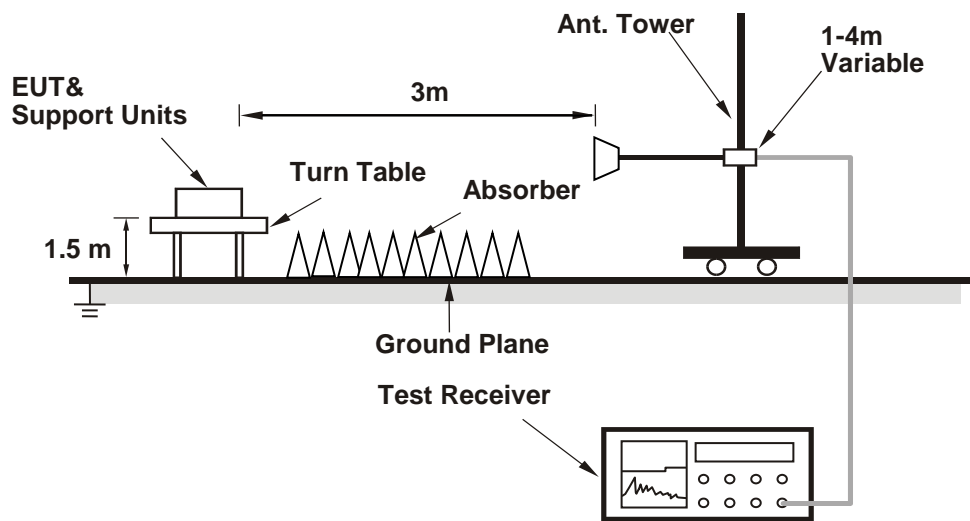

For the actual test configuration, please refer to the attached file (Test Setup Photo).

4.8.5 Test Results

BELOW 1GHz

LTE Band 2: 1.4 MHz

Mode	TX channel 18607	Frequency Range	Below 1000 MHz
------	------------------	-----------------	----------------

Antenna Polarity & Test Distance: Horizontal at 3 M							
No.	Freq. (MHz)	Reading (dBm)	S.G Power Value (dBm)	Correction Factor (dB)	Emission Value (dBm)	Limit (dBm)	Margin (dB)
1	90.43	31.42	-60.90	-1.18	-62.08	-13	-49.08
2	137.21	32.07	-61.26	-1.29	-62.56	-13	-49.56
3	294.44	32.93	-62.68	3.75	-58.94	-13	-45.94
4	340.71	27.46	-70.02	3.62	-66.40	-13	-53.40
5	517.75	31.21	-64.10	2.76	-61.34	-13	-48.34
6	732.95	25.53	-70.83	1.09	-69.74	-13	-56.74
Antenna Polarity & Test Distance: Vertical at 3 M							
No.	Freq. (MHz)	Reading (dBm)	S.G Power Value (dBm)	Correction Factor (dB)	Emission Value (dBm)	Limit (dBm)	Margin (dB)
1	67.8	30.17	-56.63	-5.32	-61.94	-13	-48.94
2	94.84	32.26	-59.30	-0.92	-60.22	-13	-47.22
3	125.87	32.94	-57.93	-1.22	-59.15	-13	-46.15
4	234.73	28.99	-66.38	3.88	-62.50	-13	-49.50
5	536.08	32.17	-62.92	2.62	-60.30	-13	-47.30
6	631.1	35.61	-59.24	1.76	-57.48	-13	-44.48

Remarks:

1. Emission Value (dBm) = S.G Value (dBm) + Correction Factor (dB).
2. Correction Factor (dB) = Substitution Antenna Gain (dB) + Cable Loss (dB).

Mode	TX channel 18900	Frequency Range	Below 1000 MHz
------	------------------	-----------------	----------------

Antenna Polarity & Test Distance: Horizontal at 3 M

No.	Freq. (MHz)	Reading (dBm)	S.G Power Value (dBm)	Correction Factor (dB)	Emission Value (dBm)	Limit (dBm)	Margin (dB)
1	90.02	30.83	-61.56	-1.20	-62.76	-13	-49.76
2	137.07	31.51	-61.79	-1.29	-63.09	-13	-50.09
3	293.53	31.77	-63.82	3.76	-60.06	-13	-47.06
4	341.29	26.21	-71.29	3.62	-67.68	-13	-54.68
5	517.43	31.15	-64.16	2.76	-61.40	-13	-48.40
6	733.6	24.54	-71.82	1.08	-70.74	-13	-57.74

Antenna Polarity & Test Distance: Vertical at 3 M

No.	Freq. (MHz)	Reading (dBm)	S.G Power Value (dBm)	Correction Factor (dB)	Emission Value (dBm)	Limit (dBm)	Margin (dB)
1	67.5	29.87	-56.75	-5.40	-62.15	-13	-49.15
2	95.03	31.25	-60.28	-0.91	-61.19	-13	-48.19
3	125.36	31.88	-58.88	-1.22	-60.10	-13	-47.10
4	234.73	27.85	-67.52	3.88	-63.64	-13	-50.64
5	536.52	31.93	-63.16	2.62	-60.54	-13	-47.54
6	631.43	35.28	-59.58	1.76	-57.81	-13	-44.81

Remarks:

1. Emission Value (dBm) = S.G Value (dBm) + Correction Factor (dB).
2. Correction Factor (dB) = Substitution Antenna Gain (dB) + Cable Loss (dB).

Mode	TX channel 19193	Frequency Range	Below 1000 MHz
------	------------------	-----------------	----------------

Antenna Polarity & Test Distance: Horizontal at 3 M

No.	Freq. (MHz)	Reading (dBm)	S.G Power Value (dBm)	Correction Factor (dB)	Emission Value (dBm)	Limit (dBm)	Margin (dB)
1	90.42	30.25	-62.07	-1.18	-63.25	-13	-50.25
2	137.48	31.23	-62.16	-1.29	-63.46	-13	-50.46
3	293.68	31.67	-63.92	3.75	-60.17	-13	-47.17
4	340.49	27.06	-70.41	3.62	-66.79	-13	-53.79
5	518.03	30.11	-65.20	2.76	-62.44	-13	-49.44
6	733.37	24.32	-72.04	1.08	-70.96	-13	-57.96

Antenna Polarity & Test Distance: Vertical at 3 M

No.	Freq. (MHz)	Reading (dBm)	S.G Power Value (dBm)	Correction Factor (dB)	Emission Value (dBm)	Limit (dBm)	Margin (dB)
1	67.07	29.19	-57.17	-5.53	-62.70	-13	-49.70
2	95.52	31.30	-60.14	-0.89	-61.03	-13	-48.03
3	126.07	32.33	-58.59	-1.22	-59.81	-13	-46.81
4	233.9	27.51	-67.87	3.90	-63.97	-13	-50.97
5	536.44	31.04	-64.05	2.62	-61.43	-13	-48.43
6	631.4	34.33	-60.53	1.76	-58.76	-13	-45.76

Remarks:

1. Emission Value (dBm) = S.G Value (dBm) + Correction Factor (dB).
2. Correction Factor (dB) = Substitution Antenna Gain (dB) + Cable Loss (dB).

LTE Band 2: 3 MHz

Mode	TX channel 18615	Frequency Range	Below 1000 MHz
------	------------------	-----------------	----------------

Antenna Polarity & Test Distance: Horizontal at 3 M

No.	Freq. (MHz)	Reading (dBm)	S.G Power Value (dBm)	Correction Factor (dB)	Emission Value (dBm)	Limit (dBm)	Margin (dB)
1	89.73	30.78	-61.66	-1.22	-62.88	-13	-49.88
2	136.39	31.02	-62.14	-1.29	-63.42	-13	-50.42
3	293.67	31.67	-63.92	3.75	-60.17	-13	-47.17
4	340.9	27.18	-70.31	3.62	-66.69	-13	-53.69
5	517.57	29.91	-65.40	2.76	-62.64	-13	-49.64
6	733.54	24.68	-71.68	1.08	-70.60	-13	-57.60

Antenna Polarity & Test Distance: Vertical at 3 M

No.	Freq. (MHz)	Reading (dBm)	S.G Power Value (dBm)	Correction Factor (dB)	Emission Value (dBm)	Limit (dBm)	Margin (dB)
1	68.24	29.32	-57.74	-5.19	-62.93	-13	-49.93
2	95.7	31.75	-59.66	-0.87	-60.54	-13	-47.54
3	125.08	32.02	-58.68	-1.22	-59.90	-13	-46.90
4	234.48	28.28	-67.09	3.89	-63.21	-13	-50.21
5	536.85	30.94	-64.14	2.62	-61.53	-13	-48.53
6	631.99	35.54	-59.32	1.76	-57.56	-13	-44.56

Remarks:

1. Emission Value (dBm) = S.G Value (dBm) + Correction Factor (dB).
2. Correction Factor (dB) = Substitution Antenna Gain (dB) + Cable Loss (dB).

Mode	TX channel 18900	Frequency Range	Below 1000 MHz
------	------------------	-----------------	----------------

Antenna Polarity & Test Distance: Horizontal at 3 M

No.	Freq. (MHz)	Reading (dBm)	S.G Power Value (dBm)	Correction Factor (dB)	Emission Value (dBm)	Limit (dBm)	Margin (dB)
1	91.25	30.20	-61.98	-1.13	-63.11	-13	-50.11
2	137.21	30.61	-62.72	-1.29	-64.02	-13	-51.02
3	294.28	32.38	-63.23	3.75	-59.48	-13	-46.48
4	339.83	26.48	-70.96	3.62	-67.34	-13	-54.34
5	517.51	30.54	-64.77	2.76	-62.01	-13	-49.01
6	733.06	24.86	-71.50	1.09	-70.42	-13	-57.42

Antenna Polarity & Test Distance: Vertical at 3 M

No.	Freq. (MHz)	Reading (dBm)	S.G Power Value (dBm)	Correction Factor (dB)	Emission Value (dBm)	Limit (dBm)	Margin (dB)
1	66.98	28.77	-57.54	-5.55	-63.09	-13	-50.09
2	94.23	31.50	-60.16	-0.96	-61.12	-13	-48.12
3	125.13	32.70	-58.01	-1.22	-59.23	-13	-46.23
4	235.28	27.78	-67.59	3.88	-63.71	-13	-50.71
5	536.2	32.09	-63.00	2.62	-60.38	-13	-47.38
6	630.89	34.31	-60.54	1.76	-58.78	-13	-45.78

Remarks:

1. Emission Value (dBm) = S.G Value (dBm) + Correction Factor (dB).
2. Correction Factor (dB) = Substitution Antenna Gain (dB) + Cable Loss (dB).

Mode	TX channel 19185	Frequency Range	Below 1000 MHz
------	------------------	-----------------	----------------

Antenna Polarity & Test Distance: Horizontal at 3 M

No.	Freq. (MHz)	Reading (dBm)	S.G Power Value (dBm)	Correction Factor (dB)	Emission Value (dBm)	Limit (dBm)	Margin (dB)
1	89.84	30.23	-62.19	-1.21	-63.40	-13	-50.40
2	136.72	30.81	-62.42	-1.29	-63.71	-13	-50.71
3	294.87	32.58	-63.05	3.75	-59.30	-13	-46.30
4	340.94	26.97	-70.52	3.62	-66.90	-13	-53.90
5	518.24	29.87	-65.43	2.75	-62.68	-13	-49.68
6	732.24	25.35	-71.01	1.10	-69.91	-13	-56.91

Antenna Polarity & Test Distance: Vertical at 3 M

No.	Freq. (MHz)	Reading (dBm)	S.G Power Value (dBm)	Correction Factor (dB)	Emission Value (dBm)	Limit (dBm)	Margin (dB)
1	67.83	28.88	-57.94	-5.31	-63.24	-13	-50.24
2	94.89	31.64	-59.91	-0.92	-60.83	-13	-47.83
3	125.36	32.78	-57.98	-1.22	-59.20	-13	-46.20
4	235.71	28.36	-67.01	3.87	-63.14	-13	-50.14
5	535.54	30.84	-64.26	2.63	-61.63	-13	-48.63
6	631.48	34.54	-60.32	1.76	-58.55	-13	-45.55

Remarks:

1. Emission Value (dBm) = S.G Value (dBm) + Correction Factor (dB).
2. Correction Factor (dB) = Substitution Antenna Gain (dB) + Cable Loss (dB).

LTE Band 2: 5 MHz

Mode	TX channel 18625	Frequency Range	Below 1000 MHz
------	------------------	-----------------	----------------

Antenna Polarity & Test Distance: Horizontal at 3 M

No.	Freq. (MHz)	Reading (dBm)	S.G Power Value (dBm)	Correction Factor (dB)	Emission Value (dBm)	Limit (dBm)	Margin (dB)
1	91.2	30.61	-61.58	-1.13	-62.71	-13	-49.71
2	136.61	30.73	-62.47	-1.29	-63.76	-13	-50.76
3	294.94	31.86	-63.77	3.75	-60.02	-13	-47.02
4	341.67	27.36	-70.16	3.61	-66.54	-13	-53.54
5	517.09	30.09	-65.23	2.76	-62.46	-13	-49.46
6	732.25	25.20	-71.16	1.10	-70.06	-13	-57.06

Antenna Polarity & Test Distance: Vertical at 3 M

No.	Freq. (MHz)	Reading (dBm)	S.G Power Value (dBm)	Correction Factor (dB)	Emission Value (dBm)	Limit (dBm)	Margin (dB)
1	67	29.86	-56.46	-5.55	-62.01	-13	-49.01
2	94.06	30.96	-60.73	-0.97	-61.70	-13	-48.70
3	126.83	32.22	-58.86	-1.23	-60.09	-13	-47.09
4	234.51	27.77	-67.60	3.89	-63.72	-13	-50.72
5	535.38	31.52	-63.58	2.63	-60.95	-13	-47.95
6	631.45	35.54	-59.32	1.76	-57.55	-13	-44.55

Remarks:

1. Emission Value (dBm) = S.G Value (dBm) + Correction Factor (dB).
2. Correction Factor (dB) = Substitution Antenna Gain (dB) + Cable Loss (dB).

Mode	TX channel 18900	Frequency Range	Below 1000 MHz
------	------------------	-----------------	----------------

Antenna Polarity & Test Distance: Horizontal at 3 M

No.	Freq. (MHz)	Reading (dBm)	S.G Power Value (dBm)	Correction Factor (dB)	Emission Value (dBm)	Limit (dBm)	Margin (dB)
1	90.85	30.94	-61.31	-1.15	-62.46	-13	-49.46
2	137.52	30.64	-62.76	-1.29	-64.06	-13	-51.06
3	295.38	31.52	-64.12	3.74	-60.38	-13	-47.38
4	341.14	26.88	-70.62	3.62	-67.00	-13	-54.00
5	518.07	30.59	-64.72	2.76	-61.96	-13	-48.96
6	733.79	25.32	-71.04	1.08	-69.97	-13	-56.97

Antenna Polarity & Test Distance: Vertical at 3 M

No.	Freq. (MHz)	Reading (dBm)	S.G Power Value (dBm)	Correction Factor (dB)	Emission Value (dBm)	Limit (dBm)	Margin (dB)
1	66.84	30.15	-56.07	-5.59	-61.67	-13	-48.67
2	95.18	32.25	-59.25	-0.90	-60.16	-13	-47.16
3	124.89	32.87	-57.79	-1.21	-59.00	-13	-46.00
4	234.18	28.75	-66.63	3.89	-62.73	-13	-49.73
5	535.19	31.30	-63.80	2.63	-61.18	-13	-48.18
6	631.09	35.49	-59.36	1.76	-57.60	-13	-44.60

Remarks:

1. Emission Value (dBm) = S.G Value (dBm) + Correction Factor (dB).
2. Correction Factor (dB) = Substitution Antenna Gain (dB) + Cable Loss (dB).

Mode	TX channel 19175	Frequency Range	Below 1000 MHz
------	------------------	-----------------	----------------

Antenna Polarity & Test Distance: Horizontal at 3 M

No.	Freq. (MHz)	Reading (dBm)	S.G Power Value (dBm)	Correction Factor (dB)	Emission Value (dBm)	Limit (dBm)	Margin (dB)
1	90.82	30.09	-62.16	-1.16	-63.32	-13	-50.32
2	137.28	30.59	-62.76	-1.29	-64.05	-13	-51.05
3	293.88	32.88	-62.72	3.75	-58.97	-13	-45.97
4	340.21	26.44	-71.02	3.62	-67.40	-13	-54.40
5	517.43	29.94	-65.37	2.76	-62.61	-13	-49.61
6	733.09	24.19	-72.17	1.09	-71.09	-13	-58.09

Antenna Polarity & Test Distance: Vertical at 3 M

No.	Freq. (MHz)	Reading (dBm)	S.G Power Value (dBm)	Correction Factor (dB)	Emission Value (dBm)	Limit (dBm)	Margin (dB)
1	67.61	29.80	-56.88	-5.37	-62.26	-13	-49.26
2	94.61	31.59	-60.01	-0.94	-60.95	-13	-47.95
3	126.07	32.83	-58.09	-1.22	-59.31	-13	-46.31
4	235.5	28.74	-66.63	3.87	-62.76	-13	-49.76
5	536.19	31.58	-63.51	2.62	-60.89	-13	-47.89
6	631.41	34.84	-60.02	1.76	-58.25	-13	-45.25

Remarks:

1. Emission Value (dBm) = S.G Value (dBm) + Correction Factor (dB).
2. Correction Factor (dB) = Substitution Antenna Gain (dB) + Cable Loss (dB).

LTE Band 2: 10 MHz

Mode	TX channel 18650	Frequency Range	Below 1000 MHz
------	------------------	-----------------	----------------

Antenna Polarity & Test Distance: Horizontal at 3 M

No.	Freq. (MHz)	Reading (dBm)	S.G Power Value (dBm)	Correction Factor (dB)	Emission Value (dBm)	Limit (dBm)	Margin (dB)
1	90.57	30.70	-61.59	-1.17	-62.76	-13	-49.76
2	137.22	31.50	-61.84	-1.29	-63.13	-13	-50.13
3	293.96	32.33	-63.27	3.75	-59.52	-13	-46.52
4	339.79	26.53	-70.91	3.62	-67.29	-13	-54.29
5	517.26	30.98	-64.34	2.76	-61.57	-13	-48.57
6	732.76	24.86	-71.50	1.09	-70.41	-13	-57.41

Antenna Polarity & Test Distance: Vertical at 3 M

No.	Freq. (MHz)	Reading (dBm)	S.G Power Value (dBm)	Correction Factor (dB)	Emission Value (dBm)	Limit (dBm)	Margin (dB)
1	67.56	30.12	-56.53	-5.39	-61.92	-13	-48.92
2	95.83	31.18	-60.21	-0.87	-61.08	-13	-48.08
3	126.11	32.22	-58.70	-1.22	-59.93	-13	-46.93
4	235.57	28.03	-67.34	3.87	-63.47	-13	-50.47
5	535.97	30.85	-64.24	2.62	-61.62	-13	-48.62
6	631.87	35.37	-59.49	1.76	-57.73	-13	-44.73

Remarks:

1. Emission Value (dBm) = S.G Value (dBm) + Correction Factor (dB).
2. Correction Factor (dB) = Substitution Antenna Gain (dB) + Cable Loss (dB).

Mode	TX channel 18900	Frequency Range	Below 1000 MHz
------	------------------	-----------------	----------------

Antenna Polarity & Test Distance: Horizontal at 3 M

No.	Freq. (MHz)	Reading (dBm)	S.G Power Value (dBm)	Correction Factor (dB)	Emission Value (dBm)	Limit (dBm)	Margin (dB)
1	89.8	30.05	-62.38	-1.21	-63.59	-13	-50.59
2	136.7	30.90	-62.32	-1.29	-63.61	-13	-50.61
3	294.31	32.40	-63.21	3.75	-59.46	-13	-46.46
4	340.85	26.72	-70.76	3.62	-67.15	-13	-54.15
5	516.92	30.64	-64.68	2.76	-61.92	-13	-48.92
6	733.65	24.93	-71.43	1.08	-70.36	-13	-57.36

Antenna Polarity & Test Distance: Vertical at 3 M

No.	Freq. (MHz)	Reading (dBm)	S.G Power Value (dBm)	Correction Factor (dB)	Emission Value (dBm)	Limit (dBm)	Margin (dB)
1	67.69	29.11	-57.62	-5.35	-62.97	-13	-49.97
2	95.77	31.89	-59.51	-0.87	-60.38	-13	-47.38
3	125.24	31.68	-59.05	-1.22	-60.27	-13	-47.27
4	234.31	28.64	-66.73	3.89	-62.84	-13	-49.84
5	536.52	32.02	-63.07	2.62	-60.45	-13	-47.45
6	630.17	34.58	-60.27	1.76	-58.50	-13	-45.50

Remarks:

1. Emission Value (dBm) = S.G Value (dBm) + Correction Factor (dB).
2. Correction Factor (dB) = Substitution Antenna Gain (dB) + Cable Loss (dB).

Mode	TX channel 19150	Frequency Range	Below 1000 MHz
------	------------------	-----------------	----------------

Antenna Polarity & Test Distance: Horizontal at 3 M

No.	Freq. (MHz)	Reading (dBm)	S.G Power Value (dBm)	Correction Factor (dB)	Emission Value (dBm)	Limit (dBm)	Margin (dB)
1	89.93	30.61	-61.79	-1.21	-63.00	-13	-50.00
2	137.05	30.79	-62.51	-1.29	-63.80	-13	-50.80
3	294.65	31.58	-64.04	3.75	-60.29	-13	-47.29
4	341.14	26.44	-71.06	3.62	-67.44	-13	-54.44
5	517.99	30.66	-64.65	2.76	-61.89	-13	-48.89
6	732.04	24.17	-72.19	1.10	-71.09	-13	-58.09

Antenna Polarity & Test Distance: Vertical at 3 M

No.	Freq. (MHz)	Reading (dBm)	S.G Power Value (dBm)	Correction Factor (dB)	Emission Value (dBm)	Limit (dBm)	Margin (dB)
1	68.16	29.67	-57.34	-5.21	-62.56	-13	-49.56
2	94.1	31.82	-59.87	-0.97	-60.83	-13	-47.83
3	125.83	31.49	-59.37	-1.22	-60.59	-13	-47.59
4	234.64	28.81	-66.56	3.89	-62.68	-13	-49.68
5	535.69	31.64	-63.46	2.62	-60.83	-13	-47.83
6	631.67	35.60	-59.26	1.76	-57.50	-13	-44.50

Remarks:

1. Emission Value (dBm) = S.G Value (dBm) + Correction Factor (dB).
2. Correction Factor (dB) = Substitution Antenna Gain (dB) + Cable Loss (dB).

LTE Band 2: 15 MHz

Mode	TX channel 18675	Frequency Range	Below 1000 MHz
------	------------------	-----------------	----------------

Antenna Polarity & Test Distance: Horizontal at 3 M

No.	Freq. (MHz)	Reading (dBm)	S.G Power Value (dBm)	Correction Factor (dB)	Emission Value (dBm)	Limit (dBm)	Margin (dB)
1	91.35	30.80	-61.36	-1.13	-62.49	-13	-49.49
2	137.06	31.61	-61.69	-1.29	-62.98	-13	-49.98
3	295.43	31.65	-63.99	3.74	-60.25	-13	-47.25
4	341.61	26.66	-70.86	3.61	-67.24	-13	-54.24
5	518.62	30.83	-64.47	2.75	-61.72	-13	-48.72
6	733.1	24.30	-72.06	1.09	-70.98	-13	-57.98

Antenna Polarity & Test Distance: Vertical at 3 M

No.	Freq. (MHz)	Reading (dBm)	S.G Power Value (dBm)	Correction Factor (dB)	Emission Value (dBm)	Limit (dBm)	Margin (dB)
1	67.36	30.16	-56.37	-5.44	-61.82	-13	-48.82
2	95.84	31.93	-59.46	-0.87	-60.32	-13	-47.32
3	126.12	32.10	-58.83	-1.22	-60.05	-13	-47.05
4	233.99	28.37	-67.01	3.89	-63.11	-13	-50.11
5	536.25	32.01	-63.08	2.62	-60.46	-13	-47.46
6	630.45	34.18	-60.67	1.76	-58.91	-13	-45.91

Remarks:

1. Emission Value (dBm) = S.G Value (dBm) + Correction Factor (dB).
2. Correction Factor (dB) = Substitution Antenna Gain (dB) + Cable Loss (dB).

Mode	TX channel 18900	Frequency Range	Below 1000 MHz
------	------------------	-----------------	----------------

Antenna Polarity & Test Distance: Horizontal at 3 M

No.	Freq. (MHz)	Reading (dBm)	S.G Power Value (dBm)	Correction Factor (dB)	Emission Value (dBm)	Limit (dBm)	Margin (dB)
1	91	31.24	-60.98	-1.15	-62.13	-13	-49.13
2	136.68	30.95	-62.27	-1.29	-63.56	-13	-50.56
3	295.44	32.39	-63.26	3.74	-59.51	-13	-46.51
4	339.87	27.14	-70.30	3.62	-66.68	-13	-53.68
5	516.98	31.10	-64.22	2.76	-61.46	-13	-48.46
6	733.69	25.08	-71.28	1.08	-70.21	-13	-57.21

Antenna Polarity & Test Distance: Vertical at 3 M

No.	Freq. (MHz)	Reading (dBm)	S.G Power Value (dBm)	Correction Factor (dB)	Emission Value (dBm)	Limit (dBm)	Margin (dB)
1	68.59	29.72	-57.55	-5.09	-62.64	-13	-49.64
2	94.8	31.01	-60.56	-0.93	-61.48	-13	-48.48
3	125.98	31.73	-59.17	-1.22	-60.39	-13	-47.39
4	233.79	27.96	-67.42	3.90	-63.52	-13	-50.52
5	535.96	31.53	-63.56	2.62	-60.94	-13	-47.94
6	631.68	35.28	-59.58	1.76	-57.82	-13	-44.82

Remarks:

1. Emission Value (dBm) = S.G Value (dBm) + Correction Factor (dB).
2. Correction Factor (dB) = Substitution Antenna Gain (dB) + Cable Loss (dB).

Mode	TX channel 19125	Frequency Range	Below 1000 MHz
------	------------------	-----------------	----------------

Antenna Polarity & Test Distance: Horizontal at 3 M

No.	Freq. (MHz)	Reading (dBm)	S.G Power Value (dBm)	Correction Factor (dB)	Emission Value (dBm)	Limit (dBm)	Margin (dB)
1	91.17	31.11	-61.08	-1.14	-62.22	-13	-49.22
2	136.36	31.46	-61.69	-1.29	-62.98	-13	-49.98
3	293.51	31.63	-63.96	3.76	-60.20	-13	-47.20
4	341.15	26.66	-70.84	3.62	-67.22	-13	-54.22
5	517.4	30.77	-64.54	2.76	-61.78	-13	-48.78
6	733.78	25.01	-71.35	1.08	-70.28	-13	-57.28

Antenna Polarity & Test Distance: Vertical at 3 M

No.	Freq. (MHz)	Reading (dBm)	S.G Power Value (dBm)	Correction Factor (dB)	Emission Value (dBm)	Limit (dBm)	Margin (dB)
1	68.49	29.16	-58.05	-5.12	-63.17	-13	-50.17
2	94.57	32.09	-59.52	-0.94	-60.46	-13	-47.46
3	124.95	31.87	-58.80	-1.21	-60.02	-13	-47.02
4	233.79	28.57	-66.81	3.90	-62.91	-13	-49.91
5	535.41	31.12	-63.98	2.63	-61.35	-13	-48.35
6	630.31	34.49	-60.36	1.76	-58.59	-13	-45.59

Remarks:

1. Emission Value (dBm) = S.G Value (dBm) + Correction Factor (dB).
2. Correction Factor (dB) = Substitution Antenna Gain (dB) + Cable Loss (dB).

LTE Band 2: 20 MHz

Mode	TX channel 18700	Frequency Range	Below 1000 MHz
------	------------------	-----------------	----------------

Antenna Polarity & Test Distance: Horizontal at 3 M

No.	Freq. (MHz)	Reading (dBm)	S.G Power Value (dBm)	Correction Factor (dB)	Emission Value (dBm)	Limit (dBm)	Margin (dB)
1	89.63	31.22	-61.24	-1.22	-62.46	-13	-49.46
2	137.97	32.04	-61.46	-1.30	-62.76	-13	-49.76
3	293.73	31.74	-63.85	3.75	-60.10	-13	-47.10
4	339.81	27.11	-70.33	3.62	-66.71	-13	-53.71
5	518.59	30.05	-65.25	2.75	-62.50	-13	-49.50
6	733.34	24.49	-71.87	1.08	-70.79	-13	-57.79

Antenna Polarity & Test Distance: Vertical at 3 M

No.	Freq. (MHz)	Reading (dBm)	S.G Power Value (dBm)	Correction Factor (dB)	Emission Value (dBm)	Limit (dBm)	Margin (dB)
1	67.86	29.65	-57.18	-5.30	-62.48	-13	-49.48
2	95.08	31.98	-59.54	-0.91	-60.45	-13	-47.45
3	125.79	31.93	-58.92	-1.22	-60.14	-13	-47.14
4	234.45	28.34	-67.03	3.89	-63.15	-13	-50.15
5	537.04	31.03	-64.05	2.61	-61.44	-13	-48.44
6	631.61	34.68	-60.18	1.76	-58.42	-13	-45.42

Remarks:

1. Emission Value (dBm) = S.G Value (dBm) + Correction Factor (dB).
2. Correction Factor (dB) = Substitution Antenna Gain (dB) + Cable Loss (dB).

Mode	TX channel 18900	Frequency Range	Below 1000 MHz
------	------------------	-----------------	----------------

Antenna Polarity & Test Distance: Horizontal at 3 M

No.	Freq. (MHz)	Reading (dBm)	S.G Power Value (dBm)	Correction Factor (dB)	Emission Value (dBm)	Limit (dBm)	Margin (dB)
1	91.38	30.98	-61.17	-1.12	-62.30	-13	-49.30
2	136.94	31.58	-61.70	-1.29	-62.99	-13	-49.99
3	294	32.46	-63.14	3.75	-59.39	-13	-46.39
4	341.49	27.28	-70.23	3.62	-66.62	-13	-53.62
5	516.81	30.41	-64.91	2.76	-62.15	-13	-49.15
6	733.39	25.20	-71.16	1.08	-70.08	-13	-57.08

Antenna Polarity & Test Distance: Vertical at 3 M

No.	Freq. (MHz)	Reading (dBm)	S.G Power Value (dBm)	Correction Factor (dB)	Emission Value (dBm)	Limit (dBm)	Margin (dB)
1	67.3	30.03	-56.47	-5.46	-61.93	-13	-48.93
2	95.03	31.97	-59.56	-0.91	-60.47	-13	-47.47
3	125.65	32.22	-58.60	-1.22	-59.82	-13	-46.82
4	233.98	28.47	-66.91	3.89	-63.01	-13	-50.01
5	536.81	32.14	-62.94	2.62	-60.33	-13	-47.33
6	631.05	35.17	-59.68	1.76	-57.92	-13	-44.92

Remarks:

1. Emission Value (dBm) = S.G Value (dBm) + Correction Factor (dB).
2. Correction Factor (dB) = Substitution Antenna Gain (dB) + Cable Loss (dB).

Mode	TX channel 19100	Frequency Range	Below 1000 MHz
------	------------------	-----------------	----------------

Antenna Polarity & Test Distance: Horizontal at 3 M

No.	Freq. (MHz)	Reading (dBm)	S.G Power Value (dBm)	Correction Factor (dB)	Emission Value (dBm)	Limit (dBm)	Margin (dB)
1	90.03	31.41	-60.98	-1.20	-62.18	-13	-49.18
2	136.38	31.96	-61.19	-1.29	-62.48	-13	-49.48
3	293.92	31.71	-63.89	3.75	-60.14	-13	-47.14
4	341.55	27.12	-70.39	3.61	-66.78	-13	-53.78
5	517.01	30.27	-65.05	2.76	-62.29	-13	-49.29
6	733.82	25.13	-71.23	1.07	-70.16	-13	-57.16

Antenna Polarity & Test Distance: Vertical at 3 M

No.	Freq. (MHz)	Reading (dBm)	S.G Power Value (dBm)	Correction Factor (dB)	Emission Value (dBm)	Limit (dBm)	Margin (dB)
1	66.97	29.59	-56.71	-5.56	-62.27	-13	-49.27
2	95.23	31.58	-59.91	-0.90	-60.81	-13	-47.81
3	126.31	32.81	-58.16	-1.22	-59.38	-13	-46.38
4	234.71	28.08	-67.29	3.88	-63.41	-13	-50.41
5	535.78	31.98	-63.12	2.62	-60.49	-13	-47.49
6	631.82	34.21	-60.65	1.76	-58.89	-13	-45.89

Remarks:

1. Emission Value (dBm) = S.G Value (dBm) + Correction Factor (dB).
2. Correction Factor (dB) = Substitution Antenna Gain (dB) + Cable Loss (dB).

ABOVE 1GHz

LTE Band 2: 1.4 MHz

Mode	TX channel 18607	Frequency Range	Above 1000 MHz
------	------------------	-----------------	----------------

Antenna Polarity & Test Distance: Horizontal at 3 M

No.	Freq. (MHz)	Reading (dBm)	S.G Power Value (dBm)	Correction Factor (dB)	Emission Value (dBm)	Limit (dBm)	Margin (dB)
1	3701.4	58.1	-45.84	7.72	-38.12	-13	-25.12
2	5552.1	52.3	-52.59	7.08	-45.51	-13	-32.51
3	7402.8	43.64	-58.86	4.63	-54.23	-13	-41.23

Antenna Polarity & Test Distance: Vertical at 3 M

No.	Freq. (MHz)	Reading (dBm)	S.G Power Value (dBm)	Correction Factor (dB)	Emission Value (dBm)	Limit (dBm)	Margin (dB)
1	3701.4	49.67	-54.27	7.72	-46.55	-13	-33.55
2	5552.1	53.00	-51.89	7.08	-44.81	-13	-31.81
3	7402.8	40.66	-61.84	4.63	-57.21	-13	-44.21

Remarks:

1. Emission Value (dBm) = S.G Value (dBm) + Correction Factor (dB).
2. Correction Factor (dB) = Substitution Antenna Gain (dB) + Cable Loss (dB).

Mode	TX channel 18900	Frequency Range	Above 1000 MHz
------	------------------	-----------------	----------------

Antenna Polarity & Test Distance: Horizontal at 3 M

No.	Freq. (MHz)	Reading (dBm)	S.G Power Value (dBm)	Correction Factor (dB)	Emission Value (dBm)	Limit (dBm)	Margin (dB)
1	3760	57.19	-46.96	7.68	-39.28	-13	-26.28
2	5640	51.53	-53.21	7.02	-46.19	-13	-33.19
3	7520	42.9	-59.72	4.53	-55.19	-13	-42.19

Antenna Polarity & Test Distance: Vertical at 3 M

No.	Freq. (MHz)	Reading (dBm)	S.G Power Value (dBm)	Correction Factor (dB)	Emission Value (dBm)	Limit (dBm)	Margin (dB)
1	3760	49.20	-54.95	7.68	-47.27	-13	-34.27
2	5640	53.56	-51.18	7.02	-44.16	-13	-31.16
3	7520	40.07	-62.55	4.53	-58.02	-13	-45.02

Remarks:

1. Emission Value (dBm) = S.G Value (dBm) + Correction Factor (dB).
2. Correction Factor (dB) = Substitution Antenna Gain (dB) + Cable Loss (dB).

Mode	TX channel 19193	Frequency Range	Above 1000 MHz
------	------------------	-----------------	----------------

Antenna Polarity & Test Distance: Horizontal at 3 M

No.	Freq. (MHz)	Reading (dBm)	S.G Power Value (dBm)	Correction Factor (dB)	Emission Value (dBm)	Limit (dBm)	Margin (dB)
1	3818.6	58.06	-46.31	7.64	-38.67	-13	-25.67
2	5727.9	52.91	-51.69	6.96	-44.73	-13	-31.73
3	7637.2	42.7	-59.92	4.43	-55.49	-13	-42.49

Antenna Polarity & Test Distance: Vertical at 3 M

No.	Freq. (MHz)	Reading (dBm)	S.G Power Value (dBm)	Correction Factor (dB)	Emission Value (dBm)	Limit (dBm)	Margin (dB)
1	3818.6	50.51	-53.86	7.64	-46.22	-13	-33.22
2	5727.9	52.45	-52.15	6.96	-45.19	-13	-32.19
3	7637.2	41.11	-61.51	4.43	-57.08	-13	-44.08

Remarks:

1. Emission Value (dBm) = S.G Value (dBm) + Correction Factor (dB).
2. Correction Factor (dB) = Substitution Antenna Gain (dB) + Cable Loss (dB).

LTE Band 2: 3 MHz

Mode	TX channel 18615	Frequency Range	Above 1000 MHz
------	------------------	-----------------	----------------

Antenna Polarity & Test Distance: Horizontal at 3 M

No.	Freq. (MHz)	Reading (dBm)	S.G Power Value (dBm)	Correction Factor (dB)	Emission Value (dBm)	Limit (dBm)	Margin (dB)
1	3703	58.99	-44.95	7.72	-37.24	-13	-24.24
2	5554.5	51.4	-53.49	7.08	-46.41	-13	-33.41
3	7406	42.9	-59.61	4.63	-54.98	-13	-41.98

Antenna Polarity & Test Distance: Vertical at 3 M

No.	Freq. (MHz)	Reading (dBm)	S.G Power Value (dBm)	Correction Factor (dB)	Emission Value (dBm)	Limit (dBm)	Margin (dB)
1	3703	49.76	-54.18	7.72	-46.47	-13	-33.47
2	5554.5	53.63	-51.26	7.08	-44.18	-13	-31.18
3	7406	39.92	-62.59	4.63	-57.96	-13	-44.96

Remarks:

1. Emission Value (dBm) = S.G Value (dBm) + Correction Factor (dB).
2. Correction Factor (dB) = Substitution Antenna Gain (dB) + Cable Loss (dB).

Mode	TX channel 18900	Frequency Range	Above 1000 MHz
------	------------------	-----------------	----------------

Antenna Polarity & Test Distance: Horizontal at 3 M

No.	Freq. (MHz)	Reading (dBm)	S.G Power Value (dBm)	Correction Factor (dB)	Emission Value (dBm)	Limit (dBm)	Margin (dB)
1	3760	58.19	-45.96	7.68	-38.28	-13	-25.28
2	5640	51.74	-53.00	7.02	-45.98	-13	-32.98
3	7520	43.49	-59.13	4.53	-54.60	-13	-41.60

Antenna Polarity & Test Distance: Vertical at 3 M

No.	Freq. (MHz)	Reading (dBm)	S.G Power Value (dBm)	Correction Factor (dB)	Emission Value (dBm)	Limit (dBm)	Margin (dB)
1	3760	49.58	-54.57	7.68	-46.89	-13	-33.89
2	5640	53.20	-51.54	7.02	-44.52	-13	-31.52
3	7520	40.40	-62.22	4.53	-57.69	-13	-44.69

Remarks:

1. Emission Value (dBm) = S.G Value (dBm) + Correction Factor (dB).
2. Correction Factor (dB) = Substitution Antenna Gain (dB) + Cable Loss (dB).

Mode	TX channel 19185	Frequency Range	Above 1000 MHz
------	------------------	-----------------	----------------

Antenna Polarity & Test Distance: Horizontal at 3 M

No.	Freq. (MHz)	Reading (dBm)	S.G Power Value (dBm)	Correction Factor (dB)	Emission Value (dBm)	Limit (dBm)	Margin (dB)
1	3817	57.2	-47.16	7.64	-39.52	-13	-26.52
2	5725.5	51.31	-53.29	6.96	-46.33	-13	-33.33
3	7634	43.49	-59.13	4.43	-54.70	-13	-41.70

Antenna Polarity & Test Distance: Vertical at 3 M

No.	Freq. (MHz)	Reading (dBm)	S.G Power Value (dBm)	Correction Factor (dB)	Emission Value (dBm)	Limit (dBm)	Margin (dB)
1	3817	49.38	-54.98	7.64	-47.34	-13	-34.34
2	5725.5	53.98	-50.62	6.96	-43.66	-13	-30.66
3	7634	40.29	-62.33	4.43	-57.90	-13	-44.90

Remarks:

1. Emission Value (dBm) = S.G Value (dBm) + Correction Factor (dB).
2. Correction Factor (dB) = Substitution Antenna Gain (dB) + Cable Loss (dB).

LTE Band 2: 5 MHz

Mode	TX channel 18625	Frequency Range	Above 1000 MHz
------	------------------	-----------------	----------------

Antenna Polarity & Test Distance: Horizontal at 3 M

No.	Freq. (MHz)	Reading (dBm)	S.G Power Value (dBm)	Correction Factor (dB)	Emission Value (dBm)	Limit (dBm)	Margin (dB)
1	3705	57.28	-46.67	7.71	-38.96	-13	-25.96
2	5557.5	51.65	-53.23	7.08	-46.15	-13	-33.15
3	7410	44.01	-58.50	4.62	-53.88	-13	-40.88

Antenna Polarity & Test Distance: Vertical at 3 M

No.	Freq. (MHz)	Reading (dBm)	S.G Power Value (dBm)	Correction Factor (dB)	Emission Value (dBm)	Limit (dBm)	Margin (dB)
1	3705	49.60	-54.35	7.71	-46.64	-13	-33.64
2	5557.5	53.64	-51.24	7.08	-44.16	-13	-31.16
3	7410	41.60	-60.91	4.62	-56.29	-13	-43.29

Remarks:

1. Emission Value (dBm) = S.G Value (dBm) + Correction Factor (dB).
2. Correction Factor (dB) = Substitution Antenna Gain (dB) + Cable Loss (dB).

Mode	TX channel 18900	Frequency Range	Above 1000 MHz
------	------------------	-----------------	----------------

Antenna Polarity & Test Distance: Horizontal at 3 M

No.	Freq. (MHz)	Reading (dBm)	S.G Power Value (dBm)	Correction Factor (dB)	Emission Value (dBm)	Limit (dBm)	Margin (dB)
1	3760	58.07	-46.08	7.68	-38.40	-13	-25.40
2	5640	52.19	-52.55	7.02	-45.53	-13	-32.53
3	7520	44.23	-58.39	4.53	-53.86	-13	-40.86

Antenna Polarity & Test Distance: Vertical at 3 M

No.	Freq. (MHz)	Reading (dBm)	S.G Power Value (dBm)	Correction Factor (dB)	Emission Value (dBm)	Limit (dBm)	Margin (dB)
1	3760	50.59	-53.56	7.68	-45.88	-13	-32.88
2	5640	53.07	-51.67	7.02	-44.65	-13	-31.65
3	7520	39.99	-62.63	4.53	-58.10	-13	-45.10

Remarks:

1. Emission Value (dBm) = S.G Value (dBm) + Correction Factor (dB).
2. Correction Factor (dB) = Substitution Antenna Gain (dB) + Cable Loss (dB).

Mode	TX channel 19175	Frequency Range	Above 1000 MHz
------	------------------	-----------------	----------------

Antenna Polarity & Test Distance: Horizontal at 3 M

No.	Freq. (MHz)	Reading (dBm)	S.G Power Value (dBm)	Correction Factor (dB)	Emission Value (dBm)	Limit (dBm)	Margin (dB)
1	3815	58.15	-46.20	7.64	-38.56	-13	-25.56
2	5722.5	51.75	-52.86	6.96	-45.89	-13	-32.89
3	7630	43.87	-58.75	4.43	-54.32	-13	-41.32

Antenna Polarity & Test Distance: Vertical at 3 M

No.	Freq. (MHz)	Reading (dBm)	S.G Power Value (dBm)	Correction Factor (dB)	Emission Value (dBm)	Limit (dBm)	Margin (dB)
1	3815	49.72	-54.63	7.64	-46.99	-13	-33.99
2	5722.5	52.45	-52.16	6.96	-45.19	-13	-32.19
3	7630	41.53	-61.09	4.43	-56.66	-13	-43.66

Remarks:

1. Emission Value (dBm) = S.G Value (dBm) + Correction Factor (dB).
2. Correction Factor (dB) = Substitution Antenna Gain (dB) + Cable Loss (dB).

LTE Band 2: 10 MHz

Mode	TX channel 18650	Frequency Range	Above 1000 MHz
------	------------------	-----------------	----------------

Antenna Polarity & Test Distance: Horizontal at 3 M

No.	Freq. (MHz)	Reading (dBm)	S.G Power Value (dBm)	Correction Factor (dB)	Emission Value (dBm)	Limit (dBm)	Margin (dB)
1	3710	58.7	-45.27	7.71	-37.56	-13	-24.56
2	5565	52.35	-52.52	7.07	-45.45	-13	-32.45
3	7420	44.09	-58.43	4.61	-53.82	-13	-40.82

Antenna Polarity & Test Distance: Vertical at 3 M

No.	Freq. (MHz)	Reading (dBm)	S.G Power Value (dBm)	Correction Factor (dB)	Emission Value (dBm)	Limit (dBm)	Margin (dB)
1	3710	49.42	-54.55	7.71	-46.84	-13	-33.84
2	5565	53.40	-51.47	7.07	-44.40	-13	-31.40
3	7420	41.24	-61.28	4.61	-56.67	-13	-43.67

Remarks:

1. Emission Value (dBm) = S.G Value (dBm) + Correction Factor (dB).
2. Correction Factor (dB) = Substitution Antenna Gain (dB) + Cable Loss (dB).

Mode	TX channel 18900	Frequency Range	Above 1000 MHz
------	------------------	-----------------	----------------

Antenna Polarity & Test Distance: Horizontal at 3 M

No.	Freq. (MHz)	Reading (dBm)	S.G Power Value (dBm)	Correction Factor (dB)	Emission Value (dBm)	Limit (dBm)	Margin (dB)
1	3760	58.71	-45.44	7.68	-37.76	-13	-24.76
2	5640	52.98	-51.76	7.02	-44.74	-13	-31.74
3	7520	43.09	-59.53	4.53	-55.00	-13	-42.00

Antenna Polarity & Test Distance: Vertical at 3 M

No.	Freq. (MHz)	Reading (dBm)	S.G Power Value (dBm)	Correction Factor (dB)	Emission Value (dBm)	Limit (dBm)	Margin (dB)
1	3760	50.46	-53.69	7.68	-46.01	-13	-33.01
2	5640	53.57	-51.17	7.02	-44.15	-13	-31.15
3	7520	40.54	-62.08	4.53	-57.55	-13	-44.55

Remarks:

1. Emission Value (dBm) = S.G Value (dBm) + Correction Factor (dB).
2. Correction Factor (dB) = Substitution Antenna Gain (dB) + Cable Loss (dB).

Mode	TX channel 19150	Frequency Range	Above 1000 MHz
------	------------------	-----------------	----------------

Antenna Polarity & Test Distance: Horizontal at 3 M

No.	Freq. (MHz)	Reading (dBm)	S.G Power Value (dBm)	Correction Factor (dB)	Emission Value (dBm)	Limit (dBm)	Margin (dB)
1	3810	58.82	-45.51	7.65	-37.87	-13	-24.87
2	5715	51.89	-52.73	6.97	-45.76	-13	-32.76
3	7620	43.76	-58.86	4.44	-54.42	-13	-41.42

Antenna Polarity & Test Distance: Vertical at 3 M

No.	Freq. (MHz)	Reading (dBm)	S.G Power Value (dBm)	Correction Factor (dB)	Emission Value (dBm)	Limit (dBm)	Margin (dB)
1	3810	49.02	-55.31	7.65	-47.67	-13	-34.67
2	5715	53.45	-51.17	6.97	-44.20	-13	-31.20
3	7620	40.08	-62.54	4.44	-58.10	-13	-45.10

Remarks:

1. Emission Value (dBm) = S.G Value (dBm) + Correction Factor (dB).
2. Correction Factor (dB) = Substitution Antenna Gain (dB) + Cable Loss (dB).

LTE Band 2: 15 MHz

Mode	TX channel 18675	Frequency Range	Above 1000 MHz
------	------------------	-----------------	----------------

Antenna Polarity & Test Distance: Horizontal at 3 M

No.	Freq. (MHz)	Reading (dBm)	S.G Power Value (dBm)	Correction Factor (dB)	Emission Value (dBm)	Limit (dBm)	Margin (dB)
1	3715	57.84	-46.15	7.71	-38.44	-13	-25.44
2	5572.5	52.33	-52.53	7.07	-45.46	-13	-32.46
3	7430	43.05	-59.49	4.61	-54.88	-13	-41.88

Antenna Polarity & Test Distance: Vertical at 3 M

No.	Freq. (MHz)	Reading (dBm)	S.G Power Value (dBm)	Correction Factor (dB)	Emission Value (dBm)	Limit (dBm)	Margin (dB)
1	3715	50.18	-53.81	7.71	-46.10	-13	-33.10
2	5572.5	53.43	-51.43	7.07	-44.36	-13	-31.36
3	7430	40.12	-62.42	4.61	-57.81	-13	-44.81

Remarks:

1. Emission Value (dBm) = S.G Value (dBm) + Correction Factor (dB).
2. Correction Factor (dB) = Substitution Antenna Gain (dB) + Cable Loss (dB).

Mode	TX channel 18900	Frequency Range	Above 1000 MHz
------	------------------	-----------------	----------------

Antenna Polarity & Test Distance: Horizontal at 3 M

No.	Freq. (MHz)	Reading (dBm)	S.G Power Value (dBm)	Correction Factor (dB)	Emission Value (dBm)	Limit (dBm)	Margin (dB)
1	3760	58.68	-45.47	7.68	-37.79	-13	-24.79
2	5640	53.18	-51.56	7.02	-44.54	-13	-31.54
3	7520	43.06	-59.56	4.53	-55.03	-13	-42.03

Antenna Polarity & Test Distance: Vertical at 3 M

No.	Freq. (MHz)	Reading (dBm)	S.G Power Value (dBm)	Correction Factor (dB)	Emission Value (dBm)	Limit (dBm)	Margin (dB)
1	3760	48.68	-55.47	7.68	-47.79	-13	-34.79
2	5640	52.78	-51.96	7.02	-44.94	-13	-31.94
3	7520	40.54	-62.08	4.53	-57.55	-13	-44.55

Remarks:

1. Emission Value (dBm) = S.G Value (dBm) + Correction Factor (dB).
2. Correction Factor (dB) = Substitution Antenna Gain (dB) + Cable Loss (dB).

Mode	TX channel 19125	Frequency Range	Above 1000 MHz
------	------------------	-----------------	----------------

Antenna Polarity & Test Distance: Horizontal at 3 M

No.	Freq. (MHz)	Reading (dBm)	S.G Power Value (dBm)	Correction Factor (dB)	Emission Value (dBm)	Limit (dBm)	Margin (dB)
1	3805	58.79	-45.53	7.65	-37.88	-13	-24.88
2	5707.5	51.78	-52.85	6.97	-45.88	-13	-32.88
3	7610	44.11	-58.51	4.45	-54.06	-13	-41.06

Antenna Polarity & Test Distance: Vertical at 3 M

No.	Freq. (MHz)	Reading (dBm)	S.G Power Value (dBm)	Correction Factor (dB)	Emission Value (dBm)	Limit (dBm)	Margin (dB)
1	3805	50.64	-53.68	7.65	-46.03	-13	-33.03
2	5707.5	53.01	-51.62	6.97	-44.65	-13	-31.65
3	7610	41.57	-61.05	4.45	-56.60	-13	-43.60

Remarks:

1. Emission Value (dBm) = S.G Value (dBm) + Correction Factor (dB).
2. Correction Factor (dB) = Substitution Antenna Gain (dB) + Cable Loss (dB).

LTE Band 2: 20 MHz

Mode	TX channel 18700	Frequency Range	Above 1000 MHz
------	------------------	-----------------	----------------

Antenna Polarity & Test Distance: Horizontal at 3 M

No.	Freq. (MHz)	Reading (dBm)	S.G Power Value (dBm)	Correction Factor (dB)	Emission Value (dBm)	Limit (dBm)	Margin (dB)
1	3720	57.88	-46.13	7.70	-38.42	-13	-25.42
2	5580	51.84	-53.01	7.06	-45.94	-13	-32.94
3	7440	44.64	-57.91	4.60	-53.31	-13	-40.31

Antenna Polarity & Test Distance: Vertical at 3 M

No.	Freq. (MHz)	Reading (dBm)	S.G Power Value (dBm)	Correction Factor (dB)	Emission Value (dBm)	Limit (dBm)	Margin (dB)
1	3720	49.30	-54.71	7.70	-47.00	-13	-34.00
2	5580	52.07	-52.78	7.06	-45.71	-13	-32.71
3	7440	40.66	-61.89	4.60	-57.29	-13	-44.29

Remarks:

1. Emission Value (dBm) = S.G Value (dBm) + Correction Factor (dB).
2. Correction Factor (dB) = Substitution Antenna Gain (dB) + Cable Loss (dB).

Mode	TX channel 18900	Frequency Range	Above 1000 MHz
------	------------------	-----------------	----------------

Antenna Polarity & Test Distance: Horizontal at 3 M

No.	Freq. (MHz)	Reading (dBm)	S.G Power Value (dBm)	Correction Factor (dB)	Emission Value (dBm)	Limit (dBm)	Margin (dB)
1	3760	59.02	-45.13	7.68	-37.45	-13	-24.45
2	5640	52.18	-52.56	7.02	-45.54	-13	-32.54
3	7520	42.92	-59.70	4.53	-55.17	-13	-42.17

Antenna Polarity & Test Distance: Vertical at 3 M

No.	Freq. (MHz)	Reading (dBm)	S.G Power Value (dBm)	Correction Factor (dB)	Emission Value (dBm)	Limit (dBm)	Margin (dB)
1	3760	50.57	-53.58	7.68	-45.90	-13	-32.90
2	5640	53.24	-51.50	7.02	-44.48	-13	-31.48
3	7520	41.28	-61.34	4.53	-56.81	-13	-43.81

Remarks:

1. Emission Value (dBm) = S.G Value (dBm) + Correction Factor (dB).
2. Correction Factor (dB) = Substitution Antenna Gain (dB) + Cable Loss (dB).

Mode	TX channel 19100	Frequency Range	Above 1000 MHz
------	------------------	-----------------	----------------

Antenna Polarity & Test Distance: Horizontal at 3 M

No.	Freq. (MHz)	Reading (dBm)	S.G Power Value (dBm)	Correction Factor (dB)	Emission Value (dBm)	Limit (dBm)	Margin (dB)
1	3800	58.52	-45.78	7.65	-38.13	-13	-25.13
2	5700	51.55	-53.09	6.98	-46.11	-13	-33.11
3	7600	43.86	-58.76	4.46	-54.30	-13	-41.30

Antenna Polarity & Test Distance: Vertical at 3 M

No.	Freq. (MHz)	Reading (dBm)	S.G Power Value (dBm)	Correction Factor (dB)	Emission Value (dBm)	Limit (dBm)	Margin (dB)
1	3800	48.74	-55.56	7.65	-47.91	-13	-34.91
2	5700	53.04	-51.60	6.98	-44.62	-13	-31.62
3	7600	41.65	-60.97	4.46	-56.51	-13	-43.51

Remarks:

1. Emission Value (dBm) = S.G Value (dBm) + Correction Factor (dB).
2. Correction Factor (dB) = Substitution Antenna Gain (dB) + Cable Loss (dB).

5 Pictures of Test Arrangements

Please refer to the attached file (Test Setup Photo).

Appendix – Information of the Testing Laboratories

We, Bureau Veritas Consumer Products Services (H.K.) Ltd., Taoyuan Branch, were founded in 1988 to provide our best service in EMC, Radio, Telecom and Safety consultation. Our laboratories are accredited and approved according to ISO/IEC 17025.

If you have any comments, please feel free to contact us at the following:

Lin Kou EMC/RF Lab

Tel: 886-2-26052180

Fax: 886-2-26051924

Hsin Chu EMC/RF/Telecom Lab

Tel: 886-3-6668565

Fax: 886-3-6668323

Hwa Ya EMC/RF/Safety Lab

Tel: 886-3-3183232

Fax: 886-3-3270892

Email: service.adt@tw.bureauveritas.com

Web Site: www.bureauveritas-adt.com

The address and road map of all our labs can be found in our web site also.

--- END ---