

Amber Helm Development L.C.

92723 Michigan Hwy-152

Sister Lakes, Michigan 49047 USA

Tel: 888-847-8027

EMC Test Report

ZWPJBE-WR2013

Issued: August 24, 2020

regarding

USA: CFR Title 47, Part 15.249 (Emissions)
Canada: IC RSS-210v10 (Emissions)

for



JBE109

Category: Electronic Door Lock

Judgments:

FCC 15.249, ISED RSS-210v10 Compliant

Testing Completed: August 21, 2020



Prepared for:

Allegion, PLC

11819 North Pennsylvania Street, Carmel Indiana 46032 USA

Phone: +1 (317) 810-3362, Fax: +1 (317) 810-3193

Contact: Ryan Kincaid, ryan.kincaid@allegion.com

Data Recorded by:

Dr. Joseph Brunett, EMC-002790-NE

Reviewed by:

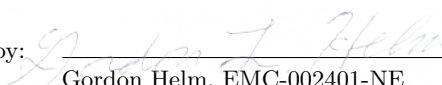
Gordon Helm, EMC-002401-NE

Prepared by:

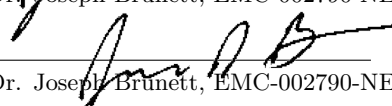
Dr. Joseph Brunett, EMC-002790-NE

Date of Issue: August 24, 2020

Revision History

Rev. No.	Date	Details	Revised By
r0	August 24, 2020	Initial Release.	J. Brunett
r1	August 30, 2020	Correct DSC to DXX.	J. Brunett

Contents

Revision History	2
Table of Contents	2
1 Test Report Scope and Limitations	4
1.1 Laboratory Authorization	4
1.2 Report Retention	4
1.3 Subcontracted Testing	4
1.4 Test Data	4
1.5 Limitation of Results	4
1.6 Copyright	4
1.7 Endorsements	4
1.8 Test Location	5
1.9 Traceability and Equipment Used	5
2 Test Specifications and Procedures	6
2.1 Test Specification and General Procedures	6
3 Configuration and Identification of the Equipment Under Test	7
3.1 Description and Declarations	7
3.1.1 EUT Configuration	8
3.1.2 Modes of Operation	8
3.1.3 Variants	8
3.1.4 Test Samples	8
3.1.5 Functional Exerciser	8
3.1.6 Modifications Made	8
3.1.7 Production Intent	8
3.1.8 Declared Exemptions and Additional Product Notes	8
4 Emissions	9
4.1 General Test Procedures	9
4.1.1 Radiated Test Setup and Procedures	9
4.1.2 Conducted Emissions Test Setup and Procedures	11
4.1.3 Power Supply Variation	11
4.2 Intentional Emissions	12
4.2.1 Fundamental Emission Pulsed Operation	12
4.2.2 Fundamental Emission Bandwidth	13
4.2.3 Fundamental Emission Field Strength	15
4.3 Unintentional Emissions	16
4.3.1 Transmit Chain Spurious Emissions	16
4.3.2 Radiated Digital Spurious	17
5 Measurement Uncertainty and Accreditation Documents	18

List of Tables

1	Test Site List.	5
2	Equipment List.	5
3	EUT Declarations.	7
4	Fundamental Emission Pulsed Operation.	12
5	Fundamental Emission Bandwidth.	13
6	Fundamental Emission Field Strength.	15
7	Transmit Chain Spurious Emissions.	16
8	Measurement Uncertainty.	18

List of Figures

1	Photos of EUT.	7
2	EUT Test Configuration Diagram.	8
3	Radiated Emissions Diagram of the EUT.	9
4	Radiated Emissions Test Setup Photograph(s).	10
5	Fundamental Emission Pulsed Operation.	12
6	Fundamental Emission Bandwidth.	14
7	Accreditation Documents	18

1 Test Report Scope and Limitations

1.1 Laboratory Authorization

Test Facility description and attenuation characteristics are on file with the FCC Laboratory, Columbia, Maryland (FCC Reg. No: US5348 and US5356) and with ISED Canada, Ottawa, ON (File Ref. No: 3161A and 24249). Amber Helm Development L.C. holds accreditation under NVLAP Lab Code 200129-0.

1.2 Report Retention

For equipment verified to comply with the regulations herein, the manufacturer is obliged to retain this report with the product records for the life of the product, and no less than ten years. A copy of this Report will remain on file with this laboratory until September 2030.

1.3 Subcontracted Testing

This report does not contain data produced under subcontract.

1.4 Test Data

This test report contains data included within the laboratories scope of accreditation.

1.5 Limitation of Results

The test results contained in this report relate only to the item(s) tested. Any electrical or mechanical modification made to the test item subsequent to the test date shall invalidate the data presented in this report. Any electrical or mechanical modification made to the test item subsequent to this test date shall require reevaluation.

1.6 Copyright

This report shall not be reproduced, except in full, without the written approval of Amber Helm Development L.C.

1.7 Endorsements

This report shall not be used to claim product endorsement by any accrediting, regulatory, or governmental agency.

1.8 Test Location

The EUT was fully tested by **Amber Helm Development L.C.**, headquartered at 92723 Michigan Hwy-152, Sister Lakes, Michigan 49047 USA. Table 1 lists all sites employed herein. Specific test sites utilized are also listed in the test results sections of this report where needed.

Table 1: Test Site List.

Description	Location	Quality Num.
OATS (3 meter)	3615 E Grand River Rd., Williamston, Michigan 48895	OATSC

1.9 Traceability and Equipment Used

Pertinent test equipment used for measurements at this facility is listed in Table 2. The quality system employed at Amber Helm Development L.C. has been established to ensure all equipment has a clearly identifiable classification, calibration expiry date, and that all calibrations are traceable to the SI through NIST, other recognized national laboratories, accepted fundamental or natural physical constants, ratio type of calibration, or by comparison to consensus standards.

Table 2: Equipment List.

Description	Manufacturer/Model	SN	Quality Num.	Cal/Ver By / Date Due
Biconical	EMCO / 93110B	9802-3039	BICEMCO01	Keysight / Aug-2020
Log Periodic Antenna	EMCO / 3146	9305-3614	LOGEMCO01	Keysight / Aug-2020
BNC-BNC Coax	WRTL / RG58/U	001	CAB001-BLACK	AHD / Oct-2020
3.5-3.5MM Coax	PhaseFlex / PhaseFlex	001	CAB015-PURP	AHD / Jan-2021
Spectrum Analyzer	R & S / FSV30	101660	RSFSV30001	RS / Apr-2021
Quad Ridge Horn	Singer / A6100	C35200	HQR1TO18S01	Keysight / Aug-2021

2 Test Specifications and Procedures

2.1 Test Specification and General Procedures

The goal of Allegion, PLC is to demonstrate that the Equipment Under Test (EUT) complies with the Rules and/or Directives below. Detailed in this report are the results of testing the Allegion, PLC JBE109 for compliance to:

Country/Region	Rules or Directive	Referenced Section(s)
United States	Code of Federal Regulations	CFR Title 47, Part 15.249
Canada	ISED Canada	IC RSS-210v10

It has been determined that the equipment under test is subject to the rules and directives above at the date of this testing. In conjunction with these rules and directives, the following specifications and procedures are followed herein to demonstrate compliance (in whole or in part) with these regulations.

ANSI C63.4:2014	"Methods of Measurement of Radio-Noise Emissions from Low-Voltage Electrical and Electronic Equipment in the Range of 9 kHz to 40 GHz"
ANSI C63.10:2013	"American National Standard of Procedures for Compliance Testing of Unlicensed Wireless Devices"
TP0102RA	"AHD Internal Document TP0102 - Radiated Emissions Test Procedure"
TP0106RC	"AHD Internal Document TP0106 - Emissions Measurement Procedures (above 40 GHz)"
ISED Canada	"The Measurement of Occupied Bandwidth"
ICES-003; Issue 6 (2016)	"Information Technology Equipment (ITE) - Limits and methods of measurement"

3 Configuration and Identification of the Equipment Under Test

3.1 Description and Declarations

The EUT is wireless enabled electronic door lock mechanism. The EUT is approximately 7 x 17 x 3.5 cm in dimension, and is depicted in Figure 1. It is powered by 6 VDC alkaline batteries. This product is used as an electronic entry door latch mechanism with Zwave+ radio interface. Table 3 outlines provider declared EUT specifications.



Figure 1: Photos of EUT.

Table 3: EUT Declarations.

General Declarations

Equipment Type:	Electronic Door Lock
Country of Origin:	USA
Nominal Supply:	6 VDC
Oper. Temp Range:	not declared
Frequency Range:	908.4, 916 MHz
Antenna Dimension:	Integral
Antenna Type:	Integral
Antenna Gain:	Not Declared
Number of Channels:	2
Channel Spacing:	Not Applicable
Alignment Range:	Not Declared
Type of Modulation:	2FSK, 2GFSK

United States

FCC ID Number:	XPB-JBE109KPD
Classification:	DXX

Canada

IC Number:	8053B-JBE109KPD
Classification:	Low Power Device (902-928 MHz)

3.1.1 EUT Configuration

The EUT is configured for testing as depicted in Figure 2.

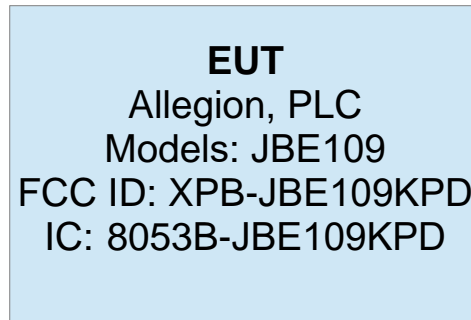

Figure 2: EUT Test Configuration Diagram.

3.1.2 Modes of Operation

The EUT is capable of operating as a Zwave+ enabled lock at either 908.4 MHz or 916.0 MHz as a single channel Zwave transceiver with data rates of 9 kbps, 40 kbps at 908.4 MHz and 100 kbps at 916 MHz. Both channels and all modulation rates are tested herein.

3.1.3 Variants

There is only a single variant of the EUT, as tested.

3.1.4 Test Samples

Two samples of the EUT were provided for emissions testing, both radiated samples. To place the EUT into CW and CM modes on the EUT's two operating channels, a serial UART interface cable was provided and interfaced via a laboratory PC terminal program. This interface was then disconnected during testing.

3.1.5 Functional Exerciser

EUT functionality was confirmed by observation of transmitted signal.

3.1.6 Modifications Made

There were no modifications made to the EUT by this laboratory. However, in order to bring the device into compliance with band fundamental emissions limits the manufacturer decreased the maximum power setting on the Zwave chipset to a power level of 20. Manufacturer states the EUT will be sold only with this firmware encoded power setting.

3.1.7 Production Intent

The EUT appears to be a production ready sample.

3.1.8 Declared Exemptions and Additional Product Notes

As the EUT contains a receiver operating between 30 and 960 MHz subject to SDoC spurious emissions limits in line with that mode of operation. Receive mode testing is performed separately via SDoC.

4 Emissions

4.1 General Test Procedures

4.1.1 Radiated Test Setup and Procedures

Radiated electromagnetic emissions from the EUT are first pre-scanned in our screen room. Spectrum and modulation characteristics of all emissions are recorded. Instrumentation, including spectrum analyzers and other test equipment as detailed in Section 1.8 are employed. After pre-scan, emission measurements are made on the test site of record. If the EUT connects to auxiliary equipment and is table or floor standing, the configurations prescribed in relevant test standards are followed. Alternatively, a layout closest to normal use (as declared by the provider) is employed if the resulting emissions appear to be worst-case in such a configuration. See Figure 3. All intentionally radiating elements that are not fixed-mounted in use are placed on the test table lying flat, on their side, and on their end (3-axes) and the resulting worst case emissions are recorded. If the EUT is fixed-mounted in use, measurements are made with the device oriented in the manner consistent with installation and then emissions are recorded. If the EUT exhibits spurious emissions due to internal receiver circuitry, such emissions are measured with an appropriate carrier signal applied.

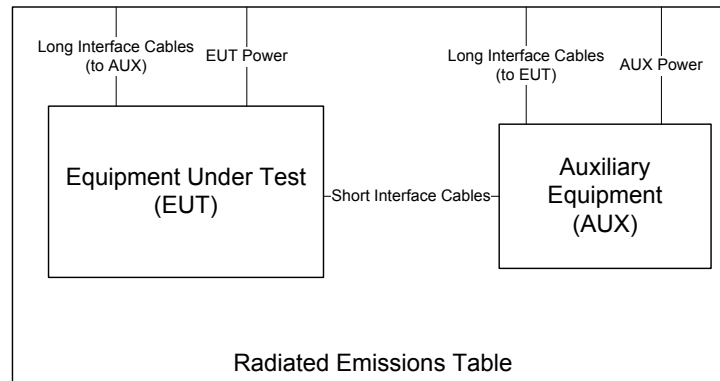

Figure 3: Radiated Emissions Diagram of the EUT.

For devices with intentional emissions below 30 MHz, a shielded loop antenna and/or E-field and H-Field broadband probes are used depending on the regulations. Shielded loops are placed at a 1 meter receive height at the desired measurement distance. For exposure in this band, the broadband probes employed are 10cm diameter single-axis shielded transducers and measurements are repeated and summed over three axes.

Emissions between 30 MHz and 1 GHz are measured using calibrated broadband antennas. For both horizontal and vertical polarizations, the test antenna is raised and lowered from 1 to 4 m in height until a maximum emission level is detected. The EUT is then rotated through 360° in azimuth until the highest emission is detected. The test antenna is then raised and lowered one last time from 1 to 4 m and the worst case value is recorded. Emissions above 1 GHz are characterized using standard gain or broadband ridge-horn antennas on our OATS with a 4×5 m rectangle of ECCOSORB absorber covering the OATS ground screen and a 1.5m table height. Care is taken to ensure that test receiver resolution and video bandwidths meet the regulatory requirements, and that the emission bandwidth of the EUT is not reduced. Photographs of the test setup employed are depicted in Figure 4.

Where regulations allow for direct measurement of field strength, power values (dBm) measured on the test receiver / analyzer are converted to $\text{dB}\mu\text{V}/\text{m}$ at the regulatory distance, using

$$E_{dist} = 107 + P_R + K_A - K_G + K_E - C_F$$

where P_R is the power recorded on spectrum analyzer, in dBm, K_A is the test antenna factor in dB/m, K_G is the combined pre-amplifier gain and cable loss in dB, K_E is duty correction factor (when applicable) in dB, and C_F is a distance conversion (employed only if limits are specified at alternate distance) in dB. This field strength value is then compared with the regulatory limit. If effective isotropic radiated power (EIRP) is computed, it is computed as

$$EIRP(\text{dBm}) = E_{3m}(\text{dB}\mu\text{V}/\text{m}) - 95.2.$$

When presenting data at each frequency, the highest measured emission under all possible EUT orientations (3-axes) is reported.

Where regulations call for substitution method measurements, the EUT is replaced by a substitution antenna if field strength measurements indicate the emission is close to the regulatory limit. This antenna is co-polarized with the test antenna and tuned (when necessary) to the emission frequency, after which the test antenna height is again optimized. The substitution antenna's signal level is adjusted such that its emission is equal to the level measured from the EUT. The signal level applied to the substitution antenna is then recorded. Effective isotropic radiated power (EIRP) and effective radiated power (ERP) in dBm are formulated from

$$EIRP = P_T - G_A = ERP + 2.16, \quad (1)$$

where P_T is the power applied to substitution antenna in dBm, including correction for cable loss, and G_A is the substitution antenna gain, in dBi.



Figure 4: Radiated Emissions Test Setup Photograph(s).

4.1.2 Conducted Emissions Test Setup and Procedures

The EUT is not subject to measurement of power line conducted emissions as it is powered solely by its internal battery.

4.1.3 Power Supply Variation

Tests at extreme supply voltages are made if required by the procedures specified in the test standard, and results of this testing are detailed in this report.

In the case the EUT is designed for operation from a battery power source, the extreme test voltages are evaluated over the range specified in the test standard; no less than $\pm 10\%$ of the nominal battery voltage declared by the manufacturer. For all battery operated equipment, worst case intentional and spurious emissions are re-checked employing a new (fully charged) battery.

4.2 Intentional Emissions

4.2.1 Fundamental Emission Pulsed Operation

Test Setup & Procedure The test equipment and facilities were setup in accordance with the standards and procedures listed in Section 2.1. Environmental conditions were set at the appropriate temperature and thermal balance was checked with a thermocouple based probe. Duty cycle is reported for all relevant modes of operation. The test equipment employed includes RSFSV30001, LOGEMCO01.

Measurement Results The details and results of testing the EUT are summarized in Table 4. Plots showing the measurements made to obtain these values are provided in Figure 5.

Table 4: Fundamental Emission Pulsed Operation.

Detector	Span	IF Bandwidth	Video Bandwidth	Test Date:	24-Aug-20
Pk	0	1 MHz	3 MHz	Test Engineer:	Joseph Brunett
				EUT:	JBE109 KPD
				EUT Mode:	Modulated
				Meas. Distance:	10 cm

#	Frequency (MHz)	EUT Test Mode*	Overall Transmission			Internal Frame Characteristics			Computed Duty Cycle	
			Min. Repetition Rate (sec)	Max. No. of Frames	Total Transmission Length (sec)	Max. Frame Length (ms)	Min. Frame Period (ms)	Frame Encoding	(%)	(dB)
R1	908.4	Cont. Mod.	-	-	inf.	inf.	-	EUT capable of continuous 2FSK/2GFSK transmission.	100.0	0.0
R2	916.0	Cont. Mod.	-	-	inf.	inf.	-	EUT capable of continuous 2FSK/2GFSK transmission.	100.0	0.0
#	C1	C2	C3	C4	C5	C6	C7	C8	C9	C10

Example Calculation: Worst Case FSK/GFSK Duty (%) = 100 %

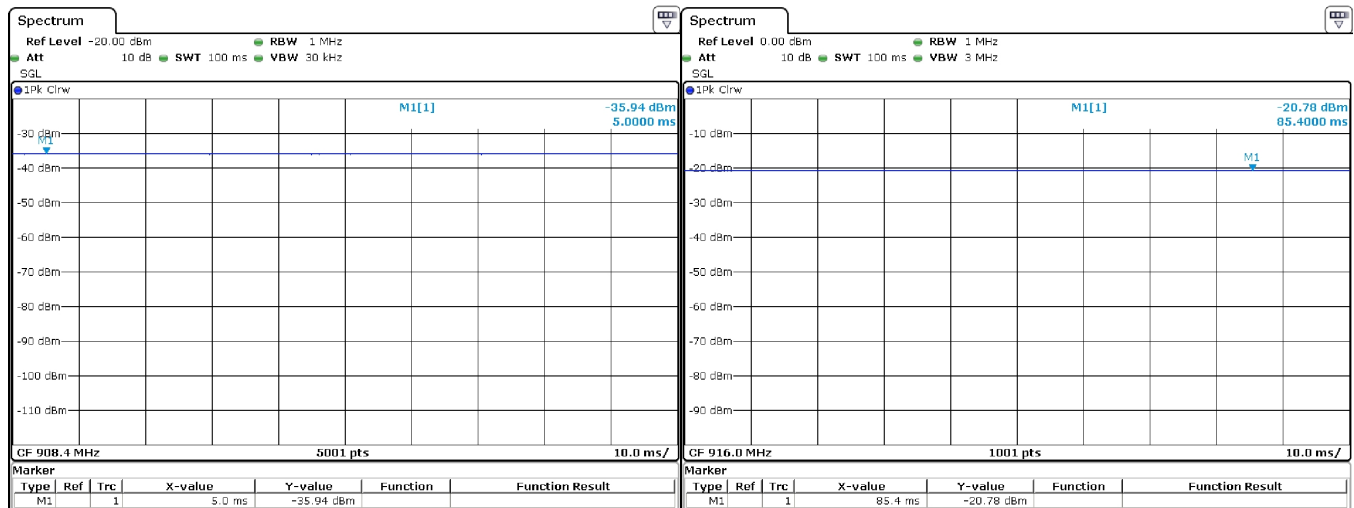

Figure 5: Fundamental Emission Pulsed Operation.

4.2.2 Fundamental Emission Bandwidth

Test Setup & Procedure The test equipment and facilities were setup in accordance with the standards and procedures listed in Section 2.1. Environmental conditions were set at the appropriate temperature and thermal balance was checked with a thermocouple based probe. Emission bandwidth (EBW) of the EUT is measured with the device placed in the test mode(s) with the shortest available frame length and minimum frame spacing. The 20 dB EBW is measured as the max-held peak-detected signal when the IF bandwidth is greater than or equal to 1% of the receiver span. For complex modulations other than ASK and FSK, the 99% emission bandwidth per IC test procedures has a different result, and is also reported. The test equipment employed includes RSFSV30001, LOGEMCO01.

Measurement Results The details and results of testing the EUT are summarized in Table 5. Plots showing the measurements made to obtain these values are provided in Figure 6.

Table 5: Fundamental Emission Bandwidth.

Detector	IF Bandwidth	Video Bandwidth	Test Date:	10-Aug-20
Pk	10 kHz	30 kHz	Test Engineer:	Joseph Brunett
			EUT:	JBE109 KPD
			EUT Mode:	Modulated
			Meas. Distance:	10 cm

							FCC/IC
#	Modulation	Center Frequency (MHz)	20 dB EBW (MHz)	99% OBW (MHz)			
R1	2FSK, 9kbps	908.4	0.083	0.079			
R2	2FSK, 40kbps	908.4	0.097	0.091			
R3	2GFSK, 100 kbps	916.0	0.129	0.115			
R4							
R5							
#	C1	C2	C3	C4	C5	C6	C7

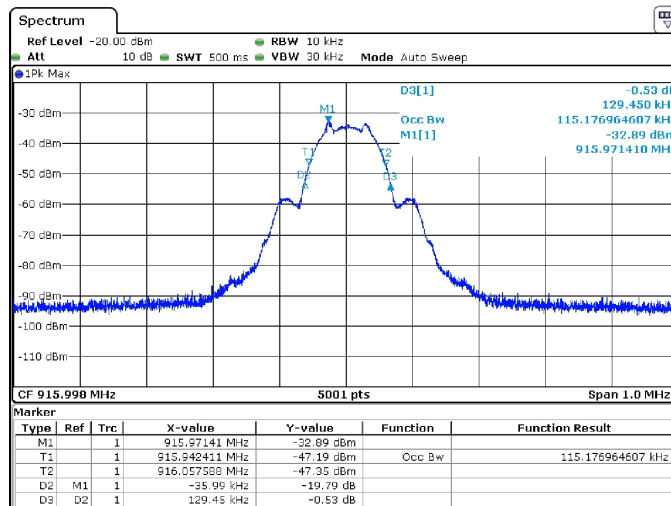
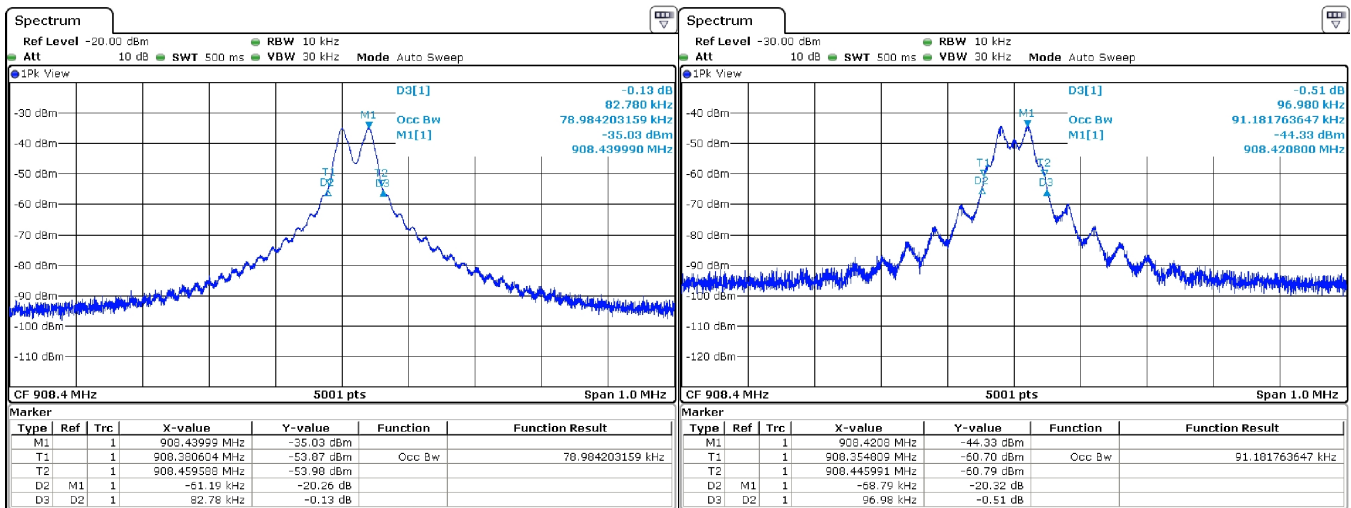

Figure 6: Fundamental Emission Bandwidth.

4.2.3 Fundamental Emission Field Strength

Test Setup & Procedure The test equipment and facilities were setup in accordance with the standards and procedures listed in Section 2.1. Environmental conditions were set at the appropriate temperature and thermal balance was checked with a thermocouple based probe. Fundamental emissions are measured at the regulatory distance on our OATS. The test equipment employed includes RSFSV30001, LOGEMCO01.

Measurement Results The details and results of testing the EUT are summarized in Table 6.

Table 6: Fundamental Emission Field Strength.

EUT Modes: a1 JBE109 - KPD 908.4 MHz, CM @ 40 kbps
 a2 JBE109 - KPD 916 MHz, CM @ 100 kbps
 a3 JBE109 - KPD 908.4 MHz, CW
 a4 JBE109 - KPD 916 MHz, CW

Test Date: 08/19/20
Test Engineer: J. Brunett

R0	Frequency		Temp. C RH %	Table Angle deg	Site				EUT			Test Antenna				Cable Kg	Receiver				Field Strength @ DR						EIRP		Details
	Start MHz	Stop MHz			MR	DR	N/F	CF	Mode	Volt.	Dim	Pol.	Ant. Height	Dim.	Ka		Rx Power Pk	Avg	Bandwidth RBW	VBW	Qpk		Qpk		Calc.	Limit	Pass Fail dB		
					m	m		dB	table	(V)	cm	H/V	m	cm	dB/m		dB	dBuV/m	MHz	Meas.	Limit	Meas.	Limit	dBm					
R1	SETUP				OATSC				JBE109 - KPD			LOGEMCO01					RSFSV30001				NOTES: WORST EUT ORIENTATION (HPOL: FLAT, VPOL: END)								
R2	908.4	908.4	28/25	0.0	3.0	3.0		0.0	a3	6.0	8.0	H	1.0	100.0	22.7	-0.2			0.12	0.30	92.9	94.0	94.0	92.9	94.0	94.0	-2.3		1.1
R3	908.4	908.4	28/25	90.0	3.0	3.0		0.0	a3	6.0	8.0	V	1.3	100.0	22.7	-0.2			0.12	0.30	93.0	94.0	94.0	93.0	94.0	94.0	-2.2		1.0
R4	SETUP				OATSC				JBE109 - KPD			LOGEMCO01					RSFSV30001				NOTES: WORST EUT ORIENTATION (HPOL: FLAT, VPOL: END)								
R5	916.0	916.0	28/25	0.0	3.0	3.0		0.0	a4	6.0	8.0	H	1.0	100.0	22.8	-0.2			0.12	0.30	92.3	94.0	94.0	92.0	94.0	94.0	-2.9		1.7
R6	916.0	916.0	28/25	90.0	3.0	3.0		0.0	a4	6.0	8.0	V	1.3	100.0	22.8	-0.2			0.12	0.30	92.7	94.0	94.0	92.4	94.0	94.0	-2.5		1.3
R7																													
#	C1	C2	C3	C4	C5	C6	C7	C8	C9	C10	C11	C12	C13	C14	C15	C16	C17	C18	C19	C20	C21	C22	C23	C24	C25	C26	C27	C28	C29

(ROW) (COLUMN) NOTE:
 R0 C5 MR is Measurement Range, which is reduced from DR to achieve necessary SNR.
 R0 C6 DR is the regulatory Desired Range measurement distance.
 R0 C7 N/F is Near-Field / Far-Field distance computed for max of EUT Antenna Dimension (C10) and Test Antenna dimension (C12), where applicable.
 R0 C8 CF is computed using a 20 dB/decade Decay Rate.
 R0 C18/19 When E-field or EIRP is reported directly from Spectrum Analyzer, Antenna Factors and Cable losses are included directly in SA settings and Pr is not reported.

4.3 Unintentional Emissions

4.3.1 Transmit Chain Spurious Emissions

Test Setup & Procedure The test equipment and facilities were setup in accordance with the standards and procedures listed in Section 2.1. Environmental conditions were set at the appropriate temperature and thermal balance was checked with a thermocouple based probe. Spurious radiated emissions measurements are performed to 10 times the highest fundamental operating frequency. The test equipment employed includes RSFSV30001, LOGEMCO01, HQR1TO18S01.

Measurement Results The details and results of testing the EUT are summarized in Table 7.

Table 7: Transmit Chain Spurious Emissions.

EUT Modes: a1 JBE109 - KPD 908.4 MHz, CM @ 40 kbps
 a2 JBE109 - KPD 916 MHz, CM @ 100 kbps
 a3 JBE109 - KPD 908.4 MHz, CW
 a4 JBE109 - KPD 916 MHz, CW

Test Date: 01/21/20
Test Engineer: J. Brunett

R0	Frequency		Temp. C	Site				EUT			Test Antenna			Cable Kg	Receiver				Field Strength @ DR				EIRP		Details				
	Start	Stop		MR	DR	N/F	CF	Mode	Volt.	Dim	Pol.	Ant. Height	Dim.		Ka	Rx Power Pk	Avg	Bandwidth RBW	VBW	Meas.	Limit	Meas.	Limit	Calc.		Limit			
	MHz	MHz		deg	m	dB	see table	(V)	cm	H/V	m	cm	dB/m		dB	dBuV/m	MHz	Meas.	Limit	Meas.	Limit	dBm	dBm	Pass		Fail			
R1	SETUP			OATSC				JBE109 - KPD			LOGEMCO01				RSFSV30001				NOTES:										
R2	890.0	902.0	28/25	0.0	3.0	3.0		0.0	a1	3.0	8.0	H	1.0	100.0	22.6	-0.2		0.12	0.30	31.0	46.0	46.0	31.0	46.0	46.0		15.0		
R3	890.0	902.0	28/25	90.0	3.0	3.0		0.0	a1	3.0	8.0	V	1.3	100.0	22.6	-0.2		0.12	0.30	29.3	46.0	46.0	29.3	46.0	46.0		16.7		
R4	928.0	940.0	28/25	0.0	3.0	3.0		0.0	a1	3.0	8.0	H	1.0	100.0	23.1	-0.2		0.12	0.30	28.2	46.0	46.0	28.2	46.0	46.0		17.8		
R5	928.0	940.0	28/25	90.0	3.0	3.0		0.0	a1	3.0	8.0	V	1.3	100.0	23.1	-0.2		0.12	0.30	33.1	46.0	46.0	33.1	46.0	46.0		12.9		
R6	SETUP			OATSC				JBE109 - KPD			HQR1TO18S01				RSFSV30001				NOTES: max all orientations of EUT										
R7	1816.8	1816.8	28/25	max all	3.0	3.0	0.3	0.0	a3	3.0	4.0	H/V	max all	15.0	30.2	-4.3		1.00	3.00	32.2	74.0	74.0	32.2	54.0	54.0		21.8		
R8	2725.2	2725.2	28/25	max all	3.0	3.0	0.4	0.0	a3	3.0	8.0	H/V	max all	15.0	30.2	-5.4		1.00	3.00	29.7	74.0	74.0	29.7	54.0	54.0		24.3		
R9	3633.6	3633.6	28/25	max all	3.0	3.0	0.5	0.0	a3	3.0	8.0	H/V	max all	15.0	31.5	-6.2		1.00	3.00	31.0	74.0	74.0	31.0	54.0	54.0		23.0		
R10	4542.0	4542.0	28/25	max all	3.0	3.0	0.7	0.0	a3	3.0	8.0	H/V	max all	15.0	32.3	-6.8		1.00	3.00	30.1	74.0	74.0	30.1	54.0	54.0		23.9		
R11	5450.4	5450.4	28/25	max all	3.0	3.0	0.8	0.0	a3	3.0	8.0	H/V	max all	15.0	32.6	-7.4		1.00	3.00	31.8	74.0	74.0	31.8	54.0	54.0		22.2		
R12	6358.8	6358.8	28/25	max all	3.0	3.0	1.0	0.0	a3	3.0	8.0	H/V	max all	15.0	33.0	-8.0		1.00	3.00	34.7	74.0	74.0	34.7	54.0	54.0		19.3		
R13	7267.2	7267.2	28/25	max all	3.0	3.0	1.1	0.0	a3	3.0	8.0	H/V	max all	15.0	33.5	-8.6		1.00	3.00	24.8	74.0	74.0	24.8	54.0	54.0		29.2		
R14	8175.6	8175.6	28/25	max all	4.0	4.0	1.2	0.0	a3	3.0	8.0	H/V	max all	15.0	34.1	-9.3		1.00	3.00	23.7	74.0	74.0	23.7	54.0	54.0		30.3		
R15	9084.0	9084.0	28/25	max all	5.0	5.0	1.4	0.0	a3	4.0	8.0	H/V	max all	15.0	34.7	-9.9		1.00	3.00	22.9	74.0	74.0	22.9	54.0	54.0		31.1		
R16																													
R17	SETUP			OATSC				JBE109 - KPD			LOGEMCO01				RSFSV30001				NOTES: max all orientations of EUT										
R18	890.0	902.0	28/25	0.0	3.0	3.0		0.0	a2	3.0	8.0	H	1.0	100.0	22.6	-0.2		0.12	0.30	32.6	46.0	46.0	32.6	46.0	46.0		13.4		
R19	890.0	902.0	28/25	90.0	3.0	3.0		0.0	a2	3.0	8.0	V	1.3	100.0	22.6	-0.2		0.12	0.30	30.2	46.0	46.0	30.2	46.0	46.0		15.8		
R20	928.0	940.0	28/25	0.0	3.0	3.0		0.0	a2	3.0	8.0	H	1.0	100.0	23.1	-0.2		0.12	0.30	29.9	46.0	46.0	29.9	46.0	46.0		16.1		
R21	928.0	940.0	28/25	90.0	3.0	3.0		0.0	a2	3.0	8.0	V	1.0	100.0	23.1	-0.2		0.12	0.30	32.5	46.0	46.0	32.5	46.0	46.0		13.5		
R22	SETUP			OATSC				JBE109 - KPD			HQR1TO18S01				RSFSV30001				NOTES: max all orientations of EUT										
R23	1832.0	1832.0	28/25	max all	3.0	3.0	0.3	0.0	a4	3.0	4.0	H/V	max all	15.0	30.1	-4.3	-93.4		1.00	3.00	30.1	74.0	74.0	30.1	54.0	54.0		23.9	
R24	2748.0	2748.0	28/25	max all	3.0	3.0	0.4	0.0	a4	3.0	8.0	H/V	max all	15.0	30.3	-5.4	-92.2		1.00	3.00	32.6	74.0	74.0	32.6	54.0	54.0		21.4	
R25	3664.0	3664.0	28/25	max all	3.0	3.0	0.5	0.0	a4	3.0	8.0	H/V	max all	15.0	31.5	-6.2	-91.1		1.00	3.00	31.5	74.0	74.0	31.5	54.0	54.0		22.5	
R26	4580.0	4580.0	28/25	max all	3.0	3.0	0.7	0.0	a4	3.0	8.0	H/V	max all	15.0	32.3	-6.9	-90.5		1.00	3.00	33.2	74.0	74.0	33.2	54.0	54.0		20.8	
R27	5496.0	5496.0	28/25	max all	3.0	3.0	0.8	0.0	a4	3.0	8.0	H/V	max all	15.0	32.6	-7.5	-89.7		1.00	3.00	31.3	74.0	74.0	31.3	54.0	54.0		22.7	
R28	6412.0	6412.0	28/25	max all	3.0	3.0	1.0	0.0	a4	3.0	8.0	H/V	max all	15.0	33.0	-8.1	-85.7		1.00	3.00	33.8	74.0	74.0	33.8	54.0	54.0		20.2	
R29	7328.0	7328.0	28/25	max all	3.0	3.0	1.1	0.0	a4	3.0	8.0	H/V	max all	15.0	33.5	-8.7	-96.4		1.00	3.00	27.5	74.0	74.0	27.5	54.0	54.0		26.5	
R30	8244.0	8244.0	28/25	max all	4.0	4.0	1.2	0.0	a4	3.0	8.0	H/V	max all	15.0	34.2	-9.3	-97.6		1.00	3.00	23.7	74.0	74.0	23.7	54.0	54.0		30.3	
R31	9160.0	9160.0	28/25	max all	5.0	5.0	1.4	0.0	a4	4.0	8.0	H/V	max all	15.0	34.8	-10.0	-96.9		1.00	3.00	23.5	74.0	74.0	23.5	54.0	54.0		30.5	
R32																													
#	C1	C2	C3	C4	C5	C6	C7	C8	C9	C10	C11	C12	C13	C14	C15	C16	C17	C18	C19	C20	C21	C22	C23	C24	C25	C26	C27	C28	C29

(ROW) (COLUMN) NOTE:
 R0 C5 MR is Measurement Range, which is reduced from DR to achieve necessary SNR.
 R0 C6 DR is the regulatory Desired Range measurement distance.
 R0 C7 N/F is Near-Field / Far-Field distance computed for max of EUT Antenna Dimension (C10) and Test Antenna dimension (C12), where applicable.
 R0 C8 CF is computed using a 20 dB/decade Decay Rate.
 R0 C18/19 When E-field or EIRP is reported directly from Spectrum Analyzer, Antenna Factors and Cable losses are included directly in SA settings and Pr is not reported.

4.3.2 Radiated Digital Spurious

The results for the measurement of digital spurious emissions are not reported herein as all digital emissions were greater than 20 dB below the regulatory limit. Radiation from digital components was measured to 4 GHz, or to five times the maximum digital component operating frequency, whichever is greater.

5 Measurement Uncertainty and Accreditation Documents

The maximum values of measurement uncertainty for the laboratory test equipment and facilities associated with each test are given in the table below. This uncertainty is computed for a 95.45% confidence level based on a coverage factor of $k = 2$.

Table 8: Measurement Uncertainty.

Measured Parameter	Measurement Uncertainty [†]
Radio Frequency	$\pm(f_{Mkr}/10^7 + RBW/10 + (SPN/(PTS - 1))/2 + 1 \text{ Hz})$
Conducted Emm. Amplitude	$\pm 1.9 \text{ dB}$
Radiated Emm. Amplitude ($f < 30 \text{ MHz}$)	$\pm 3.1 \text{ dB}$
Radiated Emm. Amplitude (30 – 200 MHz)	$\pm 4.0 \text{ dB}$
Radiated Emm. Amplitude (200 – 1000 MHz)	$\pm 5.2 \text{ dB}$
Radiated Emm. Amplitude ($f > 1000 \text{ MHz}$)	$\pm 3.7 \text{ dB}$

[†]Ref: CISPR 16-4-2:2011+A1:2014



Figure 7: Accreditation Documents