

Amber Helm Development L.C.

92723 Michigan Hwy-152

Sister Lakes, Michigan 49047 USA

Tel: 888-847-8027

EMC Test Report

DENAL-182240TX

Issued: May 8, 2018

regarding

USA: CFR Title 47, Part 15.247 (Emissions)
Canada: IC RSS-247/GENe (Emissions)

for

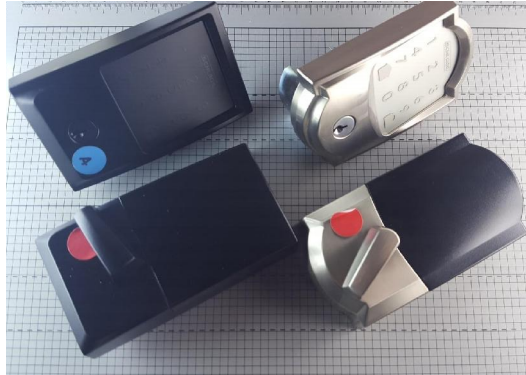

BE489WB

Category: Electronic Door Lock

Judgements:

FCC 15.247, ISED RSS-247 Compliant

Tested: April 11, 2018



TESTING No. 200129-0

Prepared for:

Allegion, PLC

11819 North Pennsylvania Street, Carmel Indiana 46032 USA

Phone: +1 (317) 810-3362

Fax: +1 (317) 810-3193

Contact: Ryan Kincaid

ryan.kincaid@allegion.com

Data Recorded by:

Gordon Helm, EMC-002404-NE

Reviewed by:

Dave Miller, EMC-003027-NE

Prepared by:

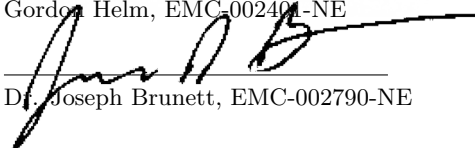
Dr. Joseph Brunett, EMC-002790-NE

Date of Issue:

May 8, 2018

Revision History

Rev. No.	Date	Details	Revised By
r0	May 8, 2018	Initial Release.	J. Brunett
r1	May 18, 2018	Additional plot annotations.	J. Brunett
r2	May 21, 2018	Modulated conducted power meas. added	J. Brunett
r3	May 23, 2018	Additional notes on conducted peak power meas.	J. Brunett

Contents

Revision History	2
Table of Contents	2
1 Test Report Scope and Limitations	5
1.1 Laboratory Authorization	5
1.2 Report Retention	5
1.3 Subcontracted Testing	5
1.4 Test Data	5
1.5 Limitation of Results	5
1.6 Copyright	5
1.7 Endorsements	5
1.8 Test Location	6
1.9 Traceability and Equipment Used	6
2 Test Specifications and Procedures	7
2.1 Test Specification and General Procedures	7
3 Configuration and Identification of the Equipment Under Test	8
3.1 Description and Declarations	8
3.1.1 EUT Configuration	8
3.1.2 Modes of Operation	8
3.1.3 Variants	9
3.1.4 Test Samples	9
3.1.5 Functional Exerciser	9
3.1.6 Modifications Made	9
3.1.7 Production Intent	9
3.1.8 Declared Exemptions and Additional Product Notes	9
4 Emissions	10
4.1 General Test Procedures	10
4.1.1 Radiated Test Setup and Procedures	10
4.1.2 Conducted Emissions Test Setup and Procedures	12
4.1.3 Power Supply Variation	12
4.2 Intentional Emissions	13
4.2.1 Duty and Transmission Cycle, Pulsed Operation	13
4.2.2 Fundamental Emission Bandwidth	16
4.2.3 Effective Isotropic Radiated Power	19
4.2.4 Power Spectral Density	22
4.3 Unintentional Emissions	25
4.3.1 Transmit Chain Spurious Emissions	25

4.3.2	Relative Transmit Chain Spurious Emissions	26
4.3.3	General Radiated Spurious	27
5	Measurement Uncertainty and Accreditation Documents	28

List of Tables

1	Test Site List.	6
2	Equipment List.	6
3	EUT Declarations.	8
4	Pulsed Emission Characteristics (Duty Cycle).	13
5	Intentional Emission Bandwidth.	16
6	Radiated Power Results.	19
7	Power Spectral Density Results.	22
8	Transmit Chain Spurious Emissions.	25
8	Transmit Chain Spurious Emissions.	25
9	Radiated Digital Spurious Emissions.	27
10	Measurement Uncertainty.	28

List of Figures

1	Photos of EUT.	8
2	EUT Test Configuration Diagram.	9
3	Radiated Emissions Diagram of the EUT.	10
4	Radiated Emissions Test Setup Photograph(s).	11
5	Conducted RF Test Setup Photograph(s).	12
6	Pulsed Emission Characteristics (Duty Cycle).	14
6	Pulsed Emission Characteristics (Duty Cycle).	15
7	Intentional Emission Bandwidth.	17
7	Intentional Emission Bandwidth.	18
8	Conducted RF Power Plots	20
8	Conducted RF Power Plots	21
9	Power Spectral Density Plots.	23
9	Power Spectral Density Plots.	24
10	Conducted Transmitter Emissions Measured.	26
11	Accreditation Documents	28

1 Test Report Scope and Limitations

1.1 Laboratory Authorization

Test Facility description and attenuation characteristics are on file with the FCC Laboratory, Columbia, Maryland (FCC Reg. No: 90413) and with ISED Canada, Ottawa, ON (File Ref. No: IC3161). Amber Helm Development L.C. holds accreditation under NVLAP Lab Code 200129-0 and includes within its scope CFR Title 47 Part 15 Subparts B and C.

1.2 Report Retention

For equipment verified to comply with the regulations herein, the manufacturer is obliged to retain this report with the product records for the life of the product, and no less than ten years. A copy of this Report will remain on file with this laboratory until April 2028.

1.3 Subcontracted Testing

This report does not contain data produced under subcontract.

1.4 Test Data

This test report contains data included within the laboratories scope of accreditation.

1.5 Limitation of Results

The test results contained in this report relate only to the item(s) tested. Any electrical or mechanical modification made to the test item subsequent to the test date shall invalidate the data presented in this report. Any electrical or mechanical modification made to the test item subsequent to this test date shall require reevaluation.

1.6 Copyright

This report shall not be reproduced, except in full, without the written approval of Amber Helm Development L.C..

1.7 Endorsements

This report shall not be used to claim product endorsement by any accrediting, regulatory, or governmental agency.

1.8 Test Location

The EUT was fully tested by **Amber Helm Development L.C.**, 92723 Michigan Hwy-152, Sister Lakes, Michigan 49047 USA. Table 1 lists all sites employed herein. Specific test sites utilized are also listed in the test results sections of this report.

Table 1: Test Site List.

Description	Location	Quality Num.
OATS (3m & 10m)	92723 Michigan Hwy-152, Sister Lakes, Michigan 49047 USA	OATSA

1.9 Traceability and Equipment Used

Pertinent test equipment used for measurements at this facility is listed in Table 2. The quality system employed at Amber Helm Development L.C. has been established to ensure all equipment has a clearly identifiable classification, calibration expiry date, and that all calibrations are traceable to the SI through NIST, other recognized national laboratories, accepted fundamental or natural physical constants, ratio type of calibration, or by comparison to consensus standards.

Table 2: Equipment List.

Description	Manufacturer/Model	SN	Quality Num.	Last Cal By / Date Due
BiconiLog Antenna	EMCO / 3142	1169	BILO3142	Lib.Labs / May-2018
(3m) RG8 Coax	CS-3227 / CS-3227	C060914	CS3227	AHD / Sept-2018
EMI Receiver	HP / 85460A/85462A	3704A00422, 3807A00465	HP8546A	Techmaster / Apr-2018
(3m) LMR-400 Coax	AHD / LMR400	C090804	LMR400	AHD / Sept-2018
(LCI) DS Coax	AHD / RG58/U	920809	RG58U	AHD / Jul-2018
(10-m) Amelco Coax	AHD / RG213U	9903-10ab	RG213U	AHD / Sept-2018
Double Ridged Horn	EMCO / 3115	2788	RH3115	Lib.Labs. / July-2018
Double Ridged Horn	Cobham / H-1798	190	RHCOB1840	Lib.Labs. / Jul 2018

2 Test Specifications and Procedures

2.1 Test Specification and General Procedures

The ultimate goal of Allegion, PLC is to demonstrate that the Equipment Under Test (EUT) complies with the Rules and/or Directives below. Detailed in this report are the results of testing the Allegion, PLC BE489WB for compliance to:

Country/Region	Rules or Directive	Referenced Section(s)
United States	Code of Federal Regulations	CFR Title 47, Part 15.247
Canada	ISED Canada	IC RSS-247/GENe

It has been determined that the equipment under test is subject to the rules and directives above at the date of this testing. In conjunction with these rules and directives, the following specifications and procedures are followed herein to demonstrate compliance (in whole or in part) with these regulations.

ANSI C63.4:2014	"Methods of Measurement of Radio-Noise Emissions from Low-Voltage Electrical and Electronic Equipment in the Range of 9 kHz to 40 GHz"
ANSI C63.10:2013 (USA)	"American National Standard of Procedures for Compliance Testing of Unlicensed Wireless Devices"
TP0102RA	"AHD Internal Document TP0102 - Radiated Emissions Test Procedure"
ISED Canada	"The Measurement of Occupied Bandwidth"
ICES-003; Issue 6 (2016)	"Information Technology Equipment (ITE) Limits and methods of measurement"

3 Configuration and Identification of the Equipment Under Test

3.1 Description and Declarations

The EUT is wireless enabled electronic door lock. The EUT is approximately 10 x 7 x 5 cm in dimension, and is depicted in Figure 1. It is powered by 6 VDC alkaline batteries. This product is used as an electronic entry door latch with WLAN and BLE interfaces. Table 3 outlines provider declared EUT specifications.



Figure 1: Photos of EUT.

Table 3: EUT Declarations.

General Declarations			
Equipment Type:	Electronic Door Lock	Country of Origin:	USA
Nominal Supply:	6 VDC	Oper. Temp Range:	not declared
Frequency Range:	2402 – 2480 MHz	Antenna Dimension:	Integral
Antenna Type:	Integral	Antenna Gain:	Not Declared
Number of Channels:	40(BLE),11(WLAN)	Channel Spacing:	2 MHz(BLE), 5 MHz(WLAN)
Alignment Range:	Not Declared	Type of Modulation:	GFSK, OFDM
United States			
FCC ID Number:	XPB-Denali	Classification:	DTS
Canada			
IC Number:	8053B-Denali	Classification:	Spread Spectrum (24002483.5 MHz)

3.1.1 EUT Configuration

The EUT is configured for testing as depicted in Figure 2.

3.1.2 Modes of Operation

The EUT is capable of operating in BLE (1Mbps) or in 802.11 b, g, or n(20) modes. Test samples were placed into worst-case operating modes (highest data rate, highest operating power that may be employed) using a PC serial UART interface that could be attached and detached from the EUT. The EUT could not be placed into full continuous transmission, so duty cycle within each transmitted pulse is measured and applied to peak measured data.

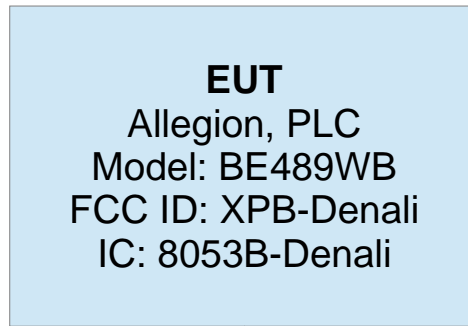

Figure 2: EUT Test Configuration Diagram.

3.1.3 Variants

There is only a single electrical version of the EUT, but there are two variants of the external housing (escutcheon). The BE489WB model may employ either escutcheon.

3.1.4 Test Samples

Two samples of the EUT were provided for emissions testing, one radiated sample and one sample for conducted measurements. The EUT can employ two different escutcheon faceplates, both of which were tested.

3.1.5 Functional Exerciser

Head unit functionality was verified by listening to broadcast audio and connecting the EUT to the N4010A Bluetooth test set. A speakers were attached to the load box on the +LR and +FR speaker terminals.

3.1.6 Modifications Made

There were no modifications made to the EUT by this laboratory. However, in order to bring the device into compliance with band edge emissions the manufacturer chose to have the maximum power setting on the WLAN chipset reduced from the maximum power setting level (1) down to a power setting level of 3. All products manufactured will be set with WLAN power setting level no lower than level 3.

3.1.7 Production Intent

The EUT appears to be a production ready sample.

3.1.8 Declared Exemptions and Additional Product Notes

None.

4 Emissions

4.1 General Test Procedures

4.1.1 Radiated Test Setup and Procedures

Radiated electromagnetic emissions from the EUT are first pre-scanned in our screen room. Spectrum and modulation characteristics of all emissions are recorded. Instrumentation, including spectrum analyzers and other test equipment as detailed in Section 1.8 are employed. After pre-scan, emission measurements are made on the test site of record. If the EUT connects to auxiliary equipment and is table or floor standing, the configurations prescribed in relevant test standards are followed. Alternatively, a layout closest to normal use (as declared by the provider) is employed if the resulting emissions appear to be worst-case in such a configuration. See Figure 3. All intentionally radiating elements that are not fixed-mounted in use are placed on the test table lying flat, on their side, and on their end (3-axes) and the resulting worst case emissions are recorded. If the EUT is fixed-mounted in use, measurements are made with the device oriented in the manner consistent with installation and then emissions are recorded. If the EUT exhibits spurious emissions due to internal receiver circuitry, such emissions are measured with an appropriate carrier signal applied.

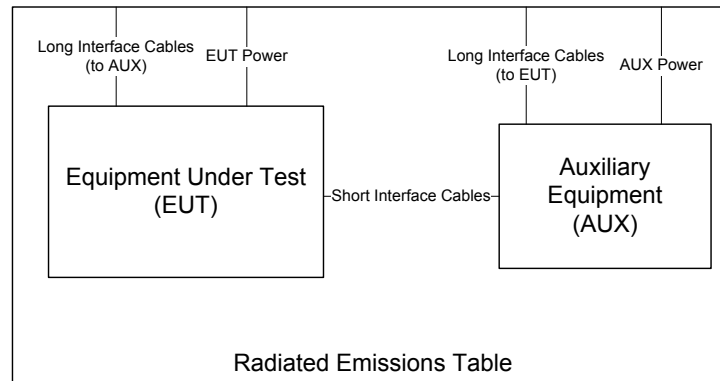

Figure 3: Radiated Emissions Diagram of the EUT.

For devices with intentional emissions below 30 MHz, a shielded loop antenna and/or E-field and H-Field broadband probes are used depending on the regulations. Shielded loops are placed at a 1 meter receive height at the desired measurement distance. For exposure in this band, the broadband probes employed are 10cm diameter single-axis shielded transducers and measurements are repeated and summed over three axes.

Emissions between 30 MHz and 1 GHz are measured using calibrated broadband antennas. For both horizontal and vertical polarizations, the test antenna is raised and lowered from 1 to 4 m in height until a maximum emission level is detected. The EUT is then rotated through 360° in azimuth until the highest emission is detected. The test antenna is then raised and lowered one last time from 1 to 4 m and the worst case value is recorded. Emissions above 1 GHz are characterized using standard gain or broadband ridge-horn antennas on our OATS with a 4×5 m rectangle of ECCOSORB absorber covering the OATS ground screen and a 1.5m table height. Care is taken to ensure that test receiver resolution and video bandwidths meet the regulatory requirements, and that the emission bandwidth of the EUT is not reduced. Photographs of the test setup employed are depicted in Figure 4.

Where regulations allow for direct measurement of field strength, power values (dBm) measured on the test receiver / analyzer are converted to $\text{dB}\mu\text{V}/\text{m}$ at the regulatory distance, using

$$E_{dist} = 107 + P_R + K_A - K_G + K_E - C_F$$

where P_R is the power recorded on spectrum analyzer, in dBm, K_A is the test antenna factor in dB/m, K_G is the combined pre-amplifier gain and cable loss in dB, K_E is duty correction factor (when applicable) in dB, and C_F is a distance conversion (employed only if limits are specified at alternate distance) in dB. This field strength value is then compared with the regulatory limit. If effective isotropic radiated power (EIRP) is computed, it is computed as

$$EIRP(\text{dBm}) = E_{3m}(\text{dB}\mu\text{V}/\text{m}) - 95.2.$$

When presenting data at each frequency, the highest measured emission under all possible EUT orientations (3-axes) is reported.

Where regulations call for substitution method measurements, the EUT is replaced by a substitution antenna if field strength measurements indicate the emission is close to the regulatory limit. This antenna is co-polarized with the test antenna and tuned (when necessary) to the emission frequency, after which the test antenna height is again optimized. The substitution antenna's signal level is adjusted such that its emission is equal to the level measured from the EUT. The signal level applied to the substitution antenna is then recorded. Effective isotropic radiated power (EIRP) and effective radiated power (ERP) in dBm are formulated from

$$EIRP = P_T - G_A = ERP + 2.16, \quad (1)$$

where P_T is the power applied to substitution antenna in dBm, including correction for cable loss, and G_A is the substitution antenna gain, in dBi.

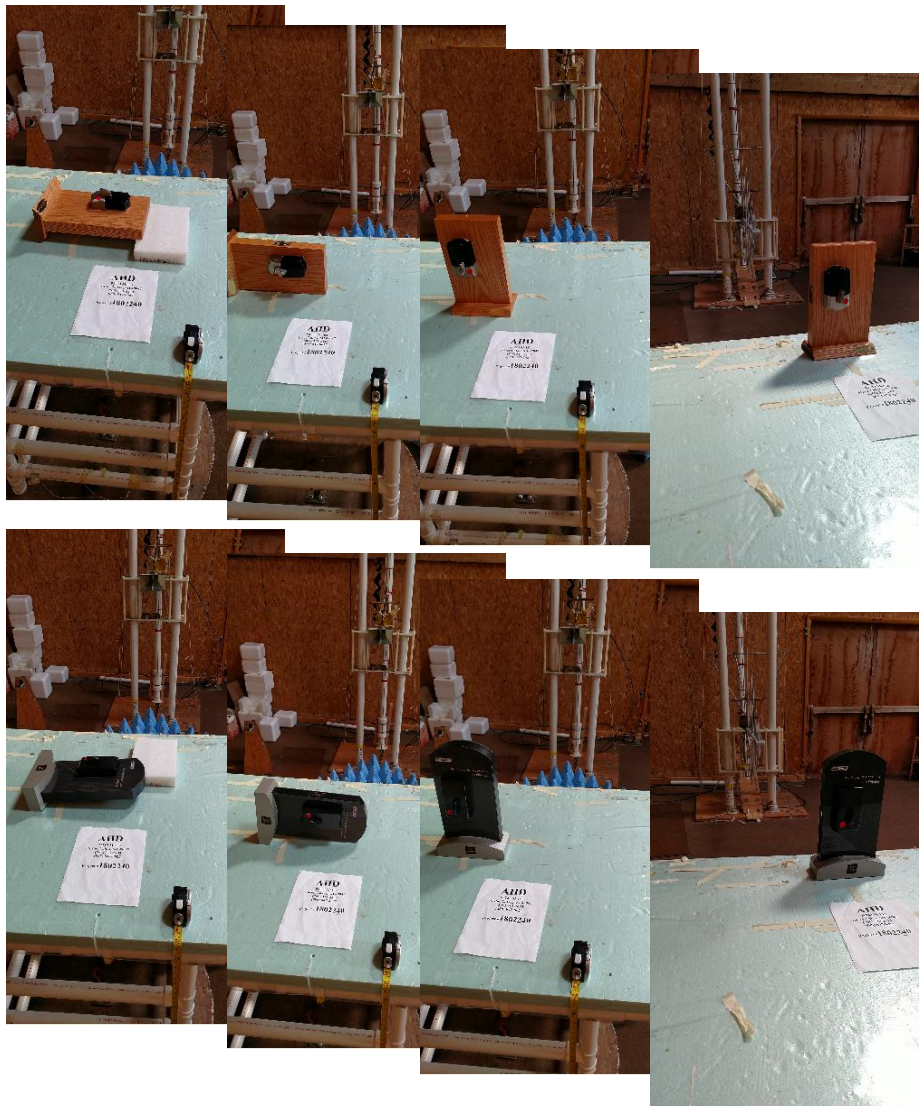

Figure 4: Radiated Emissions Test Setup Photograph(s).

4.1.2 Conducted Emissions Test Setup and Procedures

Transmit Antenna Port Conducted Emissions At least one sample EUT supplied for testing was provided with a 50Ω antenna port. Conducted transmit chain emissions measurements (where applicable) are made by connecting the EUT antenna port directly to the test receiver port. Photographs of the test setup employed are depicted in Figure 5.

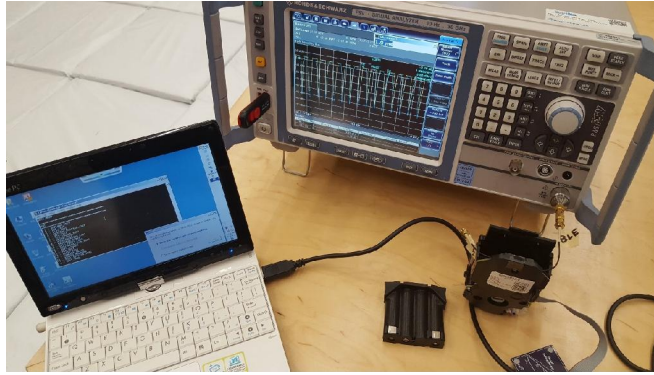

Figure 5: Conducted RF Test Setup Photograph(s).

Battery Power Conducted Spurious The EUT is not subject to measurement of power line conducted emissions as it is powered solely by its internal battery.

4.1.3 Power Supply Variation

Tests at extreme supply voltages are made if required by the the procedures specified in the test standard, and results of this testing are detailed in this report.

In the case the EUT is designed for operation from a battery power source, the extreme test voltages are evaluated over the range specified in the test standard; no less than $\pm 10\%$ of the nominal battery voltage declared by the manufacturer. For all battery operated equipment, worst case intentional and spurious emissions are re-checked employing a new (fully charged) battery.

4.2 Intentional Emissions

4.2.1 Duty and Transmission Cycle, Pulsed Operation

The details and results of testing the EUT for pulsed operation are summarized in Table 4.

Table 4: Pulsed Emission Characteristics (Duty Cycle).

Frequency Range	Det	IFBW	VBW	Test Date:	28-Apr-18
f > 1 000 MHz	Pk	1 MHz	28 MHz	Test Engineer:	Joseph Brunett
f > 1 000 MHz	Pk	28 MHz	28 MHz	EUT	Allegion Denali
				Meas. Distance:	Conducted

Pulsed Operation / Duty Cycle						
Transmit Mode	Data Rate (Mbps)	Voltage (V)	Oper. Freq (MHz)	1 MHz RBW Duty Within Pulse (dB)	RBW > OBW Duty Within Pulse (dB)	Worst Case Duty Factor (dB)
BLE	1.0	6.0	2440.0	0.0	0.4	0.0
802.11b	11.0	6.0	2437.0	6.2	2.1	2.1
802.11g	54.0	6.0	2437.0	11.6	11.2	11.2
802.11n(20)	72.2	6.0	2437.0	9.4	11.5	9.4

* Duty Cycle is measured in line with DTS procedures section 12.2.5.1 for averaging only over full-power transmission pulses.

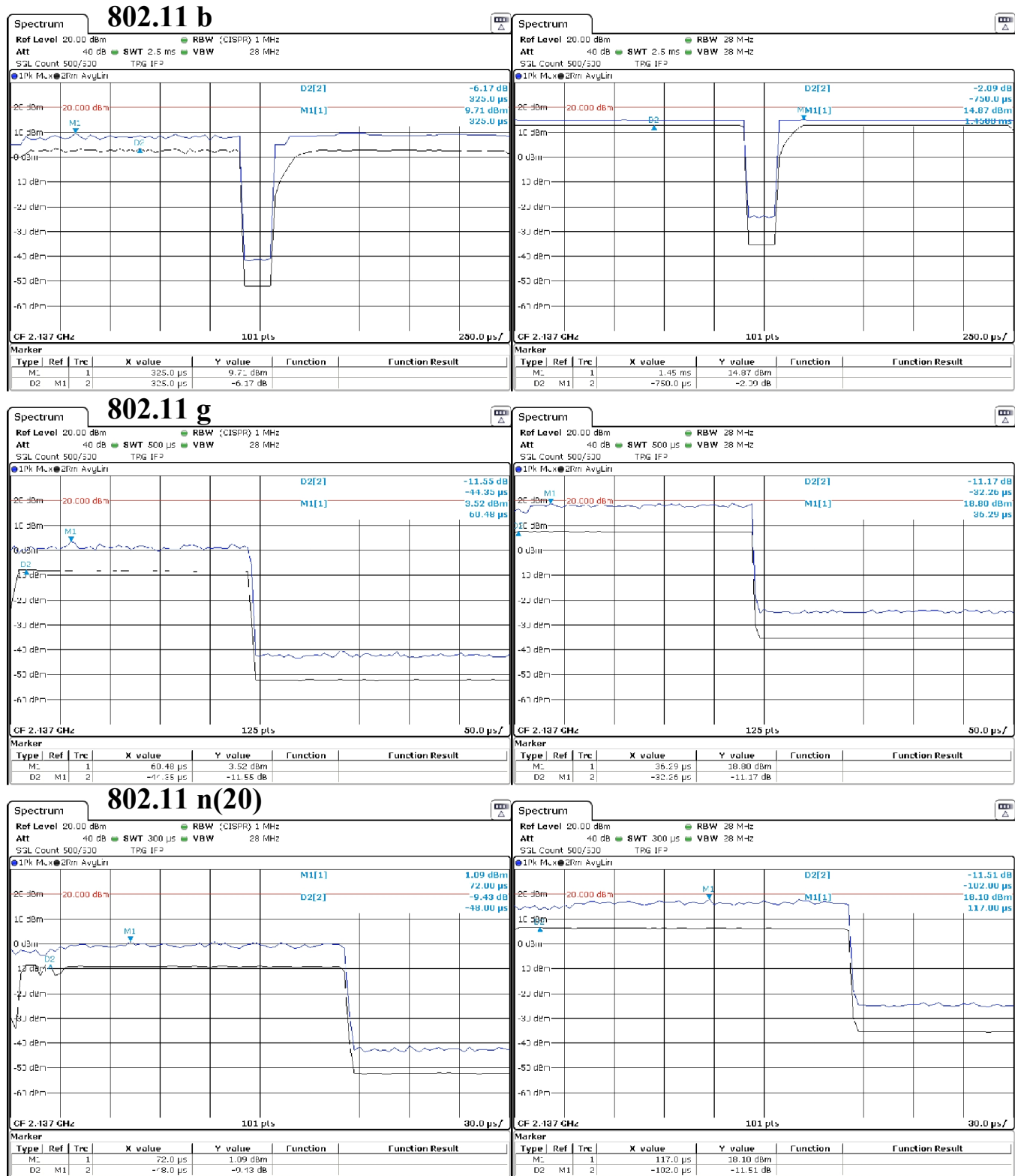

Figure 6(a): Pulsed Emission Characteristics (Duty Cycle).

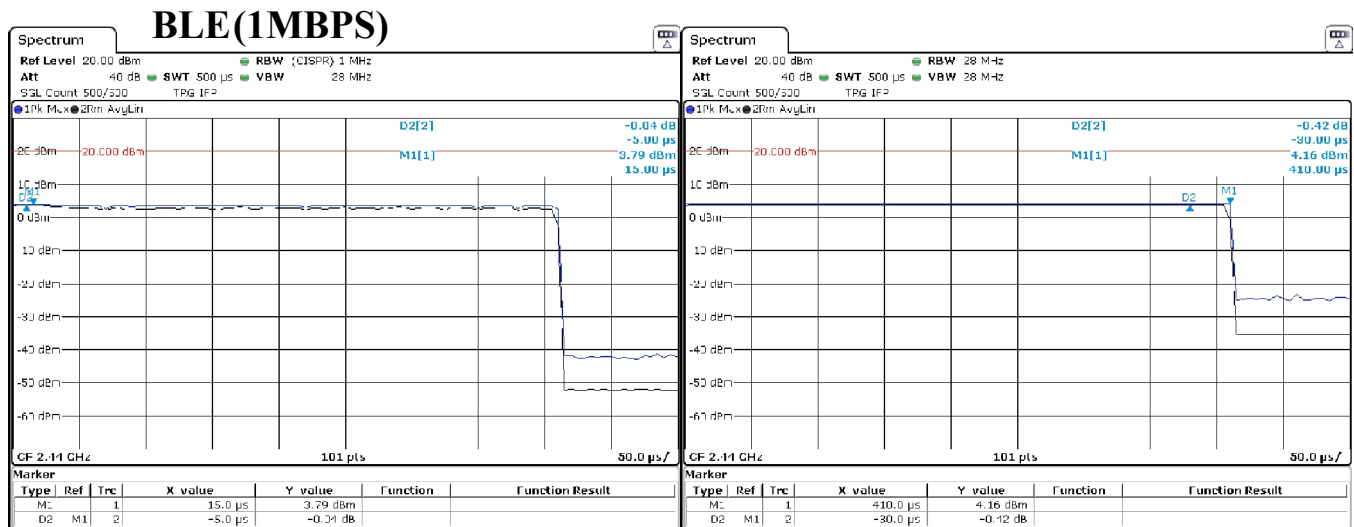

Figure 6(b): Pulsed Emission Characteristics (Duty Cycle).

4.2.2 Fundamental Emission Bandwidth

Emission bandwidth (EBW) of the EUT is measured with the device placed in the test mode(s) with the shortest available packet length and minimum packet spacing. Radiated emissions are recorded following the test procedures listed in Section 2.1. The 6 dB bandwidth is measured for the lowest, middle, and highest channels available. The 99% emission bandwidth per IC test procedures is also reported. The results of this testing are summarized in Table 5. Plots showing measurements employed obtain the emission bandwidths reported are provided in Figure 7.

Table 5: Intentional Emission Bandwidth.

Frequency Range
f > 1 000 MHz

Det Pk
IFBW 30 kHz
VBW 100 kHz

Test Date: 04/28/17
Test Engineer: Joseph Brunett
EUT: Allegion Denali
Meas. Distance: Conducted

Occupied Bandwidth								
Transmit Mode	Data Rate* (Mbps)	Voltage (V)	Oper. Freq (MHz)	6 dB BW (MHz)	6 dB BW Limit (MHz)	99% OBW (MHz)	20 dB BW (MHz)	Pass/Fail
BLE	1.0	6.0	2402.0	0.60	0.50	1.28	1.32	Pass
			2440.0	0.64	0.50	1.35	1.40	Pass
			2480.0	0.66	0.50	1.08	1.17	Pass
802.11b	11.0	6.0	2412.0	10.50	0.50	14.34	16.78	Pass
			2437.0	10.02	0.50	14.34	16.86	Pass
			2462.0	10.21	0.50	14.34	16.76	Pass
802.11g	54.0	6.0	2412.0	16.60	0.50	17.43	20.60	Pass
			2437.0	16.83	0.50	17.53	21.87	Pass
			2462.0	16.66	0.50	17.53	20.75	Pass
802.11n(20)	72.2	6.0	2412.0	17.90	0.50	18.58	22.75	Pass
			2437.0	17.91	0.50	18.73	22.75	Pass
			2462.0	18.03	0.50	18.63	21.38	Pass

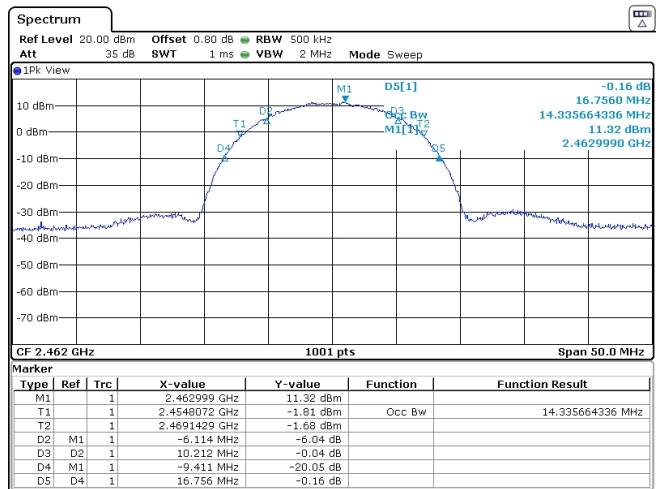
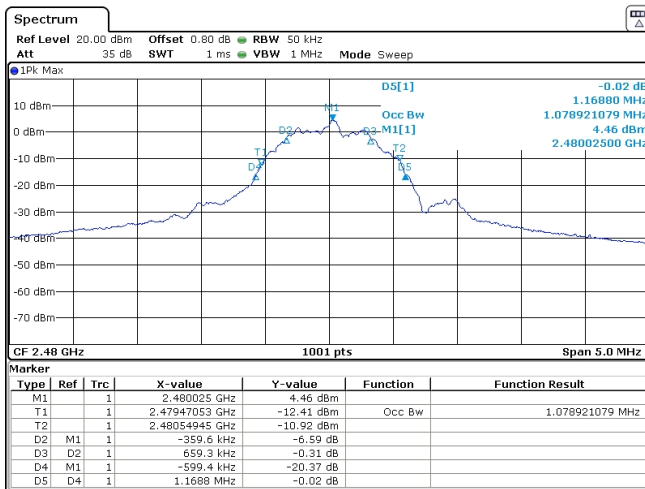
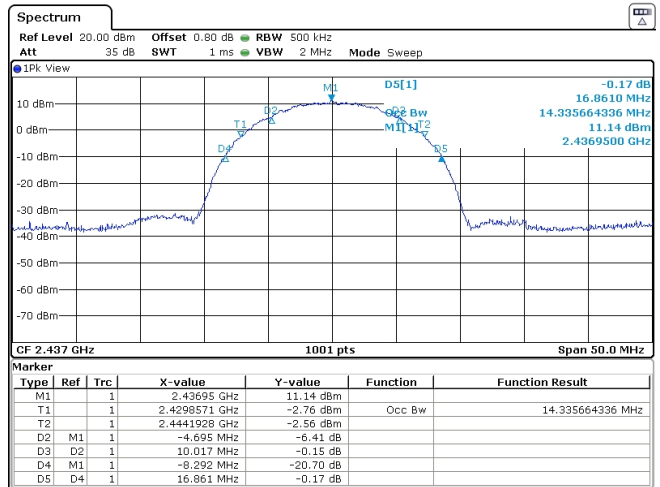
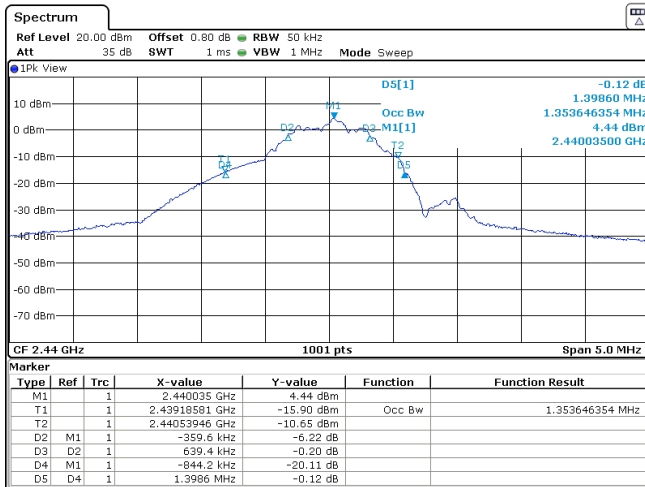
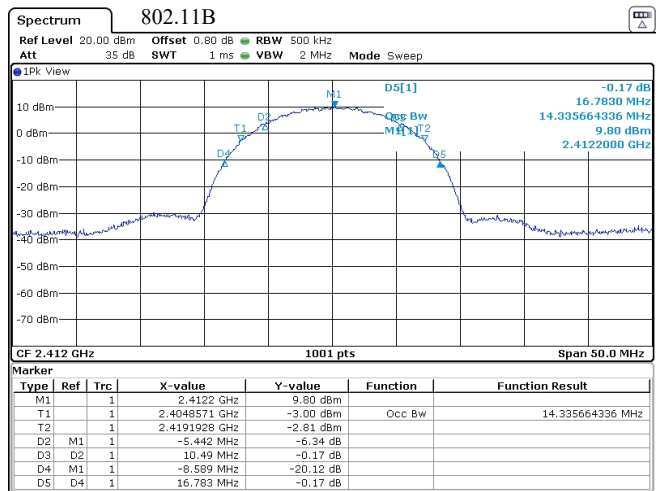
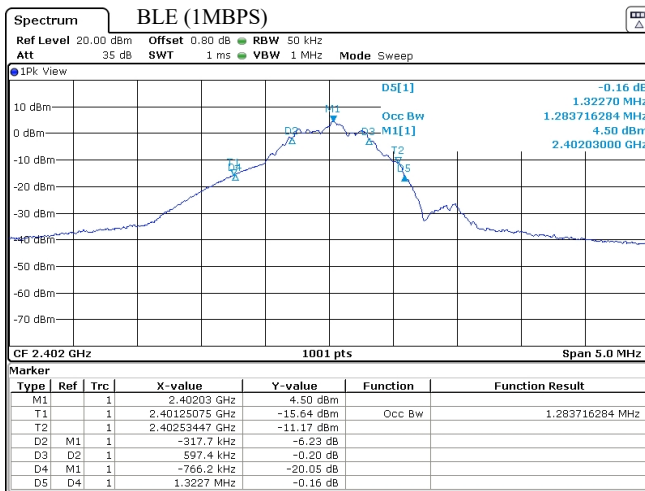

Figure 7(a): Intentional Emission Bandwidth.

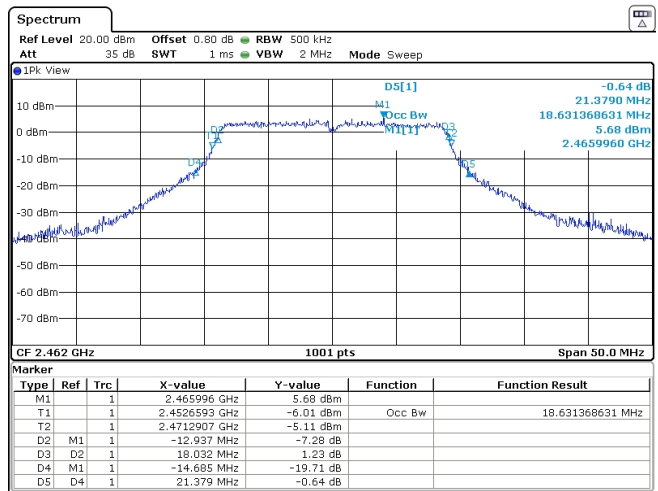
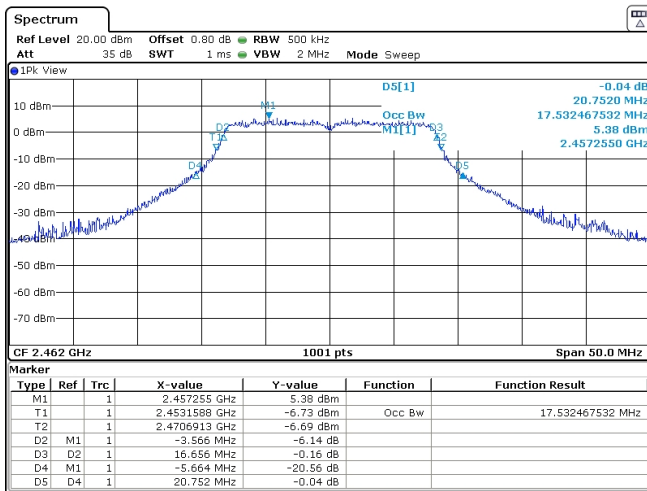
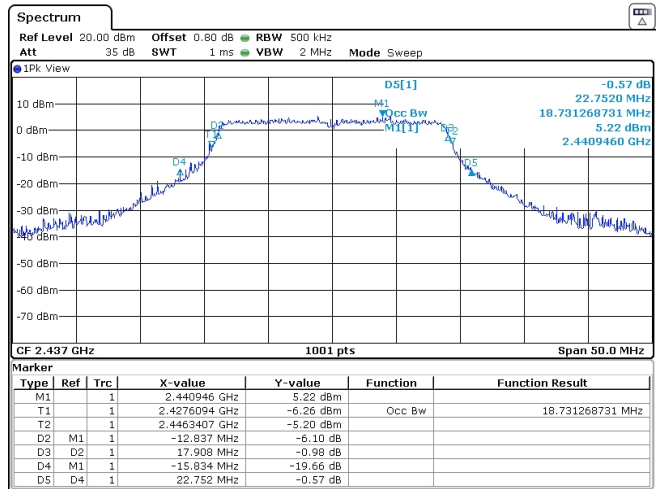
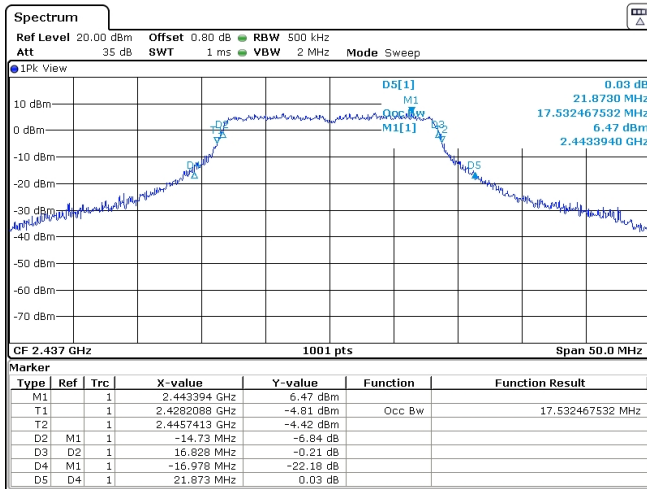
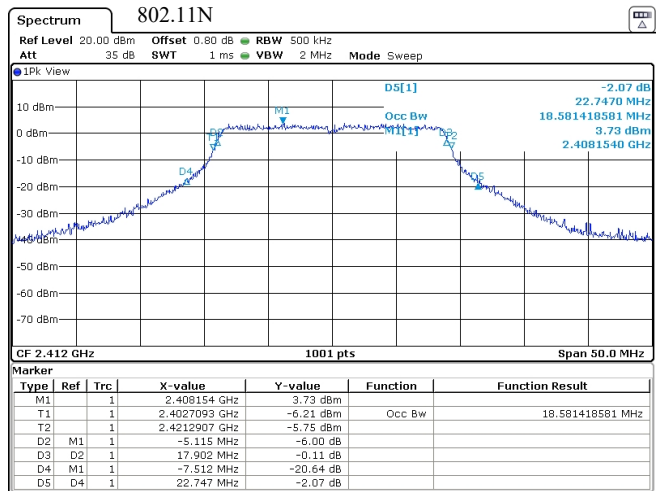
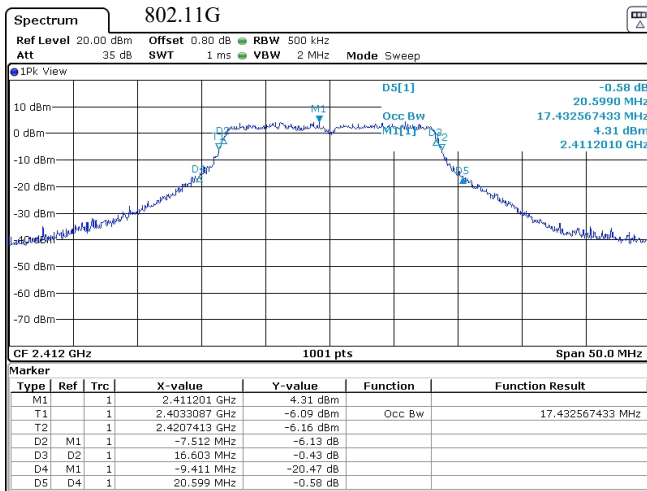

Figure 7(b): Intentional Emission Bandwidth.

4.2.3 Effective Isotropic Radiated Power

The EUT’s radiated power is computed from antenna port conducted power measurements and the gain of the EUT antenna(s). Where the EUT is not sold with an antenna connector, a modified product has been provided including such. Peak conducted output power was measured directly from the EUT at the port where the antenna attaches. The test receiver bandwidth was set to be greater than the measured emission bandwidth of the EUT to capture the true peak. Antenna gain is either provided directly by the antenna manufacturer or measured by comparison between calculated EIRP and conducted output power. Table 6 details the results of these measurements. Plots showing conducted measurements made are depicted in Figure 8.

Table 6: Radiated Power Results.

Frequency Range f > 1 000 MHz	Det Pk/Avg	IF Bandwidth 3 MHz	Video Bandwidth 10 MHz	Mode BLE	Test Date: 04/11/2018, 05/21/2018
f > 1 000 MHz	Pk/Avg	28 MHz	28 MHz	WLAN	Test Engineer: G. Helm, J. Brunett
					EUT: Allegion Denali
					Meas. Distance: 3m

FCC/IC

#	Mode	Channel	Freq. MHz	Ant. Used	Ant. Pol.	Table Azim. deg	Ant Height m	Ka dB/m	Kg dB	E3(Pk)** dBµV/m	EIRP (Pk) dBm	Pout* (Pk) dBm	Ant Gain dBi	EIRP (Avg) Limit dBm	Pass dB
1	BLE (CW) Square Chassis	L	2402.0	RH3115	H/V	30.0	2.0	28.9	-2.3	92.5	-2.7	3.9	-6.6		
2		M	2440.0	RH3115	H/V	30.0	2.0	29.0	-2.4	94.6	-6	-0.6	0.0		
3		H	2480.0	RH3115	H/V	30.0	2.0	29.1	-2.4	93.8	-1.4	-1.1	-0.3		
4	BLE (CW) Round Chassis	L	2402.0	RH3115	H/V	30.0	2.0	28.9	-2.3	92.1	-3.1	3.9	-7.0		
5		M	2440.0	RH3115	H/V	30.0	2.0	29.0	-2.4	93.5	-1.7	-0.6	-1.1		
6		H	2480.0	RH3115	H/V	30.0	2.0	29.1	-2.4	93.8	-1.4	-1.1	-0.3		
7	WLAN (CW) – B/G/N Square Chassis	L	2412.0	RH3115	H/V	290.0	2.0	28.9	-2.4	114.6	19.4	20.0	-0.6		
8		M	2437.0	RH3115	H/V	290.0	2.0	29.0	-2.4	112.7	17.5	20.2	-2.7		
9		H	2462.0	RH3115	H/V	290.0	2.0	29.1	-2.4	111.1	15.9	20.0	-4.1		
10	WLAN (CW) B/G/N Round Chassis	L	2412.0	RH3115	H/V	290.0	2.0	28.9	-2.4	113.9	18.7	20.0	-1.3		
11		M	2437.0	RH3115	H/V	290.0	2.0	29.0	-2.4	112.4	17.2	20.2	-3.0		
12		H	2462.0	RH3115	H/V	290.0	2.0	29.1	-2.4	111.0	15.8	20.0	-4.2		
#	Mode	Channel	Freq. MHz	Ant. Used	Ant. Pol.	Table Azim. deg	Ant Height m	Ka dB/m	Kg dB	E3(Pk)** dBµV/m	EIRP (Pk) dBm	Pout* (Pk) dBm	Ant Gain dBi	EIRP (Avg) Limit dBm	Pass dB
13	BLE (1MBPS) MODULATED SQUARE CHASSIS	L	2402.0								-2.7	3.9	-6.6	30.0	32.7
14		M	2440.0								4.0	4.0	0.0	30.0	26.0
15		H	2480.0									3.6	3.9	-0.3	30.0
16	WLAN 11B MODULATED SQUARE CHASSIS	L	2402.0								14.6	15.2	-0.6	30.0	15.4
17		M	2440.0								12.7	15.4	-2.7	30.0	17.4
18		H	2480.0								11.1	15.2	-4.1	30.0	18.9
19	WLAN 11G MODULATED SQUARE CHASSIS	L	2412.0								18.4	19.0	-0.6	30.0	11.6
20		M	2437.0								17.0	19.7	-2.7	30.0	13.0
21		H	2462.0								15.0	19.1	-4.1	30.0	15.0
22	WLAN 11N MODULATED SQUARE CHASSIS	L	2412.0								17.7	18.3	-0.6	30.0	12.3
23		M	2437.0								16.4	19.1	-2.7	30.0	13.6
24		H	2462.0								15.0	19.1	-4.1	30.0	15.0

* Measured conducted from the radio using conducted test sample. Peak power measured with IFBW > OBW in line with DTS Meas. Procedures Section 9.1.1 (ANSI C63.10 11.9.1.1).

(Note: IFBW & VBW maximum bandwidth of 28 MHz >> OBW available on Spectrum Analyzer only in zero span mode.) VBW = IFBW gives accurate results as IFBW >> OBW.

** Measured radiated at 3 meter distance.

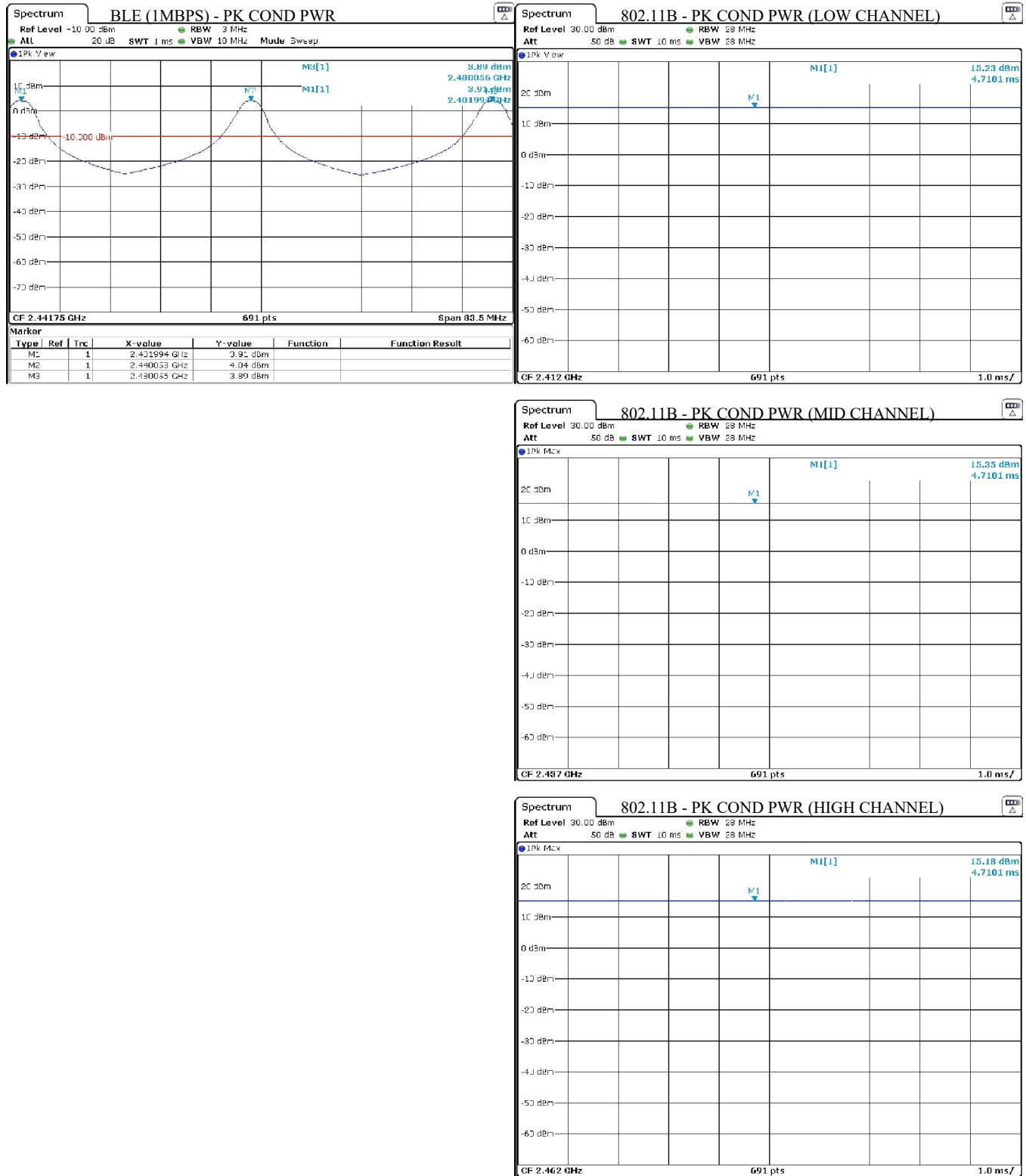

Figure 8(a): Conducted RF Power Plots



Figure 8(b): Conducted RF Power Plots

4.2.4 Power Spectral Density

For this test, the EUT was attached directly to the test receiver. Following FCC DTS measurement procedures, the emission spectrum is first scanned for maximum spectral peaks, the span and receiver bandwidth are then reduced until the power spectral density is measured in the prescribed receiver bandwidth. The results of this testing are summarized in Table 7. Plots showing how these measurements were made are depicted in Figure 9.

Table 7: Power Spectral Density Results.

Frequency Range: 2400-2483.5
Detector: Pk
IF Bandwidth: 3 kHz
Video Bandwidth: 10 kHz
Test Date: 28-Apr-18
Test Engineer: Joseph Brunett
EUT: Allegion Denali
Meas. Distance: Conducted

FCC/IC						
Mode	Channel	Frequency (MHz)	Ant. Used	PSDcond (meas)* (dBm/3kHz)	PSD Limit (dBm/3kHz)	Pass By (dB)
BLE	L	2402.0	Cond.	-10.8	8.00	18.8
	M	2441.0	Cond.	-10.8	8.00	18.8
	H	2480.0	Cond.	-10.9	8.00	18.9
802.11b	L	2402.0	Cond.	-8.7	8.00	16.7
	M	2441.0	Cond.	-8.5	8.00	16.5
	H	2480.0	Cond.	-7.8	8.00	15.8
802.11g	L	2402.0	Cond.	-16.5	8.00	24.5
	M	2441.0	Cond.	-14.3	8.00	22.3
	H	2480.0	Cond.	-15.3	8.00	23.3
802.11n(20)	L	2402.0	Cond.	-17.8	8.00	25.8
	M	2441.0	Cond.	-15.6	8.00	23.6
	H	2480.0	Cond.	-15.6	8.00	23.6

* PSD measured conducted out the the EUT antenna port following FCC DTS PKPSD procedure.

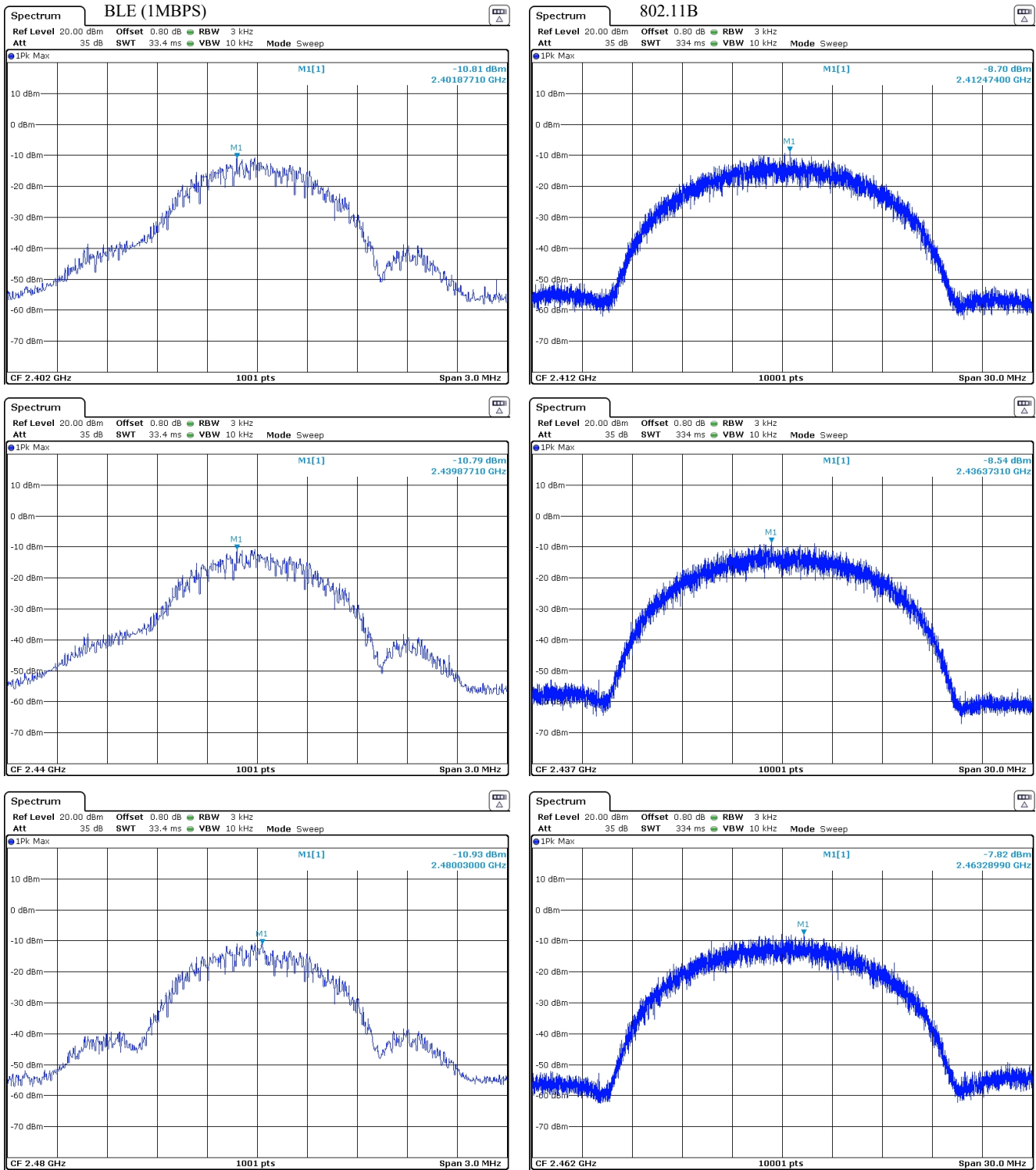

Figure 9(a): Power Spectral Density Plots.

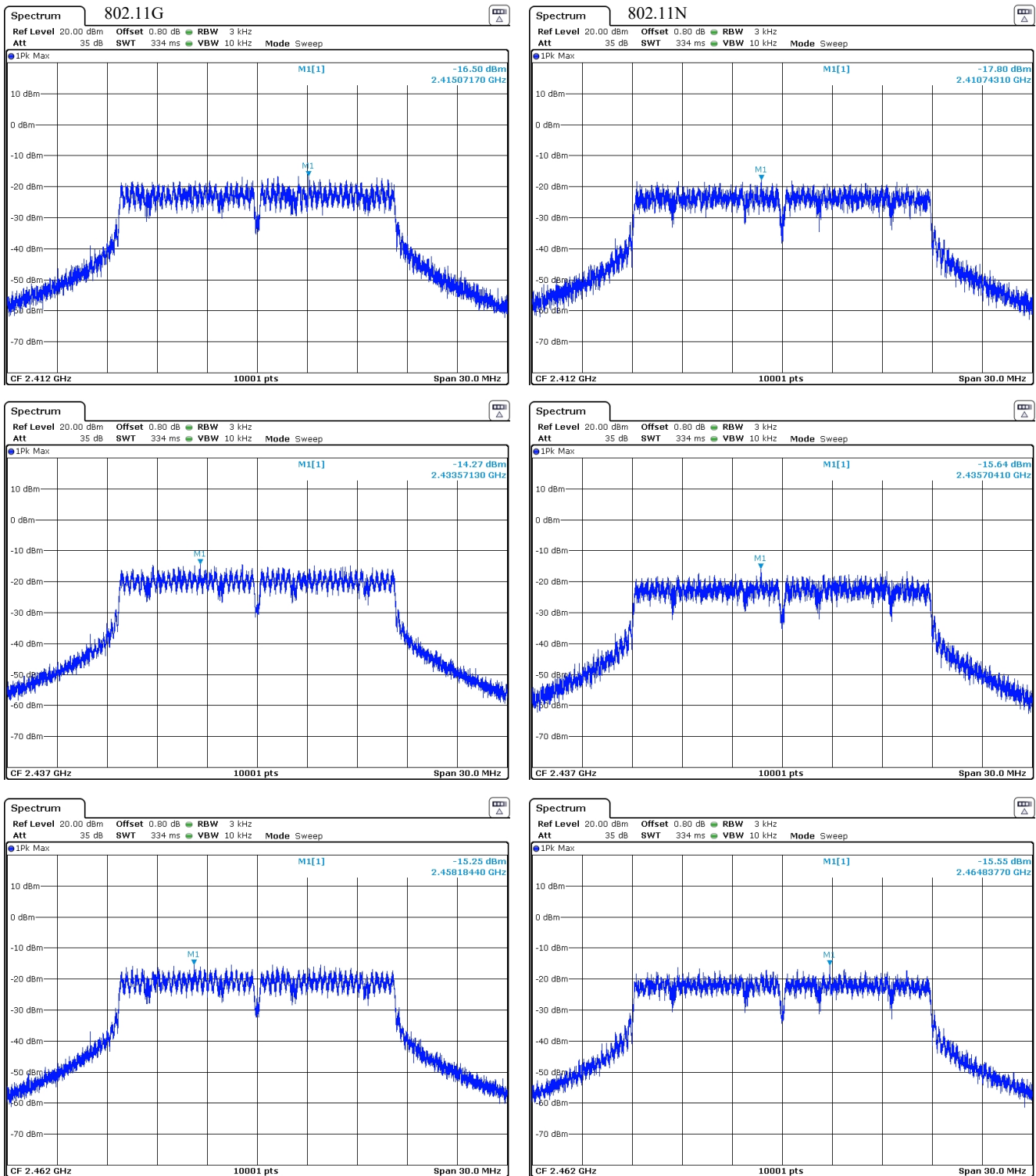

Figure 9(b): Power Spectral Density Plots.

4.3 Unintentional Emissions

4.3.1 Transmit Chain Spurious Emissions

The results for the measurement of transmit chain spurious emissions at the nominal voltage and temperature are provided in Table 8. Measurements are performed to 10 times the highest fundamental operating frequency.

Table 8(a): Transmit Chain Spurious Emissions.

Frequency Range 25 MHz f 1 000 MHz f > 1 000 MHz	Det Pk/QPk Pk/Avg	IF Bandwidth 120 kHz 1 MHz	Video Bandwidth 300 kHz 3 MHz	Test Date: 11-Apr-18
				Test Engineer: G. Helm, J. Brunett
				EUT: Allegion Denali
				Mode: BLE
				Meas. Distance: 3m

FCC/IC															
#	Mode	Freq. Start MHz	Freq. Stop MHz	Ant. Used	Ant. Pol.	Table Azim. deg	Ant Height m	Ka dB/m	Kg dB	E3(Pk) dBµV/m	E3 Pk Lim dBµV/m	E3(Avg) dBµV/m	E3 Avg Lim dBµV/m	Pass dB	Comments
1	Fundamental Restricted Band Edge (Low Side)														
2	CW	2390.0	2390.0	RH3115	H/V	10	2.2	28.9	-2.3	40.9	74.0	40.6	54.0	13.4	max L,M,H channels; all orientations
3	Fundamental Restricted Band Edge (High Side)														
4	CW	2483.5	2483.5	RH3115	H/V	30	2.2	29.1	-2.4	51.8	74.0	51.5	54.0	2.5	max L,M,H channels; all orientations
5	Harmonic Emissions														
6	CW	4804.0	4804.0	RH3115	H/V	280	2.0	33.1	-3.5	39.0	74.0	38.7	54.0	15.3	CH Low; all orientations
7	CW	4882.0	4805.0	RH3115	H/V	280	2.0	33.1	-3.6	39.0	74.0	38.7	54.0	15.3	CH Low; all orientations
8	CW	4960.0	4806.0	RH3115	H/V	280	2.0	33.1	-3.6	40.0	74.0	39.7	54.0	14.3	CH High; all orientations
9	CW	4000.0	6000.0	RH3115	H/V	280	2.0	35.0	-3.1	40.0	74.0	39.7	54.0	14.3	max L,M,H channels; all orientations
10	CW	6000.0	8400.0	RH3115	H/V	all	all	37.6	-4.1	41.8	74.0	41.5	54.0	12.5	max all
11	CW	8400.0	12500.0	RH3115	H/V	all	all	40.5	-4.9	38.8	74.0	38.5	54.0	15.5	max all, noise
12	CW	12500.0	18000.0	RH3115	H/V	all	all	45.2	-6.1	41.1	74.0	40.8	54.0	13.2	max all, noise
13	CW	18000.0	26000.0	RHCOB1840	H/V	all	all	53.0	-7.4	37.3	74.0	37.0	54.0	17.0	max all, noise
14															
15															

*Avg band edge and harmonic levels computed from Pk measurement minus duty cycle.

Table 8(b): Transmit Chain Spurious Emissions.

Frequency Range 25 MHz f 1 000 MHz f > 1 000 MHz	Det Pk/QPk Pk/Avg	IF Bandwidth 120 kHz 1 MHz	Video Bandwidth 300 kHz 3 MHz	Test Date: 11-Apr-18
				Test Engineer: G. Helm, J. Brunett
				EUT: Allegion Denali
				Mode: BLE
				Meas. Distance: 3m

FCC/IC															
#	Mode	Freq. Start MHz	Freq. Stop MHz	Ant. Used	Ant. Pol.	Table Azim. deg	Ant Height m	Ka dB/m	Kg dB	E3(Pk) dBµV/m	E3 Pk Lim dBµV/m	E3(Avg)* dBµV/m	E3 Avg Lim dBµV/m	Pass dB	Comments
1	Fundamental Restricted Band Edge (Low Side)														
2	11B	2390.0	2390.0	RH3115	H/V	290	2.2	28.9	-2.3	52.3	74.0	50.2	54.0	3.8	max L,M,H channels; all orientations
3	11G	2390.0	2390.0	RH3115	H/V	250	2.4	28.9	-2.3	52.7	74.0	41.5	54.0	12.5	max L,M,H channels; all orientations
4	11N	2390.0	2390.0	RH3115	H/V	250	2.4	28.9	-2.3	51.7	74.0	42.3	54.0	11.7	max L,M,H channels; all orientations
5															
6	Fundamental Restricted Band Edge (High Side)														
7	11B	2483.5	2483.5	RH3115	H/V	290	2.2	29.1	-2.4	53.2	74.0	51.1	54.0	2.9	max L,M,H channels; all orientations
8	11G	2483.5	2483.5	RH3115	H/V	290	2.2	29.1	-2.4	50.8	74.0	39.6	54.0	14.4	max L,M,H channels; all orientations
9	11N	2483.5	2483.5	RH3115	H/V	40	2.7	29.1	-2.4	53.9	74.0	44.5	54.0	9.5	max L,M,H channels; all orientations
10															
11	Harmonic Emissions														
12	All	4824.0	4804.0	RH3115	H/V	280	2.0	33.1	-3.5	49.9	74.0	47.8	54.0	6.2	CH Low, max all modes, all orientations
13		4874.0	4805.0	RH3115	H/V	280	2.0	33.1	-3.6	51.2	74.0	49.1	54.0	4.9	CH Mid, max all modes, all orientations
14		4924.0	4806.0	RH3115	H/V	280	2.0	33.1	-3.6	50.3	74.0	48.2	54.0	5.8	CH High, max all modes, all orientations
15		4000.0	6000.0	RH3115	H/V	all	all	35.0	-3.1	51.2	74.0	49.1	54.0	4.9	
16		7236.0	7236.0	RH3115	H/V	all	all	36.8	-4.5	45.9	74.0	43.8	54.0	10.2	CH Low, max all modes, all orientations
17		6000.0	8400.0	RH3115	H/V	all	all	37.6	-4.1	45.9	74.0	43.8	54.0	10.2	all channels; max all modulations
18		8400.0	12500.0	RH3115	H/V	all	all	40.5	-4.9	48.9	74.0	46.8	54.0	7.2	max all, noise
19		12500.0	18000.0	RH3115	H/V	all	all	45.2	-6.1	50.1	74.0	48.0	54.0	6.0	max all, noise
20		18000.0	26000.0	RHCOB1840	H/V	all	all	53.0	-7.4	50.0	74.0	47.9	54.0	6.1	max all, noise
21															
22															

*Avg band edge and harmonic levels computed from Pk measurement minus duty cycle.

4.3.2 Relative Transmit Chain Spurious Emissions

The results for the measurement of transmit chain spurious emissions relative to the fundamental in a 100 kHz receiver bandwidth (at the nominal voltage and temperature) are provided in Figure 10 below.

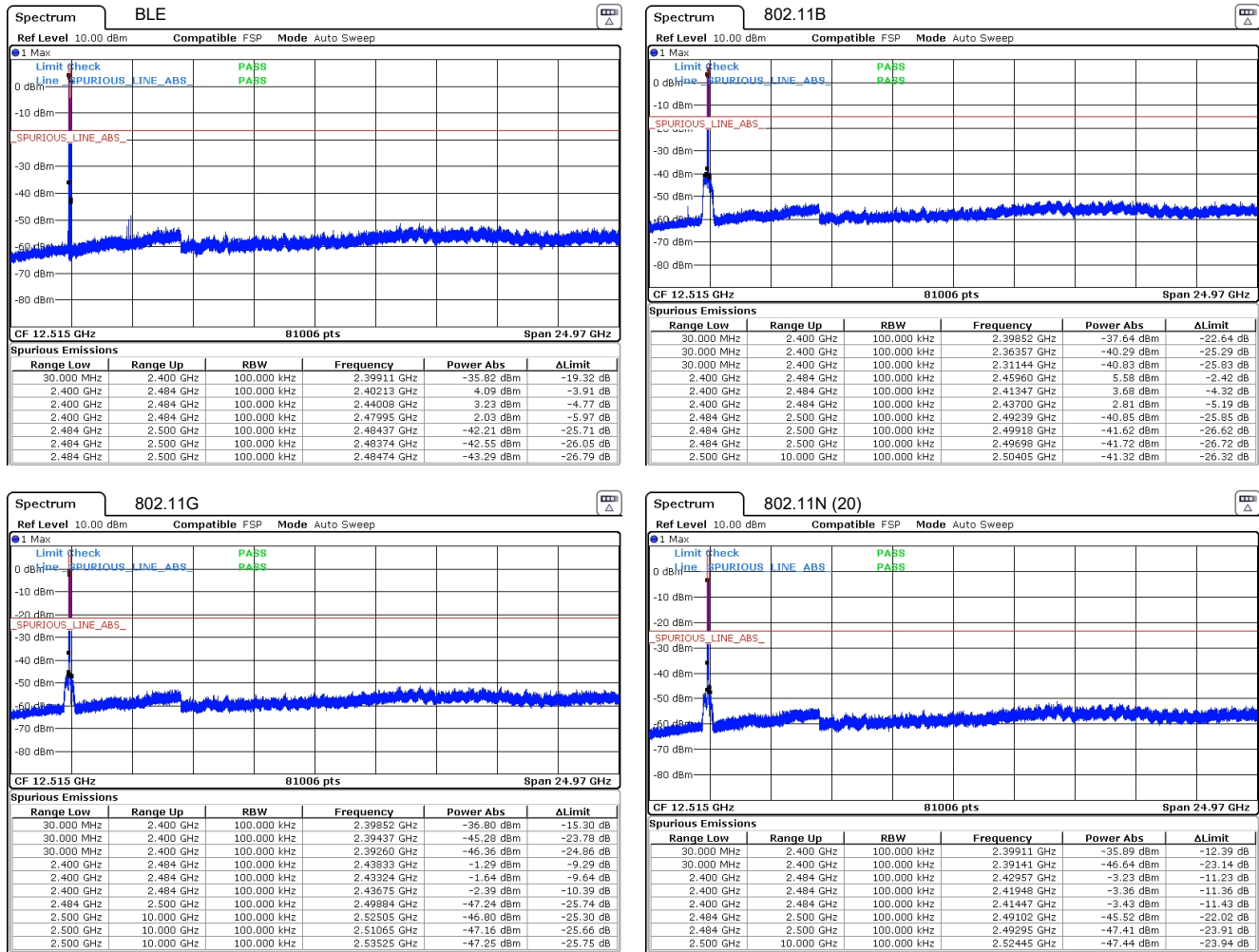

Figure 10: Conducted Transmitter Emissions Measured.

4.3.3 General Radiated Spurious

The results for the measurement of general spurious emissions (emissions arising from digital circuitry) at the nominal voltage and temperature are provided in Table 9. Radiation from digital components are measured up to 1000 MHz or to the highest frequency required by the applied standards, whichever is greater.

Table 9: Radiated Digital Spurious Emissions.

Frequency Range	Det	IF Bandwidth	Video Bandwidth	Test Date:	11-Apr-18
25 MHz f 1 000 MHz	Pk/QPk	120 kHz	300 kHz	Test Engineer:	Gordon Helm
f > 1 000 MHz	Pk	1 MHz	3 MHz	EUT:	Allegion Denali
				EUT Mode:	Active
				Meas. Distance:	3 meters

Digital Spurious Emissions													FCC/IC
#	Freq. MHz	Ant. Used	Ant. Pol.	Table Azim. deg	Ant Height m	Ka dB/m	Kg dB	E3(Pk) dBµV/m	E3(QPk/Avg) dBµV/m	FCC/IC E3lim (Pk) dBµV/m	FCC/IC E3lim (Qpk/Avg) dBµV/m	Pass dB	Comments
1	79.0	BILO3142	H	10.0	1.7	8.0	-5	37.1	31.7	60.0	40.0	8.3	background
2	81.0	BILO3142	V	250.0	1.0	7.9	-5	33.5	28.1	60.0	40.0	11.9	background
3	109.0	BILO3142	H	10.0	1.7	7.2	-6	25.8	19.2	63.5	43.5	24.3	
4	109.0	BILO3142	V	10.0	1.7	7.2	-6	23.4	16.8	63.5	43.5	26.7	
5	257.0	BILO3142	V	240.0	1.0	15.6	-1.0	19.6	12.6	66.0	46.0	33.4	
6	260.0	BILO3142	H	230.0	1.8	15.8	-1.0	17.2	12.2	66.0	46.0	33.8	
7													
8	No other spurious emissions observed within 20 dB of the regulatory limit.												
9													

5 Measurement Uncertainty and Accreditation Documents

The maximum values of measurement uncertainty for the laboratory test equipment and facilities associated with each test are given in the table below. This uncertainty is computed for a 95.45% confidence level based on a coverage factor of $k = 2$.

Table 10: Measurement Uncertainty.

Measured Parameter	Measurement Uncertainty [†]
Radio Frequency Conducted Emm. Amplitude	$\pm(f_{Mkr}/10^7 + RBW/10 + (SPN/(PTS - 1))/2 + 1 \text{ Hz})$ $\pm 1.9 \text{ dB}$
Radiated Emm. Amplitude (30 – 200 MHz)	$\pm 4.0 \text{ dB}$
Radiated Emm. Amplitude (200 – 1000 MHz)	$\pm 5.2 \text{ dB}$
Radiated Emm. Amplitude ($f > 1000 \text{ MHz}$)	$\pm 3.7 \text{ dB}$

[†]Ref: CISPR 16-4-2:2011+A1:2014

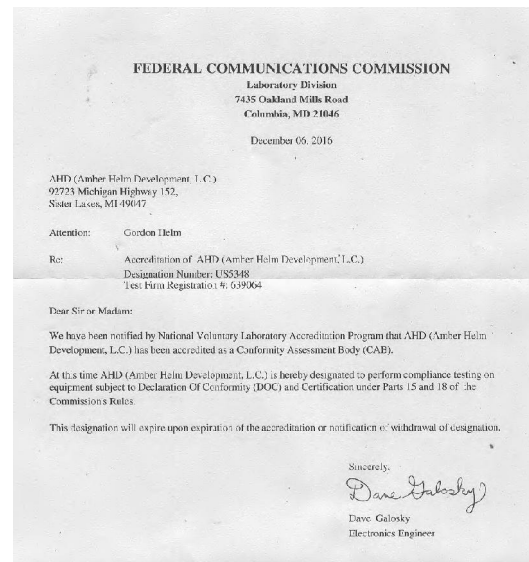

Figure 11: Accreditation Documents