

# Cabinet Host Emissions Report

regarding

**USA: FCC CFR 47, Subpart B (Emissions)**  
**Canada: ISED ICES-003 (Emissions)**

for

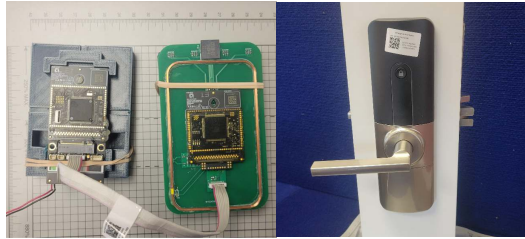

## Host Lockset w/ Modules

Category: Electronic Door Access System

Judgments:

**Compliant with FCC Part 15 Class B Spurious + ISED RSS-GEN**

Testing Completed: May 15, 2023



Prepared for:

## Allegion

11819 North Pennsylvania Street, Carmel Indiana 46032 USA

Phone: +1 (317) 810-3700, Fax: +1 (317) 810-3051

Contact: Frank Nardelli, Frank.Nardelli@allegion.com

Data Rec./Rev. by:

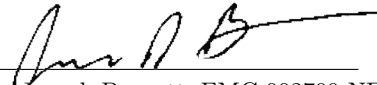
  
Dr. Joseph Brunett, EMC-002790-NE

Rpt. Auth. by:

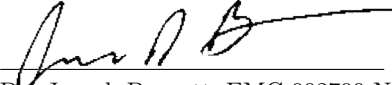
  
Dr. Joseph Brunett, EMC-002790-NE

Rpt. Prep./Rev. by:

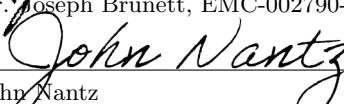
  
John Nantz

Date of Issue:

May 19, 2023

## Revision History

Rev. No.	Date	Details	Revised By
r0	May 19, 2023	Initial Release.	J. Brunett

## Contents

<b>Revision History</b>	<b>2</b>
<b>Table of Contents</b>	<b>2</b>
<b>1 Test Report Scope and Limitations</b>	<b>4</b>
1.1 Laboratory Authorization . . . . .	4
1.2 Report Retention . . . . .	4
1.3 Subcontracted Testing . . . . .	4
1.4 Test Data . . . . .	4
1.5 Limitation of Results . . . . .	4
1.6 Copyright . . . . .	4
1.7 Endorsements . . . . .	4
1.8 Test Location . . . . .	5
1.9 Traceability and Equipment Used . . . . .	5
<b>2 Test Specifications and Procedures</b>	<b>6</b>
2.1 Test Specification and General Procedures . . . . .	6
<b>3 Configuration and Identification of the Equipment Under Test</b>	<b>7</b>
3.1 Description and Declarations . . . . .	7
3.1.1 EUT Configuration . . . . .	8
3.1.2 Modes of Operation . . . . .	8
3.1.3 Variants . . . . .	9
3.1.4 Test Samples . . . . .	9
3.1.5 Functional Exerciser . . . . .	9
3.1.6 Modifications Made . . . . .	9
3.1.7 Production Intent . . . . .	9
3.1.8 Declared Exemptions and Additional Product Notes . . . . .	9
<b>4 Emissions</b>	<b>10</b>
4.1 General Test Procedures . . . . .	10
4.1.1 Radiated Test Setup and Procedures . . . . .	10
4.1.2 Conducted Emissions Test Setup and Procedures . . . . .	12
4.1.3 Power Supply Variation . . . . .	12
4.2 Unintentional Emissions . . . . .	13
4.2.1 General Radiated Spurious . . . . .	13
<b>5 Measurement Uncertainty and Accreditation Documents</b>	<b>17</b>

**List of Tables**

1	Test Site List. . . . .	5
2	Equipment List. . . . .	5
3	EUT Declarations. . . . .	7
4	Radiated Spurious Emissions. . . . .	13
4	Radiated Spurious Emissions. . . . .	14
4	Radiated Spurious Emissions. . . . .	15
4	Radiated Spurious Emissions. . . . .	16
4	Radiated Spurious Emissions. . . . .	16
4	Radiated Spurious Emissions. . . . .	16
5	Measurement Uncertainty. . . . .	17

**List of Figures**

1	Photos of EUT. . . . .	7
2	EUT Test Configuration Diagram. . . . .	8
3	Radiated Emissions Diagram of the EUT. . . . .	10
4	Radiated Emissions Test Setup Photograph(s). . . . .	11
5	Accreditation Documents . . . . .	17

## **1 Test Report Scope and Limitations**

### **1.1 Laboratory Authorization**

Test Facility description and attenuation characteristics are on file with the FCC Laboratory, Columbia, Maryland (FCC Reg. No: US5348 and US5356) and with ISED Canada, Ottawa, ON (File Ref. No: 3161A and 24249). Amber Helm Development L.C. holds accreditation under NVLAP Lab Code 200129-0.

### **1.2 Report Retention**

For equipment verified to comply with the regulations herein, the manufacturer is obliged to retain this report with the product records for the life of the product, and no less than ten years. A copy of this Report will remain on file with this laboratory until June 2033.

### **1.3 Subcontracted Testing**

This report does not contain data produced under subcontract.

### **1.4 Test Data**

This test report contains data included within the laboratory's scope of accreditation. Any data in this report that is not covered under the laboratory's scope is clearly identified.

### **1.5 Limitation of Results**

The test results contained in this report relate only to the item(s) tested. Any electrical or mechanical modification made to the test item subsequent to the test date shall invalidate the data presented in this report. Any electrical or mechanical modification made to the test item subsequent to this test date shall require reevaluation.

### **1.6 Copyright**

This report shall not be reproduced, except in full, without the written approval of Amber Helm Development L.C.

### **1.7 Endorsements**

This report shall not be used to claim product endorsement by any accrediting, regulatory, or governmental agency.

## 1.8 Test Location

The EUT was fully tested by **Amber Helm Development L.C.**, headquartered at 92723 Michigan Hwy-152, Sister Lakes, Michigan 49047 USA. Table 1 lists all sites employed herein. Specific test sites utilized are also listed in the test results sections of this report where needed.

Table 1: Test Site List.

Description	Location	Quality Num.
OATS (3 meter)	3615 E Grand River Rd., Williamston, Michigan 48895	OATSC

## 1.9 Traceability and Equipment Used

Pertinent test equipment used for measurements at this facility is listed in Table 2. The quality system employed at Amber Helm Development L.C. has been established to ensure all equipment has a clearly identifiable classification, calibration expiry date, and that all calibrations are traceable to the SI through NIST, other recognized national laboratories, accepted fundamental or natural physical constants, ratio type of calibration, or by comparison to consensus standards.

Table 2: Equipment List.

Description	Manufacturer/Model	SN	Quality Num.	Cal/Ver By / Date Due
Spectrum Analyzer	R & S / FSV30	101660	RSFSV30001	RS / Apr-2024
Spectrum Analyzer	R & S / FPC1500	101692	RSFPC15001	RS / Dec-2023
BNC-BNC Coax	WRTL / RG58/U	001	CAB001-BLACK	AHD / Sept-2023
3.5-3.5MM Coax	PhaseFlex / PhaseFlex	001	CAB015-PURP	AHD / Sept-2023
Biconical	EMCO / 93110B	9802-3039	BICEMCO01	Keysight / Aug-2023
Log Periodic Antenna	EMCO / 3146	9305-3614	LOGEMCO01	Keysight / Aug-2023
Quad Ridge Horn	Singer / A6100	C35200	HQR1TO18S01	Keysight / Aug-2024
K-Band Horn	JEF / NRL Std.	001	HRNK01	AHD / Jul-2023

## 2 Test Specifications and Procedures

### 2.1 Test Specification and General Procedures

The goal of Allegion is to demonstrate that the Equipment Under Test (EUT) complies with the Rules and/or Directives below. Detailed in this report are the results of testing the Allegion Host Lockset w/ Modules for compliance to:

Country/Region	Rules or Directive	Referenced Section(s)
United States	Code of Federal Regulations	FCC CFR 47, Subpart B
Canada	ISED Canada	ISED ICES-003

It has been determined that the equipment under test is subject to the rules and directives above at the date of this testing. In conjunction with these rules and directives, the following specifications and procedures are followed herein to demonstrate compliance (in whole or in part) with these regulations.

ANSI C63.4:2014	"Methods of Measurement of Radio-Noise Emissions from Low-Voltage Electrical and Electronic Equipment in the Range of 9 kHz to 40 GHz"
TP0102RA	"AHD Internal Document TP0102 - Radiated Emissions Test Procedure"
ICES-003; Issue 7 (2020)	"Information Technology Equipment (ITE) - Limits and methods of measurement"

### 3 Configuration and Identification of the Equipment Under Test

#### 3.1 Description and Declarations

The EUT is battery powered wireless electronic door lock. The EUT is approximately 22x13x15 cm in dimension, and is depicted in Figure 1. It is powered by 6 VDC alkaline batteries. This product is used as an electronic door entry system. Table 3 outlines provider declared EUT specifications.



Figure 1: Photos of EUT.

Table 3: EUT Declarations.

General Declarations	
<b>Equipment Type:</b>	Electronic Door Access System
<b>Country of Origin:</b>	Not Declared
<b>Nominal Supply:</b>	6 VDC
<b>Oper. Temp Range:</b>	Not Declared
United States	
<b>FCC ID Number:</b>	Contains: XPB-47446672, XPB-47334317
<b>Classification:</b>	Host Device
Canada	
<b>IC Number:</b>	Contains: 8053B-47446672, 8053B-47334317
<b>Classification:</b>	Host Device

### 3.1.1 EUT Configuration

The EUT is configured for testing as depicted in Figure 2.

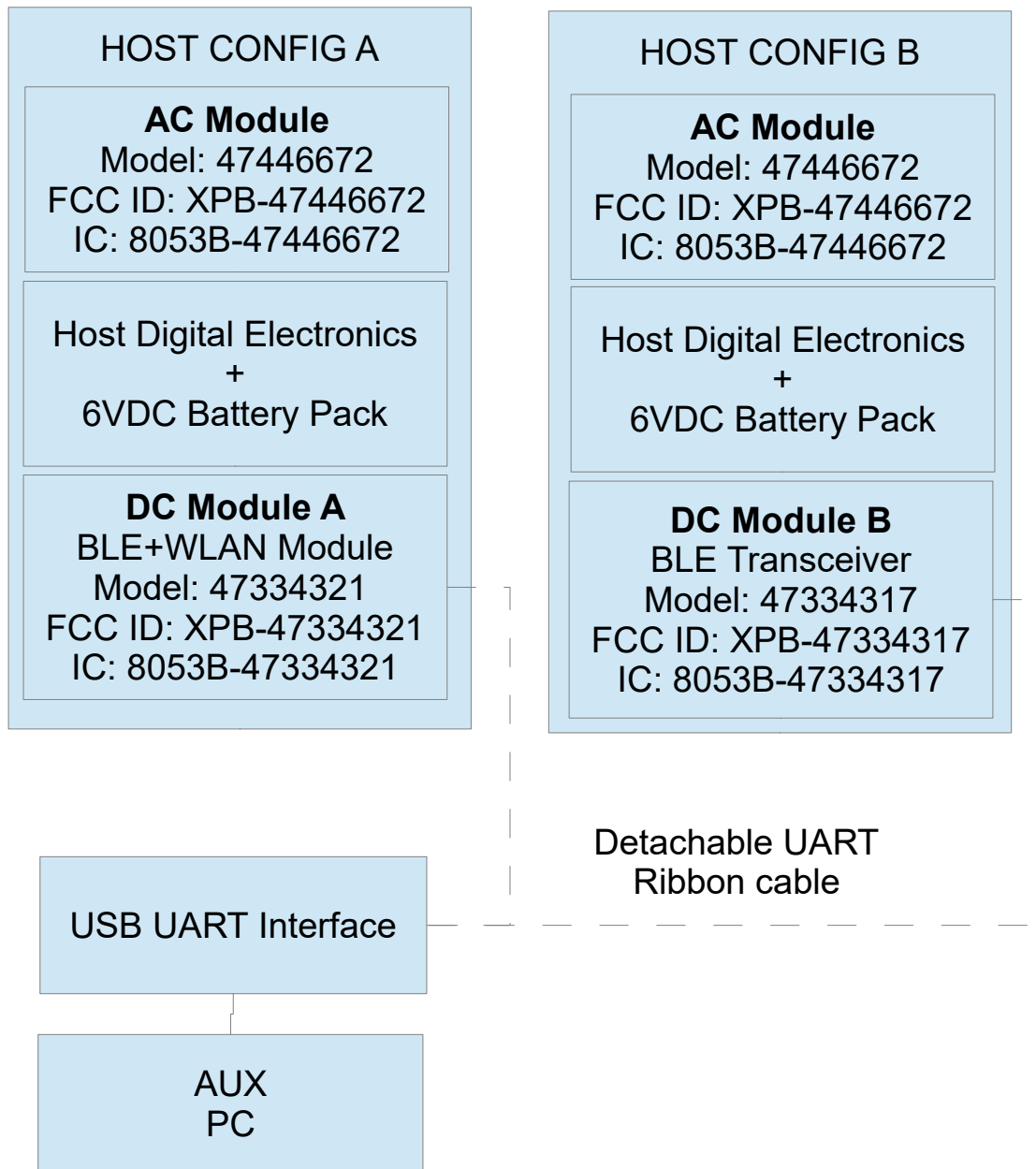

Figure 2: EUT Test Configuration Diagram.

### 3.1.2 Modes of Operation

The host EUT (and subsequently just the bare host PCB) was populated with a pair of radio modules prior to testing. Each radio module was placed into continuous transmitting mode via its respective PC UART interfaces / special programming tag prior to spurious digital and intermodulation emissions testing. The results of each co-located host configuration are reported herein.



### **3.1.3 Variants**

This report details spurious emissions from the manufacturer's Digital Core modules, FCC ID: XPB-47334321, IC: 8053B-47334321 and FCC ID: XPB-47334317, IC: 8053B-47334317 when co-located in a host product with the manufacturer's Access Core module, FCC ID: XPB-47446672, IC: 8053B-47446672 (and in turn its depopulated variant FCC ID: XPB-47446668, IC: 8053B-47446668).

### **3.1.4 Test Samples**

One normal operating sample of the host chassis was provided for emissions testing along with samples of each radio module detailed herein. The host chassis was populated with both digital core (DC) wireless radio modules as well as the most populated access core (AC) tag reading radio module. Each DC + AC pairing was evaluated for both spurious digital emissions as well as potential intermodulation components. Further measurements were made with each pair of modules assembled on the host PCB in the absence of the host chassis. This was determined to be the worst case condition for both scenarios.

### **3.1.5 Functional Exerciser**

Normal functionality was confirmed by measurement of transmitted signals.

### **3.1.6 Modifications Made**

There were no modifications made to the EUTs by this laboratory.

### **3.1.7 Production Intent**

The EUT appears to be a production ready sample.

### **3.1.8 Declared Exemptions and Additional Product Notes**

The host was populated with both a module for reading access cards to actuate the mechanical door lock feature (exterior/front side) and BLE/WLAN transceiver module for access tracking (interior/back side). The access card reader and the BLE/WLAN transceivers employed in this host are both seeking modular certification. In compliance with FCC KDB 996369 D04 Module Integration Guide v02, the overall host system spurious emissions were evaluated in this report with each radio module pair actively transmitting.

## 4 Emissions

### 4.1 General Test Procedures

#### 4.1.1 Radiated Test Setup and Procedures

Radiated electromagnetic emissions from the EUT are first pre-scanned in our screen room. Spectrum and modulation characteristics of all emissions are recorded. Instrumentation, including spectrum analyzers and other test equipment as detailed in Section 1.8 are employed. After pre-scan, emission measurements are made on the test site of record. If the EUT connects to auxiliary equipment and is table or floor standing, the configurations prescribed in relevant test standards are followed. Alternatively, a layout closest to normal use (as declared by the provider) is employed if the resulting emissions appear to be worst-case in such a configuration. See Figure 3. All intentionally radiating elements that are not fixed-mounted in use are placed on the test table lying flat, on their side, and on their end (3-axes) and the resulting worst case emissions are recorded. If the EUT is fixed-mounted in use, measurements are made with the device oriented in the manner consistent with installation and then emissions are recorded. If the EUT exhibits spurious emissions due to internal receiver circuitry, such emissions are measured with an appropriate carrier signal applied.

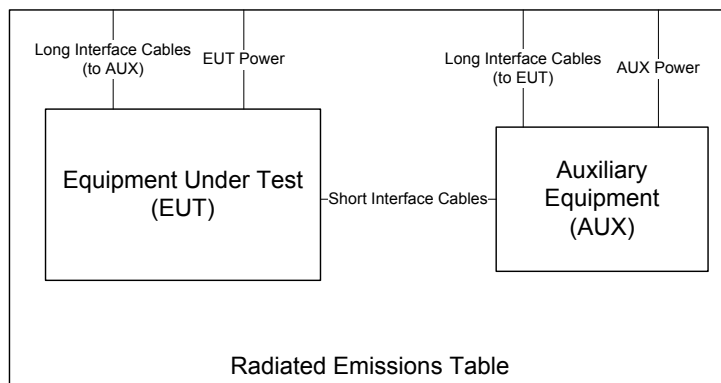

Figure 3: Radiated Emissions Diagram of the EUT.

For devices with intentional emissions below 30 MHz, a shielded loop antenna and/or E-field and H-Field broadband probes are used depending on the regulation. Shielded loops are placed at a 1 meter receive height at the desired measurement distance. For exposure in this band, 10cm diameter single-axis broadband probes meeting the requirements of ISED SPR-002 section 5.2 are employed. Measurements are repeated and summed over three axes, and the entire frequency range is measured with and without the EUT transmitting.

Emissions between 30 MHz and 1 GHz are measured using calibrated broadband antennas. For both horizontal and vertical polarizations, the test antenna is raised and lowered from 1 to 4 m in height until a maximum emission level is detected. The EUT is then rotated through  $360^\circ$  in azimuth until the highest emission is detected. The test antenna is then raised and lowered one last time from 1 to 4 m and the worst case value is recorded. Emissions above 1 GHz are characterized using standard gain or broadband ridge-horn antennas on our OATS with a  $4 \times 5$  m rectangle of ECCOSORB absorber covering the OATS ground screen and a 1.5m table height. Care is taken to ensure that test receiver resolution and video bandwidths meet the regulatory requirements, and that the emission bandwidth of the EUT is not reduced. Photographs of the test setup employed are depicted in Figure 4.

Where regulations allow for direct measurement of field strength, power values (dBm) measured on the test receiver / analyzer are converted to  $\text{dB}\mu\text{V}/\text{m}$  at the regulatory distance, using

$$E_{dist} = 107 + P_R + K_A - K_G + K_E - C_F$$

where  $P_R$  is the power recorded on spectrum analyzer, in dBm,  $K_A$  is the test antenna factor in dB/m,  $K_G$  is the combined pre-amplifier gain and cable loss in dB,  $K_E$  is duty correction factor (when applicable) in dB, and  $C_F$  is a distance conversion (employed only if limits are specified at alternate distance) in dB. This field strength value is then compared with the regulatory limit. If effective isotropic radiated power (EIRP) is computed, it is computed as

$$EIRP(\text{dBm}) = E_{3m}(\text{dB}\mu\text{V}/\text{m}) - 95.2.$$

When presenting data at each frequency, the highest measured emission under all possible EUT orientations (3-axes) is reported.

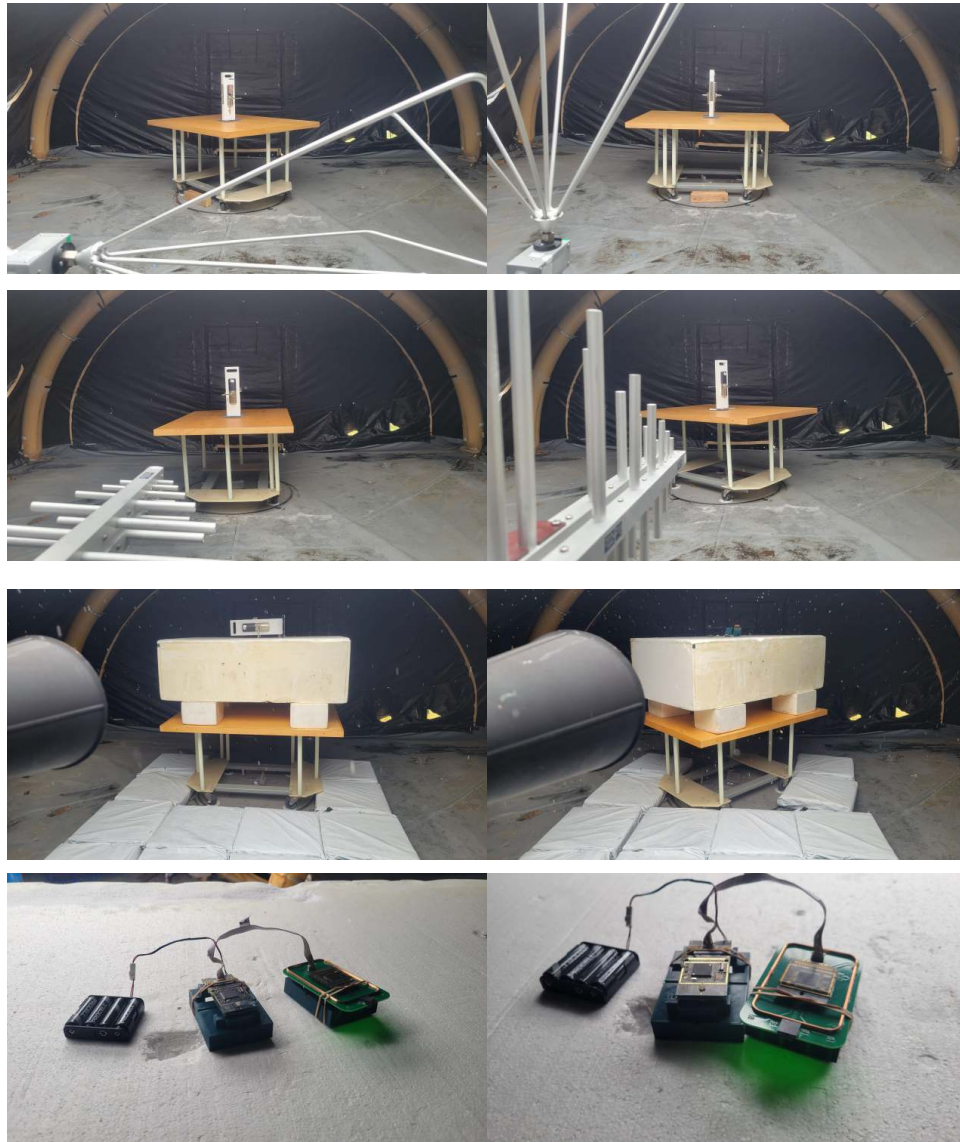

Figure 4: Radiated Emissions Test Setup Photograph(s).

#### **4.1.2 Conducted Emissions Test Setup and Procedures**

The EUT is not subject to measurement of power line conducted emissions as it is powered solely by its internal battery.

#### **4.1.3 Power Supply Variation**

Tests at extreme supply voltages are made if required by the procedures specified in the test standard, and results of this testing are detailed in this report.

Power supply variation testing was not performed for this device.

## 4.2 Unintentional Emissions

### 4.2.1 General Radiated Spurious

The results for the measurement of general spurious emissions (emissions arising from digital circuitry) at the nominal voltage and temperature are provided in Table 4. Radiation from digital components are measured up to 1000 MHz or to the highest frequency required by the applied standards, whichever is greater.

Table 4(a): Radiated Spurious Emissions.

<b>Frequency Range</b>	<b>Det</b>	<b>F Bandwidth</b>	<b>Video Bandwidth</b>	<b>Test Date:</b>	16-Dec-22
25 MHz ≤ f ≤ 1 000 MHz	Pk/QPk	120 kHz	300 kHz	<b>Test Engineer:</b>	J. Brunett
f > 1 000 MHz	Pk	1 MHz	3 MHz	<b>EUT:</b>	Allegion DC+AC Active
f > 1 000 MHz	Avg/RMS	1 MHz	3 MHz	<b>EUT Mode:</b>	Active (reading card)
				<b>Meas. Distance:</b>	3 m
				<b>Temperature:</b>	2 C
				<b>Rel. Humidity:</b>	31%

Digital Spurious Emissions - RADIATED (OATS)															FCC/ISED/CE
#	Test Freq. MHz	Antenna		E-Field @ 3m**					CISPR32 CLB (Pk)		FCC/ISED CLB (QPk)		FCC/ISED CLA (QPk)		Comments
		QN	Test Pol.	Ka dB/m	Kg dB	Pk dBμV/m	QPk dBμV/m	Avg dBμV/m	E3lim dBμV/m	Pass dB	E3lim dBμV/m	Pass dB	E3lim dBμV/m	Pass dB	
1	52.0	BICEMCO01	H	8.8	-4	23.1			40.0	16.9	40.0	16.9	49.5	26.4	In lockset
2	68.0	BICEMCO01	H	7.7	-4	25.5			40.0	14.5	40.0	14.5	49.5	24.0	In lockset
3	149.2	BICEMCO01	H	12.4	-7	29.3			40.0	10.7	43.5	14.2	54.0	24.7	In lockset
4	472.0	LOGEMCO01	H	17.0	-1.6	32.9			47.0	14.1	46.0	13.1	56.9	24.0	In lockset
5	584.0	LOGEMCO01	H	18.8	-2.0	29.4			47.0	17.6	46.0	16.6	56.9	27.5	In lockset
6	647.0	LOGEMCO01	H	19.7	-2.1	30.6			47.0	16.4	46.0	15.4	56.9	26.3	In lockset
7	726.0	LOGEMCO01	H	20.7	-2.4	29.9			47.0	17.1	46.0	16.1	56.9	27.0	In lockset
8	746.0	LOGEMCO01	H	20.9	-2.4	30.7			47.0	16.3	46.0	15.3	56.9	26.2	In lockset
9	2390.0	HQR1TO18S01	H	20.2	-3.2	48.9		39.0	50.0	11.0	54.0	15.0			In lockset
10	2483.5	HQR1TO18S01	H	20.3	-3.2	49.2		40.3	50.0	9.7	54.0	13.7			In lockset
11															
12															
13	52.0	BICEMCO01	H	8.8	-4	24.4			40.0	15.6	40.0	15.6	49.5	25.1	w/o chassis
14	68.0	BICEMCO01	H	7.7	-4	27.4			40.0	12.6	40.0	12.6	49.5	22.1	w/o chassis
15	149.2	BICEMCO01	H	12.4	-7	29.8			40.0	10.2	43.5	13.7	54.0	24.2	w/o chassis
16	472.0	LOGEMCO01	H	17.0	-1.6	34.4			47.0	12.6	46.0	11.6	56.9	22.5	w/o chassis
17	584.0	LOGEMCO01	H	18.8	-2.0	30.1			47.0	16.9	46.0	15.9	56.9	26.8	w/o chassis
18	647.0	LOGEMCO01	H	19.7	-2.1	31.0			47.0	16.0	46.0	15.0	56.9	25.9	w/o chassis
19	726.0	LOGEMCO01	H	20.7	-2.4	30.9			47.0	16.1	46.0	15.1	56.9	26.0	w/o chassis
20	746.0	LOGEMCO01	H	20.9	-2.4	30.8			47.0	16.2	46.0	15.2	56.9	26.1	w/o chassis
21	2390.0	HQR1TO18S01	H	20.2	-3.2	57.8		41.2	50.0	8.8	54.0	12.8			w/o chassis
22	2483.5	HQR1TO18S01	H	20.3	-3.2	59.2		48.7	50.0	1.3	54.0	5.3			w/o chassis
23															
24															
25															
26															
27															
28															
29															
30															
31															
32															

\*\*Pk+Avg detection (narrowband), Pk + QPk detection (wideband) emissions

\*\* When E-field is reported directly from Spectrum Analyzer, Antenna Factors and Cable losses are included directly in SA settings.

Table 4(b): Radiated Spurious Emissions.

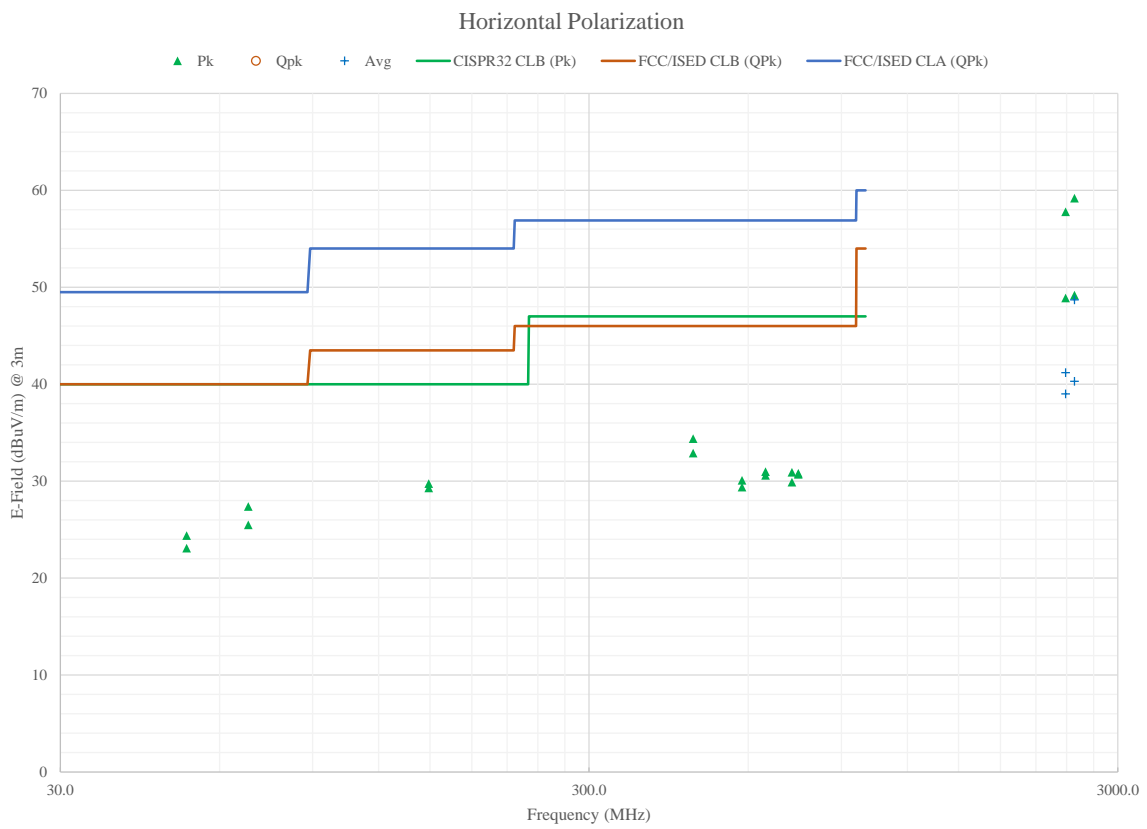

Table 4(c): Radiated Spurious Emissions.

<b>Frequency Range</b>	<b>Det</b>	<b>F Bandwidth</b>	<b>Video Bandwidth</b>	<b>Test Date:</b>	16-Dec-22
25 MHz ≤ f ≤ 1 000 MHz	Pk/QPk	120 kHz	300 kHz	<b>Test Engineer:</b>	J. Brunett
f > 1 000 MHz	Pk	1 MHz	3 MHz	<b>EUT:</b>	Allegion DC+AC Active
f > 1 000 MHz	Avg/RMS	1 MHz	3 MHz	<b>EUT Mode:</b>	Active (reading card)
				<b>Meas. Distance:</b>	3 m
				<b>Temperature:</b>	2 C
				<b>Rel. Humidity:</b>	31%

Digital Spurious Emissions - RADIATED (OATS)															FCC/ISED/CE
#	Test Freq. MHz	Antenna QN	Test Pol.	Ka dB/m	Kg dB	E-Field @ 3m**			CISPR32 CLB (Pk)		FCC/ISED CLB (QPk)		FCC/ISED CLA (QPk)		Comments
						Pk dBμV/m	Qpk dBμV/m	Avg dBμV/m	E3lim dBμV/m	Pass dB	E3lim dBμV/m	Pass dB	E3lim dBμV/m	Pass dB	
1	40.6	BICEMCO01	V	10.7	-4	25.7			40.0	14.3	40.0	14.3	49.5	23.8	In Lockset
2	68.0	BICEMCO01	V	7.7	-4	22.1			40.0	17.9	40.0	17.9	49.5	27.4	In Lockset
3	149.2	BICEMCO01	V	12.4	-7	38.7	29.7		40.0	10.3	43.5	13.8	54.0	15.3	In Lockset
4	257.0	LOGEMCO01	V	12.6	-1.0	24.9			47.0	22.1	46.0	21.1	56.9	32.0	In Lockset
5	472.0	LOGEMCO01	V	17.0	-1.6	33.1			47.0	13.9	46.0	12.9	56.9	23.8	In Lockset
6	623.0	LOGEMCO01	V	19.4	-2.1	32.7			47.0	14.3	46.0	13.3	56.9	24.2	In Lockset
7	993.0	LOGEMCO01	V	24.0	-3.1	34.0			47.0	13.0	54.0	20.0	60.0	26.0	In Lockset
8	994.0	LOGEMCO01	V	24.0	-3.1	34.1			47.0	12.9	54.0	19.9	60.0	25.9	In Lockset
9	2390.0	HQRITO18S01	V	20.2	-3.2	48.3		39.7	50.0	10.3	54.0	14.3			In Lockset
10	2483.5	HQRITO18S01	V	20.3	-3.2	46.5		38.4	50.0	11.6	54.0	15.6			In Lockset
11															
12	40.6	BICEMCO01	V	10.7	-4	28.2			40.0	11.8	40.0	11.8	49.5	21.3	w/o chassis
13	68.0	BICEMCO01	V	7.7	-4	26.5			40.0	13.5	40.0	13.5	49.5	23.0	w/o chassis
14	149.2	BICEMCO01	V	12.4	-7	41.4	28.2		40.0	11.8	43.5	15.3	54.0	12.6	w/o chassis
15	257.0	LOGEMCO01	V	12.6	-1.0	29.4			47.0	17.6	46.0	16.6	56.9	27.5	w/o chassis
16	472.0	LOGEMCO01	V	17.0	-1.6	35.1			47.0	11.9	46.0	10.9	56.9	21.8	w/o chassis
17	623.0	LOGEMCO01	V	19.4	-2.1	36.2			47.0	10.8	46.0	9.8	56.9	20.7	w/o chassis
18	993.0	LOGEMCO01	V	24.0	-3.1	36.5			47.0	10.5	54.0	17.5	60.0	23.5	w/o chassis
19	994.0	LOGEMCO01	V	24.0	-3.1	35.8			47.0	11.2	54.0	18.2	60.0	24.2	w/o chassis
20	2390.0	HQRITO18S01	V	20.2	-3.2	48.3		38.9	50.0	11.1	54.0	15.1			w/o chassis
21	2483.5	HQRITO18S01	V	20.3	-3.2	52.3		43.0	50.0	7.0	54.0	11.0			w/o chassis
22															
23															
24															
25															
26															
27															
28															
29															
30															
31															
32															

\*Pk+Avg detection (narrowband), Pk + QPk detection (wideband) emissions  
 \*\* When E-field is reported directly from Spectrum Analyzer, Antenna Factors and Cable losses are included directly in SA settings.

Table 4(d): Radiated Spurious Emissions.

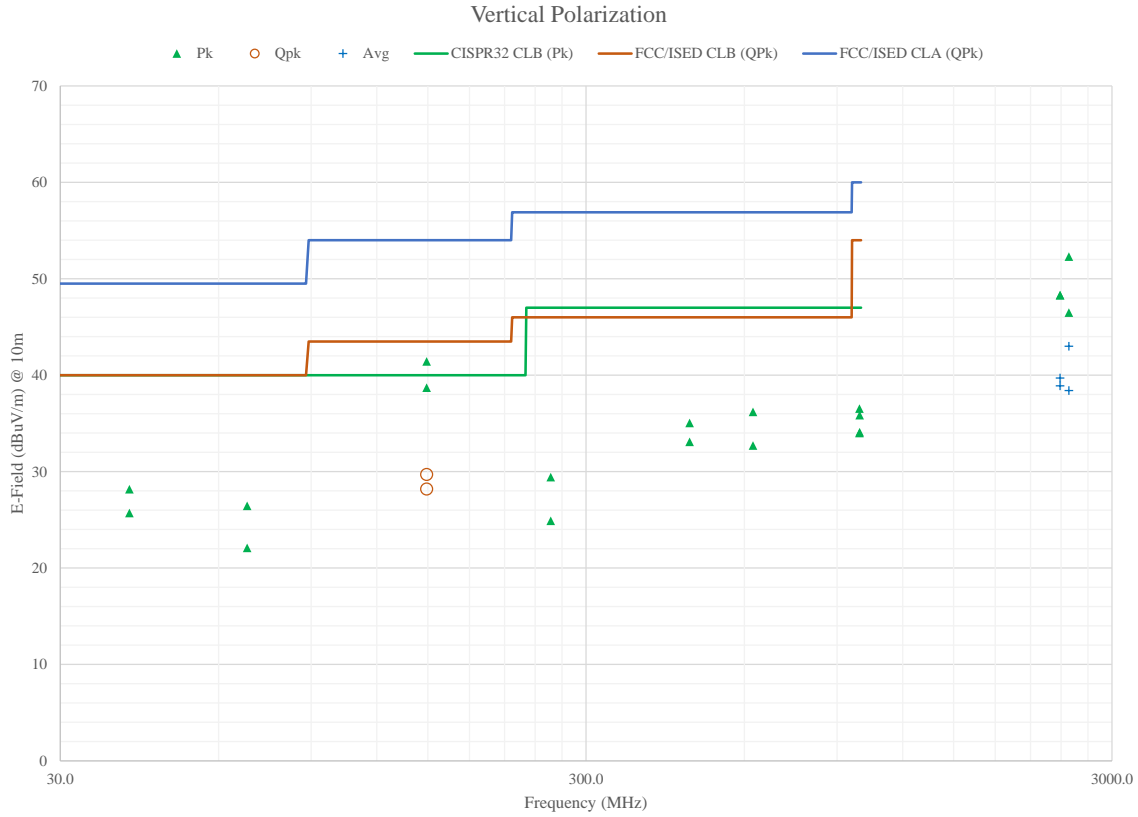

Table 4(e): Radiated Spurious Emissions.

Frequency Range	Det	IF Bandwidth	Video Bandwidth	Test Date:
9 kHz ≤ f ≤ 150 kHz	Pk/QPk	200 Hz	300 Hz	11-Dec-22
150 kHz ≤ f ≤ 30 MHz	Pk/QPk	9 kHz	30 kHz	J. Brunett
25 MHz ≤ f ≤ 1 000 MHz	Pk/QPk	120 kHz	300 kHz	EUT Mode: MULTI CM
f > 1 000 MHz	Pk	1 MHz	3MHz	Meas. Distance: 3 meters
f > 1 000 MHz	Avg	1 MHz	3MHz	EUT Tested: See below.

Fundamental Emissions Measurements																		
#	Config.	EUT Orientation	Freq. kHz	Ant. Used QN	Ant.** Height m	Table Azim deg	Ka dB/m	Kg dB	C1**		E-field @ 300m			H-field @ 300m (ISED)			Pass By***	
									3m / 300m dB	E-field @ 3m Pk dBuV/m	Pk	QPk	Limit QPk	Pk	QPk	Limit QPk		
1	In Lockset (AC+DC)	Flat	124.3	EMCOLOOP1	1.0	0	10.1	0.0	80.0	73.9		-6.1		25.7	-57.6		-25.8	31.8
2		Side	124.3	EMCOLOOP1	1.0	0	10.1	0.0	80.0	67.9		-12.1		25.7	-63.6		-25.8	37.8
3		End	124.3	EMCOLOOP1	1.0	0	10.1	0.0	80.0	63.9		-16.1		25.7	-67.6		-25.8	41.8
4	w/o Chassis (AC + DC)	Flat	124.3	EMCOLOOP1	1.0	0	10.1	0.0	80.0	81.2		1.2		25.7	-50.3		-25.8	24.5
5		Side	124.3	EMCOLOOP1	1.0	0	10.1	0.0	80.0	75.3		-4.7		25.7	-56.2		-25.8	30.4
6		End	124.3	EMCOLOOP1	1.0	0	10.1	0.0	80.0	61.0		-19.0		25.7	-70.5		-25.8	44.7

Table 4(f): Radiated Spurious Emissions.

Frequency Range	Det	IF Bandwidth	Video Bandwidth	Test Date:
9 kHz ≤ f ≤ 150 kHz	Pk/QPk	200 Hz	300 Hz	11-Dec-22
150 kHz ≤ f ≤ 30 MHz	Pk/QPk	9 kHz	30 kHz	J. Brunett
30 MHz ≤ f ≤ 1 000 MHz	Pk/QPk	120 kHz	300 kHz	Meas. Distance: 3m
				EUT Tested: See below.
				EUT Mode: Multi CM

Fundamental Emissions Measurements																				
R0	Mode / Antenna	Test Antenna Polarization	Freq. MHz	Ant. Used	Ant. Ht.	Table Angle	Meas. Dist. m	Pr dBm	Ka dB/m	Kg dB	N/FF boundary m	Cf 3 m / 30 m dB	E3m (Pk) Pk dBuV/m	E30m Pk/QPk/Avg dBuV/m	Limit	H30m Pk/QPk/Avg dBuA/m	Limit	Pass By		
R1	In Lockset (AC+DC)	Coaxial - Horiz	13.56	EMCOLOOP1	1.0	90.0	3.0		16.9	0.8	3.5	20.0	58.9	38.9		84.0	-12.6		45.1	
R4	w/o Chassis (AC + DC)	Coaxial - Horiz	13.56	EMCOLOOP1	1.0	90.0	3.0		16.9	0.8	3.5	20.0	71.2	51.2		84.0	-3		32.8	
#	C1	C2	C3	C4	C5	C6	C7	C8	C9	C10	C11	C12	C13	C14	C15	C16	C17	C18	C19	C20

(ROW) (COLUMN) NOTE:  
 R0 C1 EUT was tested in CM mode. No averaging applied. Peak data reported to demonstrate compliance.  
 R0 C11 N/FF Boundary at lambda/2pi distance for small radiator.  
 R0 C12 40 dB/dec near field conversion factor, 20 dB/dec far-field conversion factors are permitted. 20dB is chosen to show compliance under worst case conversion.  
 R0 C13 When E-field is reported directly from Spectrum Analyzer, Antenna Factors and Cable losses are included directly in SA settings.  
 R0 C17 H-field is computed by subtracting dBΩ in freespace from E-Field measurements = 20\*log(120π) = 51.5dB



## 5 Measurement Uncertainty and Accreditation Documents

The maximum values of measurement uncertainty for the laboratory test equipment and facilities associated with each test are given in the table below. This uncertainty is computed for a 95.45% confidence level based on a coverage factor of  $k = 2$ .

Table 5: Measurement Uncertainty.

Measured Parameter	Measurement Uncertainty <sup>†</sup>
Radio Frequency	$\pm(f_{Mkr}/10^7 + RBW/10 + (SPN/(PTS - 1))/2 + 1 \text{ Hz})$
Conducted Emm. Amplitude	$\pm 1.9 \text{ dB}$
Radiated Emm. Amplitude ( $f < 30 \text{ MHz}$ )	$\pm 3.1 \text{ dB}$
Radiated Emm. Amplitude (30 – 200 MHz)	$\pm 4.0 \text{ dB}$
Radiated Emm. Amplitude (200 – 1000 MHz)	$\pm 5.2 \text{ dB}$
Radiated Emm. Amplitude ( $f > 1000 \text{ MHz}$ )	$\pm 3.7 \text{ dB}$

<sup>†</sup>Ref: CISPR 16-4-2:2011+A1:2014



Figure 5: Accreditation Documents