

NFC Test Report

regarding

USA: CFR Title 47, Part 15.225 (Emissions)

Canada: RSS-210v10/GENv5 (Emissions)

for



47446672

Category: Keycard Access Module

Judgments:

Complies with FCC Part 15.225, and ISED RSS-210v10

Testing Completed: March 1, 2023



Prepared for:

Allegion, PLC

11819 North Pennsylvania Street, Carmel Indiana 46032 USA

Phone: +1 (317) 810-3362, Fax: +1 (317) 810-3193

Contact: Frank Nardelli, Frank.Nardelli@allegion.com

Data Rec./Rev. by: Joseph Brunett
Dr. Joseph Brunett, EMC-002790-NE

Rpt. Auth. by: Joseph Brunett
Dr. Joseph Brunett, EMC-002790-NE

Rpt. Prep./Rev. by: John Nantz
John Nantz

Date of Issue: March 1, 2023

Revision History

Rev. No.	Date	Details	Revised By
r0	March 1, 2023	Initial Release.	J. Brunett
r1	June 13, 2023	add AC Emm. data.	J. Brunett

Contents

Revision History	2
Table of Contents	2
1 Test Report Scope and Limitations	4
1.1 Laboratory Authorization	4
1.2 Report Retention	4
1.3 Subcontracted Testing	4
1.4 Test Data	4
1.5 Limitation of Results	4
1.6 Copyright	4
1.7 Endorsements	4
1.8 Test Location	5
1.9 Traceability and Equipment Used	5
2 Test Specifications and Procedures	6
2.1 Test Specification and General Procedures	6
3 Configuration and Identification of the Equipment Under Test	7
3.1 Description and Declarations	7
3.1.1 EUT Configuration	8
3.1.2 Modes of Operation	8
3.1.3 Variants	8
3.1.4 Test Samples	8
3.1.5 Functional Exerciser	8
3.1.6 Modifications Made	9
3.1.7 Production Intent	9
3.1.8 Declared Exemptions and Additional Product Notes	9
4 Emissions	10
4.1 General Test Procedures	10
4.1.1 Radiated Test Setup and Procedures	10
4.1.2 Conducted Emissions Test Setup and Procedures	12
4.1.3 Power Supply Variation	13
4.2 Intentional Emissions	14
4.2.1 Fundamental Emission Pulsed Operation	14
4.2.2 Fundamental Emission Bandwidth	16
4.2.3 Fundamental Emission	17
4.3 Unintentional Emissions	19
4.3.1 Transmit Chain Spurious Emissions	19
4.3.2 Conducted Emissions Test Results - AC Power Port(s)	20
5 Measurement Uncertainty and Accreditation Documents	21

List of Tables

1	Test Site List.	5
2	Equipment List.	5
3	EUT Declarations.	7
4	Pulsed Emission Characteristics (Duty Cycle).	14
5	Intentional Emission Bandwidth.	16
6	Fundamental Radiated Emissions.	17
6	Fundamental Radiated Emissions.	18
7	Transmit Chain Spurious Emissions.	19
8	AC Mains Power Conducted Emissions Results.	20
9	Measurement Uncertainty.	21

List of Figures

1	Photos of EUT.	7
2	EUT Test Configuration Diagram.	8
3	Radiated Emissions Diagram of the EUT.	10
4	Radiated Emissions Test Setup Photograph(s).	11
5	Conducted Emissions Setup Diagram of the EUT.	12
6	Conducted Emissions Test Setup Photograph(s).	12
7	Example Pulsed Emission Characteristics (Duty Cycle).	15
8	Example Intentional Emission Bandwidth.	16
9	Accreditation Documents	21

1 Test Report Scope and Limitations

1.1 Laboratory Authorization

Test Facility description and attenuation characteristics are on file with the FCC Laboratory, Columbia, Maryland (FCC Reg. No: US5348 and US5356) and with ISED Canada, Ottawa, ON (File Ref. No: 3161A and 24249). Amber Helm Development L.C. holds accreditation under NVLAP Lab Code 200129-0.

1.2 Report Retention

For equipment verified to comply with the regulations herein, the manufacturer is obliged to retain this report with the product records for the life of the product, and no less than ten years. A copy of this Report will remain on file with this laboratory until April 2033.

1.3 Subcontracted Testing

This report does not contain data produced under subcontract.

1.4 Test Data

This test report contains data included within the laboratory's scope of accreditation. Any data in this report that is not covered under the laboratory's scope is clearly identified.

1.5 Limitation of Results

The test results contained in this report relate only to the item(s) tested. Any electrical or mechanical modification made to the test item subsequent to the test date shall invalidate the data presented in this report. Any electrical or mechanical modification made to the test item subsequent to this test date shall require reevaluation.

1.6 Copyright

This report shall not be reproduced, except in full, without the written approval of Amber Helm Development L.C.

1.7 Endorsements

This report shall not be used to claim product endorsement by any accrediting, regulatory, or governmental agency.

1.8 Test Location

The EUT was fully tested by **Amber Helm Development L.C.**, headquartered at 92723 Michigan Hwy-152, Sister Lakes, Michigan 49047 USA. Table 1 lists all sites employed herein. Specific test sites utilized are also listed in the test results sections of this report where needed.

Table 1: Test Site List.

Description	Location	Quality Num.
OATS (3 meter)	3615 E Grand River Rd., Williamston, Michigan 48895	OATSC

1.9 Traceability and Equipment Used

Pertinent test equipment used for measurements at this facility is listed in Table 2. The quality system employed at Amber Helm Development L.C. has been established to ensure all equipment has a clearly identifiable classification, calibration expiry date, and that all calibrations are traceable to the SI through NIST, other recognized national laboratories, accepted fundamental or natural physical constants, ratio type of calibration, or by comparison to consensus standards.

Table 2: Equipment List.

Description	Manufacturer/Model	SN	Quality Num.	Cal/Ver By / Date Due
Spectrum Analyzer	R & S / FSV30	101660	RSFSV30001	RS / Apr-2024
Spectrum Analyzer	R & S / FPC1500	101692	RSFPC15001	RS / Dec-2023
Shielded Loop Antenna	EMCO / 6507	9012-1264	EMCOLOOP2	Keysight / Aug-2023
Biconical	EMCO / 93110B	9802-3039	BICEMCO01	Keysight / Aug-2023
Log Periodic Antenna	EMCO / 3146	9305-3614	LOGEMCO01	Keysight / Aug-2023

2 Test Specifications and Procedures

2.1 Test Specification and General Procedures

The goal of Allegion, PLC is to demonstrate that the Equipment Under Test (EUT) complies with the Rules and/or Directives below. Detailed in this report are the results of testing the Allegion, PLC 47446672 for compliance to:

Country/Region	Rules or Directive	Referenced Section(s)
United States	Code of Federal Regulations	CFR Title 47, Part 15.225
Canada	ISED Canada	RSS-210v10/GENv5

It has been determined that the equipment under test is subject to the rules and directives above at the date of this testing. In conjunction with these rules and directives, the following specifications and procedures are followed herein to demonstrate compliance (in whole or in part) with these regulations.

ANSI C63.4:2014	"Methods of Measurement of Radio-Noise Emissions from Low-Voltage Electrical and Electronic Equipment in the Range of 9 kHz to 40 GHz"
ANSI C63.10:2013	"American National Standard of Procedures for Compliance Testing of Unlicensed Wireless Devices"
TP0102RA	"AHD Internal Document TP0102 - Radiated Emissions Test Procedure"

3 Configuration and Identification of the Equipment Under Test

3.1 Description and Declarations

The EUT is an access card reader module. The EUT is approximately 3.5 x 5 x 0.5 cm in dimension, and is depicted in Figure 1. It is powered by 3.3 VDC lock power system. This product is used as an access reader to enable key free access to the manufacturer’s lockset host products. Table 3 outlines provider declared EUT specifications.

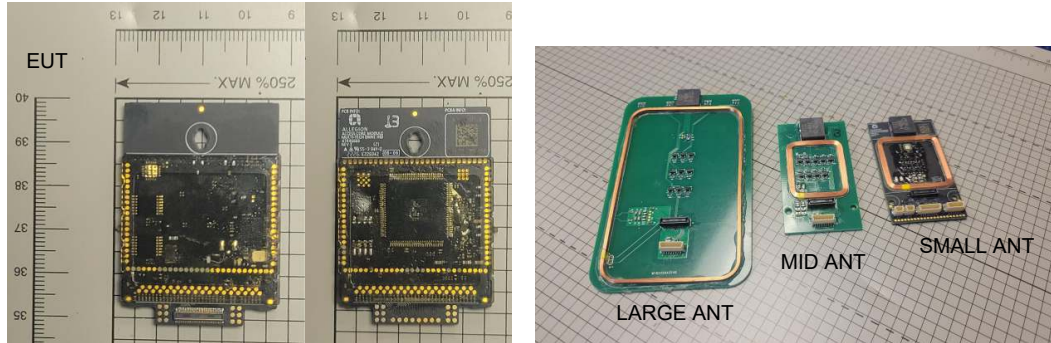

Figure 1: Photos of EUT.

Table 3: EUT Declarations.

General Declarations	
Equipment Type:	Keycard Access Module
Country of Origin:	Not Declared
Nominal Supply:	3.3 VDC
Oper. Temp Range:	Not Declared
Frequency Range:	13.56 MHz
Antenna Dimension:	Integral
Antenna Type:	Coils (large, medium, small)
Antenna Gain:	Integral
Number of Channels:	1
Channel Spacing:	None
Alignment Range:	Not Declared
Type of Modulation:	ASK
United States	
FCC ID Number:	XPB-47446672
Classification:	DXX
Canada	
IC Number:	8053B-47446672
Classification:	Other

3.1.1 EUT Configuration

The EUT is configured for testing as depicted in Figure 2.

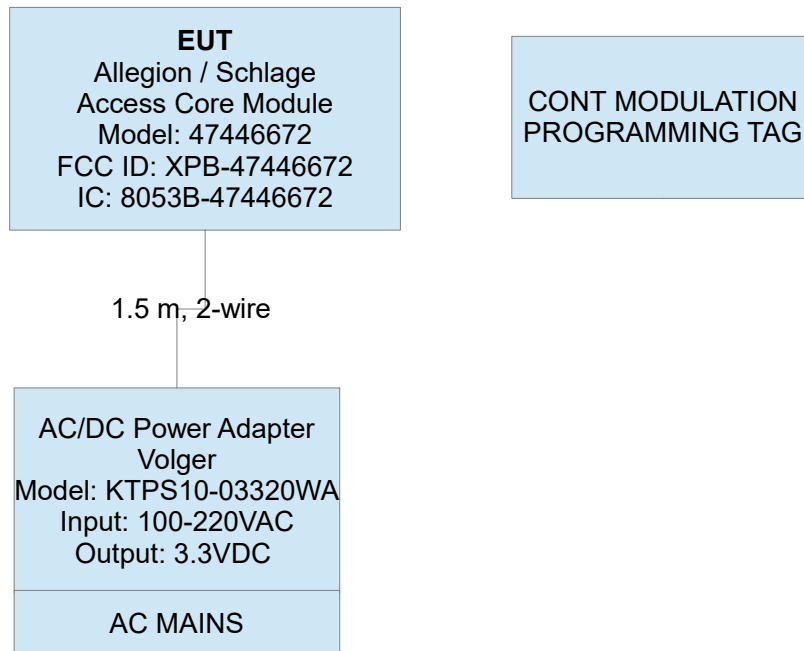

Figure 2: EUT Test Configuration Diagram.

3.1.2 Modes of Operation

The EUT is capable of two modes of operation, POLLING continuously to detect a 13.56 MHz tag and TAG READ interrogation if detected. Both modes are tested herein. This product is also populated with 125 kHz LF proximity tag reader circuitry with test data reported in AHD Report No. ALGACA-WR2240USB. Digital spurious and AC mains spurious emissions are reported with both radios active. Furthermore, this EUT has been evaluated when co-located with this manufacturer's DTS transceiver modules (Digital Core modules, FCC ID: XPB-47334321, IC: 8053B-47334321 and FCC ID: XPB-47334317, IC: 8053B-47334317) in a separate host / cabinet emissions report, AHD Report No. ALGACA-WR2240USC.

3.1.3 Variants

There is only a single version of the EUT.

3.1.4 Test Samples

Two samples of the fully populated EUT were provided for testing along with 3 unique PCB antennas that can be employed. Each EUT sample was capable of either normal operation or forced transmission for testing via a UART / PC terminal interface. Test data is provided demonstrating compliance with all three antenna boards. The EUT employs unique power and antenna board connectors used only by the module manufacturer, preventing this module's use in any device other than those tested and authorized by this module manufacturer.

3.1.5 Functional Exerciser

Normal functionality was confirmed by measurement of transmitted signals.

3.1.6 Modifications Made

There were no modifications made to the EUT by this laboratory.

3.1.7 Production Intent

The EUT appears to be a production ready sample.

3.1.8 Declared Exemptions and Additional Product Notes

The EUT is a module, subject to further compliance evaluation in every host lockset into which it may be employed. The manufacturer intends to complete this testing via SDoC evaluation completed separately.

4 Emissions

4.1 General Test Procedures

4.1.1 Radiated Test Setup and Procedures

Radiated electromagnetic emissions from the EUT are first pre-scanned in our screen room. Spectrum and modulation characteristics of all emissions are recorded. Instrumentation, including spectrum analyzers and other test equipment as detailed in Section 1.8 are employed. After pre-scan, emission measurements are made on the test site of record. If the EUT connects to auxiliary equipment and is table or floor standing, the configurations prescribed in relevant test standards are followed. Alternatively, a layout closest to normal use (as declared by the provider) is employed if the resulting emissions appear to be worst-case in such a configuration. See Figure 3. All intentionally radiating elements that are not fixed-mounted in use are placed on the test table lying flat, on their side, and on their end (3-axes) and the resulting worst case emissions are recorded. If the EUT is fixed-mounted in use, measurements are made with the device oriented in the manner consistent with installation and then emissions are recorded. If the EUT exhibits spurious emissions due to internal receiver circuitry, such emissions are measured with an appropriate carrier signal applied.

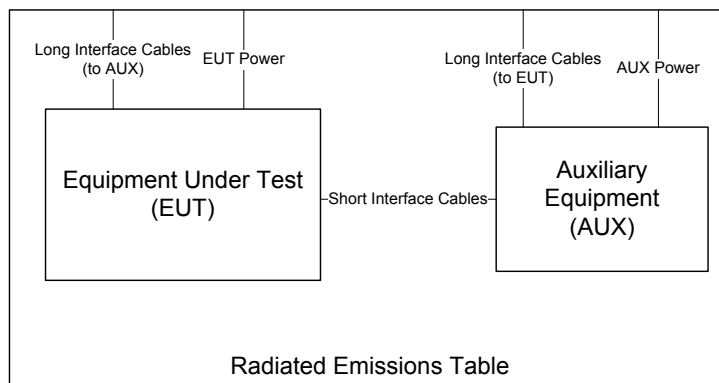

Figure 3: Radiated Emissions Diagram of the EUT.

For devices with intentional emissions below 30 MHz, a shielded loop antenna and/or E-field and H-Field broadband probes are used depending on the regulation. Shielded loops are placed at a 1 meter receive height at the desired measurement distance. For exposure in this band, 10cm diameter single-axis broadband probes meeting the requirements of ISED SPR-002 section 5.2 are employed. Measurements are repeated and summed over three axes, and the entire frequency range is measured with and without the EUT transmitting.

Emissions between 30 MHz and 1 GHz are measured using calibrated broadband antennas. For both horizontal and vertical polarizations, the test antenna is raised and lowered from 1 to 4 m in height until a maximum emission level is detected. The EUT is then rotated through 360° in azimuth until the highest emission is detected. The test antenna is then raised and lowered one last time from 1 to 4 m and the worst case value is recorded. Emissions above 1 GHz are characterized using standard gain or broadband ridge-horn antennas on our OATS with a 4×5 m rectangle of ECCOSORB absorber covering the OATS ground screen and a 1.5m table height. Care is taken to ensure that test receiver resolution and video bandwidths meet the regulatory requirements, and that the emission bandwidth of the EUT is not reduced. Photographs of the test setup employed are depicted in Figure 4.

Where regulations allow for direct measurement of field strength, power values (dBm) measured on the test receiver / analyzer are converted to $\text{dB}\mu\text{V}/\text{m}$ at the regulatory distance, using

$$E_{dist} = 107 + P_R + K_A - K_G + K_E - C_F$$

where P_R is the power recorded on spectrum analyzer, in dBm, K_A is the test antenna factor in dB/m, K_G is the combined pre-amplifier gain and cable loss in dB, K_E is duty correction factor (when applicable) in dB, and C_F is a distance conversion (employed only if limits are specified at alternate distance) in dB. This field strength value is then compared with the regulatory limit. If effective isotropic radiated power (EIRP) is computed, it is computed as

$$EIRP(\text{dBm}) = E_{3m}(\text{dB}\mu\text{V}/\text{m}) - 95.2.$$

When presenting data at each frequency, the highest measured emission under all possible EUT orientations (3-axes) is reported.

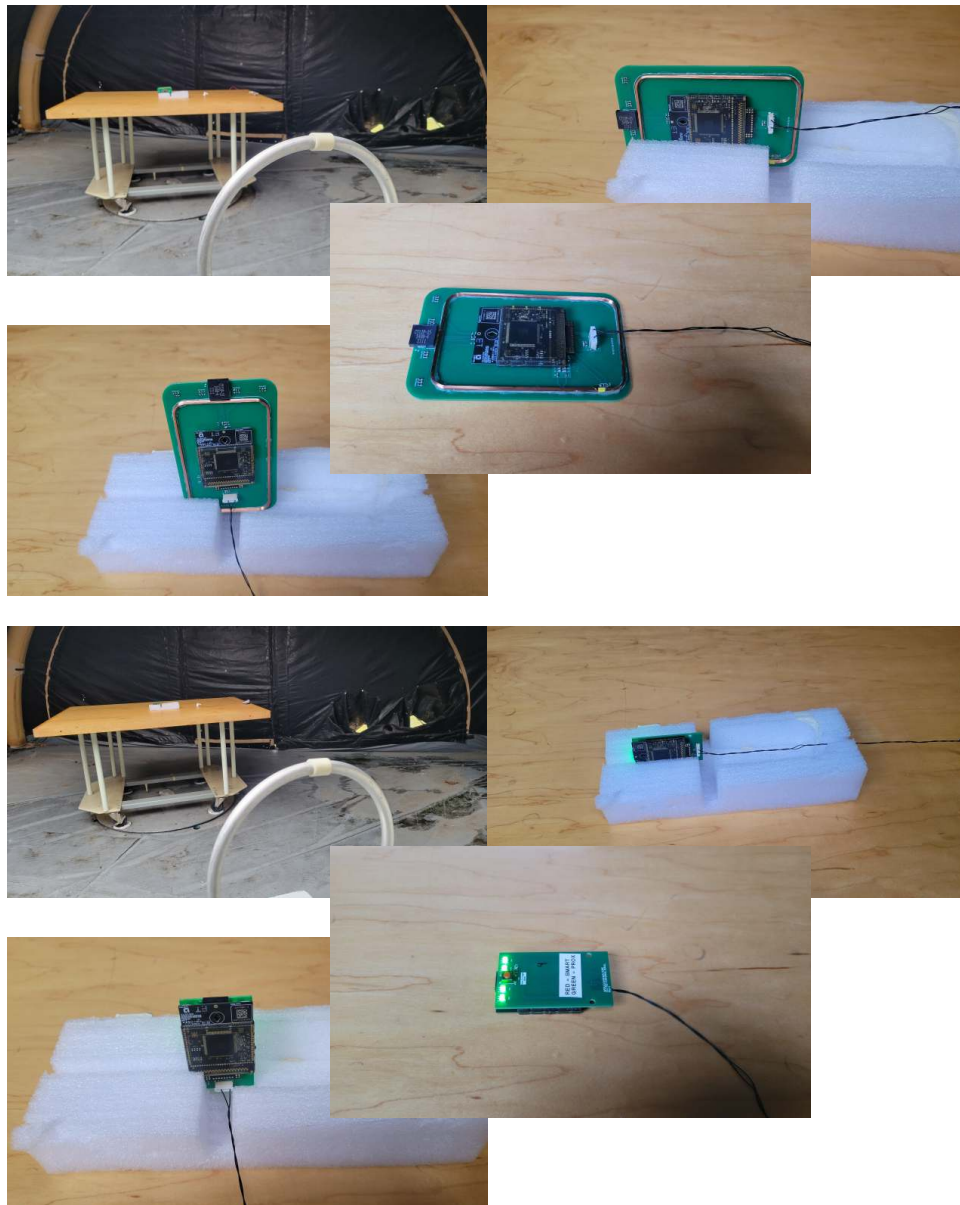

Figure 4: Radiated Emissions Test Setup Photograph(s).

4.1.2 Conducted Emissions Test Setup and Procedures

AC Port Conducted Spurious For this device, AC power line conducted emissions are measured in our screen room. If the EUT connects to auxiliary equipment and is table or floor standing, the configurations prescribed in ANSI C63.4 / CISPR 22 are employed. Alternatively, an on-table layout more representative of actual use may be employed if the resulting emissions appear to be worst-case in such a configuration. See Figure 5.

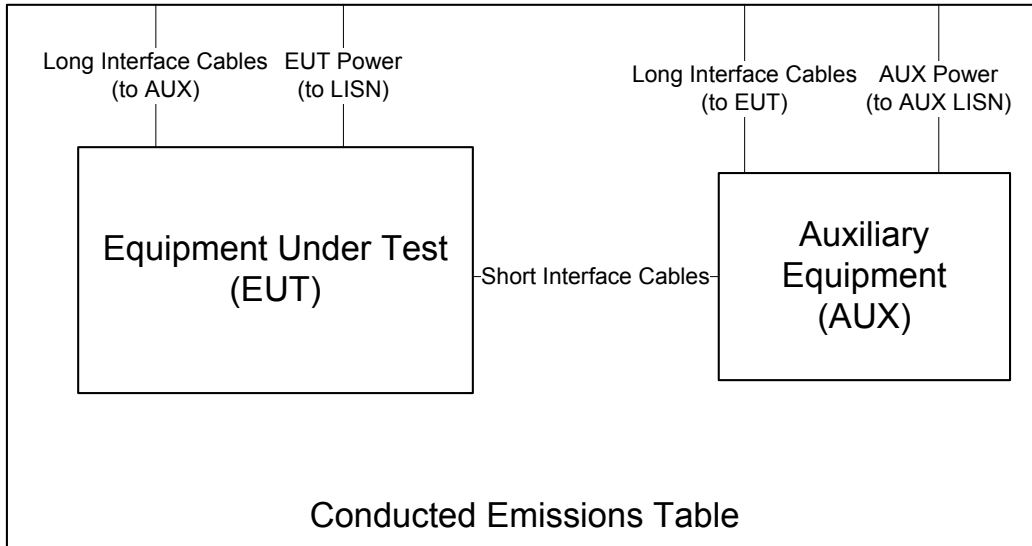

Figure 5: Conducted Emissions Setup Diagram of the EUT.

Conducted emissions are measured and recorded for each AC mains power source over the spectrum 0.15 MHz to 30 MHz for both the ungrounded (HI/PHASE) and grounded (LO/GND) conductors with the EUT placed in its highest current draw operating mode(s). The test receiver is set to peak-hold mode in order to record the peak emissions throughout the course of functional operation. Only if an emission exceeds or is near the limit are quasi-peak and average detection applied. Photographs of the test setup employed are depicted in Figure 6.



Figure 6: Conducted Emissions Test Setup Photograph(s).

4.1.3 Power Supply Variation

Tests at extreme supply voltages are made if required by the procedures specified in the test standard, and results of this testing are detailed in this report.

In the case of this EUT, measurements of the worst-case radiated emissions are performed with the supply voltage varied by no less than 85% and 115% of the nominal rated value for devices connecting to AC power mains.

4.2 Intentional Emissions

4.2.1 Fundamental Emission Pulsed Operation

The details and results of testing the EUT for pulsed operation are summarized in Table 4.

Table 4: Pulsed Emission Characteristics (Duty Cycle).

Frequency Range	Det	IF Bandwidth	Video Bandwidth	Test Date:	11-Dec-22
9 kHz ≤ f ≤ 150 kHz	Pk/QPk	200 Hz	300 Hz	Test Engineer:	J. Brunett
150 kHz ≤ f ≤ 30 MHz	Pk/QPk	9 kHz/10 kHz	30 kHz	EUT Mode:	Normal Operating
25 MHz ≤ f ≤ 1 000 MHz	Pk/QPk	120 kHz	300 kHz	Meas. Distance:	3 meters
f > 1 000 MHz	Pk	3 MHz	3MHz	EUT Tested:	Allegion NFC
f > 1 000 MHz	Avg	3 MHz	10kHz		

R0	EUT Mode	Overall Transmission			Internal Frame Characteristics			Computed Duty Cycle	
		Min. Repetition Rate (sec)	Max. No. of Frames	Total Transmission Length (sec)	Max. Frame Length (ms)	Min. Frame Period (ms)	Frame Encoding	(%)	Duty (dB)
R1	13.56 MHz Polling	0.730	8	-	32.8	41.1	In normal operation the EUT NFC device transmits 8 short pulses at 13.56 MHz every 730ms looking for a tag (coil loading change).	N/A	N/A
R2	13.56 MHz Tag Read	Single	1	-	104.1	-	When a tag is detected the EUT NFC device will transmit a longer (104 ms) frame to read the tag. This frame occurs on every tag read.	N/A	N/A
#	C1	C2	C3	C4	C5	C6	C7	C8	C9

(ROW) (COLUMN) NOTE:
 R0 C8/C9 No Duty Cycle is employed when demonstrating compliance.



Figure 7: Example Pulsed Emission Characteristics (Duty Cycle).

4.2.2 Fundamental Emission Bandwidth

Emission bandwidth (EBW) of the EUT is measured with the device placed in the test mode(s) with the shortest available frame length and minimum frame spacing. Radiated emissions are recorded following the test procedures listed in Section 2.1. The 20 dB EBW is measured as the max-held peak-detected signal when the IF bandwidth is greater than or equal to 1% of the receiver span. For complex modulations other than ASK and FSK, the 99% emission bandwidth per IC test procedures has a different result, and is also separately reported. The results of EBW testing are summarized in Table 5. Plots showing measurements employed to obtain the emission bandwidth reported are provided in Figure 8.

Table 5: Intentional Emission Bandwidth.

Frequency Range	Det	IF Bandwidth	Video Bandwidth	Test Date:	11-Dec-22
9 kHz ≤ f ≤ 150 kHz	Pk	> 1% Span	≥ 3 * IFBW	Test Engineer:	J. Brunett
150 kHz ≤ f ≤ 30 MHz	Pk	> 1% Span	≥ 3 * IFBW	EUT Mode:	See Below
				Meas. Distance:	0.1 meters
				EUT Tested:	Allegion NFC

R0	Mode	Frequency Range (MHz)	Temp (C)	Supply (V)	99% PWR BW (kHz)	20 dB EBW (kHz)	fL (20 dBc) (MHz)	fH (20 dBc) (MHz)
R1	13.56 MHz Polling	13.56	20	3.3	493.20	431.47	13.346	13.778
R2	13.56 MHz Tag Read	13.56	20	3.3	531.30	434.01	13.343	13.777
#	C1	C2	C3	C4	C5	C6	C7	C9

(ROW) (COLUMN) NOTE:

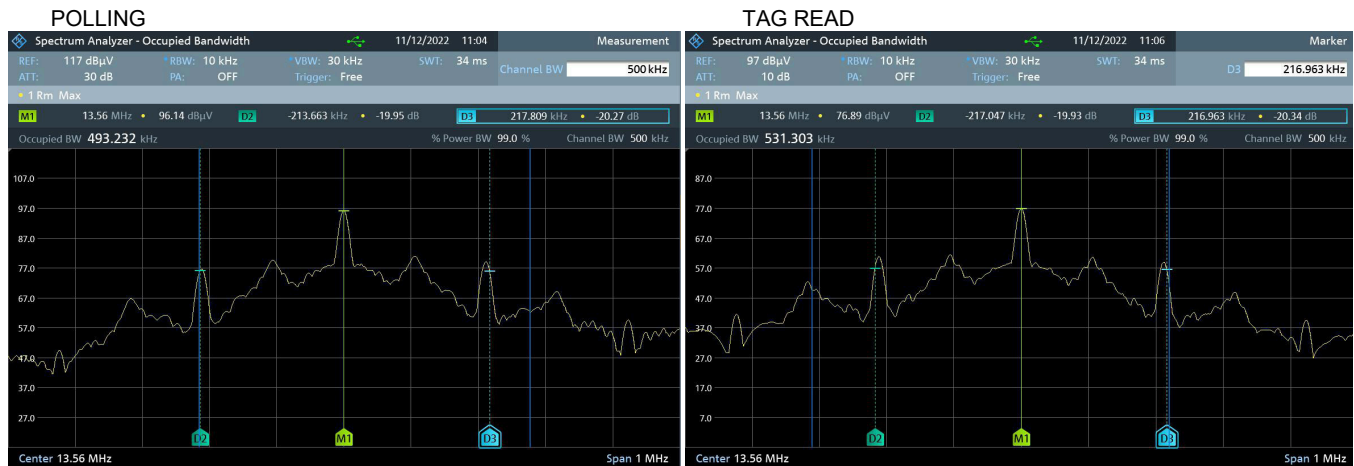

Figure 8: Example Intentional Emission Bandwidth.

4.2.3 Fundamental Emission

Following the test procedures listed in Section 2.1, field emissions measurements are made on the EUT for both Horizontal and Vertically polarized coupling fields. The EUT’s loop antenna(s) are measured along all three axes, including when the EUT loop axes are aligned in the same axis as the test loop and aligned coplanar (in the same plane) with the test loop antenna. Table 6 details the results of these measurements.

Table 6(a): Fundamental Radiated Emissions.

Frequency Range	Det	IF Bandwidth	Video Bandwidth	Test Date:
9 kHz ≤ f ≤ 150 kHz	Pk/QPk	200 Hz	300 Hz	11-Dec-22
150 kHz ≤ f ≤ 30 MHz	Pk/QPk	9 kHz	30 kHz	Test Engineer: J. Brunett
30 MHz ≤ f ≤ 1 000 MHz	Pk/QPk	120 kHz	300 kHz	Meas. Distance: 3 meters
				EUT Tested: Allegion NFC
				EUT Mode: CM

Fundamental Emissions Measurements																				
R0	Mode / Antenna	Test Antenna	Freq. MHz	Ant. Used	Ant. Ht.	Table Angle	Meas. Dist. m	Pr dBm	Ka dB/m	Kg dB	NF/FF boundary m	Cf 3 m / 30 m dB	E3m (Pk) Pk dBuV/m	E30m			H30m			Pass By
														Pk dBuV/m	QPk/Avg	Limit	Pk dBuA/m	QPk/Avg	Limit	
R1	CM (Large Antenna)	Coaxial - Horz	13.56	EMCOLOOP1	1.0	90.0	3.0		16.9	0.8	3.5	20.0	73.3	53.3	84.0	1.8				30.7
R2		Coplanar - Horz	13.56	EMCOLOOP1	1.0	90.0	3.0		16.9	0.8	3.5	20.0	68.9	48.9	84.0	-2.6				35.1
R3		Coplanar - Vert	13.56	EMCOLOOP1	1.0	90.0	3.0		16.9	0.8	3.5	20.0	65.2	45.2	84.0	-6.3				38.8
R4	CM (Medium Antenna)	Coaxial - Horz	13.56	EMCOLOOP1	1.0	90.0	3.0		16.9	0.8	3.5	20.0	63.3	43.3	84.0	-8.2				40.7
R5	CM (Small Antenna)	Coaxial - Horz	13.56	EMCOLOOP1	1.0	90.0	3.0		16.9	0.8	3.5	20.0	58.3	38.3	84.0	-13.2				45.7
Frequency Stability over Temperature/Voltage																				
R6	Mode	Temp (°C)	Freq. (MHz)	Voltage (VDC)	Freq. Variation (+/- ppm)					Freq. Variation Limit (+/- ppm)					Pass					
R7	CM	20	13.560168	3.3	BASELINE															
R8	CM	-20	13.560112	3.3	-4					100					TRUE					
R9	CM	55	13.560558	3.3	29					100					TRUE					
R10	CM	20	13.560068	3.5	-7					100					TRUE					
R11	CM	20	13.560673	2.8	off					off										
#	C1	C2	C3	C4	C5	C6	C7	C8	C9	C10	C11	C12	C13	C14	C15	C16	C17	C18	C19	C20

(ROW) (COLUMN) NOTE:
 R0 C1 EUT was tested in CM mode. No averaging applied, Peak data reported to demonstrate compliance.
 R0 C11 NF/FF Boundary at lambda/2pi distance for small radiator.
 R0 C12 40 dB/dec near field conversion factor, 20 dB/dec far-field conversion factors are permitted. 20dB is chosen to show compliance under worst case conversion.
 R0 C13 When E-field is reported directly from Spectrum Analyzer, Antenna Factors and Cable losses are included directly in SA settings.
 R0 C17 H-field is computed by subtracting dBΩ in freespace from E-Field measurements = 20*log(120π) = 51.5dB

Table 6(b): Fundamental Radiated Emissions.



4.3 Unintentional Emissions

4.3.1 Transmit Chain Spurious Emissions

The results for the measurement of transmit chain spurious emissions at the nominal voltage and temperature are provided in Table 7. Following the test procedures listed in Section 2.1, field emissions measurements are made on the EUT for both Horizontal and Vertically polarized coupling fields. The EUT’s loop antenna(s) are measured when the EUT loop axes placed in all three axes, including when they are aligned along the same axis as the test loop antenna and are aligned coplanar with the test loop antenna. For all arrangements, test loop is rotated for maximum field. The results for the measurement of transmit chain spurious emissions at the nominal voltage and temperature are provided in Table 7. Measurements are performed to 10 times the highest fundamental operating frequency.

Table 7: Transmit Chain Spurious Emissions.

Frequency Range	Det	IF Bandwidth	Video Bandwidth	Test Date:	21-Dec-22
9 kHz ≤ f ≤ 150 kHz	Pk/QPk	200 Hz	300 Hz	Test Engineer:	J. Brunett
150 kHz ≤ f ≤ 30 MHz	Pk/QPk	9 kHz	30 kHz	Meas. Distance:	3 meters
25 MHz ≤ f ≤ 1 000 MHz	Pk/QPk	120 kHz	300 kHz	EUT Tested:	Allegion NFC

Transmit Chain Spurious Emissions																				
#	Mode / Antenna	Test Antenna Polarization	Freq. Start MHz	Freq. Stop MHz	Ant. Used	Ant. Ht. m	Table Angle deg	Meas. Dist. m	Ka	Kg	NF/FF boundary	Cf (3 to 30m) dB	E3m (Pk) dBuV/m	E-field (Pk) (Qpk/Avg) dBuV/m	E-field Limit (30m / 3m) dBuV/m	H-field (Pk) (Qpk/Avg) dBuA/m	ISED H-field Limit (30m / 3m) dBuA/m	Pass By	Comments	
R1	CM (Large Antenna)	Coaxial - Horz	27.1	27.1	EMCOLOOP1	1.0	90.0	3.0	8.7	1.0	1.8	20.0	40.0	20.0	49.5	-31.5	-21.9	9.6	Max all	
R2		HV (worst case)	40.7	40.7	BICEMCO01	1.0	max all	3.0	11.5	-4			33.1	33.1	40.0			6.9	background	
R3		HV (worst case)	54.2	54.2	BICEMCO01	1.0	max all	3.0	10.1	-4			23.8	23.8	40.0			16.2	background	
R4		HV (worst case)	67.8	67.8	BICEMCO01	1.0	max all	3.0	9.7	-4			27.7	27.7	40.0			12.3	background	
R5		HV (worst case)	81.4	81.4	BICEMCO01	1.0	max all	3.0	9.5	-5			18.1	18.1	40.0			21.9	background	
R6		HV (worst case)	94.9	94.9	BICEMCO01	1.0	max all	3.0	9.7	-5			37.3	38.0	43.5			5.5	background	
R7		HV (worst case)	108.5	108.5	BICEMCO01	1.0	max all	3.0	10.6	-6			24.7	24.7	43.5			18.8	background	
R8		HV (worst case)	122.0	122.0	BICEMCO01	1.0	max all	3.0	11.7	-6			24.0	24.0	43.5			19.5	background	
R9		HV (worst case)	135.6	135.6	BICEMCO01	1.0	max all	3.0	12.3	-6			21.9	21.9	43.5			21.6	background	
R10	CM (Mid Antenna)	Coaxial - Horz	27.1	27.1	EMCOLOOP1	1.0	90.0	3.0	8.7	1.0	1.8	20.0	35.4	15.4	49.5	-36.1	-21.9	14.2	Max all	
R11		HV (worst case)	40.7	40.7	BICEMCO01	1.0	max all	3.0	11.5	-4			33.1	33.1	40.0			6.9	background	
R12		HV (worst case)	54.2	54.2	BICEMCO01	1.0	max all	3.0	10.1	-4			23.8	23.8	40.0			16.2	background	
R13		HV (worst case)	67.8	67.8	BICEMCO01	1.0	max all	3.0	9.7	-4			27.7	27.7	40.0			12.3	background	
R14		HV (worst case)	81.4	81.4	BICEMCO01	1.0	max all	3.0	9.5	-5			18.1	18.1	40.0			21.9	background	
R15		HV (worst case)	94.9	94.9	BICEMCO01	1.0	max all	3.0	9.7	-5			37.3	38.0	43.5			5.5	background	
R16		HV (worst case)	108.5	108.5	BICEMCO01	1.0	max all	3.0	10.6	-6			24.7	24.7	43.5			18.8	background	
R17		HV (worst case)	122.0	122.0	BICEMCO01	1.0	max all	3.0	11.7	-6			24.0	24.0	43.5			19.5	background	
R18		HV (worst case)	135.6	135.6	BICEMCO01	1.0	max all	3.0	12.3	-6			21.9	21.9	43.5			21.6	background	
R19	CM (Small Antenna)	Coaxial - Horz	27.1	27.1	EMCOLOOP1	1.0	90.0	3.0	8.7	1.0	1.8	20.0	29.6	9.6	49.5	-41.9	-21.9	20.0	Max all	
R20		HV (worst case)	40.7	40.7	BICEMCO01	1.0	max all	3.0	11.5	-4			34.4	34.4	40.0			5.6	background	
R21		HV (worst case)	54.2	54.2	BICEMCO01	1.0	max all	3.0	10.1	-4			23.0	23.0	40.0			17.0	background	
R22		HV (worst case)	67.8	67.8	BICEMCO01	1.0	max all	3.0	9.7	-4			25.2	25.2	40.0			14.8	background	
R23		HV (worst case)	81.4	81.4	BICEMCO01	1.0	max all	3.0	9.5	-5			19.0	19.0	40.0			21.0	background	
R24		HV (worst case)	94.9	94.9	BICEMCO01	1.0	max all	3.0	9.7	-5			35.8	38.0	43.5			5.5	background	
R25		HV (worst case)	108.5	108.5	BICEMCO01	1.0	max all	3.0	10.6	-6			23.4	23.4	43.5			20.1	background	
R26		HV (worst case)	122.0	122.0	BICEMCO01	1.0	max all	3.0	11.7	-6			21.4	21.4	43.5			22.1	background	
R27		HV (worst case)	135.6	135.6	BICEMCO01	1.0	max all	3.0	12.3	-6			22.5	22.5	43.5			21.0	background	

(ROW) (COLUMN) NOTE:
R0 C1 EUT was tested in CM (Continuously Modulating) mode. No averaging applied, Peak data reported to demonstrate compliance.
R0 C11 NF/FF Boundary at lambda/2pi distance for small radiator.
R1 C12 40 dB/dec near field conversion factor, 20 dB/dec far-field conversion factors are permitted. 20dB is chosen to show compliance under worst case conversion.
R0 C13 When E-field is reported directly from Spectrum Analyzer, Antenna Factors and Cable losses are included directly in SA settings.
R0 C17 H-field is computed by subtracting dBΩ in freespace from E-Field measurements = 20*log(120π) = 51.5dB

4.3.2 Conducted Emissions Test Results - AC Power Port(s)

The results of emissions from the EUT's AC mains power port(s) are reported in Table 8.

Table 8: AC Mains Power Conducted Emissions Results.

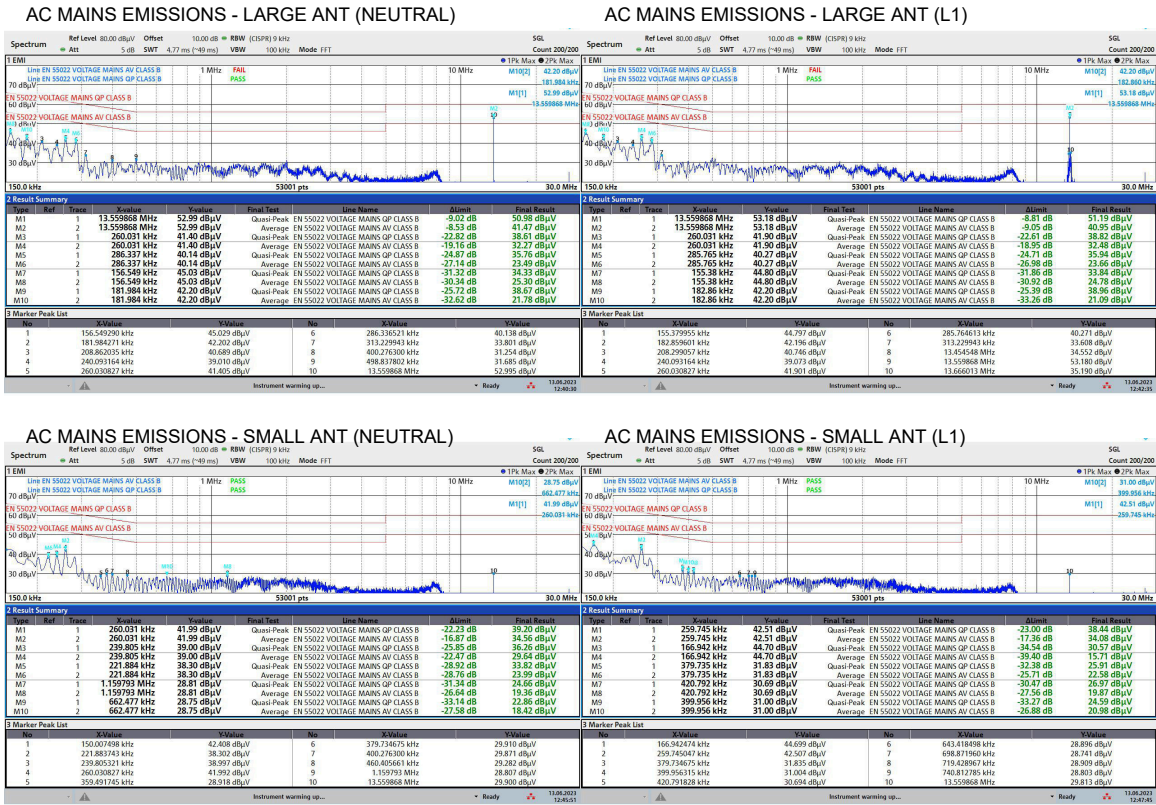

5 Measurement Uncertainty and Accreditation Documents

The maximum values of measurement uncertainty for the laboratory test equipment and facilities associated with each test are given in the table below. This uncertainty is computed for a 95.45% confidence level based on a coverage factor of $k = 2$.

Table 9: Measurement Uncertainty.

Measured Parameter	Measurement Uncertainty [†]
Radio Frequency	$\pm(f_{Mkr}/10^7 + RBW/10 + (SPN/(PTS - 1))/2 + 1 \text{ Hz})$
Conducted Emm. Amplitude	$\pm 1.9 \text{ dB}$
Radiated Emm. Amplitude ($f < 30 \text{ MHz}$)	$\pm 3.1 \text{ dB}$
Radiated Emm. Amplitude (30 – 200 MHz)	$\pm 4.0 \text{ dB}$
Radiated Emm. Amplitude (200 – 1000 MHz)	$\pm 5.2 \text{ dB}$
Radiated Emm. Amplitude ($f > 1000 \text{ MHz}$)	$\pm 3.7 \text{ dB}$

[†]Ref: CISPR 16-4-2:2011+A1:2014



Figure 9: Accreditation Documents