

DTS Test Report

regarding

USA: CFR Title 47, Part 15.247 (Emissions)
Canada: IC RSS-247/GENe (Emissions)

for

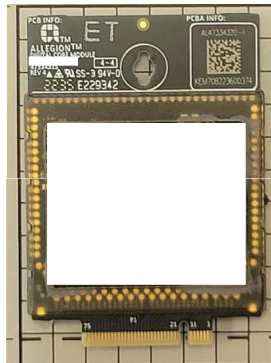

Model: 47334321

Category: DTS Module (BLE+WLAN)

Judgments:
FCC 15.247, ISED RSS-247v2 Compliant
Testing Completed: February 14, 2022



Prepared for:

Allegion, PLC

11819 North Pennsylvania Street, Carmel Indiana 46032 USA
Phone: +1 (317) 810-3362, Fax: +1 (317) 810-3193
Contact: Frank Nardelli, Frank.Nardelli@allegion.com

Data Rec./Rev. by: Joseph Brunett
Dr. Joseph Brunett, EMC-002790-NE

Rpt. Auth. by: Joseph Brunett
Dr. Joseph Brunett, EMC-002790-NE

Rpt. Prep./Rev. by: John Nantz
John Nantz

Date of Issue: February 14, 2022

Revision History

Rev. No.	Date	Details	Revised By
r0	February 14, 2022	Initial Release.	J. Brunett
r1	May 23, 2023	Add second variant.	J. Brunett

Contents

Revision History	2
Table of Contents	2
1 Test Report Scope and Limitations	5
1.1 Laboratory Authorization	5
1.2 Report Retention	5
1.3 Subcontracted Testing	5
1.4 Test Data	5
1.5 Limitation of Results	5
1.6 Copyright	5
1.7 Endorsements	5
1.8 Test Location	6
1.9 Traceability and Equipment Used	6
2 Test Specifications and Procedures	7
2.1 Test Specification and General Procedures	7
3 Configuration and Identification of the Equipment Under Test	8
3.1 Description and Declarations	8
3.1.1 EUT Configuration	9
3.1.2 Modes of Operation	9
3.1.3 Variants	9
3.1.4 Test Samples	10
3.1.5 Functional Exerciser	10
3.1.6 Modifications Made	10
3.1.7 Production Intent	10
3.1.8 Declared Exemptions and Additional Product Notes	10
4 Emissions	11
4.1 General Test Procedures	11
4.1.1 Radiated Test Setup and Procedures	11
4.1.2 Conducted Emissions Test Setup and Procedures	13
4.1.3 Power Supply Variation	14
4.2 Intentional Emissions	15
4.2.1 Duty and Transmission Cycle, Pulsed Operation	15
4.2.2 Fundamental Emission Bandwidth	17
4.2.3 Effective Isotropic Radiated Power	19
4.2.4 Power Spectral Density	20
4.3 Unintentional Emissions	22
4.3.1 Restricted Band Transmit Chain Spurious Emissions	22
4.3.2 OOB Transmit Chain Spurious Emissions	28
4.3.3 Radiated Digital Spurious	29
4.3.4 Conducted Emissions Test Results - AC Power Port(s)	30

5 Measurement Uncertainty and Accreditation Documents

31

List of Tables

1 Test Site List. 6
2 Equipment List. 6
3 EUT Declarations. 8
4 Pulsed Emission Characteristics (Duty Cycle). 15
5 Intentional Emission Bandwidth. 17
6 Radiated Power Results. 19
7 Power Spectral Density Results. 20
8 Transmit Chain Spurious Emissions. 22
8 Transmit Chain Spurious Emissions. 23
8 Transmit Chain Spurious Emissions. 24
8 Transmit Chain Spurious Emissions. 25
8 Transmit Chain Spurious Emissions. 26
8 Transmit Chain Spurious Emissions. 27
9 AC Mains Power Conducted Emissions Results. 30
10 Measurement Uncertainty. 31

List of Figures

1 Photos of EUT. 8
2 EUT Test Configuration Diagram. 9
3 Radiated Emissions Diagram of the EUT. 11
4 Radiated Emissions Test Setup Photograph(s). 12
5 Conducted RF Test Setup Photograph(s). 13
6 Conducted Emissions Setup Diagram of the EUT. 13
7 Conducted Emissions Test Setup Photograph(s). 14
8 Example Pulsed Emission Characteristics (Duty Cycle). 16
9 Example Intentional Emission Bandwidth Plots. 18
10 Power Spectral Density Plots. 21
11 Worst Case Transmitter OOB Emissions Measured. 28
12 Accreditation Documents 31

1 Test Report Scope and Limitations

1.1 Laboratory Authorization

Test Facility description and attenuation characteristics are on file with the FCC Laboratory, Columbia, Maryland (FCC Reg. No: US5348 and US5356) and with ISED Canada, Ottawa, ON (File Ref. No: 3161A and 24249). Amber Helm Development L.C. holds accreditation under NVLAP Lab Code 200129-0.

1.2 Report Retention

For equipment verified to comply with the regulations herein, the manufacturer is obliged to retain this report with the product records for the life of the product, and no less than ten years. A copy of this Report will remain on file with this laboratory until March 2032.

1.3 Subcontracted Testing

This report does not contain data produced under subcontract.

1.4 Test Data

This test report contains data included within the laboratory's scope of accreditation. Any data in this report that is not covered under the laboratory's scope is clearly identified.

1.5 Limitation of Results

The test results contained in this report relate only to the item(s) tested. Any electrical or mechanical modification made to the test item subsequent to the test date shall invalidate the data presented in this report. Any electrical or mechanical modification made to the test item subsequent to this test date shall require reevaluation.

1.6 Copyright

This report shall not be reproduced, except in full, without the written approval of Amber Helm Development L.C.

1.7 Endorsements

This report shall not be used to claim product endorsement by any accrediting, regulatory, or governmental agency.

1.8 Test Location

The EUT was fully tested by **Amber Helm Development L.C.**, headquartered at 92723 Michigan Hwy-152, Sister Lakes, Michigan 49047 USA. Table 1 lists all sites employed herein. Specific test sites utilized are also listed in the test results sections of this report where needed.

Table 1: Test Site List.

Description	Location	Quality Num.
OATS (3 meter)	3615 E Grand River Rd., Williamston, Michigan 48895	OATSC

1.9 Traceability and Equipment Used

Pertinent test equipment used for measurements at this facility is listed in Table 2. The quality system employed at Amber Helm Development L.C. has been established to ensure all equipment has a clearly identifiable classification, calibration expiry date, and that all calibrations are traceable to the SI through NIST, other recognized national laboratories, accepted fundamental or natural physical constants, ratio type of calibration, or by comparison to consensus standards.

Table 2: Equipment List.

Description	Manufacturer/Model	SN	Quality Num.	Cal/Ver By / Date Due
EMI Receiver	R & S / ESW26	101313	RSESW2601	RS / October-2023
Spectrum Analyzer	R & S / FSV30	101660	RSFSV30001	RS / Apr-2024
Pk/Avg Pwr Mtr	BK Prec. / RFP3008	620C22101	BKPM300801	BK / Mar-2024
Power Meter	R & S / NRP50S	101087	RSNRP50	RS / Nov-2024
BNC-BNC Coax	WRTL / RG58/U	001	CAB001-BLACK	AHD / Sept-2023
3.5-3.5MM Coax	PhaseFlex / PhaseFlex	001	CAB015-PURP	AHD / Jun-2023
Biconical	EMCO / 93110B	9802-3039	BICEMCO01	Keysight / Aug-2023
Log Periodic Antenna	EMCO / 3146	9305-3614	LOGEMCO01	Keysight / Aug-2023
Quad Ridge Horn	Singer / A6100	C35200	HQR1TO18S01	Keysight / Aug-2024
K-Band Horn	JEF / NRL Std.	001	HRNK01	AHD / Jul-2023

2 Test Specifications and Procedures

2.1 Test Specification and General Procedures

The goal of Allegion, PLC is to demonstrate that the Equipment Under Test (EUT) complies with the Rules and/or Directives below. Detailed in this report are the results of testing the Allegion, PLC Model: 47334321 for compliance to:

Country/Region	Rules or Directive	Referenced Section(s)
United States	Code of Federal Regulations	CFR Title 47, Part 15.247
Canada	ISED Canada	IC RSS-247/GENe

It has been determined that the equipment under test is subject to the rules and directives above at the date of this testing. In conjunction with these rules and directives, the following specifications and procedures are followed herein to demonstrate compliance (in whole or in part) with these regulations.

ANSI C63.4:2014	"Methods of Measurement of Radio-Noise Emissions from Low-Voltage Electrical and Electronic Equipment in the Range of 9 kHz to 40 GHz"
ANSI C63.10:2013	"American National Standard of Procedures for Compliance Testing of Unlicensed Wireless Devices"
KDB 558074 D01 v05r02	"GUIDANCE FOR COMPLIANCE MEASUREMENTS ON DIGITAL TRANSMISSION SYSTEM, FREQUENCY HOPPING SPREAD SPECTRUM SYSTEM, AND HYBRID SYSTEM DEVICES OPERATING UNDER SECTION 15.247 OF THE FCC RULES "
KDB 662911 D01v02r01	"Emissions Testing of Transmitters with Multiple Outputs in the Same Band"
KDB 662911 D02 v01	"MIMO with Cross-Polarized Antenna"
TP0102RA	"AHD Internal Document TP0102 - Radiated Emissions Test Procedure"
ICES-003; Issue 7 (2020)	"Information Technology Equipment (ITE) - Limits and methods of measurement"

3 Configuration and Identification of the Equipment Under Test

3.1 Description and Declarations

The EUT is wireless enabled module. The EUT is approximately 5 x 3.5 x 0.4 cm in dimension, and is depicted in Figure 1. It is powered by 3.3 VDC lock power system. This product is used as a wireless module in an electronic entry door latch. Table 3 outlines provider declared EUT specifications.

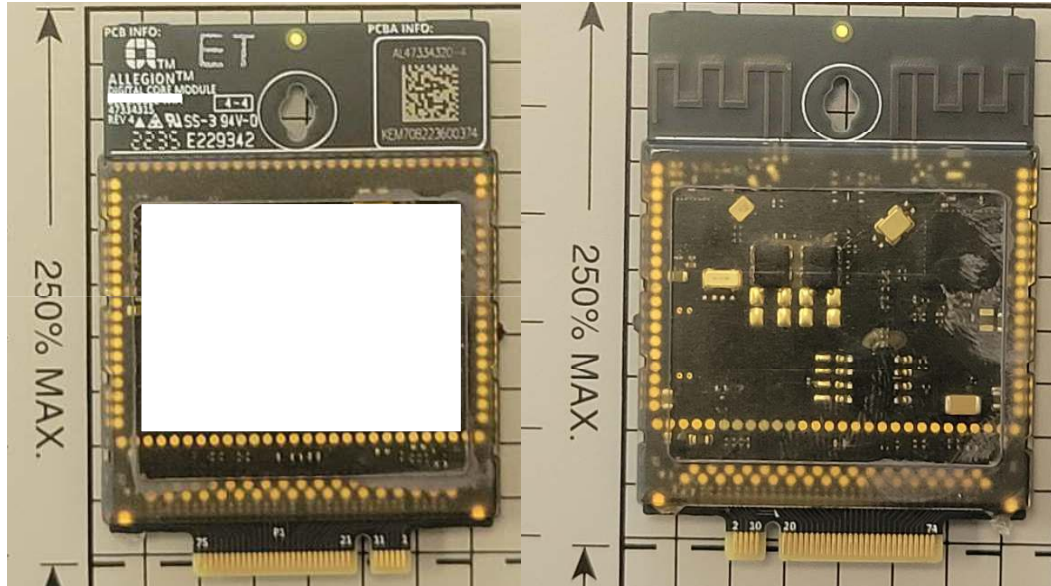

Figure 1: Photos of EUT.

Table 3: EUT Declarations.

General Declarations	
Equipment Type:	DTS Module (BLE+WLAN)
Country of Origin:	Not Declared
Nominal Supply:	3.3 VDC
Oper. Temp Range:	Not Declared
Frequency Range:	2400 – 2483.5 MHz
Antenna Dimension:	Integral
Antenna Type:	PCB Trace
Antenna Gain:	-2.0 dBi (meas.)
Number of Channels:	11(WLAN), 40(BLE)
Channel Spacing:	5 MHz(WLAN), 1 MHz(BLE)
Alignment Range:	Not Declared
Type of Modulation:	GFSK, OFDM
United States	
FCC ID Number:	XPB-47334321
Classification:	DTS
Canada	
IC Number:	8053B-47334321
Classification:	Spread Spectrum (2400-2483.5 MHz)

3.1.1 EUT Configuration

The EUT is configured for testing as depicted in Figure 2.

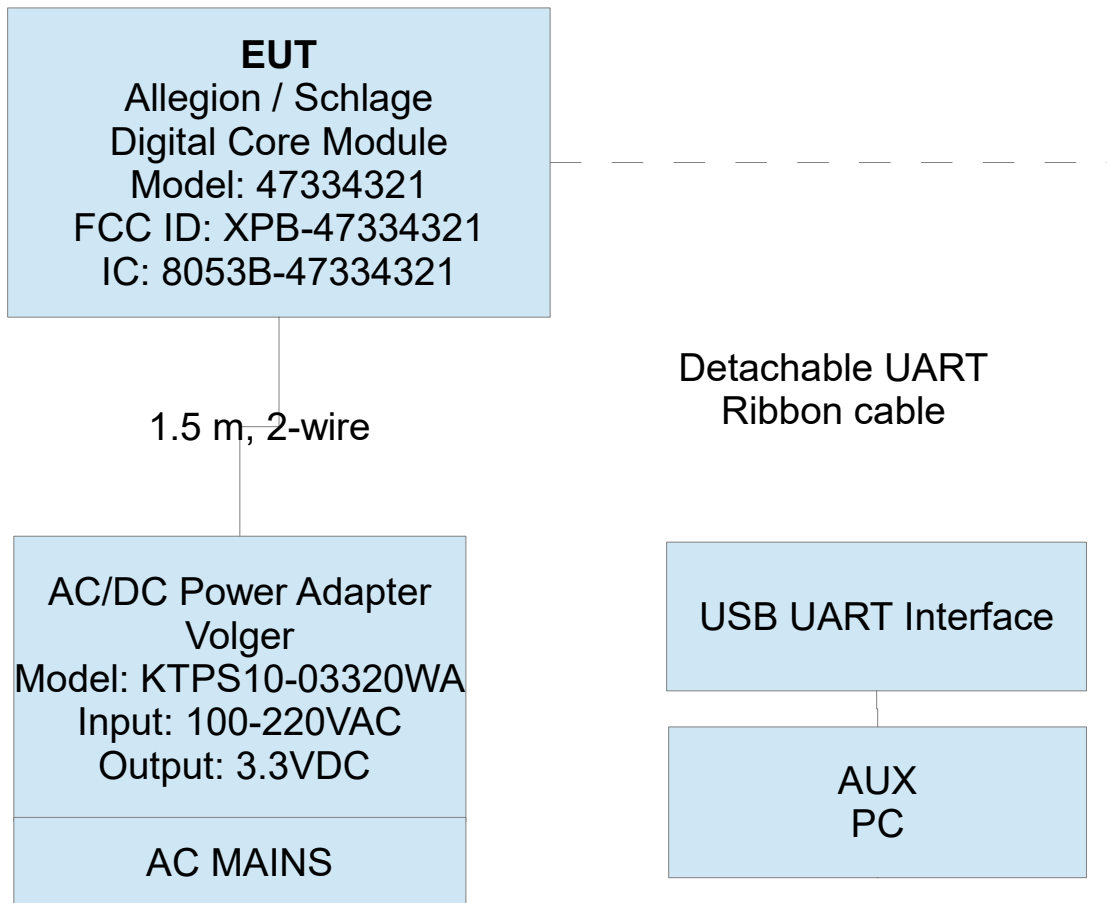

Figure 2: EUT Test Configuration Diagram.

3.1.2 Modes of Operation

The EUT is capable of operating in 802.11 b, g, n(20) SISO, and BLE modes. Test samples were placed into worst-case operating states (highest data rate, highest operating power that may be employed in each mode) using a PC serial UART interface that could be attached and then detached from the EUT during testing. The EUT was placed into maximum possible transmission on-time and measured in line with DTS guidelines. The EUT is also evaluated when co-located with associated RF tag reader modules (Access Core modules, FCC ID: XPB-47446672, IC: 8053B-47446672 and FCC ID: XPB-47446668, IC: 8053B-47446668) from this manufacturer.

3.1.3 Variants

There are two hardware variants of the EUT and which can populate either NXP (HVIN: 47334321) and Infineon (HVIN: 47677869) digital microprocessors to alleviate component shortage concerns. Both variants are otherwise identical devices and variant 47334321 is fully tested herein.

3.1.4 Test Samples

Three samples of the EUT were provided for emissions testing, two normal radiated samples and one sample with u.fl. connectors populated to allow for conducted RF port measurements. .

3.1.5 Functional Exerciser

Normal functionality was confirmed by measurement of transmitted signals.

3.1.6 Modifications Made

There were no modifications made to the EUT by this laboratory. However, in order to bring the device into compliance with band edge and inter-modulation spurious emissions observed during pretesting, the manufacturer has fixed the WLAN chipset power setting values to 16 for 11B/G/N, and 10 for BLE.

3.1.7 Production Intent

The EUT appears to be a production ready sample.

3.1.8 Declared Exemptions and Additional Product Notes

The EUT is a module, subject to further compliance evaluation in every host lockset into which it may be employed. The manufacturer intends to complete this testing via SDoC evaluation completed separately. Further, the EUT employs a unique power connector that is employed only by the module manufacturer, preventing its use in any device other than those tested and authorized by the module manufacturer.

4 Emissions

4.1 General Test Procedures

4.1.1 Radiated Test Setup and Procedures

Radiated electromagnetic emissions from the EUT are first pre-scanned in our screen room. Spectrum and modulation characteristics of all emissions are recorded. Instrumentation, including spectrum analyzers and other test equipment as detailed in Section 1.8 are employed. After pre-scan, emission measurements are made on the test site of record. If the EUT connects to auxiliary equipment and is table or floor standing, the configurations prescribed in relevant test standards are followed. Alternatively, a layout closest to normal use (as declared by the provider) is employed if the resulting emissions appear to be worst-case in such a configuration. See Figure 3. All intentionally radiating elements that are not fixed-mounted in use are placed on the test table lying flat, on their side, and on their end (3-axes) and the resulting worst case emissions are recorded. If the EUT is fixed-mounted in use, measurements are made with the device oriented in the manner consistent with installation and then emissions are recorded. If the EUT exhibits spurious emissions due to internal receiver circuitry, such emissions are measured with an appropriate carrier signal applied.

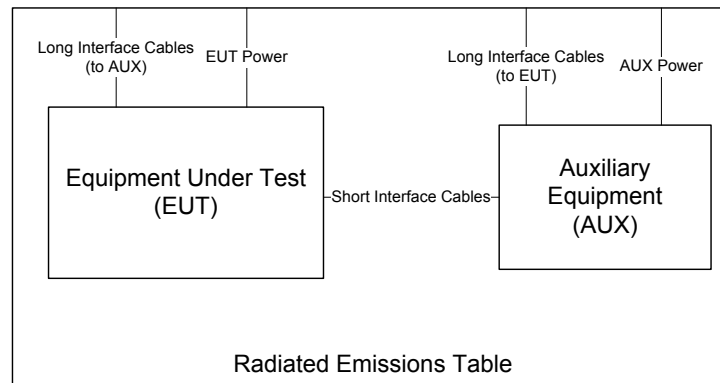

Figure 3: Radiated Emissions Diagram of the EUT.

For devices with intentional emissions below 30 MHz, a shielded loop antenna and/or E-field and H-Field broadband probes are used depending on the regulation. Shielded loops are placed at a 1 meter receive height at the desired measurement distance. For exposure in this band, 10cm diameter single-axis broadband probes meeting the requirements of ISED SPR-002 section 5.2 are employed. Measurements are repeated and summed over three axes, and the entire frequency range is measured with and without the EUT transmitting.

Emissions between 30 MHz and 1 GHz are measured using calibrated broadband antennas. For both horizontal and vertical polarizations, the test antenna is raised and lowered from 1 to 4 m in height until a maximum emission level is detected. The EUT is then rotated through 360° in azimuth until the highest emission is detected. The test antenna is then raised and lowered one last time from 1 to 4 m and the worst case value is recorded. Emissions above 1 GHz are characterized using standard gain or broadband ridge-horn antennas on our OATS with a 4×5 m rectangle of ECCOSORB absorber covering the OATS ground screen and a 1.5m table height. Care is taken to ensure that test receiver resolution and video bandwidths meet the regulatory requirements, and that the emission bandwidth of the EUT is not reduced. Photographs of the test setup employed are depicted in Figure 4.

Where regulations allow for direct measurement of field strength, power values (dBm) measured on the test receiver / analyzer are converted to $\text{dB}\mu\text{V}/\text{m}$ at the regulatory distance, using

$$E_{dist} = 107 + P_R + K_A - K_G + K_E - C_F$$

where P_R is the power recorded on spectrum analyzer, in dBm, K_A is the test antenna factor in dB/m, K_G is the combined pre-amplifier gain and cable loss in dB, K_E is duty correction factor (when applicable) in dB, and C_F is a distance conversion (employed only if limits are specified at alternate distance) in dB. This field strength value is then compared with the regulatory limit. If effective isotropic radiated power (EIRP) is computed, it is computed as

$$EIRP(\text{dBm}) = E_{3m}(\text{dB}\mu\text{V}/\text{m}) - 95.2.$$

When presenting data at each frequency, the highest measured emission under all possible EUT orientations (3-axes) is reported.



Figure 4: Radiated Emissions Test Setup Photograph(s).

4.1.2 Conducted Emissions Test Setup and Procedures

Transmit Antenna Port Conducted Emissions At least one sample EUT supplied for testing was provided with a 50Ω antenna port. Conducted transmit chain emissions measurements (where applicable) are made by connecting the EUT antenna port directly to the test receiver port. Photographs of the test setup employed are depicted in Figure 5.

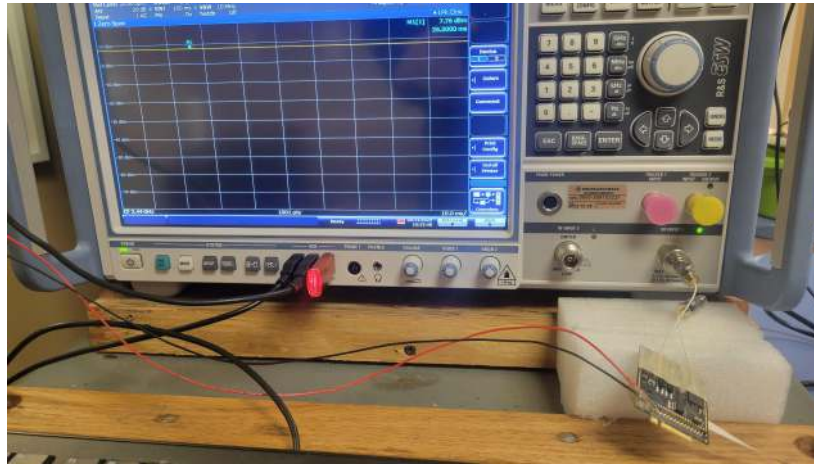

Figure 5: Conducted RF Test Setup Photograph(s).

AC Port Conducted Spurious For this device, AC power line conducted emissions are measured in our screen room. If the EUT connects to auxiliary equipment and is table or floor standing, the configurations prescribed in ANSI C63.4 / CISPR 22 are employed. Alternatively, an on-table layout more representative of actual use may be employed if the resulting emissions appear to be worst-case in such a configuration. See Figure 6.

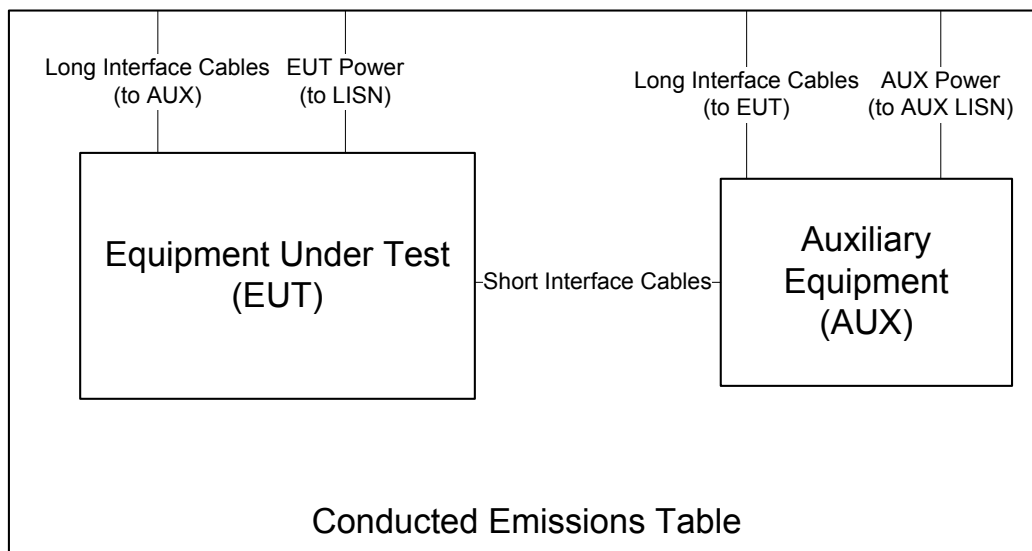

Figure 6: Conducted Emissions Setup Diagram of the EUT.

Conducted emissions are measured and recorded for each AC mains power source over the spectrum 0.15 MHz to 30 MHz for both the ungrounded (HI/PHASE) and grounded (LO/GND) conductors with the EUT placed in

its highest current draw operating mode(s). The test receiver is set to peak-hold mode in order to record the peak emissions throughout the course of functional operation. Only if an emission exceeds or is near the limit are quasi-peak and average detection applied. Photographs of the test setup employed are depicted in Figure 7.



Figure 7: Conducted Emissions Test Setup Photograph(s).

4.1.3 Power Supply Variation

Tests at extreme supply voltages are made if required by the procedures specified in the test standard, and results of this testing are detailed in this report.

In the case of this EUT, measurements of the worst-case radiated emissions are performed with the supply voltage varied by no less than 85% and 115% of the nominal rated value for devices connecting to AC power mains.

4.2 Intentional Emissions

4.2.1 Duty and Transmission Cycle, Pulsed Operation

The details and results of testing the EUT for pulsed operation are summarized in Table 4. Plots showing the measurements made to obtain these values are provided in Figure 8.

Table 4: Pulsed Emission Characteristics (Duty Cycle).

Test Date: 22-May-23
Test Engineer: Joseph Brunett
EUT: Allegion 47334321
Meas. Distance: Conducted

Test Mode Pulsed Operation / Average Measurement Duty Cycle								
#	Mode	Data Rate Mbps	Voltage V	Oper. Freq MHz	Pulse Length	Pulse Period	Duty Cycle %	Power Correction dB
R1	BLE, 500kBps	0.5	3.3	2440.0	-	-	100	0.00
R2	BLE, 1MBps	1.0	3.3	2440.0	-	-	100	0.00
R3	BLE, 2 MBps	2.0	3.3	2440.0	-	-	100	0.00
R4	802.11b	1.0	3.3	2437.0	-	-	100	0.00
R5	802.11g	6.0	3.3	2437.0	-	-	100	0.00
R6	802.11n(20)	11.0	3.3	2437.0	-	-	100	0.00
#	C1	C3	C4	C5	C6	C7	C8	C9

* Duty Cycle is measured in line with DTS guidance 558074 D01 v5 r02 section 6(b) for averaging only over full-power transmission pulses.

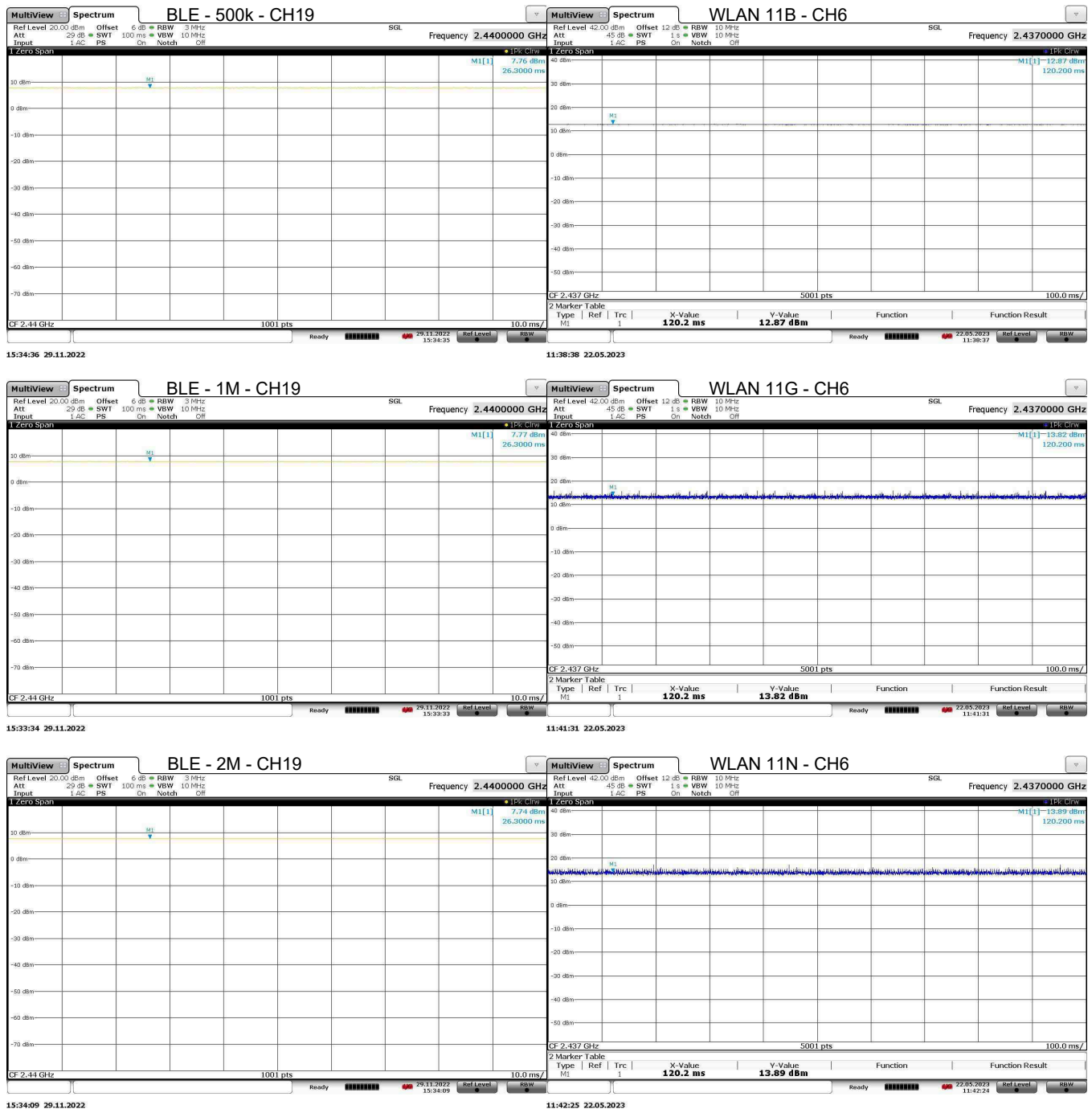

Figure 8: Example Pulsed Emission Characteristics (Duty Cycle).

4.2.2 Fundamental Emission Bandwidth

Emission bandwidth (EBW) of the EUT is measured with the device placed in the test mode(s) with the shortest available packet length and minimum packet spacing. Radiated emissions are recorded following the test procedures listed in Section 2.1. The 6 dB bandwidth is measured for the lowest, middle, and highest channels available. The 99% emission bandwidth per IC test procedures is also reported. The results of this testing are summarized in Table 5. Plots showing measurements employed obtain the emission bandwidths reported are provided in Figure 9.

Table 5: Intentional Emission Bandwidth.

Test Date: 22-May-23
Test Engineer: Joseph Brunett
EUT: Allegion 47334321
Meas. Distance: Conducted

#	Transmit Mode	Data Rate (Mbps)	Voltage (V)	Occupied Bandwidth				Pass/Fail
				Oper. Freq (MHz)	DTS 6 dB BW (MHz)	DTS 6 dB BW Limit (MHz)	99% OBW (MHz)	
R1	BLE, 500kBps	0.5	3.3	2402.0	0.67	0.50	1.08	Pass
R2				2440.0	0.68	0.50	1.08	Pass
R3				2480.0	0.67	0.50	1.08	Pass
R4	BLE, 1MBps	1.0	3.3	2402.0	0.74	0.50	1.04	Pass
R5				2440.0	0.74	0.50	1.04	Pass
R6				2480.0	0.74	0.50	1.04	Pass
R7	BLE, 2 MBps	2.0	3.3	2402.0	1.36	0.50	2.08	Pass
R8				2440.0	1.36	0.50	2.09	Pass
R9				2480.0	1.35	0.50	2.10	Pass
R10	802.11b	11.0	3.3	2412.0	8.33	0.50	14.80	Pass
R11				2437.0	8.63	0.50	14.83	Pass
R12				2462.0	7.64	0.50	14.45	Pass
R13	802.11g	54.0	3.3	2412.0	16.48	0.50	16.61	Pass
R14				2437.0	16.51	0.50	16.61	Pass
R15				2462.0	16.51	0.50	16.52	Pass
R16	802.11n(20)	65.0	3.3	2412.0	17.29	0.50	17.52	Pass
R17				2437.0	17.44	0.50	17.53	Pass
R18				2462.0	17.35	0.50	17.45	Pass
#	C1	C2	C3	C4	C5	C6	C7	C8

ROW COLUMN NOTE

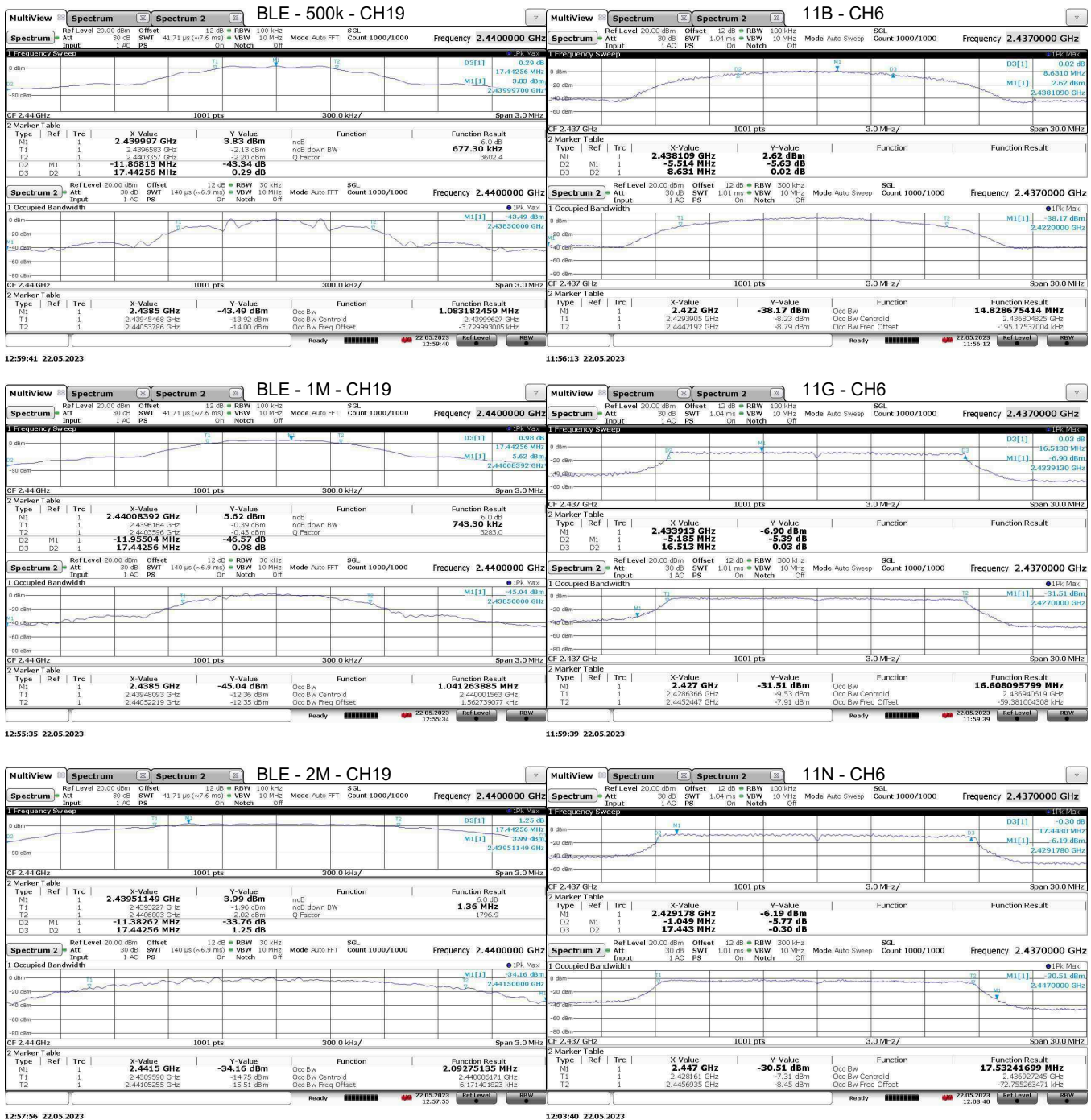

Figure 9: Example Intentional Emission Bandwidth Plots.

4.2.3 Effective Isotropic Radiated Power

The EUT’s radiated power is computed from antenna port conducted power measurements and the gain of the EUT antenna(s). Where the EUT is not sold with an antenna connector, a modified product has been provided including such. The results of this testing are summarized in Table 6.

Table 6: Radiated Power Results.

Test Date: 10-Apr-23
Test Engineer: Joseph Brunett
EUT: Allegion 47334321
Meas. Distance: Conducted

#	Mode	Channel	Fundamental Power										Pass dB	Comments
			Freq. MHz	Pout (Pk) dBm	Pout (Avg) dBm	Duty dB	Pout (Avg) + Duty dBm	Ant Gain dBi	EIRP (Avg) dBm	EIRP (Avg) Limit dBm				
R1	BLE, 500kBps	0	2402.0	9.6	9.4	0.0	9.4	2.0	11.4	36.0	24.6			
R2		19	2440.0	10.0	9.8	0.0	9.8	2.0	11.8	36.0	24.2			
R3		39	2480.0	9.6	9.3	0.0	9.3	2.0	11.3	36.0	24.7			
R4	BLE, 1MBps	0	2402.0	9.6	9.3	0.0	9.3	2.0	11.3	36.0	24.7			
R5		19	2440.0	9.7	9.5	0.0	9.5	2.0	11.5	36.0	24.5			
R6		39	2480.0	9.6	9.3	0.0	9.3	2.0	11.3	36.0	24.7			
R7	BLE, 2 MBps	0	2402.0	9.5	9.0	0.0	9.0	2.0	11.0	36.0	25.0			
R8		19	2440.0	9.6	9.3	0.0	9.3	2.0	11.3	36.0	24.7			
R9		39	2480.0	9.5	9.1	0.0	9.1	2.0	11.1	36.0	24.9			
R10	802.11B	1	2412.0	15.9	14.80	0.0	14.8	2.0	16.8	36.0	19.2			
R11		6	2437.0	16.2	14.80	0.0	14.8	2.0	16.8	36.0	19.2			
R12		11	2462.0	16.1	14.80	0.0	14.8	2.0	16.8	36.0	19.2			
R13	802.11G	1	2412.0	15.1	12.30	0.0	12.3	2.0	14.3	36.0	21.7			
R14		6	2437.0	15.3	12.30	0.0	12.3	2.0	14.3	36.0	21.7			
R15		11	2462.0	16.1	12.30	0.00	12.3	2.0	14.3	36.0	21.7			
R16	802.11N(20)	1	2412.0	15.6	12.20	0.00	12.2	2.0	14.2	36.0	21.8			
R17		6	2437.0	15.7	12.20	0.00	12.2	2.0	14.2	36.0	21.8			
R18		11	2462.0	16.0	12.20	0.00	12.2	2.0	14.2	36.0	21.8			
#	C1	C2	C3	C4	C5	C6	C7	C8	C9	C10	C11	C12		

(ROW) (COLUMN) NOTES
 ALL C8 Minimum allowed reported antenna gain of 2 dBi > EUT Ant Gain per ANSI C63.10 11.12.2.6
 ALL C4 Measured conducted per DTS Guidance 558074 D01 v5 r02 / ANSI C63.10 11.9.2.3.1 (AVGPM)
 ALL C5 Measured conducted per DTS Guidance 558074 D01 v5 r02 / ANSI C63.10 11.9.1.3 (PKPM1)

4.2.4 Power Spectral Density

For this test, the EUT was attached directly to the test receiver. Following FCC DTS measurement procedures, the emission spectrum is first scanned for maximum spectral peaks, the span and receiver bandwidth are then reduced until the power spectral density is measured in the prescribed receiver bandwidth. The results of this testing are summarized in Table 7. Plots showing how these measurements were made are depicted in Figure 10.

Table 7: Power Spectral Density Results.

Frequency Range	Detector	IF Bandwidth	Video Bandwidth	Test Date:	4-Dec-22
2400-2483.5	Pk	3 kHz	10 kHz	Test Engineer:	Joseph Brunett
				EUT:	Allegion 47334321
				Meas. Distance:	Conducted

3kHz Power Spectral Density							
#	Mode	Channel	Frequency (MHz)	Ant. Used	PSDcond (meas)* (dBm/3kHz)	PSD Limit (dBm/3kHz)	Pass By (dB)
R1	BLE, 500kBps	0	2402.0	Cond.	1.0	8.00	7.0
R2		19	2440.0	Cond.	1.7	8.00	6.3
R3		39	2480.0	Cond.	1.1	8.00	7.0
R4	BLE, 1MBps	0	2402.0	Cond.	-8.7	8.00	16.7
R5		19	2440.0	Cond.	-8.0	8.00	16.0
R6		39	2480.0	Cond.	-8.6	8.00	16.6
R7	BLE, 2 MBps	0	2402.0	Cond.	-10.5	8.00	18.5
R8		19	2440.0	Cond.	-9.8	8.00	17.8
R9		39	2480.0	Cond.	-10.4	8.00	18.4
R10	802.11b	1	2412.0	Cond.	-1.8	8.00	9.8
R11		6	2437.0	Cond.	-3.5	8.00	11.5
R12		11	2462.0	Cond.	-11.0	8.00	19.0
R13	802.11g	1	2412.0	Cond.	-13.6	8.00	21.6
R14		6	2437.0	Cond.	-13.3	8.00	21.3
R15		11	2462.0	Cond.	-11.9	8.00	19.9
R16	802.11n(20)	1	2412.0	Cond.	-13.7	8.00	21.7
R17		6	2437.0	Cond.	-12.3	8.00	20.3
R18		11	2462.0	Cond.	-12.8	8.00	20.8
#	C1	C2	C3	C4	C5	C6	C7

* PSD measured conducted following DTS guidance 558074 D01 v5 r02 8.4 / ANSI C63.10 11.10 PKPSD procedure.

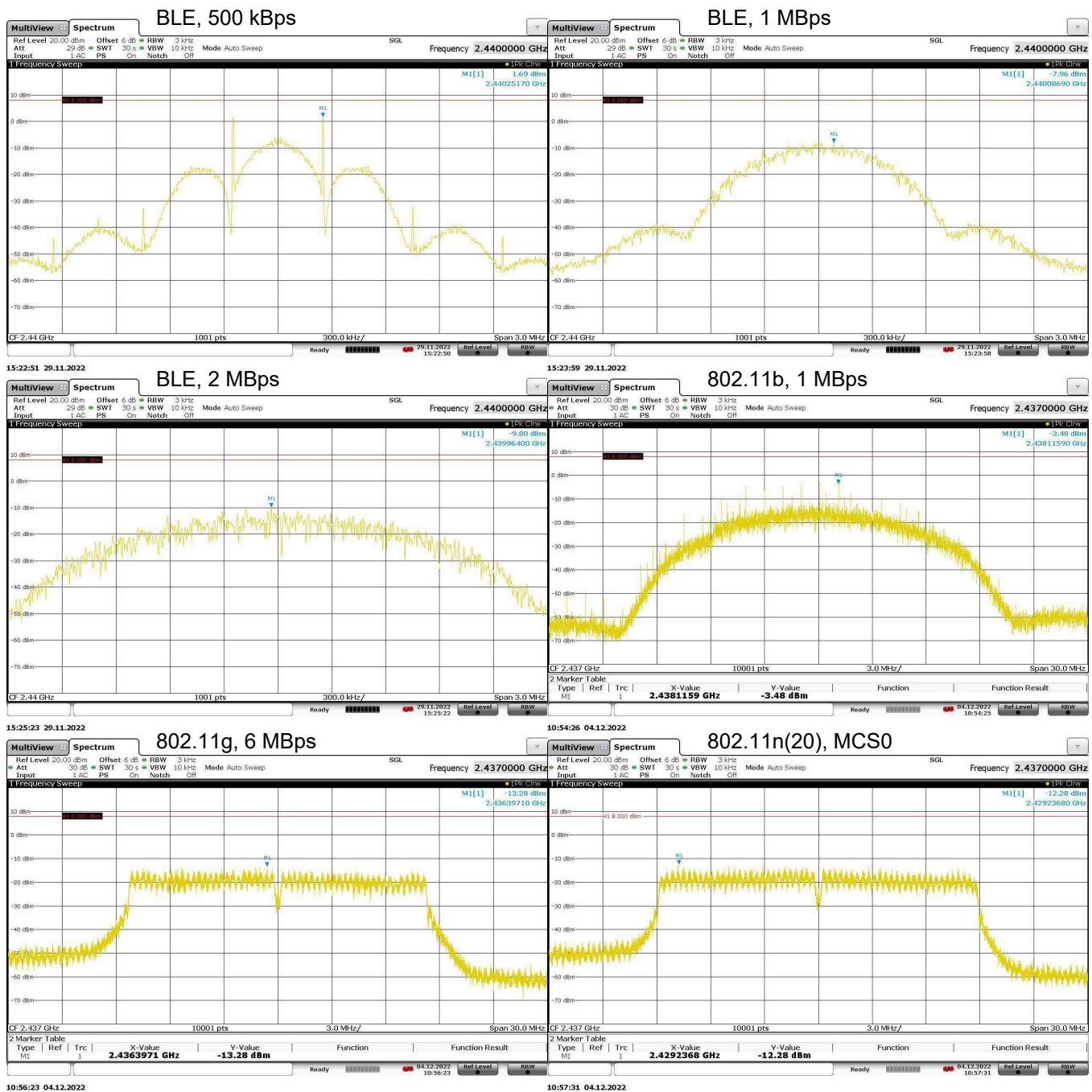

Figure 10: Power Spectral Density Plots.

4.3 Unintentional Emissions

4.3.1 Restricted Band Transmit Chain Spurious Emissions

The results for the measurement of transmit chain spurious emissions at the nominal voltage and temperature are provided in Table 8. Measurements are performed to 10 times the highest fundamental operating frequency.

Table 8(a): Transmit Chain Spurious Emissions.

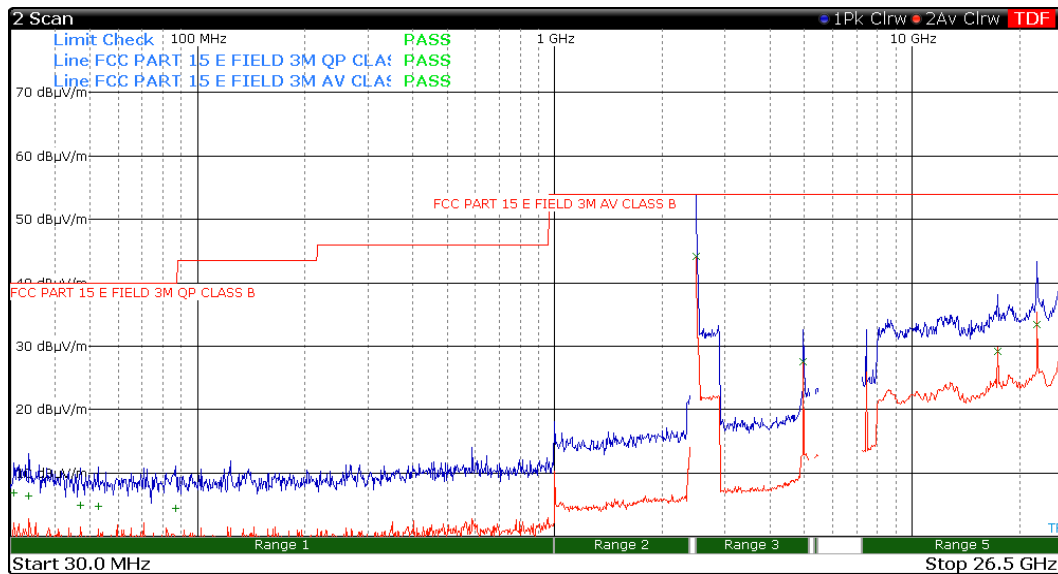

Frequency Range	Det	IF Bandwidth	Video Bandwidth	Test Date:	20-Jan-23
30 >= f > 1000 MHz	Pk/QPk	100 kHz	300 kHz	Test Engineer:	J. Brunett
f < 1000 MHz	Pk/Avg	1 MHz	3 MHz	EUT:	Allegion 47334321
				Meas. Distance:	Conducted

Transmitter Spurious in Restricted Bands														FCC/IC
R0	Mode	Frequency		Meas. Output Power		Ant Gain	GR Factor	Mode Duty	Electric Field @ 3m				Pass	Comments
		Start MHz	Stop MHz	Pk dBm	Qpk dBm				Meas. Pk dBuV/m	Limit Pk dBuV/m	Meas. Qpk dBuV/m	Limit Qpk dBuV/m		
R1	BLE, 500kBps	30	88	-90.2		2.0	6.0	0.0	13.0			40	27.0	max L,M,H channels or noise
R2	BLE, 500kBps	88	216	-91.1		2.0	6.0	0.0	12.1			43	30.9	max L,M,H channels or noise
R3	BLE, 500kBps	216	1000	-91.9		2.0	6.0	0.0	11.3			46	34.7	max L,M,H channels or noise
R4	Mode	Frequency		Output Power		Ant Gain	GR Factor	Mode Duty	Electric Field @ 3m				Pass	Comments
		Start MHz	Stop MHz	Pk dBm	Avg dBm				Meas. Pk dBuV/m	Limit Pk dBuV/m	Meas. Avg dBuV/m	Limit Avg dBuV/m		
R5	Fundamental Restricted Band Edge (Low Side)													
R6	BLE, 500kBps	2390.0	2390.0	-61.4	-71.4	2.0	0.0	0.0	35.8	74.0	25.8	54.0	28.2	max all - L,M,H channels
R7	Fundamental Restricted Band Edge (High Side)													
R8	BLE, 500kBps	2483.5	2483.5	-43.3	-53.3	2.0	0.0	0.0	53.9	74.0	43.9	54.0	10.1	max all - L,M,H channels
R9														
R10	BLE, 500kBps	4804.0	4804.0	-60.5	-70.4	2.0	0.0	0.0	36.7	74.0	26.8	54.0	27.2	max all - L channel
R11	BLE, 500kBps	4880.0	4880.0	-60.2	-70.1	2.0	0.0	0.0	37.0	74.0	27.1	54.0	26.9	max all - M channel
R12	BLE, 500kBps	4960.0	4960.0	-59.7	-69.6	2.0	0.0	0.0	37.5	74.0	27.6	54.0	26.4	max all - H channel
R13	BLE, 500kBps	7206.0	7206.0	-65.0	-74.9	2.0	0.0	0.0	32.2	74.0	22.3	54.0	31.7	max all - L channel
R13	BLE, 500kBps	7320.0	7320.0	-63.8	-73.1	2.0	0.0	0.0	33.4	74.0	24.1	54.0	29.9	max all - M channel
R13	BLE, 500kBps	7440.0	7440.0	-65.3	-72.0	2.0	0.0	0.0	31.9	74.0	25.2	54.0	28.8	max all - H channel
R14	BLE, 500kBps	1000.0	4000.0	-43.3	-53.3	2.0	0.0	0.0	53.9	74.0	43.9	54.0	10.1	max L,M,H channels or noise
R15	BLE, 500kBps	4000.0	6000.0	-59.7	-69.6	2.0	0.0	0.0	37.5	74.0	27.6	54.0	26.4	max L,M,H channels or noise
R16	BLE, 500kBps	6000.0	8400.0	-63.8	-72.0	2.0	0.0	0.0	33.4	74.0	25.2	54.0	28.8	max L,M,H channels or noise
R17	BLE, 500kBps	8400.0	12500.0	-63.7	-68.3	2.0	0.0	0.0	33.5	74.0	28.9	54.0	25.1	max L,M,H channels or noise
R18	BLE, 500kBps	12500.0	26000.0	-54.0	-58.9	2.0	0.0	0.0	43.2	74.0	38.3	54.0	15.7	max L,M,H channels or noise
#	C1	C2	C3	C4	C5	C6	C7	C8	C9	C10	C11	C12	C13	C14
(ROW)	(COLUMN)													
ALL	C4, C5	NOTES												
ALL	C6	Conducted measurements were made in line with DTS guidance 558074 D01 v5 r02 sections 8.5, 8.6, 8.7 / ANSI C63.10 11.10, 11.11, 11.12												
ALL	C7	Minimum allowed antenna gain per ANSI C63.10 11.12.2.6 set to 2 dBi. Measured antenna gain ~ -2 dBi.												
ALL	C9, C11	Ground Reflection Factor as described in ANSI C63.10-2013 section 11.12.2.2 (e)												
ALL		Computed according to ANSI C63.10-2013 section 11.12.2.2 (e)												

Table 8(b): Transmit Chain Spurious Emissions.

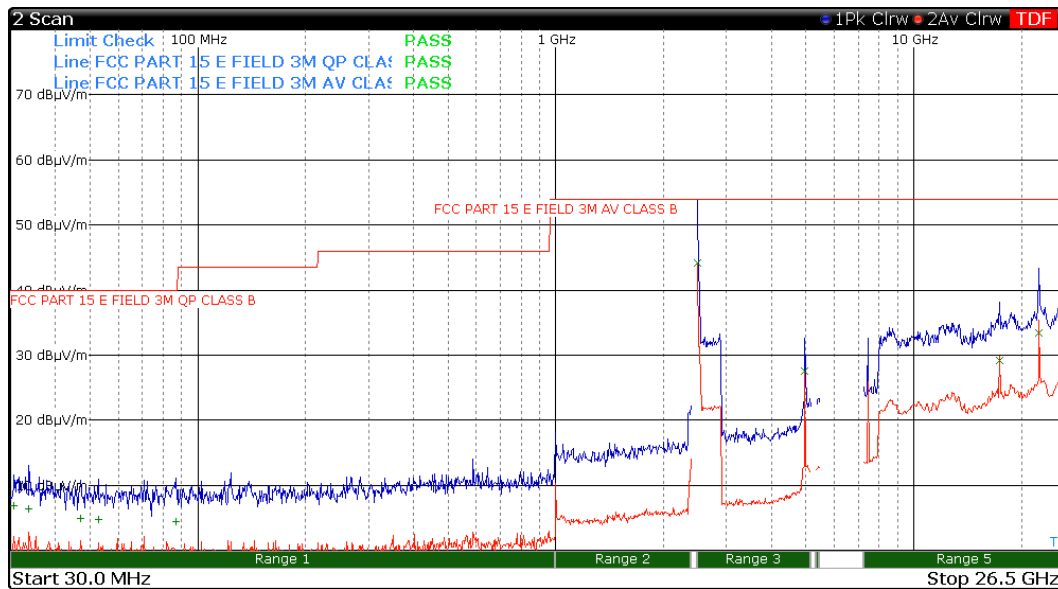

Frequency Range	Det	IF Bandwidth	Video Bandwidth	Test Date:	20-Jan-23
30 >= f > 1000 MHz	Pk/QPk	100 kHz	300 kHz	Test Engineer:	J. Brunett
f < 1000 MHz	Pk/Avg	1 MHz	3 MHz	EUT:	Allegion 47334321
				Meas. Distance:	Conducted

Transmitter Spurious in Restricted Bands													FCC/IC	
Mode	Frequency		Meas. Output Power		Ant Gain	GR Factor	Mode Duty	Electric Field @ 3m				Pass	Comments	
	Start MHz	Stop MHz	Pk dBm	Qpk dBm				Meas. Pk dBuV/m	Limit Pk dBuV/m	Meas. Avg dBuV/m	Limit Avg dBuV/m			
R0	BLE, 1MBps	30	88	-90.2	2.0	6.0	0.0	13.0			40	27.0	max L,M,H channels or noise	
R2	BLE, 1MBps	88	216	-91.1	2.0	6.0	0.0	12.1			43	30.9	max L,M,H channels or noise	
R3	BLE, 1MBps	216	1000	-91.9	2.0	6.0	0.0	11.3			46	34.7	max L,M,H channels or noise	
R4	Mode	Start MHz	Stop MHz	Output Power Pk dBm	Avg dBm	Ant Gain dBi	GR Factor dB	Mode Duty Cycle dB	Meas. Pk dBuV/m	Limit Pk dBuV/m	Meas. Avg dBuV/m	Limit Avg dBuV/m	Pass dB	Comments
R5	Fundamental Restricted Band Edge (Low Side)													
R6	BLE, 1MBps	2390.0	2390.0	-60.9	-70.9	2.0	0.0	0.0	36.3	74.0	26.3	54.0	27.7	max all - L,M,H channels
R7	Fundamental Restricted Band Edge (High Side)													
R8	BLE, 1MBps	2483.5	2483.5	-39.2	-49.2	2.0	0.0	0.0	58.0	74.0	48.0	54.0	6.0	max all - L,M,H channels
R9														
R10	BLE, 1MBps	4804.0	4804.0	-60.5	-70.4	2.0	0.0	0.0	36.7	74.0	26.8	54.0	27.2	max all - L channel
R11	BLE, 1MBps	4880.0	4880.0	-60.6	-70.5	2.0	0.0	0.0	36.6	74.0	26.7	54.0	27.3	max all - M channel
R12	BLE, 1MBps	4960.0	4960.0	-59.8	-69.7	2.0	0.0	0.0	37.4	74.0	27.5	54.0	26.5	max all - H channel
R13	BLE, 1MBps	7206.0	7206.0	-65.0	-75.9	2.0	0.0	0.0	32.2	74.0	21.3	54.0	32.7	max all - L channel
R13	BLE, 1MBps	7320.0	7320.0	-63.8	-71.9	2.0	0.0	0.0	33.4	74.0	25.3	54.0	28.7	max all - M channel
R13	BLE, 1MBps	7440.0	7440.0	-64.5	-71.0	2.0	0.0	0.0	32.7	74.0	26.2	54.0	27.8	max all - H channel
R14	BLE, 1MBps	1000.0	4000.0	-39.2	-49.2	2.0	0.0	0.0	58.0	74.0	48.0	54.0	6.0	max L,M,H channels or noise
R15	BLE, 1MBps	4000.0	6000.0	-59.8	-69.7	2.0	0.0	0.0	37.4	74.0	27.5	54.0	26.5	max L,M,H channels or noise
R16	BLE, 1MBps	6000.0	8400.0	-63.8	-71.0	2.0	0.0	0.0	33.4	74.0	26.2	54.0	27.8	max L,M,H channels or noise
R17	BLE, 1MBps	8400.0	12500.0	-63.7	-68.3	2.0	0.0	0.0	33.5	74.0	28.9	54.0	25.1	max L,M,H channels or noise
R18	BLE, 1MBps	12500.0	26000.0	-54.0	-58.9	2.0	0.0	0.0	43.2	74.0	38.3	54.0	15.7	max L,M,H channels or noise
#	C1	C2	C3	C4	C5	C6	C7	C8	C9	C10	C11	C12	C13	C14

(ROW) (COLUMN) NOTES
 ALL C4, C5 Conducted measurements were made in line with DTS guidance 558074 D01 v5 r02 sections 8.5, 8.6, 8.7 / ANSI C63.10 11.10, 11.11, 11.12
 ALL C6 Minimum allowed antenna gain per ANSI C63.10 11.12.2.6 set to 2 dBi. Measured antenna gain ~-2 dBi.
 ALL C7 Ground Reflection Factor as described in ANSI C63.10-2013 section 11.12.2.2 ©
 ALL C9, C11 Computed according to ANSI C63.10-2013 section 11.12.2.2 (e)

Table 8(c): Transmit Chain Spurious Emissions.

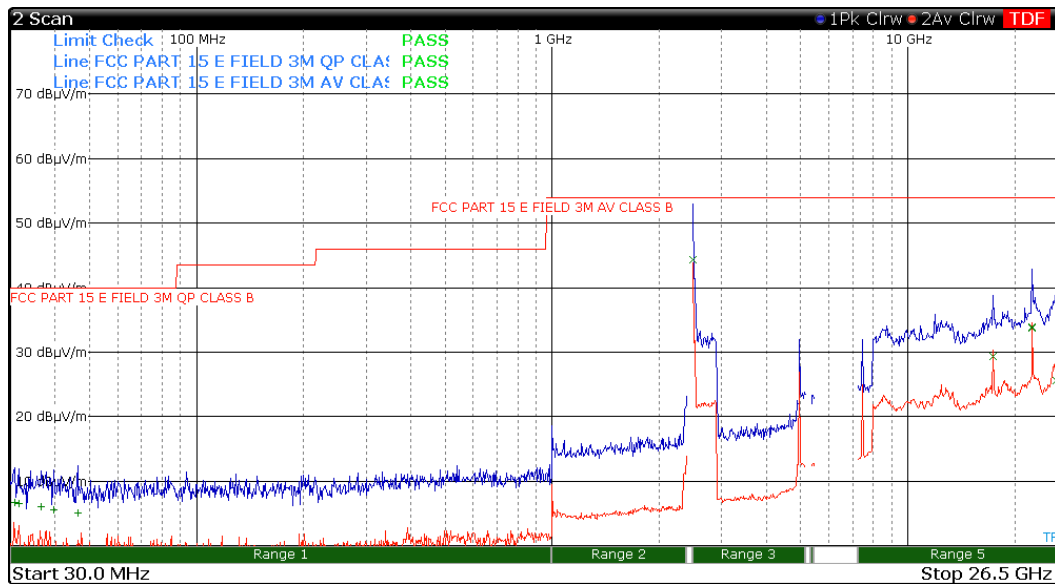

Frequency Range	Det	IF Bandwidth	Video Bandwidth	Test Date:	20-Jan-23
30 >= f > 1000 MHz	PK/QPk	100 kHz	300 kHz	Test Engineer:	J. Brunett
f < 1000 MHz	PK/Avg	1 MHz	3 MHz	EUT:	Allegion 47334321
				Meas. Distance:	Conducted

Transmitter Spurious in Restricted Bands														FCC/IC
Mode	Frequency		Meas. Output Power		Ant Gain	GR Factor	Mode Duty	Electric Field @ 3m				Pass	Comments	
	Start MHz	Stop MHz	Pk dBm	Qpk dBm				Meas. Pk dBuV/m	Limit Pk dBuV/m	Meas. Avg dBuV/m	Limit Avg dBuV/m			
R0	BLE, 2 MBps	30	88	-90.2	2.0	6.0	0.0	13.0	74.0	25.3	54.0	27.0	max L,M,H channels or noise	
R1	BLE, 2 MBps	88	216	-91.1	2.0	6.0	0.0	12.1	74.0	25.3	54.0	30.9	max L,M,H channels or noise	
R2	BLE, 2 MBps	216	1000	-91.9	2.0	6.0	0.0	11.3	74.0	25.3	54.0	34.7	max L,M,H channels or noise	
R3	BLE, 2 MBps	216	1000	-91.9	2.0	6.0	0.0	11.3	74.0	25.3	54.0	34.7	max L,M,H channels or noise	
R4	BLE, 2 MBps	2390.0	2390.0	-61.9	-71.9	2.0	0.0	0.0	35.3	74.0	25.3	54.0	28.7	max all - L,M,H channels
R5	BLE, 2 MBps	2483.5	2483.5	-42.9	-52.9	2.0	0.0	0.0	54.3	74.0	44.3	54.0	9.7	max all - L,M,H channels
R6	BLE, 2 MBps	4804.0	4804.0	-60.5	-70.4	2.0	0.0	0.0	36.7	74.0	26.8	54.0	27.2	max all - L channel
R7	BLE, 2 MBps	4880.0	4880.0	-60.6	-70.5	2.0	0.0	0.0	36.6	74.0	26.7	54.0	27.3	max all - M channel
R8	BLE, 2 MBps	4960.0	4960.0	-66.8	-76.7	2.0	0.0	0.0	30.4	74.0	20.5	54.0	33.5	max all - H channel
R9	BLE, 2 MBps	7206.0	7206.0	-65.0	-75.9	2.0	0.0	0.0	32.2	74.0	21.3	54.0	32.7	max all - L channel
R10	BLE, 2 MBps	7320.0	7320.0	-63.8	-71.9	2.0	0.0	0.0	33.4	74.0	25.3	54.0	28.7	max all - M channel
R11	BLE, 2 MBps	7440.0	7440.0	-64.5	-71.0	2.0	0.0	0.0	32.7	74.0	26.2	54.0	27.8	max all - H channel
R12	BLE, 2 MBps	1000.0	4000.0	-42.9	-52.9	2.0	0.0	0.0	54.3	74.0	44.3	54.0	9.7	max L,M,H channels or noise
R13	BLE, 2 MBps	4000.0	6000.0	-60.5	-70.4	2.0	0.0	0.0	36.7	74.0	26.8	54.0	27.2	max L,M,H channels or noise
R14	BLE, 2 MBps	6000.0	8400.0	-63.8	-71.0	2.0	0.0	0.0	33.4	74.0	26.2	54.0	27.8	max L,M,H channels or noise
R15	BLE, 2 MBps	8400.0	12500.0	-63.7	-68.3	2.0	0.0	0.0	33.5	74.0	28.9	54.0	25.1	max L,M,H channels or noise
R16	BLE, 2 MBps	12500.0	26000.0	-54.0	-58.9	2.0	0.0	0.0	43.2	74.0	38.3	54.0	15.7	max L,M,H channels or noise
R17	BLE, 2 MBps	12500.0	26000.0	-54.0	-58.9	2.0	0.0	0.0	43.2	74.0	38.3	54.0	15.7	max L,M,H channels or noise

(ROW)	(COLUMN)	NOTES
ALL	C4, C5	Conducted measurements were made in line with DTS guidance 558074 D01 v5 r02 sections 8.5, 8.6, 8.7 / ANSI C63.10 11.10, 11.11, 11.12
ALL	C6	Minimum allowed antenna gain per ANSI C63.10 11.12.2.6 set to 2 dBi. Measured antenna gain ~ -2 dBi.
ALL	C7	Ground Reflection Factor as described in ANSI C63.10-2013 section 11.12.2.2 ©
ALL	C9, C11	Computed according to ANSI C63.10-2013 section 11.12.2.2 (e)

Table 8(d): Transmit Chain Spurious Emissions.

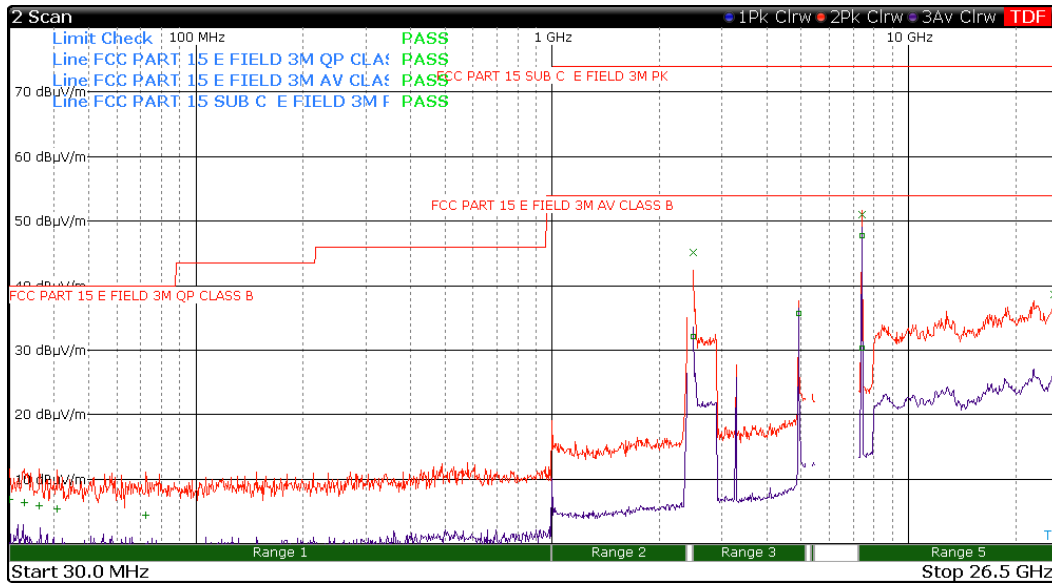

Frequency Range 30 >= f > 1000 MHz f < 1000 MHz	Det Pk/QPk PK/Avg	IF Bandwidth 100 kHz 1 MHz	Video Bandwidth 300 kHz 3 MHz	Test Date: 22-May-23	EUT: Allegion 47334321
				Test Engineer: J. Brunett	Meas. Distance: Conducted

Transmitter Spurious in Restricted Bands														FCC/IC
Mode	Frequency		Meas. Output Power		Ant Gain	GR Factor	Mode Duty	Electric Field @ 3m				Pass	Comments	
	Start MHz	Stop MHz	Pk dBm	Qpk dBm				Meas. Pk dBuV/m	Limit Pk dBuV/m	Meas. Avg dBuV/m	Limit Avg dBuV/m			
R0	802.11b	30	88	-90.2	2.0	6.0	0.0	13.0	40	27.0		max L,M,H channels or noise		
R2	802.11b	88	216	-91.1	2.0	6.0	0.0	12.1	43	30.9		max L,M,H channels or noise		
R3	802.11b	216	1000	-91.9	2.0	6.0	0.0	11.3	46	34.7		max L,M,H channels or noise		
R4	Mode	Start MHz	Stop MHz	Output Power Pk dBm	Avg dBm	Ant Gain dBi	GR Factor dB	Mode Duty Cycle dB	Meas. Pk dBuV/m	Limit Pk dBuV/m	Meas. Avg dBuV/m	Limit Avg dBuV/m	Pass dB	Comments
R5	Fundamental Restricted Band Edge (Low Side)													
R6	802.11b	2390.0	2390.0	-65.3	-69.2	2.0	0.0	0.0	31.9	74.0	28.0	54.0	26.0	max all - L,M,H channels
R7	Fundamental Restricted Band Edge (High Side)													
R8	802.11b	2483.5	2483.5	-55.2	-66.6	2.0	0.0	0.0	42.0	74.0	30.6	54.0	23.4	max all - L,M,H channels
R9														
R10	802.11b	4824.0	4824.0	-66.8	-67.4	2.0	0.0	0.0	30.4	74.0	29.8	54.0	24.2	max all - L channel
R11	802.11b	4874.0	4874.0	-64.0	-65.2	2.0	0.0	0.0	33.2	74.0	32.0	54.0	22.0	max all - M channel
R12	802.11b	4924.0	4924.0	-60.7	-61.5	2.0	0.0	0.0	36.5	74.0	35.7	54.0	18.3	max all - H channel
R13	802.11b	7236.0	7236.0	-57.1	-60.0	2.0	0.0	0.0	40.1	74.0	37.2	54.0	16.8	max all - L channel
R13	802.11b	7311.0	7311.0	-48.9	-52.0	2.0	0.0	0.0	48.3	74.0	45.2	54.0	8.8	max all - M channel
R13	802.11b	7386.0	7386.0	-45.5	-48.1	2.0	0.0	0.0	51.7	74.0	49.1	54.0	4.9	max all - H channel
R14	802.11b	1000.0	4000.0	-55.2	-66.6	2.0	0.0	0.0	42.0	74.0	30.6	54.0	23.4	max L,M,H channels or noise
R15	802.11b	4000.0	6000.0	-60.7	-61.5	2.0	0.0	0.0	36.5	74.0	35.7	54.0	18.3	max L,M,H channels or noise
R16	802.11b	6000.0	8400.0	-45.5	-48.1	2.0	0.0	0.0	51.7	74.0	49.1	54.0	4.9	max L,M,H channels or noise
R17	802.11b	8400.0	12500.0	-63.7	-68.3	2.0	0.0	0.0	33.5	74.0	28.9	54.0	25.1	max L,M,H channels or noise
R18	802.11b	12500.0	26000.0	-54.0	-66.6	2.0	0.0	0.0	43.2	74.0	30.6	54.0	23.4	max L,M,H channels or noise
#	C1	C2	C3	C4	C5	C6	C7	C8	C9	C10	C11	C12	C13	C14

(ROW) (COLUMN) NOTES
 ALL C4, C5 Conducted measurements were made in line with DTS guidance 558074 D01 v5 r02 sections 8.5, 8.6, 8.7 / ANSI C63.10 11.10, 11.11, 11.12
 ALL C6 Minimum allowed antenna gain per ANSI C63.10 11.12.2.6 set to 2 dBi. Measured antenna gain ~ -2 dBi.
 ALL C7 Ground Reflection Factor as described in ANSI C63.10-2013 section 11.12.2.2 ©
 ALL C9, C11 Computed according to ANSI C63.10-2013 section 11.12.2.2 (e)

Table 8(e): Transmit Chain Spurious Emissions.

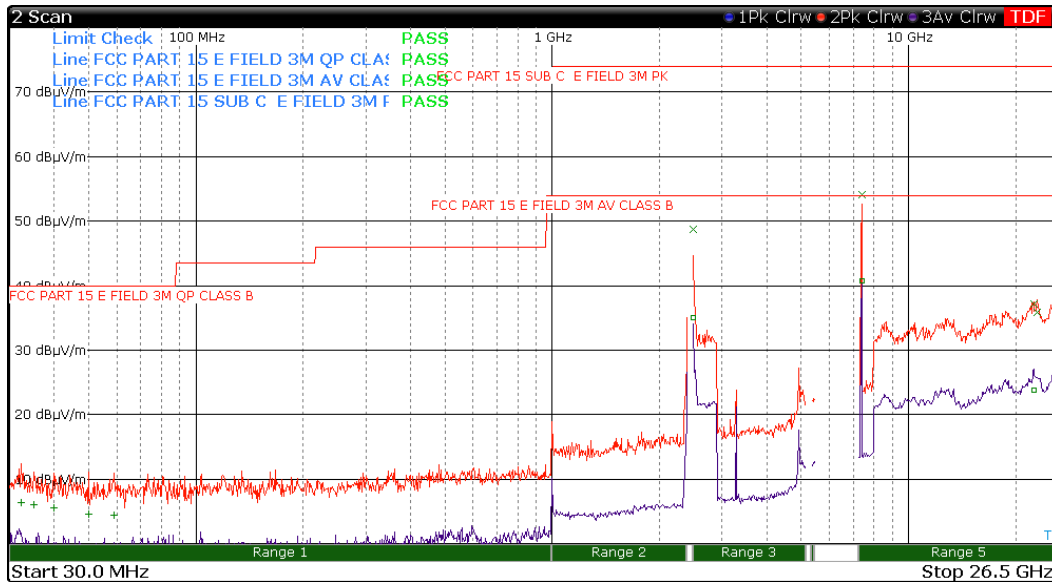

Frequency Range	Det	IF Bandwidth	Video Bandwidth	Test Date:	22-May-23
30 >= f > 1000 MHz	Pk/QPk	100 kHz	300 kHz	Test Engineer:	J. Brunett
f < 1000 MHz	Pk/Avg	1 MHz	3 MHz	EUT:	Allegion 47334321
				Meas. Distance:	Conducted

Transmitter Spurious in Restricted Bands														FCC/IC
R#	Mode	Frequency		Meas. Output Power		Ant Gain	GR Factor	Mode Duty	Electric Field @ 3m				Pass	Comments
		Start MHz	Stop MHz	Pk dBm	Qpk dBm				Meas. Pk dBuV/m	Limit Pk dBuV/m	Meas. Avg dBuV/m	Limit Avg dBuV/m		
R1	802.11g	30	88	-90.2		2.0	6.0	0.0	13.0			40	27.0	max L,M,H channels or noise
R2	802.11g	88	216	-91.1		2.0	6.0	0.0	12.1			43	30.9	max L,M,H channels or noise
R3	802.11g	216	1000	-91.9		2.0	6.0	0.0	11.3			46	34.7	max L,M,H channels or noise
R4	Mode	Start MHz	Stop MHz	Output Power Pk dBm	Avg dBm	Ant Gain dBi	GR Factor dB	Mode Duty Cycle dB	Meas. Pk dBuV/m	Limit Pk dBuV/m	Meas. Avg dBuV/m	Limit Avg dBuV/m	Pass dB	Comments
R5	Fundamental Restricted Band Edge (Low Side)													
R6	802.11g	2390.0	2390.0	-48.3	-63.8	2.0	0.0	0.0	48.9	74.0	33.4	54.0	20.6	max all - L,M,H channels
R7	Fundamental Restricted Band Edge (High Side)													
R8	802.11g	2483.5	2483.5	-48.5	-62.2	2.0	0.0	0.0	48.7	74.0	35.0	54.0	19.0	max all - L,M,H channels
R9														
R10	802.11g	4824.0	4824.0	-45.4	-55.3	2.0	0.0	0.0	51.8	74.0	41.9	54.0	12.1	max all - L channel
R11	802.11g	4874.0	4874.0	-45.7	-55.6	2.0	0.0	0.0	51.5	74.0	41.6	54.0	12.4	max all - M channel
R12	802.11g	4924.0	4924.0	-43.8	-53.7	2.0	0.0	0.0	53.4	74.0	43.5	54.0	10.5	max all - H channel
R13	802.11g	7236.0	7236.0	-41.2	-58.2	2.0	0.0	0.0	56.0	74.0	39.0	54.0	15.0	max all - L channel
R13	802.11g	7311.0	7311.0	-41.9	-57.0	2.0	0.0	0.0	55.3	74.0	40.2	54.0	13.8	max all - M channel
R13	802.11g	7386.0	7386.0	-43.0	-56.5	2.0	0.0	0.0	54.2	74.0	40.7	54.0	13.3	max all - H channel
R14	802.11g	1000.0	4000.0	-48.3	-62.2	2.0	0.0	0.0	48.9	74.0	35.0	54.0	19.0	max L,M,H channels or noise
R15	802.11g	4000.0	6000.0	-43.8	-53.7	2.0	0.0	0.0	53.4	74.0	43.5	54.0	10.5	max L,M,H channels or noise
R16	802.11g	6000.0	8400.0	-41.2	-56.5	2.0	0.0	0.0	56.0	74.0	40.7	54.0	13.3	max L,M,H channels or noise
R17	802.11g	8400.0	12500.0	-63.7	-68.3	2.0	0.0	0.0	33.5	74.0	28.9	54.0	25.1	max L,M,H channels or noise
R18	802.11g	12500.0	26000.0	-54.0	-66.6	2.0	0.0	0.0	43.2	74.0	30.6	54.0	23.4	max L,M,H channels or noise
#	C1	C2	C3	C4	C5	C6	C7	C8	C9	C10	C11	C12	C13	C14

(ROW) (COLUMN) NOTES
 ALL C4, C5 Conducted measurements were made in line with DTS guidance 558074 D01 v5 r02 sections 8.5, 8.6, 8.7 / ANSI C63.10 11.10, 11.11, 11.12
 ALL C6 Minimum allowed antenna gain per ANSI C63.10 11.12.2.6 set to 2 dBi. Measured antenna gain ~ -2 dBi.
 ALL C7 Ground Reflection Factor as described in ANSI C63.10-2013 section 11.12.2.2 ©
 ALL C9, C11 Computed according to ANSI C63.10-2013 section 11.12.2.2 (e)

Table 8(f): Transmit Chain Spurious Emissions.

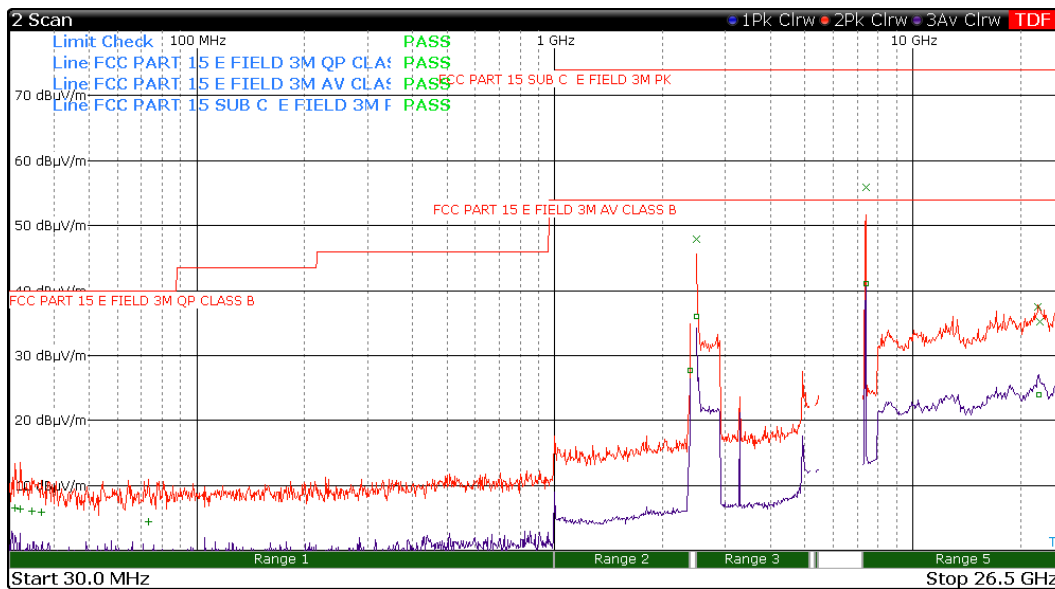

Frequency Range 30 >= f > 1000 MHz f < 1000 MHz	Det Pk/QPk Pk/Avg	IF Bandwidth 100 kHz 1 MHz	Video Bandwidth 300 kHz 3 MHz	Test Date: 22-May-23	EUT: Allegion 47334321
				Test Engineer: J. Brunnett	Meas. Distance: Conducted

Transmitter Spurious in Restricted Bands														FCC/IC
R#	Mode	Frequency		Meas. Output Power		Ant Gain	GR Factor	Mode Duty	Electric Field @ 3m				Pass	Comments
		Start MHz	Stop MHz	Pk dBm	Qpk dBm				Meas. Pk dBuV/m	Limit Pk dBuV/m	Meas. Avg dBuV/m	Limit Avg dBuV/m		
R0														
R1	802.11n(20)	30	88	-91.0		2.0	6.0	0.0	12.2			40	27.8	max L,M,H channels or noise
R2	802.11n(20)	88	216	-91.1		2.0	6.0	0.0	12.1			43	30.9	max L,M,H channels or noise
R3	802.11n(20)	216	1000	-91.9		2.0	6.0	0.0	11.3			46	34.7	max L,M,H channels or noise
R4														
R5	Fundamental Restricted Band Edge (Low Side)													
R6	802.11n(20)	2390.0	2390.0	-44.9	-62.0	2.0	0.0	0.0	52.3	74.0	35.2	54.0	18.8	max all - L,M,H channels
R7	Fundamental Restricted Band Edge (High Side)													
R8	802.11n(20)	2483.5	2483.5	-49.3	-61.1	2.0	0.0	0.0	47.9	74.0	36.1	54.0	17.9	max all - L,M,H channels
R9														
R10	802.11n(20)	4824.0	4824.0	-45.4	-55.3	2.0	0.0	0.0	51.8	74.0	41.9	54.0	12.1	max all - L channel
R11	802.11n(20)	4874.0	4874.0	-45.7	-55.6	2.0	0.0	0.0	51.5	74.0	41.6	54.0	12.4	max all - M channel
R12	802.11n(20)	4924.0	4924.0	-43.8	-53.7	2.0	0.0	0.0	53.4	74.0	43.5	54.0	10.5	max all - H channel
R13	802.11n(20)	7236.0	7236.0	-41.5	-57.2	2.0	0.0	0.0	55.7	74.0	40.0	54.0	14.0	max all - L channel
R13	802.11n(20)	7311.0	7311.0	-42.9	-57.2	2.0	0.0	0.0	54.3	74.0	40.0	54.0	14.0	max all - M channel
R13	802.11n(20)	7386.0	7386.0	-41.4	-56.1	2.0	0.0	0.0	55.8	74.0	41.1	54.0	12.9	max all - H channel
R14	802.11n(20)	1000.0	4000.0	-44.9	-61.1	2.0	0.0	0.0	52.3	74.0	36.1	54.0	17.9	max L,M,H channels or noise
R15	802.11n(20)	4000.0	6000.0	-43.8	-53.7	2.0	0.0	0.0	53.4	74.0	43.5	54.0	10.5	max L,M,H channels or noise
R16	802.11n(20)	6000.0	8400.0	-41.4	-56.1	2.0	0.0	0.0	55.8	74.0	41.1	54.0	12.9	max L,M,H channels or noise
R17	802.11n(20)	8400.0	12500.0	-63.7	-68.3	2.0	0.0	0.0	33.5	74.0	28.9	54.0	25.1	max L,M,H channels or noise
R18	802.11n(20)	12500.0	26000.0	-49.5	-51.6	2.0	0.0	0.0	47.7	74.0	45.6	54.0	8.4	max L,M,H channels or noise
#	C1	C2	C3	C4	C5	C6	C7	C8	C9	C10	C11	C12	C13	C14

(ROW) (COLUMN) NOTES
 ALL C4, C5 Conducted measurements were made in line with DTS guidance 558074 D01 v5 r02 sections 8.5, 8.6, 8.7 / ANSI C63.10 11.10, 11.11, 11.12
 ALL C6 Minimum allowed antenna gain per ANSI C63.10 11.12.2.6 set to 2 dBi. Measured antenna gain ~ -2 dBi.
 ALL C7 Ground Reflection Factor as described in ANSI C63.10-2013 section 11.12.2.2 ©
 ALL C9, C11 Computed according to ANSI C63.10-2013 section 11.12.2.2 (e)

4.3.2 OOB Transmit Chain Spurious Emissions

The results for the measurement of transmit chain spurious emissions relative to the fundamental in a 100 kHz receiver bandwidth (at the nominal voltage and temperature) in the worst cases are provided in Figure 11 below.



Figure 11: Worst Case Transmitter OOB Emissions Measured.

4.3.3 Radiated Digital Spurious

The results for the measurement of digital spurious emissions are not reported herein as all digital emissions were greater than 20 dB below the regulatory limit. Radiation from digital components was measured to 1 GHz, or to five times the maximum digital component operating frequency, whichever is greater.

4.3.4 Conducted Emissions Test Results - AC Power Port(s)

The results of emissions from the EUT's AC mains power port(s) are reported in Table 9.

Table 9: AC Mains Power Conducted Emissions Results.

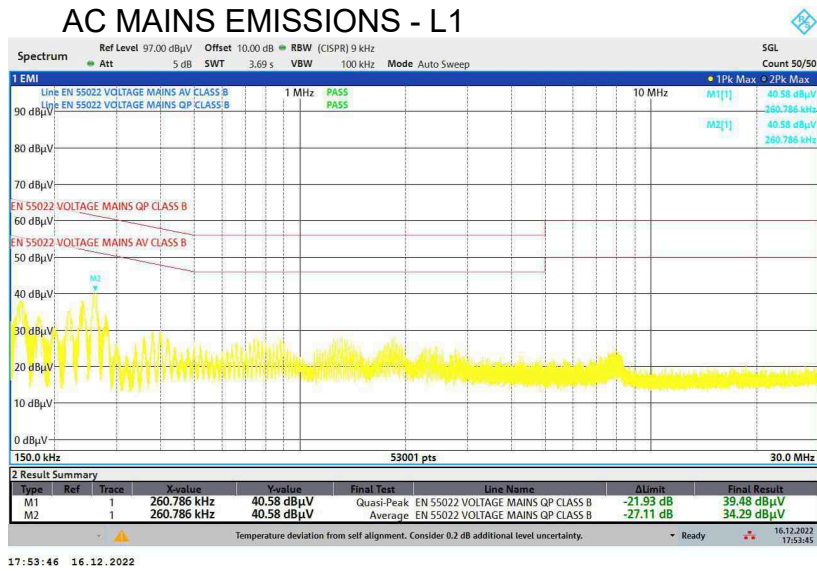
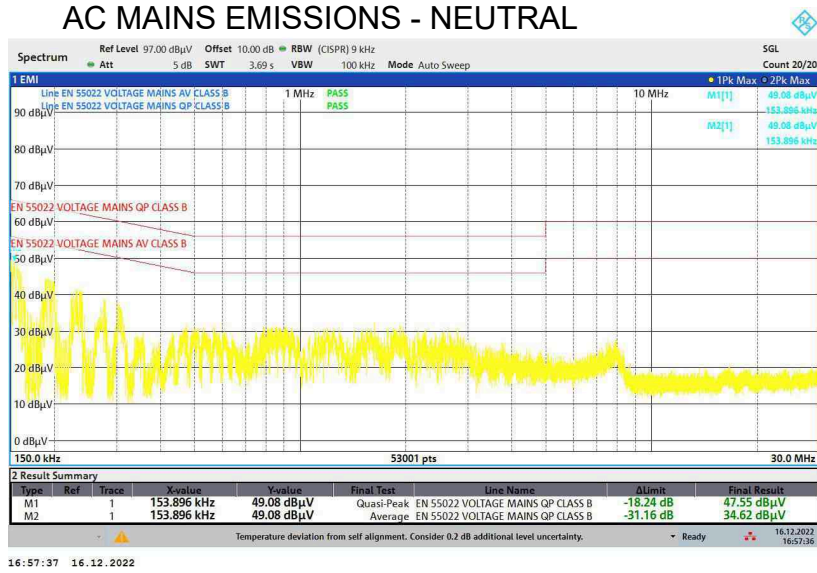

5 Measurement Uncertainty and Accreditation Documents

The maximum values of measurement uncertainty for the laboratory test equipment and facilities associated with each test are given in the table below. This uncertainty is computed for a 95.45% confidence level based on a coverage factor of $k = 2$.

Table 10: Measurement Uncertainty.

Measured Parameter	Measurement Uncertainty [†]
Radio Frequency	$\pm(f_{Mkr}/10^7 + RBW/10 + (SPN/(PTS - 1))/2 + 1 \text{ Hz})$
Conducted Emm. Amplitude	$\pm 1.9 \text{ dB}$
Radiated Emm. Amplitude ($f < 30 \text{ MHz}$)	$\pm 3.1 \text{ dB}$
Radiated Emm. Amplitude (30 – 200 MHz)	$\pm 4.0 \text{ dB}$
Radiated Emm. Amplitude (200 – 1000 MHz)	$\pm 5.2 \text{ dB}$
Radiated Emm. Amplitude ($f > 1000 \text{ MHz}$)	$\pm 3.7 \text{ dB}$

[†]Ref: CISPR 16-4-2:2011+A1:2014



Figure 12: Accreditation Documents