



# FCC Radio Test Report

## FCC ID: XP8DLM108

This report concerns (check one) :  Original Grant  Class I Change

Issued Date : Jun. 23, 2010  
Project No. : R1005001A  
Equipment : mini-PCI radio Module  
Model Name : DLM108

Applicant : Doodle Labs LLP  
Address : 745 Toapayoh Lorong 5, #04-01,  
Singapore 319 455

Tested by: Neutron Engineering Inc. EMC Laboratory  
Date of Receipt: May 11, 2010  
Date of Test: May 11, 2010 ~ Jun. 07, 2010

Testing Engineer : Rush Kao  
(Rush Kao)  
Technical Manager : Jeff Yang  
(Jeff Yang)  
Authorized Signatory : Andy Chiu  
(Andy Chiu)

**Neutron Engineering Inc.**  
B1, No. 37, Lane 365, YangGuang St.,  
NeiHu District 114, Taipei, Taiwan.  
TEL: +886-2-2657-3299  
FAX: +886-2-2657-3331





**Declaration**

**Neutron** represents to the client that testing is done in accordance with standard procedures as applicable and that test instruments used has been calibrated with the standards traceable to National Measurement Laboratory (**NML**) of **R.O.C.**, or National Institute of Standards and Technology (**NIST**) of **U.S.A.**

**Neutron's** reports apply only to the specific samples tested under conditions. It is manufacture's responsibility to ensure that additional production units of this model are manufactured with the identical electrical and mechanical components. **Neutron** shall have no liability for any declarations, inferences or generalizations drawn by the client or others from **Neutron** issued reports.

**Neutron's** reports must not be used by the client to claim product endorsement by the authorities or any agency of the Government.

This report is the confidential property of the client. As a mutual protection to the clients, the public and **Neutron-self**, extracts from the test report shall not be reproduced except in full with **Neutron's** authorized written approval.

**Neutron's** laboratory quality assurance procedures are in compliance with the **ISO Guide 17025** requirements, and accredited by the conformity assessment authorities listed in this test report.

**Limitation**

For the use of the authority's logo is limited unless the Test Standard(s)/Scope(s)/Item(s) mentioned in this test report is (are) included in the conformity assessment authorities acceptance respective.



<b>Table of Contents</b>	<b>Page</b>
<b>1 . CERTIFICATION</b>	<b>5</b>
<b>2 . SUMMARY OF TEST RESULTS</b>	<b>6</b>
2.1 TEST FACILITY	7
2.2 MEASUREMENT UNCERTAINTY	7
<b>3 . GENERAL INFORMATION</b>	<b>8</b>
3.1 GENERAL DESCRIPTION OF EUT	8
3.2 DESCRIPTION OF TEST MODES	10
3.3 TABLE OF PARAMETERS OF TEXT SOFEWARE SETTING	10
3.4 BLOCK DIAGRAM SHOWING THE CONFIGURATION OF SYSTEM TESTED	11
3.4 DESCRIPTION OF SUPPORT UNITS	12
<b>4 . EMC EMISSION TEST</b>	<b>13</b>
4.1 CONDUCTED EMISSION MEASUREMENT	13
4.1.1 POWER LINE CONDUCTED EMISSION	13
4.1.2 MEASUREMENT INSTRUMENTS LIST	13
4.1.3 TEST PROCEDURE	14
4.1.4 DEVIATION FROM TEST STANDARD	14
4.1.5 TEST SETUP	14
4.1.6 EUT OPERATING CONDITIONS	15
4.1.7 TEST RESULTS	16
4.2 RADIATED EMISSION MEASUREMENT	18
4.2.1 RADIATED EMISSION LIMITS	18
4.2.2 MEASUREMENT INSTRUMENTS LIST	19
4.2.3 TEST PROCEDURE	19
4.2.4 DEVIATION FROM TEST STANDARD	19
4.2.5 TEST SETUP	20
4.2.6 EUT OPERATING CONDITIONS	20
4.2.7 TEST RESULTS-BETWEEN 30MHZ - 1000MHZ	21
4.2.8 TEST RESULTS-ABOVE 1000MHZ	23
<b>5 . BANDWITH TEST</b>	<b>47</b>
5.1 APPLIED PROCEDURES / LIMIT	47
5.1.1 MEASUREMENT INSTRUMENTS LIST	47
5.1.2 TEST PROCEDURE	47
5.1.3 DEVIATION FROM STANDARD	47
5.1.4 TEST SETUP	47
5.1.5 EUT OPERATION CONDITIONS	47
5.1.6 TEST RESULTS	48



<b>Table of Contents</b>	<b>Page</b>
<b>6 . PEAK OUTPUT POWER TEST</b>	<b>55</b>
<b>6.1 APPLIED PROCEDURES / LIMIT</b>	<b>55</b>
6.1.1 MEASUREMENT INSTRUMENTS LIST	55
6.1.2 TEST PROCEDURE	55
6.1.3 DEVIATION FROM STANDARD	55
6.1.4 TEST SETUP	55
6.1.5 EUT OPERATION CONDITIONS	55
6.1.6 TEST RESULTS	56
<b>7 . ANTENNA CONDUCTED SPURIOUS EMISSION</b>	<b>57</b>
<b>7.1 APPLIED PROCEDURES / LIMIT</b>	<b>57</b>
7.1.1 MEASUREMENT INSTRUMENTS LIST	57
7.1.2 TEST PROCEDURE	57
7.1.3 DEVIATION FROM STANDARD	57
7.1.4 TEST SETUP	57
7.1.5 EUT OPERATION CONDITIONS	57
7.1.6 TEST RESULTS	58
<b>8 . POWER SPECTRAL DENSITY TEST</b>	<b>70</b>
<b>8.1 APPLIED PROCEDURES / LIMIT</b>	<b>70</b>
8.1.1 MEASUREMENT INSTRUMENTS LIST	70
8.1.2 TEST PROCEDURE	70
8.1.3 DEVIATION FROM STANDARD	70
8.1.4 TEST SETUP	70
8.1.5 EUT OPERATION CONDITIONS	70
8.1.6 TEST RESULTS	71
<b>9 . RF EXPOSURE TEST</b>	<b>78</b>
<b>9.1 RF EXPOSURE REQUIREMENTS / LIMIT:</b>	<b>78</b>
9.1.1 MPE CALCULATION METHOD	78
<b>10 . EUT TEST PHOTO</b>	<b>79</b>



## 1. CERTIFICATION

Equipment : mini-PCI radio Module  
Brand Name : DOODLE LABS  
Model Name : DLM108  
Applicant : Doodle Labs LLP  
Date of Test : May 11, 2010 ~ Jun. 07, 2010  
Standards : FCC Part15, Subpart C / ANCI C63.4 : 2003

The above equipment has been tested and found compliance with the requirement of the relative standards by Neutron Engineering Inc. EMC Laboratory.

The test data, data evaluation, and equipment configuration contained in our test report (Ref No. NEI-FCCP-1-R1005001A) were obtained utilizing the test procedures, test instruments, test sites that has been accredited by the Authority of NVLAP and TAF according to the ISO-17025 quality assessment standard and technical standard(s).



## 2. SUMMARY OF TEST RESULTS

Test procedures according to the technical standards:

FCC Reference	Description	Results
<b>Transmitter Mode (TX)</b>		
15.207	AC Power Line Conducted Emissions	Compliant
15.203/15.247(c)	Antenna Requirement	Compliant
15.247(a)	6dB Occupied Bandw	Compliant
15.247(b)	Maximum Peak Conducted Output Power	Compliant
15.247(d), 15.205, 15.209	Spurious Radiated and Conducted Emissions	Compliant
15.247(e)	Peak Power Spectral Density and RF Exposure	Compliant

**NOTE:**

(1) "N/A" denotes test is not applicable in this Test Report

(2) The EUT shall comply with paragraph 15.247 and 15.212 of the FCC Part 15, subpart C rules. Regarding compliance with paragraph 15.212 refer to the submitted modular approval letter (DA 00-1407) exhibit.



**2.1 TEST FACILITY**

The test facilities used to collect the test data in this report is **CB08(FCC R.N.: 614388)** at the location of 1F., No. 61, Ln. 77, Sing-ai Rd., Neihu Dist., Taipei City 114, Taiwan (R.O.C.)

**2.2 MEASUREMENT UNCERTAINTY**

The reported uncertainty of measurement  $y \pm U$ , where expanded uncertainty **U** is based on a standard uncertainty multiplied by a coverage factor of **k=2**, providing a level of confidence of approximately **95%**.

The measurement instrumentation uncertainty considerations contained in CISPR 16-4-2.

A. Conducted Measurement :

Test Site	Method	Measurement Frequency Range	U , (dB)	NOTE
C01	ANSI	150 KHz ~ 30MHz	1.94	

B. Radiated Measurement :

Test Site	Method	Measurement Frequency Range	Ant. H / V	U , (dB)	NOTE
OS-01	ANSI	30MHz ~ 200MHz	V	2.86	
		30MHz ~ 200MHz	H	2.56	
		200MHz ~ 1,000MHz	V	2.88	
		200MHz ~ 1,000MHz	H	2.98	
OS-02	ANSI	30MHz ~ 200MHz	V	2.48	
		30MHz ~ 200MHz	H	2.16	
		200MHz ~ 1,000MHz	V	2.50	
		200MHz ~ 1,000MHz	H	2.66	

Our calculated Measurement Instrumentation Uncertainty is shown in the tables above. These are our  $U_{lab}$  values in CISPR 16-4-2 terminology.

Since Table 1 of CISPR 16-4-2 has values of measurement instrumentation uncertainty, called  $U_{CISPR}$ , as follows:

Conducted Disturbance (mains port) – 150 kHz – 30 MHz : 3.6 dB

Radiated Disturbance (electric field strength on an open area test site or alternative test site) – 30 MHz – 1000 MHz : 5.2 dB

It can be seen that our  $U_{lab}$  values are smaller than  $U_{CISPR}$ .



**3. GENERAL INFORMATION**

**3.1 GENERAL DESCRIPTION OF EUT**

Equipment	mini-PCI radio Module
Brand Name	DOODLE LABS
Model Name	DLM108
OEM Brand/Model Name	N/A
Model Difference	N/A
Product Description	The EUT is a mini-PCI radio Module.
	Operation Frequency: 907~922 MHz
	Modulation Type: DSSS/BPSK
	Bit Rate of Transmitter: 11b: 11/5.5/2/1 Mbps 11g: 54/48/36/24/18/12/9/6 Mbps
	Channel Bandwidth 5/10/20M
	Number Of Channel: Please see Note 2.
	Antenna Designation: Please see Note 3.
	Antenna Gain(Peak): Please see Note 3.
	Output Power(Max): 11b: 21.62dBm (Max.) 11g: 29.67dBm (Max.)
	Based on the application, features, or specification exhibited in User's Manual, the EUT is considered as an ITE/Computing Device. More details of EUT technical specification, please refer to the User's Manual.
Power Source	Supplied from miniPCI Slot.
Power Rating	N/A
Connecting I/O Port(s)	Please refer to the User's Manual
Products Covered	Antenna: Please refer to the Note 3.

Note:

1. For a more detailed features description, please refer to the manufacturer's specifications or the User's Manual.





2.

Channel List	
Channel	Frequency (MHz)
01	907
02	912
03	917
04	922

3. Table for Filed Antenna

Ant.	Brand	Model Name	Antenna Type	Connector	Cable loss (Min.)	Gain (dBi)
1	Pacific Wireless	MA9-7N	Omni Directional	N Male	1.57	7

NOTE: Total gain :  $7 - 1.57 = 5.43$  dBi



**3.2 DESCRIPTION OF TEST MODES**

To investigate the maximum EMI emission characteristics generates from EUT, the test system was pre-scanning tested base on the consideration of following EUT operation mode or test configuration mode which possible have effect on EMI emission level. Each of these EUT operation mode(s) or test configuration mode(s) mentioned above was evaluated respectively.

Pretest Test Mode	TX	RX	Description
Mode 1	v		907MHz
Mode 2	v		912MHz
Mode 3	v		917MHz
Mode 4	v		922MHz

For Final Conducted Test			
Final Test Mode	TX	RX	Description
Mode 1	v		TX

For Final Radiated Test < 1GHz			
Final Test Mode	TX	RX	Description
Mode 1	v		917MHz

For Final Radiated Test > 1GHz			
Final Test Mode	TX	RX	Description
Mode 1	v		907MHz
Mode 2	v		912MHz
Mode 3	v		917MHz
Mode 4	v		922MHz

**3.3 TABLE OF PARAMETERS OF TEXT SOFEWARE SETTING**

During testing channel & power controlling software provided by the customer was used to control the operating channel as well as the output power level. The RF output power selection is for the setting of RF output power expected by the customer and is going to be fixed on the firmware of the final end product

Test software Version	ART				Channel BW
	907MHz	912MHz	917MHz	922MHz	
IEEE 802.11b DSSS	-	8.5	9.5	-	20MHz
IEEE 802.11g OFDM	16	17.5	17	17	5MHz
IEEE 802.11g OFDM	15.5	17.5	16.5	16.5	10MHz
IEEE 802.11g OFDM	-	16.5	16.5	-	20MHz



3.4 BLOCK DIAGRAM SHOWING THE CONFIGURATION OF SYSTEM TESTED

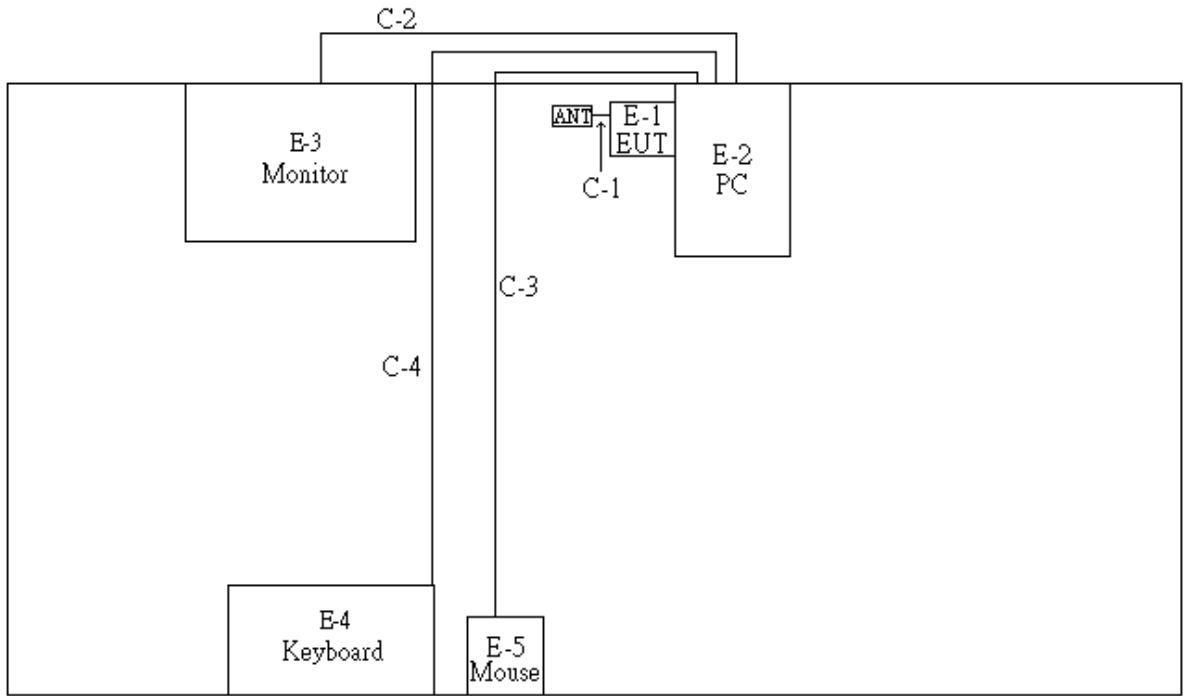



**3.4 DESCRIPTION OF SUPPORT UNITS**

The EUT has been tested as an independent unit together with other necessary accessories or support units. The following support units or accessories were used to form a representative test configuration during the tests.

Item	Equipment	Mfr/Brand	Model/Type No.	FCC ID	Series No.	Note
E-1	mini-PCI radio Module	DOODLE LABS	DLM108	XP8DLM108	N/A	EUT
E-2	PC	DELL	DIMENSION2400	DOC	0Y09197082160FN	
E-3	22" LCD TV Monitor	BenQ	ET-0026-NA	DOC	ETE6902198026	
E-4	USB K/B	INTOPIC	KBD-USB-500	DOC	N/A	
E-5	USB Mouse	IBM	MO28UO	DOC	23-271883	

Item	Shielded Type	Ferrite Core	Length	Note
C-1	YES	NO	3.0M	ANT cable
C-2	YES	YES	1.8M	Monitor VGA cable
C-3	YES	YES	1.7M	Mouse USB cable
C-4	YES	YES	2.0M	Keyboard USB cable

Note:

- (1) The support equipment was authorized by Declaration of Confirmation.
- (2) For detachable type I/O cable should be specified the length in cm in 『Length』 column.



**4. EMC EMISSION TEST**

**4.1 CONDUCTED EMISSION MEASUREMENT**

**4.1.1 POWER LINE CONDUCTED EMISSION (Frequency Range 150KHz-30MHz)**

FREQUENCY (MHz)	Class A (dBuV)		Class B (dBuV)	
	Quasi-peak	Average	Quasi-peak	Average
0.15 -0.5	79.00	66.00	66 - 56 *	56 - 46 *
0.50 -5.0	73.00	60.00	56.00	46.00
5.0 -30.0	73.00	60.00	60.00	50.00

Note:

- (1) The tighter limit applies at the band edges.
- (2) The limit of " \* " marked band means the limitation decreases linearly with the logarithm of the frequency in the range.

**4.1.2 MEASUREMENT INSTRUMENTS LIST**

Item	Kind of Equipment	Manufacturer	Type No.	Serial No.	Calibrated until
1	LISN	EMCO	3816/2	00042991	Feb. 7, 2011
2	Test Cable	TIMES	LMR-400	SR03_C_01&02	Aug. 19, 2010
3	Pulse Limiter	Electro-Metrics	EM-7600	112644	Dec. 27, 2010
4	EMI Test Receiver	R&S	ESCI	100082	Mar. 16, 2011
5	50Ω BNC TYPE Terminator	N/A	N/A	01	May 25, 2011
6	50Ω BNC TYPE Terminator	N/A	N/A	03	May 25, 2011
7	LISN	EMCO	4825/2	00028234	Jul. 13, 2010

Remark: " N/A" denotes No Model Name , Serial No. or No Calibration specified.

#### 4.1.3 TEST PROCEDURE

- The EUT was placed 0.8 meters from the horizontal ground plane with EUT being connected to the power mains through a line impedance stabilization network (LISN). All other support equipments powered from additional LISN(s). The LISN provide 50 Ohm/ 50uH of coupling impedance for the measuring instrument.
- Interconnecting cables that hang closer than 40 cm to the ground plane shall be folded back and forth in the center forming a bundle 30 to 40 cm long.
- I/O cables that are not connected to a peripheral shall be bundled in the center. The end of the cable may be terminated, if required, using the correct terminating impedance. The overall length shall not exceed 1 m.
- LISN at least 80 cm from nearest part of EUT chassis.
- For the actual test configuration, please refer to the related Item –EUT Test Photos.

#### 4.1.4 DEVIATION FROM TEST STANDARD

No deviation

#### 4.1.5 TEST SETUP

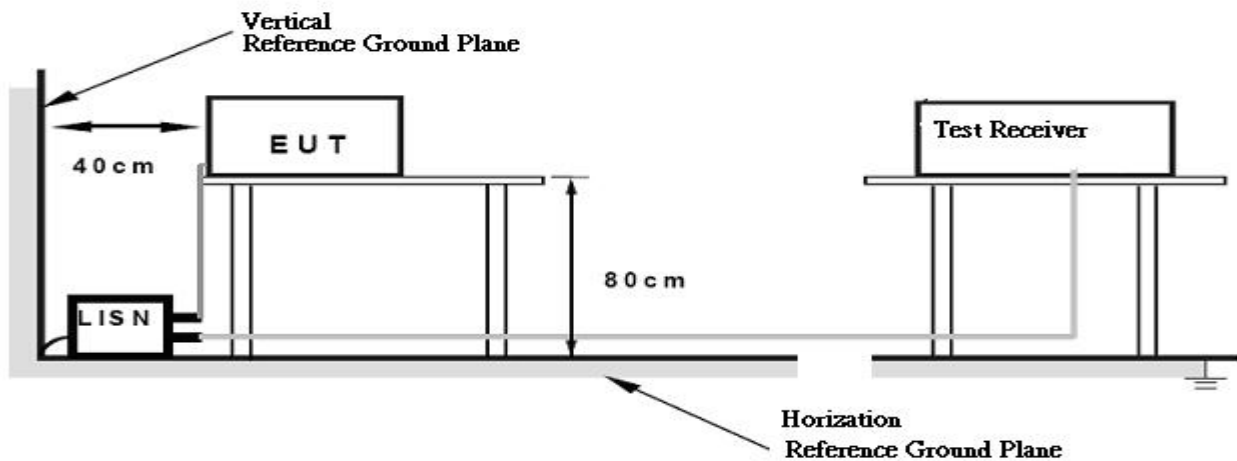



#### **4.1.6 EUT OPERATING CONDITIONS**

The EUT was configured for testing in a typical fashion (as a customer would normally use it). The EUT has been programmed to continuously transmit during test. This operating condition was tested and used to collect the included data.



**4.1.7 TEST RESULTS**

EUT :	mini-PCI radio Module	Model Name :	DLM108
Temperature :	25 °C	Relative Humidity :	51%
Test Voltage :	AC 120V/60Hz		
Test Mode :	TX		

Freq. (MHz)	Terminal L/N	Measured(dBuV)		Limits(dBuV)		Margin (dB)	Note
		QP-Mode	AV-Mode	QP-Mode	AV-Mode		
0.17	Line	46.55	*	64.74	54.74	-18.19	(QP)
0.47	Line	39.75	*	56.57	46.57	-16.82	(QP)
0.64	Line	33.84	*	56.00	46.00	-22.16	(QP)
0.92	Line	34.31	*	56.00	46.00	-21.69	(QP)
1.16	Line	34.53	*	56.00	46.00	-21.47	(QP)
1.68	Line	33.98	*	56.00	46.00	-22.02	(QP)

**Remark**

- (1) Reading in which marked as QP means measurements by using are Quasi-Peak Mode with Detector BW=9KHz; SPA setting in RBW=10KHz,VBW =10KHz, Swp. Time = 0.2 sec./MHz ◦ Reading in which marked as AV means measurements by using are Average Mode with instrument setting in RBW=10KHz,VBW=10KHz, Swp. Time =0.2 sec./MHz ◦
- (2) All readings are QP Mode value unless otherwise stated AVG in column of 『 Note 』 . If the QP Mode Measured value compliance with the QP Limits and lower than AVG Limits, the EUT shall be deemed to meet both QP & AVG Limits and then only QP Mode was measured, but AVG Mode didn't perform ◦ In this case, a “ \* ” marked in AVG Mode column of Interference Voltage Measured ◦
- (3) Measuring frequency range from 150KHz to 30MHz ◦

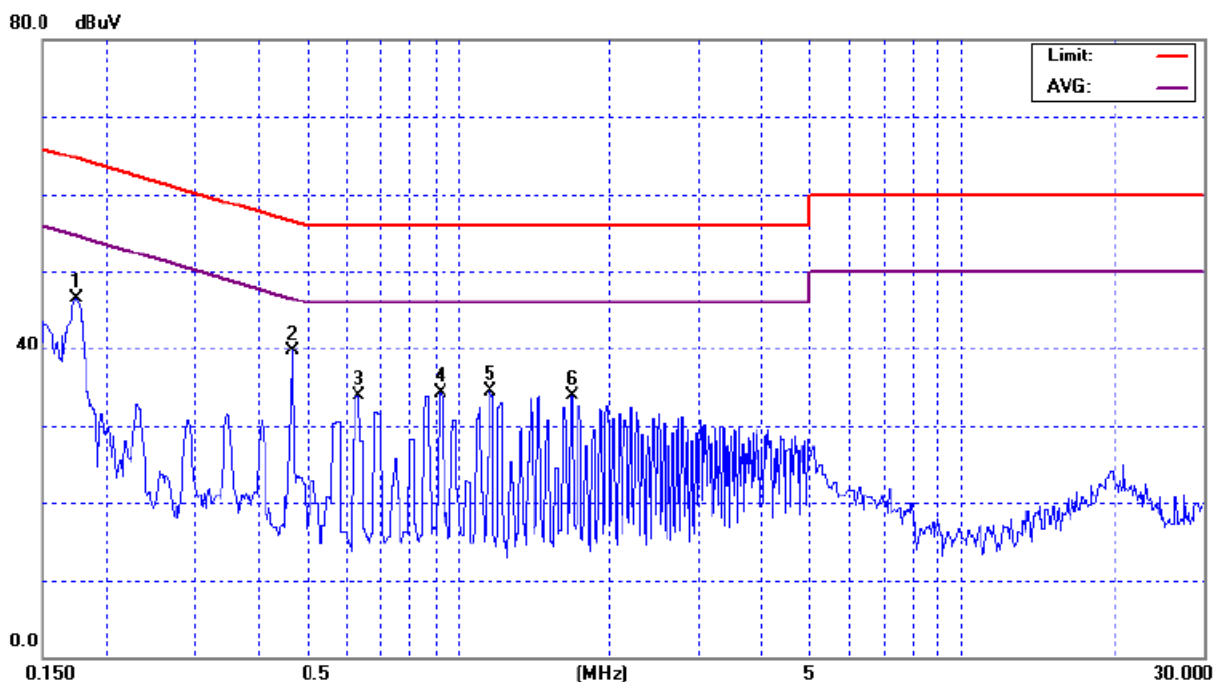





EUT :	mini-PCI radio Module	Model Name :	DLM108
Temperature :	25° C	Relative Humidity :	51%
Test Voltage :	AC 120V/60Hz		
Test Mode :	TX		

Freq. (MHz)	Terminal L/N	Measured(dBuV)		Limits(dBuV)		Margin (dB)	Note
		QP-Mode	AV-Mode	QP-Mode	AV-Mode		
0.17	Neutral	47.01	*	64.74	54.74	-17.73	(QP)
0.23	Neutral	34.99	*	62.36	52.36	-27.37	(QP)
0.64	Neutral	34.80	*	56.00	46.00	-21.20	(QP)
0.93	Neutral	34.92	*	56.00	46.00	-21.08	(QP)
1.16	Neutral	34.84	*	56.00	46.00	-21.16	(QP)
1.69	Neutral	34.32	*	56.00	46.00	-21.68	(QP)

**Remark**

- (1) Reading in which marked as QP means measurements by using are Quasi-Peak Mode with Detector BW=9KHz; SPA setting in RBW=10KHz,VBW =10KHz, Swp. Time = 0.2 sec./MHz ◦ Reading in which marked as AV means measurements by using are Average Mode with instrument setting in RBW=10KHz,VBW=10KHz, Swp. Time =0.2 sec./MHz ◦
- (2) All readings are QP Mode value unless otherwise stated AVG in column of 『 Note 』 . If the QP Mode Measured value compliance with the QP Limits and lower than AVG Limits, the EUT shall be deemed to meet both QP & AVG Limits and then only QP Mode was measured, but AVG Mode didn't perform ◦ In this case, a " \* " marked in AVG Mode column of Interference Voltage Measured ◦
- (3) Measuring frequency range from 150KHz to 30MHz ◦

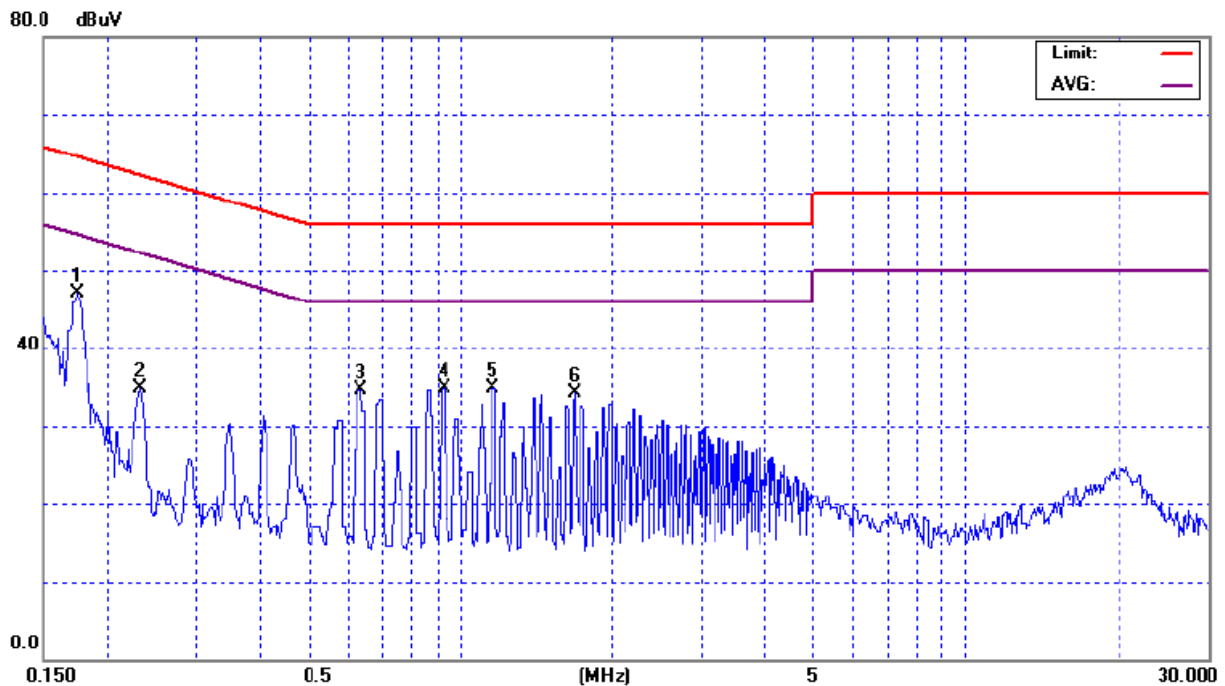



**4.2 RADIATED EMISSION MEASUREMENT**

**4.2.1 RADIATED EMISSION LIMITS (Frequency Range 9kHz-1000MHz)**

20dBc in any 100 kHz bandwidth outside the operating frequency band. In case the emission fall within the restricted band specified on 15.205(a), then the 15.209(a) limit in the table below has to be followed.

Frequencies (MHz)	Field Strength (micovolts/meter)	Measurement Distance (meters)
0.009~0.490	2400/F(KHz)	300
0.490~1.705	24000/F(KHz)	30
1.705~30.0	30	30
30~88	100	3
88~216	150	3
216~960	200	3
Above 960	500	3

**LIMITS OF RADIATED EMISSION MEASUREMENT (Above 1000MHz)**

FREQUENCY (MHz)	Class A (dBuV/m) (at 3m)		Class B (dBuV/m) (at 3m)	
	PEAK	AVERAGE	PEAK	AVERAGE
Above 1000	80	60	74	54

Notes:

- (1) The limit for radiated test was performed according to FCC PART 15B.
- (2) The tighter limit applies at the band edges.
- (3) Emission level (dBuV/m)=20log Emission level (uV/m).



**4.2.2 MEASUREMENT INSTRUMENTS LIST**

Item	Kind of Equipment	Manufacturer	Type No.	Serial No.	Calibrated until
1	Spectrum Analyzer	R&S	FSP-40	100129	Sep. 10, 2010
2	Horn Antenna	Schwarzbeck	BBHA 9120 D	9120D-325	Dec. 15, 2010
3	Microwave Pre_amplifier	Agilent	8449B	3008A01714	Apr. 19, 2011
4	Microflex Cable	N/A	N/A	1m	May. 19, 2011
5	Microflex Cable	AISI	S104-SMAP-1	10m	Aug. 23, 2010
6	Microflex Cable	N/A	N/A	3m	Aug. 23, 2010
7	Test Cable	N/A	LMR-400	966_12m	Jun. 18, 2010
8	Test Cable	N/A	LMR-400	966_3m	Jun. 18, 2010
9	Pre-Amplifier	EMC	EMC-330	980001	Jun. 03, 2011
10	Log-Bicon Antenna	Schwarzbeck	VULB9168-352	9168-352	Jun. 17, 2010

Remark: " N/A" denotes No Model Name / Serial No. and No Calibration specified.

**4.2.3 TEST PROCEDURE**

- a. The measuring distance of at 10 m shall be used for measurements at frequency up to 1GHz. For frequencies above 1GHz, any suitable measuring distance may be used.
- b. The EUT was placed on the top of a rotating table 0.8 meters above the ground at a 3m or 10 meter open area test site. The table was rotated 360 degrees to determine the position of the highest radiation.
- c. The height of the equipment or of the substitution antenna shall be 0.8 m; the height of the test antenna shall vary between 1 m to 4 m. Both horizontal and vertical polarizations of the antenna are set to make the measurement.
- d. The initial step in collecting conducted emission data is a spectrum analyzer peak detector mode pre-scanning the measurement frequency range. Significant peaks are then marked and then Quasi Peak detector mode re-measured.
- e. If the Peak Mode measured value compliance with and lower than Quasi Peak Mode Limit, the EUT shall be deemed to meet QP Limits and then no additional QP Mode measurement performed.
- f. For the actual test configuration, please refer to the related Item –EUT Test Photos.

**4.2.4 DEVIATION FROM TEST STANDARD**

No deviation

#### 4.2.5 TEST SETUP

(A) Radiated Emission Test Set-Up, Frequency Below 1000MHz

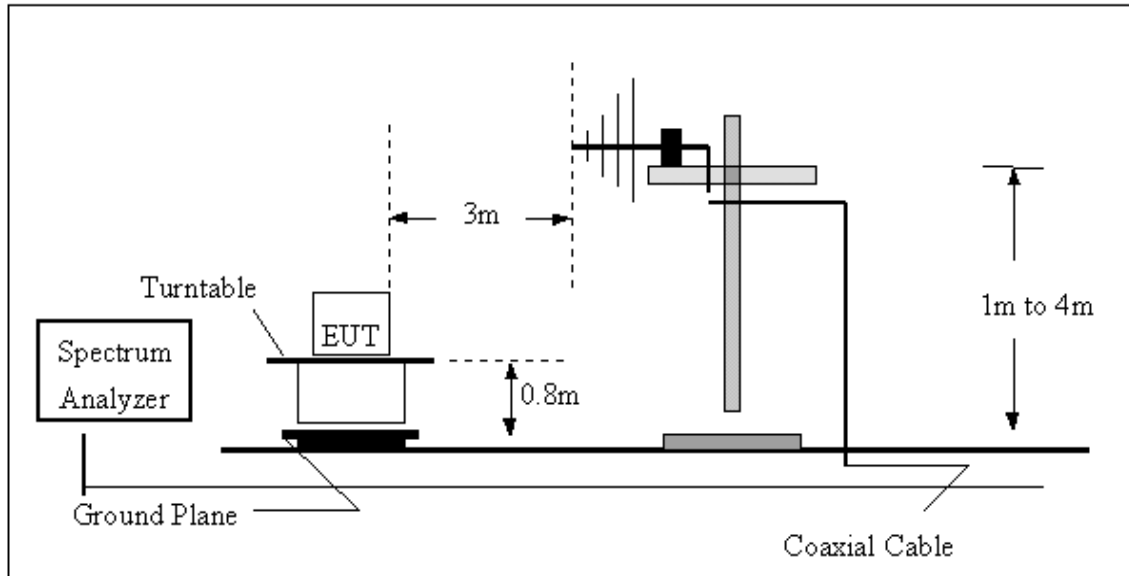

(B) Radiated Emission Test Set-UP Frequency Over 1 GHz

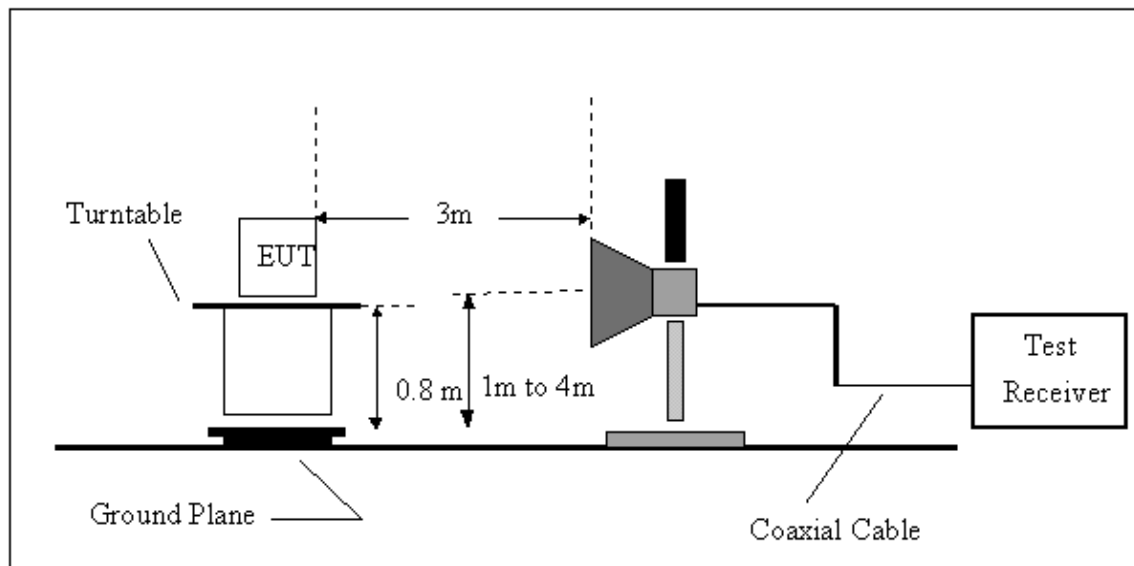

#### 4.2.6 EUT OPERATING CONDITIONS

The EUT tested system was configured as the statements of 4.1.6 Unless otherwise a special operating condition is specified in the follows during the testing.



**4.2.7 TEST RESULTS-BETWEEN 30MHZ - 1000MHZ**

EUT :	mini-PCI radio Module	Model Name :	DLM108
Temperature :	26 °C	Relative Humidity :	60%
Test Voltage :	AC 120V/60Hz		
Test Mode :	TX 917MHz		

Freq. (MHz)	Ant. H/V	Reading(RA) (dBuV)	Corr.Factor(CF) (dB)	Measured(FS) (dBuV/m)	Limits(QP) (dBuV/m)	Margin (dB)	Note
365.62	V	49.22	-6.77	42.45	46.00	- 3.55	
449.04	V	46.59	-4.51	42.08	46.00	- 3.92	
499.48	V	46.38	-3.85	42.53	46.00	- 3.47	
534.40	V	46.10	-3.07	43.03	46.00	- 2.97	
600.36	V	45.28	-1.54	43.74	46.00	- 2.26	
662.44	V	42.64	-0.04	42.60	46.00	- 3.40	

**Remark :**

- (1) Spectrum Setting : 30MHz – 1000MHz , RBW= 100KHz, VBW=100KHz, Sweep time = 200 ms. 1GHz- 25GHz, RBW= 1MHz, VBW= 1MHz, Sweep time = Auto
- (2) All readings are Peak unless otherwise stated QP in column of 『Note』 . Peak denotes that the Peak reading compliance with the QP Limits and then QP Mode measurement didn't perform ◦
- (3) Measuring frequency range from 30MHz to 1000MHz or the 10th harmonic of highest fundamental frequency ◦ “F” denotes fundamental frequency; “ H” denotes spurious frequency. “E” denotes band edge frequency.
- (4) Radiated emissions measured in frequency range from 30 MHz to 1000 MHz were made with an instrument using Peak detector mode or QP detector mode of the emission ◦
- (5) Data of measurement within this frequency range shown “ - ” in the table above means the reading of emissions are attenuated more than 20dB below the permissible limits or the field strength is too small to be measured.

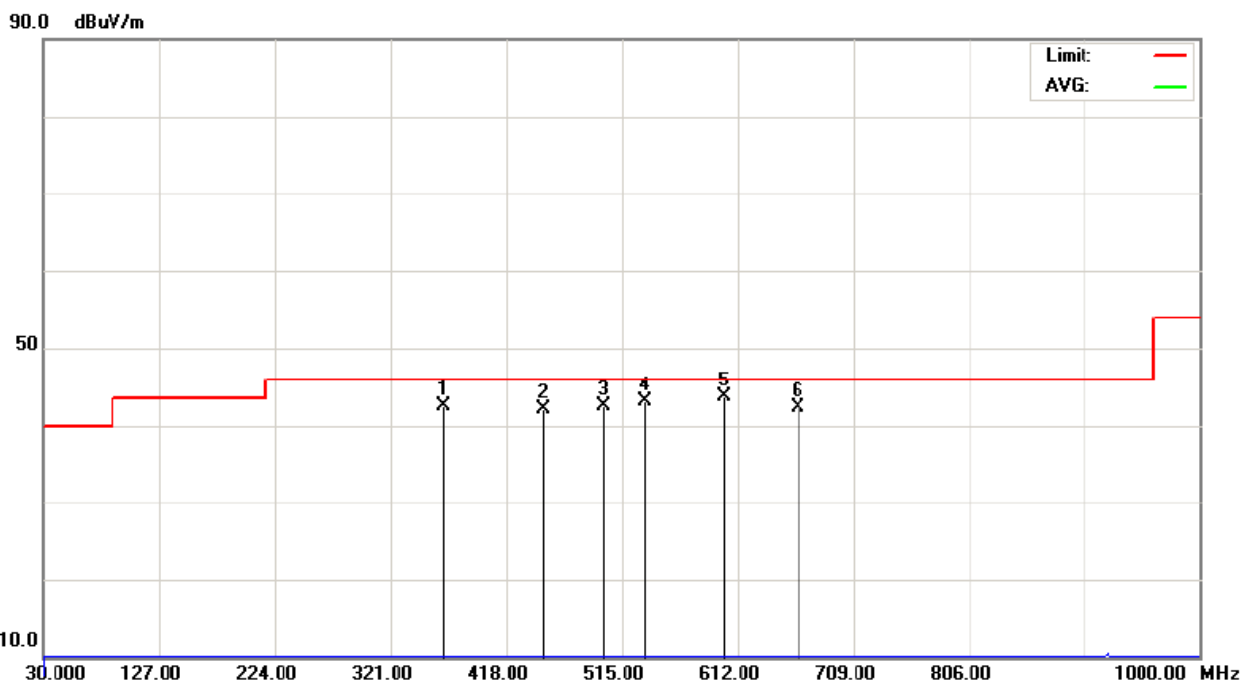



EUT :	mini-PCI radio Module	Model Name :	DLM108
Temperature :	26 °C	Relative Humidity :	60%
Test Voltage :	AC 120V/60Hz		
Test Mode :	TX 917MHz		

Freq. (MHz)	Ant. H/V	Reading(RA) (dBuV)	Corr.Factor(CF) (dB)	Measured(FS) (dBuV/m)	Limits(QP) (dBuV/m)	Margin (dB)	Note
332.64	H	52.52	-7.50	45.02	46.00	- 0.98	
464.56	H	47.81	-4.29	43.52	46.00	- 2.48	
532.46	H	46.21	-3.11	43.10	46.00	- 2.90	
600.36	H	45.10	-1.54	43.56	46.00	- 2.44	
749.74	H	42.07	1.01	43.08	46.00	- 2.92	
840.92	H	37.89	1.98	39.87	46.00	- 6.13	

**Remark :**

- (1) Spectrum Setting : 30MHz – 1000MHz , RBW= 100KHz, VBW=100KHz, Sweep time = 200 ms. 1GHz- 25GHz, RBW= 1MHz, VBW= 1MHz, Sweep time = Auto
- (2) All readings are Peak unless otherwise stated QP in column of 『Note』 . Peak denotes that the Peak reading compliance with the QP Limits and then QP Mode measurement didn't perform ◦
- (3) Measuring frequency range from 30MHz to 1000MHz or the 10th harmonic of highest fundamental frequency ◦ “F” denotes fundamental frequency; “ H” denotes spurious frequency. “E” denotes band edge frequency.
- (4) Radiated emissions measured in frequency range from 30 MHz to 1000 MHz were made with an instrument using Peak detector mode or QP detector mode of the emission ◦
- (5) Data of measurement within this frequency range shown “ - ” in the table above means the reading of emissions are attenuated more than 20dB below the permissible limits or the field strength is too small to be measured.

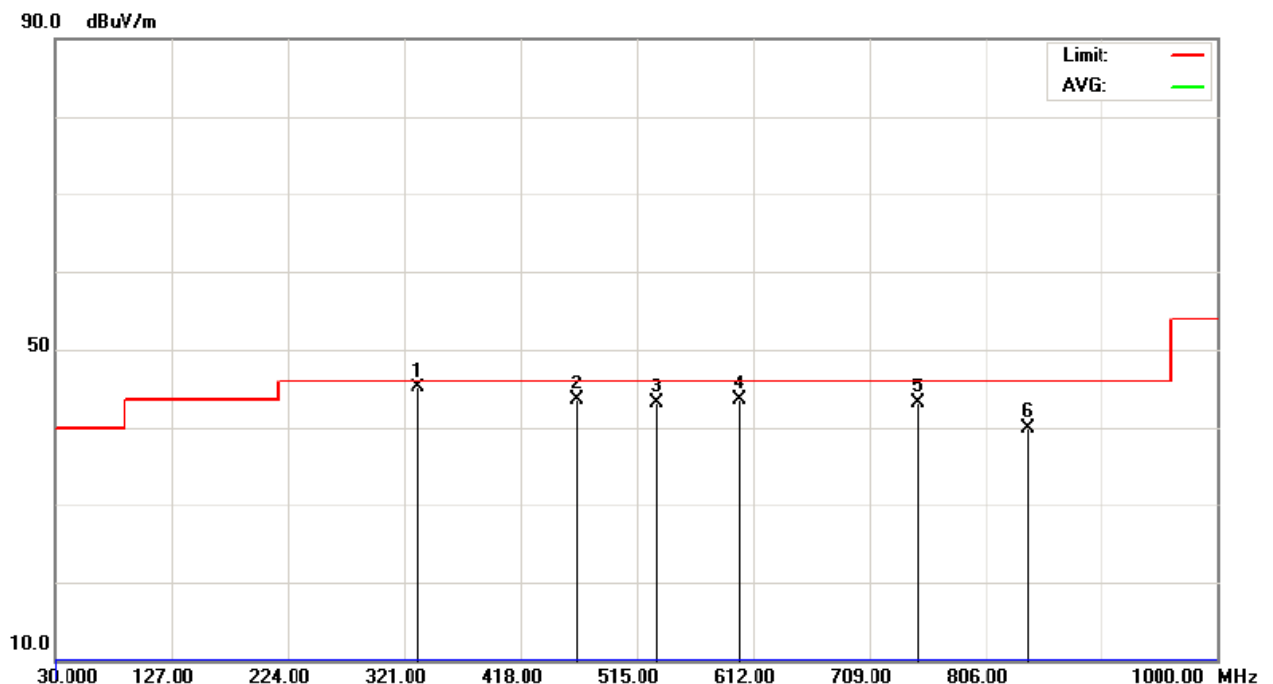



**4.2.8 TEST RESULTS-ABOVE 1000MHZ**

EUT :	mini-PCI radio Module	Model Name :	DLM108
Temperature :	26 °C	Relative Humidity :	60%
Test Voltage :	AC 120V/60Hz		
Test Mode :	TX 907MHz_ 5MHz		

Freq. (MHz)	Ant.Pol. H/V	Reading		Ant./CF CF(dB)	Act.		Limit		Note
		Peak (dBuV)	AV (dBuV)		Peak (dBuV/m)	AV (dBuV/m)	Peak (dBuV/m)	AV (dBuV/m)	
1813.88	V	69.41	55.21	-4.19	65.22	51.02	74.00	54.00	X/H
2720.16	V	54.58	41.12	-2.13	52.45	38.99	74.00	54.00	X/H
1813.70	H	64.15	51.36	-4.19	59.96	47.17	74.00	54.00	X/H
2720.12	H	49.70	36.48	-2.13	47.57	34.35	74.00	54.00	X/H

**Remark :**

- (1) Spectrum Setting : 30MHz – 1000MHz , RBW= 100KHz, VBW=100KHz, Sweep time = 200 ms. 1GHz- 25GHz, RBW= 1MHz, VBW= 1MHz, Sweep time = Auto
- (2) All readings are Peak unless otherwise stated QP in column of 『Note』 . Peak denotes that the Peak reading compliance with the QP Limits and then QP Mode measurement didn't perform ◦
- (3) Measuring frequency range from 30MHz to 1000MHz or the 10th harmonic of highest fundamental frequency ◦ "F" denotes fundamental frequency; "H" denotes spurious frequency. "E" denotes band edge frequency. (This judgment method includes the Band Edge Requirement.)
- (4) Radiated emissions measured in frequency range above 1000MHz were made with an instrument using Peak detector mode and AV detector mode of the emission ◦
- (5) Data of measurement within this frequency range shown " \* " in the table above means the reading of emissions are attenuated more than 20dB below the permissible limits or the field strength is too small to be measured.
- (6) A preamp and high pass filter were used for this test in order to provide sufficient measurement sensitivity.
- (7) EUT Orthogonal Axes :  
"X" - denotes Laid on Table ; "Y" - denotes Vertical Stand ; "Z" - denotes Side Stand
- (8) During the measurements above 1GHz it is taken care of that the EUT is always within the 3dB cone of radiation BW of the used antenna.



Orthogonal Axis : X  
TX 907MHz\_ 11G 5MHz (Above 1000 MHz, Vertical)

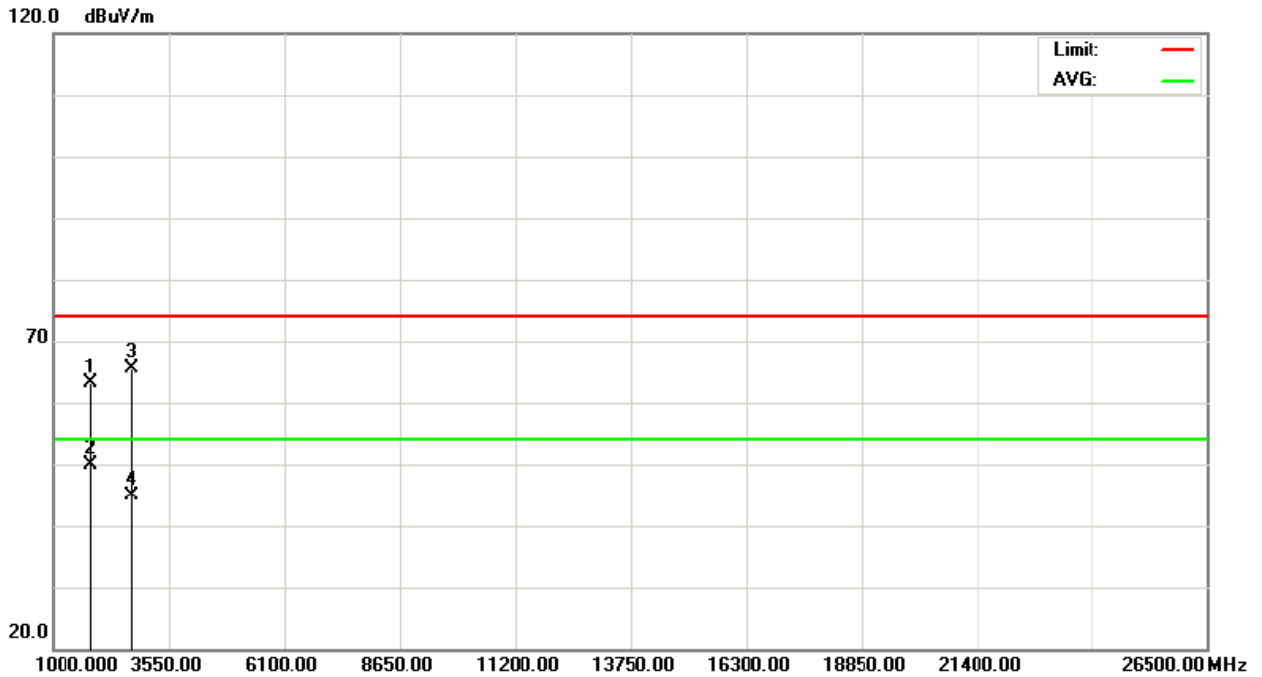

TX 907MHz\_ 11G 5MHz (Above 1000 MHz, Horizontal)

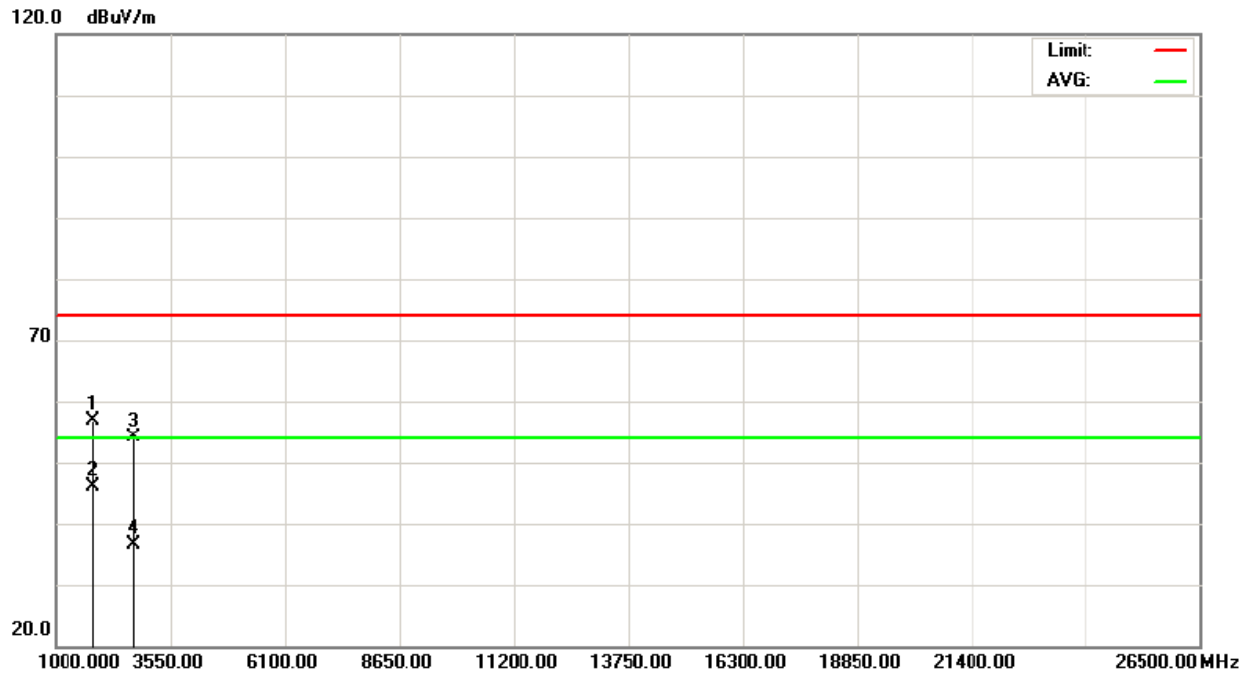





EUT :	mini-PCI radio Module	Model Name :	DLM108
Temperature :	26 ° C	Relative Humidity :	60%
Test Voltage :	AC 120V/60Hz		
Test Mode :	TX 907MHz_11G 10MHz		

Freq. (MHz)	Ant.Pol. H/V	Reading		Ant./CF CF(dB)	Act.		Limit		Note
		Peak (dBuV)	AV (dBuV)		Peak (dBuV/m)	AV (dBuV/m)	Peak (dBuV/m)	AV (dBuV/m)	
1813.84	V	63.35	50.36	-4.19	59.16	46.17	74.00	54.00	X/H
2719.04	V	48.33	37.55	-2.13	46.20	35.42	74.00	54.00	X/H
1813.72	H	63.04	48.96	-4.19	58.85	44.77	74.00	54.00	X/H
2719.02	H	44.94	34.67	-2.13	42.81	32.54	74.00	54.00	X/H

**Remark :**

- (1) Spectrum Setting : 30MHz – 1000MHz , RBW= 100KHz, VBW=100KHz, Sweep time = 200 ms. 1GHz- 25GHz, RBW= 1MHz, VBW= 1MHz, Sweep time = Auto
- (2) All readings are Peak unless otherwise stated QP in column of 『Note』 . Peak denotes that the Peak reading compliance with the QP Limits and then QP Mode measurement didn't perform ◦
- (3) Measuring frequency range from 30MHz to 1000MHz or the 10th harmonic of highest fundamental frequency ◦“F” denotes fundamental frequency; “H” denotes spurious frequency. “E” denotes band edge frequency. (This judgment method includes the Band Edge Requirement.)
- (4) Radiated emissions measured in frequency range above 1000MHz were made with an instrument using Peak detector mode and AV detector mode of the emission ◦
- (5) Data of measurement within this frequency range shown “ \* ” in the table above means the reading of emissions are attenuated more than 20dB below the permissible limits or the field strength is too small to be measured.
- (6) A preamp and high pass filter were used for this test in order to provide sufficient measurement sensitivity.
- (7) EUT Orthogonal Axes :  
“X” - denotes Laid on Table ; ”Y” - denotes Vertical Stand ; ”Z” - denotes Side Stand
- (8) During the measurements above 1GHz it is taken care of that the EUT is always within the 3dB cone of radiation BW of the used antenna.



Orthogonal Axis : X  
TX 907MHz\_11G 10MHz (Above 1000 MHz, Vertical)

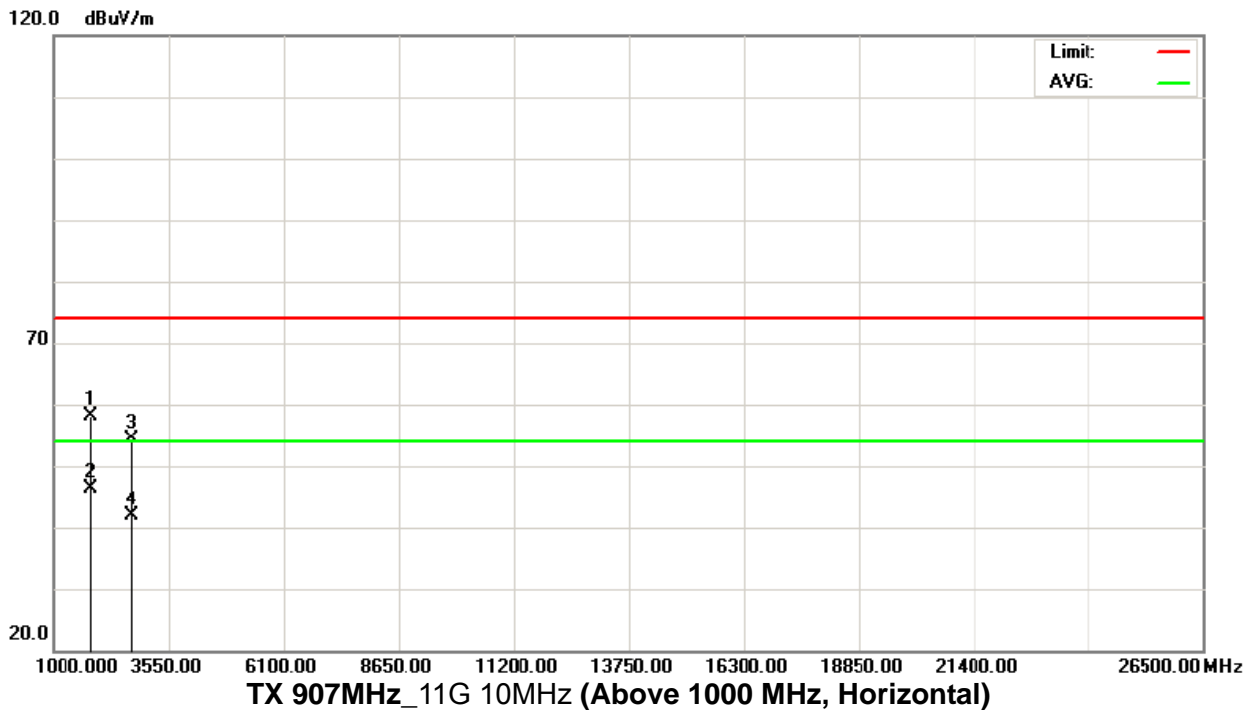

TX 907MHz\_11G 10MHz (Above 1000 MHz, Horizontal)

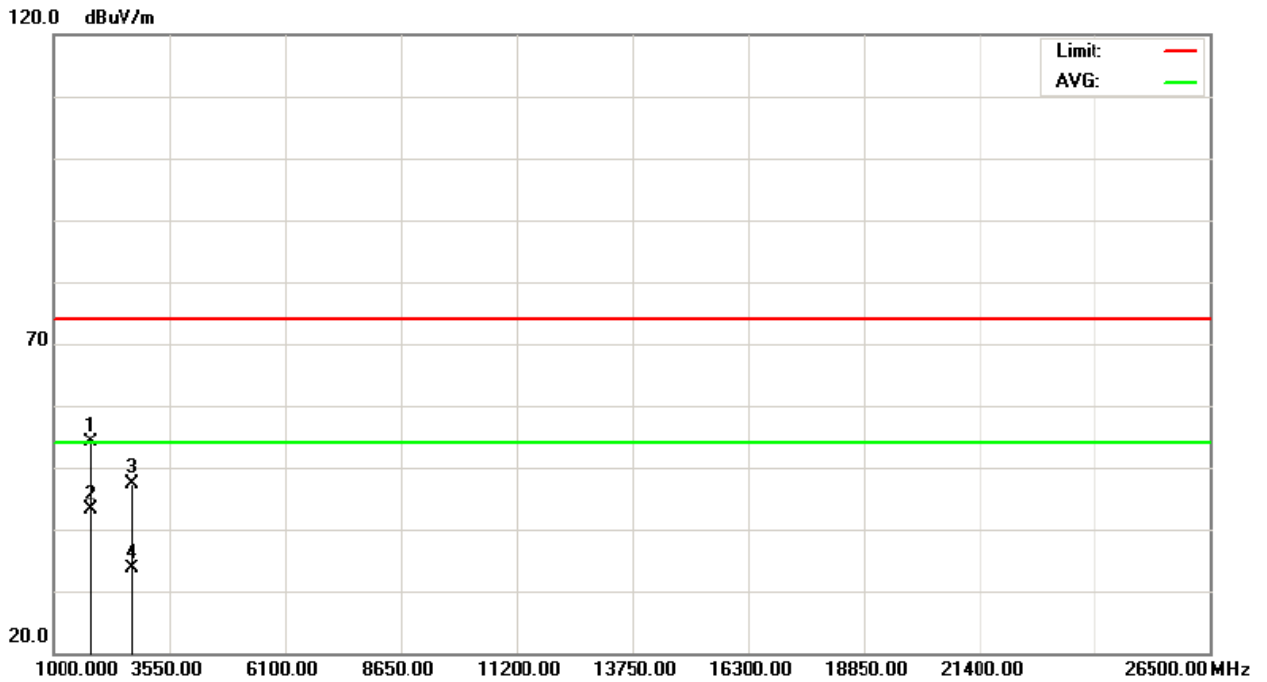



EUT :	mini-PCI radio Module	Model Name :	DLM108
Temperature :	26 ° C	Relative Humidity :	60%
Test Voltage :	AC 120V/60Hz		
Test Mode :	TX 912MHz_11B 20MHz		

Freq. (MHz)	Ant.Pol. H/V	Reading		Ant./CF CF(dB)	Act.		Limit		Note
		Peak (dBuV)	AV (dBuV)		Peak (dBuV/m)	AV (dBuV/m)	Peak (dBuV/m)	AV (dBuV/m)	
1823.95	V	57.60	56.36	-4.17	53.43	52.19	74.00	54.00	X/H
2740.55	V	46.34	38.96	-2.17	44.17	36.79	74.00	54.00	X/H
4823.87	H	58.51	57.05	-4.17	54.34	52.88	74.00	54.00	X/H
2738.09	H	43.01	33.74	-2.17	40.84	31.57	74.00	54.00	X/H

**Remark :**

- (1) Spectrum Setting : 30MHz – 1000MHz , RBW= 100KHz, VBW=100KHz, Sweep time = 200 ms. 1GHz- 25GHz, RBW= 1MHz, VBW= 1MHz, Sweep time = Auto
- (2) All readings are Peak unless otherwise stated QP in column of 『Note』 . Peak denotes that the Peak reading compliance with the QP Limits and then QP Mode measurement didn't perform ◦
- (3) Measuring frequency range from 30MHz to 1000MHz or the 10th harmonic of highest fundamental frequency ◦ "F" denotes fundamental frequency; "H" denotes spurious frequency. "E" denotes band edge frequency. (This judgment method includes the Band Edge Requirement.)
- (4) Radiated emissions measured in frequency range above 1000MHz were made with an instrument using Peak detector mode and AV detector mode of the emission ◦
- (5) Data of measurement within this frequency range shown " \* " in the table above means the reading of emissions are attenuated more than 20dB below the permissible limits or the field strength is too small to be measured.
- (6) A preamp and high pass filter were used for this test in order to provide sufficient measurement sensitivity.
- (7) EUT Orthogonal Axes :  
"X" - denotes Laid on Table ; "Y" - denotes Vertical Stand ; "Z" - denotes Side Stand
- (8) During the measurements above 1GHz it is taken care of that the EUT is always within the 3dB cone of radiation BW of the used antenna.



Orthogonal Axis : X

TX 912MHz\_11B 20MHz (Above 1000 MHz, Vertical)

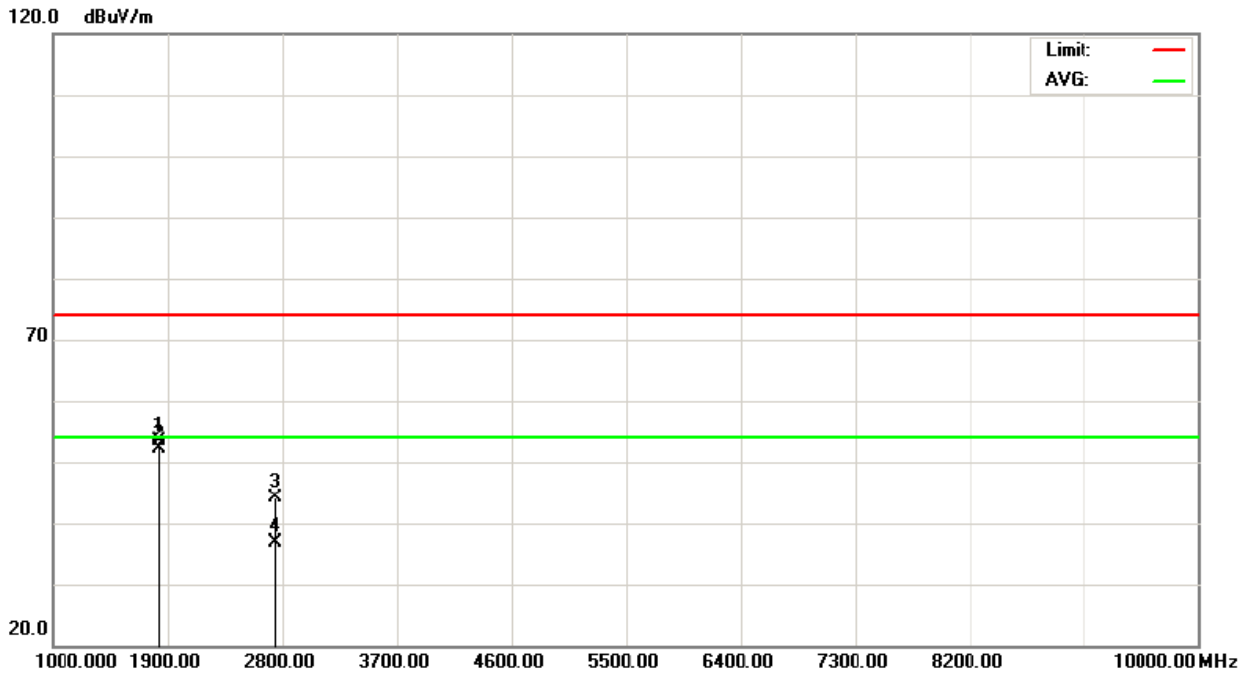

TX 912MHz\_11B 20MHz (Above 1000 MHz, Horizontal)

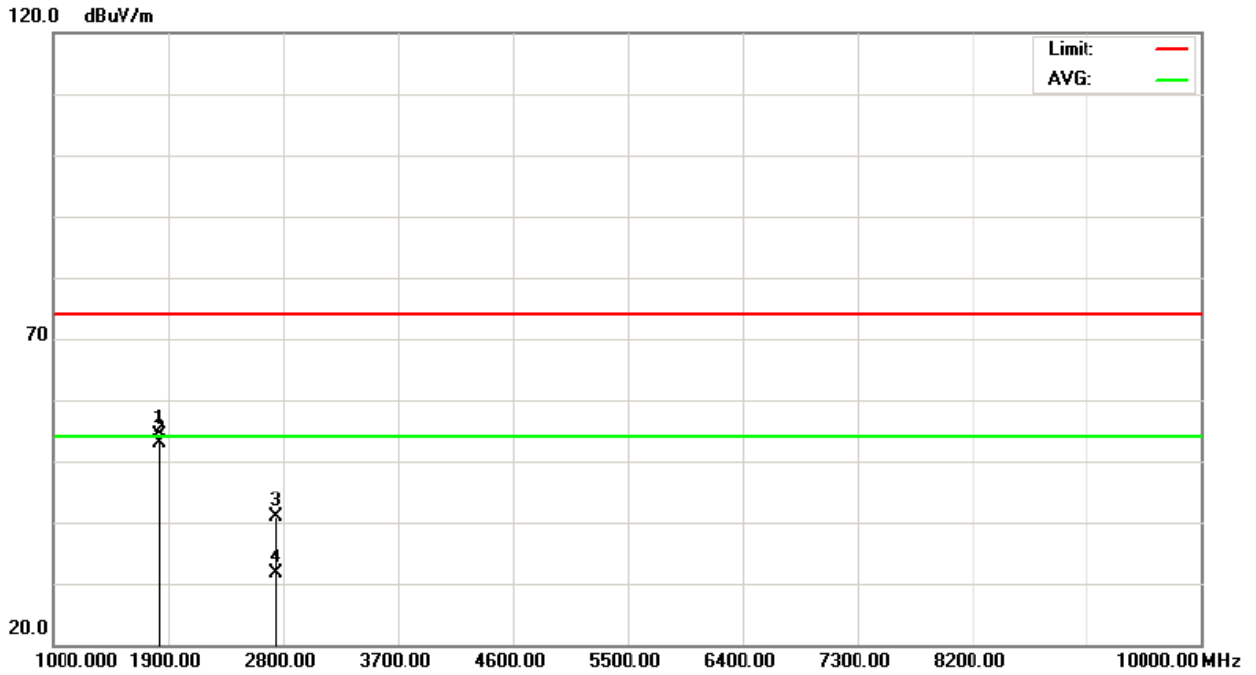



EUT :	mini-PCI radio Module	Model Name :	DLM108
Temperature :	26 ° C	Relative Humidity :	60%
Test Voltage :	AC 120V/60Hz		
Test Mode :	TX 912MHz_5MHz		

Freq. (MHz)	Ant.Pol. H/V	Reading		Ant./CF CF(dB)	Act.		Limit		Note
		Peak (dBuV)	AV (dBuV)		Peak (dBuV/m)	AV (dBuV/m)	Peak (dBuV/m)	AV (dBuV/m)	
1824.00	V	65.90	52.64	-4.17	61.73	48.47	74.00	54.00	X/H
2736.58	V	53.19	41.11	-2.17	51.02	38.94	74.00	54.00	X/H
1823.80	H	64.23	52.38	-4.17	60.06	48.21	74.00	54.00	X/H
2735.90	H	45.92	35.33	-2.16	43.76	33.17	74.00	54.00	X/H

**Remark :**

- (1) Spectrum Setting : 30MHz – 1000MHz , RBW= 100KHz, VBW=100KHz, Sweep time = 200 ms. 1GHz- 25GHz, RBW= 1MHz, VBW= 1MHz, Sweep time = Auto
- (2) All readings are Peak unless otherwise stated QP in column of 『Note』 . Peak denotes that the Peak reading compliance with the QP Limits and then QP Mode measurement didn't perform ◦
- (3) Measuring frequency range from 30MHz to 1000MHz or the 10th harmonic of highest fundamental frequency ◦“F” denotes fundamental frequency; “H” denotes spurious frequency. “E” denotes band edge frequency. (This judgment method includes the Band Edge Requirement.)
- (4) Radiated emissions measured in frequency range above 1000MHz were made with an instrument using Peak detector mode and AV detector mode of the emission ◦
- (5) Data of measurement within this frequency range shown “ \* ” in the table above means the reading of emissions are attenuated more than 20dB below the permissible limits or the field strength is too small to be measured.
- (6) A preamp and high pass filter were used for this test in order to provide sufficient measurement sensitivity.
- (7) EUT Orthogonal Axes :  
“X” - denotes Laid on Table ; “Y” - denotes Vertical Stand ; “Z” - denotes Side Stand
- (8) During the measurements above 1GHz it is taken care of that the EUT is always within the 3dB cone of radiation BW of the used antenna.



Orthogonal Axis : X  
TX 912MHz\_11G 5MHz (Above 1000 MHz, Vertical)

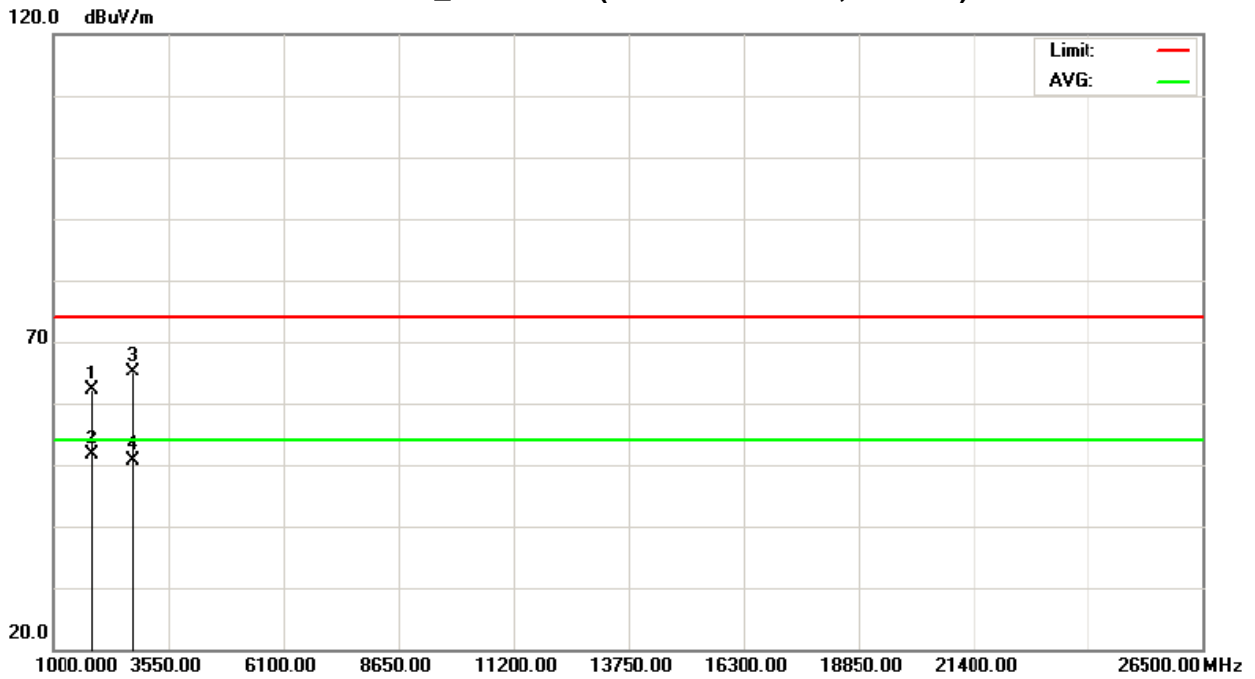

TX 912MHz\_11G 5MHz (Above 1000 MHz, Horizontal)

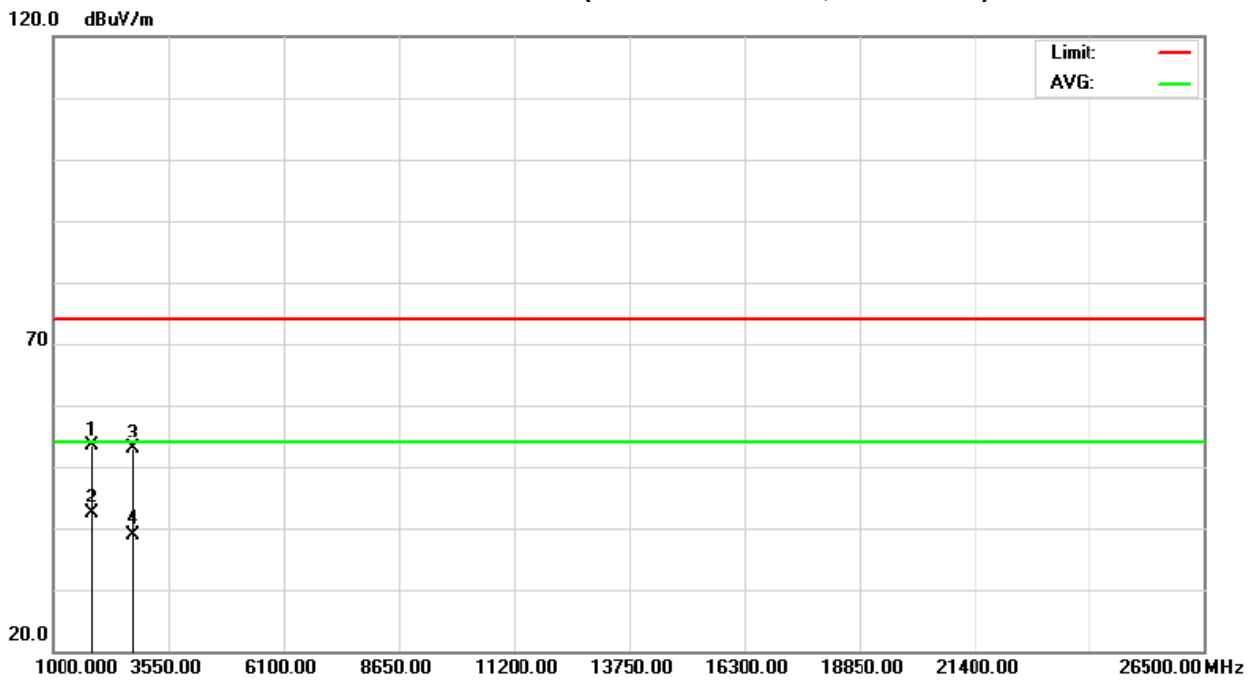



EUT :	mini-PCI radio Module	Model Name :	DLM108
Temperature :	26 ° C	Relative Humidity :	60%
Test Voltage :	AC 120V/60Hz		
Test Mode :	TX 912MHz_11G 10MHz		

Freq. (MHz)	Ant.Pol. H/V	Reading		Ant./CF CF(dB)	Act.		Limit		Note
		Peak (dBuV)	AV (dBuV)		Peak (dBuV/m)	AV (dBuV/m)	Peak (dBuV/m)	AV (dBuV/m)	
1824.20	V	61.50	50.63	-4.17	57.33	46.46	74.00	54.00	X/H
2738.16	V	48.35	37.53	-2.17	46.18	35.36	74.00	54.00	X/H
1824.08	H	62.19	50.02	-4.17	58.02	45.85	74.00	54.00	X/H
2737.96	H	44.73	33.96	-2.17	42.56	31.79	74.00	54.00	X/H

**Remark :**

- (1) Spectrum Setting : 30MHz – 1000MHz , RBW= 100KHz, VBW=100KHz, Sweep time = 200 ms. 1GHz- 25GHz, RBW= 1MHz, VBW= 1MHz, Sweep time = Auto
- (2) All readings are Peak unless otherwise stated QP in column of 『Note』 . Peak denotes that the Peak reading compliance with the QP Limits and then QP Mode measurement didn't perform ◦
- (3) Measuring frequency range from 30MHz to 1000MHz or the 10th harmonic of highest fundamental frequency ◦ "F" denotes fundamental frequency; "H" denotes spurious frequency. "E" denotes band edge frequency. (This judgment method includes the Band Edge Requirement.)
- (4) Radiated emissions measured in frequency range above 1000MHz were made with an instrument using Peak detector mode and AV detector mode of the emission ◦
- (5) Data of measurement within this frequency range shown " \* " in the table above means the reading of emissions are attenuated more than 20dB below the permissible limits or the field strength is too small to be measured.
- (6) A preamp and high pass filter were used for this test in order to provide sufficient measurement sensitivity.
- (7) EUT Orthogonal Axes :  
"X" - denotes Laid on Table ; "Y" - denotes Vertical Stand ; "Z" - denotes Side Stand
- (8) During the measurements above 1GHz it is taken care of that the EUT is always within the 3dB cone of radiation BW of the used antenna.



Orthogonal Axis : X

TX 912MHz\_11G 10MHz (Above 1000 MHz, Vertical)

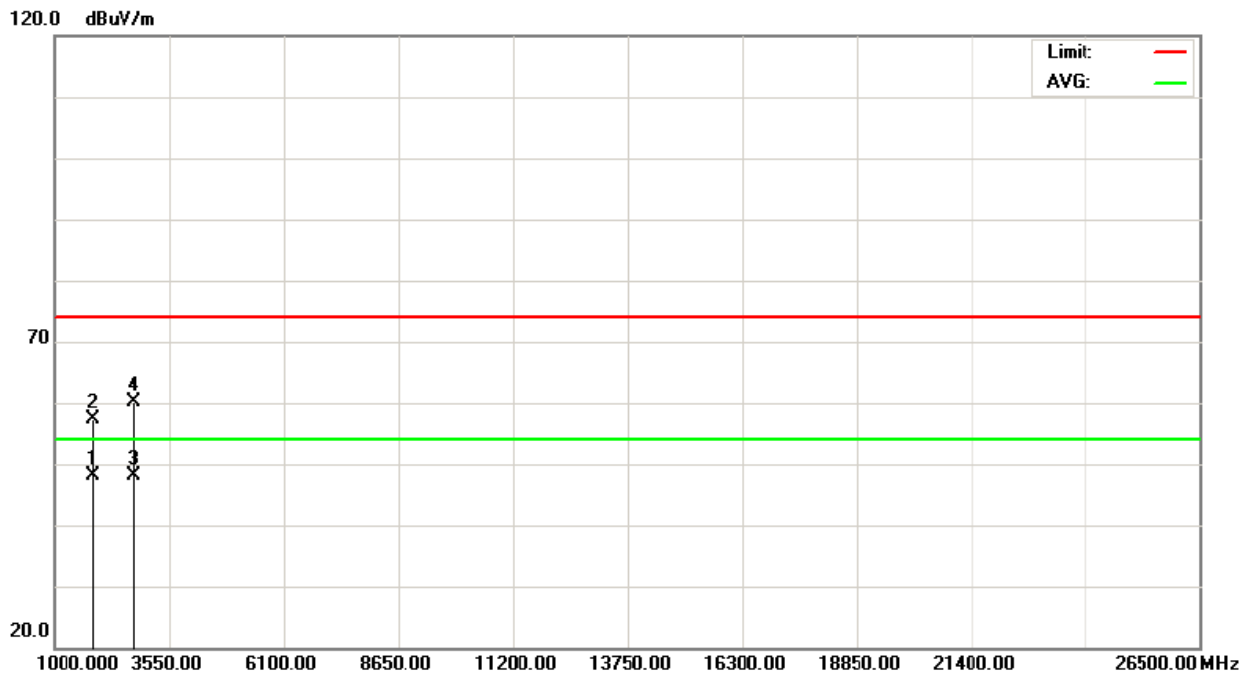

TX 912MHz\_11G 10MHz (Above 1000 MHz, Horizontal)

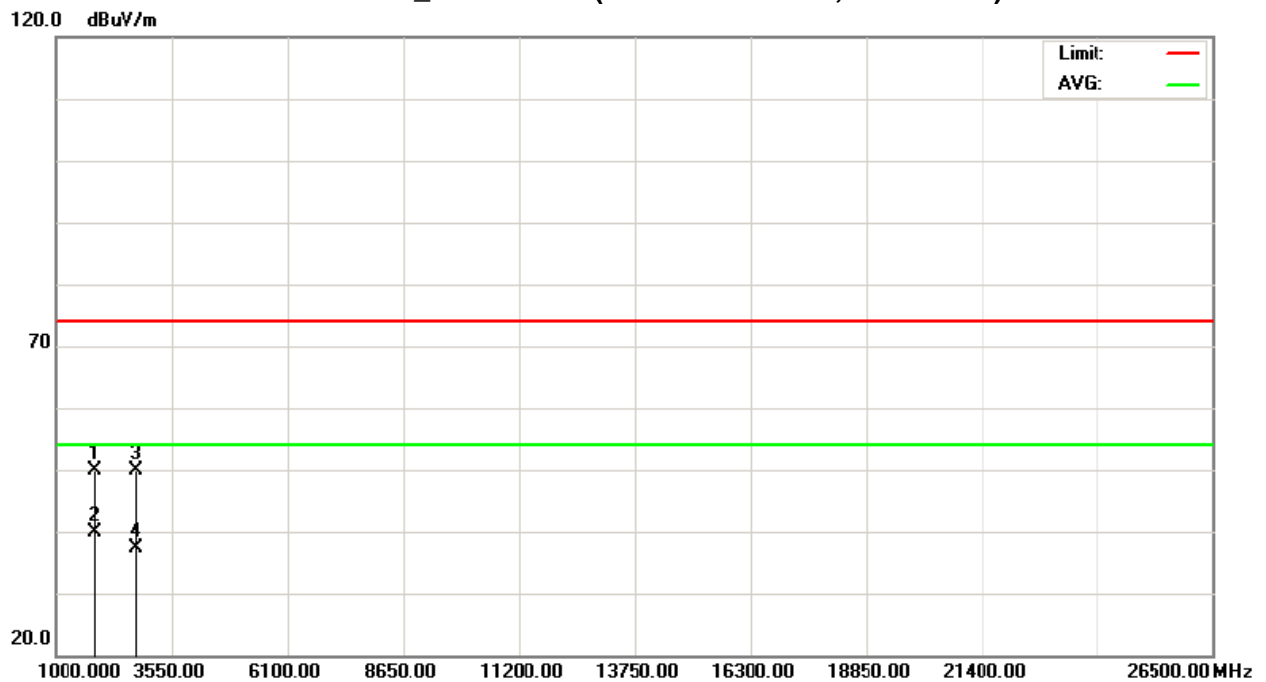





EUT :	mini-PCI radio Module	Model Name :	DLM108
Temperature :	26 ° C	Relative Humidity :	60%
Test Voltage :	AC 120V/60Hz		
Test Mode :	TX 912MHz_11G 20MHz		

Freq. (MHz)	Ant.Pol. H/V	Reading		Ant./CF CF(dB)	Act.		Limit		Note
		Peak (dBuV)	AV (dBuV)		Peak (dBuV/m)	AV (dBuV/m)	Peak (dBuV/m)	AV (dBuV/m)	
1823.88	V	58.32	46.72	-4.17	54.15	42.55	74.00	54.00	X/H
2741.95	V	47.16	36.23	-2.18	44.98	34.05	74.00	54.00	X/H
1824.44	H	58.20	46.16	-4.17	54.03	41.99	74.00	54.00	X/H
2739.11	H	42.11	32.59	-2.17	39.94	30.42	74.00	54.00	X/H

**Remark :**

- (1) Spectrum Setting : 30MHz – 1000MHz , RBW= 100KHz, VBW=100KHz, Sweep time = 200 ms. 1GHz- 25GHz, RBW= 1MHz, VBW= 1MHz, Sweep time = Auto
- (2) All readings are Peak unless otherwise stated QP in column of 『Note』 . Peak denotes that the Peak reading compliance with the QP Limits and then QP Mode measurement didn't perform ◦
- (3) Measuring frequency range from 30MHz to 1000MHz or the 10th harmonic of highest fundamental frequency ◦“F” denotes fundamental frequency; “H” denotes spurious frequency. “E” denotes band edge frequency. (This judgment method includes the Band Edge Requirement.)
- (4) Radiated emissions measured in frequency range above 1000MHz were made with an instrument using Peak detector mode and AV detector mode of the emission ◦
- (5) Data of measurement within this frequency range shown “ \* ” in the table above means the reading of emissions are attenuated more than 20dB below the permissible limits or the field strength is too small to be measured.
- (6) A preamp and high pass filter were used for this test in order to provide sufficient measurement sensitivity.
- (7) EUT Orthogonal Axes :  
“X” - denotes Laid on Table ; ”Y” - denotes Vertical Stand ; ”Z” - denotes Side Stand
- (8) During the measurements above 1GHz it is taken care of that the EUT is always within the 3dB cone of radiation BW of the used antenna.



Orthogonal Axis : X

TX 912MHz\_11G 20MHz (Above 1000 MHz, Vertical)

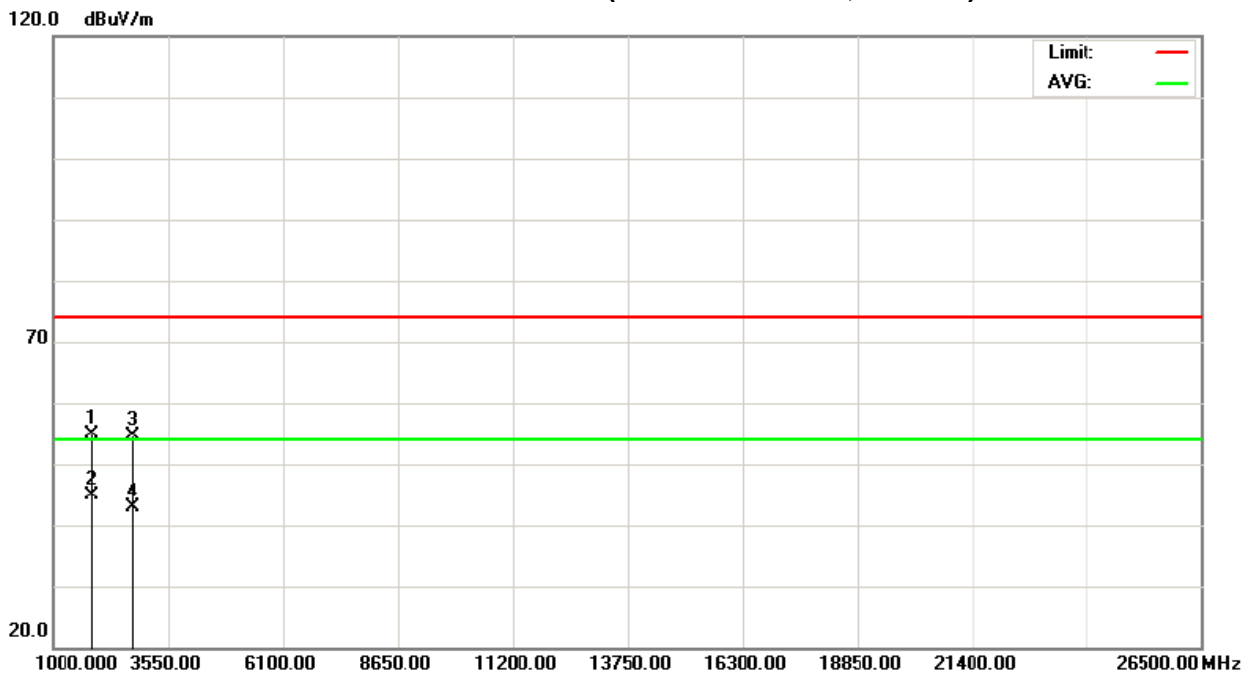

TX 912MHz\_11G 20MHz (Above 1000 MHz, Horizontal)

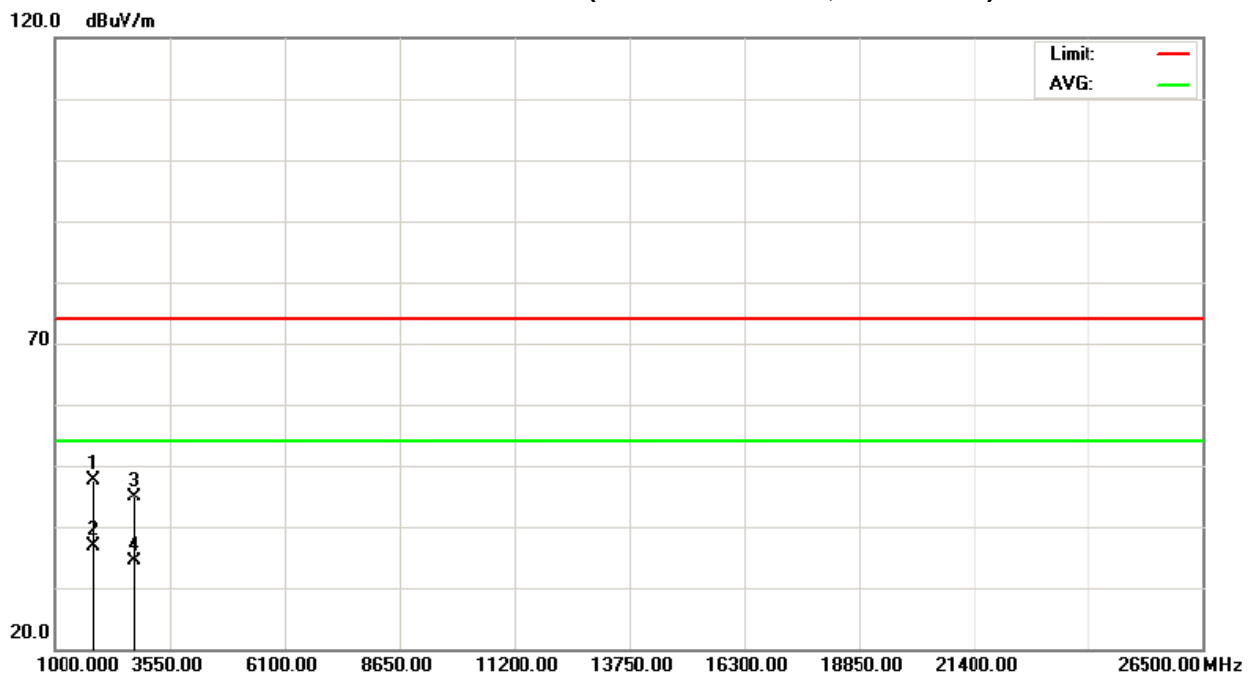



EUT :	mini-PCI radio Module	Model Name :	DLM108
Temperature :	26 °C	Relative Humidity :	60%
Test Voltage :	AC 120V/60Hz		
Test Mode :	TX 917MHz_11B 20MHz		

Freq. (MHz)	Ant.Pol. H/V	Reading		Ant./CF CF(dB)	Act.		Limit		Note
		Peak (dBuV)	AV (dBuV)		Peak (dBuV/m)	AV (dBuV/m)	Peak (dBuV/m)	AV (dBuV/m)	
1833.95	V	59.01	57.30	-4.15	54.86	53.15	74.00	54.00	X/H
2753.68	V	47.50	41.43	-2.20	45.30	39.23	74.00	54.00	X/H
1833.96	H	57.46	55.93	-4.15	53.31	51.78	74.00	54.00	X/H
2752.00	H	44.58	34.56	-2.20	42.38	32.36	74.00	54.00	X/H

**Remark :**

- (1) Spectrum Setting : 30MHz – 1000MHz , RBW= 100KHz, VBW=100KHz, Sweep time = 200 ms. 1GHz- 25GHz, RBW= 1MHz, VBW= 1MHz, Sweep time = Auto
- (2) All readings are Peak unless otherwise stated QP in column of 『Note』 . Peak denotes that the Peak reading compliance with the QP Limits and then QP Mode measurement didn't perform ◦
- (3) Measuring frequency range from 30MHz to 1000MHz or the 10th harmonic of highest fundamental frequency ◦ "F" denotes fundamental frequency; "H" denotes spurious frequency. "E" denotes band edge frequency. (This judgment method includes the Band Edge Requirement.)
- (4) Radiated emissions measured in frequency range above 1000MHz were made with an instrument using Peak detector mode and AV detector mode of the emission ◦
- (5) Data of measurement within this frequency range shown " \* " in the table above means the reading of emissions are attenuated more than 20dB below the permissible limits or the field strength is too small to be measured.
- (6) A preamp and high pass filter were used for this test in order to provide sufficient measurement sensitivity.
- (7) EUT Orthogonal Axes :  
"X" - denotes Laid on Table ; "Y" - denotes Vertical Stand ; "Z" - denotes Side Stand
- (8) During the measurements above 1GHz it is taken care of that the EUT is always within the 3dB cone of radiation BW of the used antenna.



Orthogonal Axis : X

TX 917MHz\_11B 20MHz (Above 1000 MHz, Vertical)

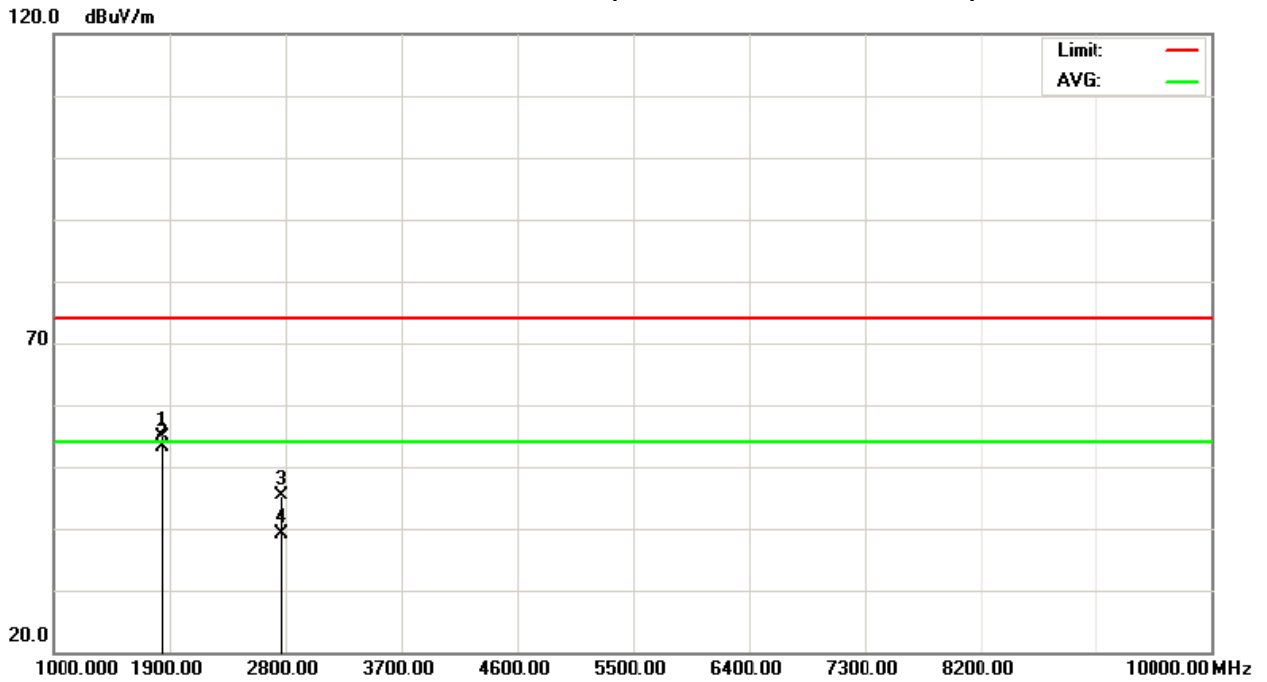

TX 917MHz\_11B 20MHz (Above 1000 MHz, Horizontal)

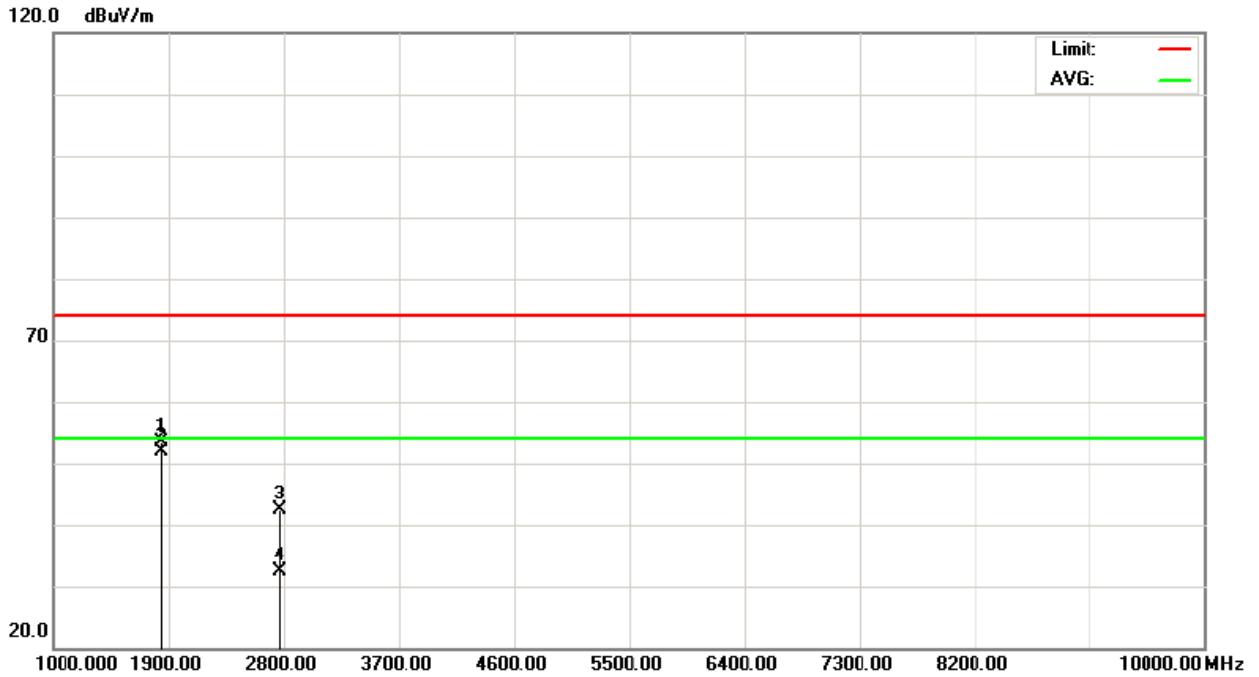



EUT :	mini-PCI radio Module	Model Name :	DLM108
Temperature :	26 ° C	Relative Humidity :	60%
Test Voltage :	AC 120V/60Hz		
Test Mode :	TX 917MHz_5MHz		

Freq. (MHz)	Ant.Pol. H/V	Reading		Ant./CF CF(dB)	Act.		Limit		Note
		Peak (dBuV)	AV (dBuV)		Peak (dBuV/m)	AV (dBuV/m)	Peak (dBuV/m)	AV (dBuV/m)	
1834.72	V	64.73	51.87	-4.15	60.58	47.72	74.00	54.00	X/H
2752.28	V	51.62	40.97	-2.20	49.42	38.77	74.00	54.00	X/H
1834.20	H	62.43	51.24	-4.15	58.28	47.09	74.00	54.00	X/H
2752.12	H	45.30	34.18	-2.20	43.10	31.98	74.00	54.00	X/H

**Remark :**

- (1) Spectrum Setting : 30MHz – 1000MHz , RBW= 100KHz, VBW=100KHz, Sweep time = 200 ms. 1GHz- 25GHz, RBW= 1MHz, VBW= 1MHz, Sweep time = Auto
- (2) All readings are Peak unless otherwise stated QP in column of 『Note』 . Peak denotes that the Peak reading compliance with the QP Limits and then QP Mode measurement didn't perform ◦
- (3) Measuring frequency range from 30MHz to 1000MHz or the 10th harmonic of highest fundamental frequency ◦“F” denotes fundamental frequency; “H” denotes spurious frequency. “E” denotes band edge frequency. (This judgment method includes the Band Edge Requirement.)
- (4) Radiated emissions measured in frequency range above 1000MHz were made with an instrument using Peak detector mode and AV detector mode of the emission ◦
- (5) Data of measurement within this frequency range shown “ \* ” in the table above means the reading of emissions are attenuated more than 20dB below the permissible limits or the field strength is too small to be measured.
- (6) A preamp and high pass filter were used for this test in order to provide sufficient measurement sensitivity.
- (7) EUT Orthogonal Axes :  
“X” - denotes Laid on Table ; ”Y” - denotes Vertical Stand ; ”Z” - denotes Side Stand
- (8) During the measurements above 1GHz it is taken care of that the EUT is always within the 3dB cone of radiation BW of the used antenna.



Orthogonal Axis : X  
TX 917MHz\_11G 5MHz (Above 1000 MHz, Vertical)

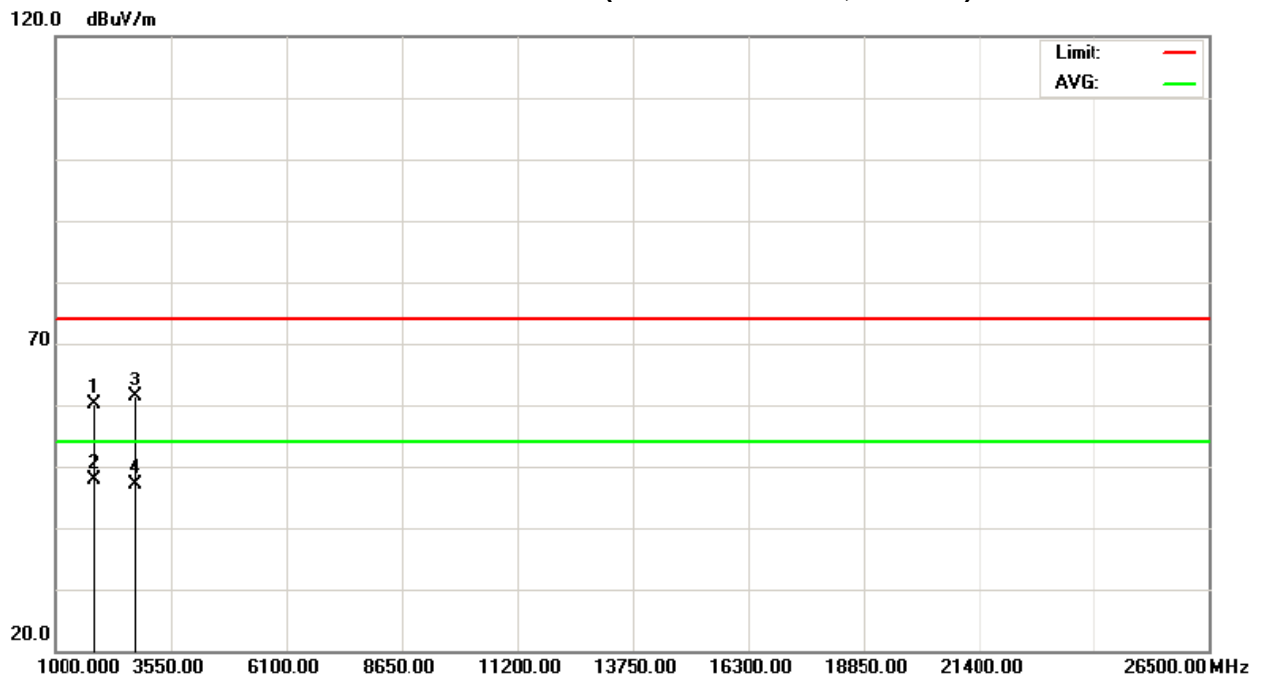

TX 917MHz\_11G 5MHz (Above 1000 MHz, Horizontal)

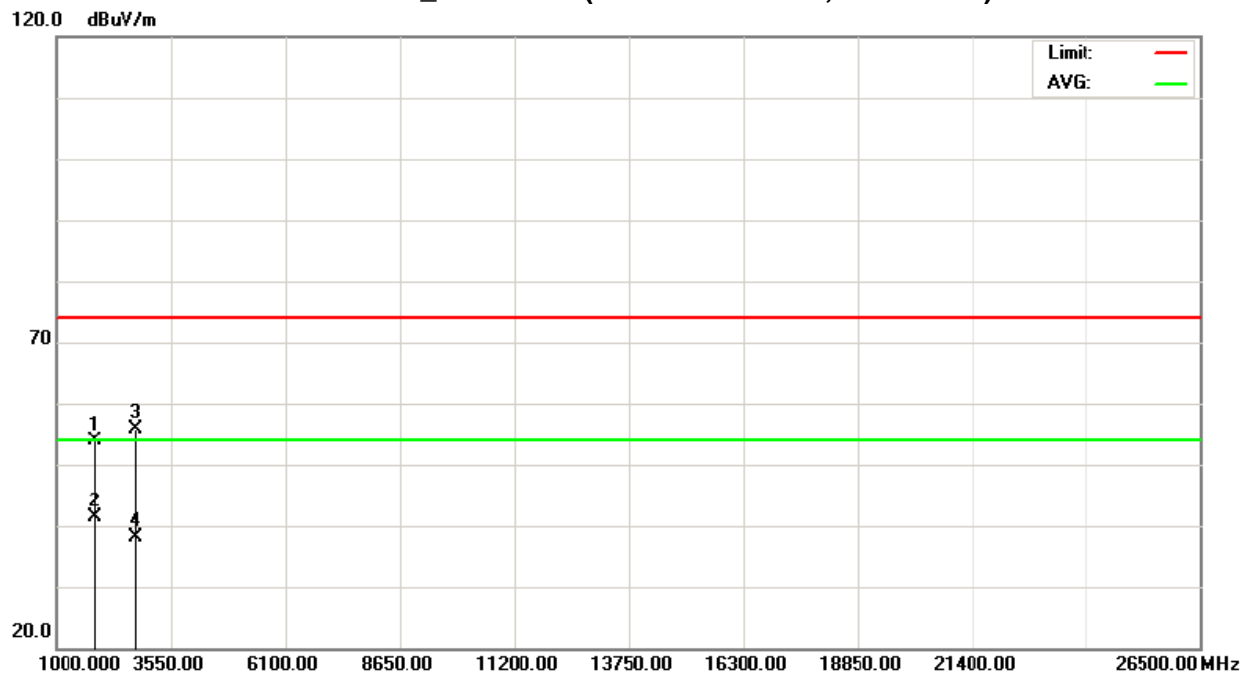



EUT :	mini-PCI radio Module	Model Name :	DLM108
Temperature :	26 ° C	Relative Humidity :	60%
Test Voltage :	AC 120V/60Hz		
Test Mode :	TX 917MHz_11G 10MHz		

Freq. (MHz)	Ant.Pol. H/V	Reading		Ant./CF CF(dB)	Act.		Limit		Note
		Peak (dBuV)	AV (dBuV)		Peak (dBuV/m)	AV (dBuV/m)	Peak (dBuV/m)	AV (dBuV/m)	
1836.56	V	63.56	49.59	-4.14	59.42	45.45	74.00	54.00	X/H
2753.60	V	48.53	38.70	-2.20	46.33	36.50	74.00	54.00	X/H
1836.00	H	60.06	48.34	-4.15	55.91	44.19	74.00	54.00	X/H
2754.59	H	43.59	33.07	-2.21	41.38	30.86	74.00	54.00	X/H

**Remark :**

- (1) Spectrum Setting : 30MHz – 1000MHz , RBW= 100KHz, VBW=100KHz, Sweep time = 200 ms. 1GHz- 25GHz, RBW= 1MHz, VBW= 1MHz, Sweep time = Auto
- (2) All readings are Peak unless otherwise stated QP in column of 『Note』 . Peak denotes that the Peak reading compliance with the QP Limits and then QP Mode measurement didn't perform ◦
- (3) Measuring frequency range from 30MHz to 1000MHz or the 10th harmonic of highest fundamental frequency ◦ "F" denotes fundamental frequency; "H" denotes spurious frequency. "E" denotes band edge frequency. (This judgment method includes the Band Edge Requirement.)
- (4) Radiated emissions measured in frequency range above 1000MHz were made with an instrument using Peak detector mode and AV detector mode of the emission ◦
- (5) Data of measurement within this frequency range shown " \* " in the table above means the reading of emissions are attenuated more than 20dB below the permissible limits or the field strength is too small to be measured.
- (6) A preamp and high pass filter were used for this test in order to provide sufficient measurement sensitivity.
- (7) EUT Orthogonal Axes :  
"X" - denotes Laid on Table ; "Y" - denotes Vertical Stand ; "Z" - denotes Side Stand
- (8) During the measurements above 1GHz it is taken care of that the EUT is always within the 3dB cone of radiation BW of the used antenna.



Orthogonal Axis : X  
TX 917MHz\_11G 10MHz (Above 1000 MHz, Vertical)

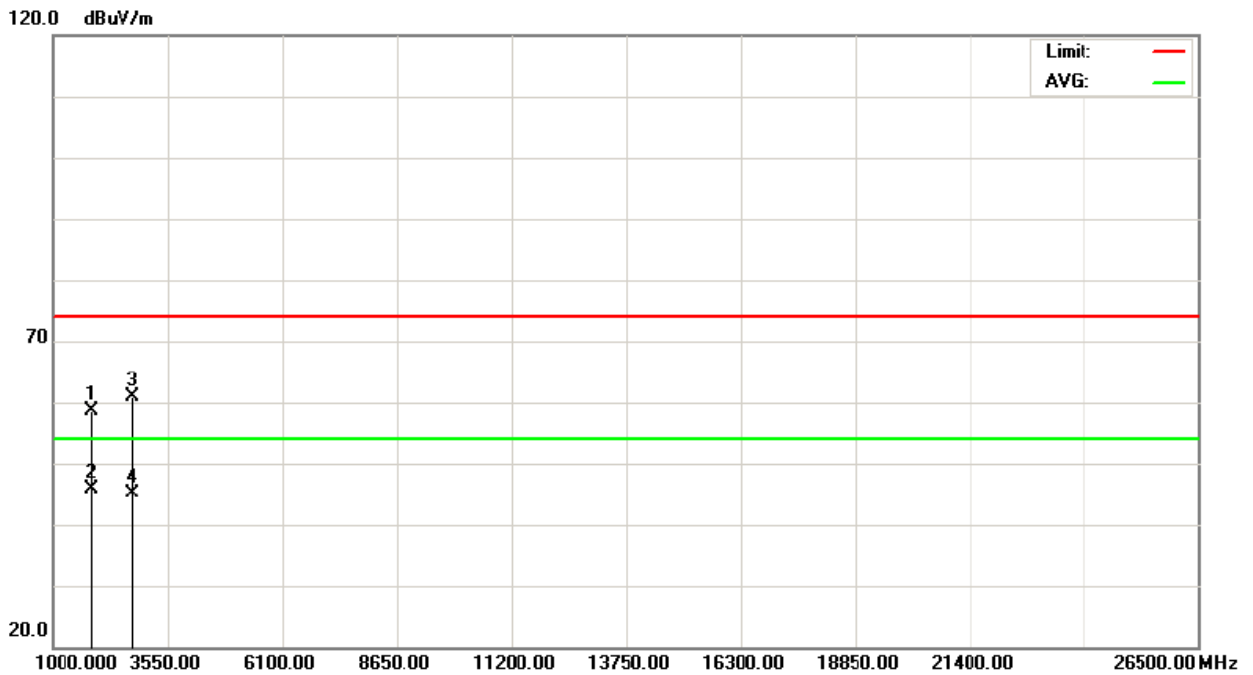

TX 917MHz\_11G 10MHz (Above 1000 MHz, Horizontal)

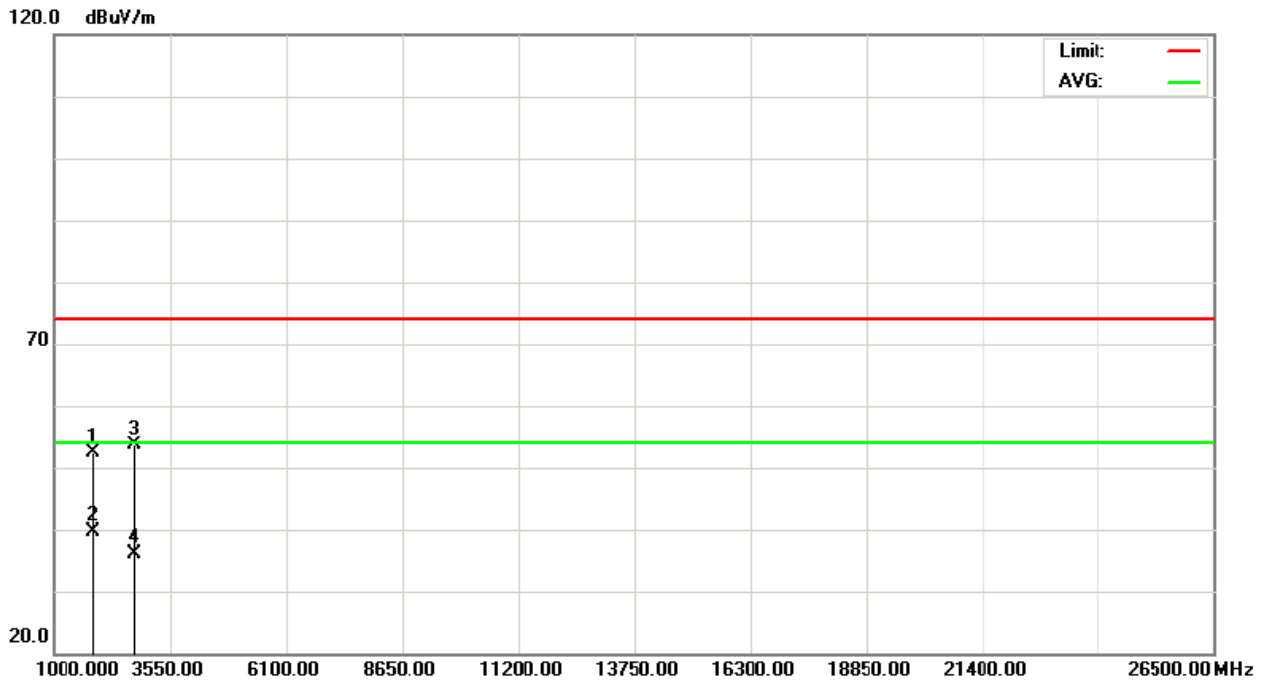





EUT :	mini-PCI radio Module	Model Name :	DLM108
Temperature :	26 ° C	Relative Humidity :	60%
Test Voltage :	AC 120V/60Hz		
Test Mode :	TX 917MHz_11G 20MHz		

Freq. (MHz)	Ant.Pol. H/V	Reading		Ant./CF CF(dB)	Act.		Limit		Note
		Peak (dBuV)	AV (dBuV)		Peak (dBuV/m)	AV (dBuV/m)	Peak (dBuV/m)	AV (dBuV/m)	
1836.75	V	60.74	47.00	-4.14	56.60	42.86	74.00	54.00	X/H
2753.72	V	46.77	36.75	-2.20	44.57	34.55	74.00	54.00	X/H
1837.31	H	57.50	46.04	-4.14	53.36	41.90	74.00	54.00	X/H
2756.11	H	42.16	32.36	-2.21	39.95	30.15	74.00	54.00	X/H

**Remark :**

- (1) Spectrum Setting : 30MHz – 1000MHz , RBW= 100KHz, VBW=100KHz, Sweep time = 200 ms. 1GHz- 25GHz, RBW= 1MHz, VBW= 1MHz, Sweep time = Auto
- (2) All readings are Peak unless otherwise stated QP in column of 『Note』 . Peak denotes that the Peak reading compliance with the QP Limits and then QP Mode measurement didn't perform ◦
- (3) Measuring frequency range from 30MHz to 1000MHz or the 10th harmonic of highest fundamental frequency ◦“F” denotes fundamental frequency; “H” denotes spurious frequency. “E” denotes band edge frequency. (This judgment method includes the Band Edge Requirement.)
- (4) Radiated emissions measured in frequency range above 1000MHz were made with an instrument using Peak detector mode and AV detector mode of the emission ◦
- (5) Data of measurement within this frequency range shown “ \* ” in the table above means the reading of emissions are attenuated more than 20dB below the permissible limits or the field strength is too small to be measured.
- (6) A preamp and high pass filter were used for this test in order to provide sufficient measurement sensitivity.
- (7) EUT Orthogonal Axes :  
“X” - denotes Laid on Table ; ”Y” - denotes Vertical Stand ; ”Z” - denotes Side Stand
- (8) During the measurements above 1GHz it is taken care of that the EUT is always within the 3dB cone of radiation BW of the used antenna.



Orthogonal Axis : X  
TX 917MHz\_11G 20MHz (Above 1000 MHz, Vertical)

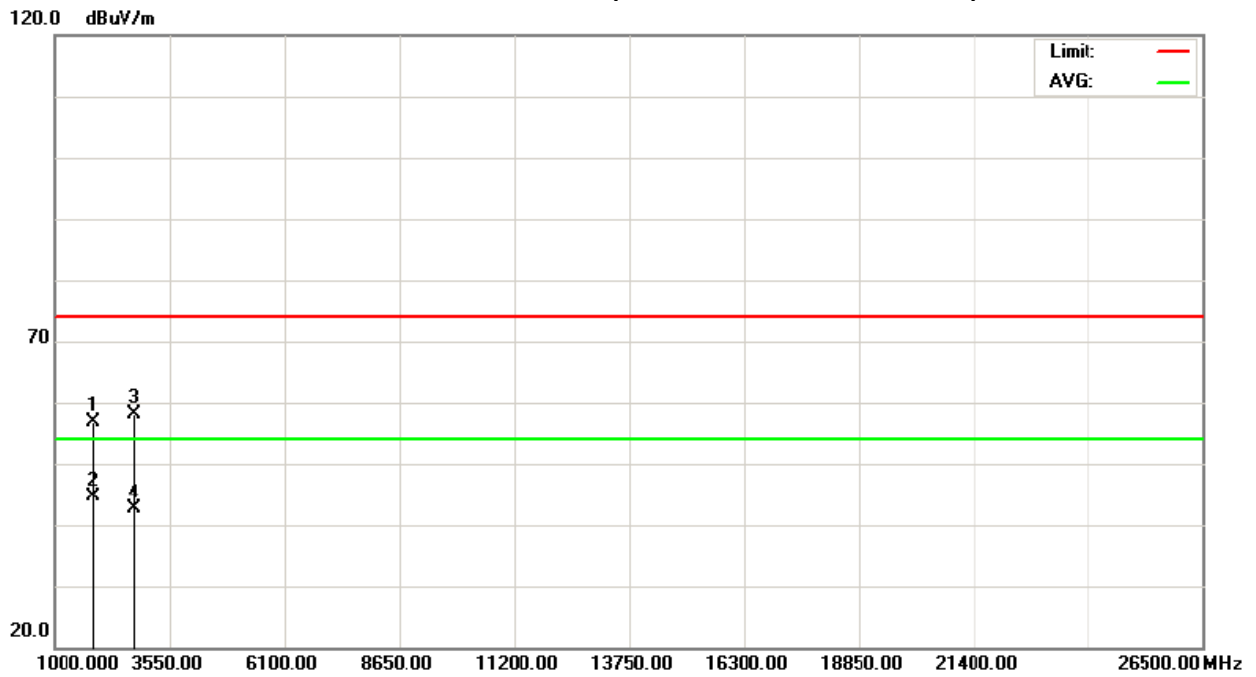

TX 917MHz\_11G 20MHz (Above 1000 MHz, Horizontal)

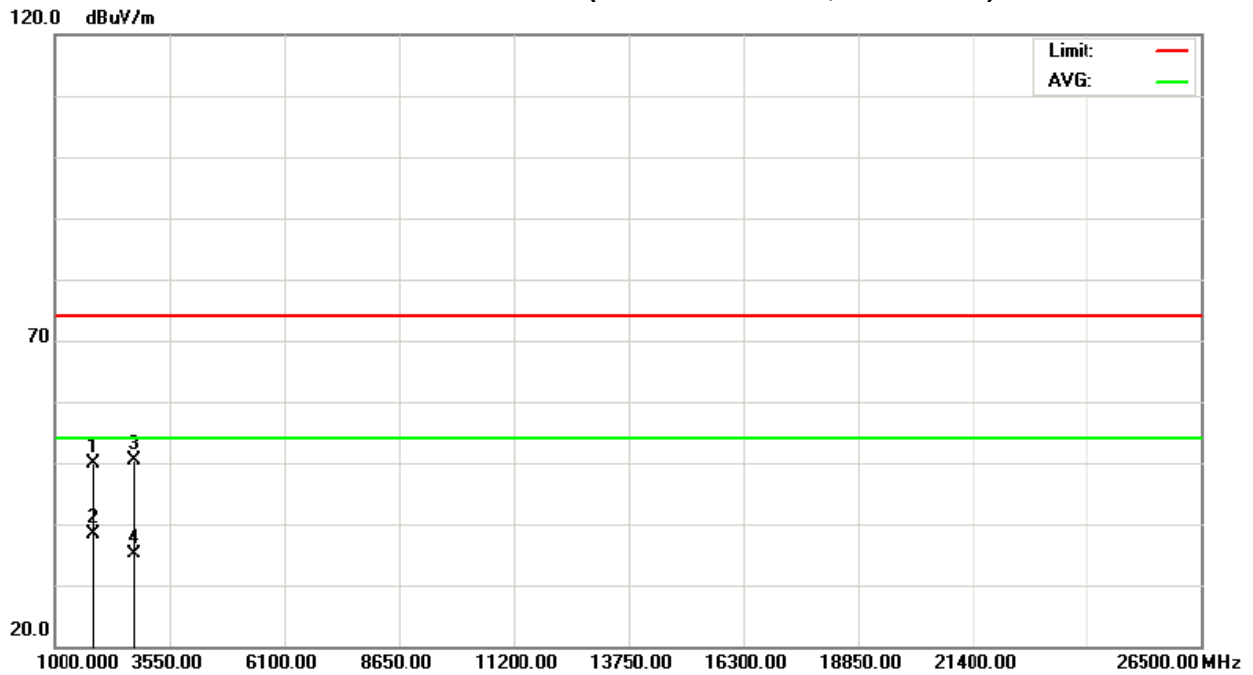



EUT :	mini-PCI radio Module	Model Name :	DLM108
Temperature :	26 ° C	Relative Humidity :	60%
Test Voltage :	AC 120V/60Hz		
Test Mode :	TX 922MHz_5MHz		

Freq. (MHz)	Ant. Pol. H/V	Reading		Ant./CF CF(dB)	Act.		Limit		Note
		Peak (dBuV)	AV (dBuV)		Peak (dBuV/m)	AV (dBuV/m)	Peak (dBuV/m)	AV (dBuV/m)	
1843.36	V	65.01	51.15	-4.13	60.88	47.02	74.00	54.00	X/H
2763.96	V	51.63	40.19	-2.23	49.40	37.96	74.00	54.00	X/H
1843.64	H	62.44	50.29	-4.13	58.31	46.16	74.00	54.00	X/H
2764.36	H	44.41	33.94	-2.23	42.18	31.71	74.00	54.00	X/H

**Remark :**

- (1) Spectrum Setting : 30MHz – 1000MHz , RBW= 100KHz, VBW=100KHz, Sweep time = 200 ms. 1GHz- 25GHz, RBW= 1MHz, VBW= 1MHz, Sweep time = Auto
- (2) All readings are Peak unless otherwise stated QP in column of 『Note』 . Peak denotes that the Peak reading compliance with the QP Limits and then QP Mode measurement didn't perform ◦
- (3) Measuring frequency range from 30MHz to 1000MHz or the 10th harmonic of highest fundamental frequency ◦ "F" denotes fundamental frequency; "H" denotes spurious frequency. "E" denotes band edge frequency. (This judgment method includes the Band Edge Requirement.)
- (4) Radiated emissions measured in frequency range above 1000MHz were made with an instrument using Peak detector mode and AV detector mode of the emission ◦
- (5) Data of measurement within this frequency range shown " \* " in the table above means the reading of emissions are attenuated more than 20dB below the permissible limits or the field strength is too small to be measured.
- (6) A preamp and high pass filter were used for this test in order to provide sufficient measurement sensitivity.
- (7) EUT Orthogonal Axes :  
"X" - denotes Laid on Table ; "Y" - denotes Vertical Stand ; "Z" - denotes Side Stand
- (8) During the measurements above 1GHz it is taken care of that the EUT is always within the 3dB cone of radiation BW of the used antenna.



Orthogonal Axis : X  
TX 922MHz\_11G 5MHz (Above 1000 MHz, Vertical)

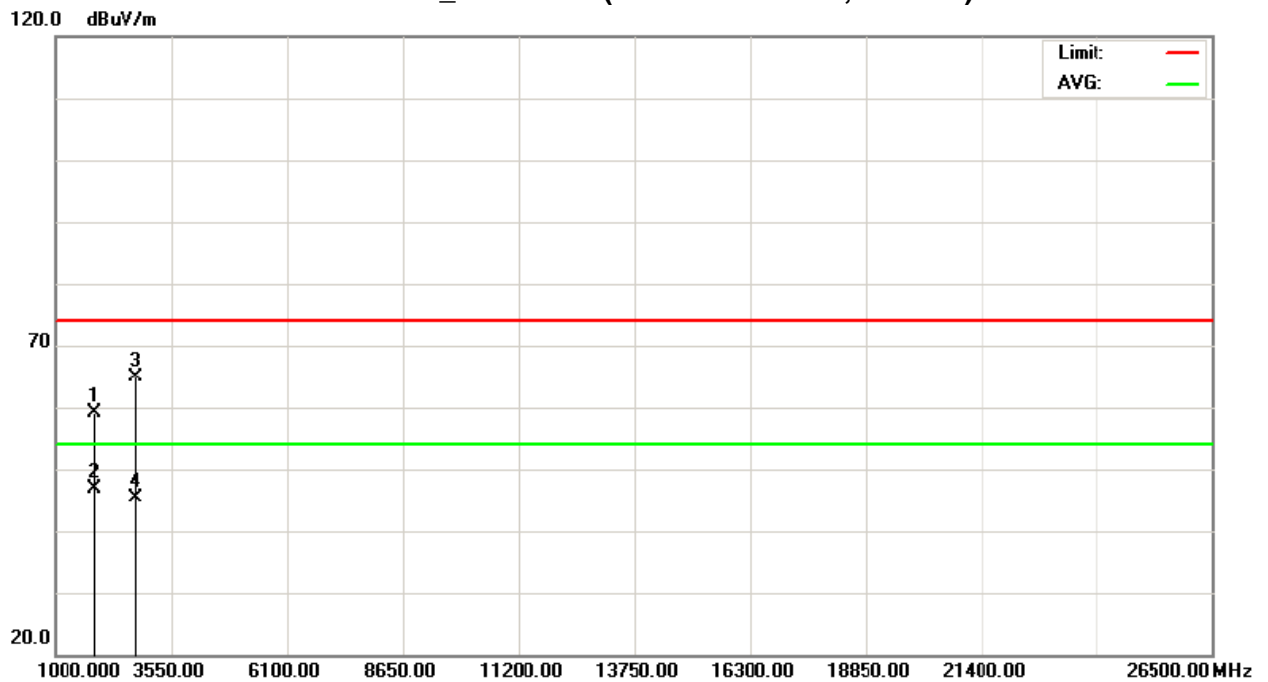

TX 922MHz\_11G 5MHz (Above 1000 MHz, Horizontal)

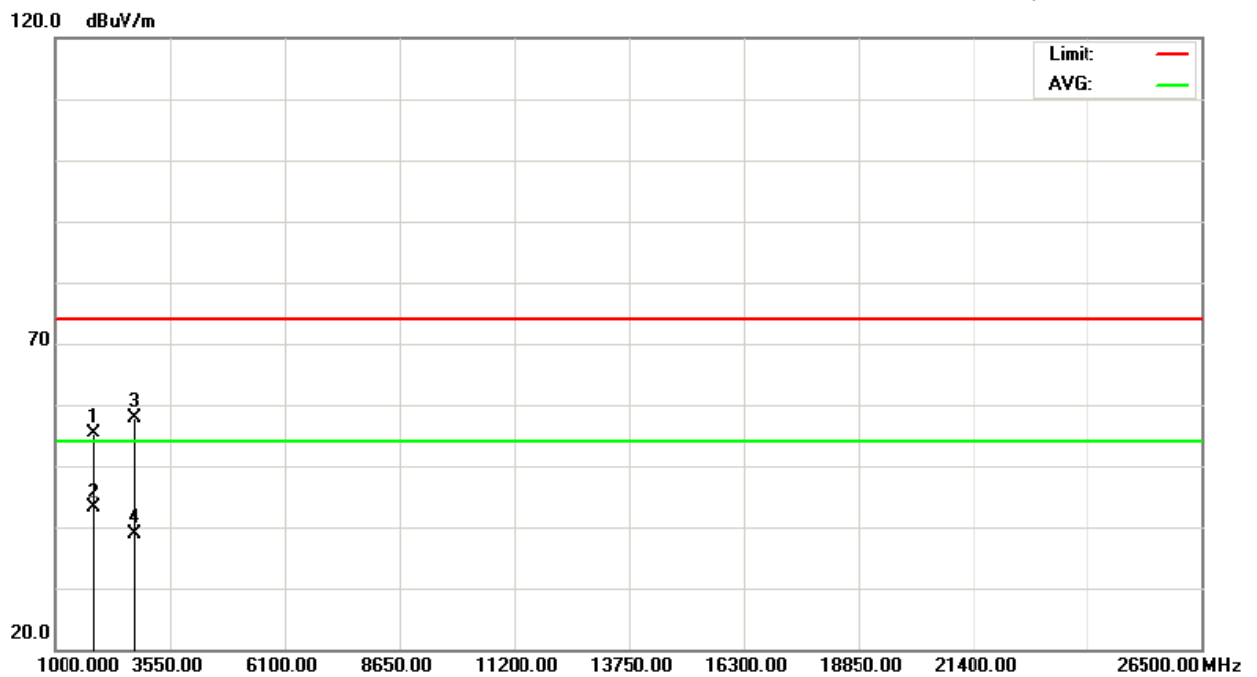



EUT :	mini-PCI radio Module	Model Name :	DLM108
Temperature :	26 ° C	Relative Humidity :	60%
Test Voltage :	AC 120V/60Hz		
Test Mode :	TX 922MHz_ 11G 10MHz		

Freq. (MHz)	Ant.Pol. H/V	Reading		Ant./CF CF(dB)	Act.		Limit		Note
		Peak (dBuV)	AV (dBuV)		Peak (dBuV/m)	AV (dBuV/m)	Peak (dBuV/m)	AV (dBuV/m)	
1839.81	V	60.72	48.88	-4.14	56.58	44.74	74.00	54.00	X/H
2761.61	V	49.24	37.61	-2.22	47.02	35.39	74.00	54.00	X/H
1839.85	H	59.80	47.21	-4.14	55.66	43.07	74.00	54.00	X/H
2762.09	H	42.73	32.49	-2.22	40.51	30.27	74.00	54.00	X/H

**Remark :**

- (1) Spectrum Setting : 30MHz – 1000MHz , RBW= 100KHz, VBW=100KHz, Sweep time = 200 ms. 1GHz- 25GHz, RBW= 1MHz, VBW= 1MHz, Sweep time = Auto
- (2) All readings are Peak unless otherwise stated QP in column of 『Note』 . Peak denotes that the Peak reading compliance with the QP Limits and then QP Mode measurement didn't perform ◦
- (3) Measuring frequency range from 30MHz to 1000MHz or the 10th harmonic of highest fundamental frequency ◦“F” denotes fundamental frequency; “H” denotes spurious frequency. “E” denotes band edge frequency. (This judgment method includes the Band Edge Requirement.)
- (4) Radiated emissions measured in frequency range above 1000MHz were made with an instrument using Peak detector mode and AV detector mode of the emission ◦
- (5) Data of measurement within this frequency range shown “ \* ” in the table above means the reading of emissions are attenuated more than 20dB below the permissible limits or the field strength is too small to be measured.
- (6) A preamp and high pass filter were used for this test in order to provide sufficient measurement sensitivity.
- (7) EUT Orthogonal Axes :  
“X” - denotes Laid on Table ; ”Y” - denotes Vertical Stand ; ”Z” - denotes Side Stand
- (8) During the measurements above 1GHz it is taken care of that the EUT is always within the 3dB cone of radiation BW of the used antenna.



Orthogonal Axis : X

TX 922MHz\_ 11G 10MHz (Above 1000 MHz, Vertical)

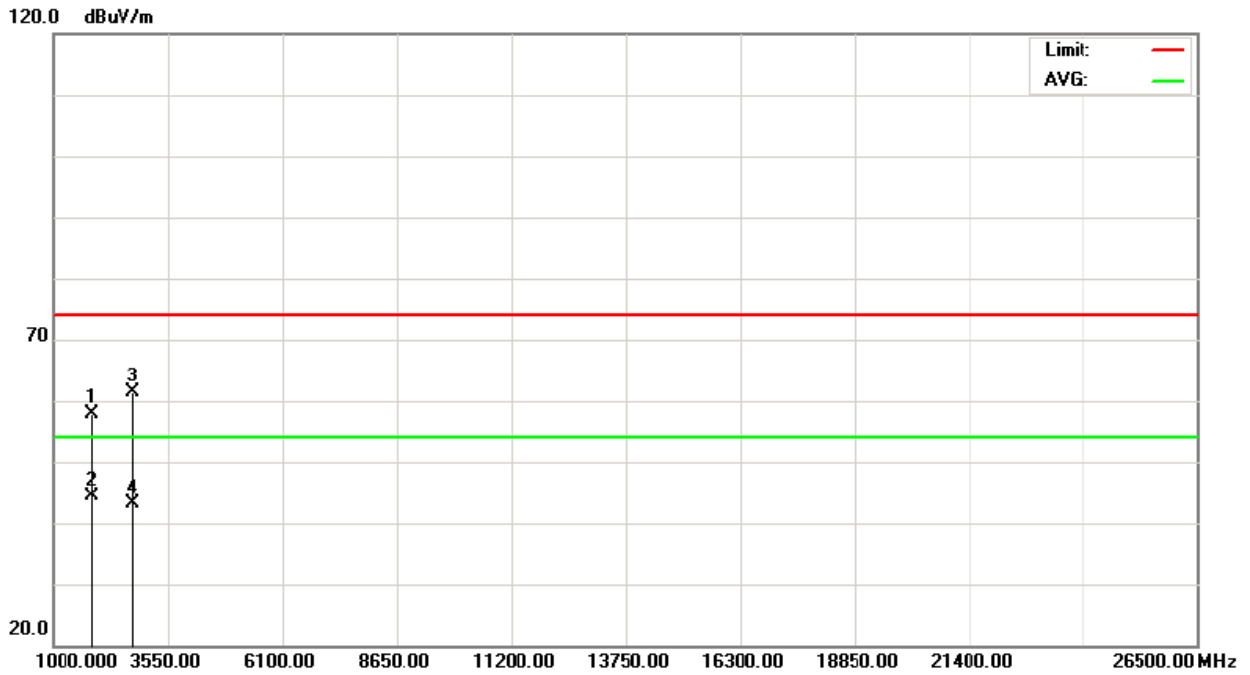

TX 922MHz\_ 11G 10MHz (Above 1000 MHz, Horizontal)

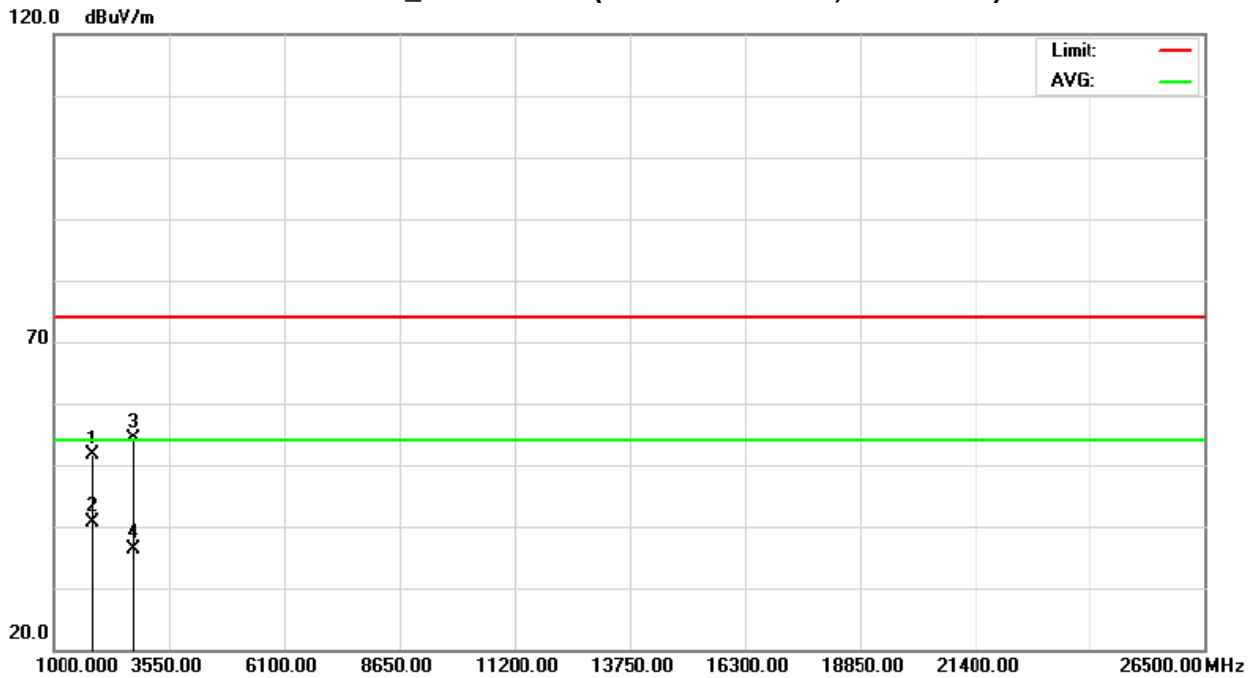



**5. BANDWIDTH TEST**

**5.1 APPLIED PROCEDURES / LIMIT**

FCC Part15, Subpart C			
Test Item	Limit	Frequency Range (MHz)	Result
Bandwidth	>= 500KHz (6dB bandwidth)	2400-2483.5	PASS

**5.1.1 MEASUREMENT INSTRUMENTS LIST**

Item	Kind of Equipment	Manufacturer	Type No.	Serial No.	Calibrated until
1	Spectrum Analyzer	R&S	FSP-40	100129	Sep. 10, 2010

Remark: " N/A" denotes No Model Name , Serial No. or No Calibration specified.

**5.1.2 TEST PROCEDURE**

- a. The EUT was directly connected to the spectrum analyzer and antenna output port as show in the block diagram below,
- b. Spectrum Setting : RBW= 100KHz, VBW=100KHz, Sweep time = Auto.

**5.1.3 DEVIATION FROM STANDARD**

No deviation.

**5.1.4 TEST SETUP**

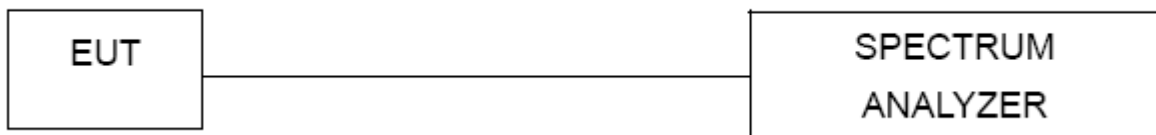

**5.1.5 EUT OPERATION CONDITIONS**

The EUT tested system was configured as the statements of 4.1.6 Unless otherwise a special operating condition is specified in the follows during the testing.  
Chip antenna measurement result.



**5.1.6 TEST RESULTS**

EUT :	mini-PCI radio Module	Model Name :	DLM108
Temperature :	26 ° C	Relative Humidity :	60%
Test Voltage :	AC 120V/60Hz		
Test Mode :	TX 907MHz/912MHz/917MHz/922MHz		

<b>Configuration (11B 20MHz)</b>				
Frequency (MHz)	Bandwidth (MHz)	99% Occupied Bandwidth (MHz)	LIMIT (MHz)	Test Result
912MHz	6.48	8.08	>=500KHz	Compliant
917MHz	5.76	7.56	>=500KHz	Compliant

<b>Configuration (11G 5MHz)</b>				
Frequency (MHz)	Bandwidth (MHz)	99% Occupied Bandwidth (MHz)	LIMIT (MHz)	Test Result
907MHz	4.12	4.32	>=500KHz	Compliant
912MHz	4.20	4.68	>=500KHz	Compliant
917MHz	4.08	4.40	>=500KHz	Compliant
922MHz	4.08	4.68	>=500KHz	Compliant

<b>Configuration (11G 10MHz)</b>				
Frequency (MHz)	Bandwidth (MHz)	99% Occupied Bandwidth (MHz)	LIMIT (MHz)	Test Result
907MHz	8.12	8.36	>=500KHz	Compliant
912MHz	8.24	9.80	>=500KHz	Compliant
917MHz	7.88	8.32	>=500KHz	Compliant
922MHz	5.44	8.56	>=500KHz	Compliant

<b>Configuration (11G 20MHz)</b>				
Frequency (MHz)	Bandwidth (MHz)	99% Occupied Bandwidth (MHz)	LIMIT (MHz)	Test Result
912MHz	16.40	16.72	>=500KHz	Compliant
917MHz	13.80	16.32	>=500KHz	Compliant





### Configuration (11B 20MHz) 912MHz



\*RBW 100 kHz Delta 1 [T1 ]  
 \*VBW 100 kHz 0.93 dB  
 Ref 21 dBm \*Att 30 dB SWT 5 ms 6.480000000 MHz

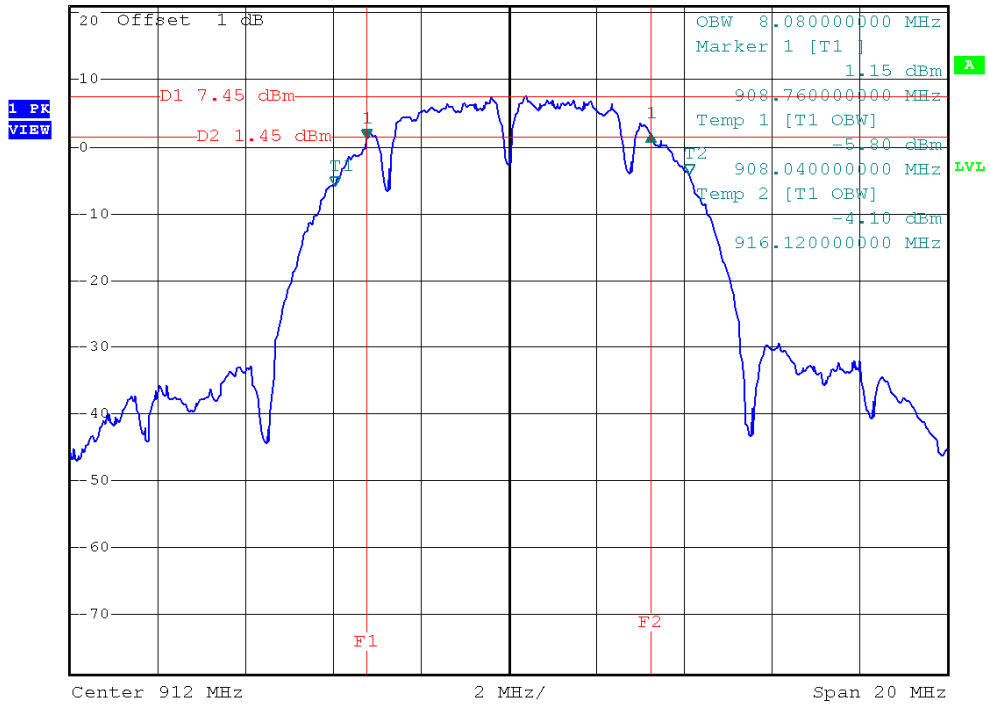

### 917MHz



\*RBW 100 kHz Delta 1 [T1 ]  
 \*VBW 100 kHz 1.10 dB  
 Ref 21 dBm \*Att 30 dB SWT 5 ms 5.760000000 MHz

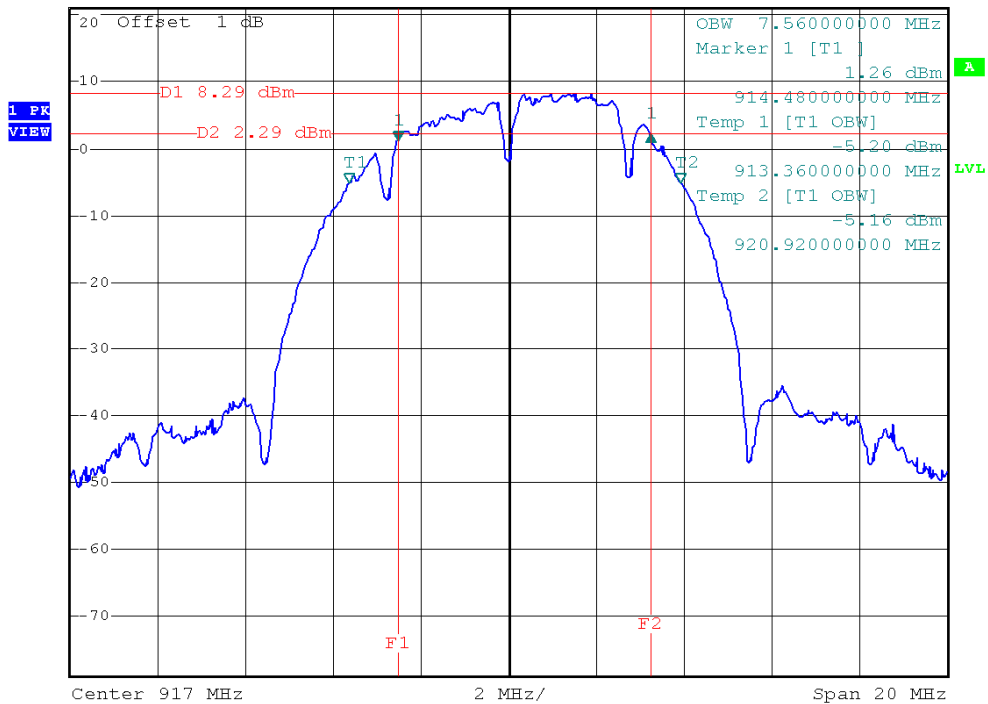



Configuration (11G 5MHz)  
907MHz

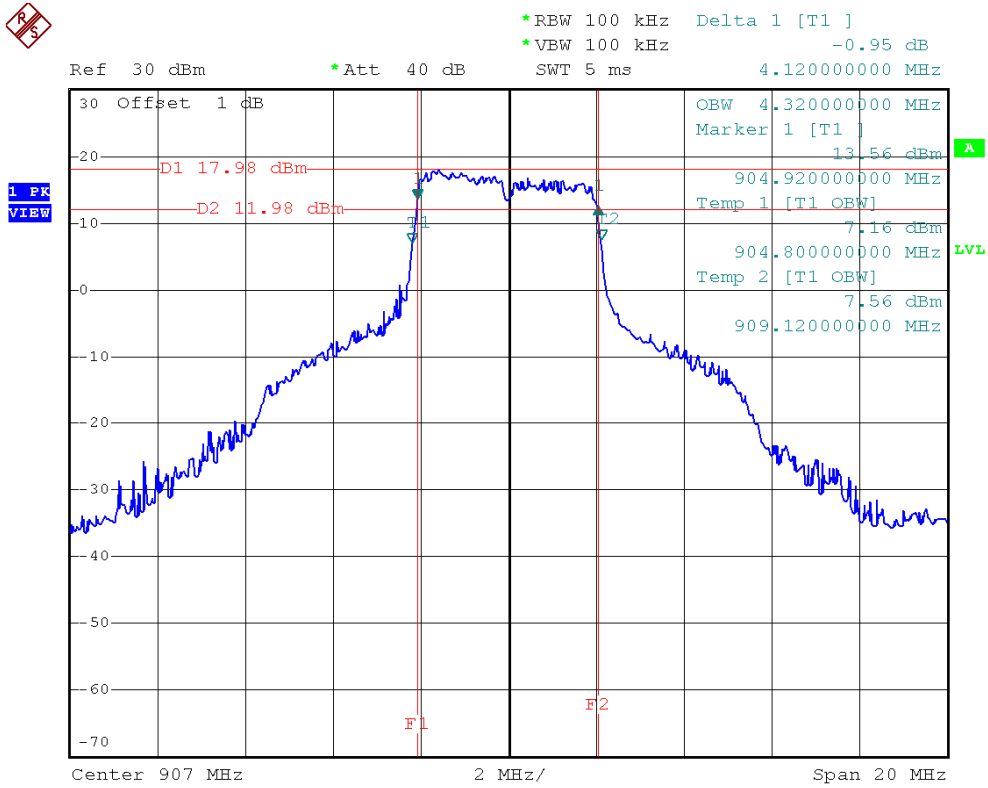

912MHz

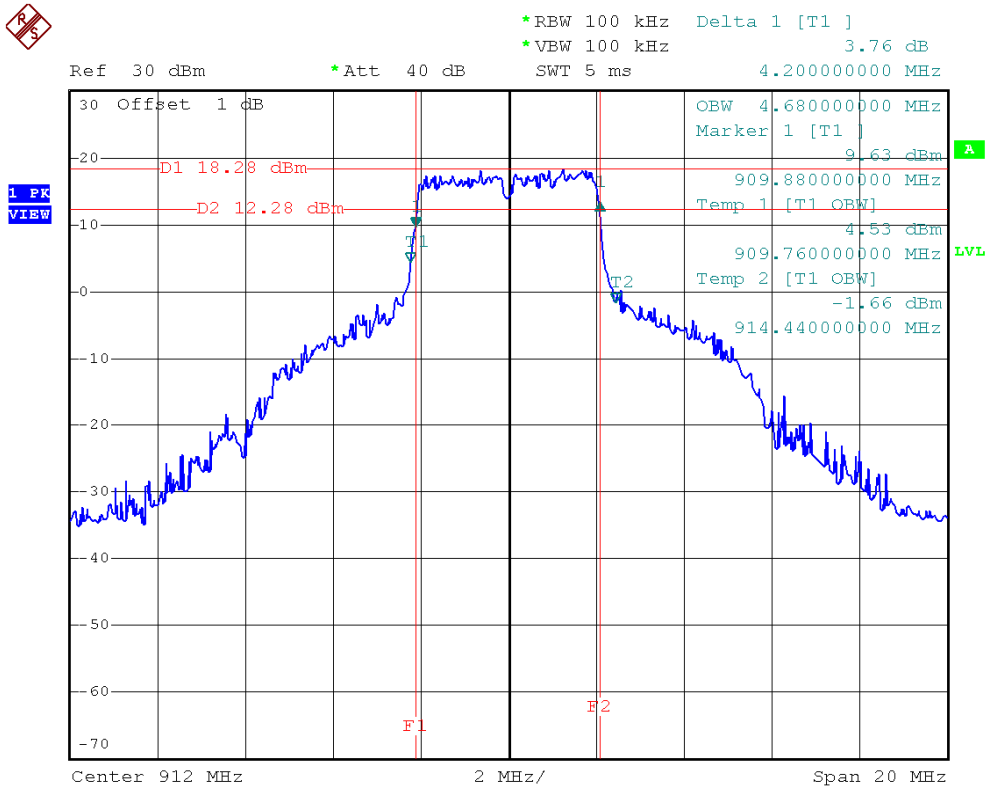



Configuration (5MHz)  
917MHz

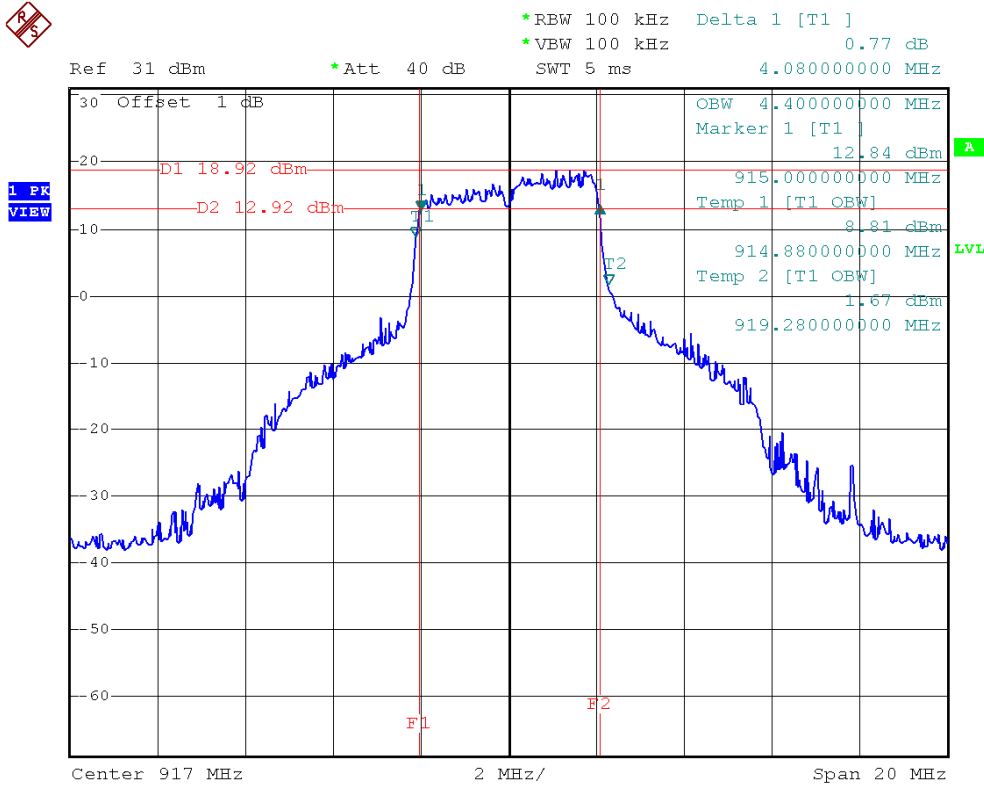

922MHz

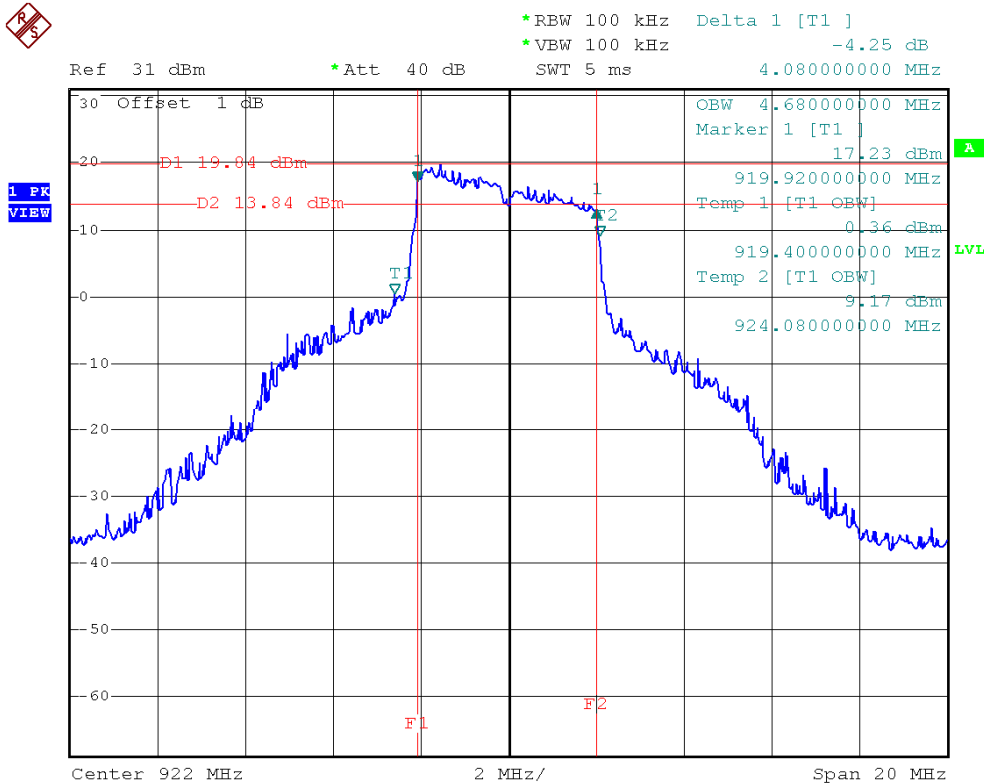



### Configuration (11G 10MHz)

#### 907MHz

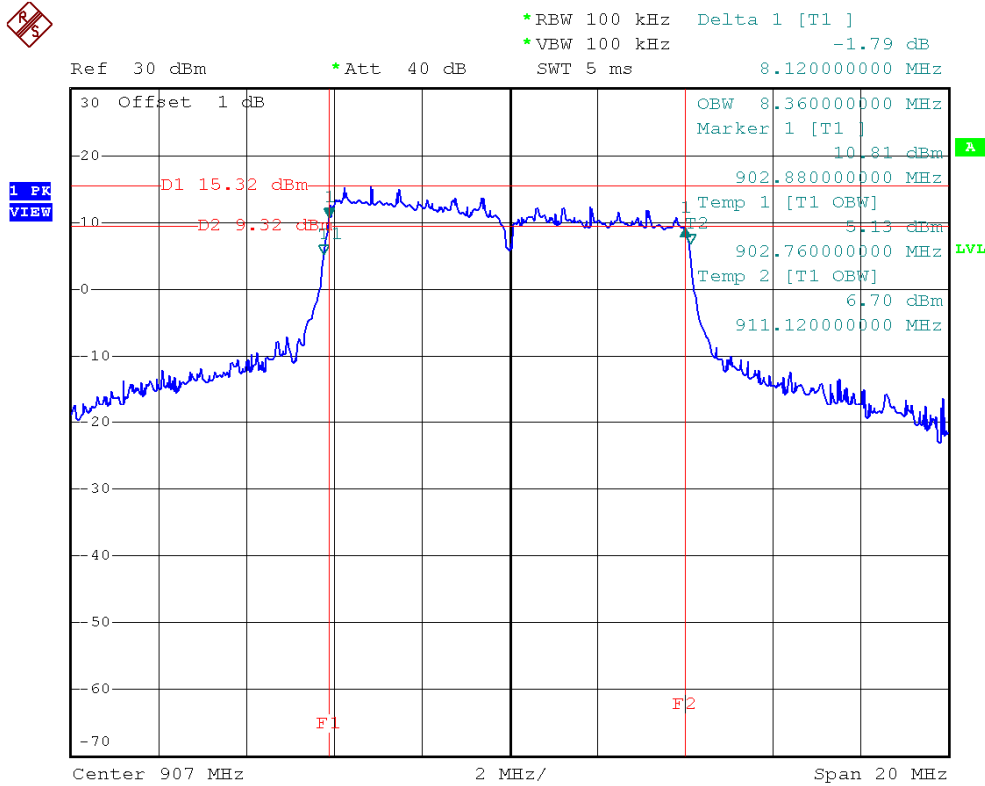

#### 912MHz

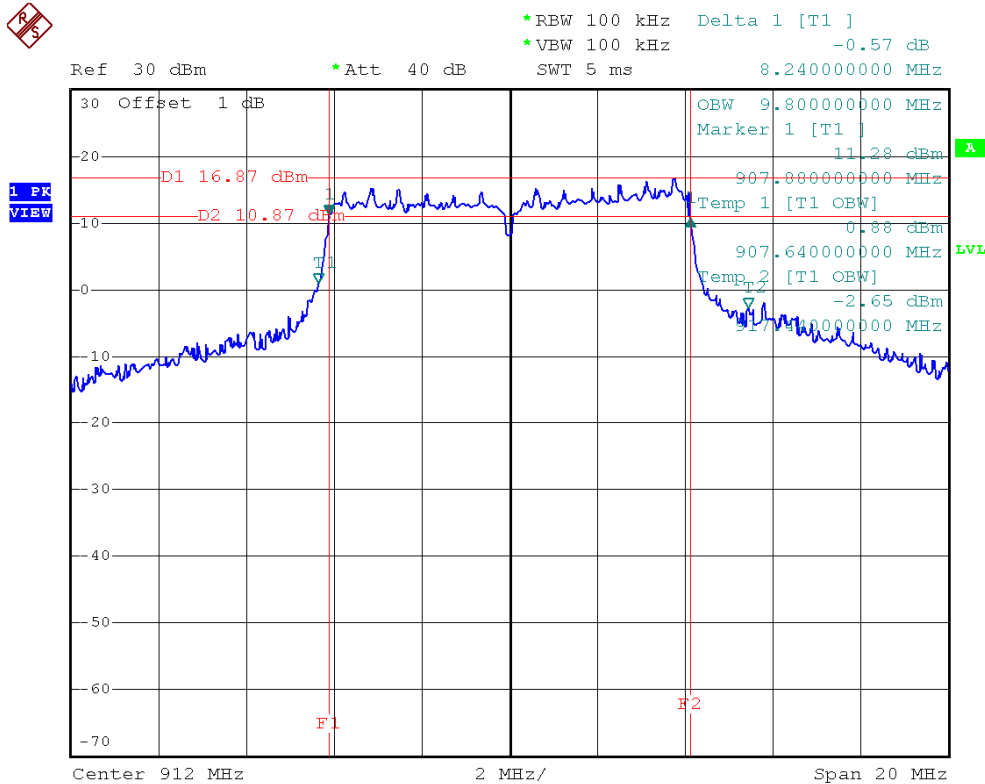



Configuration (11G 10MHz)

917MHz

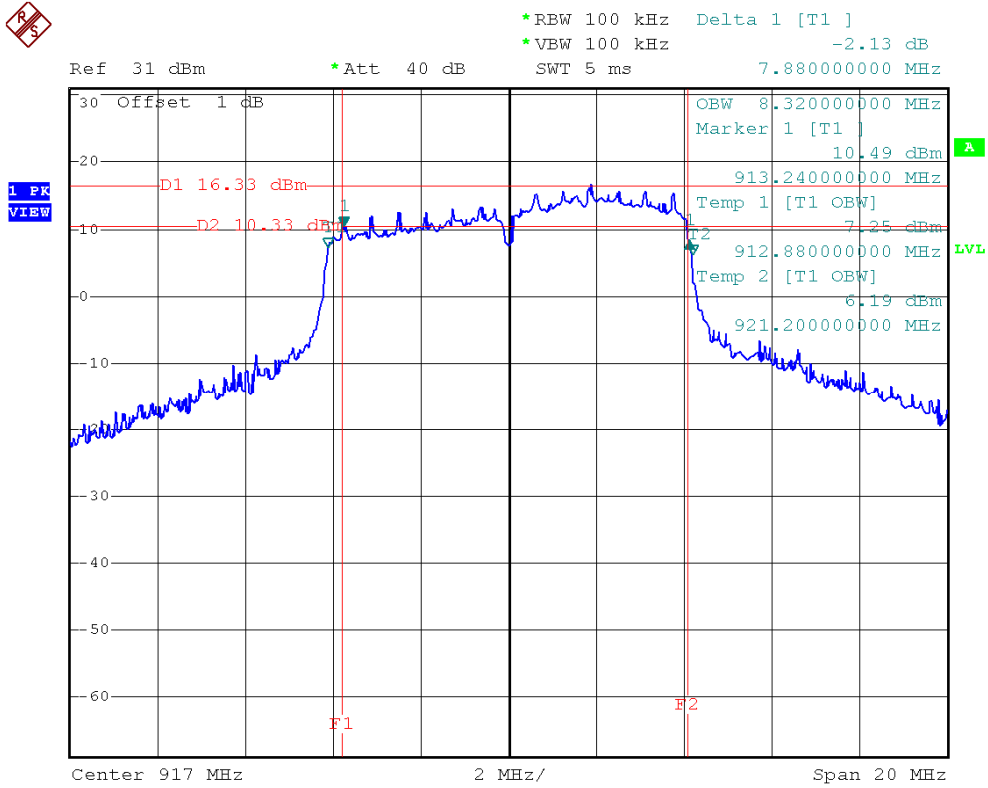

922MHz

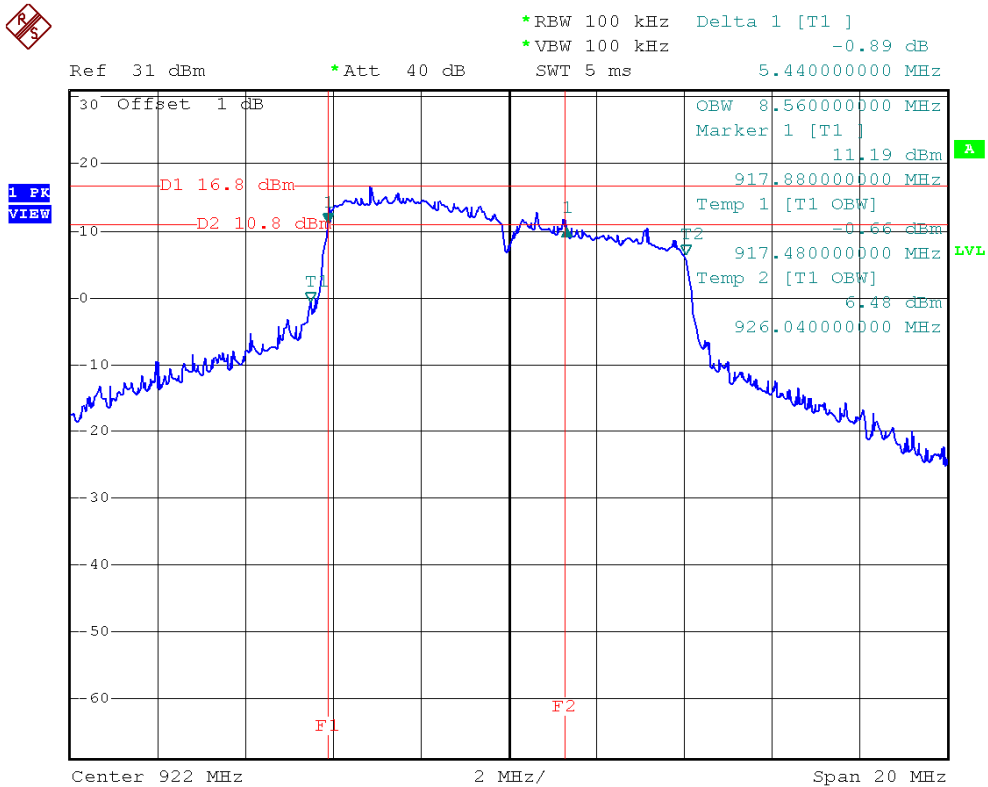



Configuration (11G 20MHz)

912MHz

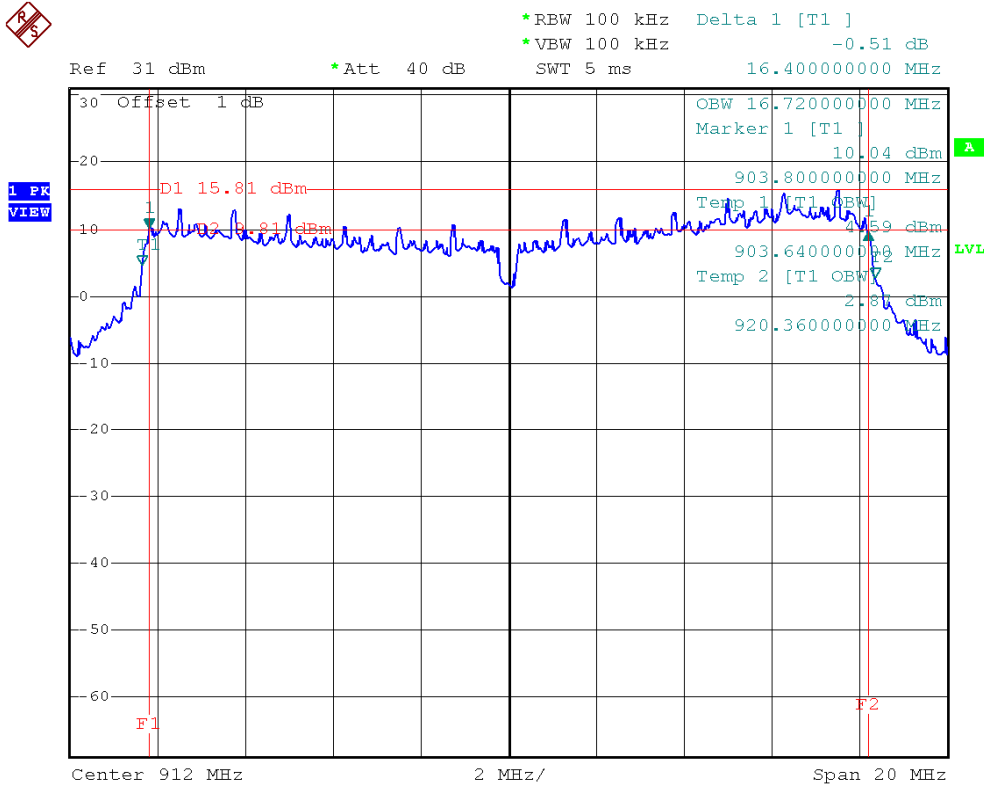

917MHz

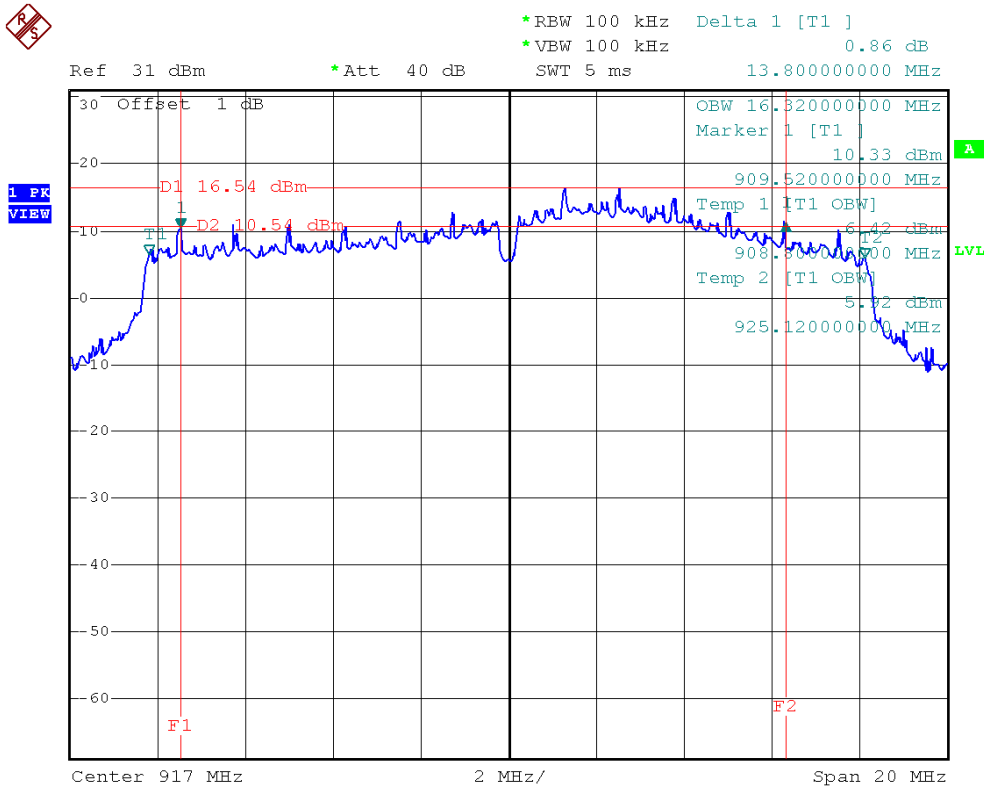



**6. PEAK OUTPUT POWER TEST**

**6.1 APPLIED PROCEDURES / LIMIT**

FCC Part15, Subpart C			
Test Item	Limit	Frequency Range (MHz)	Result
Peak Output Power	1 watt or 30dBm	2400-2483.5	PASS

**6.1.1 MEASUREMENT INSTRUMENTS LIST**

Item	Kind of Equipment	Manufacturer	Type No.	Serial No.	Calibrated until
1	Power Meter	Anritsu	ML2487A	6K00004714	Feb. 10, 2011
2	Power Meter Sensor	Anritsu	MA2491A	34138	Feb. 10, 2011

Remark: " N/A" denotes No Model Name , Serial No. or No Calibration specified.

**6.1.2 TEST PROCEDURE**

- a. The EUT was directly connected to the power meter and antenna output port as show in the block diagram below,

**6.1.3 DEVIATION FROM STANDARD**

No deviation.

**6.1.4 TEST SETUP**



**6.1.5 EUT OPERATION CONDITIONS**

The EUT tested system was configured as the statements of 4.1.6 Unless otherwise a special operating condition is specified in the follows during the testing.  
Omni Directional antenna measurement result.



**6.1.6 TEST RESULTS**

EUT :	mini-PCI radio Module	Model Name :	DLM108
Temperature :	26 °C	Relative Humidity :	60%
Test Voltage :	AC 120V/60Hz		
Test Mode :	TX 907MHz/912MHz/917MHz/922MHz		

<b>Configuration (11B 20MHz)</b>				
Frequency (MHz)	Peak Output Power (dBm)	LIMIT (dBm)	LIMIT (W)	Test Result
912MHz	21.62	30	1	Compliant
917MHz	20.21	30	1	Compliant

<b>Configuration (11G 5MHz)</b>				
Frequency (MHz)	Peak Output Power (dBm)	LIMIT (dBm)	LIMIT (W)	Test Result
907MHz	29.63	30	1	Compliant
912MHz	29.67	30	1	Compliant
917MHz	29.64	30	1	Compliant
922MHz	29.65	30	1	Compliant

<b>Configuration (11G 10MHz)</b>				
Frequency (MHz)	Peak Output Power (dBm)	LIMIT (dBm)	LIMIT (W)	Test Result
907MHz	29.66	30	1	Compliant
912MHz	29.65	30	1	Compliant
917MHz	29.63	30	1	Compliant
922MHz	29.63	30	1	Compliant

<b>Configuration (11G 20MHz)</b>				
Frequency (MHz)	Peak Output Power (dBm)	LIMIT (dBm)	LIMIT (W)	Test Result
912MHz	29.66	30	1	Compliant
917MHz	29.66	30	1	Compliant





**7. ANTENNA CONDUCTED SPURIOUS EMISSION**

**7.1 APPLIED PROCEDURES / LIMIT**

FCC Part15, Subpart C			
Test Item	Limit	Frequency Range (MHz)	Result
Antenna conducted Spurious Emission	20dB less than the peak value of fundamental frequency	30-25000	PASS

**7.1.1 MEASUREMENT INSTRUMENTS LIST**

Item	Kind of Equipment	Manufacturer	Type No.	Serial No.	Calibrated until
1	Spectrum Analyzer	R&S	FSP-40	100129	Sep. 10, 2010

Remark: " N/A" denotes No Model Name , Serial No. or No Calibration specified.

**7.1.2 TEST PROCEDURE**

- a. The EUT was directly connected to the spectrum analyzer and antenna output port as show in the block diagram below,
- b. Spectrum Setting : RBW= 100KHz, VBW=100KHz, Sweep time = Auto.

**7.1.3 DEVIATION FROM STANDARD**

No deviation.

**7.1.4 TEST SETUP**



**7.1.5 EUT OPERATION CONDITIONS**

The EUT tested system was configured as the statements of 4.1.6 Unless otherwise a special operating condition is specified in the follows during the testing.  
Omni Directional antenna measurement result.



**7.1.6 TEST RESULTS**

EUT :	mini-PCI radio Module	Model Name :	DLM108
Temperature :	26 °C	Relative Humidity :	60%
Test Voltage :	AC 120V/60Hz		
Test Mode :	TX 907MHz/912MHz/917MHz/922MHz		

**Configuration (11B 20MHz)**

**912MHz**

**AVERAGE-LO**

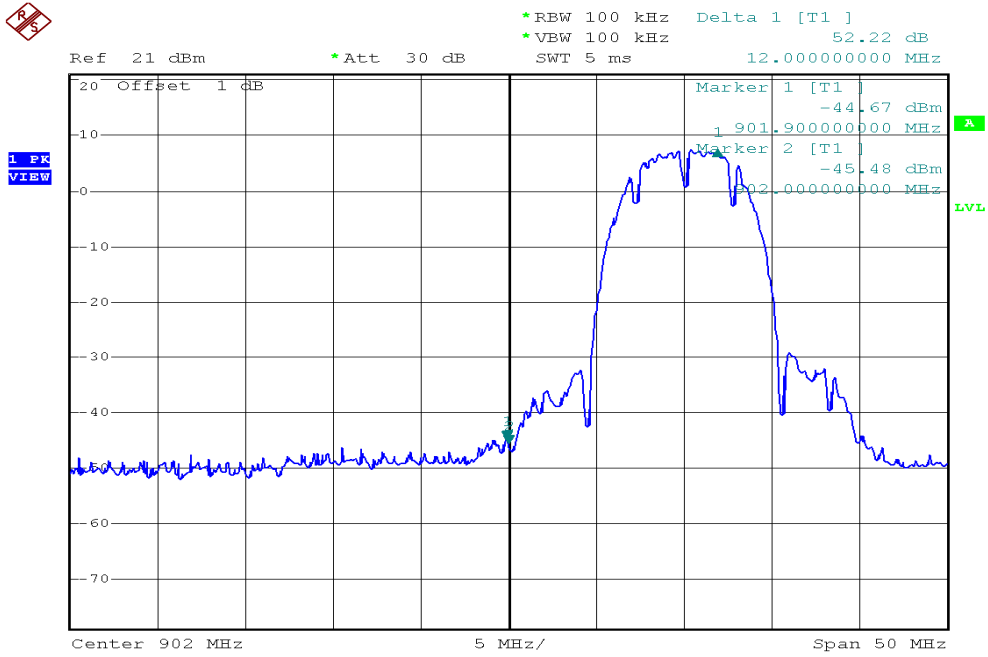

**CONDUCTED EMISSION**

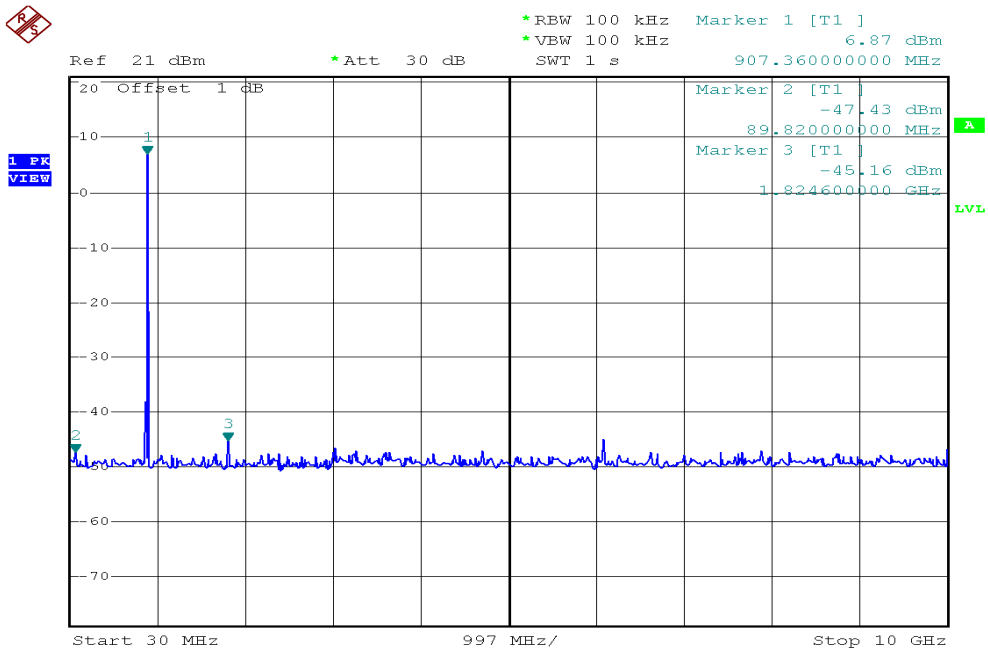



### Configuration (11B 20MHz)

917MHz

### AVERAGE-UP



\*RBW 100 kHz Delta 1 [T1 ]  
 \*VBW 100 kHz 55.49 dB  
 Ref 21 dBm \*Att 30 dB SWT 5 ms -12.500000000 MHz

1 PK VIEW

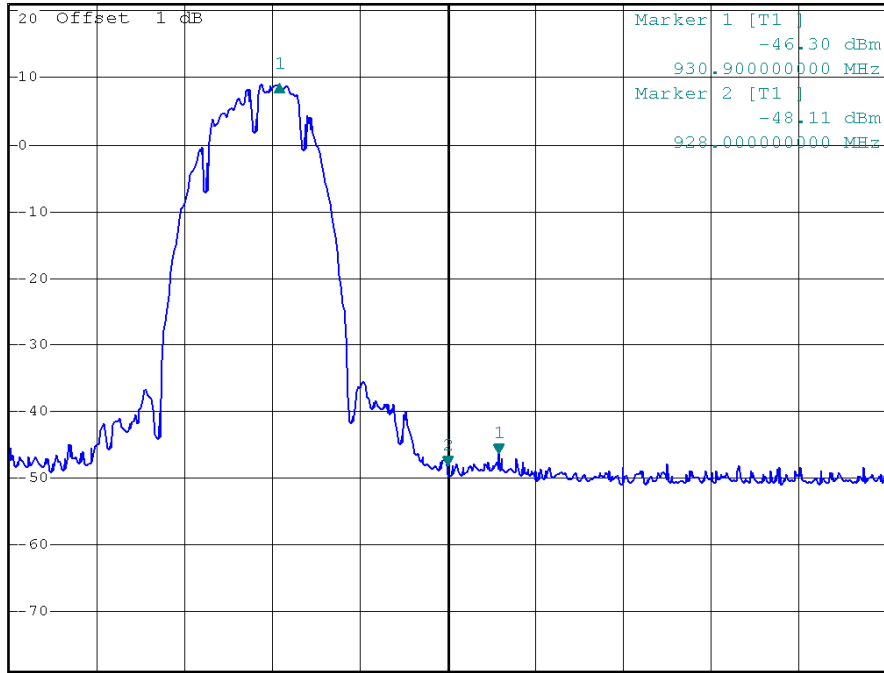

Center 928 MHz 5 MHz/ Span 50 MHz

### CONDUCTED EMISSION



\*RBW 100 kHz Marker 1 [T1 ]  
 \*VBW 100 kHz 8.36 dBm  
 Ref 21 dBm \*Att 30 dB SWT 1 s 907.360000000 MHz

1 PK VIEW

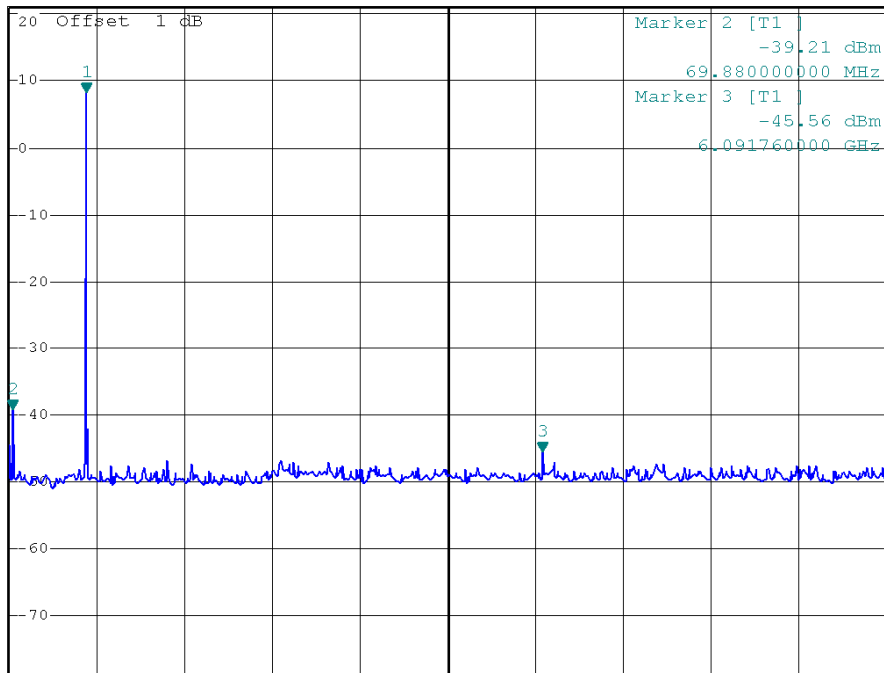

Start 30 MHz 997 MHz/ Stop 10 GHz



### Configuration (5MHz)

907MHz

### AVERAGE-LO



\*RBW 100 kHz Delta 1 [T1 ]  
\*VBW 100 kHz 30.80 dB  
SWT 5 ms 3.300000000 MHz

Ref 30 dBm

\*Att 40 dB

1 PK  
VIEW

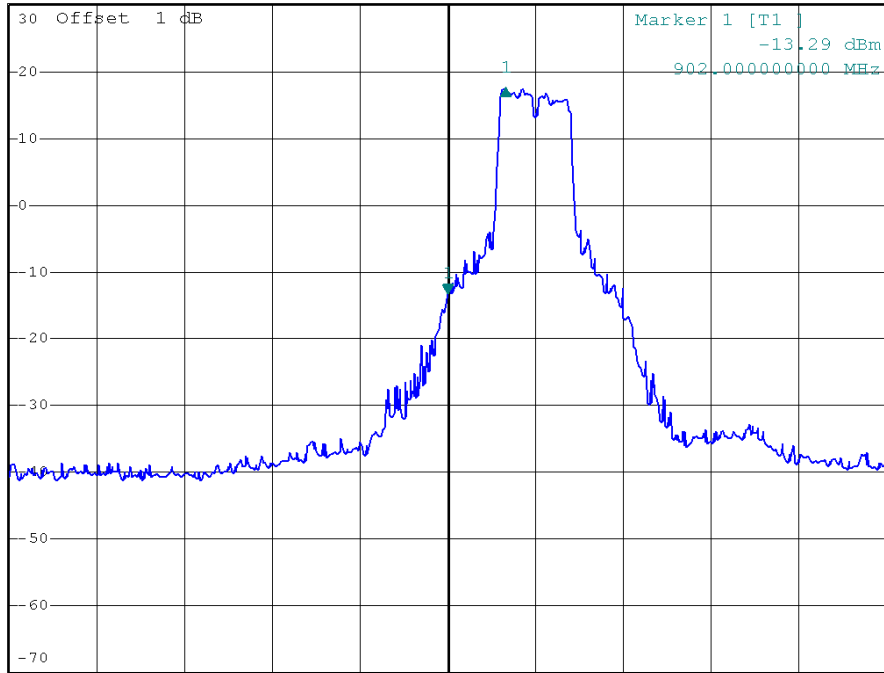

Center 902 MHz 5 MHz/ Span 50 MHz

### CONDUCTED EMISSION



\*RBW 100 kHz Marker 1 [T1 ]  
\*VBW 100 kHz 17.41 dBm  
SWT 1 s 907.360000000 MHz

Ref 30 dBm

\*Att 40 dB

1 PK  
VIEW

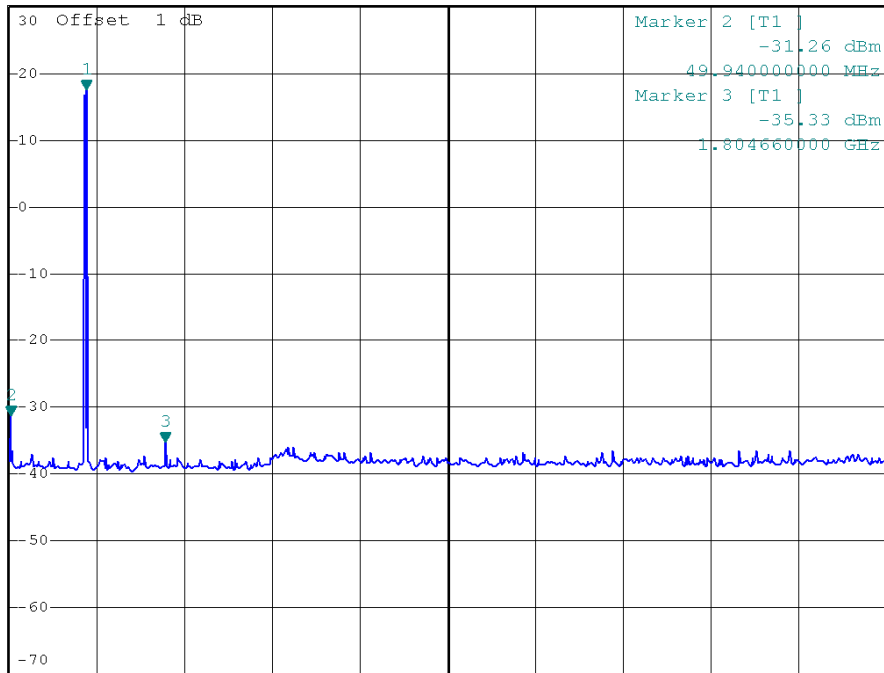

Start 30 MHz 997 MHz/ Stop 10 GHz



### Configuration (5MHz)

912MHz

### AVERAGE-LO



\*RBW 100 kHz Delta 1 [T1 ]  
\*VBW 100 kHz 50.81 dB  
SWT 5 ms 11.10000000 MHz

Ref 31 dBm

\*Att 40 dB

1 PK  
VIEW

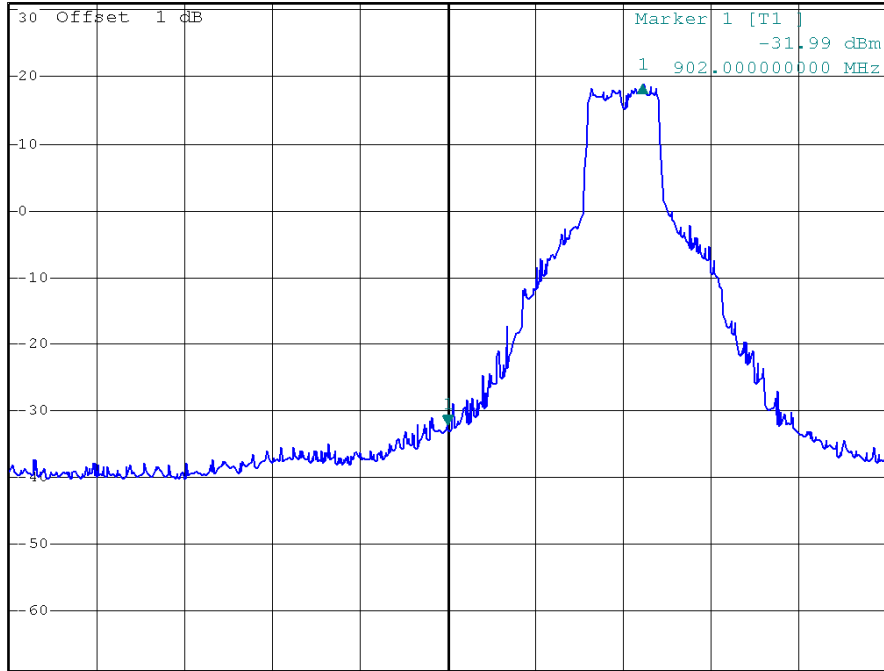

Center 902 MHz

5 MHz/

Span 50 MHz

### CONDUCTED EMISSION



\*RBW 100 kHz Marker 3 [T1 ]  
\*VBW 100 kHz -35.29 dBm  
SWT 1 s 1.82460000 GHz

Ref 31 dBm

\*Att 40 dB

1 PK  
VIEW

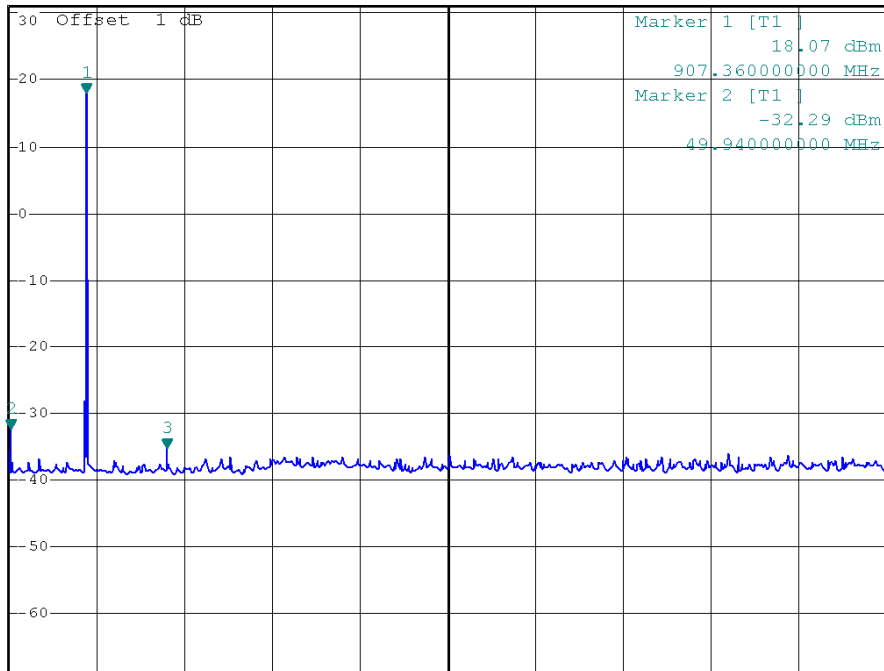

Start 30 MHz

997 MHz/

Stop 10 GHz



### Configuration (5MHz)

917MHz

### AVERAGE-UP



\*RBW 100 kHz Delta 1 [T1 ]  
\*VBW 100 kHz 56.16 dB  
SWT 5 ms -9.600000000 MHz

Ref 31 dBm

\*Att 40 dB

1 PK  
VIEW



Center 928 MHz

5 MHz/

Span 50 MHz

### CONDUCTED EMISSION



\*RBW 100 kHz Marker 1 [T1 ]  
\*VBW 100 kHz 18.31 dBm  
SWT 1 s 907.360000000 MHz

Ref 31 dBm

\*Att 40 dB

1 PK  
VIEW

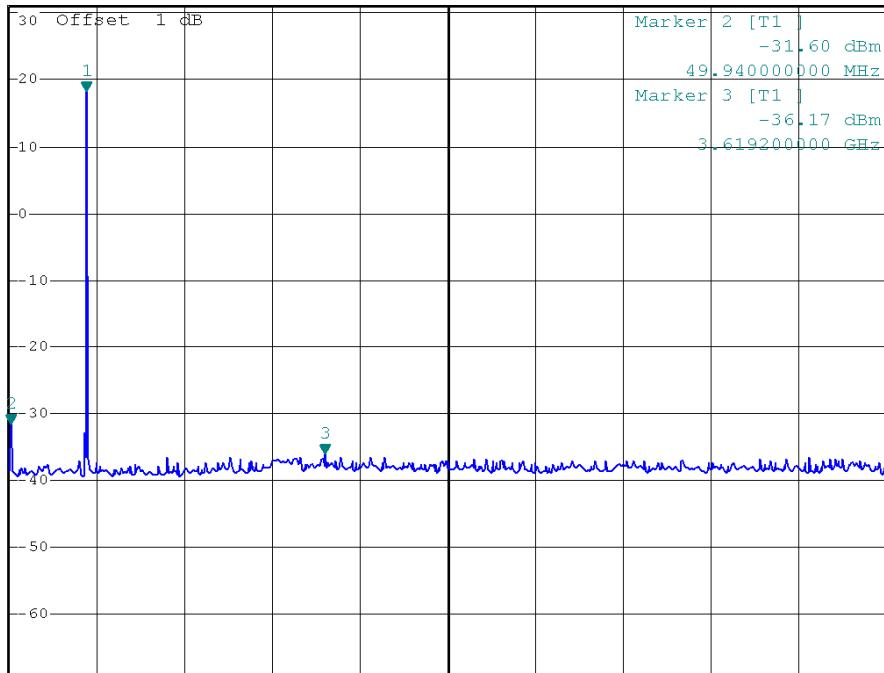

Start 30 MHz

997 MHz/

Stop 10 GHz



### Configuration (5MHz)

922MHz

AVERAGE-UP



\*RBW 100 kHz Delta 1 [T1 ]  
\*VBW 100 kHz 45.84 dB  
SWT 5 ms -7.900000000 MHz

Ref 31 dBm

\*Att 40 dB



Center 928 MHz

5 MHz/

Span 50 MHz

### CONDUCTED EMISSION



\*RBW 100 kHz Marker 3 [T1 ]  
\*VBW 100 kHz -36.11 dBm  
SWT 1 s 1.844540000 GHz

Ref 31 dBm

\*Att 40 dB

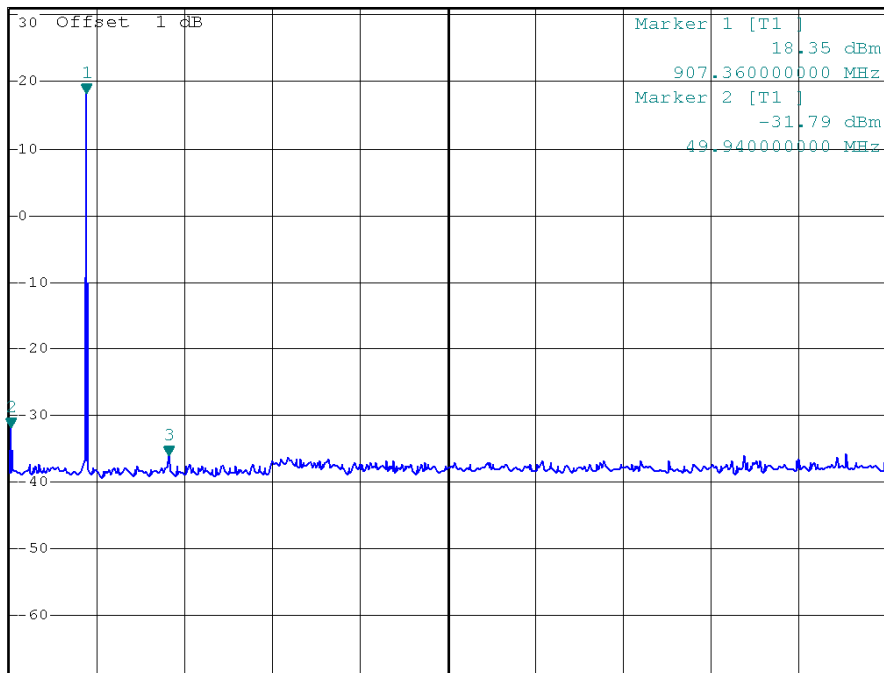

Start 30 MHz

997 MHz/

Stop 10 GHz



### Configuration (11G 10MHz)

907MHz

AVERAGE-LO



\*RBW 100 kHz Delta 1 [T1 ]  
\*VBW 100 kHz 25.47 dB  
SWT 5 ms 1.300000000 MHz

Ref 30 dBm

\*Att 40 dB

1 PK  
VIEW

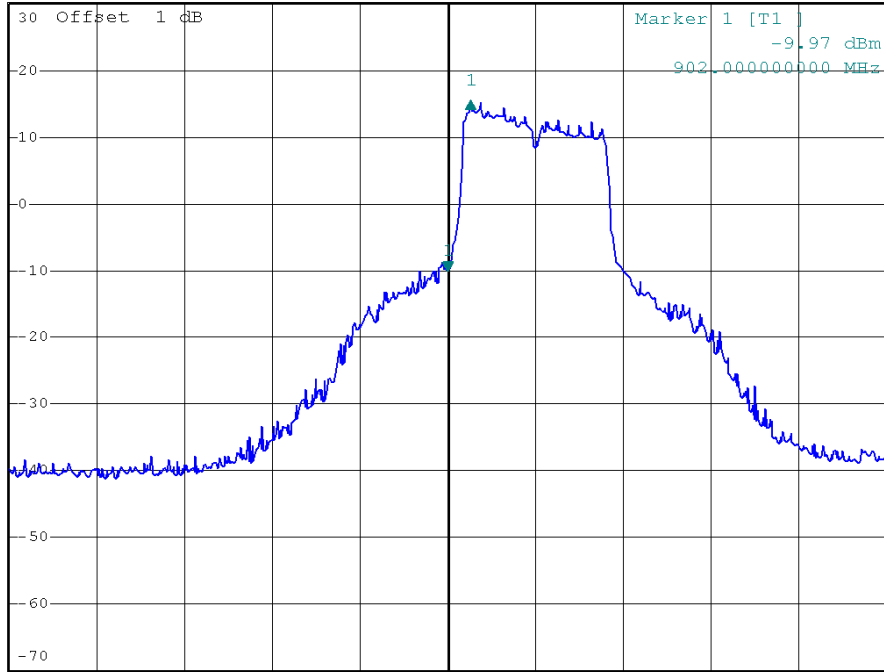

Center 902 MHz

5 MHz/

Span 50 MHz

### CONDUCTED EMISSION



\*RBW 100 kHz Marker 1 [T1 ]  
\*VBW 100 kHz 12.19 dBm  
SWT 1 s 907.360000000 MHz

Ref 30 dBm

\*Att 40 dB

1 PK  
VIEW

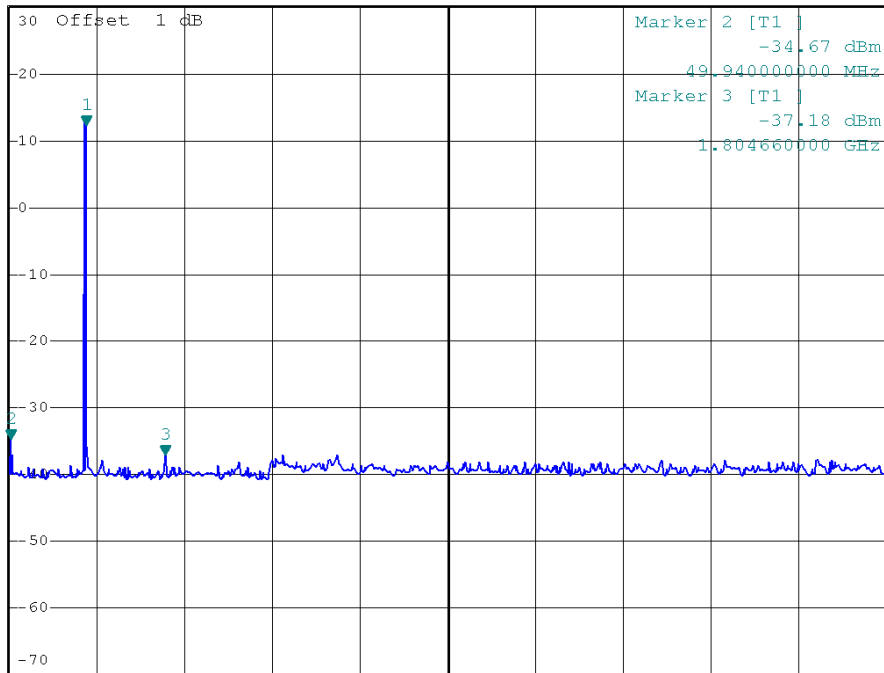

Start 30 MHz

997 MHz/

Stop 10 GHz





### Configuration (11G 10MHz)

912MHz

### AVERAGE-LO



\*RBW 100 kHz Delta 1 [T1 ]  
\*VBW 100 kHz 31.85 dB  
SWT 5 ms 13.800000000 MHz

Ref 31 dBm

\*Att 40 dB

1 PK  
VIEW



Center 902 MHz 5 MHz/ Span 50 MHz

### CONDUCTED EMISSION



\*RBW 100 kHz Marker 1 [T1 ]  
\*VBW 100 kHz 15.96 dBm  
SWT 1 s 907.360000000 MHz

Ref 31 dBm

\*Att 40 dB

1 PK  
VIEW

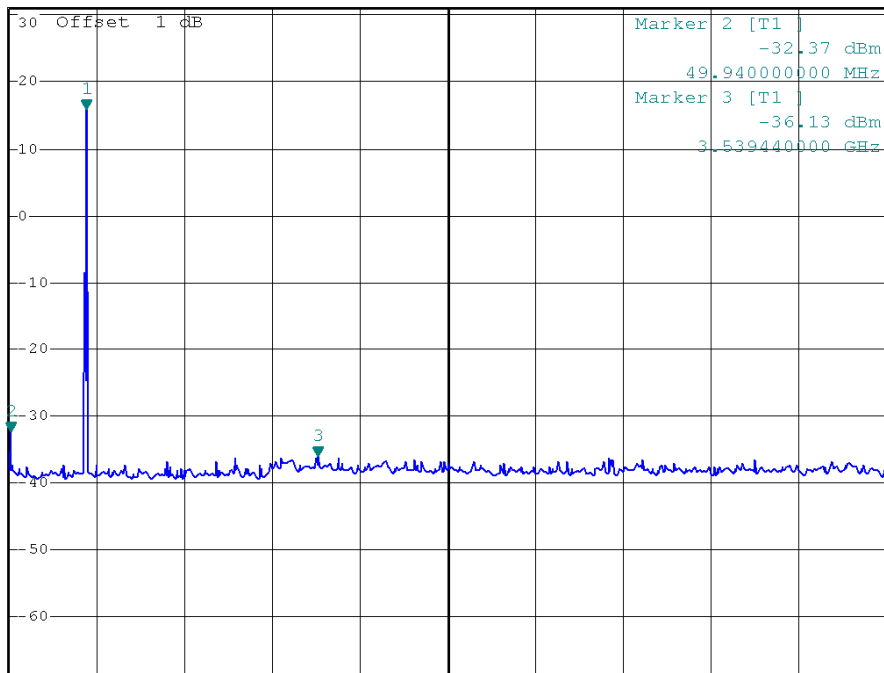

Start 30 MHz 997 MHz/ Stop 10 GHz



### Configuration (11G 10MHz)

917MHz

### AVERAGE-UP



\*RBW 100 kHz Delta 1 [T1 ]  
\*VBW 100 kHz 38.76 dB  
SWT 5 ms -8.500000000 MHz

Ref 31 dBm

\*Att 40 dB

1 PK  
VIEW

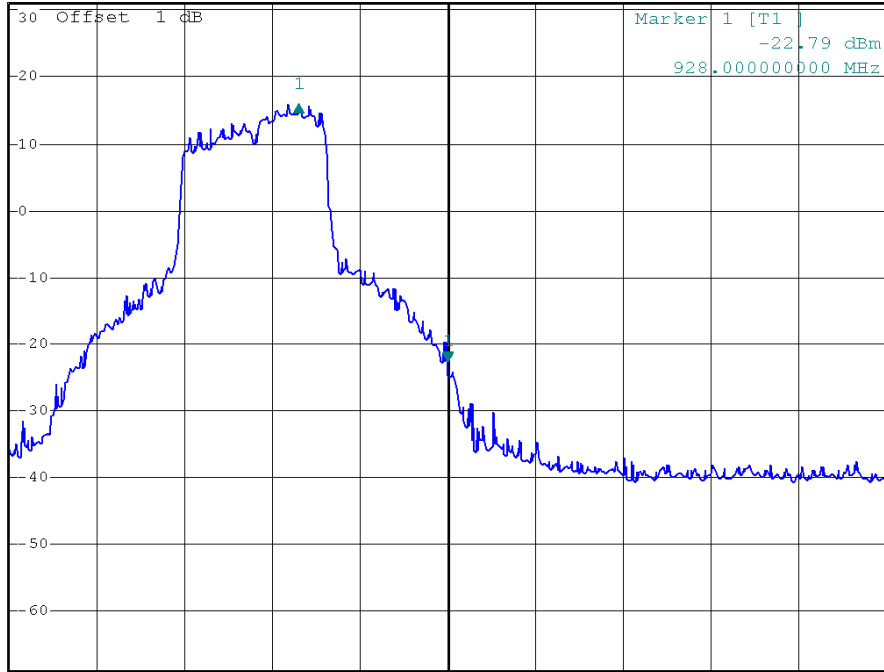

Center 928 MHz

5 MHz/

Span 50 MHz

### CONDUCTED EMISSION



\*RBW 100 kHz Marker 1 [T1 ]  
\*VBW 100 kHz 14.18 dBm  
SWT 1 s 907.360000000 MHz

Ref 31 dBm

\*Att 40 dB

1 PK  
VIEW

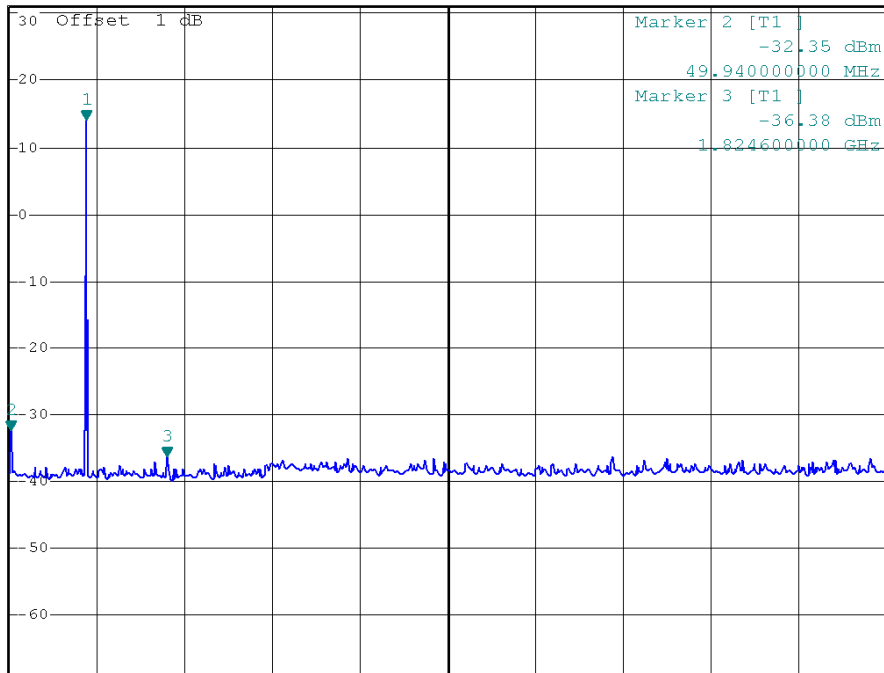

Start 30 MHz

997 MHz/

Stop 10 GHz



### Configuration (11G 10MHz)

922MHz

AVERAGE-UP



\*RBW 100 kHz Delta 1 [T1 ]  
 \*VBW 100 kHz 30.08 dB  
 \*Att 40 dB  
 SWT 5 ms -9.100000000 MHz

Ref 31 dBm

1 PK  
VIEW



Center 928 MHz 5 MHz/ Span 50 MHz

### CONDUCTED EMISSION



\*RBW 100 kHz Marker 1 [T1 ]  
 \*VBW 100 kHz 15.36 dBm  
 \*Att 40 dB  
 SWT 1 s 907.360000000 MHz

Ref 31 dBm

1 PK  
VIEW

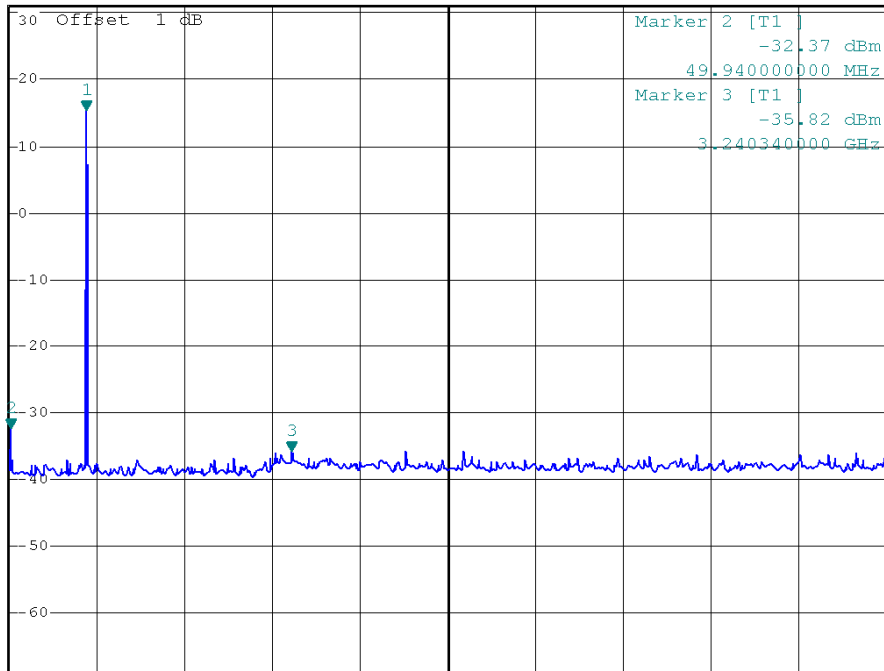

Start 30 MHz 997 MHz/ Stop 10 GHz



### Configuration (11G 20MHz)

912MHz

### AVERAGE-LO



\*RBW 100 kHz Delta 1 [T1 ]  
\*VBW 100 kHz 23.01 dB  
SWT 5 ms 17.500000000 MHz

Ref 31 dBm

\*Att 40 dB

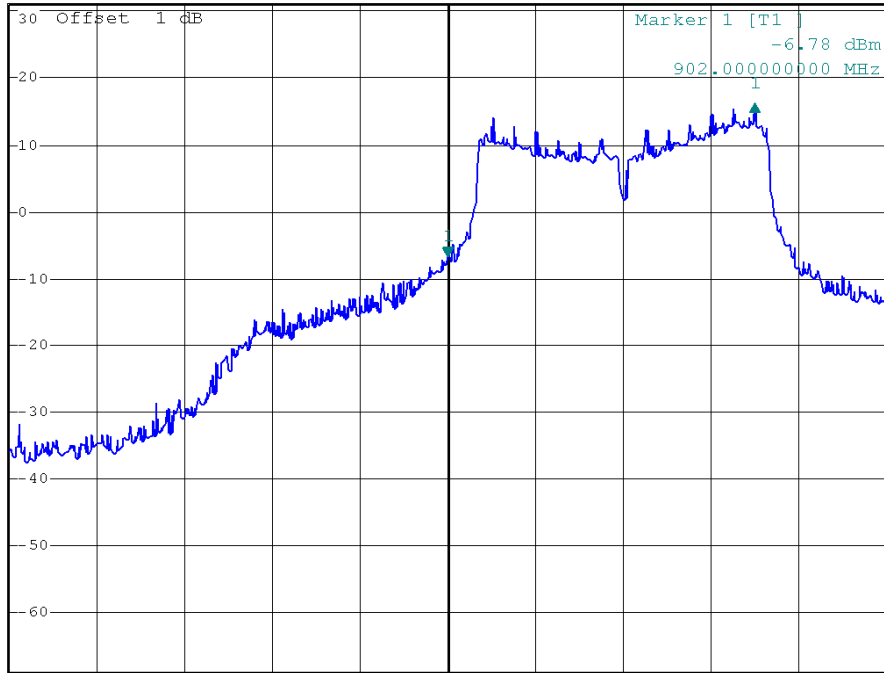

Center 902 MHz 5 MHz/ Span 50 MHz

### CONDUCTED EMISSION



\*RBW 100 kHz Marker 1 [T1 ]  
\*VBW 100 kHz 13.05 dBm  
SWT 1 s 907.360000000 MHz

Ref 31 dBm

\*Att 40 dB

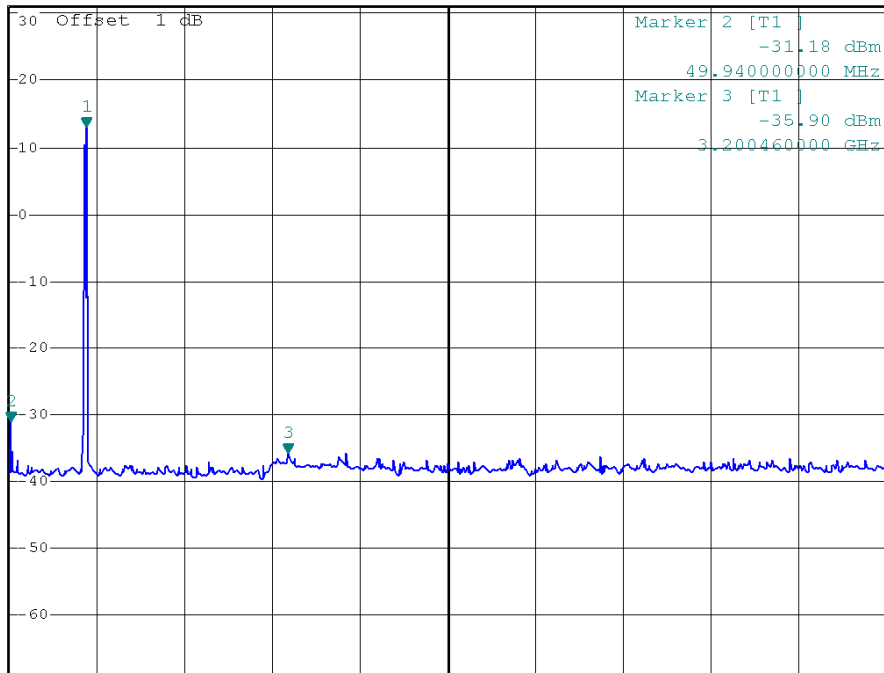

Start 30 MHz 997 MHz/ Stop 10 GHz



### Configuration IEEE 802.11g(11G 20MHz)

917MHz

AVERAGE-UP



\*RBW 100 kHz Delta 1 [T1 ]  
\*VBW 100 kHz 28.33 dB  
SWT 5 ms -9.700000000 MHz

Ref 31 dBm

\*Att 40 dB

1 PK  
VIEW

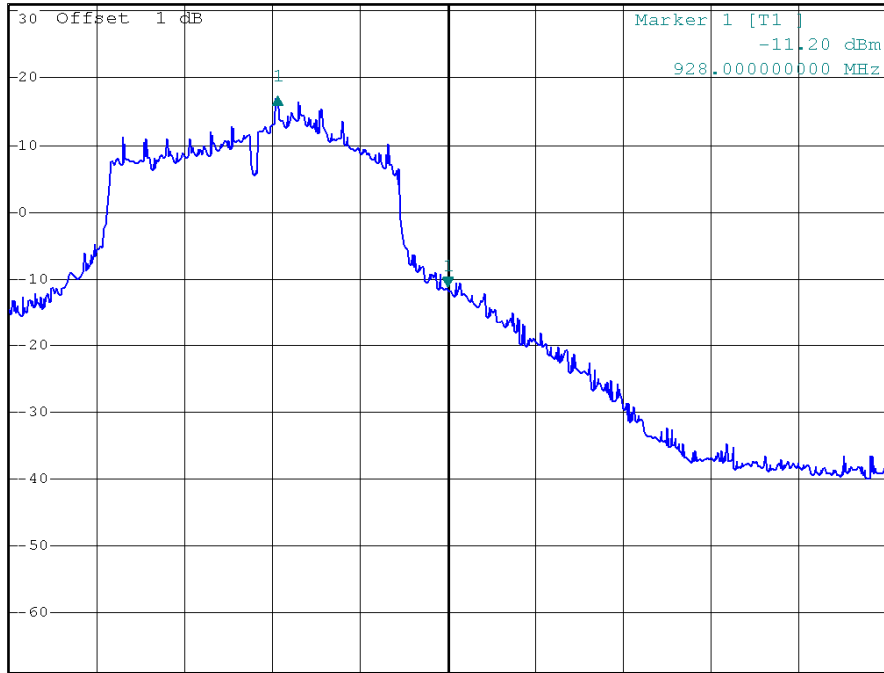

Center 928 MHz

5 MHz/

Span 50 MHz

### CONDUCTED EMISSION



\*RBW 100 kHz Marker 1 [T1 ]  
\*VBW 100 kHz 14.41 dBm  
SWT 1 s 907.360000000 MHz

Ref 31 dBm

\*Att 40 dB

1 PK  
VIEW

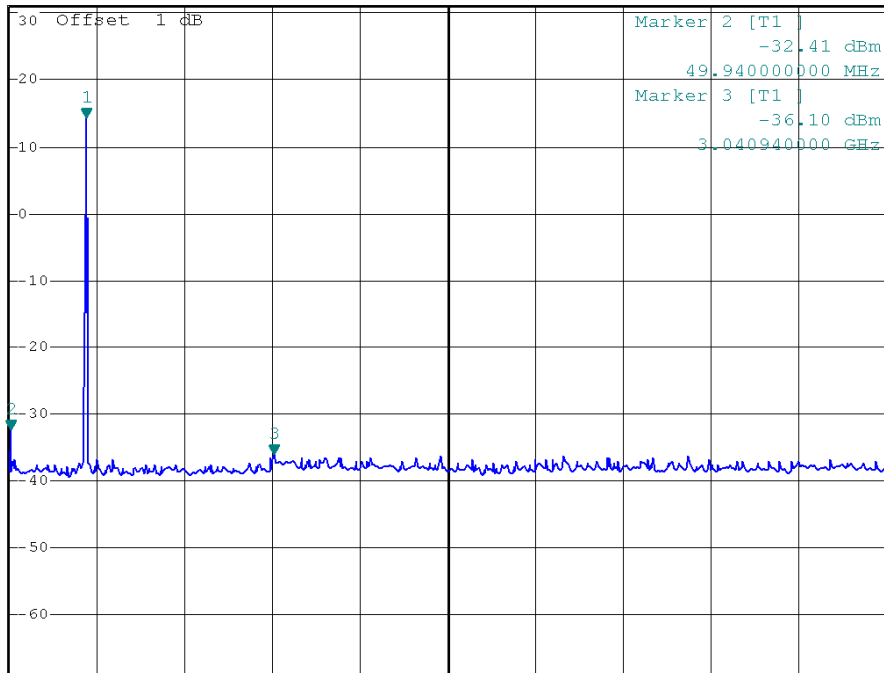

Start 30 MHz

997 MHz/

Stop 10 GHz



**8. POWER SPECTRAL DENSITY TEST**

**8.1 APPLIED PROCEDURES / LIMIT**

FCC Part15, Subpart C			
Test Item	Limit	Frequency Range (MHz)	Result
Power Spectral Density	8 dBm (in any 3KHz)	2400-2483.5	PASS

**8.1.1 MEASUREMENT INSTRUMENTS LIST**

Item	Kind of Equipment	Manufacturer	Type No.	Serial No.	Calibrated until
1	Spectrum Analyzer	R&S	FSP-40	100129	Sep. 10, 2010

Remark: " N/A" denotes No Model Name, Serial No. or No Calibration specified.

**8.1.2 TEST PROCEDURE**

- a. The EUT was directly connected to the spectrum analyzer and antenna output port as show in the block diagram below,
- b. Spectrum Setting : RBW=3KHz, VBW=30KHz, Sweep time = 500s.

**8.1.3 DEVIATION FROM STANDARD**

No deviation.

**8.1.4 TEST SETUP**



**8.1.5 EUT OPERATION CONDITIONS**

The EUT tested system was configured as the statements of 4.1.6 Unless otherwise a special operating condition is specified in the follows during the testing.  
Omni Directional antenna measurement result.



**8.1.6 TEST RESULTS**

EUT :	mini-PCI radio Module	Model Name :	DLM108
Temperature :	26 ° C	Relative Humidity :	60%
Test Voltage :	AC 120V/60Hz		
Test Mode :	TX 907MHz/912MHz/917MHz/922MHz		

<b>Configuration (11B 20MHz)</b>			
Frequency (MHz)	Power Density (dBm)	LIMIT (dBm)	Test Result
912MHz	-4.28	8	Compliant
917MHz	-4.82	8	Compliant

<b>Configuration (11G 5MHz)</b>			
Frequency (MHz)	Power Density (dBm)	LIMIT (dBm)	Test Result
907MHz	6.80	8	Compliant
912MHz	7.03	8	Compliant
917MHz	7.97	8	Compliant
922MHz	7.77	8	Compliant

<b>Configuration (11G 10MHz)</b>			
Frequency (MHz)	Power Density (dBm)	LIMIT (dBm)	Test Result
907MHz	2.69	8	Compliant
912MHz	5.54	8	Compliant
917MHz	4.96	8	Compliant
922MHz	6.02	8	Compliant

<b>Configuration (11G 20MHz)</b>			
Frequency (MHz)	Power Density (dBm)	LIMIT (dBm)	Test Result
912MHz	2.43	8	Compliant
917MHz	3.74	8	Compliant



### Configuration (11B 20MHz)

#### 912MHz



\*RBW 3 kHz      Marker 1 [T1 ]  
\*VBW 30 kHz      -4.28 dBm  
\*SWT 500 s      912.605000000 MHz

Ref 21 dBm      \*Att 30 dB

1 PK  
VIEW

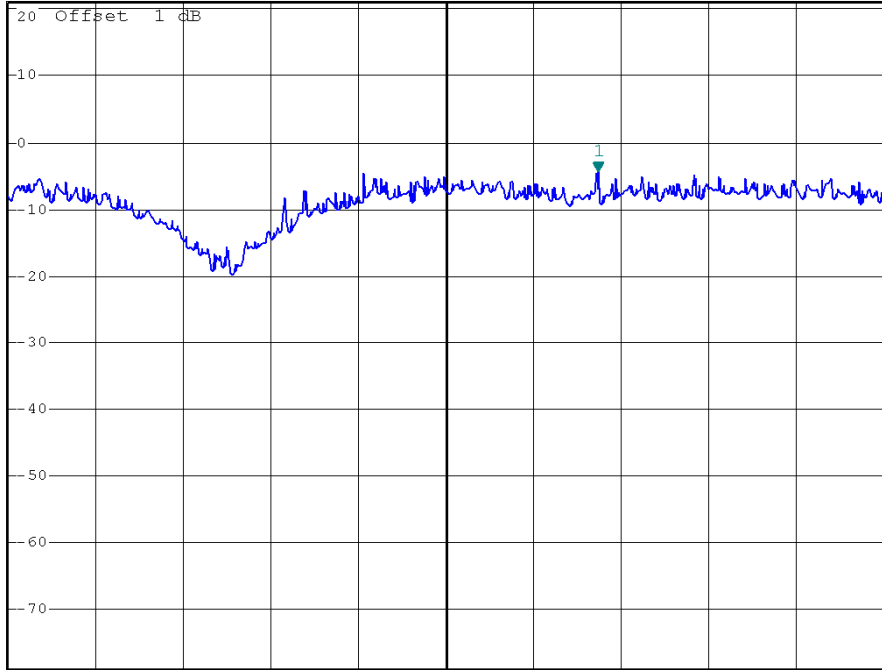

Center 912.344 MHz      150 kHz/      Span 1.5 MHz

#### 917MHz



\*RBW 3 kHz      Marker 1 [T1 ]  
\*VBW 30 kHz      -4.82 dBm  
\*SWT 500 s      917.265000000 MHz

Ref 21 dBm      \*Att 30 dB

1 PK  
VIEW

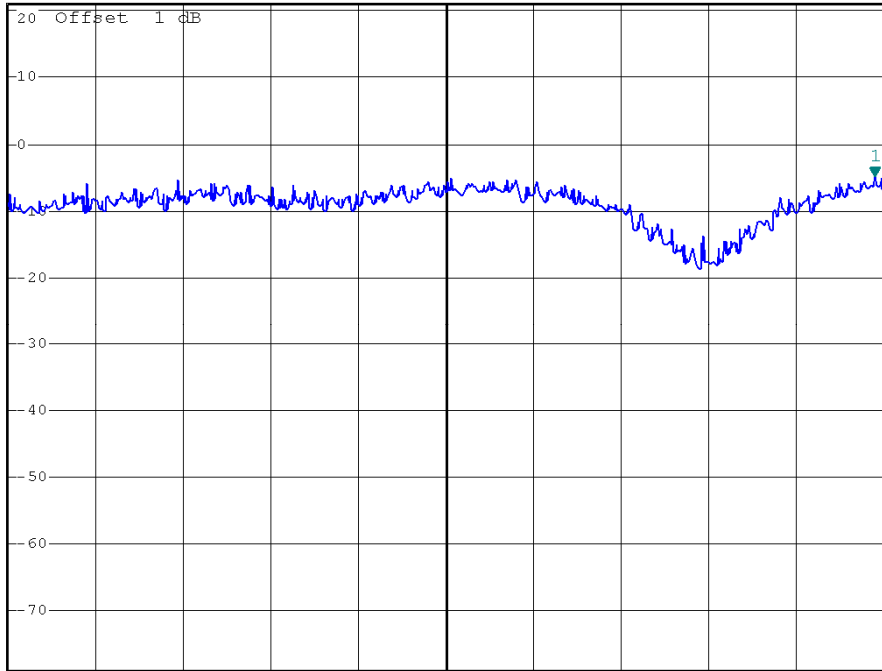

Center 916.53 MHz      150 kHz/      Span 1.5 MHz





### Configuration (5MHz)

#### 907MHz



\*RBW 3 kHz    Marker 1 [T1 ]  
\*VBW 30 kHz    6.80 dBm  
\*SWT 500 s    906.814000000 MHz

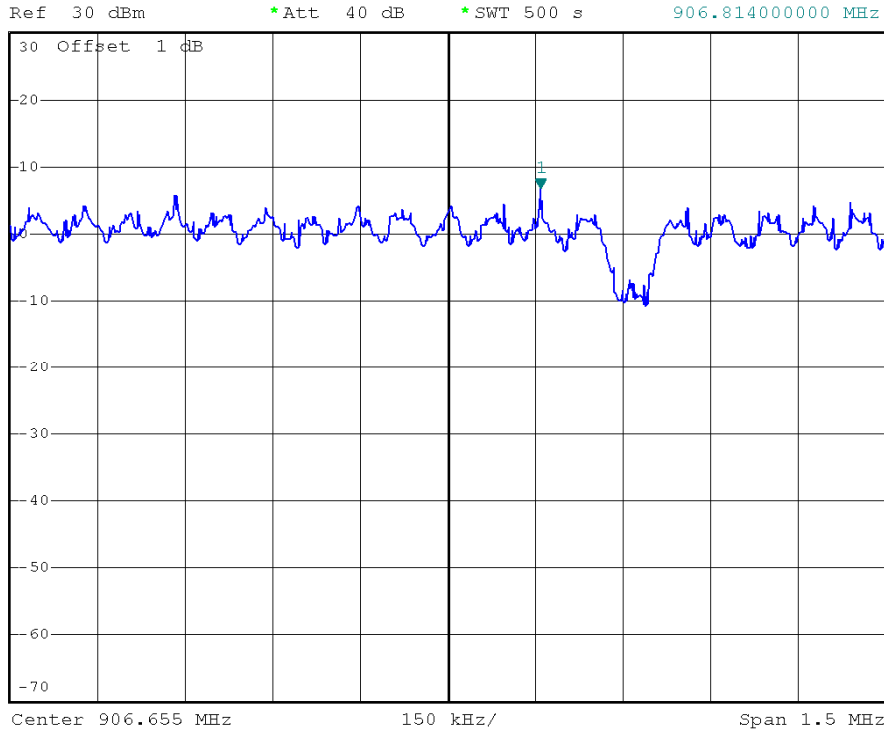

#### 912MHz



\*RBW 3 kHz    Marker 1 [T1 ]  
\*VBW 30 kHz    7.03 dBm  
\*SWT 500 s    913.845000000 MHz

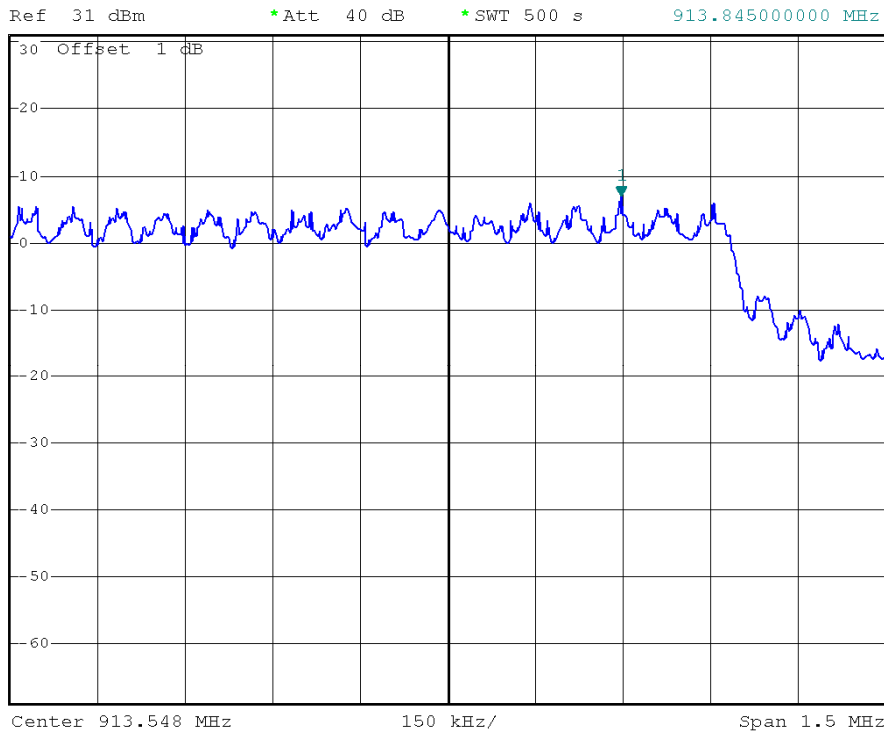



### Configuration (5MHz)

#### 917MHz



\*RBW 3 kHz    Marker 1 [T1 ]  
\*VBW 30 kHz    7.97 dBm  
\*SWT 500 s    919.004000000 MHz

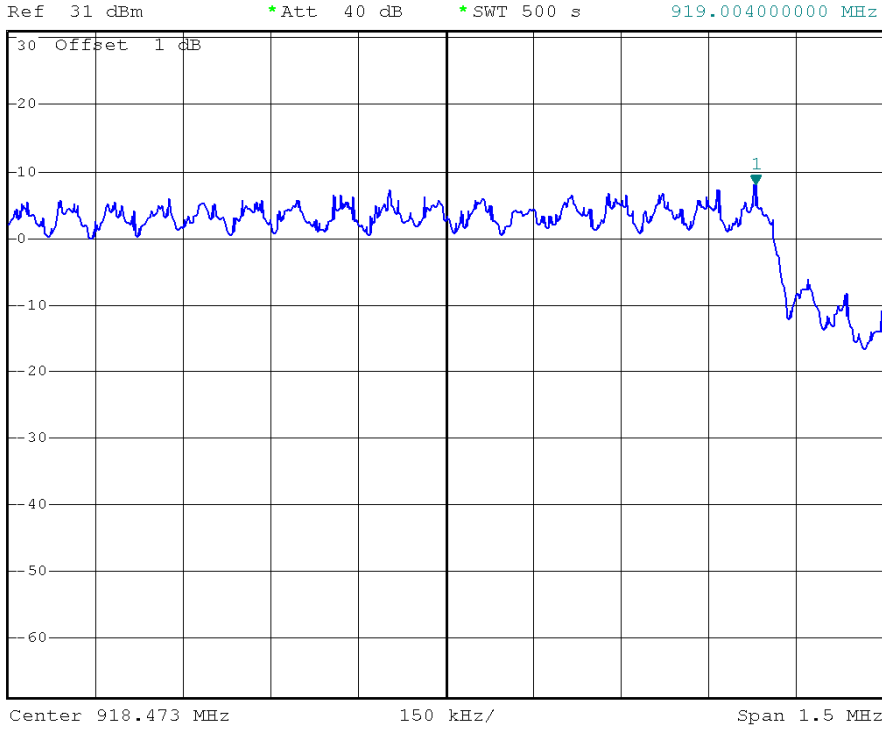

#### 922MHz



\*RBW 3 kHz    Marker 1 [T1 ]  
\*VBW 30 kHz    7.77 dBm  
\*SWT 500 s    920.090000000 MHz

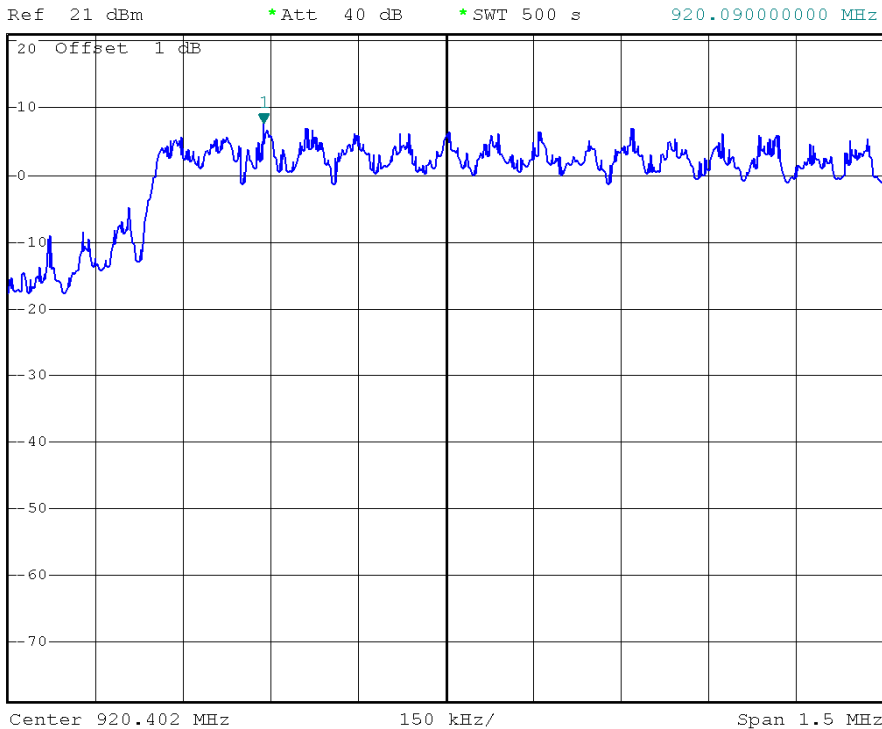



### Configuration (11G 10MHz)

#### 907MHz



\*RBW 3 kHz      Marker 1 [T1 ]  
\*VBW 30 kHz      2.69 dBm  
\*SWT 500 s      906.65700000 MHz

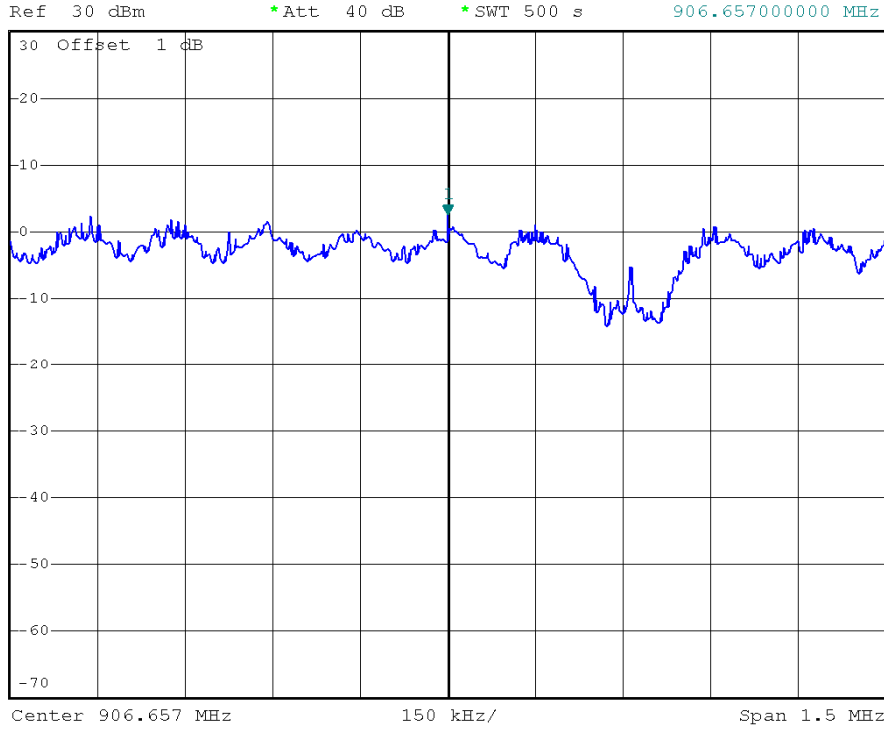

#### 912MHz



\*RBW 3 kHz      Marker 1 [T1 ]  
\*VBW 30 kHz      5.54 dBm  
\*SWT 500 s      915.40700000 MHz

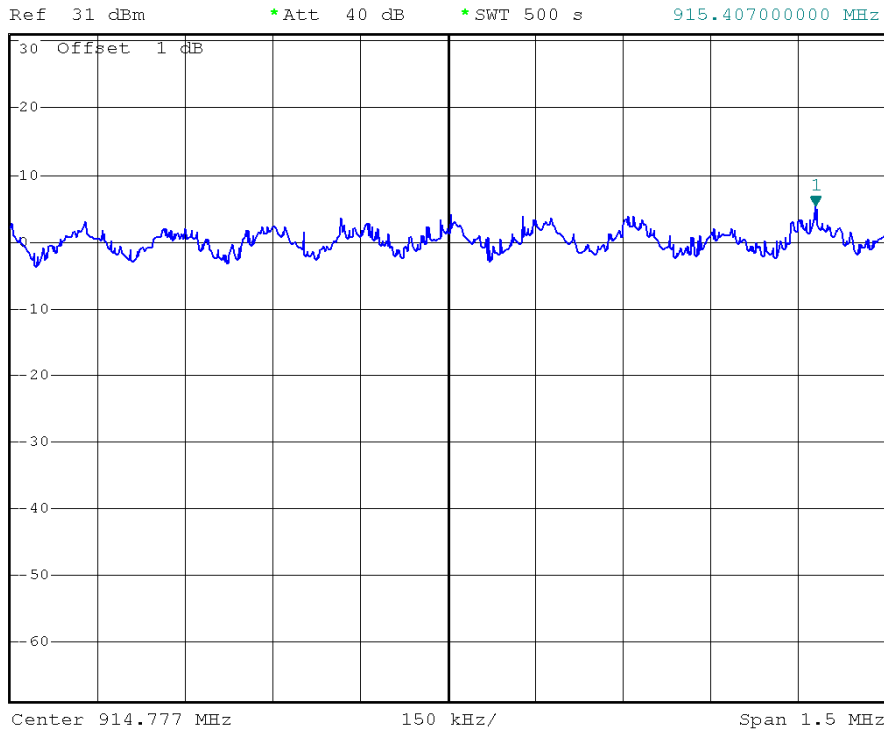



### Configuration (11G 10MHz)

#### 917MHz



\*RBW 3 kHz    Marker 1 [T1 ]  
\*VBW 30 kHz    4.96 dBm  
\*SWT 500 ms    919.154000000 MHz

Ref 31 dBm    \*Att 40 dB

1 PK  
VIEW

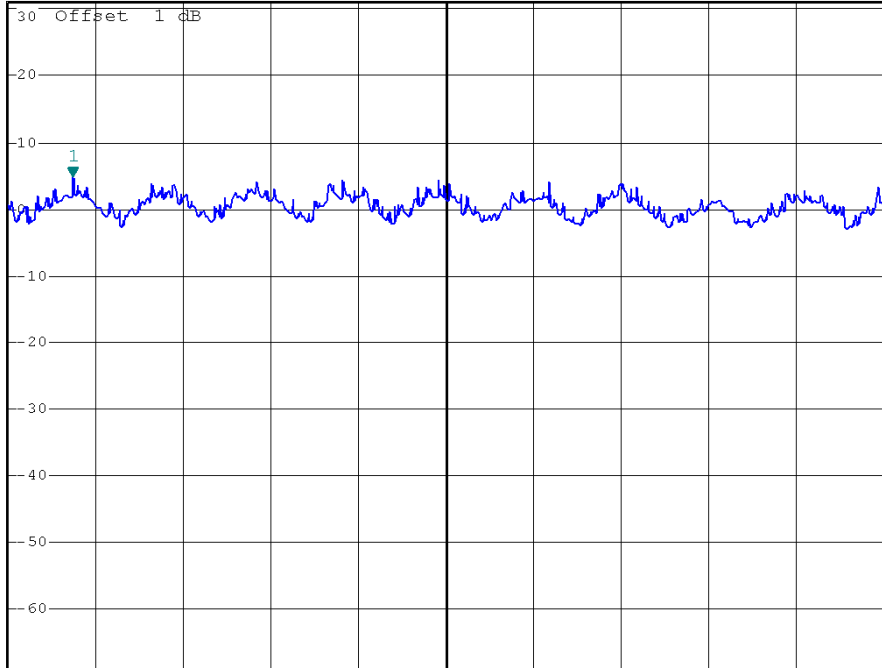

Center 919.793 MHz    150 kHz/    Span 1.5 MHz

#### 922MHz



\*RBW 3 kHz    Marker 1 [T1 ]  
\*VBW 30 kHz    6.02 dBm  
\*SWT 500 s    919.472000000 MHz

Ref 31 dBm    \*Att 40 dB

1 PK  
VIEW

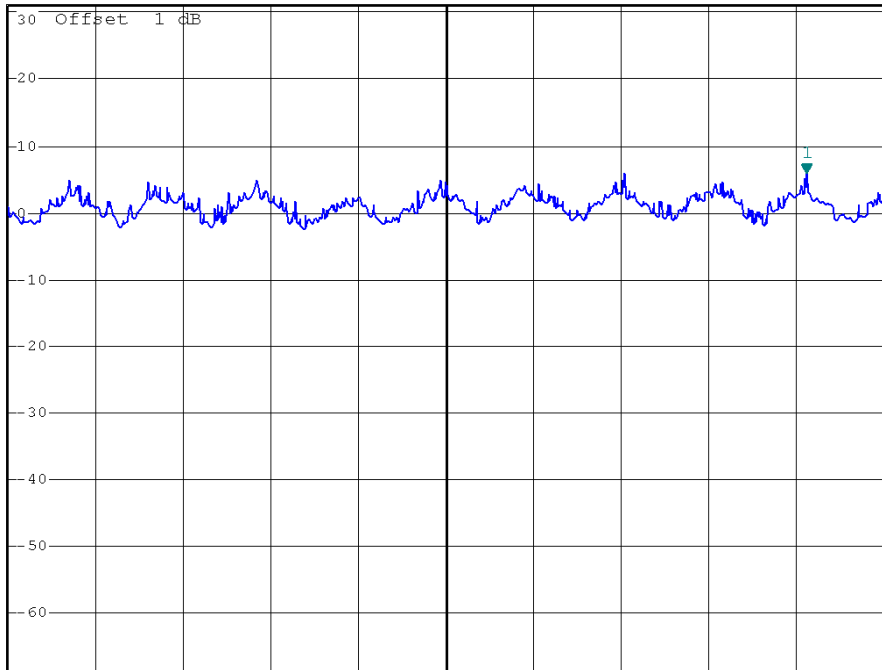

Center 918.854 MHz    150 kHz/    Span 1.5 MHz



### Configuration (11G 20MHz)

#### 912MHz



\*RBW 3 kHz    Marker 1 [T1 ]  
\*VBW 30 kHz    2.43 dBm  
\*SWT 500 s    917.939000000 MHz

Ref 31 dBm    \*Att 40 dB

1 PK  
VIEW

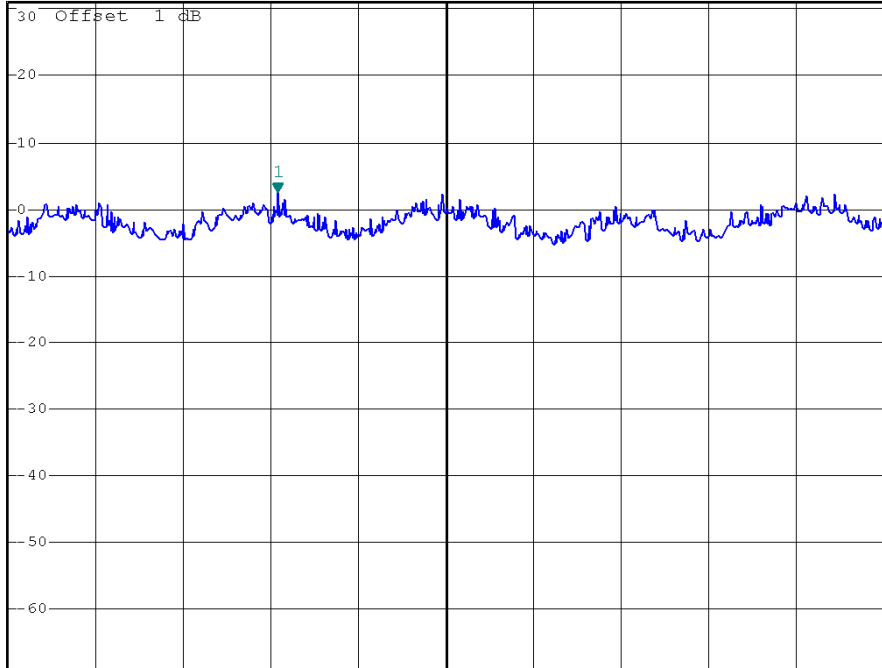

Center 918.227 MHz    150 kHz/    Span 1.5 MHz

#### 917MHz



\*RBW 3 kHz    Marker 1 [T1 ]  
\*VBW 30 kHz    3.74 dBm  
\*SWT 500 s    918.853000000 MHz

Ref 31 dBm    \*Att 40 dB

1 PK  
VIEW

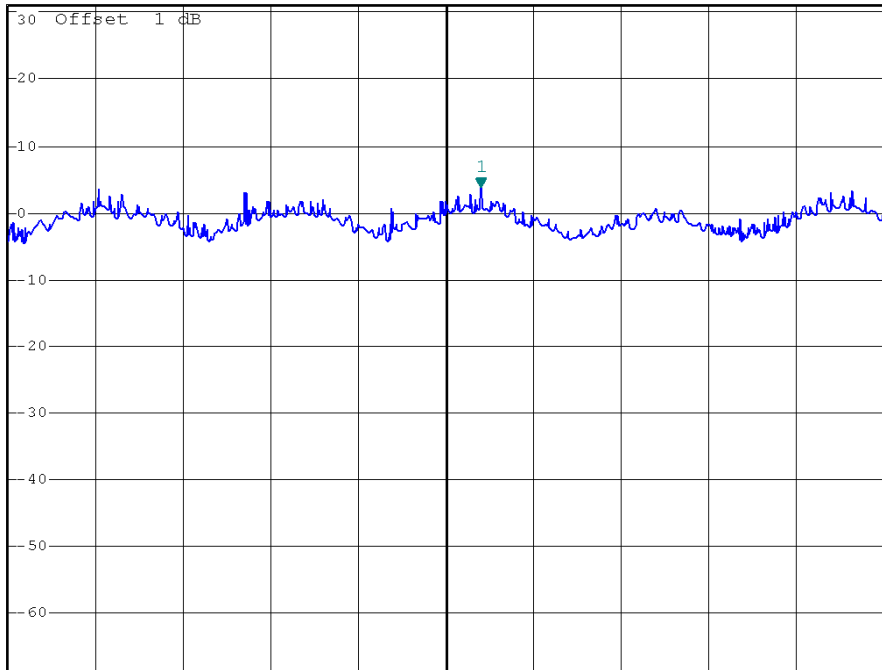

Center 918.793 MHz    150 kHz/    Span 1.5 MHz



**9. RF EXPOSURE TEST**

**9.1 RF EXPOSURE REQUIREMENTS / LIMIT:**

§1.1307(b)(1) and §1.1307(b)(2): Systems operating under the provisions of this section shall be operated in a manner that ensures that the public is not exposed to radio frequency energy levels in excess of the Commission’s guidelines.

§1.1310: As specified in this section, the maximum permissible exposure (MPE). Limit shall be used to evaluate the environmental impact of human exposure to radiofrequency (RF) radiation as specified in Sec. 1.1307(b), except in the case of portable devices which shall be evaluated according to the provisions of Sec. 2.1093 of this chapter.

(A) Limits for Occupational / Controlled Exposure

Frequency Range (MHz)	Electric Field Strength (E) (V/m)	Magnetic Field Strength (H) (A/m)	Power Density (S) (mW/ cm <sup>2</sup> )	Averaging Time  E  <sup>2</sup> , H  <sup>2</sup> or S (minutes)
0.3-3.0	614	1.63	(100)*	6
3.0-30	1842 / f	4.89 / f	(900 / f)*	6
30-300	61.4	0.163	1.0	6
300-1500			F/300	6
1500-100,000			5	6

(B) Limits for General Population / Uncontrolled Exposure

Frequency Range (MHz)	Electric Field Strength (E) (V/m)	Magnetic Field Strength (H) (A/m)	Power Density (S) (mW/ cm <sup>2</sup> )	Averaging Time  E  <sup>2</sup> , H  <sup>2</sup> or S (minutes)
0.3-1.34	614	1.63	(100)*	30
1.34-30	824/f	2.19/f	(180/f)*	30
30-300	27.5	0.073	0.2	30
300-1500			F/1500	30
1500-100,000			1.0	30

Note: f = frequency in MHz ; \*Plane-wave equivalent power density

**9.1.1 MPE CALCULATION METHOD**

MPE Limit Calculation: EUT’s operating frequencies @ **902-928**MHz;

Highest conducted power = **29.67**dBm (peak) therefore,

Limit for Uncontrolled exposure: **0.6** mW/ cm<sup>2</sup> or **10** mW/ cm<sup>2</sup>

EUT maximum antenna gain = **5.43** dBi.

Equation from page 18 of OET 65, Edition 97-01

$S = PG / 4 \pi R^2$  or  $R = \sqrt{PG / 4 \pi S}$  where,

**S** = Power Density (**0.6** mW/ cm<sup>2</sup>)

**P** = Power Input to antenna (**926.83**mW)

**G** = Antenna Gain (**3.49** numeric)

$$R = (926.83 * 3.49 / 4 * 3.14 * 0.6)^{1/2} = (3234.63 * 7.536)^{1/2} = 20.7 \text{ cm}$$