

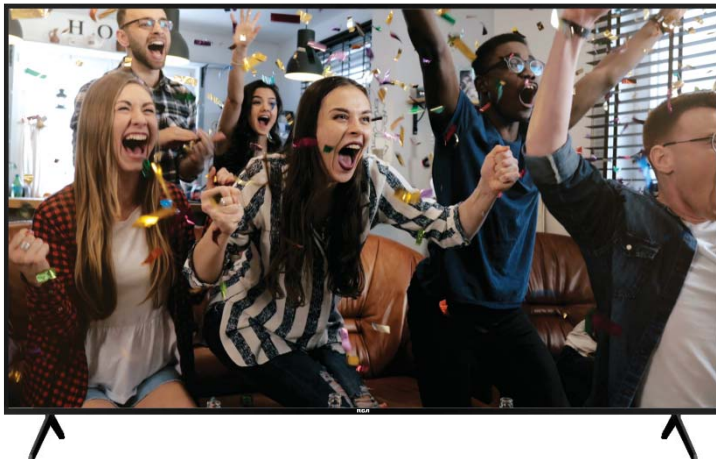

# INSTRUCTION MANUAL

---

Before using the TV, please read this manual thoroughly, and retain it for future reference.



## Model: RWOSU9847



This product has been manufactured and sold under the responsibility of Curtis International Ltd.

RCA, the RCA logo, the two dogs (Nipper and Chipper) logo, are registered trademarks or trademarks of Technicolor (S.A.) or its affiliates and are used under license by Curtis International Ltd.

Any other product, service, company, trade or product name and logo referenced herein are neither endorsed nor sponsored by Technicolor (S.A.) or its Affiliates.



## CONTENTS

1	<b>SAFETY PRECAUTION</b>		1
2	<b>IMPORTANT SAFETY INSTRUCTIONS</b>		2
3	<b>ACCESSORIES</b>		3
4	<b>GETTING STARTED</b>		3
5	<b>CONTROL REFERENCE GUIDE</b>	Remote Control	4
		Front View	5
		Back View	5
		Back View	6
6	<b>WALL MOUNT INSTALLATION</b>		7
7	<b>CONNECTIONS</b>	Installation	8
		Antenna Connection	9
		AV Connection	9
		HDMI Connection	10
		Power Cord Connection	10
		Optical audio output Connection	11
8	<b>INITIAL SETUP</b>	Putting The Unit On A Proper Place	12
		Turning The Unit On For The First Time	12
		Source Selection	13
9	<b>TV SETUP</b>	Quick Settings	14
		Using Live Menu	14
		Picture Menu	15
		Sound Menu	16
		Channel Menu	17
		Connection Menu	18
		General Menu	19
		Accessibility Menu	20
		Support Menu	21

# CONTENTS

---

10	<b>SMART TV OPERATION</b>		22
11	<b>Using Home Dashboard</b>		24
11	<b>USB MEDIA PLAYER</b>		25
12	<b>DISPLAY MODE</b>	Video Formats	27
13	<b>SPECIFICATION</b>		28
14	<b>TROUBLE- SHOOTING GUIDE</b>	TV Symptom	29
15	<b>WARRANTY CARD</b>		30

---

*\* The pictures, functions and other information provided in the manual are for reference only. If it does not match the actual object, please refer to the actual product.*

---

# SAFETY PRECAUTION

- \* CAUTION MARKING WAS LOCATED AT THE REAR OF THE APPARATUS. **PLACEMENT INFORMATION**



WARNING: TO REDUCE THE RISK OF ELECTRIC SHOCK, DO NOT REMOVE COVER (OR BACK) NO USER SERVICEABLE PARTS INSIDE. REFER SERVICING TO QUALIFIED SERVICE PERSONNEL.

 The lightning flash with arrowhead symbol, within an equilateral triangle, is intended to alert the user to the presence of uninsulated "dangerous voltage" within the product's enclosure that may be of sufficient magnitude to constitute a risk of electric shock to persons.

 The exclamation point within an equilateral triangle is intended to alert the user to the presence of important operating and maintenance (servicing) instructions in the literature accompanying the appliance.

 **CAUTION**

- DANGER OF EXPLOSION IF BATTERY IS INCORRECTLY REPLACED. REPLACE ONLY WITH THE SAME OR EQUIVALENT TYPE.
- USE OF CONTROLS OR ADJUSTMENTS OR PERFORMANCE OF PROCEDURES OTHER THAN THOSE SPECIFIED MAY RESULT IN HAZARDOUS RADIATION EXPOSURE.

 **WARNING:**

- TO REDUCE THE RISK OF FIRE OR ELECTRIC SHOCK, DO NOT EXPOSE THIS APPLIANCE TO RAIN OR MOISTURE. TO AVOID FIRE OR SHOCK HAZARD, DO NOT EXPOSE THIS UNIT TO RAIN OR MOISTURE. DO NOT PLACE OBJECTS FILLED WITH LIQUIDS ON OR NEAR THIS UNIT.
- SHOULD ANY TROUBLE OCCUR, DISCONNECT THE AC POWER CORD AND REFER SERVICING TO A QUALIFIED TECHNICIAN.

 This equipment is a Class II or double insulated electrical appliance. It has been designed in such a way that it does not require a safety connection to electrical earth.

- Do not use this unit in places that are extremely hot, cold, dusty or humid.
- Do not restrict the airflow of this unit by placing it somewhere with poor airflow, by covering it with a cloth, by placing it on bedding or carpeting.

## SAFETY INFORMATION

- When connecting or disconnecting the AC power cord, grip the plug and not the cord itself. Pulling the cord may damage it and create a hazard.
- When you are not going to use the unit for a long period of time, disconnect the AC power cord.

## RATING PLATE LOCATION

The rating plate is located on the rear of the unit.

## FCC STATEMENTS

NOTE: This unit has been tested and found to comply with the limits for a Class B digital device, pursuant to Part 15 of the FCC Rules. These limits are designed to provide reasonable protection against harmful interference in a residential installation.

This unit generates, uses and can radiate radio frequency energy and, if not installed and used in accordance with the instructions, may cause harmful interference to radio communication. However, there is no guarantee that interference will not occur in a particular installation. If this unit does cause harmful interference to radio or television reception, which can be determined by turning the unit off and on, the user is encouraged to try to correct the interference by one or more of the following measures:

- Reorient or relocate the receiving antenna.
- Increase the separation between the unit and receiver.
- Connect the unit into an outlet on a circuit different from that to which the receiver is connected.
- Consult the dealer or an experienced radio/TV technician for help.

 **WARNING:**

Changes or modifications to this unit not expressly approved by the party responsible for compliance could void the user authority to operate the unit.

This equipment complies with FCC radiation exposure limits set forth for an uncontrolled environment. This equipment should be installed and operated with minimum distance 20cm between the radiator & your body.

**HDMI**<sup>®</sup>

HIGH-DEFINITION MULTIMEDIA INTERFACE

"HDMI, the HDMI logo and High-Definition Multimedia Interface are trademarks or registered trademarks of HDMI Licensing LLC."

# IMPORTANT SAFETY INSTRUCTIONS

- 1) Read these instructions.
- 2) Keep these instructions.
- 3) Heed all warnings.
- 4) Follow all instructions.
- 5) Do not use this apparatus near water.
- 6) Clean only with a dry cloth.
- 7) Do not block any ventilation openings.  
Install in accordance with the manufacturer's instructions.
- 8) Do not install near any heat sources such as radiators, heat registers, stoves, or other apparatus (including amplifiers) that produce heat.
- 9) Do not defeat the safety purpose of the polarized or grounding-type plug.  
A polarized plug has two blades with one wider than the other.  
A grounding-type plug has two blades and a third grounding prong.  
The wide blade or the third prong is provided for your safety.  
If the provided plug does not fit into your wall outlet, consult an electrician for replacement of the obsolete outlet.
- 10) Protect the power cord from being walked on or pinched particularly at plugs, convenience receptacles, and the point where they exit from the apparatus.
- 11) Only use attachments / accessories specified by the manufacturer.
- 12) Use only with the cart, stand, tripod, bracket, or table specified by the manufacturer, or sold with the apparatus.  
When a cart is used, use caution when moving the cart / apparatus combination to avoid injury from tip-over.
- 13) Unplug this apparatus during lightning storms or when unused for long periods of time.
- 14) Refer all servicing to qualified service personnel. Servicing is required when the apparatus has been damaged in any way, such as the power cord or plug is damaged, liquid has been spilled or objects have fallen into the apparatus, the apparatus has been exposed to rain or moisture, does not operate normally, or has been dropped.
- 15) The mains plug is used as disconnect device, the disconnect device shall remain readily operable.



## PERSONAL SAFETY NOTICE

- ALWAYS read and follow all instructions for the installation and use of the TV.
- Place the TV in a location that is level and sturdy.
- DO NOT place the TV on a furniture with drawers that can be used as steps by small children.
- DO NOT allow children to pull the TV or climb on the furniture where the TV is placed.
- DO NOT allow children to play in front of or around the TV.
- ALWAYS route all the cables connecting to the TV so the cables cannot be easily pulled and grabbed by children.
- When installing the TV on a wall, please purchase a TV mount recommended by a professional TV installer, and follow the installation instructions that come with the TV mount.
- Before installing the TV on a wall, please check to make sure the wall structure can support the weight of the TV and the mount. If in doubt, please ask the advice from a professional TV installer.
- People should not be turning on the TV before checking that the power cord is inserted "well".
- People should be checking the voltage of the AC power receptacle and the TV before plugging in the TV.

# ACCESSORIES

Please check and identify the supplied accessories.

Remote control .....	x 1
Battery(AAA) .....	x 2
Instruction Manual .....	x 1
Base stand .....	x 2
Base stand screws .....	x 6
Troubleshooting instructions card.....	x 1

# GETTING STARTED

## USING THE REMOTE CONTROL

- Point the remote control at the remote sensor located on the unit.
- When there is a strong ambient light source, the performance of the infrared remote sensor may be degraded, causing unreliable operation.
- The recommended effective distance for remote operation is about 16 feet (5 meters).

## TO INSTALL THE BATTERIES

1. Open the battery door.

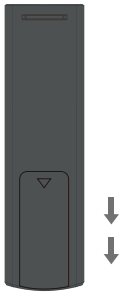

2. Insert 2"AAA"batteries.

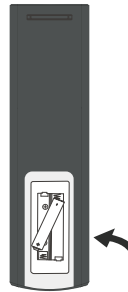

## BATTERY REPLACEMENT

When the batteries become weak, the operating distance of the remote control is greatly reduced and you will need to replace the batteries.

**⚠ CAUTION :** Danger of explosion if battery is incorrectly replaced.

## NOTES

- If the remote control is not going to be used for a long time, remove the batteries to avoid damage caused by battery leakage corrosion.
- Do not mix old and new batteries. Do not mix ALKALINE, standard (CARBON-ZINC) or rechargeable (NICKEL-CADMIUM) batteries.
- Always remove batteries as soon as they become weak.
- Weak batteries can leak and severely damage the remote control.

**⚠ WARNING :**  
Do not dispose batteries in a fire. Batteries may explode or leak.  
Batteries shall not be exposed to excessive heat such as sunshine, fire or the like.

# CONTROL REFERENCE GUIDE

## REMOTE CONTROL



Format : NEC

Customer code: 04H FBH

**POWER** (⏻): Turns the TV on or off.

**TV**: Switch to TV Mode.

**(Q)**: Switch to search menu.

**CC/SUB**: Setup the mode of closed caption or access the subtitle.

**(⊗)**: Enters the Quick Settings menu.

**(⇄)**: Select the input source mode.

**Number buttons**: Choose the channel directly

**LIST**: Access the channel list.

**(...)**: It displays the additional buttons on the remote control. Press this button to select the desired option from "More Actions" displayed on the TV screen.

**VOL+ / VOL-**: Increases or decreases the TV volume.

**CH<sup>^</sup> / CHV<sup>^</sup>**: Change to the previous or next program.

**QUICK ACCESS**: long-press 0, you can add Quick Access.

**FAV**: Show favorite channel list.

**GUIDE**: Check the programme.

**MUTE** (⊘): Mute or restore the sound.

**PLAY** (▶): Play while watching media.

**PAUSE** (⏸): Pause while watching media.

**HOME** (⌂): Enter the home page.

**Return(Back)**: Return to the previous step.

**EXIT**: Exit the current screen.

**Navigation buttons**: (Up/Down/Left/Right ◀/▶/▲/▼) Navigate the menu.

**(⊙)**: Confirm the selection.

**(⊕)** INFO: Show the detailed information.

**SAP**: Turn on the Audio Language.

**MOVIES**: Search Movies.(make sure the Internet connection is normal)

**REC**: This button does not apply to this model.

**(□)**: This button does not apply to this model.

**NETFLIX**: Access the Netflix interface.

**PRIME VIDEO**: Access the Prime Video interface.

**Color Buttons**(RED/GREEN/YELLOW/BLUE): Execute the prompt function in specific mode.

### IMPORTANT NOTICE:

Depending on the country where the TV is installed, certain apps may not be available.

The quick launch button on the remote control associated with those apps will therefore not work.

All other functionalities of the remote will work as designed.

\*Some functions and features are only available when using the LG ThinQ APP.



# CONTROL REFERENCE GUIDE

## FRONT VIEW

About remote control working distance and angle, see next page.

**Power/Standby Indicator:** Blue and red dual-color LED. It shows red when the TV is turned off and blue when turned on. **Remote Control Sensor:** Remote control IR sensor, which receives infrared ray sent by remote control.

**NOTE:** If there is a protective film around the screen, remove the protective film before using the TV.



Remote Control Sensor  
Power/Standby Indicator

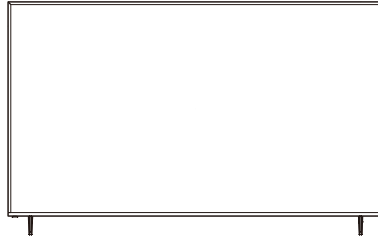

## BACK VIEW

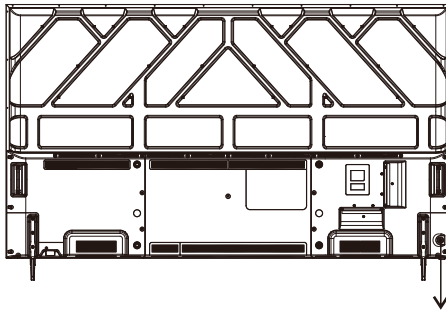

- ⏻ : When TV power off, short press this button to turn on. When TV is on, long press this button to turn off.
- When TV is on, short press this button to call out the key menu, short press this button again, the cursor will move from left to right. When the cursor moves to the icon you want to adjust the option, long press this button to select the option that needs to be adjusted, and the selected icon will become a hollow circle icon, change and then short press the button to achieve The function adjustment of the option. After the adjustment, long press the button again to exit the adjustment of the current option, at this time, the hollow circle icon will change back to the solid circle icon. Repeat the previous operation, you can realize the adjustment of other options.
- The pop-up menu will be automatically closed if there is no operation within 10 seconds.

## BACK VIEW

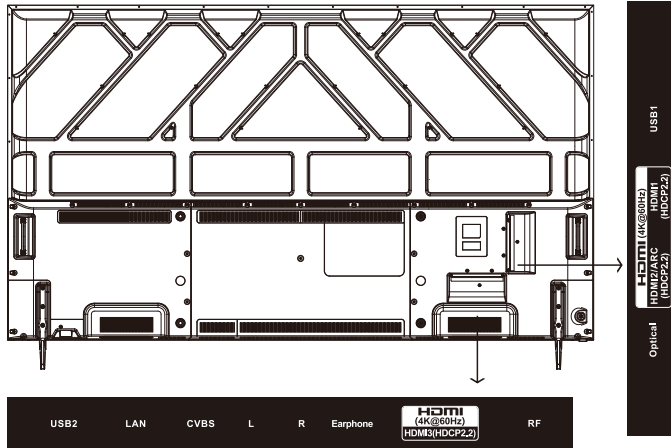

USB: Connect the USB device such as the flash disk to access the TV media function.

LAN: Connect the Internet.

CVBS : Connect an AV device that has composite video jacks, such as a VCR or DVD player.

- *L*: Left audio channel connection.
- *R*: Right audio channel connection.

EARPHONE: Connect a 3.5mm headphone for personal audio.

HDMI: (High-Definition Multimedia Interface) Provides an uncompressed digital connection. Please enter to the setup menu to turn it on.

RF: Connect to receive the signal from your antenna or cable through a coaxial cable.

OPTICAL: Digital TV sound output.

# WALL MOUNT INSTALLATION

## INSTALLING / REMOVING THE BASE STAND

**WARNING :** The LED Display is very fragile , and must be protected at all times when removing the base Stand .

Be sure that no hard or sharp object or anything that could scratch or damage the LED display comes into contact with it Do NOT exert pressure on the front of the unit at any time because the screen could crack.

1. Disconnect all cables or cords connected to the unit.
2. Lay the unit down on a flat surface with the back side facing up Please make sure to place a soft cushioned material (such as a pillow or thick piece of foam) beneath the screen.
3. To remove the base stand, loosen screws off the holes then pull downwards to release the base stand

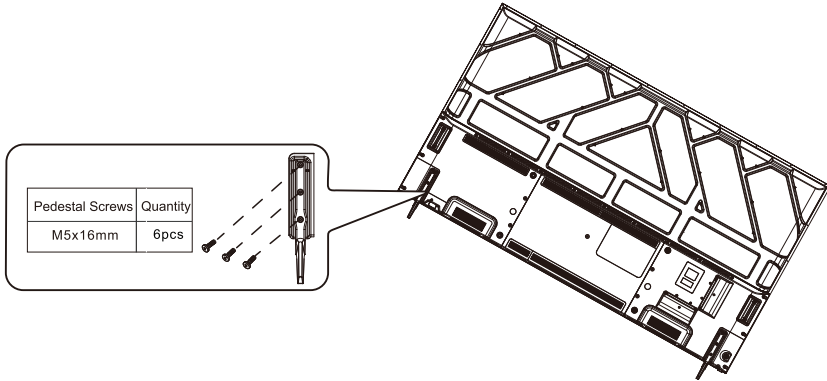

## MOUNTING ON THE WALL

This unit is VESA-compliant, and is designed to be wall-mounted with a VESA-compliant 35.4"x16" (900mm x 400mm) mounting kit designed for flat-panel TVs (not supplied). Length of screw should be not exceed 18 mm

## NOTE

Remove the base stand before mounting the unit on the wall.

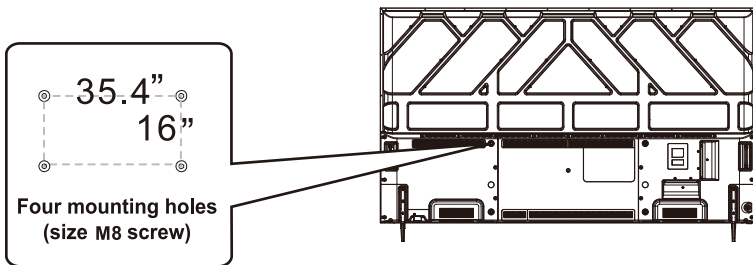

# Installation

Your TV is packaged with the stand and the cabinet separated. Before using the TV, install the stand as described below, or if you want to mount it to a wall, see page 7 for mounting advice; the wall mount itself is not supplied.

## IMPORTANT!

- Make sure the TV set is unplugged from the power supply before installing or removing the stand.
- The TV panel may be awkward to install on your own. We recommend you ask someone to help with installation and/or removal of the stand.

## Attaching the stand

### Step 1

Place a soft cushioned material on top of a flat surface to prevent damaging the screen panel. Then place the TV monitor flat on top, with the screen side facing down, as illustrated on the right (1).

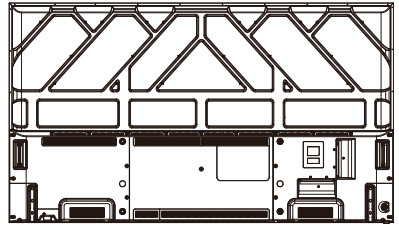

### Step 2

Align the screw holes on the stand and the bottom of the TV, as illustrated on the right (2).



### Step 3

Tighten the screws (supplied) with a screwdriver to affix the stand to the panel, as illustrated on the right (3).

