



INSTRUCTION MANUAL

Before using the TV, please read this manual thoroughly, and retain it for future reference.



Model: RQSM5022-B



'This product has been manufactured and sold under the responsibility of Curtis International Ltd.

RCA, the RCA logo, the two dogs (Nipper and Chipper) logo, are registered trademarks or trademarks of Technicolor (S.A.) or its affiliates and are used under license by Curtis International Ltd.

Any other product, service, company, trade or product name and logo referenced herein are neither endorsed nor sponsored by Technicolor (S.A.) or its Affiliates.'

CONTENTS

| | | | |
|---|--------------------------------------|--|----|
| 1 | SAFETY PRECAUTION | | 1 |
| 2 | IMPORTANT SAFETY INSTRUCTIONS | | 2 |
| 3 | ACCESSORIES | | 3 |
| 4 | GETTING STARTED | | 3 |
| 5 | CONTROL REFERENCE GUIDE | Remote Control | 4 |
| | | Front View | 5 |
| | | Back View | 5 |
| | | Back View | 6 |
| 6 | WALL MOUNT INSTALLATION | | 7 |
| 7 | CONNECTIONS | Installation | 8 |
| | | Antenna Connection | 9 |
| | | AV Connection | 9 |
| | | HDMI Connection | 10 |
| | | Power Cord Connection | 10 |
| | | Optical audio output Connection | 11 |
| 8 | INITIAL SETUP | Putting The Unit On A Proper Place | 12 |
| | | Turning The Unit On For The First Time | 12 |
| | | Source Selection | 12 |
| 9 | TV SETUP | Picture Menu | 13 |
| | | Sound Menu | 14 |
| | | Channel Menu | 15 |
| | | Time Menu | 16 |
| | | Setup Menu | 17 |
| | | Advance Menu | 18 |
| | | Network Menu | 19 |

CONTENTS

| | | | |
|----|--|---------------|----|
| 10 | USB MEDIA PLAYER | | 20 |
| 11 | SMART TV OPERATION | | 22 |
| 12 | DISPLAY MODE | Video Formats | 25 |
| 13 | SPECIFICATION | | 26 |
| 14 | TROUBLE- SHOOTING GUIDE | TV Symptom | 27 |
| 15 | WARRANTY CARD | | 28 |

** The pictures, functions and other information provided in the manual are for reference only.
If it does not match the actual object, please refer to the actual product.*

SAFETY PRECAUTION

* CAUTION MARKING WAS LOCATED AT THE REAR OF THE APPARATUS. **PLACEMENT INFORMATION**



WARNING: TO REDUCE THE RISK OF ELECTRIC SHOCK, DO NOT REMOVE COVER (OR BACK) NO USER SERVICEABLE PARTS INSIDE. REFER SERVICING TO QUALIFIED SERVICE PERSONNEL.

 The lightning flash with arrowhead symbol, within an equilateral triangle, is intended to alert the user to the presence of uninsulated “dangerous voltage” within the product’s enclosure that may be of sufficient magnitude to constitute a risk of electric shock to persons.

 The exclamation point within an equilateral Triangle is intended to alert the user to The presence of important operating and maintenance (servicing) instructions in the literature accompanying the appliance.

CAUTION

- DANGER OF EXPLOSION IF BATTERY IS INCORRECTLY REPLACED. REPLACE ONLY WITH THE SAME OR EQUIVALENT TYPE.
- USE OF CONTROLS OR ADJUSTMENTS OR PERFORMANCE OF PROCEDURES OTHER THAN THOSE SPECIFIED MAY RESULT IN HAZARDOUS RADIATION EXPOSURE.

WARNING:

- TO REDUCE THE RISK OF FIRE OR ELECTRIC SHOCK, DO NOT EXPOSE THIS APPLIANCE TO RAIN OR MOISTURE.
- TO PREVENT FIRE OR SHOCK HAZARD, DO NOT EXPOSE THIS UNIT TO RAIN OR MOISTURE. DO NOT PLACE OBJECTS FILLED WITH LIQUIDS ON OR NEAR THIS UNIT.
- SHOULD ANY TROUBLE OCCUR, DISCONNECT THE AC POWER CORD AND REFER SERVICING TO A QUALIFIED TECHNICIAN.

 This equipment is a Class II or double insulated electrical appliance. It has been designed in such a way that it does not require a safety connection to electrical earth.

- Do not use this unit in places that are extremely hot, cold, dusty or humid.
- Do not restrict the airflow of this unit by placing it somewhere with poor airflow, by covering it with a cloth, by placing it on bedding or carpeting.

SAFETY INFORMATION

- When connecting or disconnecting the AC power cord, grip the plug and not the cord itself. Pulling the cord may damage it and create a hazard.
- When you are not going to use the unit for a long period of time, disconnect the AC power cord.

RATING PLATE LOCATION

The rating plate is located on the rear of the unit.

FCC STATEMENTS

NOTE: This unit has been tested and found to comply with the limits for a Class B digital device, pursuant to Part 15 of the FCC Rules. These limits are designed to provide reasonable protection against harmful interference in a residential installation.

This unit generates, uses and can radiate radio frequency energy and, if not installed and used in accordance with the instructions, may cause harmful interference to radio communication. However, there is no guarantee that interference will not occur in a particular installation. If this unit does cause harmful interference to radio or television reception, which can be determined by turning the unit off and on, the user is encouraged to try to correct the interference by one or more of the following measures:

- Reorient or relocate the receiving antenna.
- Increase the separation between the unit and receiver.
- Connect the unit into an outlet on a circuit different from that to which the receiver is connected.
- Consult the dealer or an experienced radio/TV technician for help.

WARNING:

Changes or modifications to this unit not expressly approved by the party responsible for compliance could void the user authority to operate the unit.

This equipment complies with FCC radiation exposure limits set forth for an uncontrolled environment. This equipment should be installed and operated with minimum distance 20cm between the radiator & your body.

HDMI®

HIGH-DEFINITION MULTIMEDIA INTERFACE

“HDMI, the HDMI logo and High-Definition Multimedia Interface are trademarks or registered trademarks of HDMI Licensing LLC.”

IMPORTANT SAFETY INSTRUCTIONS

- 1) Read these instructions.
- 2) Keep these instructions.
- 3) Heed all warnings.
- 4) Follow all instructions.
- 5) Do not use this apparatus near water.
- 6) Clean only with a dry cloth.
- 7) Do not block any ventilation openings.
Install in accordance with the manufacturer's instructions.
- 8) Do not install near any heat sources such as radiators, heat registers, stoves, or other apparatus (including amplifiers) that produce heat.
- 9) Do not defeat the safety purpose of the polarized or grounding-type plug.
A polarized plug has two blades with one wider than the other.
A grounding-type plug has two blades and a third grounding prong.
The wide blade or the third prong is provided for your safety.
If the provided plug does not fit into your wall outlet, consult an electrician for replacement of the obsolete outlet.
- 10) Protect the power cord from being walked on or pinched particularly at plugs, convenience receptacles, and the point where they exit from the apparatus.
- 11) Only use attachments / accessories specified by the manufacturer.
- 12) Use only with the cart, stand, tripod, bracket, or table specified by the manufacturer, or sold with the apparatus.
When a cart is used, use caution when moving the cart / apparatus combination to avoid injury from tip-over.
- 13) Unplug this apparatus during lightning storms or when unused for long periods of time.
- 14) Refer all servicing to qualified service personnel. Servicing is required when the apparatus has been damaged in any way, such as the power cord or plug is damaged, liquid has been spilled or objects have fallen into the apparatus, the apparatus has been exposed to rain or moisture, does not operate normally, or has been dropped.
- 15) The mains plug is used as disconnect device, the disconnect device shall remain readily operable.



PERSONAL SAFETY NOTICE

- ALWAYS read and follow all instructions for the installation and use of the TV.
- Place the TV in a location that is level and sturdy.
- DO NOT place the TV on a furniture with drawers that can be used as steps by small children.
- DO NOT allow children to pull the TV or climb on the furniture where the TV is placed.
- DO NOT allow children to play in front of or around the TV.
- ALWAYS route all the cables connecting to the TV so the cables cannot be easily pulled and grabbed by children.
- When installing the TV on a wall, please purchase a TV mount recommended by a professional TV installer, and follow the installation instructions that come with the TV mount.
- Before installing the TV on a wall, please check to make sure the wall structure can support the weight of the TV and the mount. If in doubt, please ask the advice from a professional TV installer.
- People should not be turning on the TV before checking that the power cord is inserted "well".
- People should be checking the voltage of the AC power receptacle and the TV before plugging in the TV.

ACCESSORIES

Please check and identify the supplied accessories.

| | |
|--|-----|
| Remote control | x 1 |
| Battery(AAA) | x 2 |
| Instruction Manual | x 1 |
| Base stand | x 2 |
| Base stand screws..... | x 4 |
| Troubleshooting instructions card..... | x 1 |

GETTING STARTED

USING THE REMOTE CONTROL

- Point the remote control at the remote sensor located on the unit.
- When there is a strong ambient light source, the performance of the infrared remote sensor may be degraded, causing unreliable operation.
- The recommended effective distance for remote operation is about 16 feet (5 meters).

TO INSTALL THE BATTERIES

1. Open the battery door.

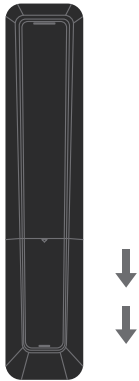

2. Insert 2"AAA"batteries.

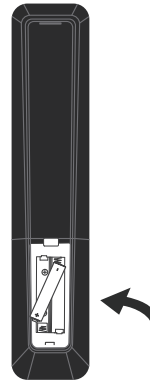

BATTERY REPLACEMENT

When the batteries become weak, the operating distance of the remote control is greatly reduced and you will need to replace the batteries.

! CAUTION : Danger of explosion if battery is incorrectly replaced.

NOTES

- If the remote control is not going to be used for a long time, remove the batteries to avoid damage caused by battery leakage corrosion.
- Do not mix old and new batteries. Do not mix ALKALINE, standard (CARBON-ZINC) or rechargeable (NICKEL-CADMIUM) batteries.
- Always remove batteries as soon as they become weak.
- Weak batteries can leak and severely damage the remote control.

! WARNING :
Do not dispose batteries in a fire. Batteries may explode or leak.
Batteries shall not be exposed to excessive heat such as sunshine, fire or the like.

CONTROL REFERENCE GUIDE

REMOTE CONTROL

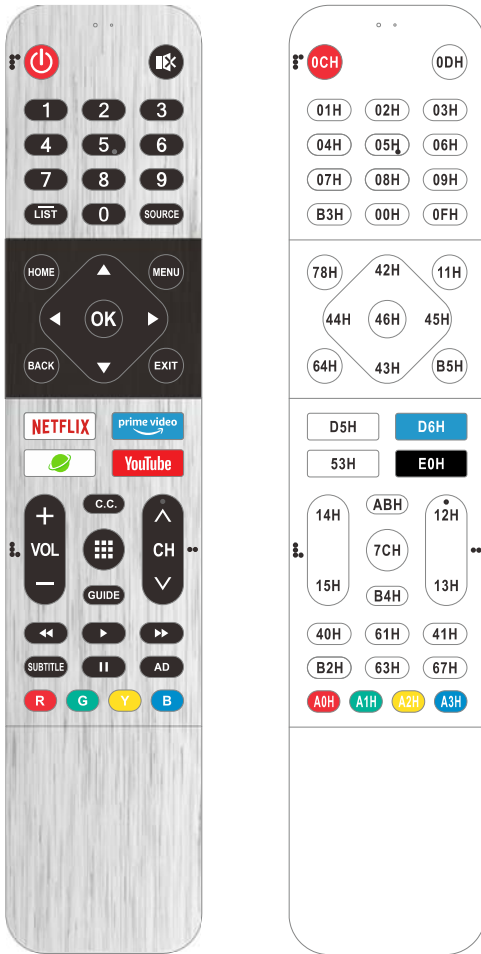

Remote control system code: TC9012

Customer code: 0E

POWER(⏻): Turns the TV on or off.

MUTE(🔇): Mute or restore the sound

Number buttons: Choose the channel directly

LIST: Access the channel list.

SOURCE: Select the input source mode.

HOME(🏠): Enter the home page.

Return(Back): Return to the previously-viewed channel.

MENU: Access the main menu

EXIT: Exit the current screen.

Navigation buttons: (Up/Down/Left/Right ◀/▶/▲/▼)

Navigate the menu.

OK: Confirm the selection.

NETFLIX: Access the Netflix interface.

PRIME VIDEO: Access the Prime Video interface.

🌐: Access the Internet.

YOUTUBE: Access the Youtube interface.

VOL+/VOL- : Increases or decreases the TV volume.

CH^/CHv : Change to the previous or next program.

CC: Setup the mode of closed caption.

📺: Direct access to netrange application.

GUIDE: This button does not apply to this model.

FAST BACKWARD/FAST FORWARD (◀◀/▶▶): Fast review of fast forward.

PLAY (▶): Play while watching media.

PAUSE (⏸): Pause while watching media.

SUBTITLE: Access the subtitle.

AD: This button does not apply to this model.

Color Buttons(REDF/GREEN/YELLOW/BLUE): Execute the prompt function in specific mode.

IMPORTANT NOTICE:

Depending on the country where the TV is installed, certain apps may not be available.

The quick launch button on the remote control associated with those apps will therefore not work.

All other functionalities of the remote will work as designed.

CONTROL REFERENCE GUIDE

FRONT VIEW

About remote control working distance and angle, see next page.

Power/Standby Indicator: Blue and red dual-color LED. It shows red when the TV is turned off and blue when turned on. Remote Control Sensor: Remote control IR sensor, which receives infrared ray sent by remote control.

NOTE: If there is a protective film around the screen, remove the protective film before using the TV.

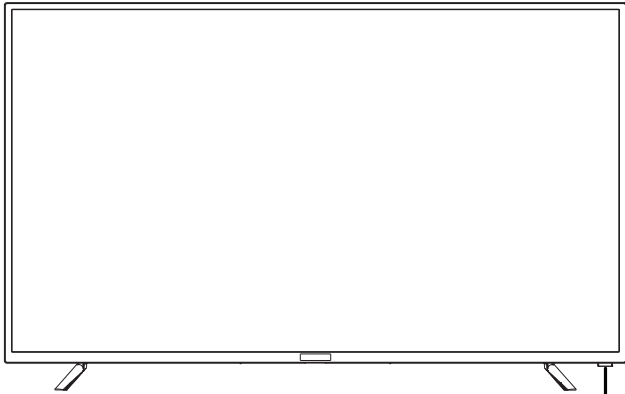

Power/Standby Indicator
Remote Control Sensor

BACK VIEW

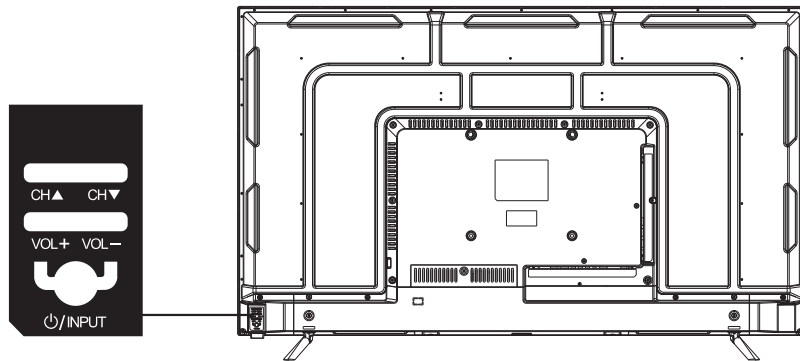

CH▲: Scans up through the channel list. In the input source menu, it acts like the up arrow on the remote control.

CH▼: Scans down through the channel list. In the input source menu, it acts like the down arrow on the remote control.

VOL+: Increases the volume.

VOL-: Decreases the volume.

⏻/INPUT: When TV power off, short press this button to turn on. When TV is on, long press this button to turn off, short press this button to call out the input source menu, press the CH+/- button to select the input source and press the power on/off button again to confirm the selection.

BACK VIEW

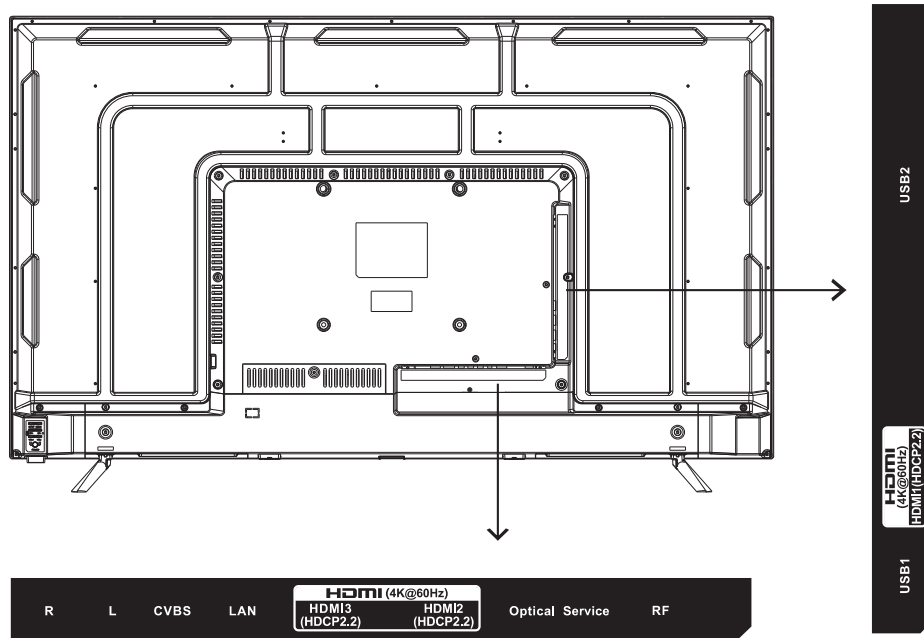

CVBS : Connect an AV device that has composite video jacks, such as a VCR or DVD player.

- *L*: Left audio channel connection.
- *R*: Right audio channel connection.

LAN: Connect the Internet.

HDMI: (High-Definition Multimedia Interface) Provides an uncompressed digital connection. Please enter to the setup menu to turn it on.

OPTICAL: Digital TV sound output.

Service: This port is used by professional maintenance personnel when repairing the machine.

RF: Connect to receive the signal from your antenna or cable through a coaxial cable.

USB: Connect the USB device such as the flash disk to access the TV media function.

HDMI Link (HDMI1): Command and control HDMI devices connected to the TV set. Please enter to the setup menu to turn it on.

WALL MOUNT INSTALLATION

INSTALLING / REMOVING THE BASE STAND

WARNING : The LED Display is very fragile , and must be protected at all times when removing the base Stand .

Be sure that no hard or sharp object or anything that could scratch or damage the LED display comes into contact with it Do NOT exert pressure on the front of the unit at any time because the screen could crack.

1. Disconnect all cables or cords connected to the unit.
2. Lay the unit down on a flat surface with the back side facing up Please make sure to place a soft cushioned material (such as a pillow or thick piece of foam) beneath the screen.
3. To remove the base stand , loosen screws off the holes then pull downwards to release the base stand

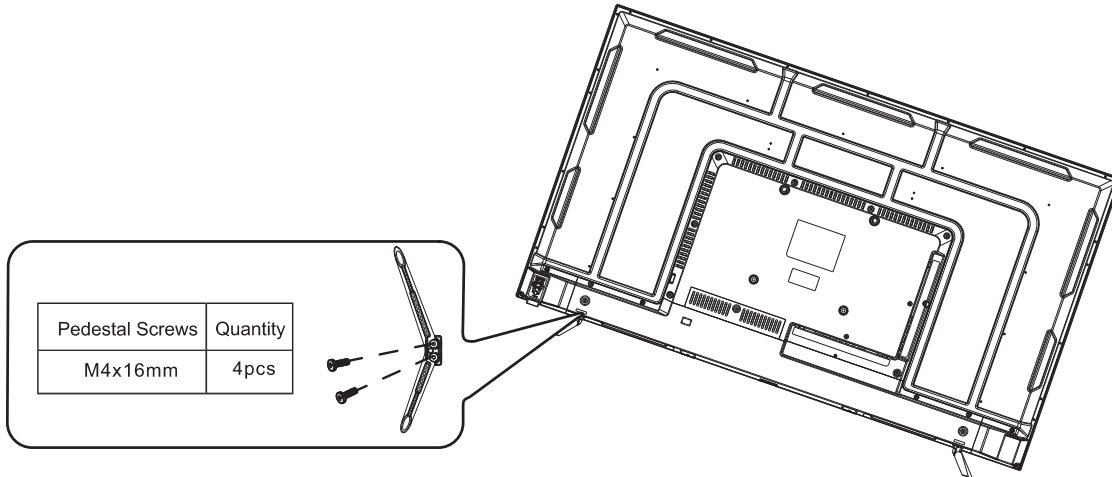

MOUNTING ON THE WALL

This unit is VESA-compliant, and is designed to be wall-mounted with a VESA-compliant 8"x 8" (200mm x 200mm) mounting kit designed for flat-panel TVs (not supplied). Length of screw should be not exceed 8 mm

NOTE

Remove the base stand before mounting the unit on the wall.

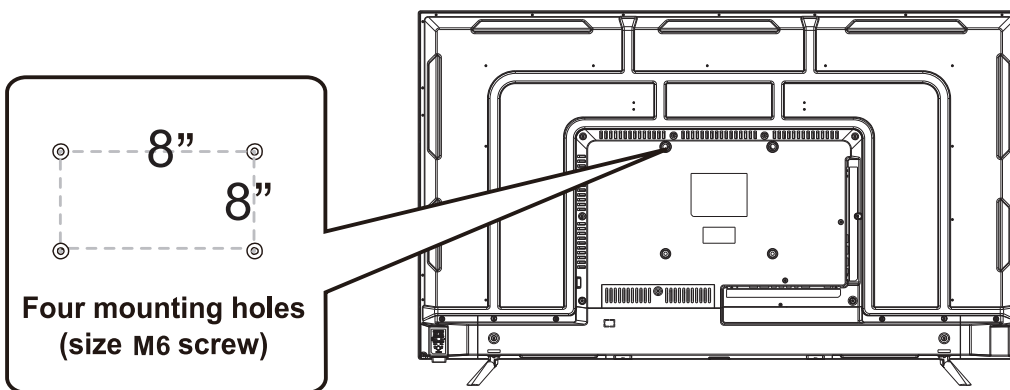

Installation

Your TV is packaged with the stand and the cabinet separated. Before using the TV, install the stand as described below, or if you want to mount it to a wall, see page 7 for mounting advice; the wall mount itself is not supplied.

IMPORTANT!

- Make sure the TV set is unplugged from the power supply before installing or removing the stand.
- The TV panel may be awkward to install on your own. We recommend you ask someone to help with installation and/or removal of the stand.

Attaching the stand

Step 1

Place a soft cushioned material on top of a flat surface to prevent damaging the screen panel. Then place the TV monitor flat on top, with the screen side facing down, as illustrated on the right (1).

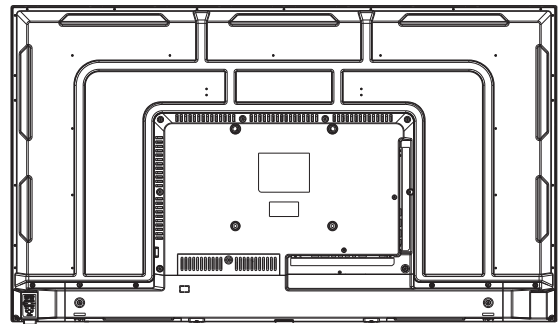

①

Step 2

Align the screw holes on the stand and the bottom of the TV, as illustrated on the right (2).

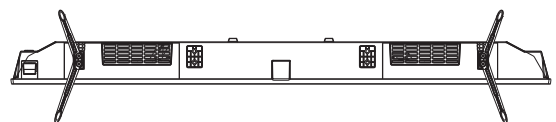

②

Step 3

Tighten the screws (supplied) with a screwdriver to affix the stand to the panel, as illustrated on the right (3).

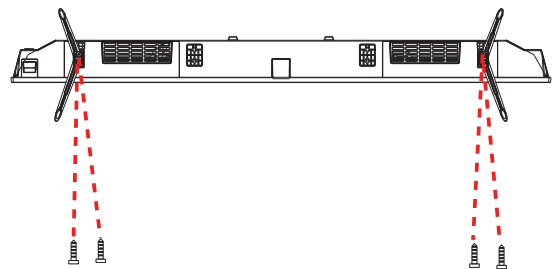

③

NOTE: Do not apply excessive force as this may damage the screw holes.

CONNECTIONS

CONNECTING A TV ANTENNA / CABLE / SATELLITE

To view television channels correctly, a signal must be received from one of the following sources:

- An indoor or outdoor aerial antenna
- A cable system
- A satellite system

NOTE

For receiving over-the-air TV broadcasts, we recommend that you use an external fixed antenna. Should you require the use of a temporary antenna, please ensure that you purchase an antenna with sufficient ability to receive in weak signal areas. Only when you are in close proximity to a transmitter will a temporary antenna reproduce a signal as strongly as a fixed antenna.

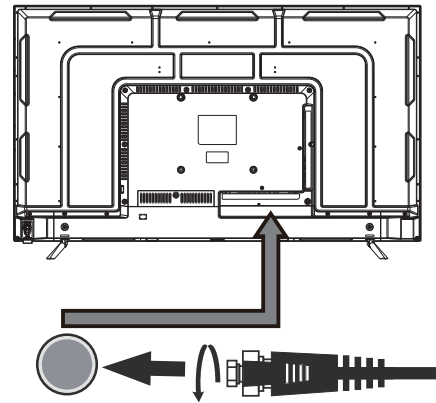

Satellite, cable or TV antenna cable to TV ANTENNA terminal (cable not included)

CONNECTING AN A/V DEVICE

To connect to other equipment such as a VCR, camcorder, satellite system or cable, etc.

CONNECTING DEVICES WITH A COMPOSITE VIDEO OUTPUT

To connect A/V devices such as a VCR, video game system or camcorder.

Connecting to a VCR / Video Game System / Camcorder

Connect the AUDIO / VIDEO cable (not included) as shown.

Make sure you connect the cable from the other equipment (**AUDIO** and **VIDEO OUT**) to this unit (AV in)

NOTE

1. Please refer to the user manual for the other equipment for more information.

2. Composite video input (shared with component)

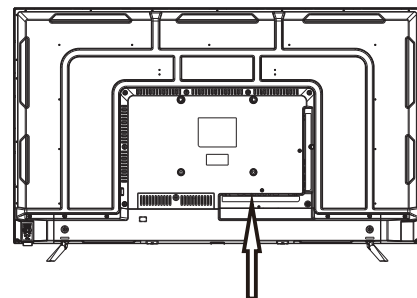

To AUDIO / VIDEO OUT jacks

VCR / VIDEO GAME SYSTEM / CAMCORDER etc.

YELLOW WHITE RED
VIDEO IN AUDIO IN
Y (VIDEO) L R

To AUDIO / VIDEO IN jacks

CONNECTIONS

CONNECTING A HIGH-DEFINITION (HD) SOURCE USING HDMI CONNECTION

HDMI (High Definition Multimedia Interface) supports both video and audio on a single digital connection for use with DVD players, DTV, set-top boxes and other digital AV devices. HDMI was developed to provide the technologies of High Bandwidth Digital Content Protection (HDCP) as well as Digital Visual Interface (DVI) in one specification. HDCP is used to protect digital content transmitted and received by DVI-compliant or HDMI-compliant displays.

HDMI has the capability to support standard, enhanced or high-definition video plus standard to multi-channel surround-sound audio. HDMI features include uncompressed digital video, a bandwidth of up to 2.2 gigabytes per second (with HDTV signals), one connector (instead of several cables and connectors), and communication between the AV source and AV devices such as DTVs.

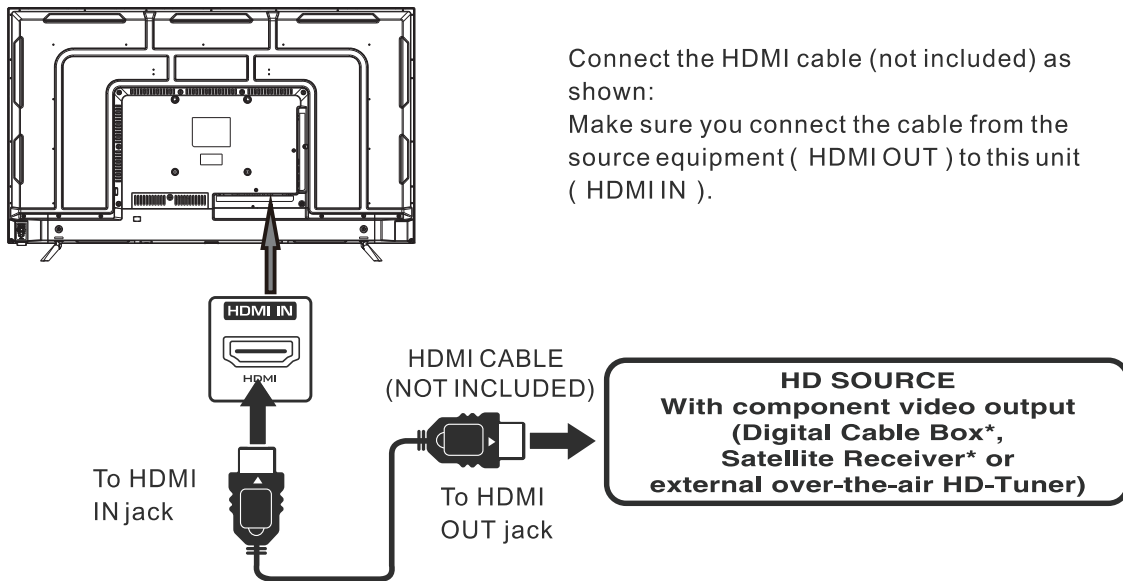

CONNECTING THE POWER CORD

You can power on your TV unit before you make sure the power cord is inserted well. At the same time, please check that the rated voltage of your unit matches your local Voltage.

NOTE

- Insert the power plug fully into the socket outlet. (If the power plug is loose, it could generate heat and cause fire .)
- Ensure that the power plug is easily accessible.
- Ensure the earth pin on the power plug is securely connected to prevent electrical shock.
- Do not touch the power plug with a wet hand. (This may cause electrical shock)
- Do not use any power cord other than that provided with this TV. (This may cause fire or electrical shock .)
- Do not damage the power cord. (A damaged cord may cause fire or electrical shock.)
- Do not move the TV with the cord plugged in the socket outlet.
- Do not place a heavy object on the cord or place the cord near a high-temperature object.
- Do not twist the cord, bend it excessively, or stretch it.
- Do not pull on the cord. Hold onto the power plug body when disconnecting cord.
- Do not use a damaged power plug or socket outlet.

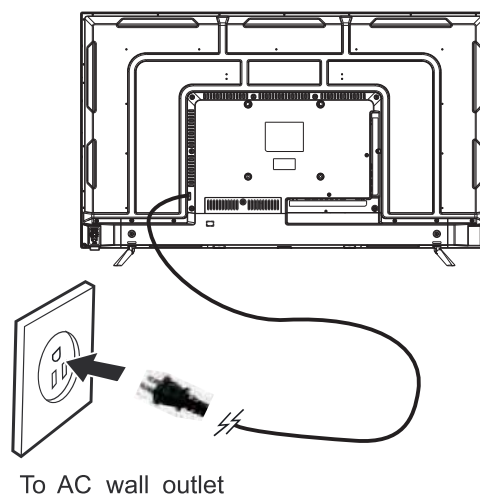

CONNECTIONS

Connection to a Home Theater Audio System

For BEST audio performance

Connecting to a Home Theater System
Dolby Digital can deliver optimal 2 channel stereo or surround sound with five discrete full range channels plus a sixth channel for a subwoofer.

Enjoy optimal sound reproduction from your system with a Dolby Digital amplifier that incorporates a digital optical input. Connect an optional digital cable directly to the television's optical audio output to listen through all inputs except VGA.
(The VGA does not support digital audio)

How To Setup SPDIF Mode

Press the MENU button on the remote control
Press the arrow button to select SPDIF Mode in sound menu.
Press OK button enter the Sub-menu.
Press down ▼ arrow button to select PCM, Auto, Transcode DD or Transcode DDP.
Please set the SPDIF Mode to PCM when using the digital amplifier normally.

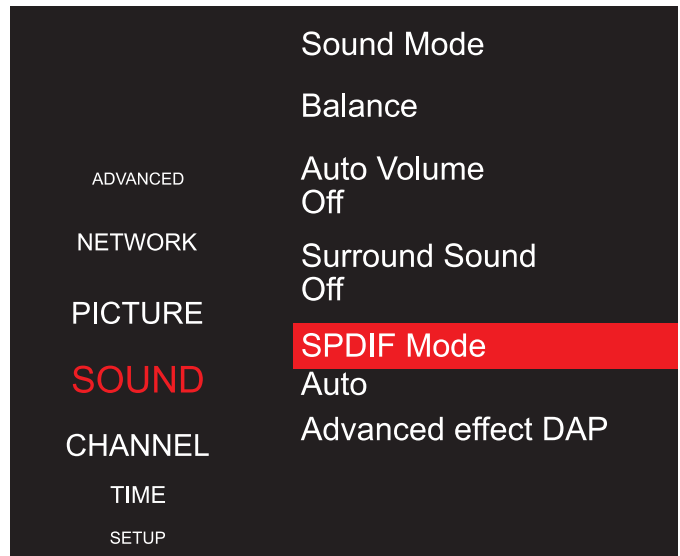
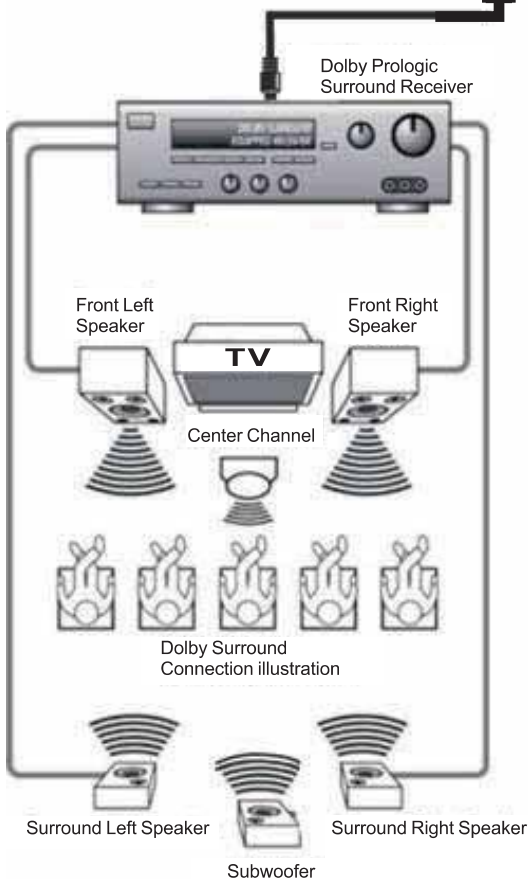
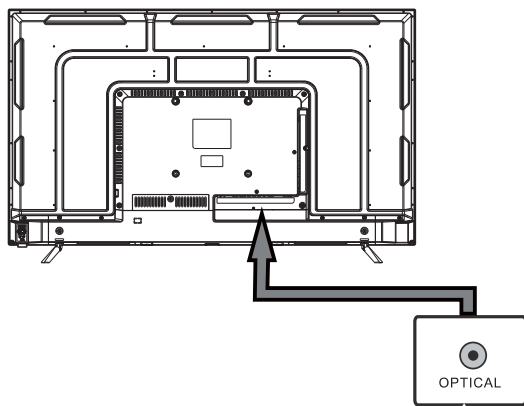

Optional digital cable
(not included)

*NOTE: Refer to the User Manual from your home theater equipment for recommended audio settings.

INITIAL SETUP

PUTTING THE UNIT ON A PROPER PLACE

When you turn on your television set for the first time, be sure to place it on a solid stable surface.

To avoid danger, do not expose the TV to water, or a heat source (e.g. lamp, candle, radiator).

Do not obstruct the ventilation grid at the rear and be sure to leave sufficient gaps around the unit.



TURNING THE UNIT ON FOR THE FIRST TIME

After you have initially connected your TV antenna or cable, turn the television ON. A screen will display asking you to select a Language, Environment, Country, Time Setting, Network Connection, Antenna Type and Auto Tuning.

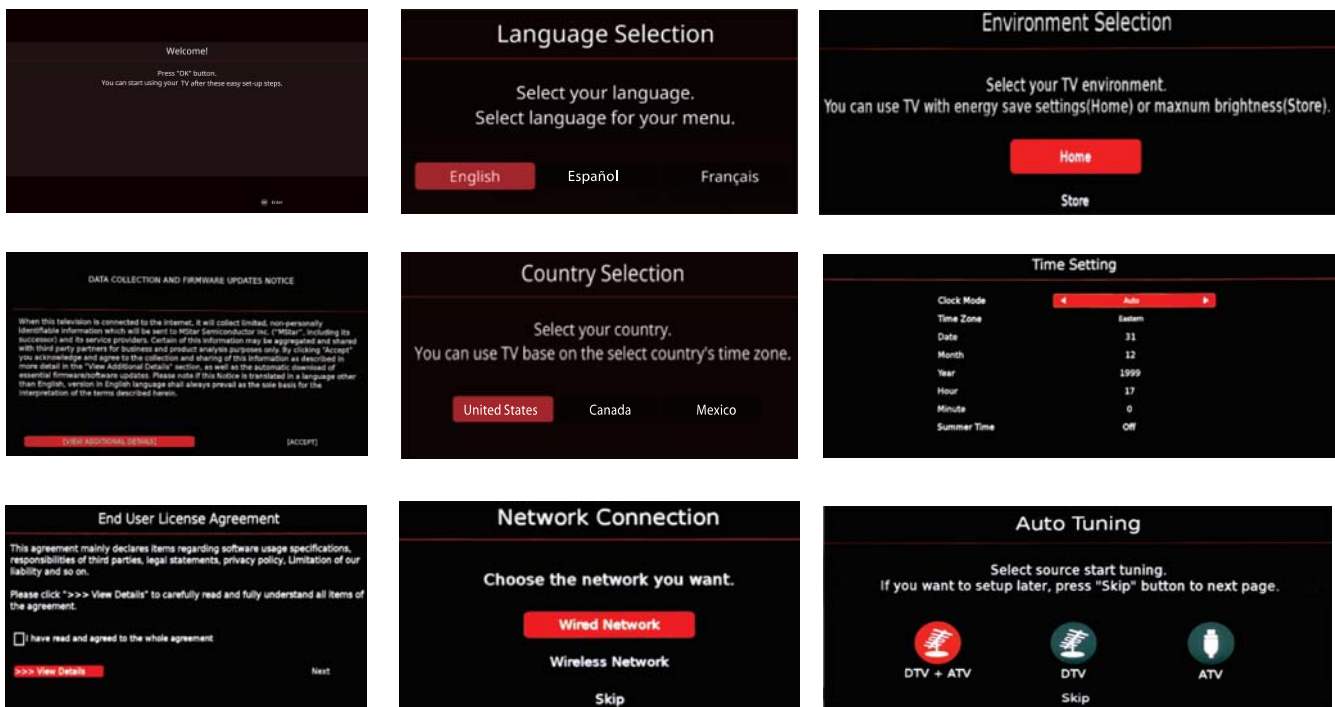

SOURCE SELECTION

1. Press the **SOURCE** button on the remote control.
2. Use the ▲ or ▼ button to select the options (TV,AV,HDMI1,HDMI2,HDMI3) and select any of them using the **OK** button. (The screen will change to your desired source).

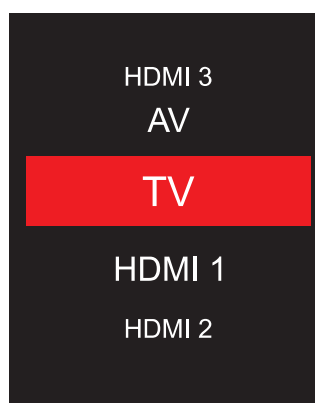

Note:

Before watching please make sure all necessary cables and devices are connected.

Picture Menu

Press **MENU** button to display the main menu.

Press **▲/▼** button to select **PICTURE** in the main menu, it will highlight the option.

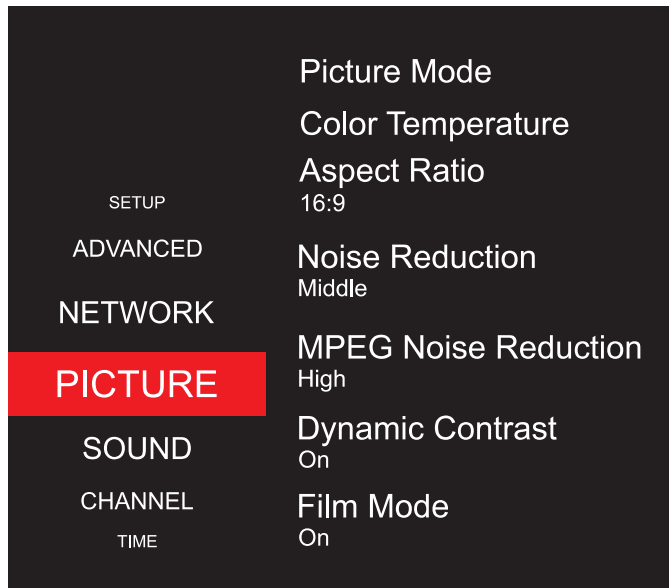

Picture Mode: Choose among Standard, Movie, User and Dynamic/Soccer depending on the region. It will be set to "User" mode automatically when you adjust any of the following six items.

This product is on standard picture mode in default, this is a power saving mode and the picture will be a little dark. Please change the picture mode to the desired mode from this setup menu.

Contrast: Adjust the difference between light and dark areas of the picture.

Brightness: Adjust the lightness of the picture.

Color: Adjust the richness of the picture.

Sharpness: Adjust the edge of the picture.

Tint: (Only for some sources) Adjust the tint value of the color.

Backlight: Adjust the backlight value of the TV screen.

Color Temperature: Select the overall color tone of the picture. Choices are Cool, Nature, Warm and User.

Aspect Ratio: Select the aspect ratio (display proportions) according to your video signal type or preference. Choices are Auto, 4:3, 16:9, Movie or Panorama.

Noise Reduction: Eliminate noise in the picture. Choices are Off, Low, Middle and High.

MPEG Noise Reduction: Eliminate noise generated while creating digital picture signals.

Dynamic Contrast: Turn on or turn off the function of dynamic contrast.

Film Mode: Turn on or turn off the function of film mode.

TV SETUP

Sound Menu

Press **MENU** button to display the main menu.

Press **▲/▼** button to select **SOUND** in the main menu, it will highlight the option.

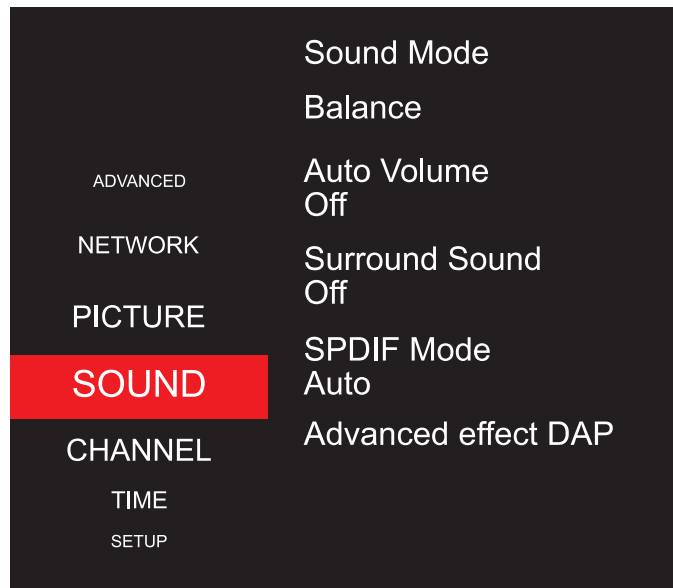

Sound Mode: Choose among Standard, Music, Movie, Soccer and User depending on the region, User. It will be set to "User" mode automatically when you adjust the value of 120Hz, 500Hz, 1.5KHz, 5KHz or 10KHz.

Balance: Control the sound balance between the right and left speaker.

Auto Volume: Turn on to adjust the sound volume depending on the input signal.

Surround Sound: Help to create rich and wider sound from stereo sound sources.

SPDIF Mode: Set the SPDIF sound output mode.

Advanced Effect DAP: Setup the advanced effect of Dolby Audio Processor(Only for some regions).

Channel Menu

Press **MENU** button to display the main menu.

Press **▲/▼** button to select **CHANNEL** in the main menu, it will highlight the option.

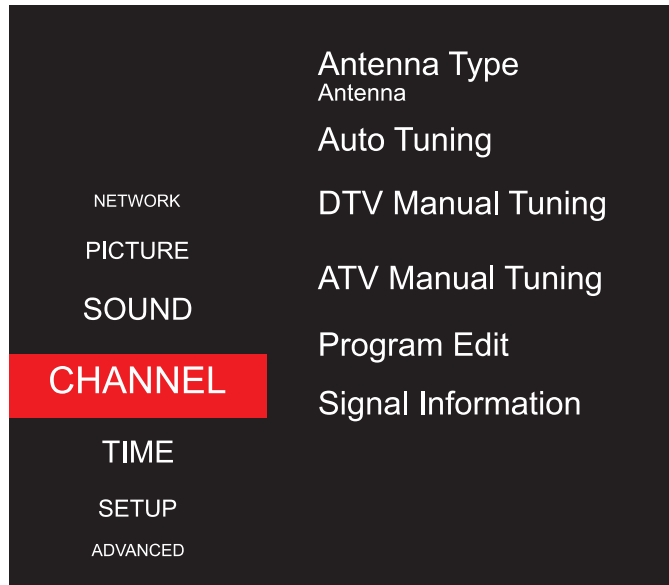

Antenna Type: Select the tuner mode between Antenna and Cable.

Auto Tuning: Select "Auto Tuning" to search the programs automatically. If you want to stop the auto tuning, press EXIT button. Then Select "Yes" to exit searching and "No" to continue searching.

DTV Manual Tuning: Search for the DTV programs manually. The search stops when a program is found and this program will be stored automatically. Press EXIT button to exit the searching. Before DTV manual search, you need to Select the desired UHF CH.

ATV Manual Tuning: Search for the ATV programs manually. When a program is found, press RED button to save it. Before ATV manual tuning, there are related items to be adjusted firstly, which differ by different sources as following instructions.

Program Edit: Edit the programs. You can delete programs, add programs to the favorite list, and so on.

Signal Information: Show the signal information of current DTV channel.

TV SETUP

Time Menu

Press **MENU** button to display the main menu.

Press **▲/▼** button to select **TIME** in the main menu, it will highlight the option.

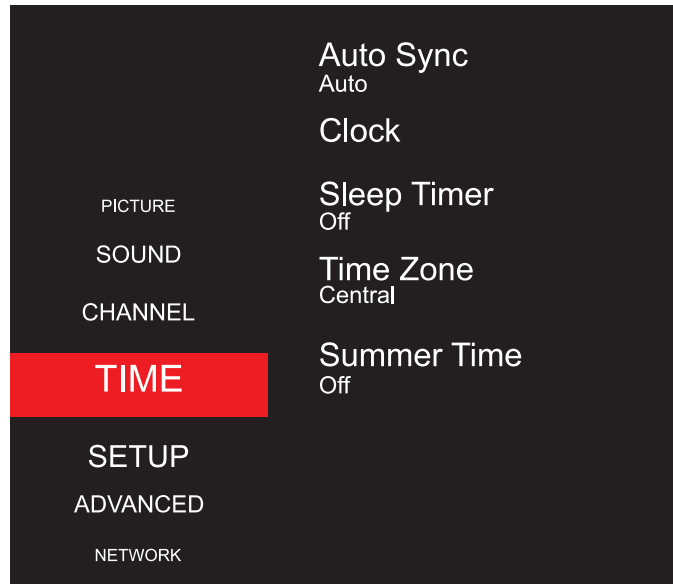

Auto Sync: Select the mode of auto sync to be "Auto" or "Manual".

Clock: Setup the TV clock. It is available only when Auto Sync is set to "Manual".

Sleep Timer: Set to turn off the TV set automatically. Choices are Off, 10, 20, 30, 60, 90, 120, 180 and 240 minutes.

Time Zone: Select the time zone. It is available only when auto sync is set to Auto.

Summer Time: Turn on or turn off the function of Summer Time.

TV SETUP

Setup Menu

Press **MENU** button to display the main menu.

Press **▲/▼** button to select **Setup** in the main menu, it will highlight the option.

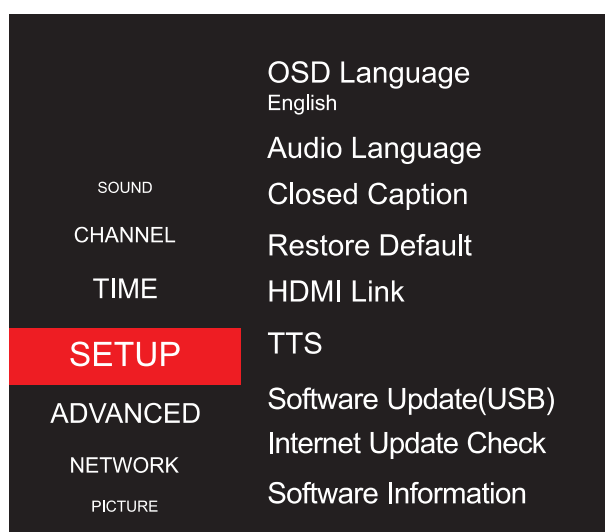

OSD Language: Select your desired OSD language.

Audio Languages: Set the primary or secondary digital audio language corresponding to the signal(Only for some regions).

Closed Caption: Setup the function of Closed Caption. You can set the options you want according to the menu options.

Restore Default: Restore Menu options to the factory defaults, and restart the initial setup.

HDMI Link (HDMI1): Command and control HDMI devices connected to the TV set. Please enter to the setup menu to turn it on.

TTS: Setup the function of Text-to-Sound.

Software Update (USB): Select to update Software from USB.

Internet Update Check: Update the software system by network connection.

Software Information: Show the current software information such as software version, etc.

App Settings: Setup for Netflix app, and show the software version.

Data Collection And Firmware Updates Notice: Read to accept or decline the "DATA COLLECTION AND FIRMWARE UPDATES NOTICE".

E-Manual: Select to enter the E-Manual to check the instructions of basic functions.

HDMI EDID: Switch the version of extended display identification data.

EDID is the information provided by the television to the video source describing the television's display capabilities.

The default setting is EDID1.4. If the HDMI signal device support 4K resolution output, please switch to EDID2.0 to get a better display effect.

LOCATION: Select your TV environment.

Advanced Menu

Press **MENU** button to display the main menu.

Press **▲/▼** button to select advanced in the main menu, it will highlight the option.

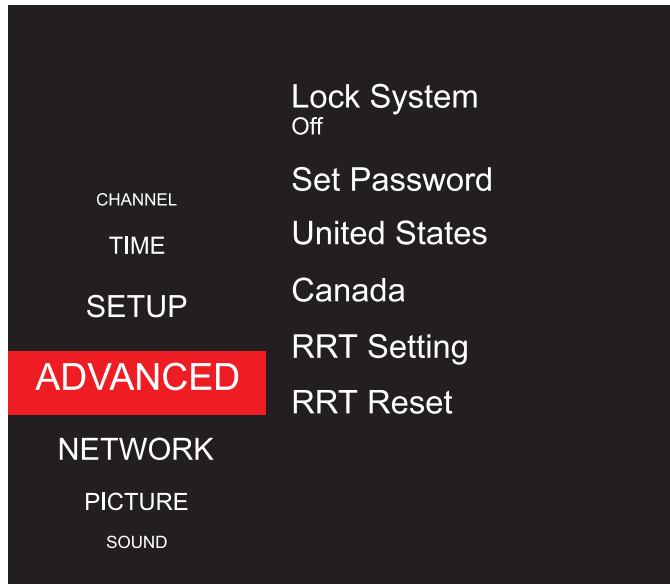

Input the initial password **"0000"** or your own password to access this feature, then press OK button to enter the following features.

Lock System: Select On to enable the following three menu items.

Set Password: Use to change the current Lock Password.

United States: Set united states rating.

Canada: Set canada rating.

RRT Setting: Adjust the settings of RRT(Region Rating Table).

RRT Reset: Reset the RRT settings to the defaults.

Note:

If you change the password and forget it, you can use the super password 8899 to enter the advanced system.

TV SETUP

Network Menu

Press **MENU** button to display the main menu.

Press **▲/▼** button to select Network in the main menu, it will highlight the option.

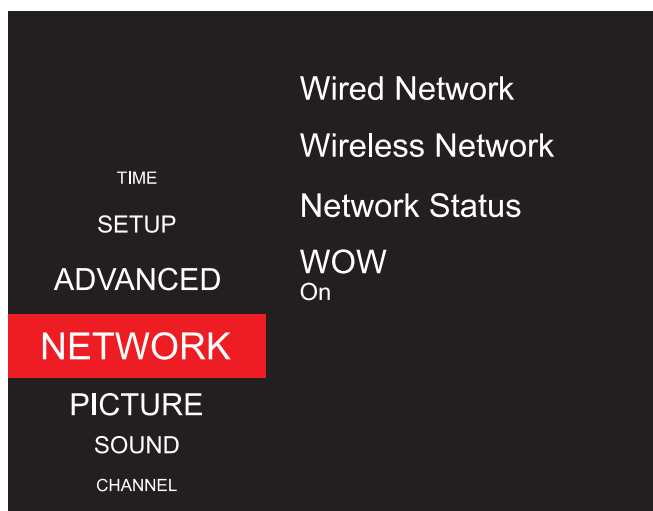

Wired Network:

1. Connect the network cable to the LAN port at the back of the TV.
2. Access main menu and select "NETWORK" sub-menu.
3. Select "Wired Network", and then select "Auto Input", wait a few seconds, the network configuration will be finished successfully.
4. You can also select "Manual Input" to input the network information manually to connect the wired Network.

Wireless Network:

1. Select "Wireless Network" and press OK button.
2. Read to accept or decline the Privacy Policy(Only for some regions).
3. Wait a few seconds, there will show a WLAN list. Select and press OK button to open the interface of inputting password.
4. Use navigation buttons to input the password, when finished, press the green button on the remote control to start the connection.

Network Status: You can check the detailed information of network connection herein.

WOW(Wake on WLAN): Turn on the TV from standby by WLAN connection.

USB Media Player

USB Media Menu

Note: Before operation MEDIA menu, Plug in USB device.

Press arrow button to select "MORE" in the Home Page, press "OK" button to enter sub-menu. Then press ◀/▶ button to select Media Player in this menu. Press "OK" button to enter.

Press ◀/▶ button to select the option you want to adjust in the main Media menu, then press "OK" button to enter.

Support format: JPEG, BMP and PNG for photo,MP3 for music.

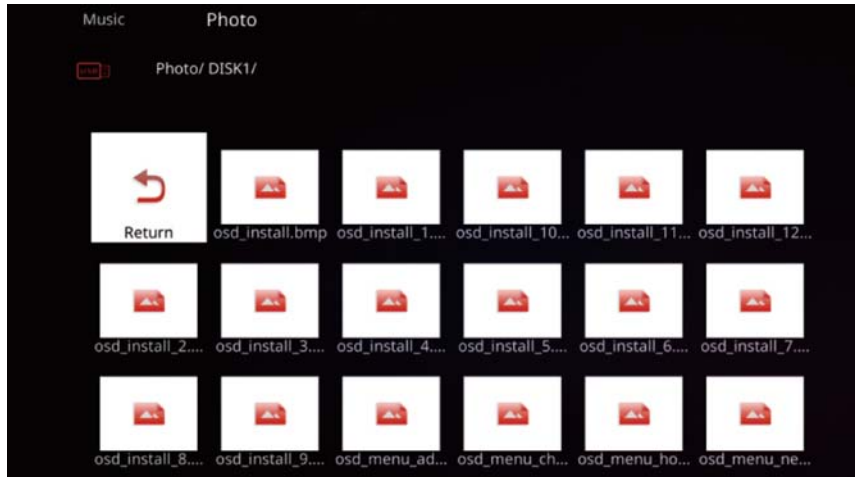

Music Menu

Press ◀/▶ button to select music in the main menu, then press "OK" button to enter.

Press menu button to return back to the previous menu and exit menu to quit.

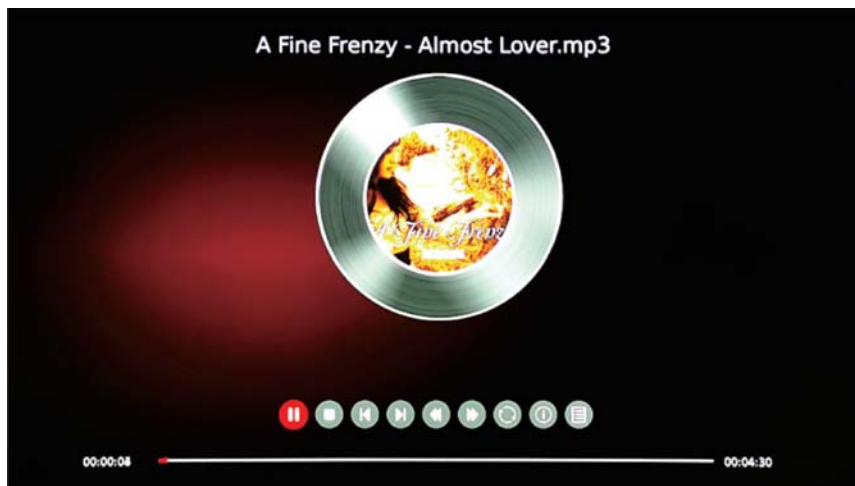

Press ◀/▶ button to select the file you want to listen to music in the file selecting menu, then press "OK" button to start playing, press media button to display and operate file details.

Photo Menu

Press ◀/▶ button to select photo in the main menu, then press “OK” button to enter.
Press menu button to return back to the previous menu and exit menu to quit.

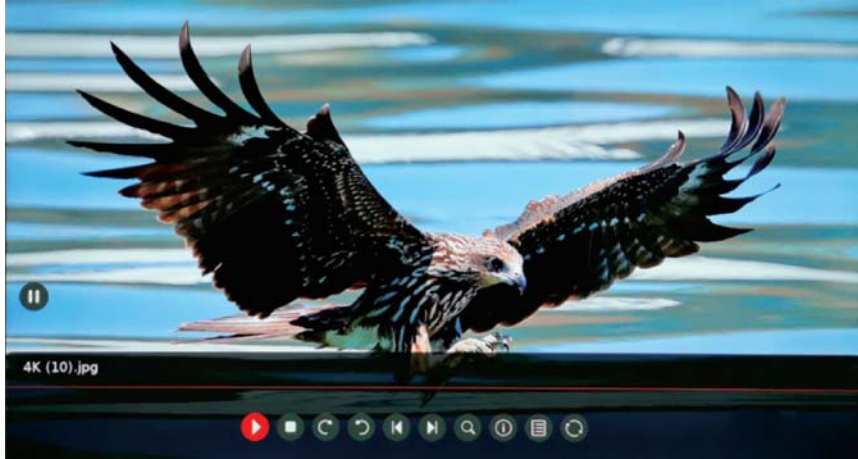

Press ◀/▶ button to select the file you want to watch in the file selecting menu, then press “OK” button to start playing, press media button to display and operate file details.

NOTE: It can not play TEXT and MOVIE format.

Smart TV Operation

Press **HOME** button on the remote control to enter the Main Launcher.

Press the arrow buttons ◀/▶ to select the APP, then press “**OK**” button to enter.

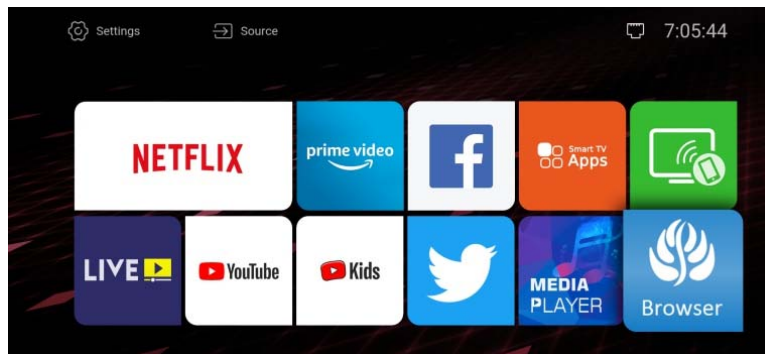

Note: Depending on the country where the TV is installed, certain apps may not be available.

NETFLIX

Press the arrow buttons ◀/▶ to select the netflix, then press “**OK**” button to enter.

After enter the NETFLIX you can see below login interface, input your account and password, press "OK" button, then you can enjoy the NETFLIX resources.



prime video

Press the arrow buttons ◀/▶ to select the Prime video, then press “**OK**” button to enter.

After enter the Prime video you can see below login interface, Complete the relevant operations based on the information on the screen, then you can enjoy the Prime video resources.

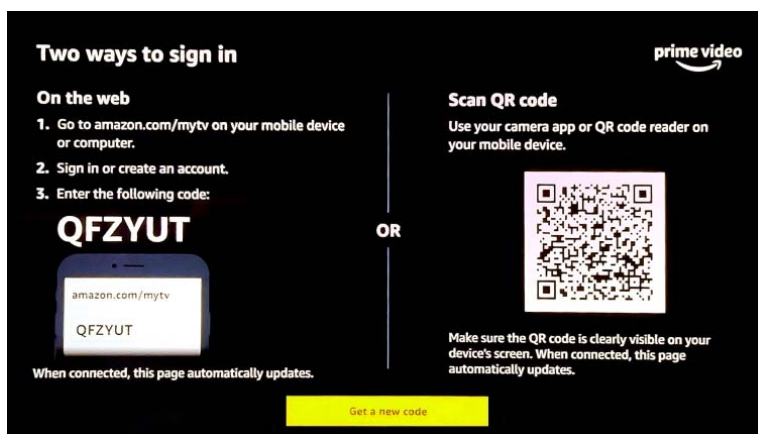

Smart TV Operation



Press the arrow buttons ◀/▶ to select the Facebook, then press “OK” button to enter.

After enter the FACEBOOK you can see below login interface with 8 random code, first pls visit <http://www.facebook.com/device> on your smart phone or computer and enter this code.

Second input your facebook account and password then login in.

Third enter the 8 random code which marked in the first picture. Then you can success to use facebook.

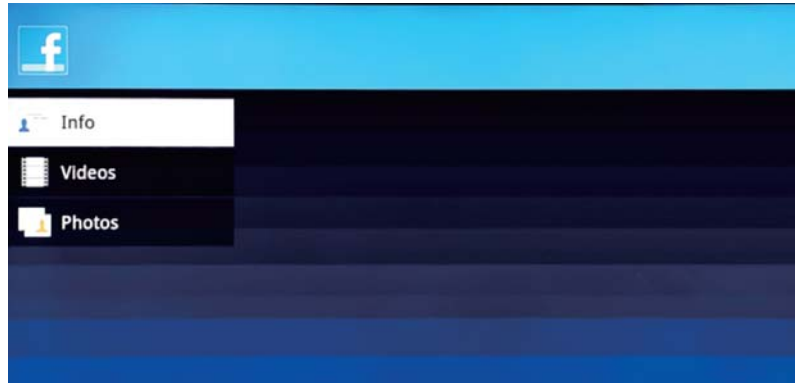

YouTube Press the arrow buttons ◀/▶ to select the Youtube, then press “OK” button to enter.

Use arrow button to select one video and press “OK” key to play. Press “Menu” key to exit playing.

Press the arrow buttons ▲/▼ to open or close control menu when playing.

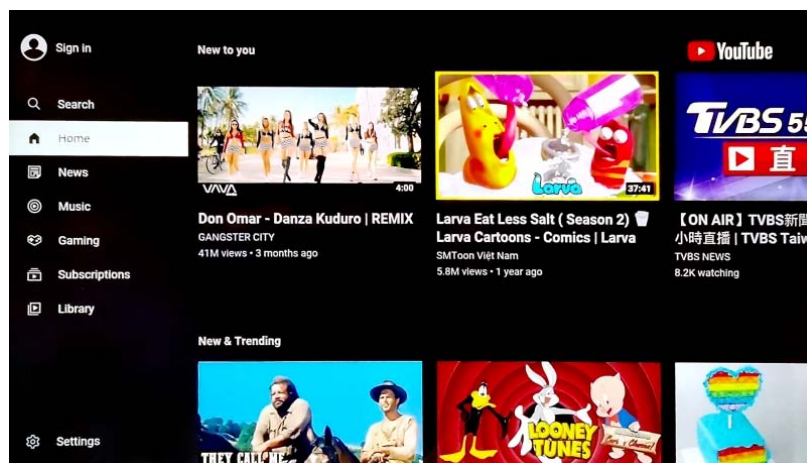

Press the arrow buttons ◀/▶ to select the twitter, then press “OK” button to enter.

After enter the twitter you can see below login interface, input your account and password, press "OK" button, then you can enjoy the twitter resources.

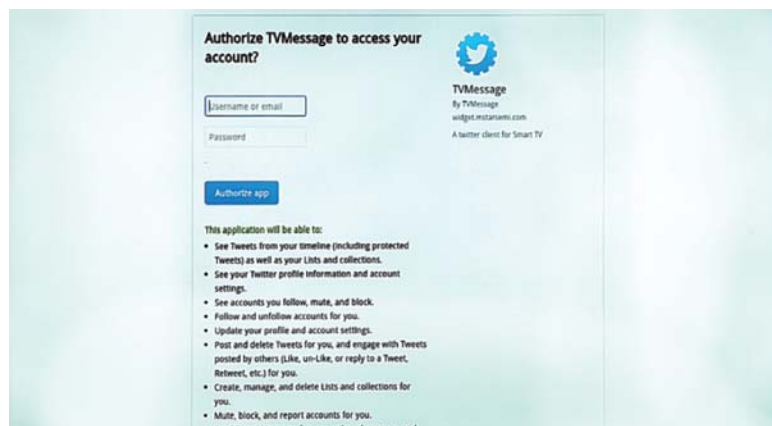

Smart TV Operation

 Press the arrow buttons ◀/▶ to select the Kids, then press “OK” button to enter.

After enter the kids you can see below login interface, You can choose the operation you want according to the screen information.

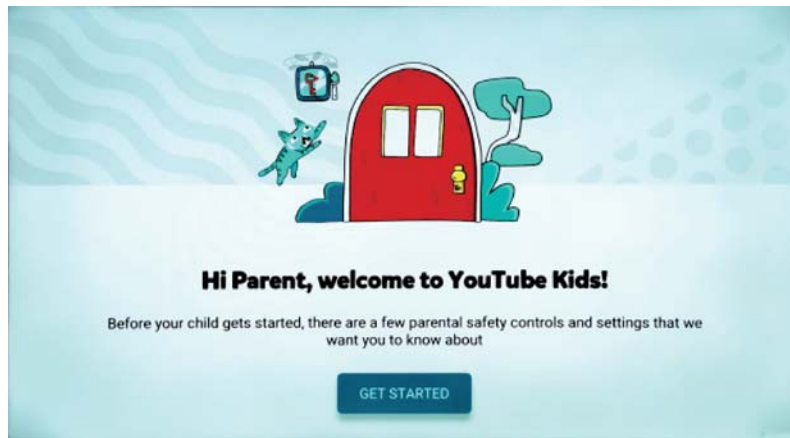

Press the arrow buttons ◀/▶ to select the mirashare, then press “OK” button to enter.

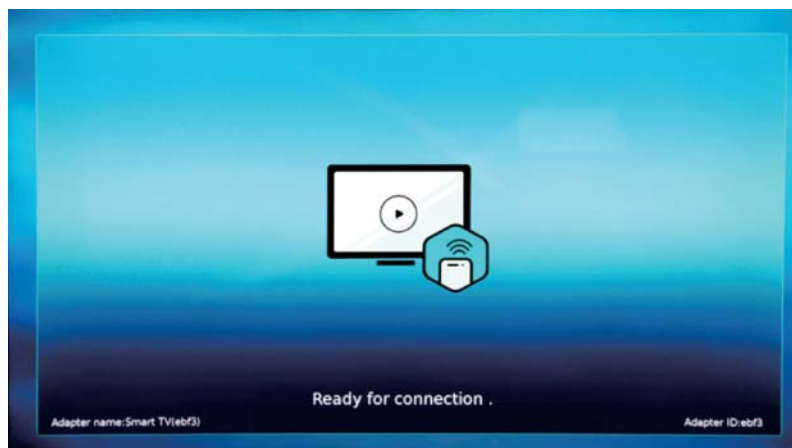

Press the arrow buttons ◀/▶ to select the Browser, then press “OK” button to enter.

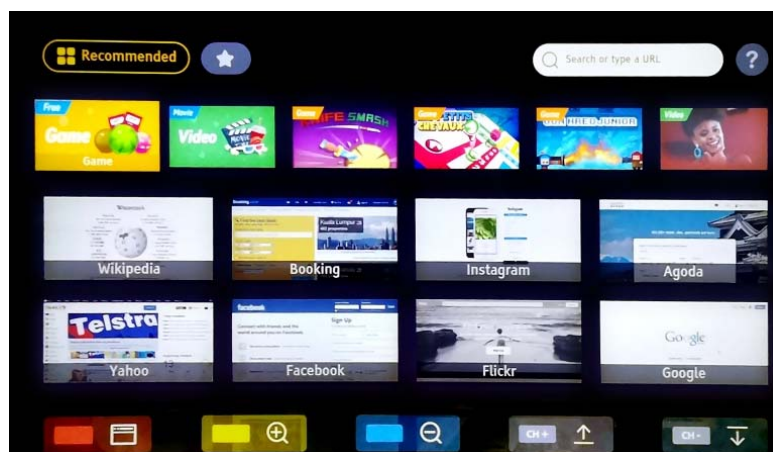

DISPLAY MODE

VIDEO FORMATS

| SUPPORTED COMPONENT / HDMI INPUT MODE | | | |
|---------------------------------------|---------------------------------------|----------------------------------|--------|
| Resolution | Horizontal Scanning Frequency (KHz) | Vertical Scanning Frequency (Hz) | Format |
| 720 X 480 | 15. 73 | 59. 94 | 480 i |
| 720 X 480 | 31. 5 | 59. 94 | 480 p |
| 1280 X 720 | 45 | 60 | 720 p |
| 1920 X 1080 | 33. 75 | 60 | 1080 i |
| 1920 X 1080 | 27 | 24 | 1080 p |
| 1920 X 1080 | 67. 50 | 60 | 1080 p |
| 3840 X 2160 | 53.9 | 24 | 2160p |
| 3840 X 2160 | 67.5 | 30 | 2160p |
| 3840 X 2160 | 134.5 | 60 | 2160p |

NOTE:

The above listed formats are also related to the AV devices you are about to connect. Before you connect this unit with others please read all instructions carefully and make sure all necessary cables are connected.

This unit may be incompatible with some other formats which are not meet the above conditions.

SPECIFICATION

| Model Description | | 50"LED TV |
|----------------------------|-------------------------|--|
| Panel | Panel Type | LED Panel |
| | Diagonal Size | 50inches |
| | Screen Format | 16:9 |
| | Resolution | 3840 x 2160 |
| | Brightness | 250 cd/m ² |
| | Contrast | 900:1 |
| | View Angle | 178(H)/178(V) |
| | Response Time | 8.0ms |
| | Maximum Color | 16.7M colors |
| Systems | Color System | NTSC/ATSC |
| | Sound System | M/N |
| | Sound Output | L/R Speaker: 10W+10W |
| Input / Output Jacks | RF Input | 75 ohm external terminal |
| | HDMI Input | 480i, 480p, 720p, 1080i, 1080p, 2160p. |
| | | HDMI1(2.0), HDMI2(2.0), HDMI3(2.0) |
| | Composite Video Input | 1.0 Vp-p, 75ohms |
| | Sound Input | AV AUDIO: For CVBS/COMPONENT Audio input 500mV rms, Impedance: 20k ohms |
| | Digital audio out | S/PDIF Optical |
| USB Port | Media player | |
| Power | Power Requirement | 100-120V~60Hz |
| | Rated Power Consumption | 82W |

This manual is only for your reference.
Specifications are subject to update without prior notice.

TROUBLESHOOTING GUIDE

SYMPTOM

CAUSE (AND REMEDY)

TV

Bad Picture (snow, multiple images distortion, blurry)

- Check the location of the antenna and adjust it if necessary.
- Make sure the antenna cable is firmly connected.
- Make sure all input cables are firmly connected.

No sound.

- Increase the volume.
- Check whether the mute function has been activated on the Remote Control.

Black and White picture.

- Check the PICTURE setting within the PICTURE menu.
- Check to make sure the program you are watching is broadcast in Color and not Black & White.

No picture or sound.

- Make sure the unit is plugged in and turned on.
- Make sure that the ATV mode is selected.
- Try a new channel to check for possible station trouble.
- Make sure the antenna is connected properly.
- Increase the volume.
- Make sure the antenna or audio/video source device is working properly.
- Make sure all cables are firmly connected.
- Check for local interference.

Colored patches of picture.

- Make sure there are no unshielded electrical devices nearby that are causing interference.
- Turn the TV off for 30 minutes, then try it again.

Panel function key does not respond correctly.

- Under the influence of electrostatic phenomenon, the product may malfunction and require user power reset.
- Unplug and re-plug the AC power cord.

The display monitor's panel goes hot.

- LED TV takes inside light phosphor. It may increase the temperature of the screen in some occasions. It's not a defect.

Unusual dots

- Black dots and Bright points may appear on the LED screen. This is a structural property of the LED panel and is not a defect.

Stripes on screen

- Adjust the impulse phase may decrease stripes. RGB in

The top of the monitor gets hot.

- It may occur during long-time working. It's not a defect.

Unable to select a certain channel.

- The channel may be skipped. Choose this channel by directly selecting the buttons from the remote control.

Disorder display at power on.

- This may be caused because of a very short interval between POWER OFF and ON.
- Unplug the power and restart.

To make a warranty claim, please email support@curtiscs.com or call 1-800-968-9853.

1 Year Warranty

This product is warranted to be free from defects in material and workmanship for a period of one (1) year from the date of original purchase. During this period, your exclusive remedy is repair or replacement of this product or component found to be defective, at our option; however, you are responsible for all costs associated with returning the product to us. If the product or component is no longer available, we will replace with a similar one of equal or greater value. Prior to a replacement being sent, the product must be rendered inoperable or returned to us.

This warranty does **not** cover glass, filters, wear from normal use, use not in conformity with the printed directions., or damage to the product resulting from accident, alteration, abuse, or misuse. This warranty extends only to the original consumer purchaser or gift recipient. Keep the original sales receipt, as proof of purchase is required to make a warranty claim. This warranty is void if the product is used for other than single-family household use or subjected to any voltage and waveform other than as on the specified rating on the label (e.g., 120V~60Hz).

We exclude all claims for special, incidental, and consequential damages caused by breach of express or implied warranty. All liability is limited to the amount of the purchase price. **Every implied warranty, including any statutory warranty or condition of merchantability or fitness for a particular purpose, is disclaimed except to the extent prohibited by law, in which case such warranty or condition is limited to the duration of this written warranty.** This warranty gives you specific legal rights. You may have other legal rights that vary depending on where you live. Some states or provinces do not allow limitations on implied warranties or special, incidental, or consequential damages, so the foregoing limitations may not apply to you.

For faster service, locate the model, type, and serial numbers on your appliance.

90 Day Warranty

Remote controls are warranted from date of purchase for a period of ninety (90) days, provided remote has been used as intended and free from damage.

ATTACH YOUR PROOF OF PURCHASE HERE, PROOF OF PURCHASE IS REQUIRED TO OBTAIN WARRANTY SERVICE.

Please have the following information available when you contact the Support Team:

- Name, address and telephone number.
- Model number and serial number.
- A clear, detailed description of the problem.
- Proof of purchase including dealer or retailer name, address and date of purchase.



MANUEL D'UTILISATION

Avant d'utiliser le TV, veuillez lire attentivement ce manuel et le conserver pour référence ultérieure.



Model: RQSM5022-B



'Ce produit a été fabriqué et vendu sous la responsabilité de Curtis International Ltd. RCA, le logo RCA, le logo des deux chiens (Nipper et Chipper), sont des marques déposées ou des marques commerciales de Technicolor (S.A.) ou de ses affiliés et sont utilisés sous licence par Curtis International Ltd. Tout autre produit, service, société, nom commercial ou produit et logo référencés ici ne sont ni approuvés ni sponsorisés par Technicolor (S.A.) ou ses affiliés.'

CONTENU

| | | | |
|---|--|--|----|
| 1 | MISES EN GARDE DE SÉCURITÉ | | 1 |
| 2 | CONSIGNES DE SÉCURITÉ IMPORTANTES | | 2 |
| 3 | ACCESSOIRES | | 3 |
| 4 | PRÉPARATIF | | 3 |
| 5 | GUIDE DE RÉFÉRENCE DES COMMANDES | Télécommande | 4 |
| | | Vue De Devant | 5 |
| | | Vue Arriere | 5 |
| | | Vue Arriere | 6 |
| 6 | MONTAGE MURAL | | 7 |
| 7 | CONNEXIONS | Installation | 8 |
| | | Connexion Antenne | 9 |
| | | Connexion AV | 9 |
| | | Connexion HDMI | 10 |
| | | Branchement du cordon d'alimentation | 10 |
| | | Connexion Optical audio output | 11 |
| 8 | INSTALLATION RAPIDE | Mise De L'appareil Dans Une Place Propre | 12 |
| | | Mise En Circuit Initiale De L'Appareil | 12 |
| | | Selection De Source | 12 |
| 9 | RÉGLAGE INITIAL DU TÉLÉVISEUR | Menu Image | 13 |
| | | Menu Son | 14 |
| | | Menu Canal | 15 |
| | | Menu horaire | 16 |
| | | Menu des paramètres | 17 |
| | | Menu avancé | 18 |
| | | Menu Réseau | 19 |

CONTENU

| | | | |
|----|--|---------------|----|
| 10 | Lecture Média USB | | 20 |
| 11 | OPÉRATION DE TV INTELLIGENT | | 22 |
| 12 | MODE D'AFFICHAGE | Formats Vidéo | 25 |
| 13 | CARACTÉRISTIQUES | | 26 |
| 14 | GUIDE DE PANNAGE | Symptôme TV | 27 |
| 15 | GÂRÂNTIE LIMITÉE | | 28 |

** Les images, fonctions et autres informations fournies dans ce manuel sont fournies à titre indicatif. S'il ne correspond pas à l'objet réel, veuillez vous reporter au produit réel.*
