

Test Report of FCC CFR 47 Part 15 Subpart C

On Behalf of

SHENZHEN QIYUE OPTRONICS COMPANY LIMITED

FCC ID: XOMIPD40B240
Product Description: 40"LED LCD FULL HD SMART TV
Model No.: SLD40HG45RQ
Supplementary Model: SLD40XXXXXXXXXXXXXXXX, D395RWB240-F-A-I,
D395XXXXXXXXXXXXXXXX, (Where "X"can be any alphanumeric
of a-z, A-Z or 0-9 or blank or -)
Brand Name: RCA
Prepared for: SHENZHEN QIYUE OPTRONICS COMPANY LIMITED
Flat3,Tower 3, Excellence Meilin Center Plaza, Zhongkang Road
128, Shangmeilin, Futian District, Shenzhen, China
Prepared by: Shenzhen Hongcai Testing Technology Co., Ltd.
1st-3rd Floor,Building C,Shuanghuan Xin Yi Dai Hi-Tech Industrial
Park,No.8 Baoqing Road,Baolong Industrial Zone,Longgang
District, Shenzhen, Guangdong, China
Tel: 86-755-86337020
Fax: 86-755-86337028
Report No.: HCT15GR035E
Issue Date: July 20, 2015
Test Date: July 10~17, 2015

Tested by:



Jiankuai.Li

Reviewed by:

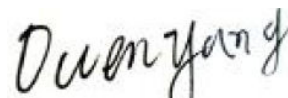

Owen Yang

Approved by:

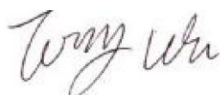

Tony Wu

TABLE OF CONTENTS

1. GENERAL INFORMATION.....	4
1.1 PRODUCT DESCRIPTION FOR EQUIPMENT UNDER TEST (EUT).....	4
1.2 TEST STANDARDS.....	5
1.3 TEST FACILITY.....	5
2. SYSTEM TEST CONFIGURATION.....	6
2.1 EUT CONFIGURATION.....	6
2.2 EUT EXERCISE.....	6
2.3 GENERAL TEST PROCEDURES.....	6
2.4 MEASUREMENT UNCERTAINTY.....	6
2.5 LIST OF MEASURING EQUIPMENTS USED.....	7
3. SUMMARY OF TEST RESULTS.....	8
4. TEST OF AC POWER LINE CONDUCTED EMISSION.....	9
4.1 APPLICABLE STANDARD.....	9
4.2 TEST SETUP DIAGRAM.....	9
4.3 TEST RESULT.....	9
5. TEST OF MAXIMUM PEAK OUTPUT POWER.....	12
5.1 APPLICABLE STANDARD.....	12
5.2 EUT SETUP.....	12
5.3 TEST EQUIPMENT LIST AND DETAILS.....	12
5.4 TEST PROCEDURE.....	12
5.5 TEST RESULT.....	13
6. TEST OF PEAK POWER SPECTRAL DENSITY.....	23
6.1 APPLICABLE STANDARD.....	23
6.2 EUT SETUP.....	23
6.3 TEST EQUIPMENT LIST AND DETAILS.....	23
6.4 TEST PROCEDURE.....	23
6.5 TEST RESULT.....	23
7. TEST OF 6DB BANDWIDTH.....	33
7.1 APPLICABLE STANDARD.....	33
7.2 EUT SETUP.....	33
7.3 TEST EQUIPMENT LIST AND DETAILS.....	33
7.4 TEST PROCEDURE.....	33
7.5 TEST RESULT.....	33
8. TEST OF CONDUCTED SPURIOUS EMISSION.....	43
8.1 APPLICABLE STANDARD.....	43
8.2 EUT SETUP.....	43
8.3 TEST EQUIPMENT LIST AND DETAILS.....	43
8.4 TEST PROCEDURE.....	43
8.5 TEST RESULT.....	43
9. TEST OF RADIATED SPURIOUS EMISSION.....	50
9.1 RADIATED SPURIOUS EMISSION.....	50
9.1.1 LIMITS.....	50
9.1.2 EUT SETUP.....	51
9.1.3 TEST PROCEDURE.....	52
9.1.4 TEST RESULT.....	52
10. TEST OF BAND EDGES EMISSION.....	66
10.1 APPLICABLE STANDARD.....	66
10.2 EUT SETUP.....	66
10.3 TEST EQUIPMENT LIST AND DETAILS.....	66
10.4 TEST PROCEDURE.....	66
10.5 TEST RESULT.....	67
11. ANTENNA REQUIREMENT.....	73

11.1 STANDARD APPLICABLE..... 73
11.2 ANTENNA CONNECTED CONSTRUCTION 73
12 .RADIO FREQUENCY EXPOSURE..... 74
12.1 OBJECTIVE..... 74
12.2 GENERAL DESCRIPTION OF TEST..... 74
1.3 HUMAN EXPOSURE ASSESSMENT RESULTS..... 75

1. GENERAL INFORMATION

1.1 Product Description for Equipment Under Test (EUT)

Client Information

Applicant:	SHENZHEN QIYUE OPTRONICS COMPANY LIMITED
Address of Applicant:	Flat3,Tower 3, Excellence Meilin Center Plaza, Zhongkang Road 128, Shangmeilin, Futian District, Shenzhen, China
Manufacturer:	SHENZHEN QIYUE OPTRONICS COMPANY LIMITED BRANCH
Address of Manufacturer:	SEIYU INDUSTRIAL PARK, DA SAN VILLAGE, DA SHUI KENG, GUANLAN TOWN, LONGHUA NEW DISTRICT, SHENZHEN, P.R.C

General Description of E.U.T

Items	Description
EUT Description:	40" LED LCD FULL HD SMART TV
Trade Name:	RCA
Model No.:	SLD40HG45RQ
Supplementary Model:	SLD40XXXXXXXXXXXXXXXXX, D395RWB240-F-A-I, D395XXXXXXXXXXXXXXXXX, (Where "X" can be any alphanumeric of a-z, A-Z or 0-9 or blank or -)
Frequency Band:	IEEE 802.11b / g: 2412MHz~2462MHz, IEEE 802.11n HT20 : 2412MHz~2462MHz, IEEE 802.11n HT40 : 2422MHz~2452MHz
Channel Spacing:	IEEE 802.11b/g, 802.11n HT20/HT40: 5MHz
Number of Channels:	IEEE 802.11b, g , HT20:11 Channels; IEEE 802.11n HT40:7 Channels
Transmit Data Rate:	maximum of 150Mbps
Type of Modulation:	IEEE 802.11b: DSSS (CCK, DQPSK, DBPSK) IEEE 802.11g: OFDM (64QAM, 16QAM, QPSK, BPSK) IEEE 802.11n HT20/40: OFDM (64QAM, 16QAM, QPSK, BPSK)
Antenna Type:	Integral Antenna
Antenna Gain:	2.2dBi
Power Supply:	Input: AC 100-120V 60Hz 58W
Adapter Information:	N/A

Remark: * The test data gathered are from the production sample provided by the manufacturer.
*Supplementary models have the same circuit, only the appearance different.

1.2 Test Standards

The tests were performed based on the Electromagnetic Interference (EMI) tests performed on the EUT. Both conducted and radiated testing were performed according to the procedures in ANSI C63.4 – 2003 Radiated testing was performed at an antenna to EUT distance 3 meters.

The tests were performed in order to determine compliance with FCC Part 15, Subpart C, and section 15.203, 15.207, 15.209 and 15.247 rules and the FCC publication KDB558074 of Guidance on Measurements for Digital Transmission Systems (47 CFR 15.247).

1.3 Test Facility

All measurement required was performed at laboratory of Shenzhen CTL Testing Technology Co., Ltd. at Floor1-A, Baisha Technology Park, No.3011 Shahexi Road, Nanshan District, Shenzhen, China

The test facility is recognized, certified, or accredited by the following organizations:

FCC – Registration No.: 970318

Shenzhen CTL Testing Technology Co., Ltd. EMC Laboratory has been registered and fully described in a report filed with the (FCC) Federal Communications Commission. The acceptance letter from the FCC is maintained in our files. Registration 970318, December, 2013.

2. SYSTEM TEST CONFIGURATION

2.1 EUT Configuration

The EUT configuration for testing is installed on RF field strength measurement to meet the Commissions requirement and operating in a manner that intends to maximize its emission characteristics in a continuous normal application.

2.2 EUT Exercise

The calibrated antennas used to sample the radiated field strength are mounted on a non-conductive, motorized antenna mast 3 or 10 meters from the leading edge of the turntable.

Support equipments or special accessories in test configuration:

AUX Description:	Manufacturer	Model No.	Certificate	CABLE
Host Computer	Dell	78MD82X	CE, FCC	1.5m Unshielded Power Cord
Monitor	Dell	E178Pc	CE, FCC	1.5m Unshielded Power Cord 1.8m shielded data Cable with core
Keyboard	Dell	L100	CE, FCC	1.8m shielded data Cable with core
Mouse	Dell	OCJ339	CE, FCC	1.8m shielded data Cable with core
Printer	EPSON	P330A	CE, FCC	1.2m Unshielded Power Cord 1.5m shielded data Cable

2.3 General Test Procedures

Conducted Emissions:The EUT is placed on the turntable, which is 0.8 m above ground plane. According to the requirements in Section 7.1 of ANSI C63.4-2003 Conducted emissions from the EUT measured in the frequency range between 0.15 MHz and 30MHz using CISPR Quasi-Peak detector mode.

Radiated Emissions: The EUT is a placed on as turntable, which is 0.8 m above ground plane. The turntable shall rotate 360 degrees to determine the position of maximum emission level. EUT is set 3m away from the receiving antenna, which varied from 1m to 4m to find out the highest emission. And also, each emission was to be maximized by changing the polarization of receiving antenna both horizontal and vertical. In order to find out the maximum emissions, exploratory radiated emission measurements were made according to the requirements in Section 13.1.4.1 of ANSI C63.4-2003.

2.4 Measurement Uncertainty

Where relevant, the following measurement uncertainty levels have been estimated for tests performed on the apparatus:

Parameter	Uncertainty
Power Line Conducted Emission	+/- 2.3 dB
Radiated Emission	+/- 3.4 dB

Uncertainty figures are valid to a confidence level of 95%.

2.5 List of Measuring Equipments Used

Test equipments list of Shenzhen Hongcai Testing Technology Co., Ltd.

No.	Instrument no.	Equipment	Manufacturer	Model No.	S/N	Last Calculator	Due Calculator
1	BCT-EMC001	EMI Test Receiver	R&S	ESCI	100687	2015-4-16	2016-4-17
2	BCT-EMC002	EMI Test Receiver	R&S	ESPI	100097	2014-11-1	2015-10-31
3	BCT-EMC003	Amplifier	HP	8447D	1937A02492	2015-4-19	2016-4-18
4	BCT-EMC004	Single Power Conductor Module	R&S	NNBM 8124	242	2015-4-19	2016-4-18
5	BCT-EMC005	Single Power Conductor Module	R&S	NNBM 8124	243	2015-4-19	2016-4-18
6	BCT-EMC006	Power Clamp	SCHWARZBECK	MDS-21	3812	2014-11-5	2015-11-4
7	BCT-EMC007	Positioning Controller	C&C	CC-C-1F	MF7802113	N/A	N/A
8	BCT-EMC008	Electrostatic Discharge Simulator	TESEQ	NSG437	125	2015-11-2	2016-11-1
9	BCT-EMC009	Fast Transient Burst Generator	SCHAFFNER	MODULA6150	34572	2015-4-16	2016-4-17
10	BCT-EMC010	Fast Transient Noise Simulator	Noiseken	FNS-105AX	10501	2014-6-26	2015-6-25
11	BCT-EMC011	Color TV Pattern Generator	PHILIPS	PM5418	TM209947	N/A	N/A
12	BCT-EMC012	Power Frequency Magnetic Field Generator	EVERFINE	EMS61000-8K	608002	2015-4-16	2016-4-17
14	BCT-EMC014	Capacitive Coupling Clamp	TESEQ	CDN8014	25096	2015-4-16	2016-4-17
15	BCT-EMC015	High Field Biconical Antenna	ELECTRO-METRICS	EM-6913	166	2014-11-28	2015-11-27
16	BCT-EMC016	Log Periodic Antenna	ELECTRO-METRICS	EM-6950	811	2014-11-28	2015-11-27
17	BCT-EMC017	Remote Active Vertical Antenna	ELECTRO-METRICS	EM-6892	304	2014-11-28	2015-11-27
18	BCT-EMC018	TRILOG Broadband Test-Antenna	SCHWARZBECK	VULB9163	9163-324	2014-5-19	2015-5-18
19	BCT-EMC019	Horn Antenna	SCHWARZBECK	BBHA9120A	0499	2014-11-28	2015-11-27
20	BCT-EMC020	Teo Line Single Phase Module	SCHWARZBECK	NSLK8128	8128247	2014-11-1	2015-10-31
21	BCT-EMC021	Triple-Loop Antenna	EVERFINE	LLA-2	711002	2014-11-15	2015-11-14
22	BCT-EMC022	Electric bridge	Jhai	JK2812C	803024	N/A	N/A
23	BCT-EMC026	RF POWER AMPLIFIER	FRANKONIA	FLL-75	1020A1109	2015-4-17	2016-4-16
24	BCT-EMC027	CDN	FRANKONIA	CDN M2+M3	A3027019	2015-4-17	2016-4-16

25	BCT-EMC029	6DB Attenuator	FRANKONIA	N/A	1001698	2015-4-17	2016-4-16
26	BCT-EMC030	EM Injection clamp	FCC	F-203I-23mm	091536	2015-4-16	2016-4-17
27	BCT-EMC031	9kHz-2.4GHz signal generator 2024	MARCONI	10S/6625-99-457-8730	112260/042	2015-4-16	2016-4-17
28	BCT-EMC032	10dB attenuator	ELECTRO-METRICS	EM-7600	836	2015-4-16	2016-4-17
29	BCT-EMC033	ISN	TESEQ	ISN-T800	30301	2014-11-15	2015-11-14
30	BCT-EMC034	10KV surge generator	SANKI	SKS-0510M	048110003E321	2014-11-01	2015-10-31
31	BCT-EMC035	HRMONICS&FLICKRE ANALYSER	VOLTECH	PM6000	200006700433	2014-11-20	2015-11-19
32	BCT-EMC036	Spectrum Analyzer	R&S	FSP	100397	2014-11-1	2015-10-31
33	BCT-EMC037	Broadband preamplifier	SCHWARZBECK	BBV9718	9718-182	2015-4-19	2016-4-18

3. SUMMARY OF TEST RESULTS

FCC Rules	Description of Test	Result
FCC §15.207	AC Power Line Conducted Emission	Pass
FCC §15.247(b)	Maximum Peak Output Power	Pass
FCC §15.247(e)	Power Spectral Density	Pass
FCC §15.247(a)	6dB Bandwidth	Pass
FCC §15.247 (d)	Conducted Spurious Emission	Pass
FCC §15.205 and §15.209	Radiated Spurious Emission	Pass
FCC §15.203/15.247(b)/(c)	Antenna Requirement	Pass

4. TEST OF AC POWER LINE CONDUCTED EMISSION

4.1 Applicable Standard

Refer to FCC §15.207.

For a Low-power Radio-frequency Device is designed to be connected to the AC power line, the radio frequency voltage that is conducted back onto the AC power line on any frequency or frequencies within the band 150 kHz to 30 MHz shall not exceed below limits table.

Frequency Range (MHz)	Limits (dBuV)	
	Quasi-Peak	Average
0.150~0.500	66~56	56~46
0.500~5.000	56	46
5.000~30.00	60	50

4.2 Test Setup Diagram

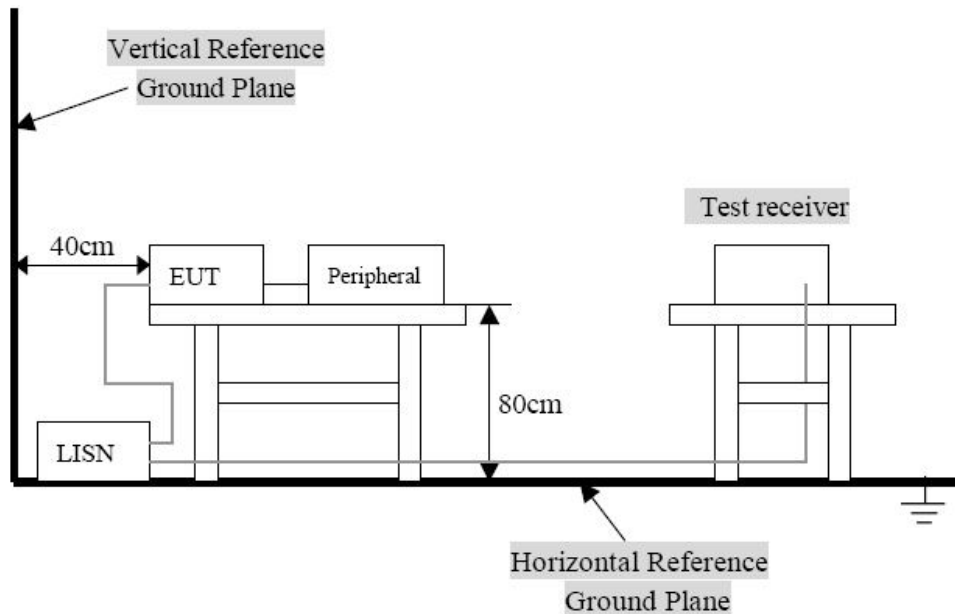

Remark: The EUT was connected to a 120 VAC/ 60Hz power source.

4.3 Test Result

Temperature (°C) : 23~25	EUT: 40" LED LCD FULL HD SMART TV
Humidity (%RH) : 45~58	M/N: SLD40HG45RQ
Barometric Pressure (mbar) : 950~1000	Operation Condition: Tx Mode

Conducted Emission:

EUT: 40"LED LCD FULL HD SMART TV
M/N: SLD40HG45RQ
Operating Condition: Tx Mode
Test Site: Shielded Room
Operator: Yang
Test Specification: AC 120V/60Hz
Comment: L Line

SCAN TABLE: "Voltage (9K-30M) FIN"
Short Description: 150K-30M Voltage

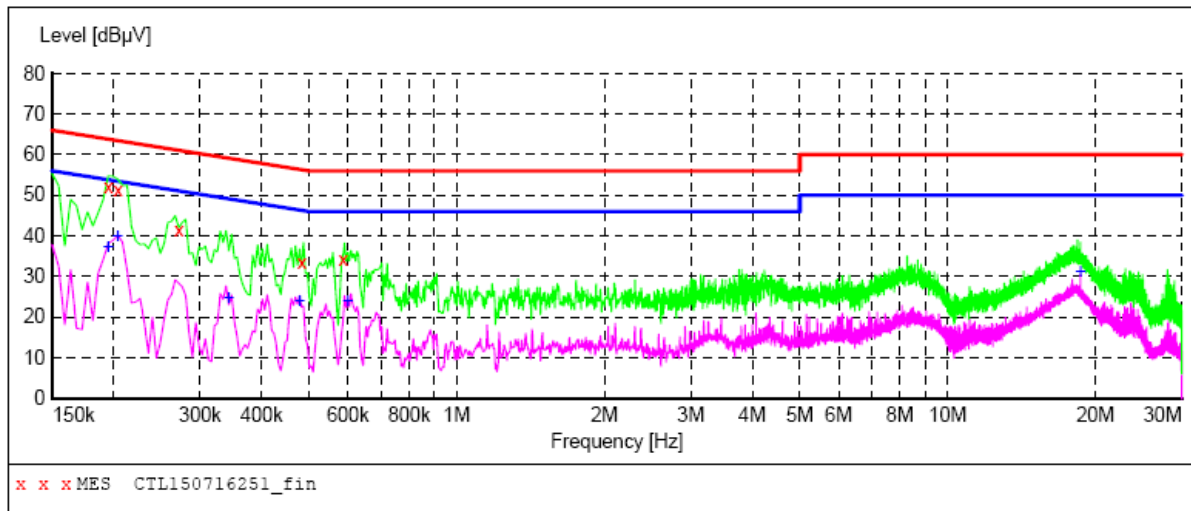

MEASUREMENT RESULT: "CTL150716251_fin"

7/16/2015 11:13AM

Frequency MHz	Level dBµV	Transd dB	Limit dBµV	Margin dB	Detector	Line	PE
0.195001	52.30	10.2	64	11.5	QP	L1	GND
0.204001	51.40	10.2	63	12.0	QP	L1	GND
0.271501	41.30	10.2	61	19.8	QP	L1	GND
0.483001	33.40	10.2	56	22.9	QP	L1	GND
0.586501	34.20	10.2	56	21.8	QP	L1	GND

MEASUREMENT RESULT: "CTL150716251_fin2"

7/16/2015 11:13AM

Frequency MHz	Level dBµV	Transd dB	Limit dBµV	Margin dB	Detector	Line	PE
0.195001	37.40	10.2	54	16.4	AV	L1	GND
0.204001	40.10	10.2	53	13.3	AV	L1	GND
0.343501	24.60	10.2	49	24.5	AV	L1	GND
0.478501	24.00	10.2	46	22.4	AV	L1	GND
0.600001	24.00	10.2	46	22.0	AV	L1	GND
18.649501	31.10	10.9	50	18.9	AV	L1	GND

Conducted Emission:

EUT: 40"LED LCD FULL HD SMART TV
M/N: SLD40HG45RQ
Operating Condition: Tx Mode
Test Site: Shielded Room
Operator: Yang
Test Specification: AC 120V/60Hz
Comment: N Line

SCAN TABLE: "Voltage (9K-30M)FIN"
Short Description: 150K-30M Voltage

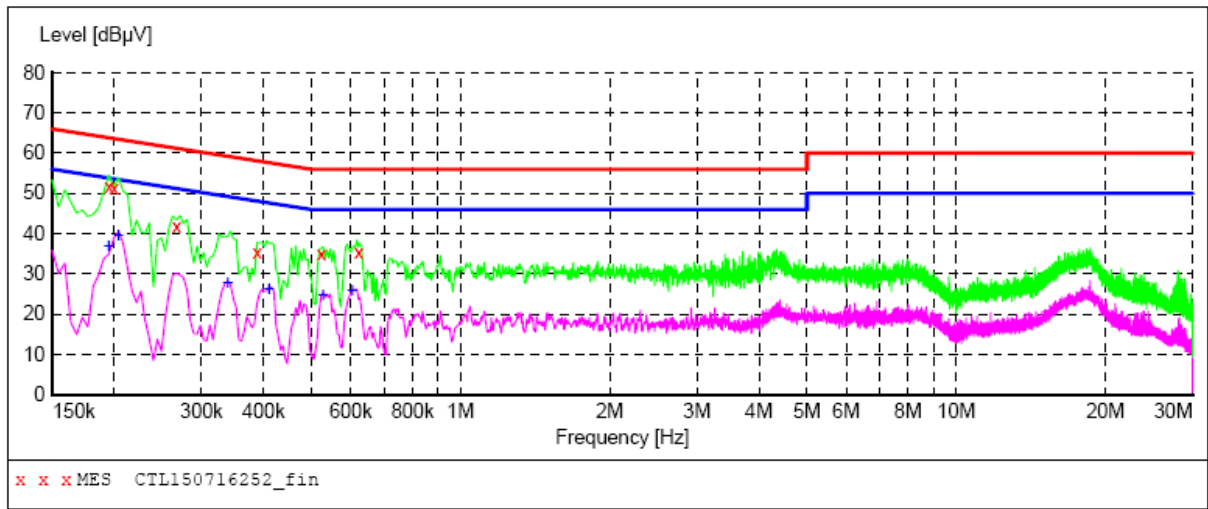

MEASUREMENT RESULT: "CTL150716252_fin"

7/16/2015 11:16AM

Frequency MHz	Level dBµV	Transd dB	Limit dBµV	Margin dB	Detector	Line	PE
0.195001	51.80	10.2	64	12.0	QP	N	GND
0.199501	51.50	10.2	64	12.1	QP	N	GND
0.267001	41.80	10.2	61	19.4	QP	N	GND
0.388501	35.50	10.2	58	22.6	QP	N	GND
0.523501	34.90	10.2	56	21.1	QP	N	GND
0.622501	35.60	10.2	56	20.4	QP	N	GND

MEASUREMENT RESULT: "CTL150716252_fin2"

7/16/2015 11:16AM

Frequency MHz	Level dBµV	Transd dB	Limit dBµV	Margin dB	Detector	Line	PE
0.195001	36.80	10.2	54	17.0	AV	N	GND
0.204001	39.50	10.2	53	13.9	AV	N	GND
0.339001	27.70	10.2	49	21.5	AV	N	GND
0.411001	26.20	10.2	48	21.4	AV	N	GND
0.528001	24.90	10.2	46	21.1	AV	N	GND
0.604501	25.80	10.2	46	20.2	AV	N	GND

5. Test of Maximum Peak Output Power

5.1 Applicable Standard

Refer to FCC §15.247 (b)

5.2 EUT Setup

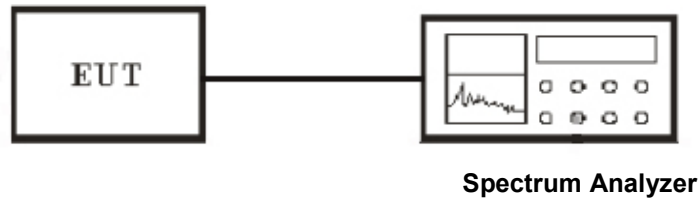

5.3 Test Equipment List and Details

See section 2.5.

5.4 Test Procedure

This procedure should only be used when the maximum available RBW of the spectrum/signal analyzer is less than the DTS bandwidth. The transmitter output was connected to a spectrum analyzer and the parameter was set as below:

1. Set the RBW = maximum available (at least 1 MHz).
2. Set the VBW = 3 x RBW or maximum available setting (must be \geq RBW).
3. Set the span to fully encompass the DTS bandwidth.
4. Detector = peak.
5. Sweep time = auto couple.
6. Trace mode = max hold.
7. Allow trace to fully stabilize.
8. Use the spectrum analyzer's band/channel power measurement function with the band limits set equal to the DTS bandwidth edges (for some analyzers, this may require a manual override to ensure use of peak detector). If the spectrum analyzer does not have a band power function, sum the spectrum levels (in linear power units) at intervals equal to the RBW extending across the DTS channel bandwidth.

5.5 Test Result

Temperature (°C) : 22~23	EUT: 40” LED LCD FULL HD SMART TV
Humidity (%RH) : 50~54	M/N: SLD40HG45RQ
Barometric Pressure (mbar) : 950~1000	Operation Condition: Tx Mode

IEEE 802.11b mode

Channel	Channel Frequency (MHz)	20dB Bandwidth (MHz)	Peak Power (dBm)	Peak Power Limit (dBm)	Pass / Fail
Low	2412	14.16	19.46	30	PASS
Middle	2437	14.16	19.30	30	PASS
High	2462	14.16	19.30	30	PASS

NOTE : 1. At final test to get the worst-case emission at 1Mbps.

IEEE 802.11g mode

Channel	Channel Frequency (MHz)	20dB Bandwidth (MHz)	Peak Power (dBm)	Peak Power Limit (dBm)	Pass / Fail
Low	2412	17.52	19.77	30	PASS
Middle	2437	17.52	19.41	30	PASS
High	2462	17.52	19.54	30	PASS

NOTE : 1. At final test to get the worst-case emission at 6Mbps.

IEEE 802.11n HT20mode

Channel	Channel Frequency (MHz)	20dB Bandwidth (MHz)	Peak Power (dBm)	Peak Power Limit (dBm)	Pass / Fail
Low	2412	18.40	19.33	30	PASS
Middle	2437	18.40	19.82	30	PASS
High	2462	18.40	19.64	30	PASS

NOTE : 1. At final test to get the worst-case emission at 13Mbps.

IEEE 802.11n HT40mode

Channel	Channel Frequency (MHz)	20dB Bandwidth (MHz)	Peak Power (dBm)	Peak Power Limit (dBm)	Pass / Fail
Low	2422	36.96	19.84	30	PASS
Middle	2437	37.12	19.80	30	PASS
High	2452	37.12	19.62	30	PASS

NOTE : 1. At final test to get the worst-case emission at 13Mbps.

MAXIMUM PEAK OUTPUT POWER (802.11b MODE CH Low)

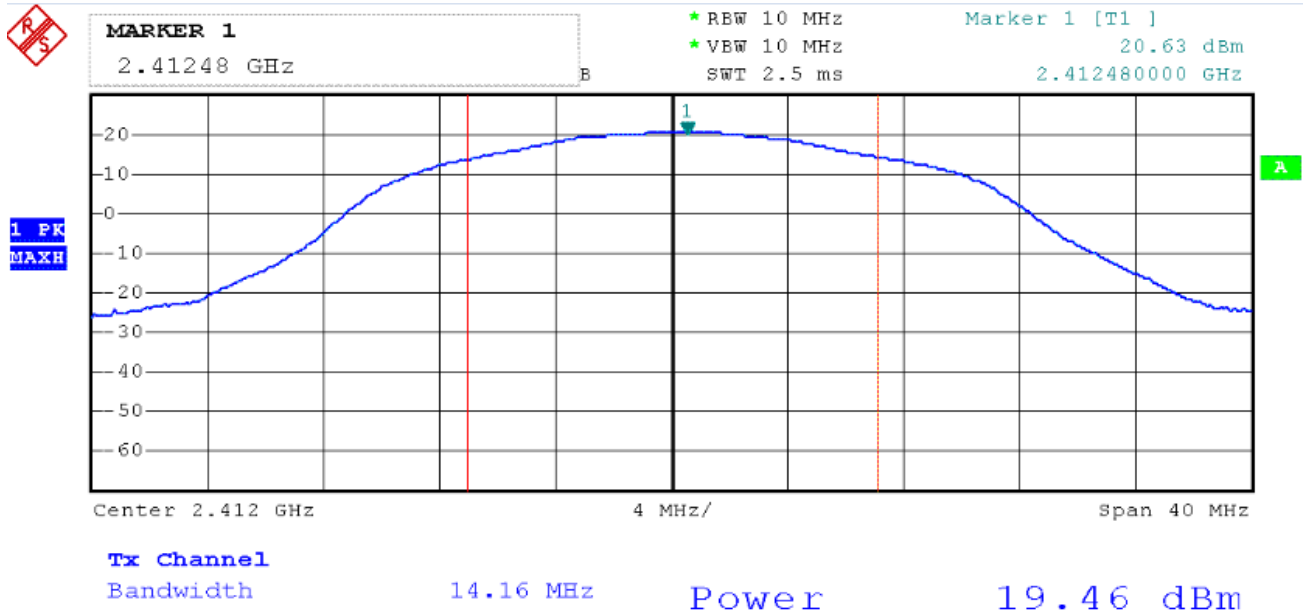

MAXIMUM PEAK OUTPUT POWER (802.11b MODE CH Mid)

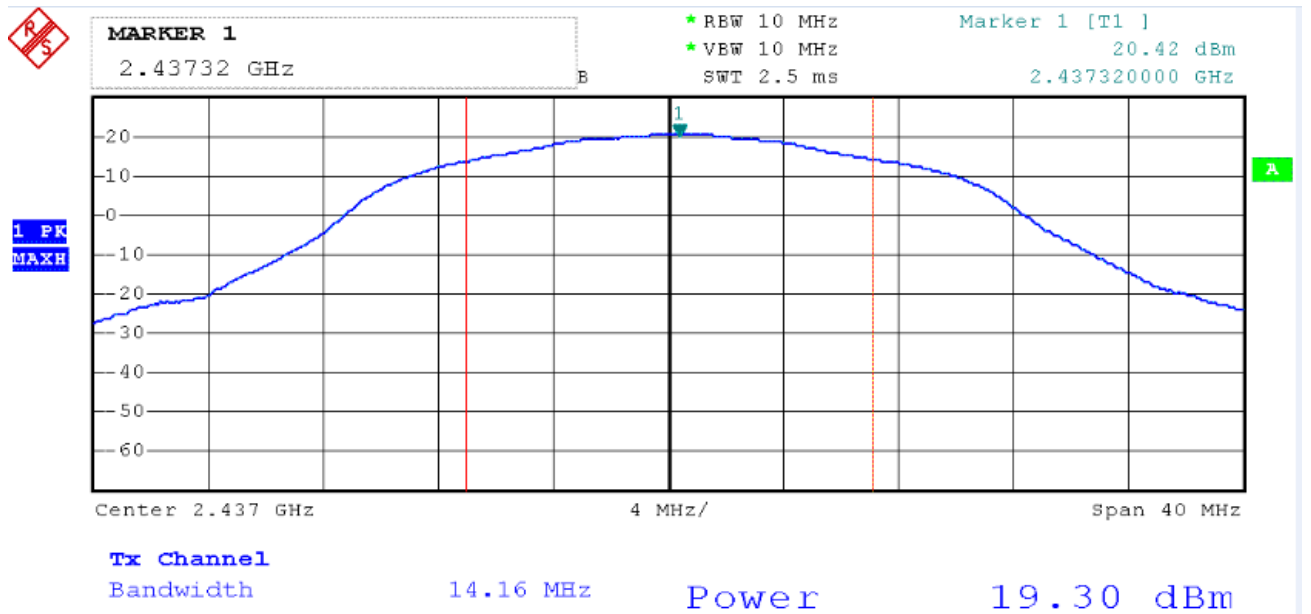

MAXIMUM PEAK OUTPUT POWER (802.11b MODE CH High)



MARKER 1
2.46264 GHz

* RBW 10 MHz
* VBW 10 MHz
SWT 2.5 ms

Marker 1 [T1]
20.45 dBm
2.462640000 GHz

1 PK
MAXH

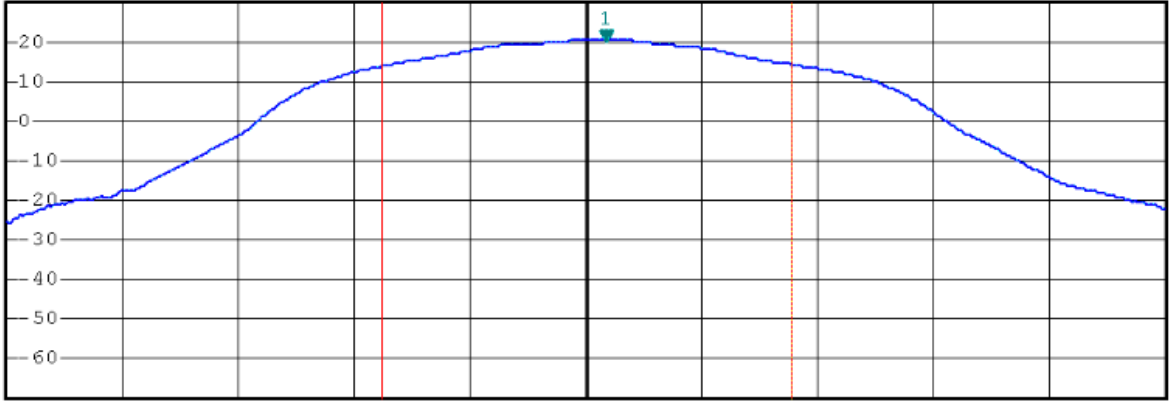

Center 2.462 GHz

4 MHz/

Span 40 MHz

Tx Channel

Bandwidth

14.16 MHz

Power

19.30 dBm

MAXIMUM PEAK OUTPUT POWER (802.11g MODE CH Low)

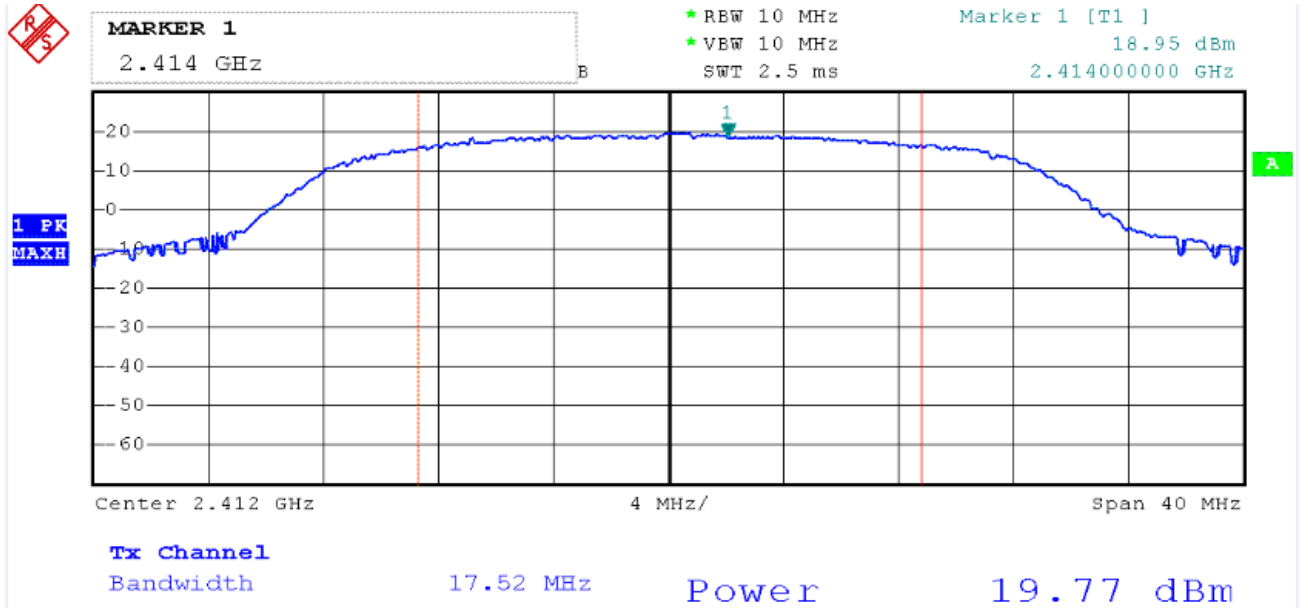

MAXIMUM PEAK OUTPUT POWER (802.11g MODE CH Mid)

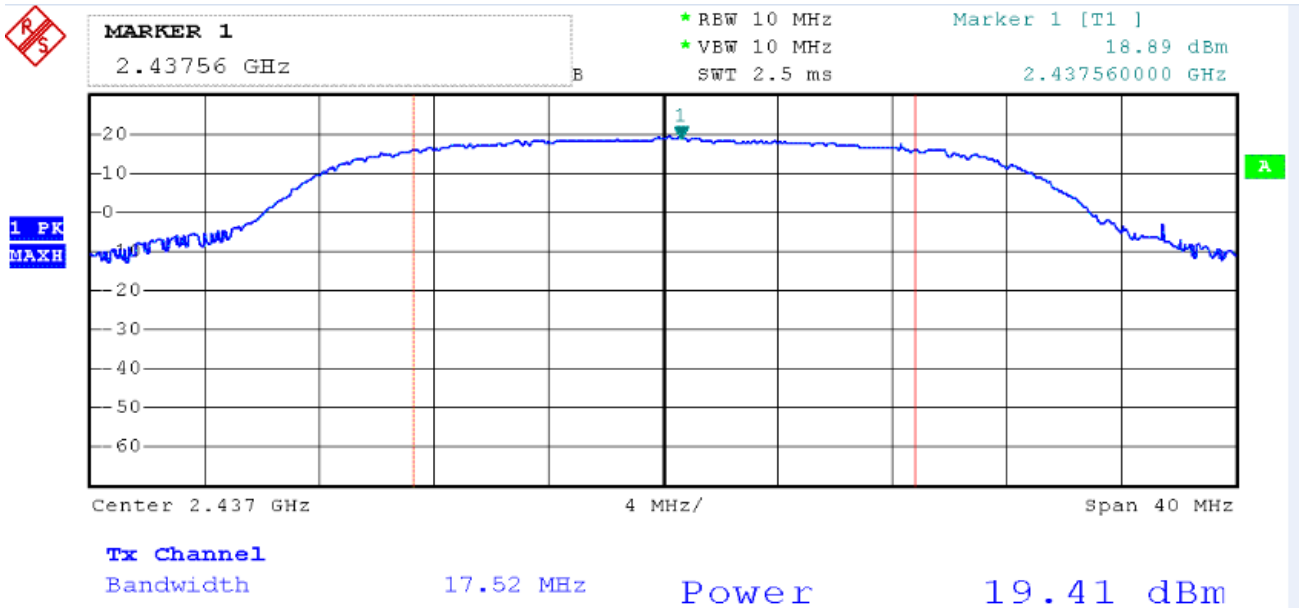

MAXIMUM PEAK OUTPUT POWER (802.11g MODE CH High)

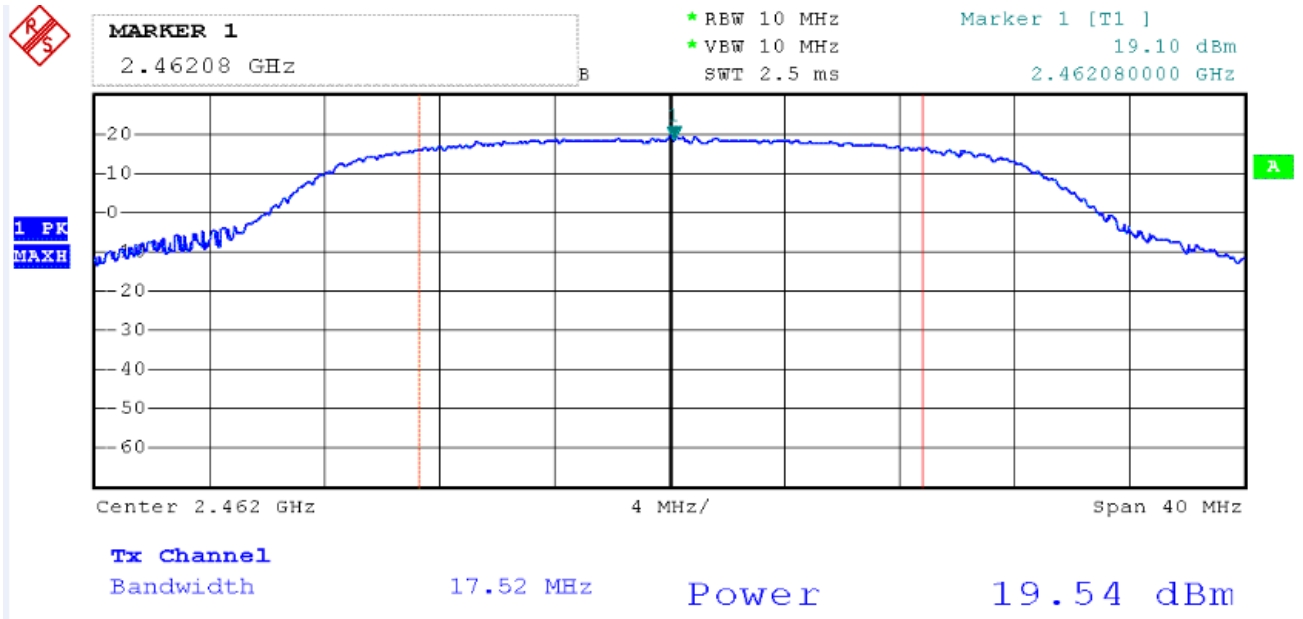

MAXIMUM PEAK OUTPUT POWER (802.11nHT20 MODE CH Low)

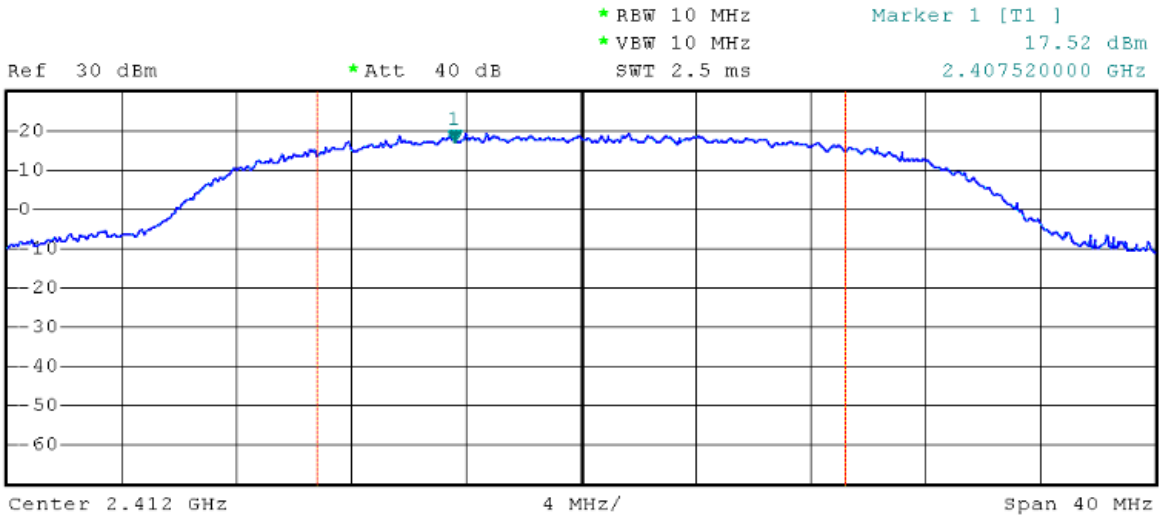

1 PK
MAXH

Tx Channel
 Bandwidth 18.4 MHz Power 19.33 dBm

MAXIMUM PEAK OUTPUT POWER (802.11nHT20 MODE CH Mid)

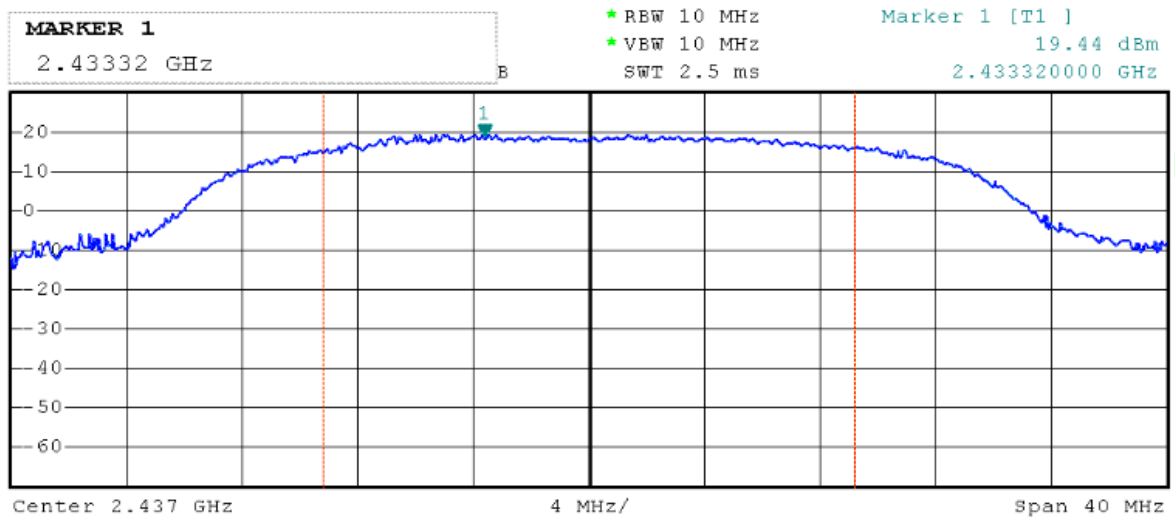

1 PK
MAXH

Tx Channel
 Bandwidth 18.4 MHz Power 19.82 dBm

MAXIMUM PEAK OUTPUT POWER (802.11nHT20 MODE CH High)

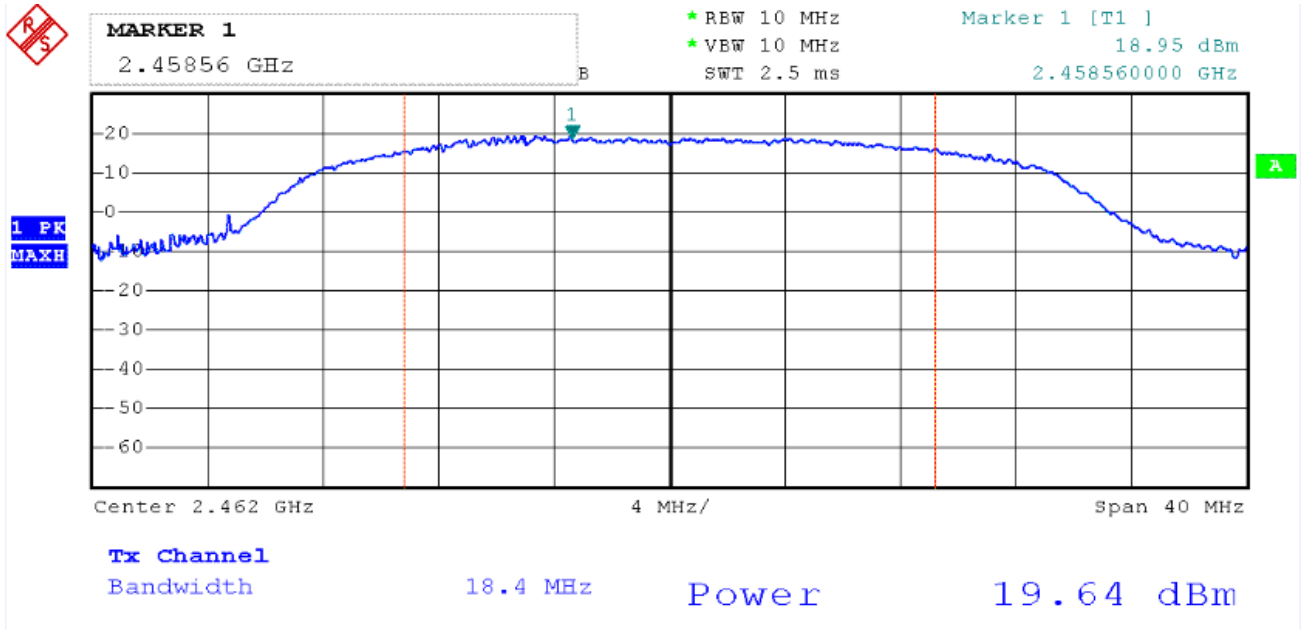

MAXIMUM PEAK OUTPUT POWER (802.11nHT40 MODE CH Low)

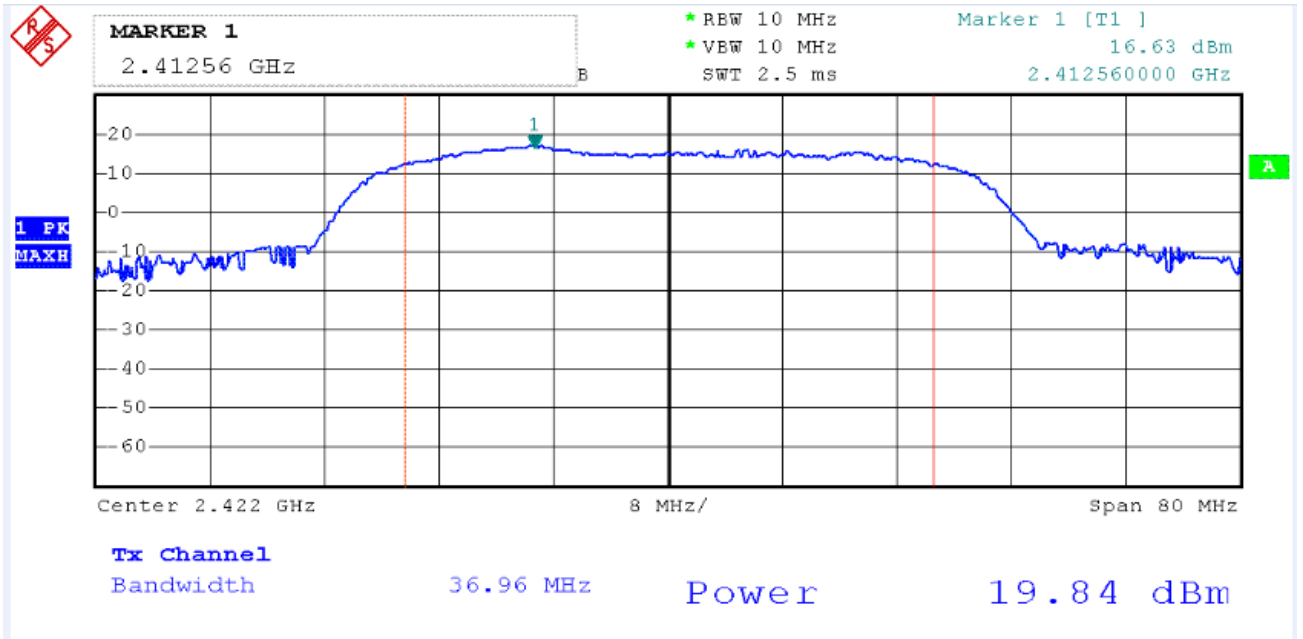

MAXIMUM PEAK OUTPUT POWER (802.11nHT40 MODE CH Mid)

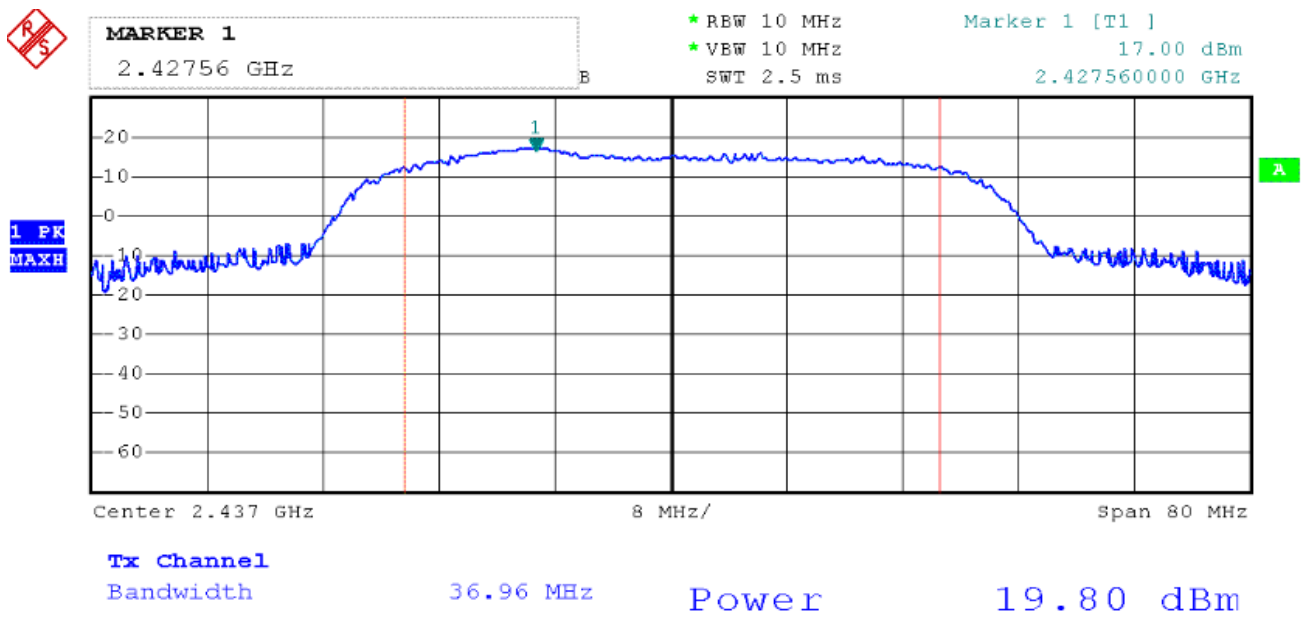

MAXIMUM PEAK OUTPUT POWER (802.11nHT40 MODE CH High)

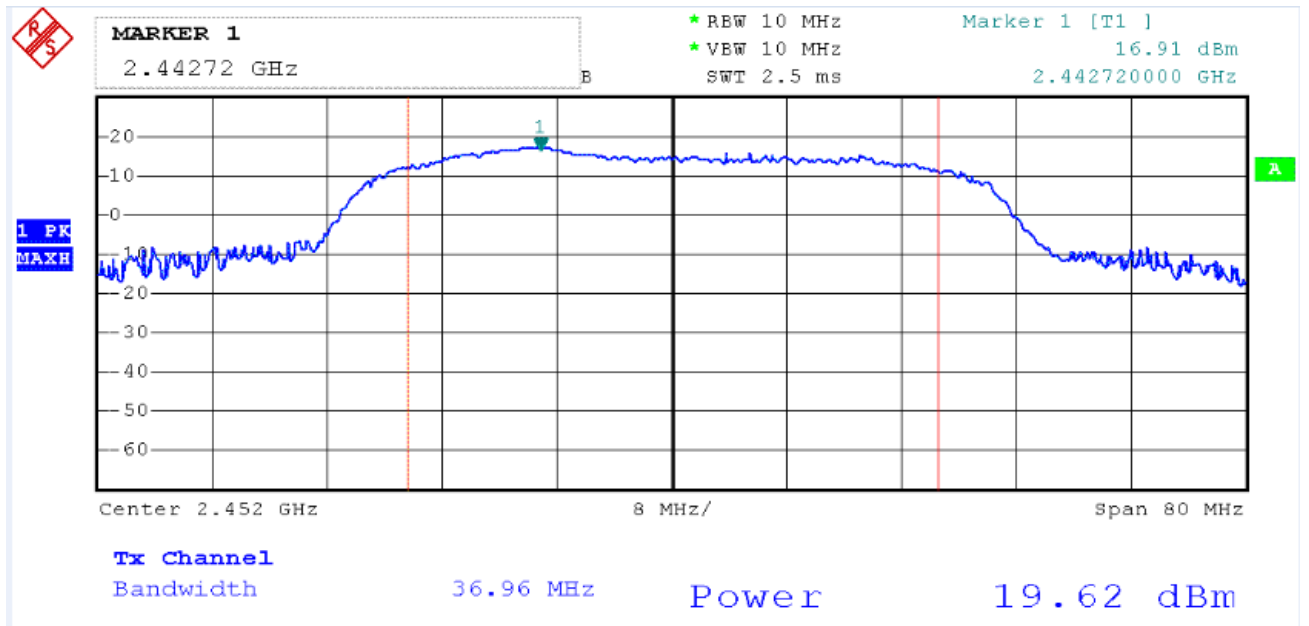

6. Test of Peak Power Spectral Density

6.1 Applicable Standard

Refer to FCC §15.247 (e).

The power spectral density conducted from the transmitter to the antenna shall not be greater than 8 dBm in any 3 kHz band during any time interval of continuous transmission.

6.2 EUT Setup

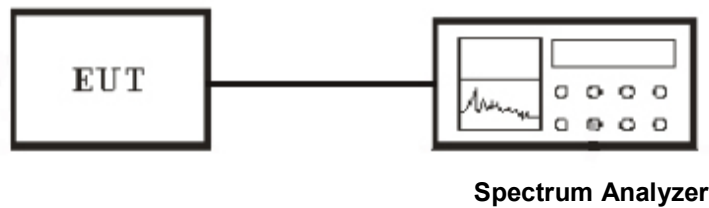

6.3 Test Equipment List and Details

See section 2.5.

6.4 Test Procedure

The transmitter output was connected to the spectrum analyzer and the parameter was set as below:

1. Set analyzer center frequency to DTS channel center frequency.
2. Set the span to 1.5 times the DTS channel bandwidth.
3. Set the RBW \geq 3 kHz.
4. Set the VBW \geq 3 x RBW.
5. Detector = peak.
6. Sweep time = auto couple.
7. Trace mode = max hold.
8. Allow trace to fully stabilize.
9. Use the peak marker function to determine the maximum amplitude level.
10. If measured value exceeds limit, reduce RBW (no less than 3 kHz) and repeat.

6.5 Test Result

Temperature (°C) : 22~23	EUT: 40" LED LCD FULL HD SMART TV
Humidity (%RH) : 50~54	M/N: SLD40HG45RQ
Barometric Pressure (mbar) : 950~1000	Operation Condition: Tx Mode

IEEE 802.11b mode

Channel	Channel Frequency (MHz)	RF Power Level in 100KHz RBW (dBm)	Correct Factor 100KHz to 3KHz (dB)	Final RF Power Level in 3KHz RBW (dBm)	Maximum Limit (dBm)	Pass / Fail
Low	2412	7.64	-15.22	-7.58	8	PASS
Middle	2437	7.59	-15.22	-7.63	8	PASS
High	2462	7.78	-15.22	-7.44	8	PASS

NOTE : 1. At final test to get the worst-case emission at 1Mbps.

IEEE 802.11 g mode

Channel	Channel Frequency (MHz)	RF Power Level in 100KHz RBW (dBm)	Correct Factor 100KHz to 3KHz (dB)	Final RF Power Level in 3KHz RBW (dBm)	Maximum Limit (dBm)	Pass / Fail
Low	2412	1.98	-15.22	-13.24	8	PASS
Middle	2437	1.99	-15.22	-13.23	8	PASS
High	2462	1.89	-15.22	-13.33	8	PASS

NOTE : 1. At final test to get the worst-case emission at 6Mbps.

IEEE 802.11nHT20 mode

Channel	Channel Frequency (MHz)	RF Power Level in 100KHz RBW (dBm)	Correct Factor 100KHz to 3KHz (dB)	Final RF Power Level in 3KHz RBW (dBm)	Maximum Limit (dBm)	Pass / Fail
Low	2412	4.21	-15.22	-11.01	8	PASS
Middle	2437	4.41	-15.22	-10.81	8	PASS
High	2462	3.68	-15.22	-11.54	8	PASS

NOTE : 1. At final test to get the worst-case emission at 13Mbps.

IEEE 802.11nHT40 mode

Channel	Channel Frequency (MHz)	RF Power Level in 100KHz RBW (dBm)	Correct Factor 100KHz to 3KHz (dB)	Final RF Power Level in 3KHz RBW (dBm)	Maximum Limit (dBm)	Pass / Fail
Low	2422	3.56	-15.22	-11.66	8	PASS
Middle	2437	3.46	-15.22	-11.76	8	PASS
High	2452	3.84	-15.22	-11.38	8	PASS

NOTE : 1. At final test to get the worst-case emission at 13Mbps.

POWER SPECTRAL DENSITY (802.11b MODE CH Low)

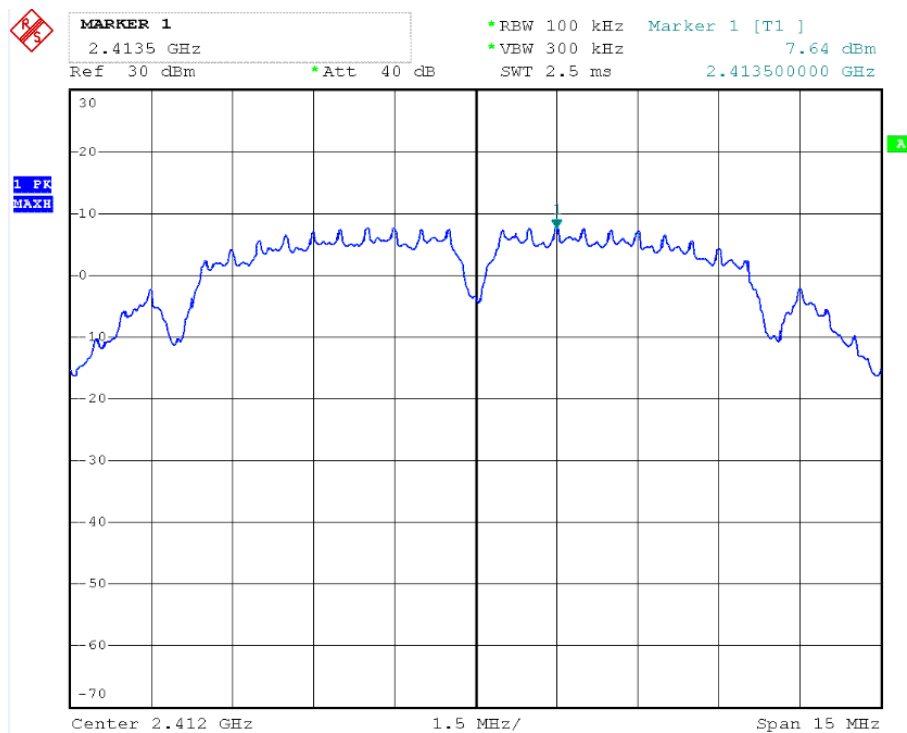

POWER SPECTRAL DENSITY (802.11b MODE CH Mid)

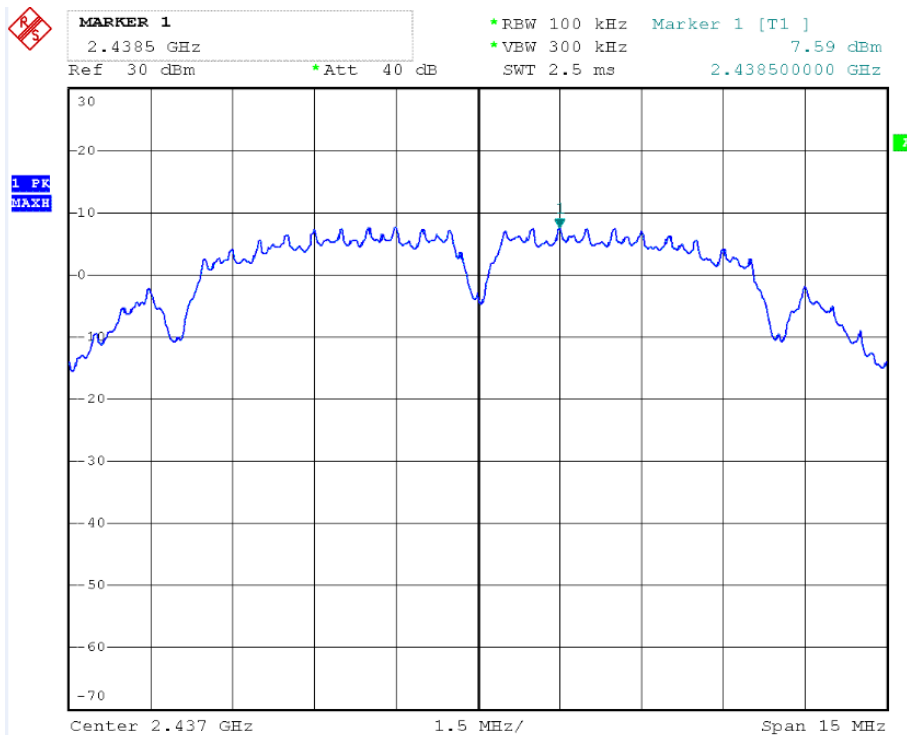

POWER SPECTRAL DENSITY (802.11b MODE CH High)

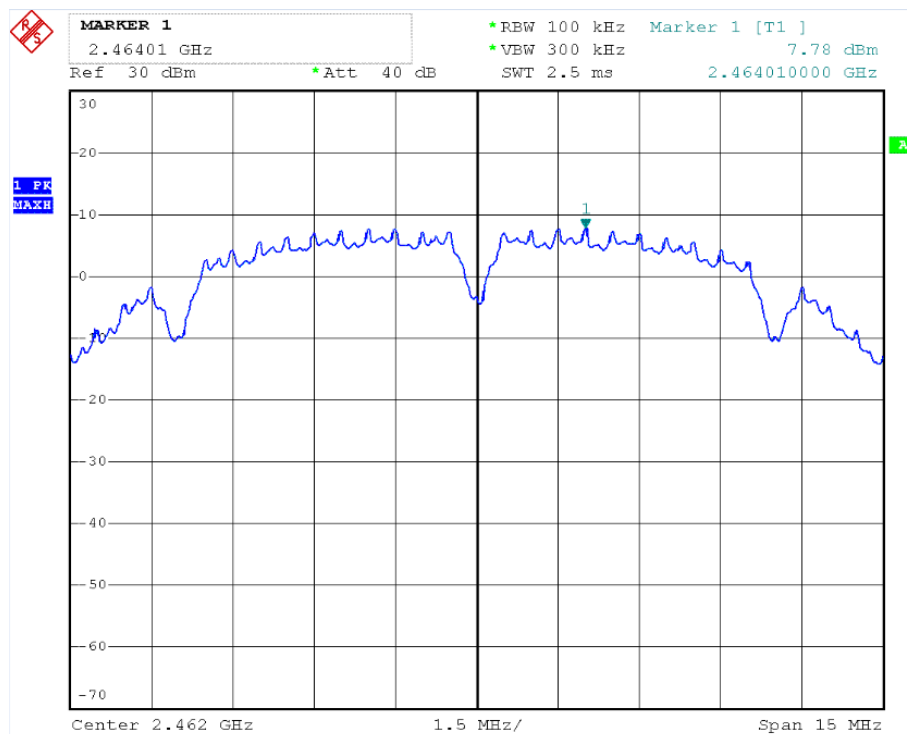

POWER SPECTRAL DENSITY (802.11g MODE CH Low)

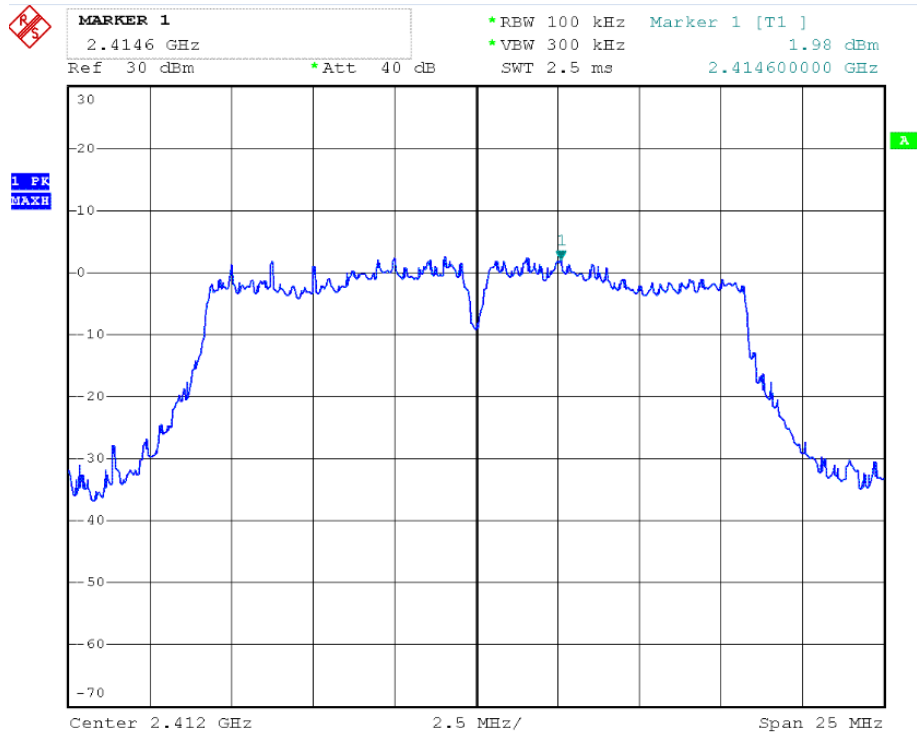

POWER SPECTRAL DENSITY (802.11g MODE CH Mid)

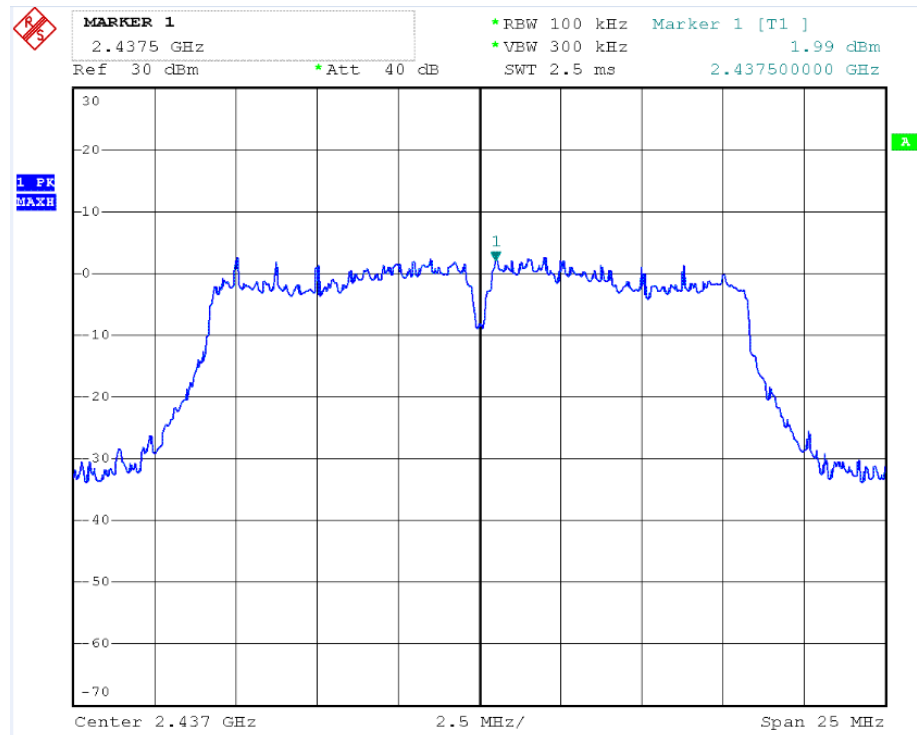

POWER SPECTRAL DENSITY (802.11g MODE CH High)

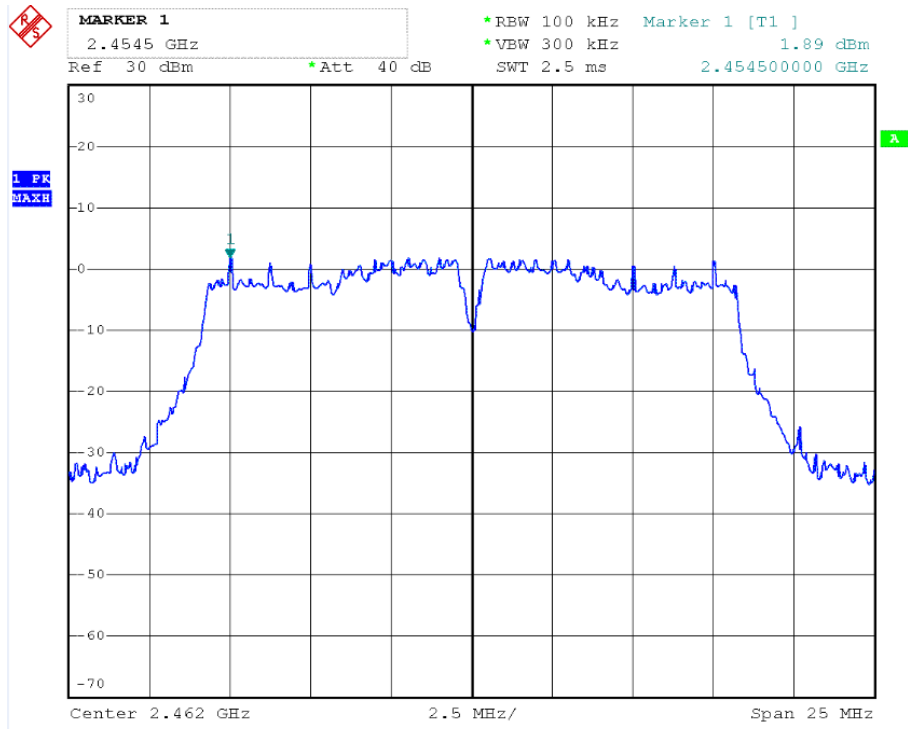

POWER SPECTRAL DENSITY (802.11nHT20 MODE CH Low)

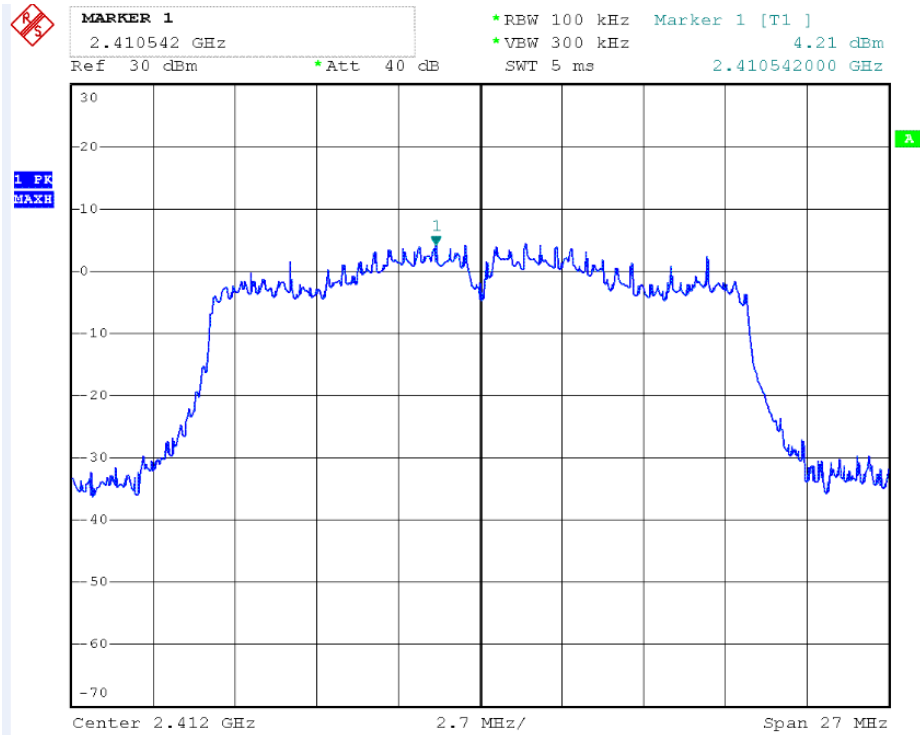

POWER SPECTRAL DENSITY (802.11nHT20 MODE CH Mid)

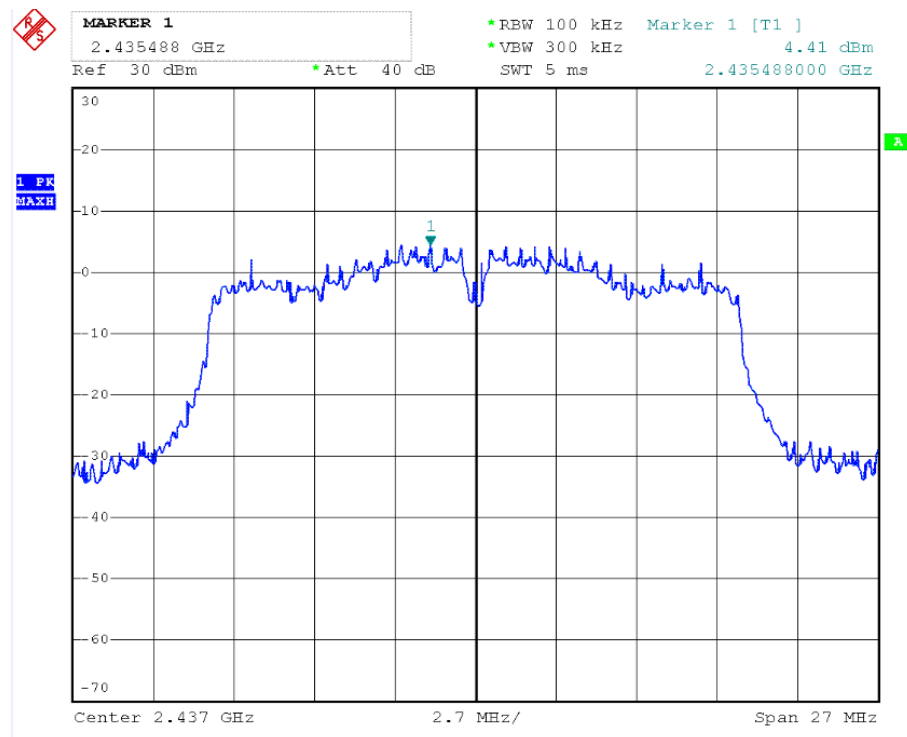

POWER SPECTRAL DENSITY (802.11nHT20 MODE CH High)

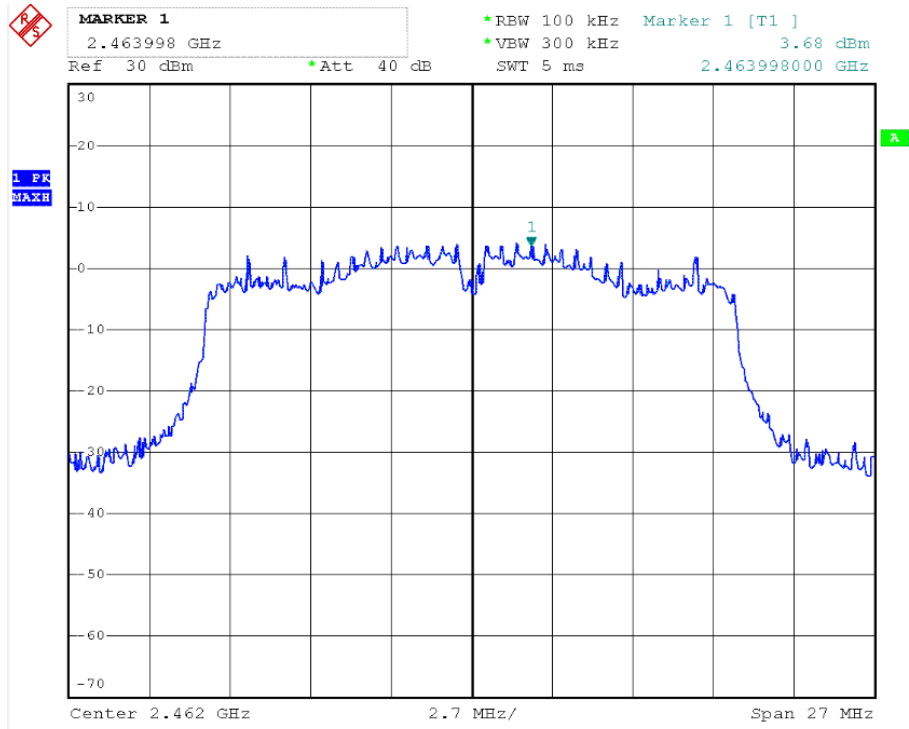

POWER SPECTRAL DENSITY (802.11nHT40 MODE CH Low)

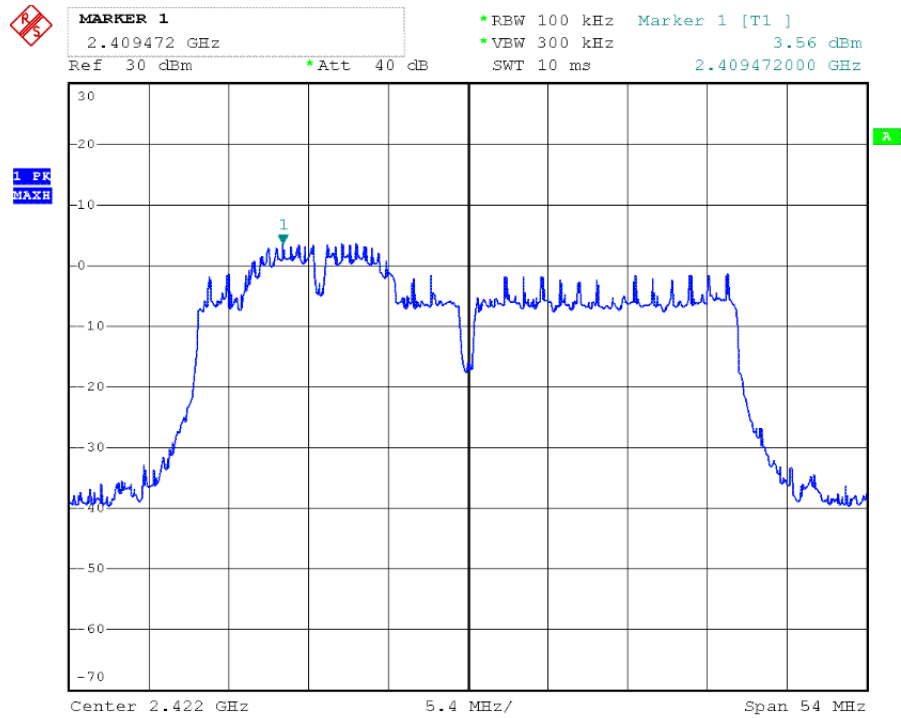

POWER SPECTRAL DENSITY (802.11nHT40 MODE CH Mid)

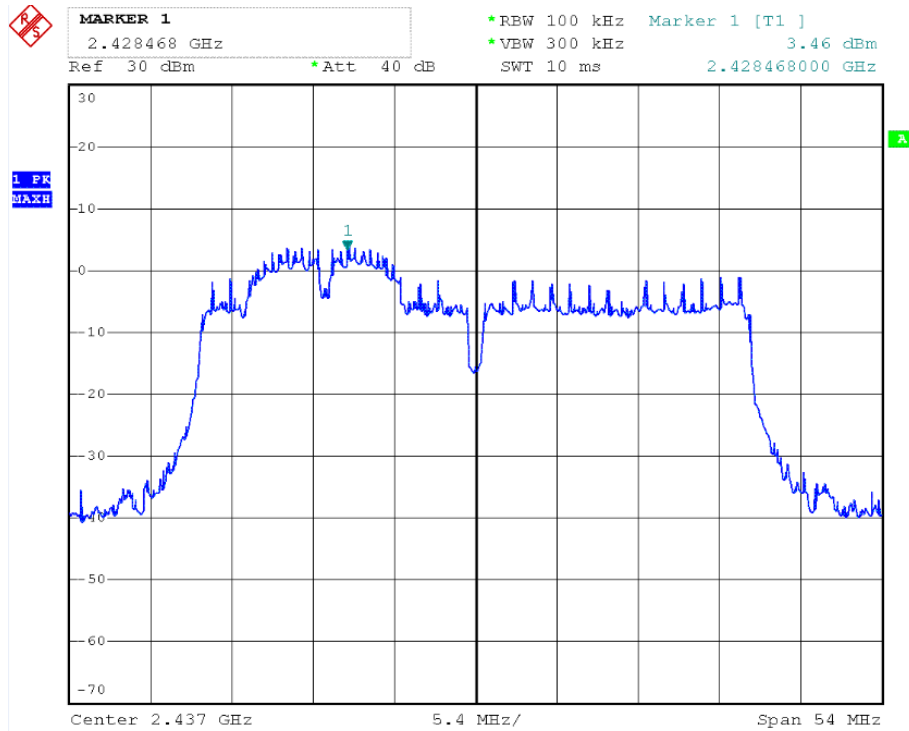

POWER SPECTRAL DENSITY (802.11nHT40 MODE CH High)

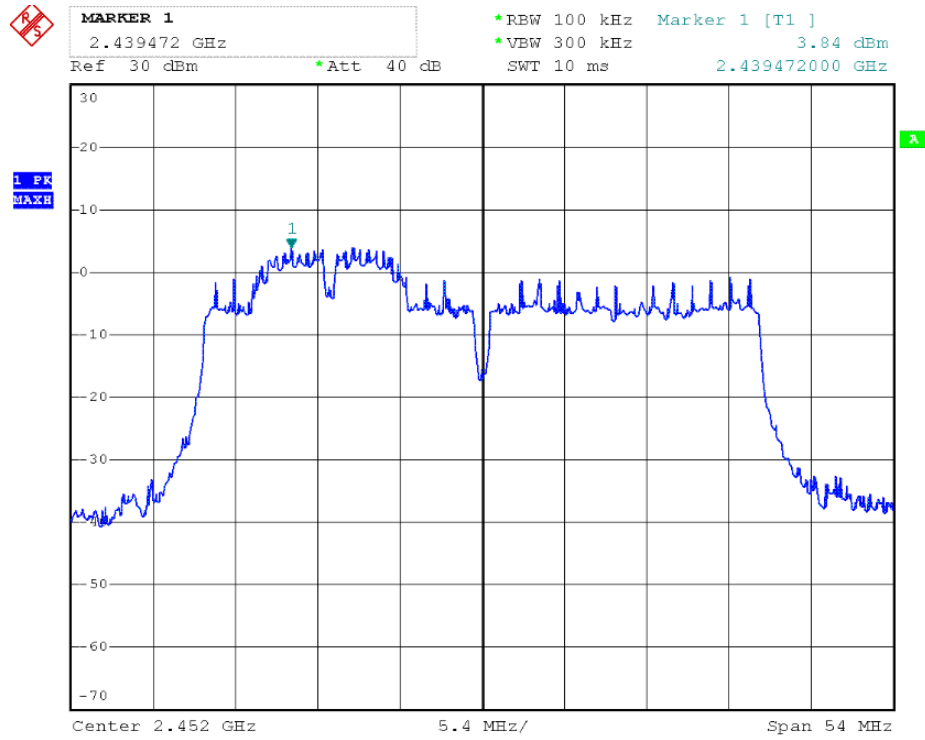

7. Test of 6dB Bandwidth

7.1 Applicable Standard

Refer to FCC §15.247 (a) (2) .

The minimum 6 dB bandwidth shall be at least 500 kHz.

7.2 EUT Setup

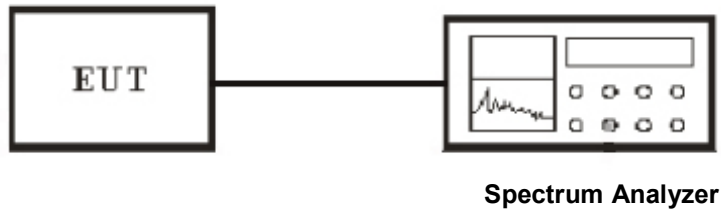

7.3 Test Equipment List and Details

See section 2.5.

7.4 Test Procedure

The 6dB bandwidth is defined as the total spectrum the power of which is higher than peak power minus 6dB. The transmitter output was connected to a spectrum analyzer and the parameter was set as below:

1. Set resolution bandwidth (RBW) = 1-5% or DTS BW, not to exceed 100 kHz.
2. Set the video bandwidth (VBW) $\geq 3 \times$ RBW.
3. Detector = Peak.
4. Trace mode = max hold.
5. Sweep = auto couple.
6. Allow the trace to stabilize.
7. Measure the maximum width of the emission that is constrained by the frequencies associated with the two outermost amplitude points (upper and lower) that are attenuated by 6 dB relative to the maximum level measured in the fundamental emission.

7.5 Test Result

Temperature (°C) : 22~23	EUT: 40" LED LCD FULL HD SMART TV
Humidity (%RH) : 50~54	M/N: SLD40HG45RQ
Barometric Pressure (mbar) : 950~1000	Operation Condition: Tx Mode

IEEE 802.11b mode

Channel	Channel Frequency (MHz)	6dB Bandwidth (MHz)	Minimum Limit (kHz)	Pass / Fail
Low	2412	10.08	500	PASS
Middle	2437	10.04	500	PASS
High	2462	10.08	500	PASS

NOTE : 1. At final test to get the worst-case emission at 1Mbps.

IEEE 802.11g mode

Channel	Channel Frequency (MHz)	6dB Bandwidth (MHz)	Minimum Limit (kHz)	Pass / Fail
Low	2412	16.40	500	PASS
Middle	2437	16.32	500	PASS
High	2462	16.40	500	PASS

NOTE : 1. At final test to get the worst-case emission at 6Mbps.

IEEE 802.11n HT20 mode

Channel	Channel Frequency (MHz)	6dB Bandwidth (MHz)	Minimum Limit (kHz)	Pass / Fail
Low	2412	15.44	500	PASS
Middle	2437	16.00	500	PASS
High	2462	15.84	500	PASS

NOTE : 1. At final test to get the worst-case emission at 13Mbps.

IEEE 802.11n HT40 mode

Channel	Channel Frequency (MHz)	6dB Bandwidth (MHz)	Minimum Limit (kHz)	Pass / Fail
Low	2422	35.36	500	PASS
Middle	2437	35.36	500	PASS
High	2452	35.52	500	PASS

NOTE : 1. At final test to get the worst-case emission at 13Mbps.

6dB BANDWIDTH (802.11b MODE CH Low)

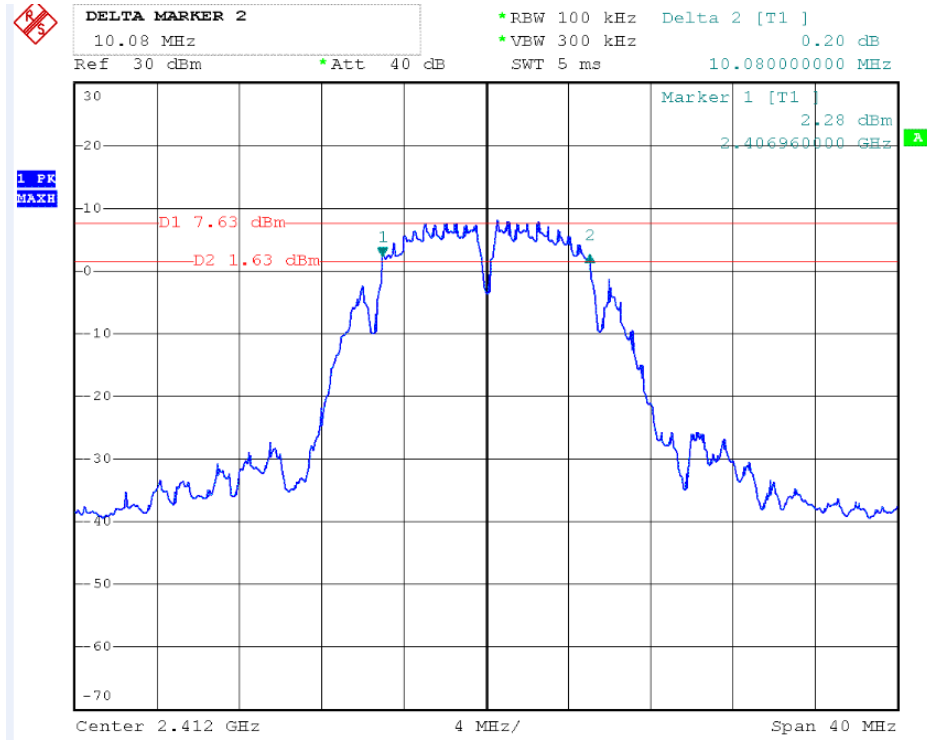

6dB BANDWIDTH (802.11b MODE CH Mid)

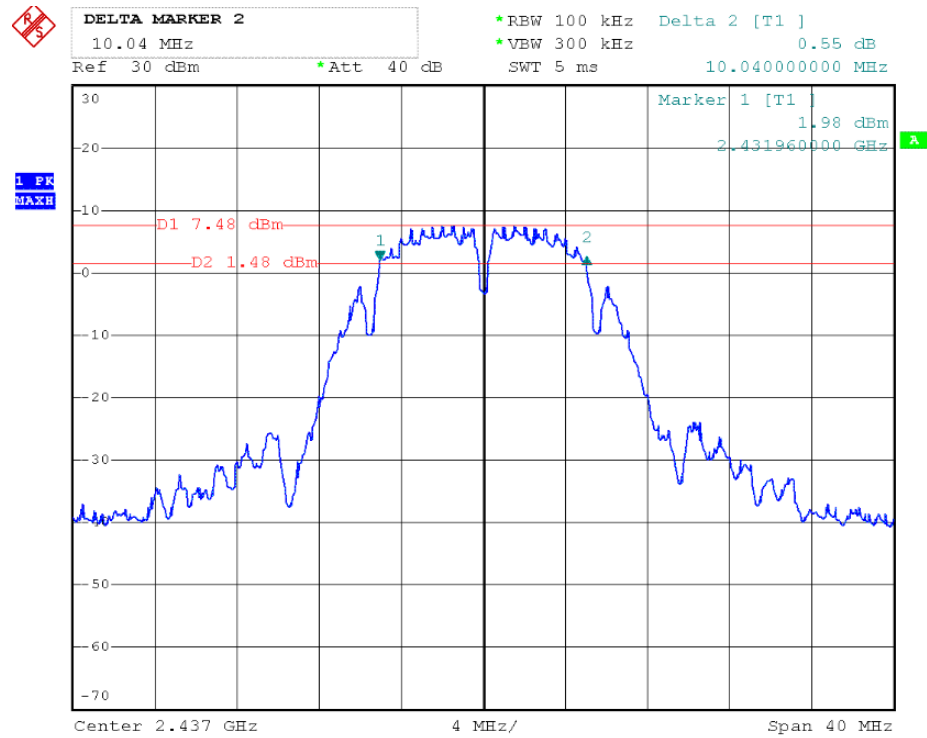

6dB BANDWIDTH (802.11b MODE CH High)

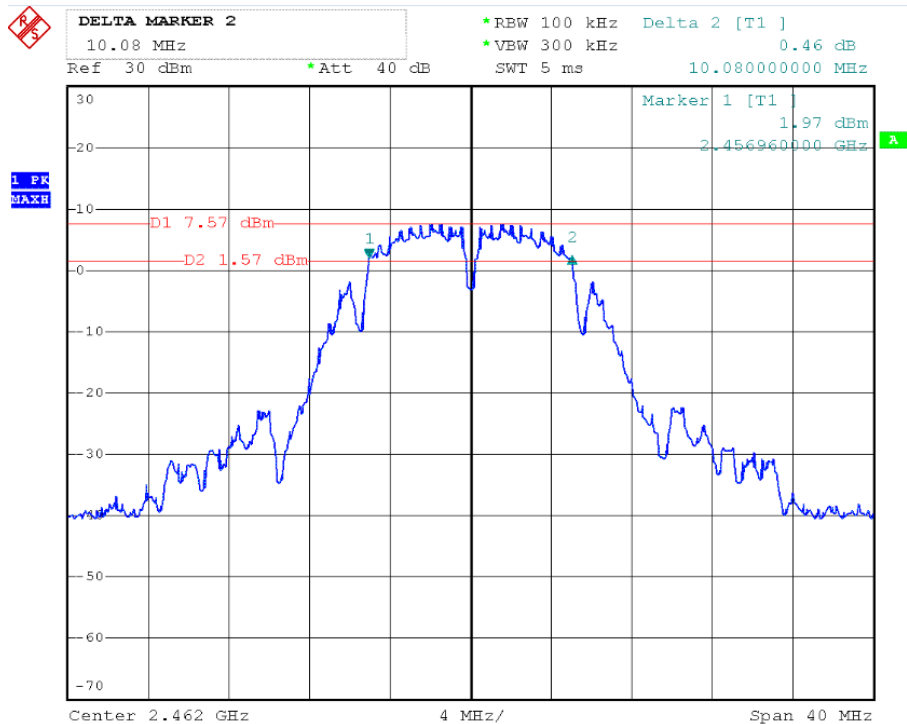

6dB BANDWIDTH (802.11g MODE CH Low)

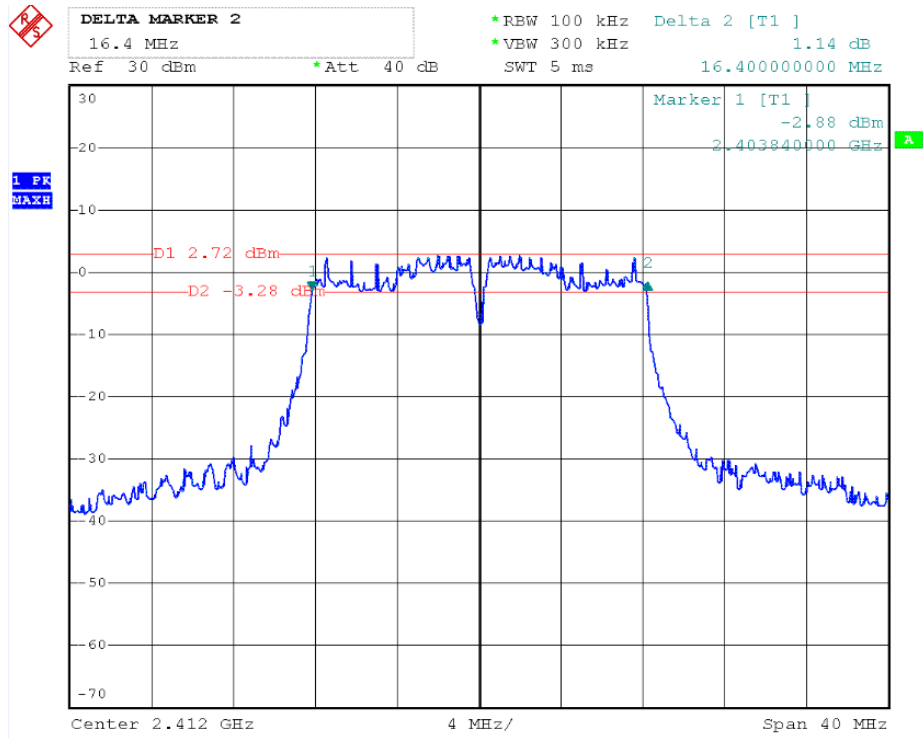

6dB BANDWIDTH (802.11g MODE CH Mid)

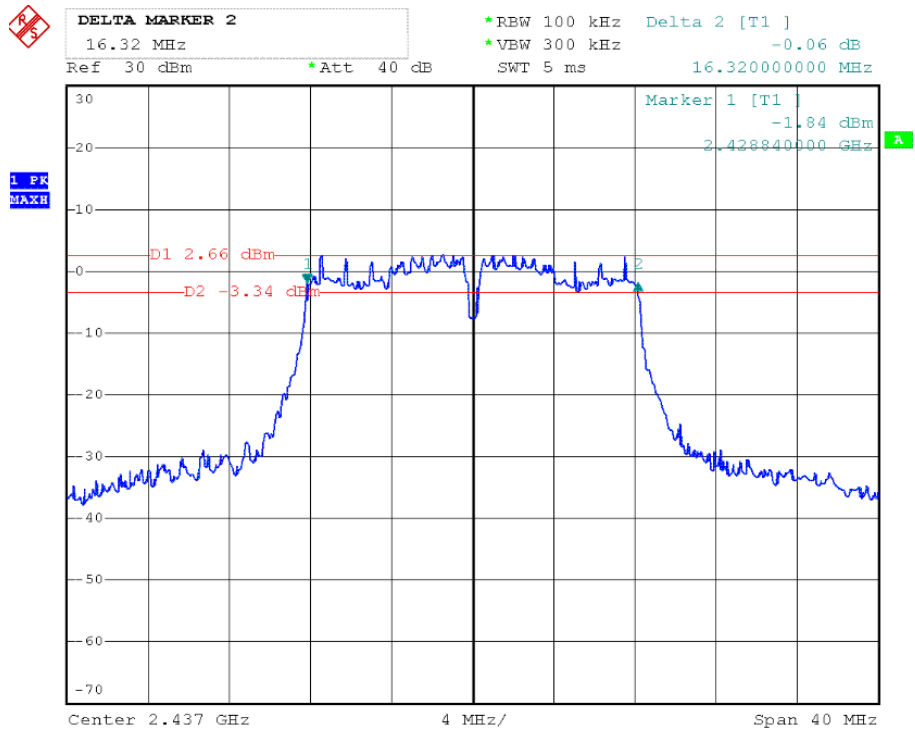

6dB BANDWIDTH (802.11g MODE CH High)

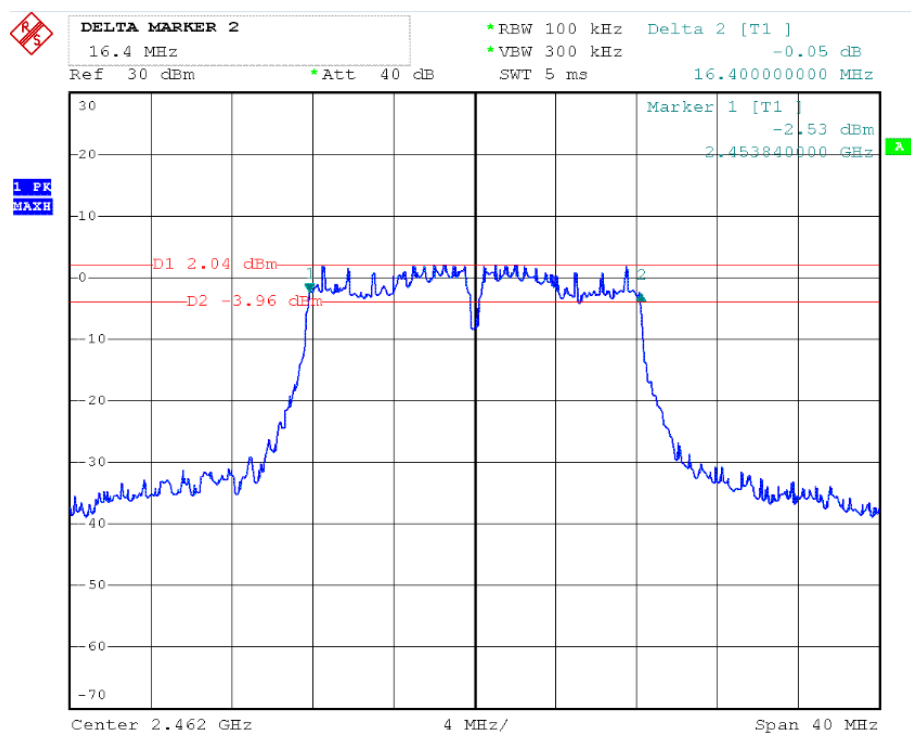

6dB BANDWIDTH (802.11n HT20 MODE CH Low)

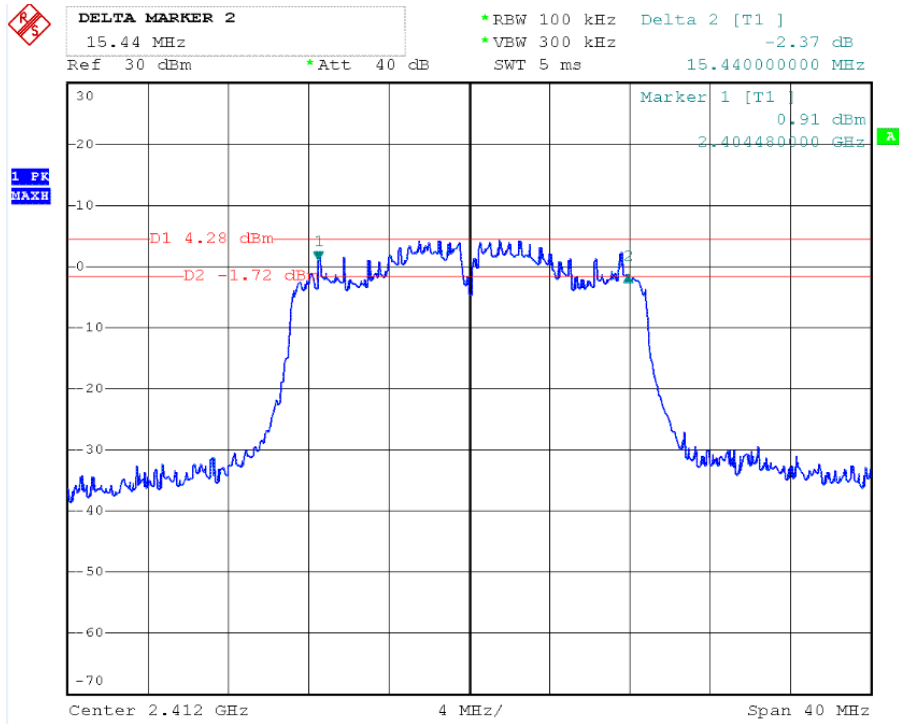

6dB BANDWIDTH (802.11n HT20 MODE CH Mid)

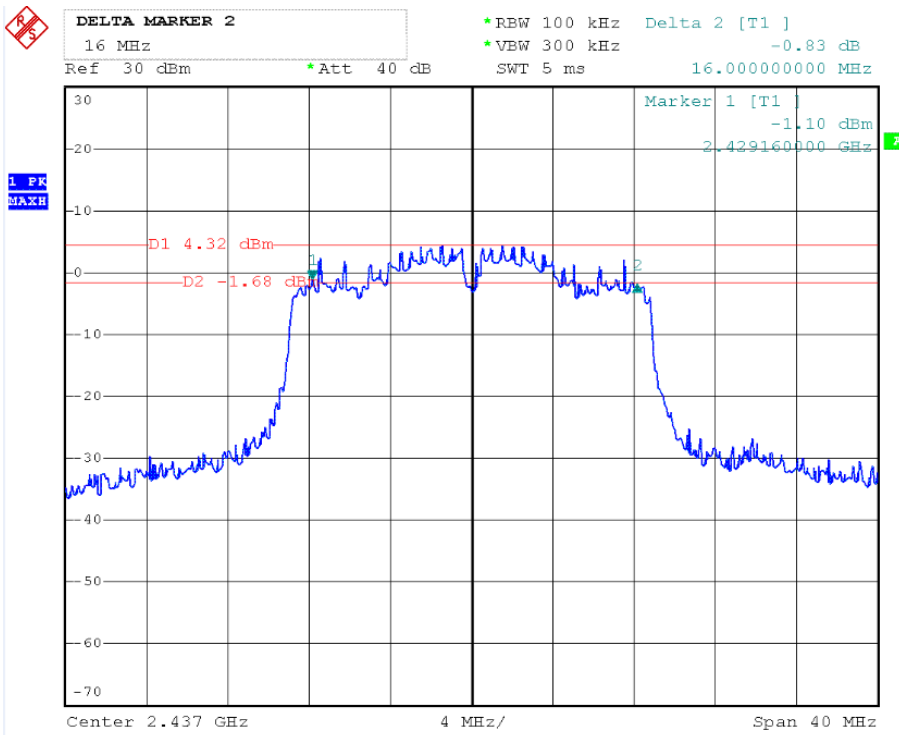

6dB BANDWIDTH (802.11n HT20 MODE CH High)

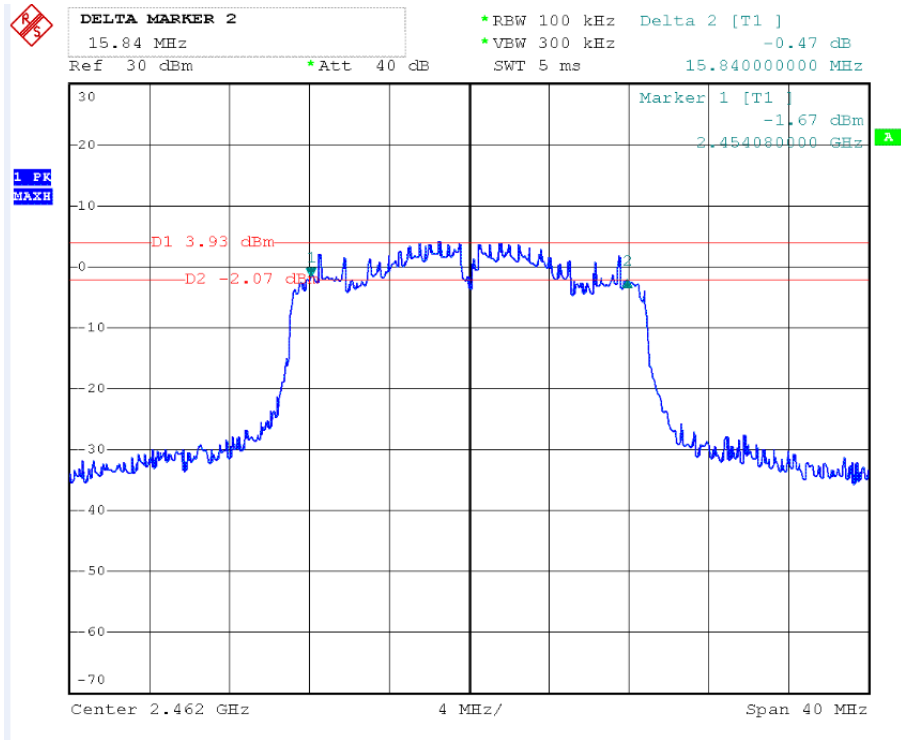

6dB BANDWIDTH (802.11n HT40 MODE CH Low)

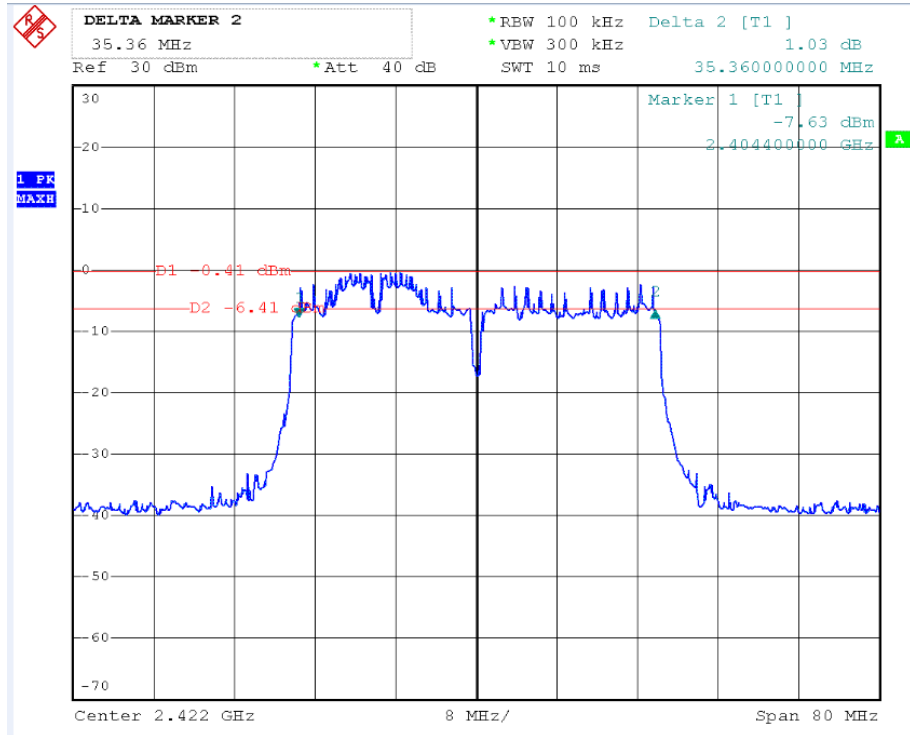

6dB BANDWIDTH (802.11n HT40 MODE CH Mid)

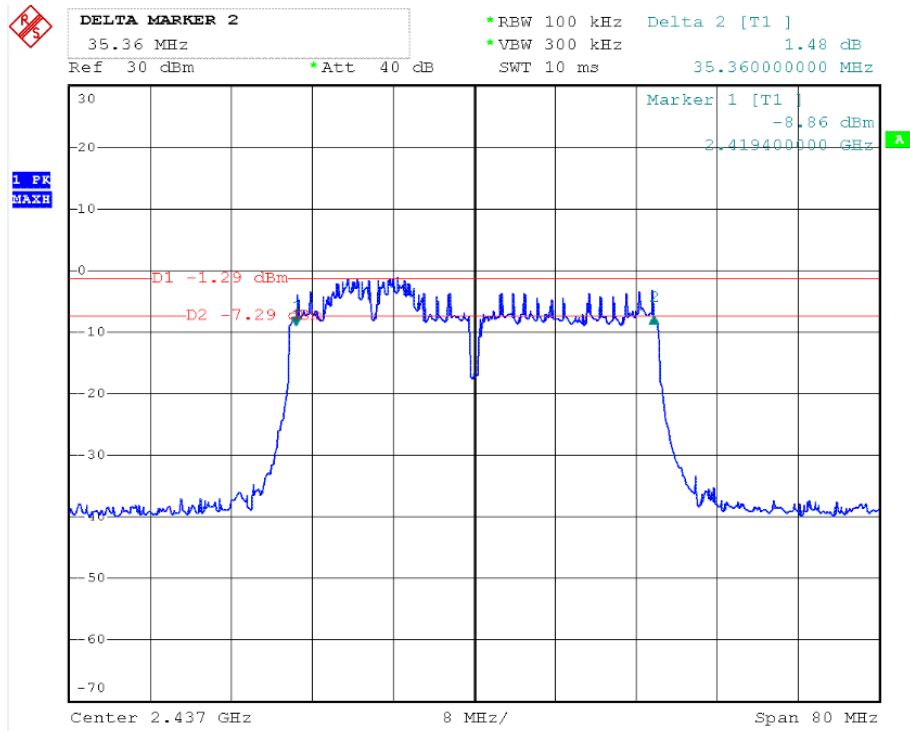

6dB BANDWIDTH (802.11n HT40 MODE CH High)

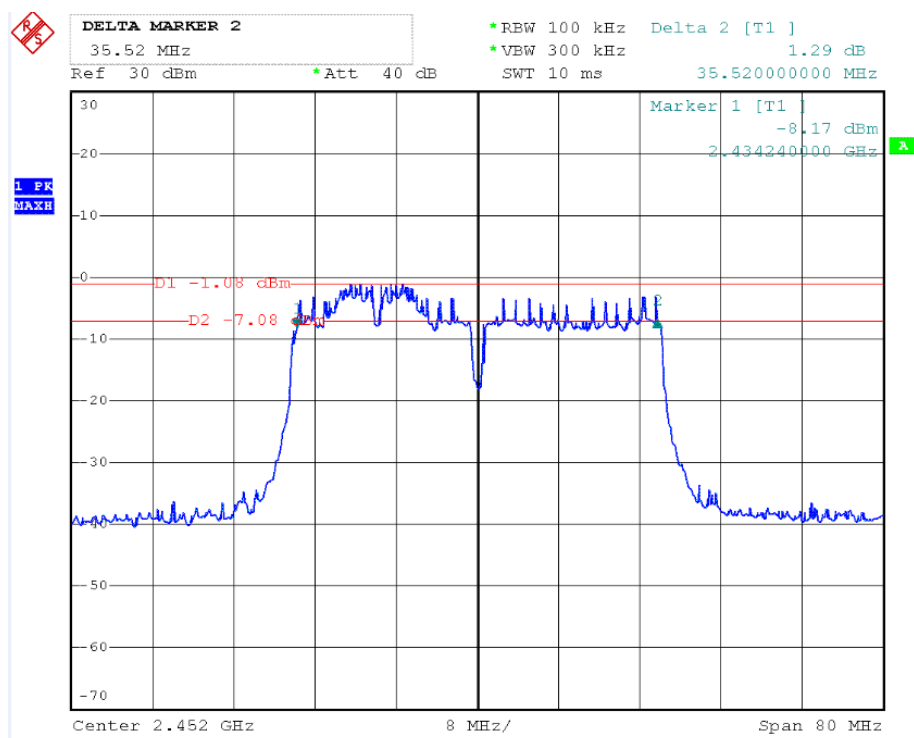

8. Test of Conducted Spurious Emission

8.1 Applicable Standard

Refer to FCC §15.247 (d)

Output power was measured based on the use of RMS averaging over a time interval, therefore the required attenuation is 30 dB.

8.2 EUT Setup

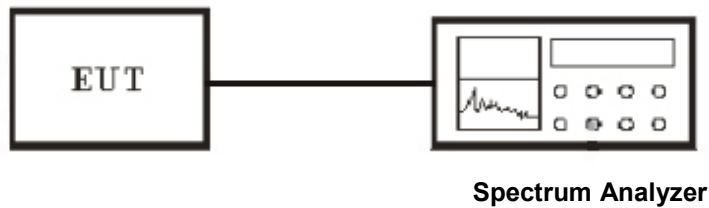

8.3 Test Equipment List and Details

See section 2.5.

8.4 Test Procedure

The transmitter output was connected to a spectrum analyzer. The spectrum from 30 MHz to 26.5 GHz is investigated with the transmitter set to the lowest, middle, and highest channels in the 2.4 GHz band. The parameter of the spectrum analyzer was set as below:

1. Set start frequency to DTS channel edge frequency.
2. Set stop frequency so as to encompass the spectrum to be examined.
3. Set RBW = 100 kHz.
4. Set VBW \geq 300 kHz.
5. Detector = peak.
6. Trace Mode = max hold.
7. Sweep = auto couple.
8. Allow the trace to stabilize (this may take some time, depending on the extent of the span).
9. Use peak marker function to determine maximum amplitude of all unwanted emissions within any 100 kHz bandwidth.

8.5 Test Result

Temperature (°C) : 22~23	EUT: 40" LED LCD FULL HD SMART TV
Humidity (%RH) : 50~54	M/N: SLD40HG45RQ
Barometric Pressure (mbar) : 950~1000	Operation Condition: TX Mode

IEEE 802.11b mode

CH Low

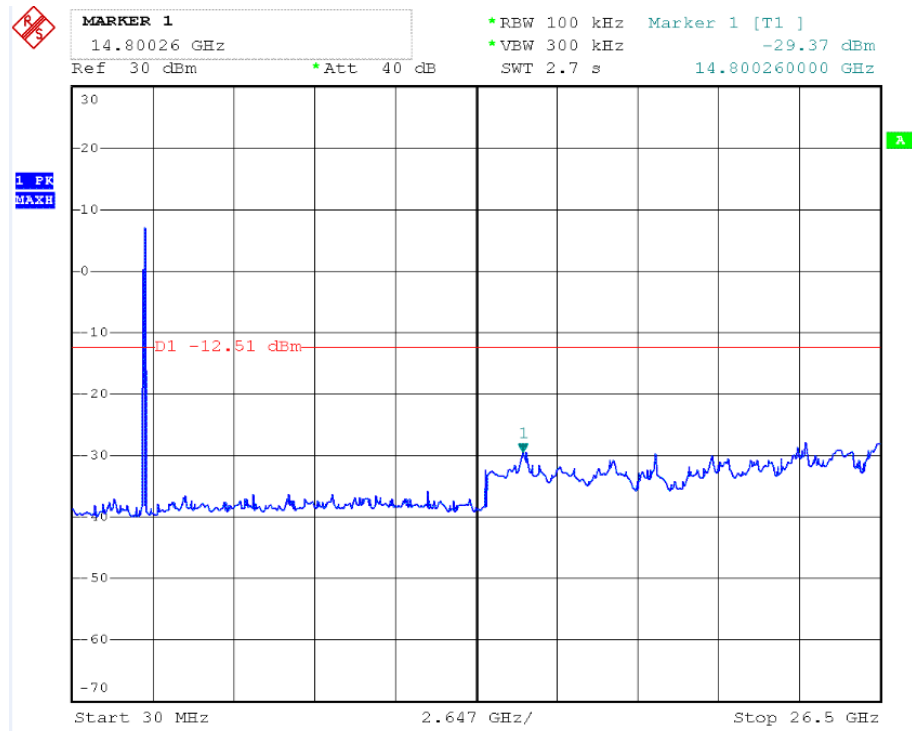

CH Mid

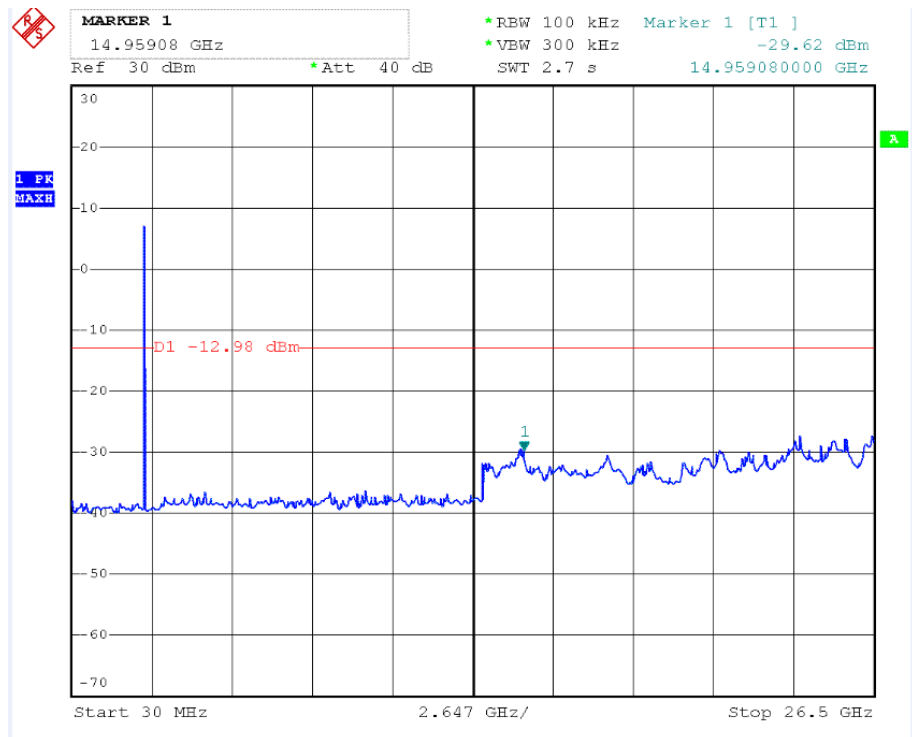

CH High

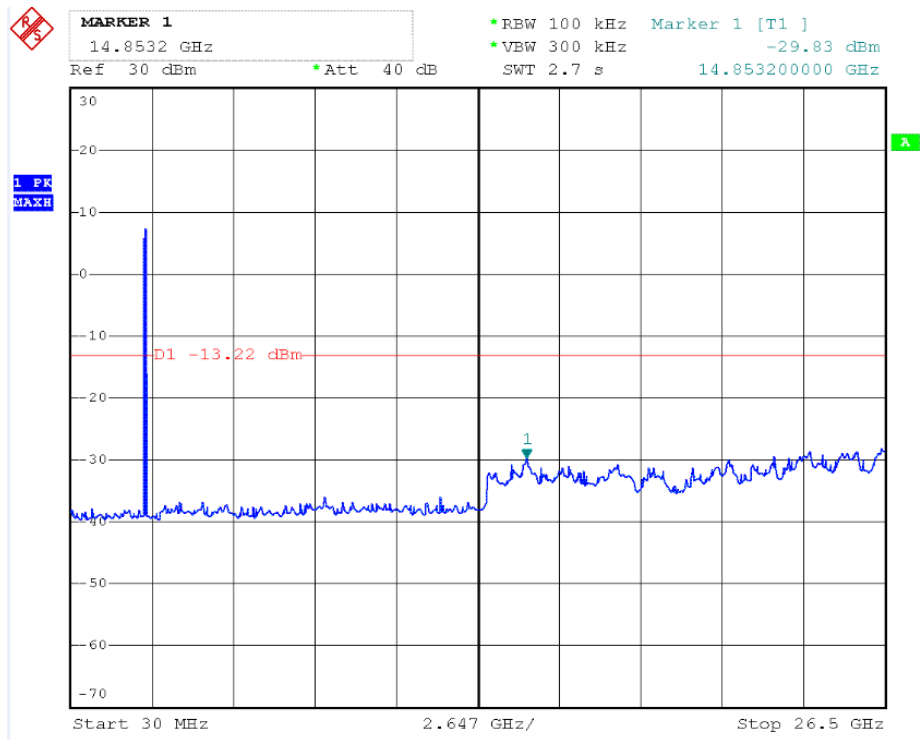

IEEE 802.11g mode CH Low

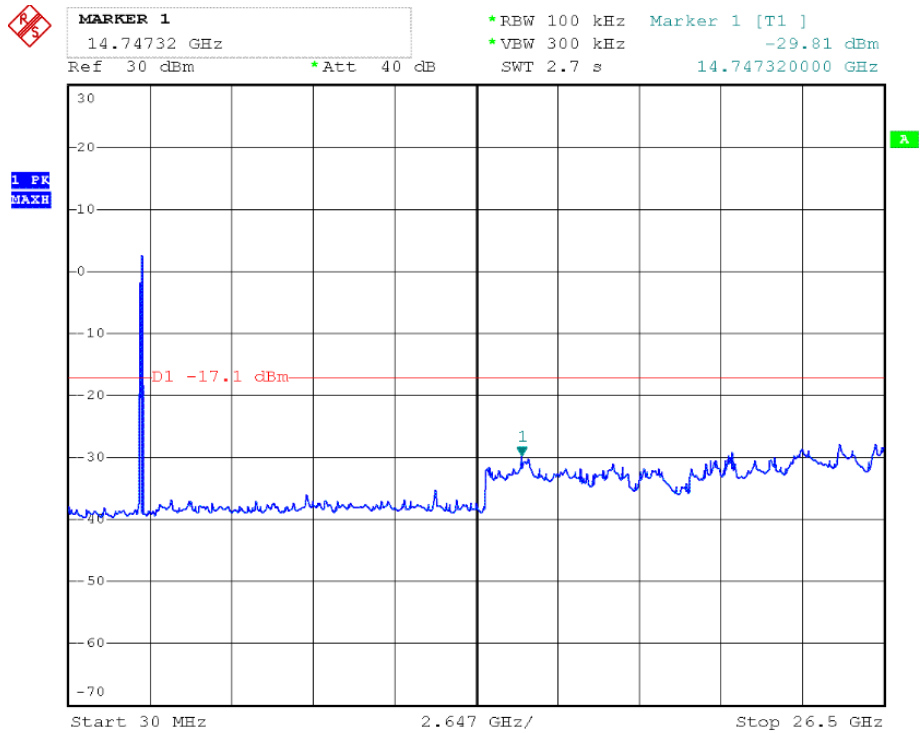

CH Mid

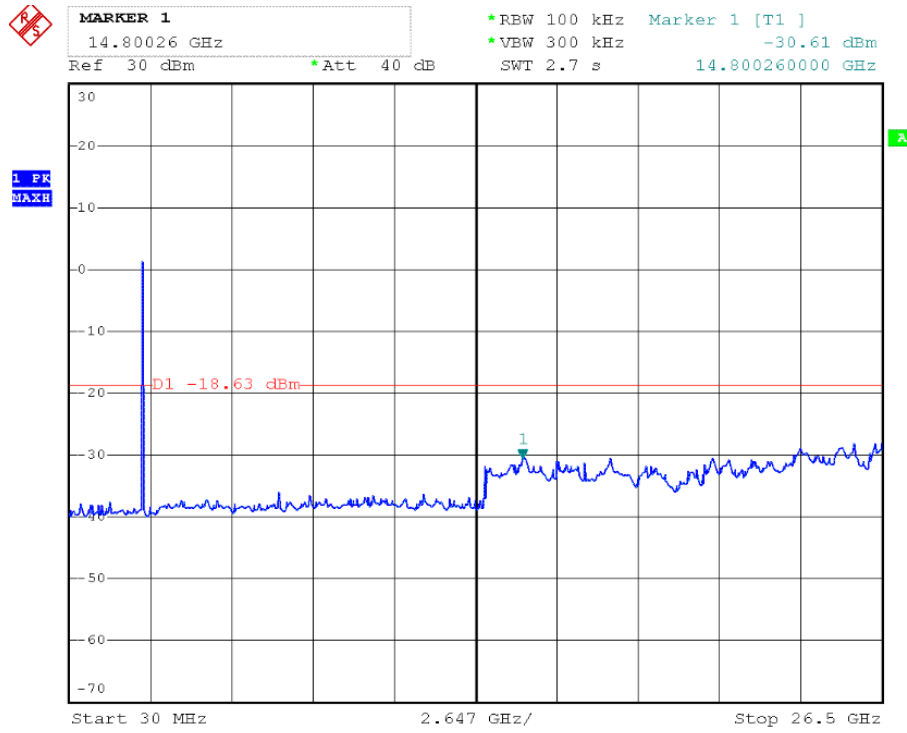

CH High

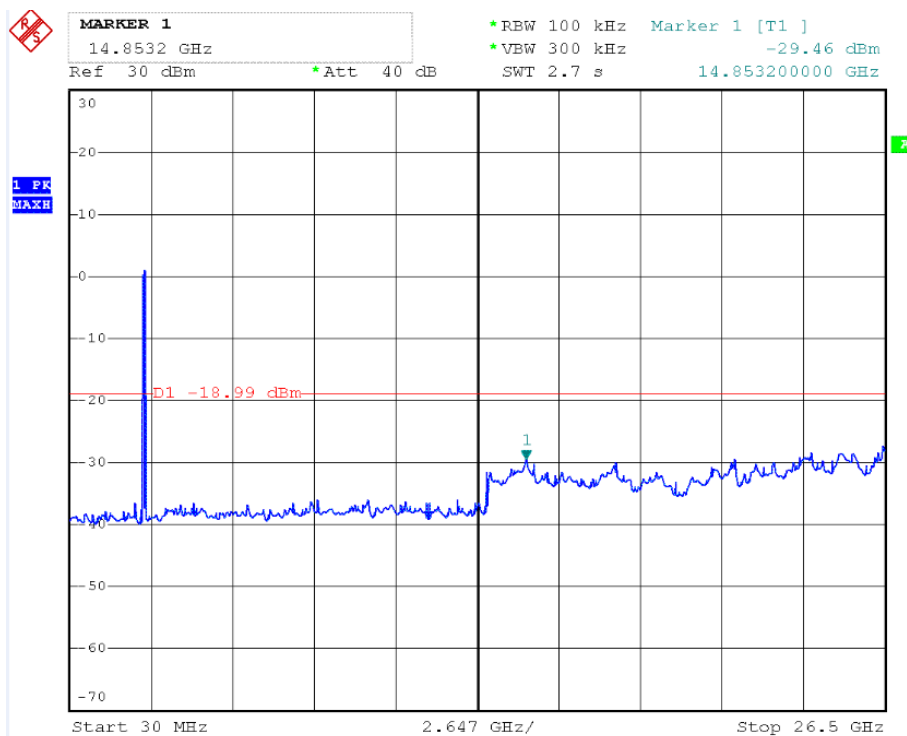

IEEE 802.11n HT20 mode
CH Low

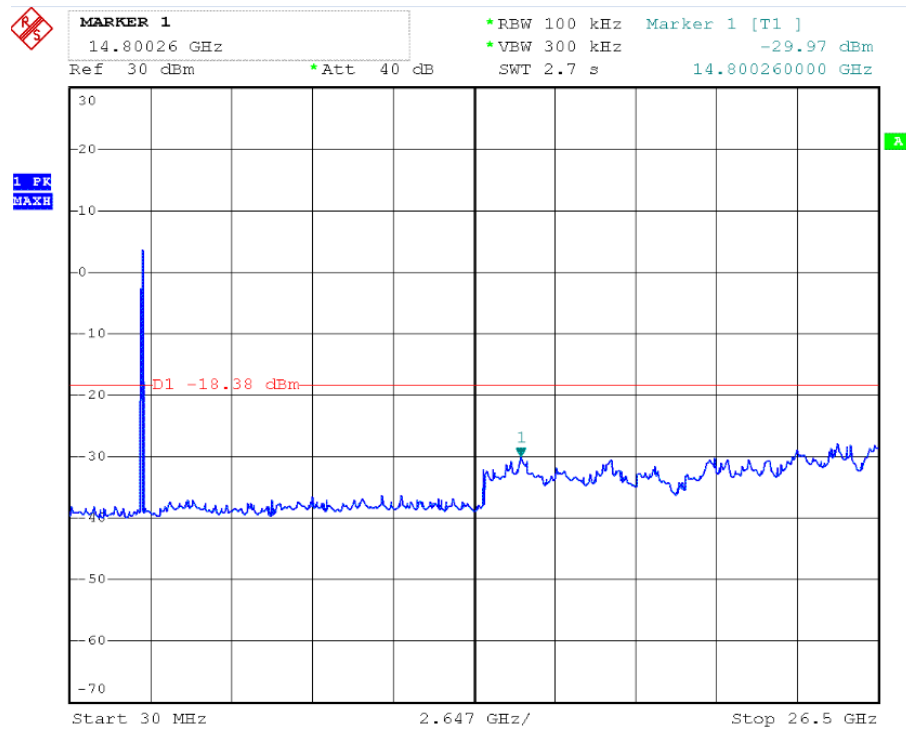

CH Mid

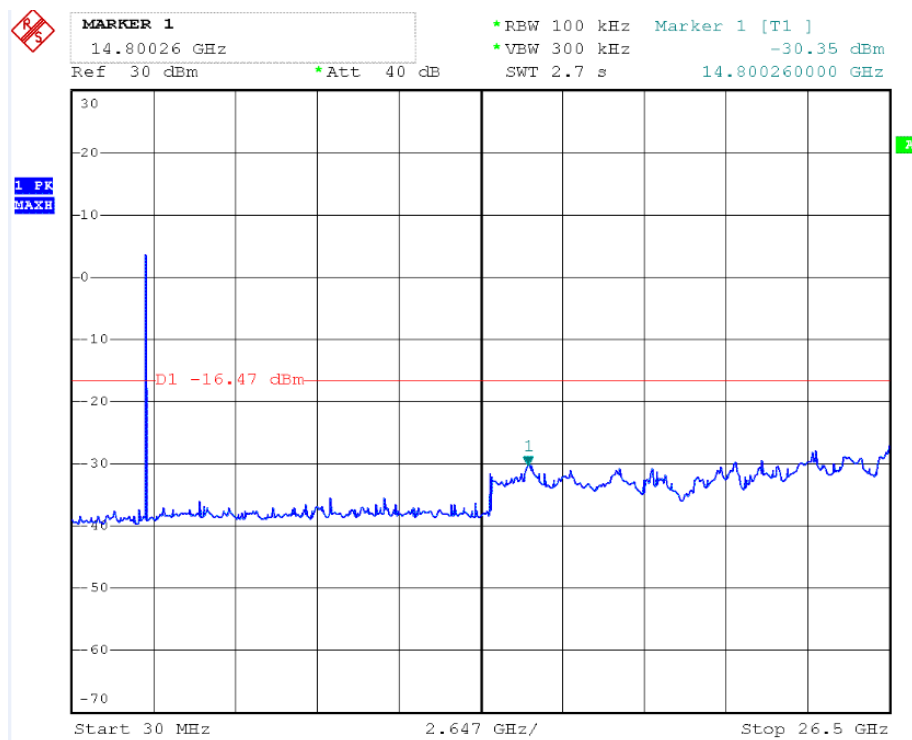

CH High

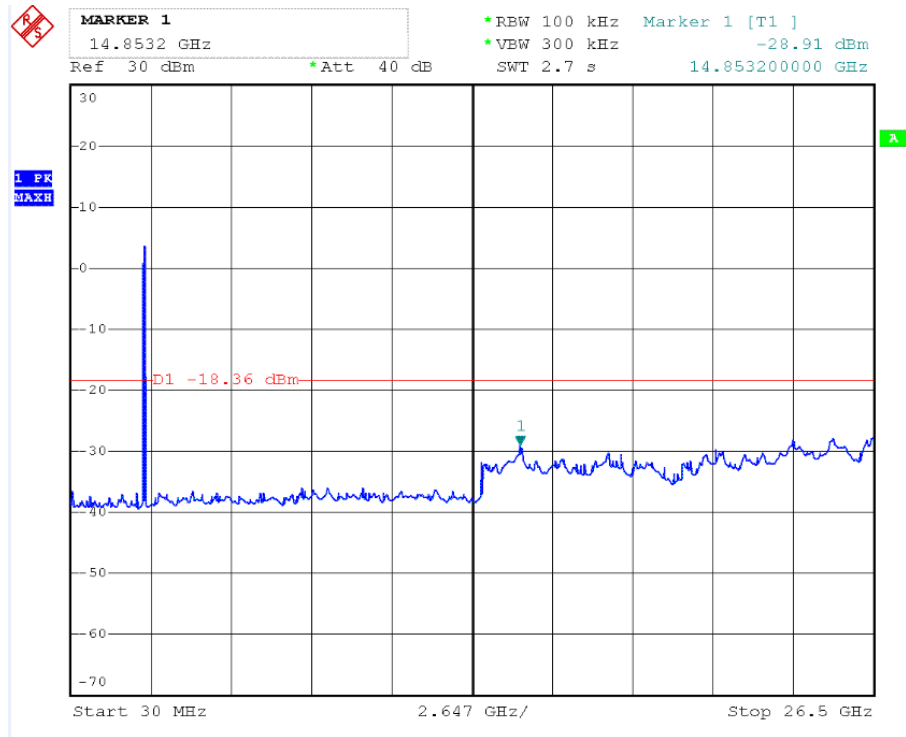

IEEE 802.11n HT40 mode
CH Low

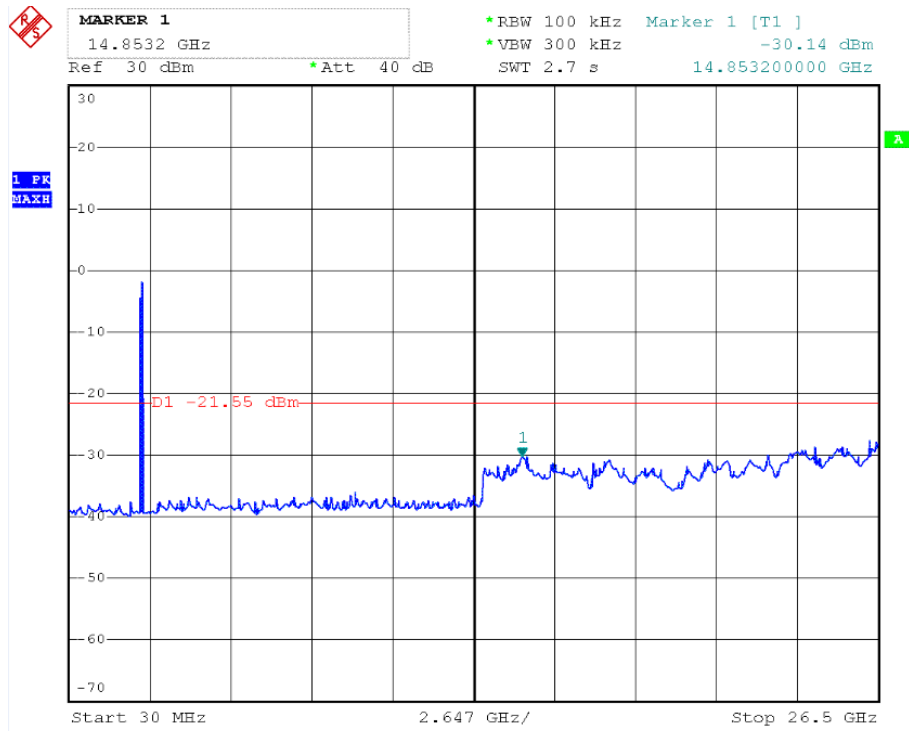

CH Mid

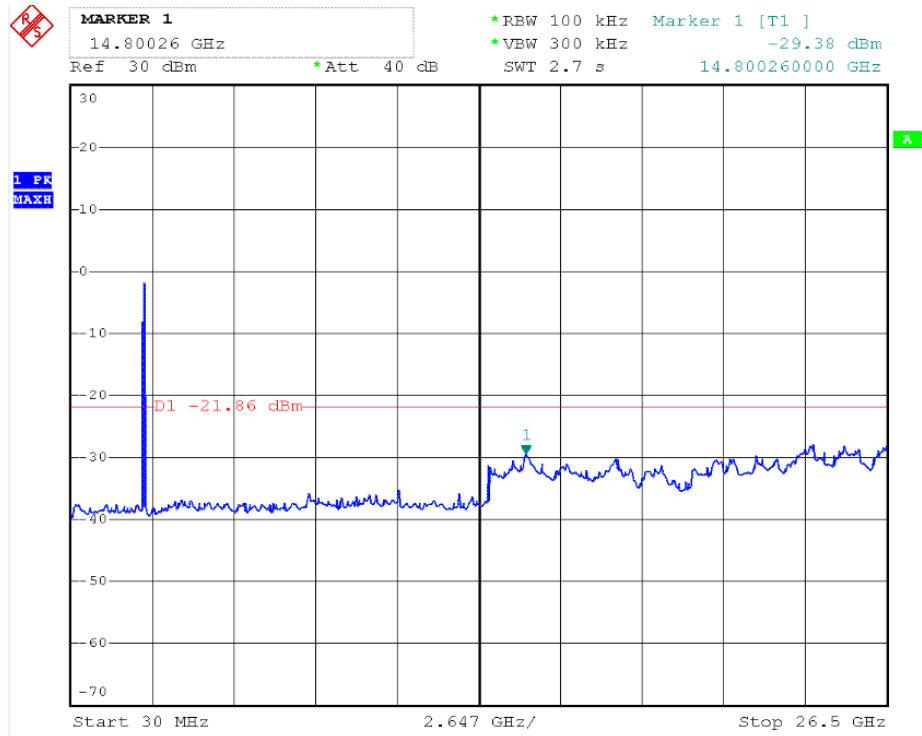

CH High



9. Test of Radiated Spurious Emission

9.1 Radiated Spurious Emission

9.1.1 Limits

15.205 (a) Except as shown in paragraph (d) of this section, only spurious emissions are permitted in any of the frequency bands listed below:

MHz	MHz	MHz	GHz
0.090 - 0.110	16.42 - 16.423	399.9 - 410	4.5 - 5.15
¹ 0.495 - 0.505	16.69475 - 16.69525	608 - 614	5.35 - 5.46
2.1735 - 2.1905	16.80425 - 16.80475	960 - 1240	7.25 - 7.75
4.125 - 4.128	25.5 - 25.67	1300 - 1427	8.025 - 8.5
4.17725 - 4.17775	37.5 - 38.25	1435 - 1626.5	9.0 - 9.2
4.20725 - 4.20775	73 - 74.6	1645.5 - 1646.5	9.3 - 9.5
6.215 - 6.218	74.8 - 75.2	1660 - 1710	10.6 - 12.7
6.26775 - 6.26825	108 - 121.94	1718.8 - 1722.2	13.25 - 13.4
6.31175 - 6.31225	123 - 138	2200 - 2300	14.47 - 14.5
8.291 - 8.294	149.9 - 150.05	2310 - 2390	15.35 - 16.2
8.362 - 8.366	156.52475 - 156.52525	2483.5 - 2500	17.7 - 21.4
8.37625 - 8.38675	156.7 - 156.9	2655 - 2900	22.01 - 23.12
8.41425 - 8.41475	162.0125 - 167.17	3260 - 3267	23.6 - 24.0
12.29 - 12.293	167.72 - 173.2	3332 - 3339	31.2 - 31.8
12.51975 - 12.52025	240 - 285	3345.8 - 3338	36.43 - 36.5
12.57675 - 12.57725	322 - 335.4	3600 - 4400	(²)
13.36 - 13.41			

15.205 (b) Except as provided in paragraphs (d) and (e), the field strength of emissions appearing within these frequency bands shall not exceed the limits shown in Section 15.209. At frequencies equal to or less than 1000 MHz, compliance with the limits in Section 15.209 shall be demonstrated using measurement instrumentation employing a CISPR quasi-peak detector. Above 1000 MHz, compliance with the emission limits in Section 15.209 shall be demonstrated based on the average value of the measured emissions. The provisions in Section 15.35 apply to these measurements.

15.209 (a) Except as provided elsewhere in this Subpart, the emissions from an intentional radiator shall not exceed the field strength levels specified in the following table :

Frequency (MHz)	Field Strength (microvolts/meter)	Measurement Distance (meters)
30 - 88	100 **	3
88 - 216	150 **	3
216 - 960	200 **	3
Above 960	500	3

** Except as provided in paragraph (g), fundamental emissions from intentional radiators operating under this Section shall not be located in the frequency bands 54-72 MHz, 76-88 MHz, 174-216 MHz

or 470-806 MHz, However, operation within these frequency bands is permitted under other sections of this Part, e-g, Sections 15.231 and 15.241.
 15.209 (b) In the emission table above, the tighter limit applies at the band edges.

9.1.2 EUT Setup

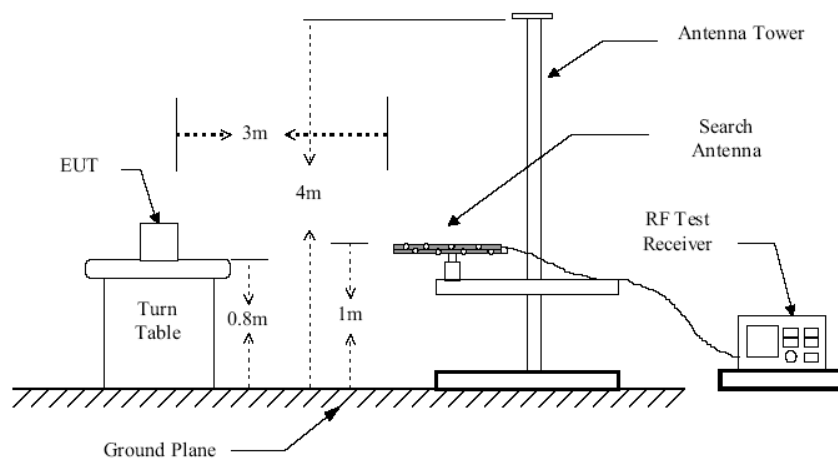
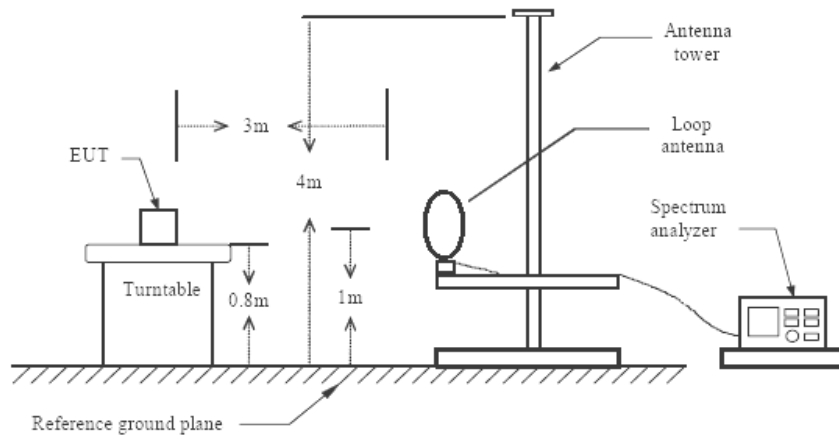

Figure 1 : Frequencies measured below 1 GHz configuration

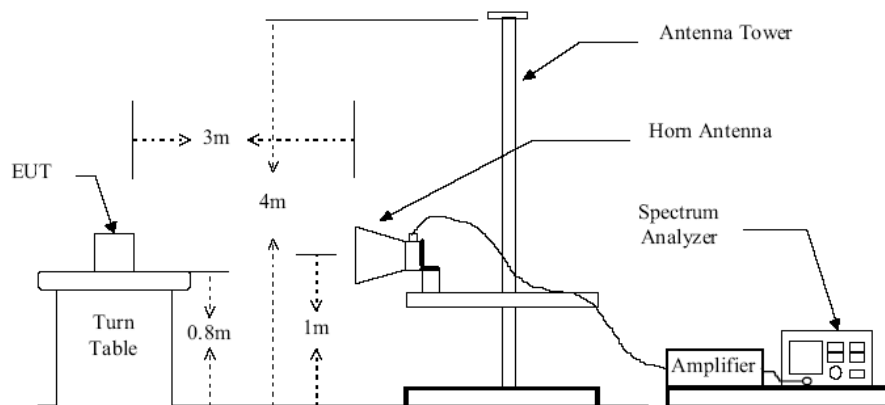

Figure 2 : Frequencies measured above 1 GHz configuration

9.1.3 Test Procedure

1. Configure the EUT according to ANSI C63.4-2003
2. The EUT was placed on the top of the turntable 0.8 meter above ground.
3. The turntable was rotated by 360 degrees to determine the position of the highest radiation.
4. For each suspected emission, the antenna tower was scanned (from 1 M to 4 M) and then the turntable was rotated (from 0 degree to 360 degrees) to find the maximum reading.
5. According to the characteristic of the EUT crystals, the range of frequencies was investigated from 9KHz to 30MHz, 30MHz to 1GHz and 1GHz to 24.8GHz.
6. Any testing performed below 30 MHz was performed using a magnetic loop antenna in accordance with ANSI C63.10: section 4.5, Table 1
7. In accordance with 15.35(b), above 1 GHz, emissions measured using a peak detector shall not exceed a level 20 dB above the average limit.
8. Measurements at 2400 & 2483.5 MHz were made to ensure band edge compliance.
9. Testing was performed with the EUT orientated in three orthogonal planes and the maximum emissions level recorded. In addition, the EUT antenna was varied within its range of motion in order to maximise emissions.
10. For Frequencies below 1 GHz, RBW= 100 kHz, testing was performed with CISPR16 compliant test receiver with QP detector. Above 1 GHz tests were performed using a spectrum analyser using the following settings:
Peak RBW=VBW= 1MHz
Average RBW=VBW= 1MHz

These settings as per ANSI C63.10

9.1.4 Test Result

Temperature (°C) : 22~23	EUT: 40” LED LCD FULL HD SMART TV
Humidity (%RH) : 50~54	M/N: SLD40HG45RQ
Barometric Pressure (mbar) : 950~1000	Operation Condition: Normal operation & TX Mode

Note: In this testing, the EUT was respectively tested in three different orientations. That is:

1. EUT was lie vertically, and then its Antenna oriented upward
2. EUT was lie vertically, and then its Antenna oriented downward
3. EUT was lie flatwise, and then its Antenna oriented to the receiving antenna

The worst test data see following pages

When the EUT was lie flatwise, and its Antenna oriented to the receiving antenna, the worst test data was got as following table.

WORST-CASE RADIATED EMISSION BELOW 30 MHz

Normal operating Mode:

Frequency	Meter Reading	Antenna Factor	Cable Loss	Emission Levels	Limits	Margin	Detector Mode
(MHz)	(dB μ V)	(dB/M)	(dB)	(dB μ V/M)	(dB μ V/M)	(dB)	PK/QP
7.1	23.79	8.23	1.03	30.99	67	-36.01	QP
16.01	22.61	9.07	1.19	30.49	49.5	-19.01	QP
22.79	22.82	9.25	1.08	30.99	49.5	-18.51	QP
25.92	22.68	8.43	1.66	29.45	49.5	-20.05	QP

WORST-CASE RADIATED EMISSION BELOW 1 GHz

Normal operating Mode:

Horizontal

Frequency	Meter Reading	Tansd	Limits	Margin	Detector Mode
(MHz)	(dB μ V)	(dB)	(dB μ V/M)	(dB)	PK/QP
46.9	34.47	15.9	40	-5.53	QP
77.8	38.00	12.0	40	-2.00	QP
174.78	28.47	13.4	43.5	-15.03	QP
297.07	34.56	18.6	46	-11.44	QP
472.06	36.60	22.7	46	-9.40	QP
576.7	37.67	25.5	46	-8.33	QP
N/A	----	----	----	----	----

Vertical

Frequency	Meter Reading	Tansd	Limits	Margin	Detector Mode
(MHz)	(dB μ V)	(dB)	(dB μ V/M)	(dB)	PK/QP
43.57	31.32	15.9	40	-8.68	QP
89.96	38.04	14.8	40	-1.96	QP
167	33.57	13	46	-12.43	QP
259.57	36.30	17.3	46	-9.70	QP
433.76	38.85	22	46	-7.15	QP
929.58	37.57	29.4	46	-8.43	QP
N/A	----	----	----	----	----

Note: 1. Transd.=Antenna Factor+Cable Loss-Pre-amplifier
Margin = Level-Limit

**WORST-CASE RADIATED EMISSION ABOVE 1 GHz
IEEE 802.11b TX (CH Low)**

Channel Low (2412MHz)								
Maximum Frequency (MHz)	Polarity and Level					Limit (dBµV/m)	Margin (dBµV/m)	Mark (P/Q/A)
	Polarity	Height (m)	Reading dBµV	Transd	Result dBµV/m			
1385.21	H	1	50.71	-7.97	42.74	74	-31.26	P
			37.8	-7.97	29.83	54	-24.17	A
1368.33	V	1	50.8	-7.97	42.83	74	-31.17	P
			37.18	-7.97	29.21	54	-24.79	A
2412	H	1	110.68	-6.47	104.21	----	----	P
			103.98	-6.47	97.51	----	----	A
2412	V	1	114.68	-6.47	108.21	----	----	P
			104.69	-6.47	98.22	----	----	A
4824	H	1	45.73	0.52	46.25	74	-27.75	P
			34.71	0.52	35.23	54	-18.77	A
4824	V	1	47.15	0.52	47.67	74	-26.33	P
			34.66	0.52	35.18	54	-18.82	A
7236	H	1	44.59	7.41	52	74	-22.00	P
			35.07	7.41	42.48	54	-11.52	A
7236	V	1	44.59	7.41	52	74	-22.00	P
			34.9	7.41	42.31	54	-11.69	A
11145.34	H	1	----	----	----	----	----	----
16327.65	----	----	----	----	----	----	----	----
25376.32	----	----	----	----	----	----	----	----

Remark: 1. Transd.=Antenna Factor+Cable Loss-Pre-amplifier
Margin = Level-Limit
Mark: P means Peak Value, Q means Quasi Peak Value, A means Average Value
2. Data of measurement within this frequency range shown “-” in the table above means the reading of emissions are attenuated more than 20dB below the permissible limits or the field strength is too small to be measured.
3. Spectrum analyzer setting P(Peak): RBW=1MHz, VBW=1MHz, A(Average): RBW=1MHz, VBW=10Hz.
4. The test limit distance is 3m limit

IEEE 802.11b TX (CH Middle)

Channel Middle (2437MHz)								
Maximum Frequency (MHz)	Polarity and Level					Limit (dBµV/m)	Margin (dBµV/m)	Mark (P/Q/A)
	Polarity	Height (m)	Reading dBµV	Transd	Result dBµV/m			
1311.67	H	1	49.87	-8.23	41.64	74	-32.36	P
			38.48	-8.23	30.25	54	-23.75	A
1311.67	V	1	50.45	-8.23	42.22	74	-31.78	P
			39.18	-8.23	30.95	54	-23.05	A
2437	H	1	110.63	-6.37	104.26	----	----	P
			99.56	-6.37	93.19	----	----	A
2437	V	1	114.67	-6.37	108.3	----	----	P
			103.71	-6.37	97.34	----	----	A
4874	H	1	45.21	0.75	45.96	74	-28.04	P
			35.08	0.75	35.83	54	-18.17	A
4874	V	1	46.69	0.75	47.44	74	-26.56	P
			36.08	0.75	36.83	54	-17.17	A
7311	H	1	43.85	7.48	51.33	74	-22.67	P
			35.28	7.48	42.76	54	-11.24	A
7311	V	1	44.52	7.48	52.00	74	-22.00	P
			35.17	7.48	42.65	54	-11.35	A
11238.52	H	1	----	----	----	----	----	----
16327.71	----	----	----	----	----	----	----	----
25376.58	----	----	----	----	----	----	----	----

Remark: 1. Transd.=Antenna Factor+Cable Loss-Pre-amplifier
Margin = Level-Limit
Mark: P means Peak Value, Q means Quasi Peak Value, A means Average Value
2. Data of measurement within this frequency range shown “-” in the table above means the reading of emissions are attenuated more than 20dB below the permissible limits or the field strength is too small to be measured.
3. Spectrum analyzer setting P(Peak): RBW=1MHz, VBW=1MHz, A(Average): RBW=1MHz, VBW=10Hz.
4. The test limit distance is 3m limit

IEEE 802.11b TX (CH High)

Channel High (2462MHz)								
Maximum Frequency (MHz)	Polarity and Level					Limit (dBµV/m)	Margin (dBµV/m)	Mark (P/Q/A)
	Polarity	Height (m)	Reading dBµV	Transd	Result dBµV/m			
1311.67	H	1	50.21	-8.23	41.98	74	-32.02	P
			38.11	-8.23	29.88	54	-24.12	A
1311.67	V	1	50.71	-8.23	42.48	74	-31.52	P
			38.22	-8.23	29.99	54	-24.01	A
2462	H	1	113.18	-6.28	106.9	----	----	P
			100.18	-6.28	93.9	----	----	A
2462	V	1	114.71	-6.28	108.43	----	----	P
			103.92	-6.28	97.64	----	----	A
4924	H	1	45.51	0.97	46.48	74	-27.52	P
			35.18	0.97	36.15	54	-17.85	A
4924	V	1	49.03	0.97	50.00	74	-24.00	P
			36.17	0.97	37.14	54	-16.86	A
7386	H	1	44.92	7.56	52.48	74	-21.52	P
			34.68	7.56	42.24	54	-11.76	A
7386	V	1	44.28	7.56	51.84	74	-22.16	P
			34.19	7.56	41.75	54	-12.25	A
11243.58	H	1	----	----	----	----	----	----
16327.45	----	----	----	----	----	----	----	----
25376.26	----	----	----	----	----	----	----	----

Remark: 1. Transd.=Antenna Factor+Cable Loss-Pre-amplifier
Margin = Level-Limit
Mark: P means Peak Value, Q means Quasi Peak Value, A means Average Value
2. Data of measurement within this frequency range shown “-” in the table above means the reading of emissions are attenuated more than 20dB below the permissible limits or the field strength is too small to be measured.
3. Spectrum analyzer setting P(Peak): RBW=1MHz, VBW=1MHz, A(Average): RBW=1MHz, VBW=10Hz.
4. The test limit distance is 3m limit

IEEE 802.11g TX (CH Low)

Channel Low (2412MHz)								
Maximum Frequency (MHz)	Polarity and Level					Limit (dBµV/m)	Margin (dBµV/m)	Mark (P/Q/A)
	Polarity	Height (m)	Reading dBµV	Transd	Result dBµV/m			
1383.65	H	1	49.56	-7.97	41.59	74	-32.41	P
			36.80	-7.97	28.83	54	-25.17	A
1383.65	V	1	48.98	-7.97	41.01	74	-32.99	P
			36.41	-7.97	28.44	54	-25.56	A
2412	H	1	106.72	-6.47	100.25	----	----	P
			96.11	-6.47	89.64	----	----	A
2412	V	1	108.71	-6.47	102.24	----	----	P
			97.91	-6.47	91.44	----	----	A
4824	H	1	44.18	0.52	44.7	74	-29.3	P
			33.80	0.52	34.32	54	-19.68	A
4824	V	1	45.00	0.52	45.52	74	-28.48	P
			33.71	0.52	34.23	54	-19.77	A
7236	H	1	44.08	7.41	51.49	74	-22.51	P
			34.17	7.41	41.58	54	-12.42	A
7236	V	1	44.87	7.41	52.28	74	-21.72	P
			34.28	7.41	41.69	54	-12.31	A
11145.34	H	1	----	----	----	----	----	----
16327.65	----	----	----	----	----	----	----	----
25376.32	----	----	----	----	----	----	----	----

Remark: 1. Transd.=Antenna Factor+Cable Loss-Pre-amplifier
Margin = Level-Limit
Mark: P means Peak Value, Q means Quasi Peak Value, A means Average Value
2. Data of measurement within this frequency range shown “-” in the table above means the reading of emissions are attenuated more than 20dB below the permissible limits or the field strength is too small to be measured.
3. Spectrum analyzer setting P(Peak): RBW=1MHz, VBW=1MHz, A(Average): RBW=1MHz, VBW=10Hz.
4. The test limit distance is 3m limit

IEEE 802.11g TX (CH Middle)

Channel Middle (2437MHz)								
Maximum Frequency (MHz)	Polarity and Level					Limit (dBµV/m)	Margin (dBµV/m)	Mark (P/Q/A)
	Polarity	Height (m)	Reading dBµV	Transd	Result dBµV/m			
1323.78	H	1	48.69	-8.23	40.46	74	-33.54	P
			36.8	-8.23	28.57	54	-25.43	A
1323.78	V	1	49.71	-8.23	41.48	74	-32.52	P
			37.02	-8.23	28.79	54	-25.21	A
2437	H	1	105.68	-6.37	99.31	----	----	P
			96.2	-6.37	89.83	----	----	A
2437	V	1	109.18	-6.37	102.81	----	----	P
			97.71	-6.37	91.34	----	----	A
4874	H	1	44.87	0.75	45.62	74	-28.38	P
			34.18	0.75	34.93	54	-19.07	A
4874	V	1	45	0.75	45.75	74	-28.25	P
			34.2	0.75	34.95	54	-19.05	A
7311	H	1	44.07	7.48	51.55	74	-22.45	P
			33.71	7.48	41.19	54	-12.81	A
7311	V	1	44.18	7.48	51.66	74	-22.34	P
			34.09	7.48	41.57	54	-12.43	A
11238.52	H	1	----	----	----	----	----	----
16327.71	----	----	----	----	----	----	----	----
25376.58	----	----	----	----	----	----	----	----

Remark: 1. Transd.=Antenna Factor+Cable Loss-Pre-amplifier
Margin = Level-Limit
Mark: P means Peak Value, Q means Quasi Peak Value, A means Average Value
2. Data of measurement within this frequency range shown “-” in the table above means the reading of emissions are attenuated more than 20dB below the permissible limits or the field strength is too small to be measured.
3. Spectrum analyzer setting P(Peak): RBW=1MHz, VBW=1MHz, A(Average): RBW=1MHz, VBW=10Hz.
4. The test limit distance is 3m limit

IEEE 802.11g TX (CH High)

Channel High (2462MHz)								
Maximum Frequency (MHz)	Polarity and Level					Limit (dBµV/m)	Margin (dBµV/m)	Mark (P/Q/A)
	Polarity	Height (m)	Reading dBµV	Transd	Result dBµV/m			
1311.67	H	1	48.96	-8.23	40.73	74	-33.27	P
			37.18	-8.23	28.95	54	-25.05	A
1311.67	V	1	49.67	-8.23	41.44	74	-32.56	P
			37.76	-8.23	29.53	54	-24.47	A
2462	H	1	104.87	-6.28	98.59	----	----	P
			94.98	-6.28	88.7	----	----	A
2462	V	1	107.87	-6.28	101.59	----	----	P
			95.91	-6.28	89.63	----	----	A
4924	H	1	43.9	0.97	44.87	74	-29.13	P
			33.71	0.97	34.68	54	-19.32	A
4924	V	1	46.7	0.97	47.67	74	-26.33	P
			35.02	0.97	35.99	54	-18.01	A
7386	H	1	44.91	7.56	52.47	74	-21.53	P
			33.98	7.56	41.54	54	-12.46	A
7386	V	1	43.76	7.56	51.32	74	-22.68	P
			33.71	7.56	41.27	54	-12.73	A
11243.58	H	1	----	----	----	----	----	----
16327.45	----	----	----	----	----	----	----	----
25376.26	----	----	----	----	----	----	----	----

Remark: 1. Transd.=Antenna Factor+Cable Loss-Pre-amplifier
Margin = Level-Limit
Mark: P means Peak Value, Q means Quasi Peak Value, A means Average Value
2. Data of measurement within this frequency range shown “-” in the table above means the reading of emissions are attenuated more than 20dB below the permissible limits or the field strength is too small to be measured.
3. Spectrum analyzer setting P(Peak): RBW=1MHz, VBW=1MHz, A(Average): RBW=1MHz, VBW=10Hz.
4. The test limit distance is 3m limit

IEEE 802.11n HT20 TX (CH Low)

Channel Low (2412MHz)								
Maximum Frequency (MHz)	Polarity and Level					Limit (dBµV/m)	Margin (dBµV/m)	Mark (P/Q/A)
	Polarity	Height (m)	Reading dBµV	Transd	Result dBµV/m			
1396.67	H	1	49.3	-7.84	41.46	74	-32.54	P
			36.96	-7.84	29.12	54	-24.88	A
1396.67	V	1	48.74	-7.84	40.9	74	-33.1	P
			36.71	-7.84	28.87	54	-25.13	A
2412	H	1	103.71	-6.47	97.24	----	----	P
			91.92	-6.47	85.45	----	----	A
2412	V	1	105.18	-6.47	98.71	----	----	P
			93.17	-6.47	86.7	----	----	A
4824	H	1	45.25	0.52	45.77	74	-28.23	P
			33.71	0.52	34.23	54	-19.77	A
4824	V	1	44.81	0.52	45.33	74	-28.67	P
			33.71	0.52	34.23	54	-19.77	A
7236	H	1	43.42	7.41	50.83	74	-23.17	P
			34.13	7.41	41.54	54	-12.46	A
7236	V	1	43.61	7.41	51.02	74	-22.98	P
			33.48	7.41	40.89	54	-13.11	A
11145.34	H	1	----	----	----	----	----	----
16327.65	----	----	----	----	----	----	----	----
25376.32	----	----	----	----	----	----	----	----

Remark: 1. Transd.=Antenna Factor+Cable Loss-Pre-amplifier
Margin = Level-Limit
Mark: P means Peak Value, Q means Quasi Peak Value, A means Average Value
2. Data of measurement within this frequency range shown “-” in the table above means the reading of emissions are attenuated more than 20dB below the permissible limits or the field strength is too small to be measured.
3. Spectrum analyzer setting P(Peak): RBW=1MHz, VBW=1MHz, A(Average): RBW=1MHz, VBW=10Hz.
4. The test limit distance is 3m limit

IEEE 802.11n HT20 TX (CH Middle)

Channel Middle (2437MHz)								
Maximum Frequency (MHz)	Polarity and Level					Limit (dBµV/m)	Margin (dBµV/m)	Mark (P/Q/A)
	Polarity	Height (m)	Reading dBµV	Transd	Result dBµV/m			
1719.35	H	1	52.67	-9.09	43.58	74	-30.42	P
			40.78	-9.09	31.69	54	-22.31	A
1719.35	V	1	49.44	-9.09	40.35	74	-33.65	P
			36.66	-9.09	27.57	54	-26.43	A
2437	H	1	104.78	-6.37	98.41	----	----	P
			95.71	-6.37	89.34	----	----	A
2437	V	1	106.71	-6.37	100.34	----	----	P
			97.18	-6.37	90.81	----	----	A
4874	H	1	44.5	0.75	45.25	74	-28.75	P
			33.87	0.75	34.62	54	-19.38	A
4874	V	1	44.49	0.75	45.24	74	-28.76	P
			33.91	0.75	34.66	54	-19.34	A
7311	H	1	44.22	7.48	51.7	74	-22.3	P
			33.71	7.48	41.19	54	-12.81	A
7311	V	1	43.49	7.48	50.97	74	-23.03	P
			33.91	7.48	41.39	54	-12.61	A
11238.52	H	1	----	----	----	----	----	----
16327.71	----	----	----	----	----	----	----	----
25376.58	----	----	----	----	----	----	----	----

Remark: 1. Transd.=Antenna Factor+Cable Loss-Pre-amplifier
Margin = Level-Limit
Mark: P means Peak Value, Q means Quasi Peak Value, A means Average Value
2. Data of measurement within this frequency range shown “-” in the table above means the reading of emissions are attenuated more than 20dB below the permissible limits or the field strength is too small to be measured.
3. Spectrum analyzer setting P(Peak): RBW=1MHz, VBW=1MHz, A(Average): RBW=1MHz, VBW=10Hz.
4. The test limit distance is 3m limit

IEEE 802.11n HT20 TX (CH High)

Channel High (2462MHz)								
Maximum Frequency (MHz)	Polarity and Level					Limit (dBµV/m)	Margin (dBµV/m)	Mark (P/Q/A)
	Polarity	Height (m)	Reading dBµV	Transd	Result dBµV/m			
1321.85	H	1	50.2	-8.23	41.97	74	-32.03	P
			36.79	-8.23	28.56	54	-25.44	A
1321.85	V	1	49.42	-8.23	41.19	74	-32.81	P
			37.07	-8.23	28.84	54	-25.16	A
2462	H	1	103.87	-6.28	97.59	----	----	P
			94.22	-6.28	87.94	----	----	A
2462	V	1	106	-6.28	99.72	----	----	P
			93.92	-6.28	87.64	----	----	A
4924	H	1	44.66	0.97	45.63	74	-28.37	P
			34.17	0.97	35.14	54	-18.86	A
4924	V	1	44.6	0.97	45.57	74	-28.43	P
			33.91	0.97	34.88	54	-19.12	A
7386	H	1	43.88	7.56	51.44	74	-22.56	P
			34.17	7.56	41.73	54	-12.27	A
7386	V	1	43.09	7.56	50.65	74	-23.35	P
			33.18	7.56	40.74	54	-13.26	A
11243.58	H	1	----	----	----	----	----	----
16327.45	----	----	----	----	----	----	----	----
25376.26	----	----	----	----	----	----	----	----

Remark: 1. Transd.=Antenna Factor+Cable Loss-Pre-amplifier
Margin = Level-Limit
Mark: P means Peak Value, Q means Quasi Peak Value, A means Average Value
2. Data of measurement within this frequency range shown “-” in the table above means the reading of emissions are attenuated more than 20dB below the permissible limits or the field strength is too small to be measured.
3. Spectrum analyzer setting P(Peak): RBW=1MHz, VBW=1MHz, A(Average): RBW=1MHz, VBW=10Hz.
4. The test limit distance is 3m limit

IEEE 802.11n HT40 TX (CH Low)

Channel Low (2422MHz)								
Maximum Frequency (MHz)	Polarity and Level					Limit (dBµV/m)	Margin (dBµV/m)	Mark (P/Q/A)
	Polarity	Height (m)	Reading dBµV	Transd	Result dBµV/m			
1338.67	H	1	48.71	-7.84	40.87	74	-33.13	P
			36.78	-7.84	28.94	54	-25.06	A
1338.67	V	1	49.97	-7.84	42.13	74	-31.87	P
			36.66	-7.84	28.82	54	-25.18	A
2422	H	1	100.08	-6.47	93.61	----	----	P
			90.69	-6.47	84.22	----	----	A
2422	V	1	102.69	-6.47	96.22	----	----	P
			91.91	-6.47	85.44	----	----	A
4844	H	1	44.19	0.52	44.71	74	-29.29	P
			33.7	0.52	34.22	54	-19.78	A
4844	V	1	44.98	0.52	45.5	74	-28.5	P
			33.66	0.52	34.18	54	-19.82	A
7266	H	1	43.87	7.41	51.28	74	-22.72	P
			33.98	7.41	41.39	54	-12.61	A
7266	V	1	44.18	7.41	51.59	74	-22.41	P
			33.96	7.41	41.37	54	-12.63	A
11145.34	H	1	----	----	----	----	----	----
16327.65	----	----	----	----	----	----	----	----
25376.32	----	----	----	----	----	----	----	----

Remark: 1. Transd.=Antenna Factor+Cable Loss-Pre-amplifier
Margin = Level-Limit
Mark: P means Peak Value, Q means Quasi Peak Value, A means Average Value
2. Data of measurement within this frequency range shown “-” in the table above means the reading of emissions are attenuated more than 20dB below the permissible limits or the field strength is too small to be measured.
3. Spectrum analyzer setting P(Peak): RBW=1MHz, VBW=1MHz, A(Average): RBW=1MHz, VBW=10Hz.
4. The test limit distance is 3m limit

IEEE 802.11n HT40 TX (CH Mid)

Channel Middle (2437MHz)								
Maximum Frequency (MHz)	Polarity and Level					Limit (dBµV/m)	Margin (dBµV/m)	Mark (P/Q/A)
	Polarity	Height (m)	Reading dBµV	Transd	Result dBµV/m			
1326.35	H	1	50.08	-7.84	42.24	74	-31.76	P
			36.96	-7.84	29.12	54	-24.88	A
1326.35	V	1	49.17	-7.84	41.33	74	-32.67	P
			36.98	-7.84	29.14	54	-24.86	A
2437	H	1	100.87	-6.37	94.5	----	----	P
			91.08	-6.37	84.71	----	----	A
2437	V	1	104.73	-6.37	98.36	----	----	P
			94.18	-6.37	87.81	----	----	A
4874	H	1	43.7	0.75	44.45	74	-29.55	P
			33.87	0.75	34.62	54	-19.38	A
4874	V	1	44.95	0.75	45.7	74	-28.3	P
			33.87	0.75	34.62	54	-19.38	A
7311	H	1	42.91	7.48	50.39	74	-23.61	P
			33.66	7.48	41.14	54	-12.86	A
7311	V	1	43.18	7.48	50.66	74	-23.34	P
			33.96	7.48	41.44	54	-12.56	A
11238.52	H	1	----	----	----	----	----	----
16327.71	----	----	----	----	----	----	----	----
25376.58	----	----	----	----	----	----	----	----

Remark: 1. Transd.=Antenna Factor+Cable Loss-Pre-amplifier
Margin = Level-Limit
Mark: P means Peak Value, Q means Quasi Peak Value, A means Average Value
2. Data of measurement within this frequency range shown “-” in the table above means the reading of emissions are attenuated more than 20dB below the permissible limits or the field strength is too small to be measured.
3. Spectrum analyzer setting P(Peak): RBW=1MHz, VBW=1MHz, A(Average): RBW=1MHz, VBW=10Hz.
4. The test limit distance is 3m limit

IEEE 802.11n HT40 TX (CH High)

Channel High (2452MHz)								
Maximum Frequency (MHz)	Polarity and Level					Limit (dBµV/m)	Margin (dBµV/m)	Mark (P/Q/A)
	Polarity	Height (m)	Reading dBµV	Transd	Result dBµV/m			
1337.63	H	1	49.02	-8.23	40.79	74	-33.21	P
			36.71	-8.23	28.48	54	-25.52	A
1337.63	V	1	49.41	-8.23	41.18	74	-32.82	P
			36.69	-8.23	28.46	54	-25.54	A
2452	H	1	100.08	-6.28	93.8	----	----	P
			90.68	-6.28	84.4	----	----	A
2452	V	1	103.87	-6.28	97.59	----	----	P
			93.18	-6.28	86.9	----	----	A
4904	H	1	43.71	0.97	44.68	74	-29.32	P
			33.66	0.97	34.63	54	-19.37	A
4904	V	1	44.87	0.97	45.84	74	-28.16	P
			33.66	0.97	34.63	54	-19.37	A
7356	H	1	42.91	7.56	50.47	74	-23.53	P
			33.69	7.56	41.25	54	-12.75	A
7356	V	1	43.71	7.56	51.27	74	-22.73	P
			33.92	7.56	41.48	54	-12.52	A
11243.58	H	1	----	----	----	----	----	----
16327.45	----	----	----	----	----	----	----	----
25376.26	----	----	----	----	----	----	----	----

Remark: 1. Transd.=Antenna Factor+Cable Loss-Pre-amplifier
Margin = Level-Limit
Mark: P means Peak Value, Q means Quasi Peak Value, A means Average Value
2. Data of measurement within this frequency range shown “-” in the table above means the reading of emissions are attenuated more than 20dB below the permissible limits or the field strength is too small to be measured.
3. Spectrum analyzer setting P(Peak): RBW=1MHz, VBW=1MHz, A(Average): RBW=1MHz, VBW=10Hz.
4. The test limit distance is 3m limit

10. Test of Band Edges Emission

10.1 Applicable Standard

Section 15.247(d): In any 100 kHz bandwidth outside the frequency band in which the spread spectrum or digitally modulated intentional radiator is operating, the radio frequency power that is produced by the intentional radiator shall be at least 20 dB below that in the 100 kHz bandwidth within the band that contains the highest level of the desired power, based on either an RF conducted or a radiated measurement. In addition, radiated emissions that fall in the restricted bands, as defined in Section 15.205, must also comply with the radiated emission limits specified in Section 15.209.

10.2 EUT Setup

Radiated Measurement Setup

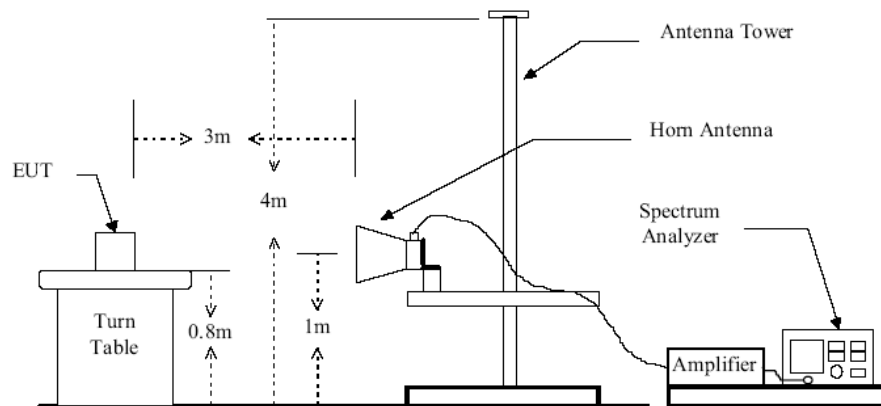
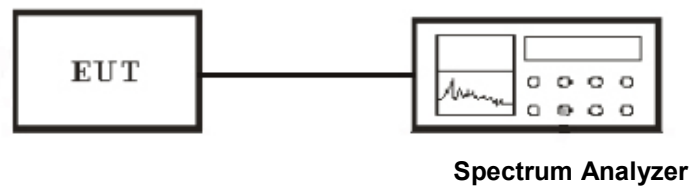

Figure 2 : Frequencies measured above 1 GHz configuration

Conducted Measurement Setup



10.3 Test Equipment List and Details

See section 2.5.

10.4 Test Procedure

Conducted Measurement

1. The transmitter is set to the lowest channel.
2. The transmitter output was connected to the spectrum analyzer via a cable and cable loss is used as the offset of the spectrum analyzer.

3. Set both RBW and VBW of spectrum analyzer to 100KHz with convenient frequency span including 100MHz bandwidth from lower band edge. Then detector set to peak and max hold this trace.
4. The lowest band edges emission was measured and recorded.
5. The transmitter set to the highest channel and repeated 2~4.

Radiated Measurement

1. Configure the EUT according to ANSI C63.4-2003
2. The turntable was rotated by 360 degrees to determine the position of the highest radiation.
3. The height of the broadband receiving antenna was varied between one meter and four meters above ground to find the maximum emission field strength of both horizontal and vertical polarization.
4. For band edge emission, the antenna tower was scan (from 1 M to 4 M) and then the turn table was rotated (from 0 degree to 360 degrees) to find the maximum reading.
5. For band edge emission, use 1MHz VBW and 1MHz RBW for reading under AV and use 1MHz VBW and 1MHz RBW for reading under PK.

10.5 Test Result

Temperature (°C) : 22~23	EUT: 40"LED LCD FULL HD SMART TV
Humidity (%RH) : 50~54	M/N: SLD40HG45RQ
Barometric Pressure (mbar) : 950~1000	Operation Condition: Tx Mode

Radiated Test Result

TEST RESULT

IEEE 802.11b mode

Channel	Freq.(MHz)	Level(dBuV)	Limit(dBuV)	Margin(dB)	Detector
	2390	48.87	74	-25.13	Peak
LOW	2390	36.68	54	-17.32	Average
	2483.5	47.91	74	-26.09	Peak
HIGH	2483.5	36.48	54	-17.52	Average

IEEE 802.11g mode

Channel	Freq.(MHz)	Level(dBuV)	Limit(dBuV)	Margin(dB)	Detector
	2390	47.85	74	-26.15	Peak
LOW	2390	35.70	54	-18.30	Average
	2483.5	48.71	74	-25.29	Peak
HIGH	2483.5	36.49	54	-17.51	Average

IEEE 802.11n HT20 mode

Channel	Freq.(MHz)	Level(dBuV)	Limit(dBuV)	Margin(dB)	Detector
	2390	47.91	74	-26.09	Peak
LOW	2390	36.18	54	-17.82	Average
	2483.5	48.71	74	-25.29	Peak
HIGH	2483.5	36.70	54	-17.30	Average

EEE 802.11n HT40 mode

Channel	Freq.(MHz)	Level(dBuV)	Limit(dBuV)	Margin(dB)	Detector
	2390	47.92	74	-26.08	Peak
LOW	2390	35.71	54	-18.29	Average
	2483.5	46.67	74	-27.33	Peak
HIGH	2483.5	34.86	54	-19.14	Average

Test of Conducted band edges

CH Low (802.11b MODE)

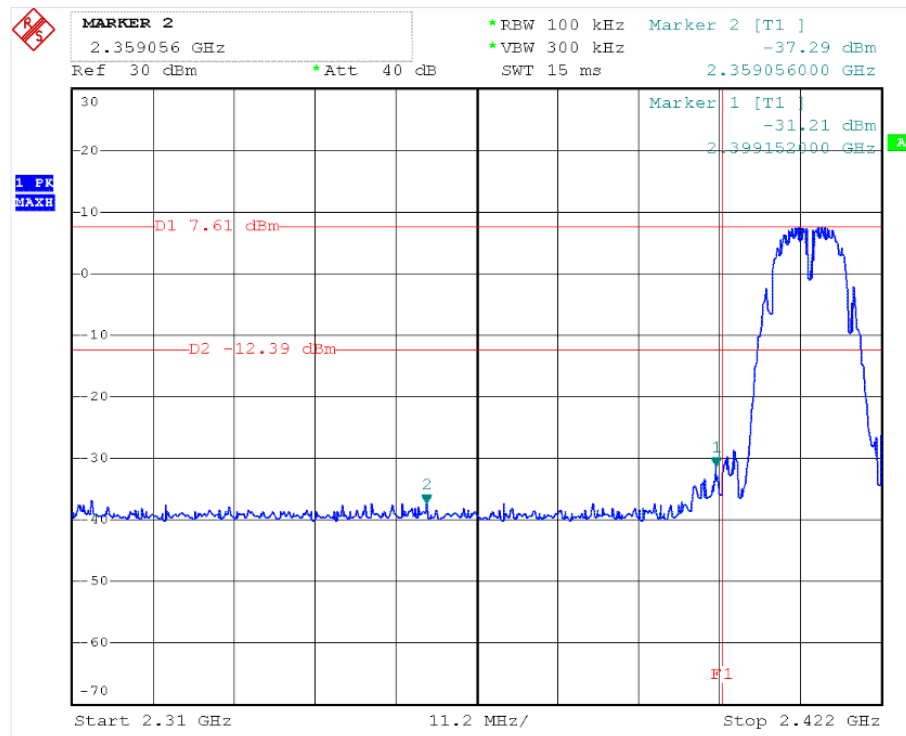

CH High (802.11b MODE)

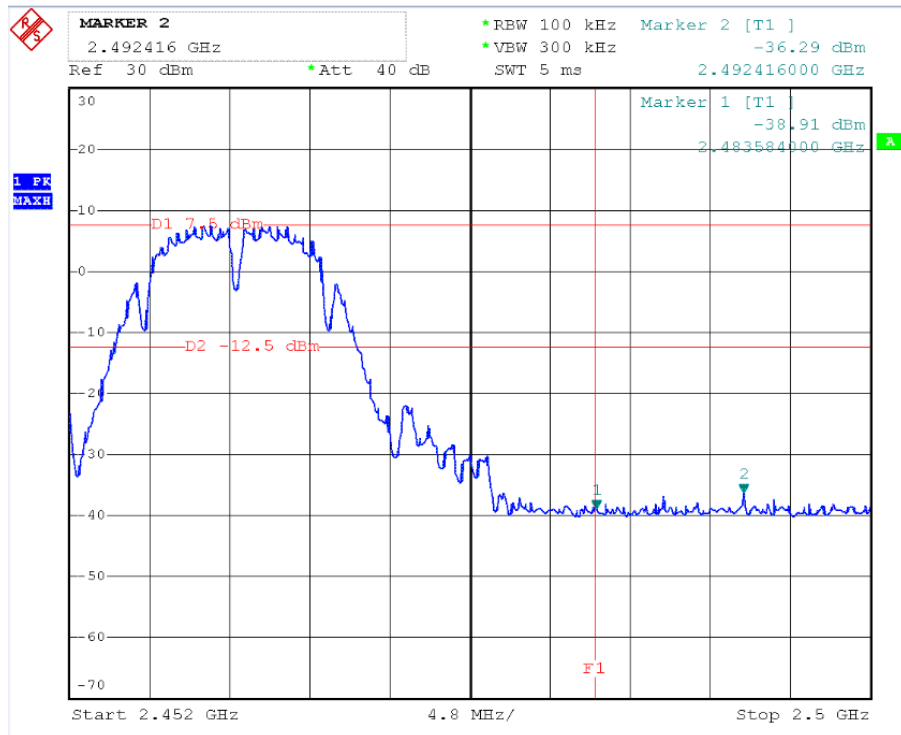

CH Low (802.11g MODE)

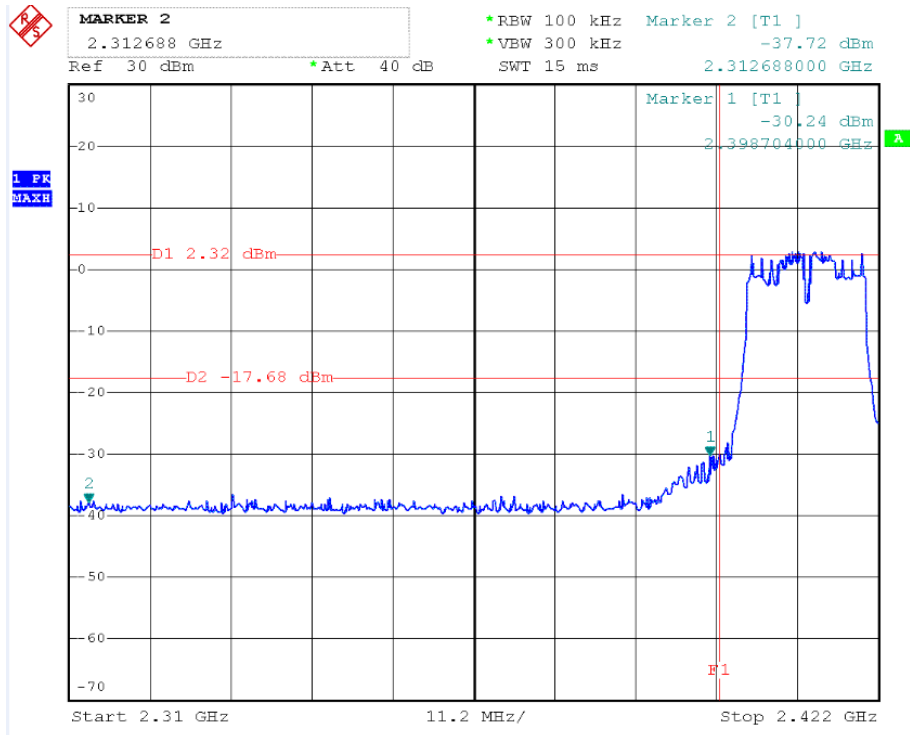

CH High (802.11g MODE)

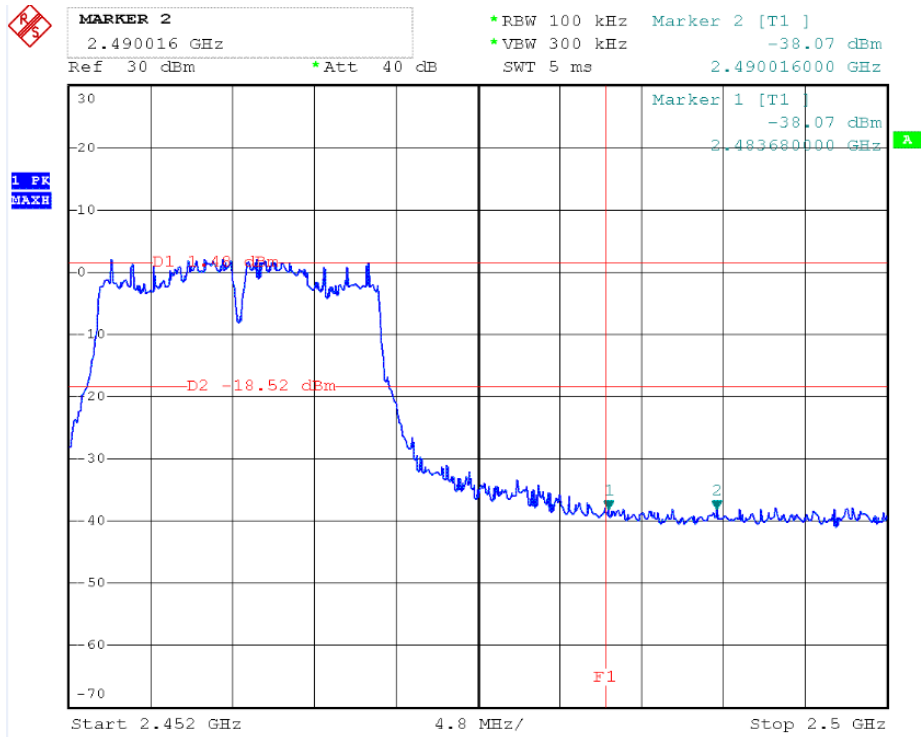

CH Low (802.11n HT20 MODE)

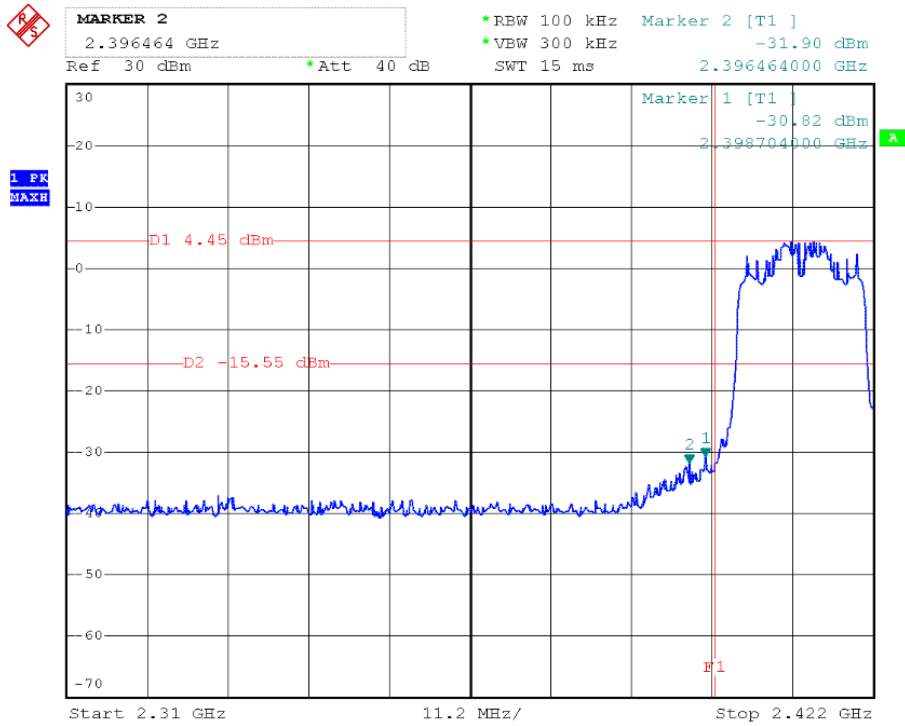

CH Low (802.11n HT20 MODE)

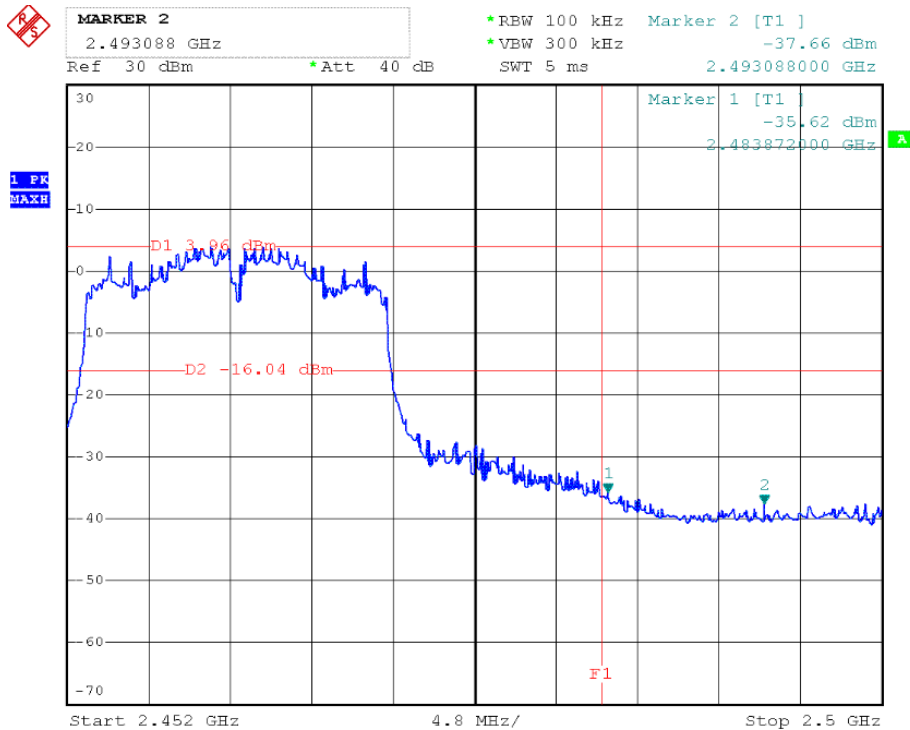

CH Low (802.11n HT40 MODE)

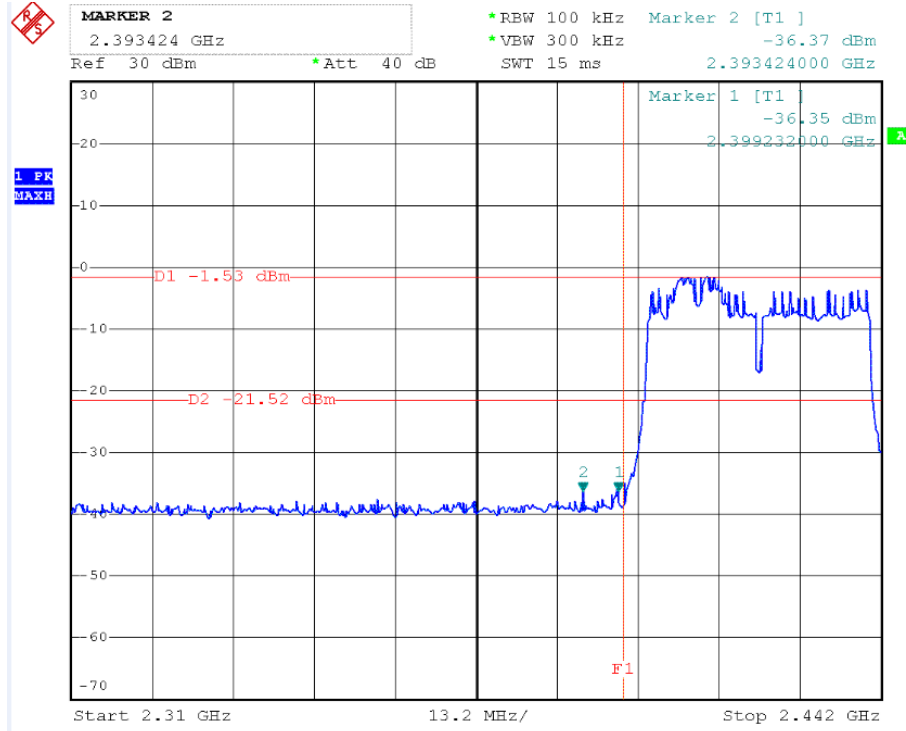

CH Low (802.11n HT40 MODE)

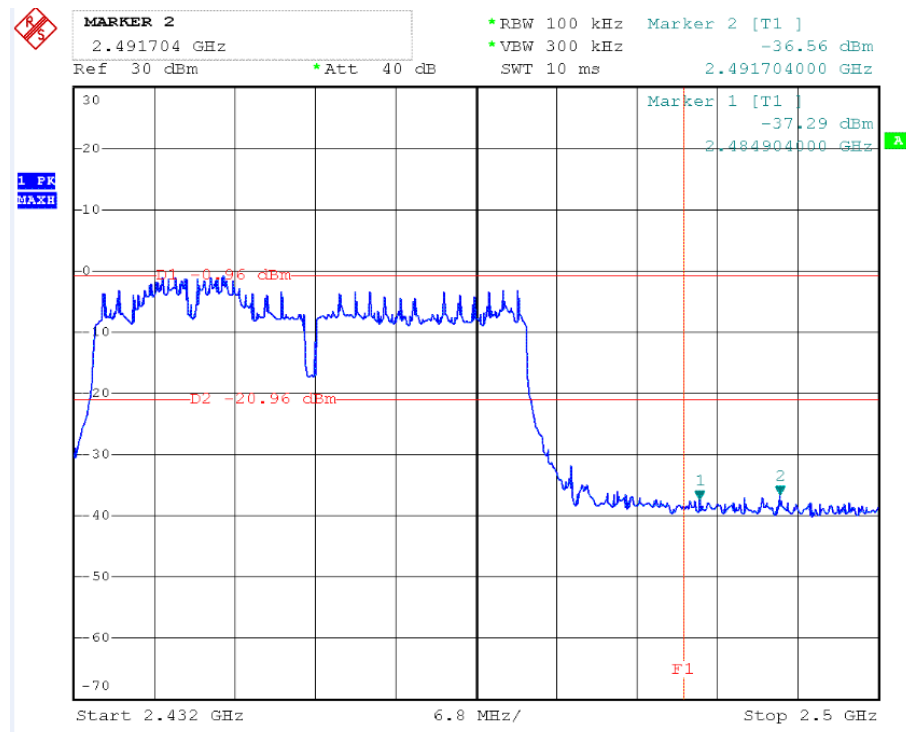

11. ANTENNA REQUIREMENT

11.1 Standard Applicable

Section 15.203:

An intentional radiator shall be designed to ensure that no antenna other than that furnished by the responsible party shall be used with the device. The use of a permanently attached antenna or of an antenna that uses a unique coupling to the intentional radiator shall be considered sufficient to comply with the provisions of this Section. The manufacturer may design the unit so that a broken antenna can be replaced by the user, but the use of a standard antenna jack or electrical connector is prohibited.

Section 15.247(b)/(c):

If transmitting antennas of directional gain greater than 6 dBi are used, the peak output power from the intentional radiator shall be reduced by the amount in dB that the directional gain of the antenna exceeds 6 dBi.

If the intentional radiator is used exclusively for fixed, point-to-point operations may employ transmitting antennas with directional gain greater than 6 dBi provided the maximum peak output power of the intentional radiator is reduced by 1 dB for every 3 dB that the directional gain of the antenna exceeds 6 dBi.

11.2 Antenna Connected Construction

The antenna is designed with permanent attachment and no consideration of replacement. The antenna used in this product is complied with Standard. The maximum Gain of the antenna lower than 6.0dBi and have the definite antenna Specification.

12 .Radio Frequency Exposure

12.1 Objective

The objective of the following report is used to demonstrate that EUT operated in a manner that ensures the public is not exposed to radio frequency energy levels in excess of the relative provisions of FCC 47CFR Part 1.1307

12.2 General Description of Test

Items	Description
EUT Frequency band	<input type="checkbox"/> FHSS: 2.400GHz ~ 2.483GHz <input checked="" type="checkbox"/> WLAN: 2.400GHz ~ 2.483GHz <input type="checkbox"/> WLAN: 5.18GHz ~ 5.32GHz / 5.50GHz ~ 5.70GHz <input type="checkbox"/> WLAN: 5.745GHz ~ 5825GHz <input type="checkbox"/> Others: _____
Device category	<input type="checkbox"/> Portable (<20cm separation) <input type="checkbox"/> Mobile (>20cm separation) <input type="checkbox"/> Others <u>Stationary type (>20cm separation)</u>
Exposure classification	<input type="checkbox"/> Occupational/Controlled exposure (S = 5mW/cm ²) <input checked="" type="checkbox"/> General Population/Uncontrolled exposure (S=1mW/cm ²) <input type="checkbox"/> Others: _____
Antenna diversity	<input checked="" type="checkbox"/> Single antenna <input type="checkbox"/> Multiple antennas: <ul style="list-style-type: none"> <input type="checkbox"/> Tx diversity <input type="checkbox"/> Rx diversity <input type="checkbox"/> Tx/Rx diversity
Max. output power	19.84dBm (0.096W)
Antenna gain (Max)	2.2 dBi (Numeric gain:1.66)
Evaluation applied	<input checked="" type="checkbox"/> MPE Evaluation <input type="checkbox"/> SAR Evaluation
<p>Note:</p> <p>1. The maximum output power is 19.84dBm (0.096W) at HT n40 mode 2422MHz. (with 1.66 numeric antenna gain.)</p> <p>2. For mobile or fixed location transmitters, no SAR consideration applied. The minimum separation generally be used is at least 20 cm, even if the calculations indicate that the MPE distance would be lesser.</p>	

1.3 Human Exposure Assessment Results

Calculation

$$\text{Given } E = \frac{\sqrt{30 \times P \times G}}{d} \quad \& \quad S = \frac{E^2}{3770}$$

Where E = Field Strength in Volts / meter

P = Power in Watts

G = Numeric antenna gain

d = Distance in meters

S = Power Density in milliwatts / square centimeter

Combining equations and re-arranging the terms to express the distance as a function of the remaining variables yields:

$$S = \frac{30 \times P \times G}{3770 d^2}$$

Changing to units of mW and cm, using:

$$P \text{ (mW)} = P \text{ (W)} / 1000 \text{ and}$$

$$d \text{ (cm)} = 100 * d \text{ (m)}$$

Yields

$$S = \frac{30 \times (P/1000) \times G}{3770 \times (d/100)^2} = 0.0796 \times \frac{P \times G}{d^2}$$

Equation 1

Where d = distance in cm

P = Power in mW

G = Numeric antenna gain

S = Power Density in mW / cm²

EUT parameter (data from the separate report)	
Given $E = \frac{\sqrt{30 \times P \times G}}{d} \quad \& \quad S = \frac{E^2}{3770}$	Where G: numerical gain of transmitting antenna; TP: Transmitted power in watt; d: distance from the transmitting antenna in meter
Max average output power in Watt (TP)	19.84dBm (0.096W)
Antenna gain (G)	2.2 dBi (Numeric gain:1.66)
Exposure classification	S=1mW/cm ²
Minimum distance in meter (d) (from transmitting structure to the human body)	20cm (0.2m)
<p>Yields</p> $S = \frac{30 \times P \times G}{3770 d^2}, \quad P=0.096W, G=1.66, d=0.2$ <p>S=0.0317mW/cm²</p> <p>Or</p> $d = \sqrt{\frac{30 \times P \times G}{3770 S}}, \quad S=1, P=0.096W, G=1.66$ <p>d=0.0356m</p>	
<p>Conclusion:</p> <p>S=0.0317mW/cm² is significant lower than the General Population Exposure Power Density Limit 1mW/cm² or except the distance when human body proximity to the antenna is less than 3.56cm then will reach the General Population Exposure Power Density Limit (For mobile or fixed location transmitters, the maximum power density is 1.0 mW / cm² even if the calculation indicates that the power density would be larger.)</p>	