



# INSTRUCTION MANUAL

---

Before using the TV, please read this manual thoroughly, and retain it for future reference.



**Model: RNSMU8615**



"This product is manufactured and sold by Curtis International Ltd.

RCA, the RCA logo, the two dogs (Nipper and Chipper) logo, are registered trademarks or trademarks of RCA Trademark Management and are used under license by Curtis International Ltd.

Any other product, service, company, trade or product name and logo referenced herein are neither endorsed nor sponsored by RCA Trademark Management or its affiliates."

## CONTENTS

1	<b>SAFETY PRECAUTION</b>		1
2	<b>IMPORTANT SAFETY INSTRUCTIONS</b>		2
3	<b>ACCESSORIES</b>		3
4	<b>GETTING STARTED</b>		3
5	<b>CONTROL REFERENCE GUIDE</b>	Remote Control	4
		Front View	5
		Bottom View	5
		Back View	6
6	<b>WALL MOUNT INSTALLATION</b>		7
7	<b>CONNECTIONS</b>	Installation	8
		Antenna Connection	9
		AV Connection	9
		YPbPr Connection	10
		HDMI Connection	10
		Power Cord Connection	11
		Optical audio output Connection	12
8	<b>INITIAL SETUP</b>	Putting The Unit On A Proper Place	13
		Turning The Unit On For The First Time	13
		Source Selection	13
9	<b>TV SETUP</b>	Picture Menu	14
		Sound Menu	15
		Function Menu	16
		Time Menu	17
		Option Menu	18
		Lock Menu	20
		Channel Menu	21

# CONTENTS

---

10	<b>USB MEDIA PLAYER</b>	22
11	<b>SMART TV OPERATION</b>	24
12	<b>DISPLAY MODE</b>	Video Formats 26
13	<b>SPECIFICATION</b>	27
14	<b>TROUBLE- SHOOTING GUIDE</b>	TV Symptom 28
15	<b>WARRANTY CARD</b>	29

---

*\* The pictures, functions and other information provided in the manual are for reference only. If it does not match the actual object, please refer to the actual product.*

---

# SAFETY PRECAUTION

\* CAUTION MARKING WAS LOCATED AT THE REAR PLACEMENT INFORMATION OF THE APPARATUS.



WARNING: TO REDUCE THE RISK OF ELECTRIC SHOCK, DO NOT REMOVE COVER (OR BACK) NO USER SERVICEABLE PARTS INSIDE. REFER SERVICING TO QUALIFIED SERVICE PERSONNEL.

 The lightning flash with arrowhead symbol, within an equilateral triangle, is intended to alert the user to the presence of uninsulated "dangerous voltage" within the product's enclosure that may be of sufficient magnitude to constitute a risk of electric shock to persons.

 The exclamation point within an equilateral triangle is intended to alert the user to the presence of important operating and maintenance (servicing) instructions in the literature accompanying the appliance.

 **CAUTION**

- DANGER OF EXPLOSION IF BATTERY IS INCORRECTLY REPLACED. REPLACE ONLY WITH THE SAME OR EQUIVALENT TYPE.
- USE OF CONTROLS OR ADJUSTMENTS OR PERFORMANCE OF PROCEDURES OTHER THAN THOSE SPECIFIED MAY RESULT IN HAZARDOUS RADIATION EXPOSURE.

 **WARNING:**

- TO REDUCE THE RISK OF FIRE OR ELECTRIC SHOCK, DO NOT EXPOSE THIS APPLIANCE TO RAIN OR MOISTURE. TO AVOID FIRE OR SHOCK HAZARD, DO NOT EXPOSE THIS UNIT TO RAIN OR MOISTURE. DO NOT PLACE OBJECTS FILLED WITH LIQUIDS ON OR NEAR THIS UNIT.
- SHOULD ANY TROUBLE OCCUR, DISCONNECT THE AC POWER CORD AND REFER SERVICING TO A QUALIFIED TECHNICIAN.

 This equipment is a Class II or double insulated electrical appliance. It has been designed in such a way that it does not require a safety connection to electrical earth.

- Do not use this unit in places that are extremely hot, cold, dusty or humid.
- Do not restrict the airflow of this unit by placing it somewhere with poor airflow, by covering it with a cloth, by placing it on bedding or carpeting.

## SAFETY INFORMATION

- When connecting or disconnecting the AC power cord, grip the plug and not the cord itself. Pulling the cord may damage it and create a hazard.
- When you are not going to use the unit for a long period of time, disconnect the AC power cord.

## RATING PLATE LOCATION

The rating plate is located on the rear of the unit.

## FCC STATEMENTS

NOTE: This unit has been tested and found to comply with the limits for a Class B digital device, pursuant to Part 15 of the FCC Rules. These limits are designed to provide reasonable protection against harmful interference in a residential installation.

This unit generates, uses and can radiate radio frequency energy and, if not installed and used in accordance with the instructions, may cause harmful interference to radio communication. However, there is no guarantee that interference will not occur in a particular installation. If this unit does cause harmful interference to radio or television reception, which can be determined by turning the unit off and on, the user is encouraged to try to correct the interference by one or more of the following measures:

- Reorient or relocate the receiving antenna.
- Increase the separation between the unit and receiver.
- Connect the unit into an outlet on a circuit different from that to which the receiver is connected.
- Consult the dealer or an experienced radio/TV technician for help.

 **WARNING:**

Changes or modifications to this unit not expressly approved by the party responsible for compliance could void the user authority to operate the unit.

**HDMI**<sup>®</sup>  
HIGH-DEFINITION MULTIMEDIA INTERFACE

"HDMI, the HDMI logo and High-Definition Multimedia Interface are trademarks or registered trademarks of HDMI Licensing LLC."

# IMPORTANT SAFETY INSTRUCTIONS

- 1) Read these instructions.
- 2) Keep these instructions.
- 3) Heed all warnings.
- 4) Follow all instructions.
- 5) Do not use this apparatus near water.
- 6) Clean only with a dry cloth.
- 7) Do not block any ventilation openings.  
Install in accordance with the manufacturer's instructions.
- 8) Do not install near any heat sources such as radiators, heat registers, stoves, or other apparatus (including amplifiers) that produce heat.
- 9) Do not defeat the safety purpose of the polarized or grounding-type plug.  
A polarized plug has two blades with one wider than the other.  
A grounding-type plug has two blades and a third grounding prong.  
The wide blade or the third prong is provided for your safety.  
If the provided plug does not fit into your wall outlet, consult an electrician for replacement of the obsolete outlet.
- 10) Protect the power cord from being walked on or pinched particularly at plugs, convenience receptacles, and the point where they exit from the apparatus.
- 11) Only use attachments / accessories specified by the manufacturer.
- 12) Use only with the cart, stand, tripod, bracket, or table specified by the manufacturer, or sold with the apparatus.  
When a cart is used, use caution when moving the cart / apparatus combination to avoid injury from tip-over.
- 13) Unplug this apparatus during lightning storms or when unused for long periods of time.
- 14) Refer all servicing to qualified service personnel. Servicing is required when the apparatus has been damaged in any way, such as the power cord or plug is damaged, liquid has been spilled or objects have fallen into the apparatus, the apparatus has been exposed to rain or moisture, does not operate normally, or has been dropped.
- 15) The mains plug is used as disconnect device, the disconnect device shall remain readily operable.



## PERSONAL SAFETY NOTICE

- ALWAYS read and follow all instructions for the installation and use of the TV.
- Place the TV in a location that is level and sturdy.
- DO NOT place the TV on a furniture with drawers that can be used as steps by small children.
- DO NOT allow children to pull the TV or climb on the furniture where the TV is placed.
- DO NOT allow children to play in front of or around the TV.
- ALWAYS route all the cables connecting to the TV so the cables cannot be easily pulled and grabbed by children.
- When installing the TV on a wall, please purchase a TV mount recommended by a professional TV installer, and follow the installation instructions that come with the TV mount.
- Before installing the TV on a wall, please check to make sure the wall structure can support the weight of the TV and the mount. If in doubt, please ask the advice from a professional TV installer.

# ACCESSORIES

Please check and identify the supplied accessories.

Remote control .....	x 1
Battery(AAA) .....	x 2
Instruction Manual .....	x 1
Mini AV in Cable.....	x 1
Mini YPbPr in Cable.....	x 1
Base stand .....	x 2
Base stand screws.....	x 6

## GETTING STARTED

### USING THE REMOTE CONTROL

- Point the remote control at the remote sensor located on the unit.
- When there is a strong ambient light source, the performance of the infrared remote sensor may be degraded, causing unreliable operation.
- The recommended effective distance for remote operation is about 16 feet (5 meters).

### TO INSTALL THE BATTERIES

1. Open the battery door.

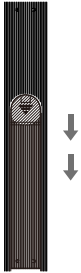

2. Insert 2"AAA"batteries.



### BATTERY REPLACEMENT

When the batteries become weak, the operating distance of the remote control is greatly reduced and you will need to replace the batteries.

**CAUTION** : Danger of explosion if battery is incorrectly replaced.

### NOTES

- If the remote control is not going to be used for a long time, remove the batteries to avoid damage caused by battery leakage corrosion.
- Do not mix old and new batteries. Do not mix ALKALINE, standard (CARBON-ZINC) or rechargeable (NICKEL-CADMIUM) batteries.
- Always remove batteries as soon as they become weak.
- Weak batteries can leak and severely damage the remote control.

**WARNING** :  
Do not dispose batteries in a fire. Batteries may explode or leak.  
Batteries shall not be exposed to excessive heat such as sunshine, fire or the like.

# CONTROL REFERENCE GUIDE

## REMOTE CONTROL

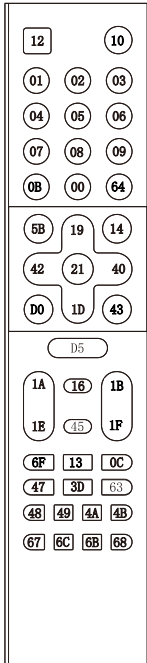

Format : NEC  
Remote Code: 20DF

Code location Chart

**POWER** (⏻): Turns the TV on or off.

**MUTE** (🔇): Mute or restore the sound

**Number buttons**: Choose the channel directly

**Decimal Point**: Input the decimal point.

**Return(Back)**: Return to the previously-viewed channel.

**MENU**: Access the main menu

**SOURCE**: Select the input source mode.

**Navigation buttons**: (Up/Down/Left/Right ◀/▶/▲/▼)

Navigate the menu.

**OK**: Confirm the selection.

**HOME** (🏠): Enter the home page.

**EXIT**: Exit the current screen.

**NETFLIX**: Access the Netflix interface.

**VOL+/VOL-** : Increases or decreases the TV volume.

**CH^/CHv** : Change to the previous or next program.

**INFO**: Show the detailed information.

**EPG**: This control button does not apply to this product.

**REC**(●): This control button does not apply to this product.

**MTS**: Select desired sound output depending on the broadcasting channel.

**CC**: Setup the mode of closed caption.

**SUBTITLE**: Access the subtitle.

**CH LIST**: Access the channel list.

**FAV**: View your assigned favorite channels.

**QUICK**: Access the quick menu.

**Color Buttons**(RED/GREEN/YELLOW/BLUE): Execute the prompt function in specific mode.

**PLAY/PAUSE** (▶/⏸): Pause or continue the playback.

**STOP** (■): Stop playback.

**FAST BACKWARD/FAST FORWARD** (◀◀/▶▶): Fast review of fast forward.

### IMPORTANT NOTICE:

Depending on the country where the TV is installed, certain apps may not be available.

The quick launch button on the remote control associated with those apps will therefore not work.

All other functionalities of the remote will work as designed.

# CONTROL REFERENCE GUIDE

## FRONT VIEW

About remote control working distance and angle, see next page.

**Power/Standby Indicator:** Blue and red dual-color LED. It shows red when the TV is turned off and blue when turned on. **Remote Control Sensor:** Remote control IR sensor, which receives infrared ray sent by remote control.

**NOTE:** If there is a protective film around the screen, remove the protective film before using the TV.

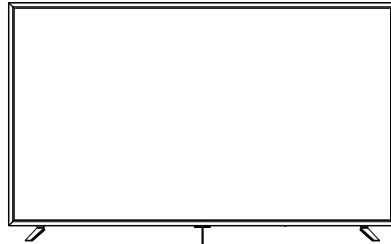

Power/Standby Indicator  
Remote Control Sensor

## BOTTOM VIEW

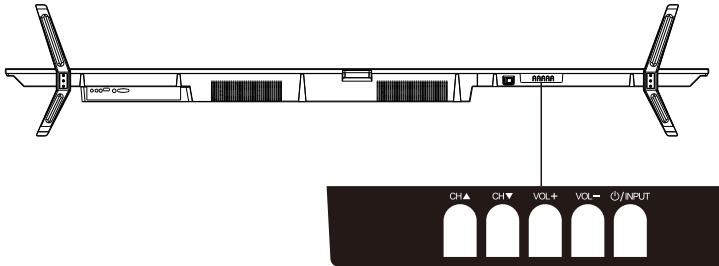

- CH▲:** Scans down through the channel list. In the TV menu system, it acts like the down arrow on the remote control and can be used to select menu options.
- CH▼:** Scans up through the channel list. In the TV menu system, it acts like the up arrow on the remote control and can be used to select menu options.
- VOL+:** Increases the volume. In the TV menu system, it acts like the right arrow on the remote control and can be used to select menu options.
- VOL-:** Decreases the volume. In the TV menu system, it acts like the left arrow on the remote control and can be used to select menu options.
- ⏻/INPUT:** When TV power off, long press this button to turn on. When TV is on, long press this button to turn off, short press this button to call out the input source menu, press the VOL+/- button to select the input source and press the power on/off button again to confirm the selection.



# CONTROL REFERENCE GUIDE

## BACK VIEW

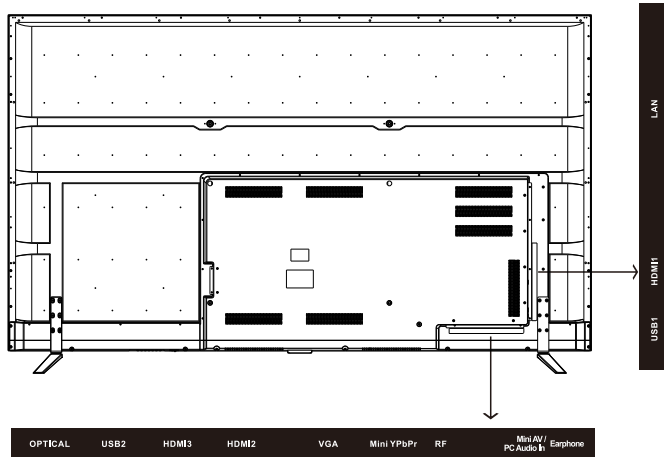

**OPTICAL:** Digital TV sound output.

**USB:** Connect the USB device such as the flash disk to access the TV media function.

**HDMI:** (High-Definition Multimedia Interface) Provides an uncompressed digital connection.

**VGA:** Connect the PC to these jacks.

**MINI YPbPr:** Connect the YPbPr output jack of the DVD or VCR.

**RF:** Connect to receive the signal from your antenna or cable through a coaxial cable.

**MINI AV:** Connect an AV device that has composite video jacks, such as a VCR or DVD Player.

Note: PC AUDIO IN and mini AV share one port, PC audio and YPbPr audio should connect from this port.

**EARPHONE:** Connect a 3.5mm headset for personal audio.

**LAN:** Connect the Internet.

# WALL MOUNT INSTALLATION

## INSTALLING / REMOVING THE BASE STAND

**WARNING :** The LED Display is very fragile , and must be protected at all times when removing the base Stand .

Be sure that no hard or sharp object or anything that could scratch or damage the LED display comes into contact with it Do NOT exert pressure on the front of the unit at any time because the screen could crack.

1. Disconnect all cables or cords connected to the unit.
2. Lay the unit down on a flat surface with the back side facing up Please make sure to place a soft cushioned material (such as a pillow or thick piece of foam) beneath the screen.
3. To remove the base stand, loosen screws off the holes then pull downwards to release the base stand

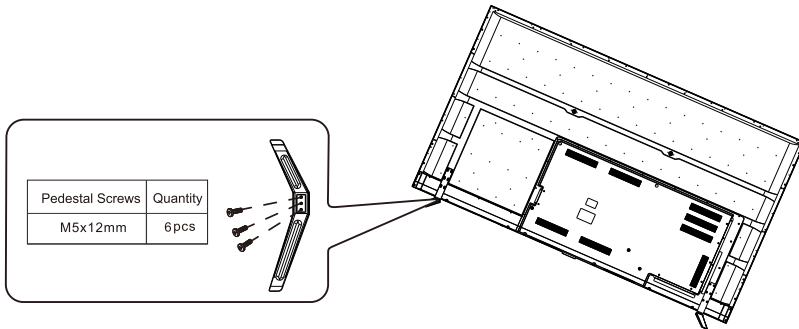

## MOUNTING ON THE WALL

This unit is VESA-compliant, and is designed to be wall-mounted with a VESA-compliant 24" x 24" (600mm x 600mm) mounting kit designed for flat-panel TVs (not supplied). Length of screw should be not exceed 12mm

## NOTE

Remove the base stand before mounting the unit on the wall.

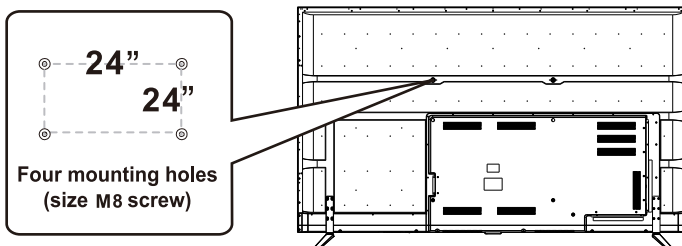

# Installation

Your TV is packaged with the stand and the cabinet separated. Before using the TV, install the stand as described below, or if you want to mount it to a wall, see page 7 for mounting advice; the wall mount itself is not supplied.

## IMPORTANT!

- Make sure the TV set is unplugged from the power supply before installing or removing the stand.
- The TV panel may be awkward to install on your own. We recommend you ask someone to help with installation and/or removal of the stand.

## Attaching the stand

### Step 1

Place a soft cushioned material on top of a flat surface to prevent damaging the screen panel. Then place the TV monitor flat on top, with the screen side facing down, as illustrated on the right (1).

### Step 2

Align the screw holes on the stand and the bottom of the TV, as illustrated on the right (2).

### Step 3

Tighten the screws (supplied) with a screwdriver to affix the stand to the panel, as illustrated on the right (3).

**NOTE:** Do not apply excessive force as this may damage the screw holes.

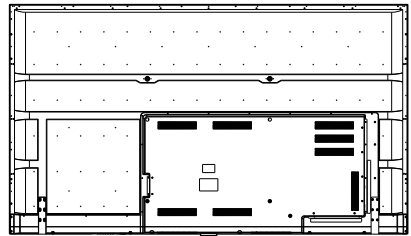

①

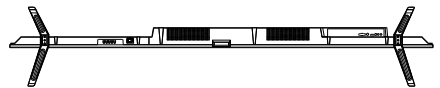

②

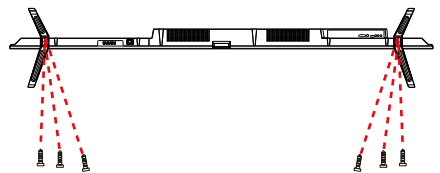

③

# CONNECTIONS

## CONNECTING A TV ANTENNA / CABLE / SATELLITE

To view television channels correctly, a signal must be received from one of the following sources:

- An indoor or outdoor aerial antenna
- A cable system
- A satellite system

### NOTE

For receiving over-the-air TV broadcasts, we recommend that you use an external fixed antenna. Should you require the use of a temporary antenna, please ensure that you purchase an antenna with sufficient ability to receive in weak signal areas. Only when you are in close proximity to a transmitter will a temporary antenna reproduce a signal as strongly as a fixed antenna.

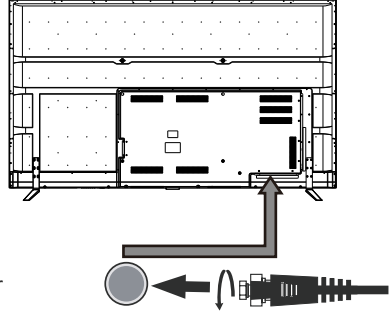

Satellite, cable or TV antenna cable to TV ANTENNA terminal (cable not included)

## CONNECTING AN A/V DEVICE

To connect to other equipment such as a VCR, camcorder, satellite system or cable, etc.

## CONNECTING DEVICES WITH A COMPOSITE VIDEO OUTPUT

To connect AV devices such as a VCR, video game system or camcorder.

### Connecting to a VCR / Video Game System / Camcorder

Connect the AUDIO / VIDEO cable (not included) as shown.

Make sure you connect the cable from the other equipment ( **AUDIO** and **VIDEO OUT** ) to this unit (Mini AV)

### NOTE

1. Please refer to the user manual for the other equipment for more information.
2. Composite video input (shared with component)

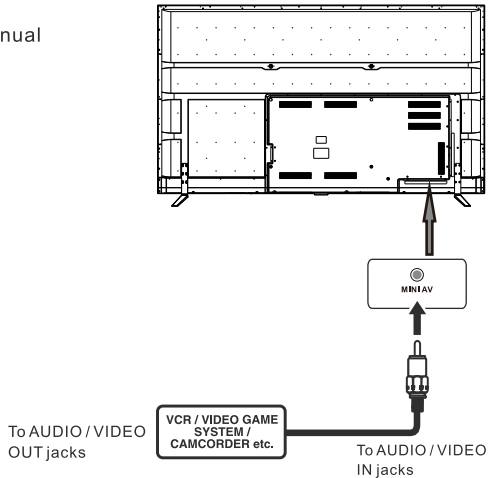

# CONNECTIONS

## CONNECTING A HIGH-DEFINITION (HD) SOURCE USING COMPONENT CONNECTION

High-Definition (HD) Devices with component video output must be connected to the YPbPr input. Connect the component video cable and audio cable (not included) as shown.

Make sure you connect the component video cable and audio cable from the other equipment (COMPONENT OUT and AUDIO OUT) to the unit COMPONENT IN.

### NOTE

When connecting a DVD player to the television, the picture resolution is solely dependent upon the resolution supported by the DVD player attached. DVD player resolutions vary from 480i to 1080P and this television can support DVD players up to a maximum resolution of 1080P.

\* May require a subscription for receiving HD channels, check with your cable/satellite service provider for details.

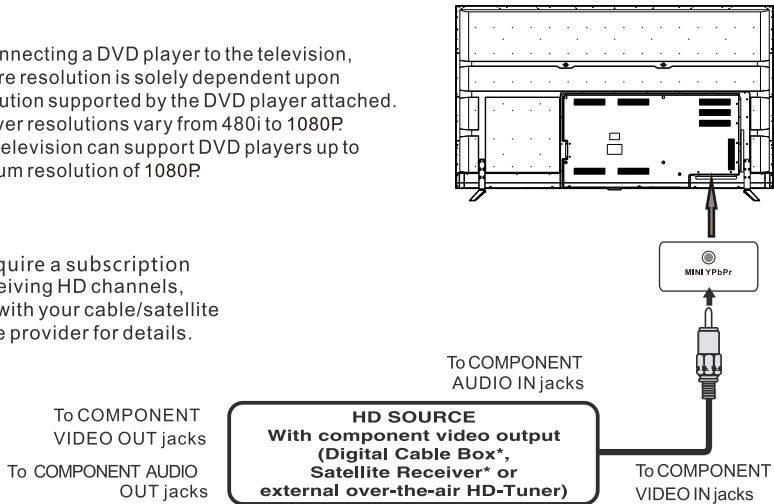

## CONNECTING A HIGH-DEFINITION (HD) SOURCE USING HDMI CONNECTION

HDMI (High Definition Multimedia Interface) supports both video and audio on a single digital connection for use with DVD players, DTV, set-top boxes and other digital AV devices. HDMI was developed to provide the technologies of High Bandwidth Digital Content Protection (HDCP) as well as Digital Visual Interface (DVI) in one specification. HDCP is used to protect digital content transmitted and received by DVI-compliant or HDMI-compliant displays.

HDMI has the capability to support standard, enhanced or high-definition video plus standard to multi-channel surround-sound audio. HDMI features include uncompressed digital video, a bandwidth of up to 2.2 gigabytes per second (with HDTV signals), one connector (instead of several cables and connectors), and communication between the AV source and AV devices such as DTVs.

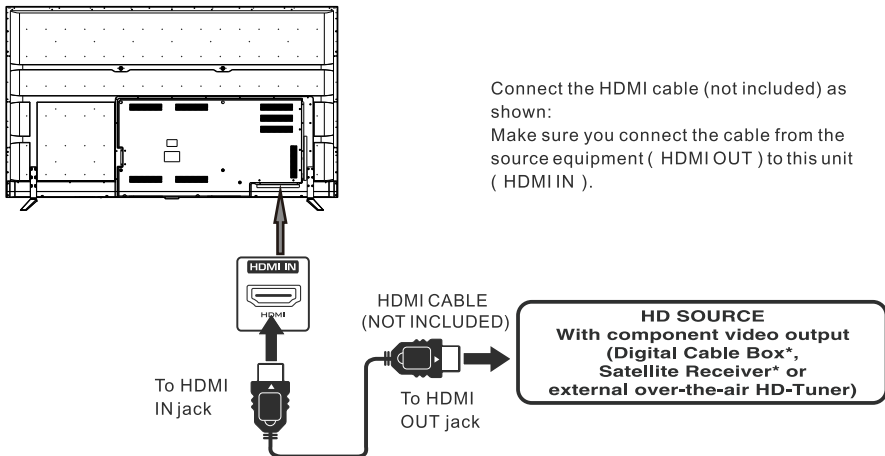

Connect the HDMI cable (not included) as shown:  
Make sure you connect the cable from the source equipment (HDMI OUT) to this unit (HDMI IN).

# CONNECTIONS

## CONNECTING A PC

Connect the 15-pin D-SUB PC/VGA connector from your computer to the 15-pin D-SUB PC/VGA input on this unit using a monitor cable and an audio cable (not included) as shown.

Make sure you connect the cable from the computer (VGA and AUDIO - PC OUT ) to this unit (VGA and AUDIO - PC IN ).

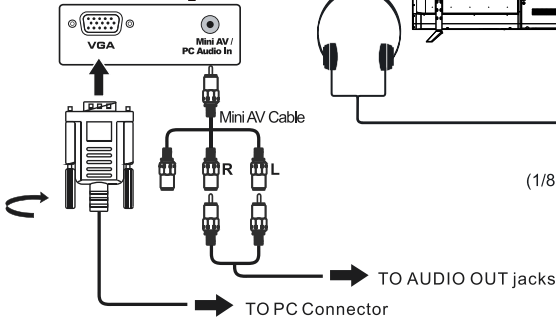
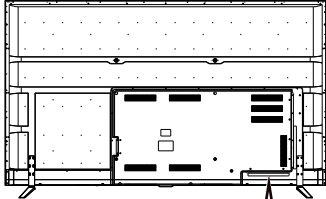

## CONNECTING HEADPHONES

- Turn down the volume before connecting headphones to the unit, then adjust the volume to your desired level.
- When headphones are connected, no sound will come from the front speakers.

### NOTE

Avoiding listening to sound at high Levels for prolonged period of time. This may be harmful to you and may cause hearing loss.

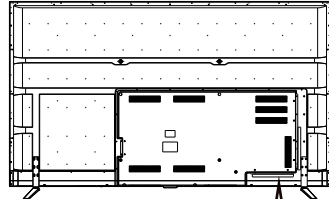

**EARPHONE**  
(1/8" [ 3.5mm ] diameter plug)  
NOT INCLUDED

## CONNECTING THE POWER CORD

You can power on your TV unit before you make sure the power cord is inserted well. At the same time, please check that the rated voltage of your unit matches your local Voltage.

### NOTE

- Insert the power plug fully into the socket outlet. (If the power plug is loose it could generate heat and cause fire .)
- Ensure that the power plug is easily accessible.
- Ensure the earth pin on the power plug is securely connected to prevent electrical shock.
- Do not touch the power plug with a wet hand. (This may cause electrical shock)
- Do not use any power cord other than that provided with this TV. (This may cause fire or electrical shock.)
- Do not damage the power cord. (A damaged cord may cause fire or electrical shock.)
- Do not move the TV with the cord plugged in the socket outlet.
- Do not place a heavy object on the cord or place the cord near a high-temperature object.
- Do not twist the cord, bend it excessively, or stretch it.
- Do not pull on the cord. Hold onto the power plug body when disconnecting cord.
- Do not use a damaged power plug or socket outlet.

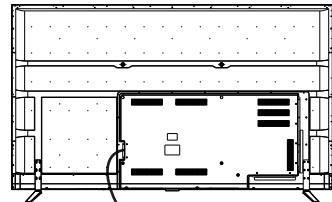

To AC wall outlet

## Connection to a Home Theater Audio System

### For BEST audio performance

Connecting to a Home Theater System  
Dolby Digital can deliver optimal 2 channel stereo or surround sound with five discrete full range channels plus a sixth channel for a subwoofer.

Enjoy optimal sound reproduction from your system with a Dolby Digital amplifier that incorporates a digital optical input. Connect an optional digital cable directly to the television's optical audio output to listen through all inputs except VGA.  
(The VGA does not support digital audio)

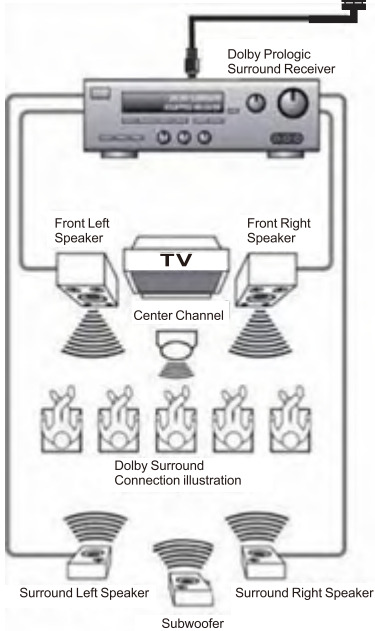
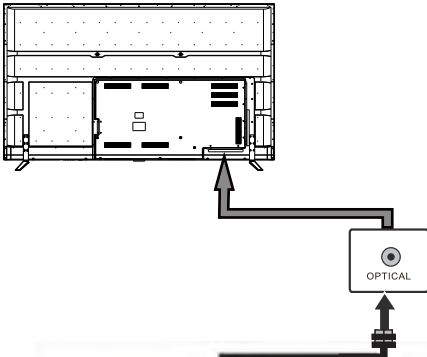

Optional digital cable  
(not included)

How To Setup Digital Audio Output  
Press the MENU button on the remote control  
Press the right ► arrow button to select sound  
Press the down ▼ arrow button to highlight Digital Audio Output ► Audio, PCM.

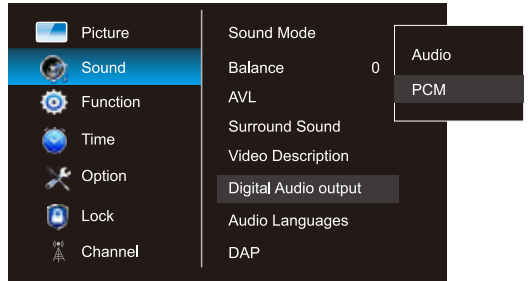

\*NOTE: Refer to the User Manual from your home theater equipment for recommended audio settings.

# INITIAL SETUP

## PUTTING THE UNIT ON A PROPER PLACE

When you turn on your television set for the first time, be sure to place it on a solid stable surface.

To avoid danger, do not expose the TV to water, or a heat source (e.g. lamp, candle, radiator).

Do not obstruct the ventilation grid at the rear and be sure to leave sufficient gaps around the unit.



## TURNING THE UNIT ON FOR THE FIRST TIME

After you have initially connected your TV antenna or cable, turn the television ON. A screen will display asking you to select a Language, Country and Internet.

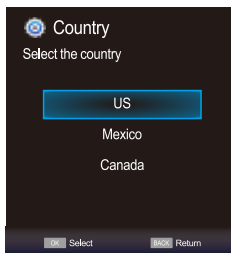

Select option of Auto Tuning under the up and down keys. Then press OK button on suitable location and the auto tuning will begin.

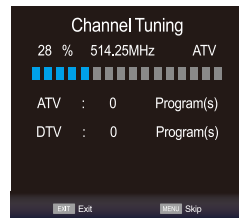
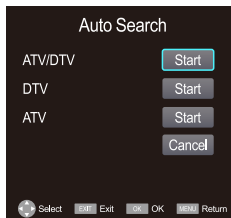
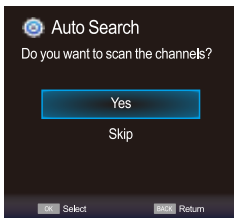

## SOURCE SELECTION

1. Press the **SOURCE** button on the remote control.
2. Use the **▲** or **▼** button to select the options (TV, AV, Component, HDMI, USB) and select any of them using the **OK** button. (The screen will change to your desired source).

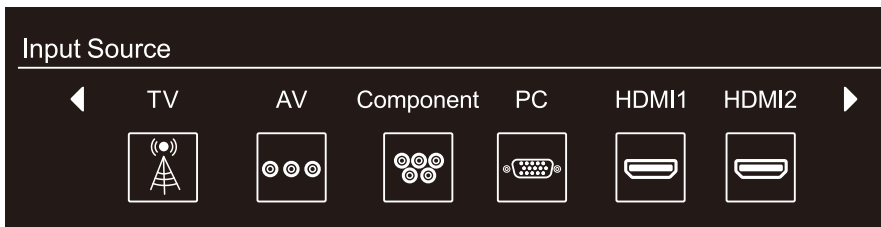

Note:

Before watching please make sure all necessary cables and devices are connected.



## Picture Menu

Press **MENU** button to display the main menu.

Press ◀ / ▶ button to select **PICTURE** in the main menu, it will highlight the first option.

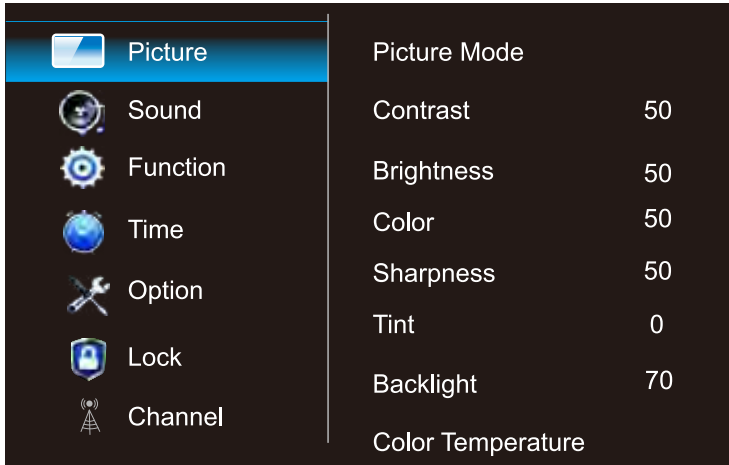

**Picture Mode:** Choose among Sports, Normal, Mild, Save and User. The following five items (Contrast, Brightness, Color, Sharpness and Tint) can be adjust only when the picture mode is set to "User" mode.

**Contrast:** Adjust the difference between light and dark areas of the picture.

**Brightness:** Adjust the lightness of the picture.

**Color:** Adjust the richness of the picture.

**Sharpness:** Adjust the edge of the picture.

**Tint:** (Only for some sources) Adjust the tint value of the color.

**Backlight:** Adjust the backlight value of the TV screen.

**Color Temperature:** Select the overall color tone of the picture. Choices are Cool, Standard and Warm.

# TV SETUP

## Sound Menu

Press **MENU** button to display the main menu.

Press ◀ / ▶ button to select **SOUND** in the main menu, it will highlight the first option.

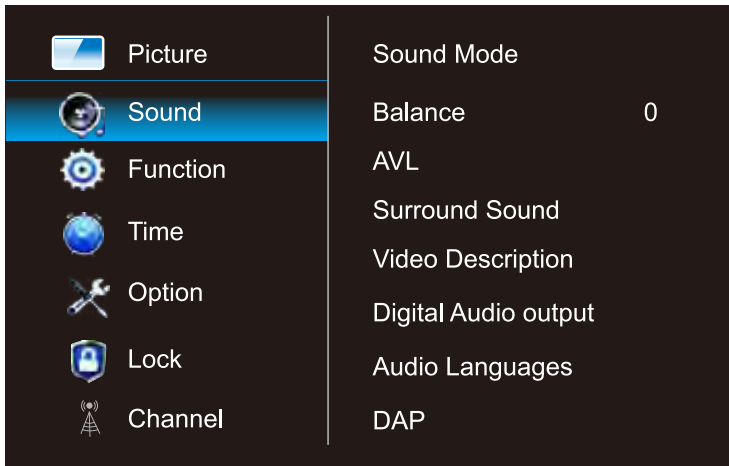

**Sound Mode:** Choose among Standard, Music, Movie, Sports and User. The value of 120Hz, 500Hz, 1.5KHz, 5KHz or 10KHz can be adjusted only when the sound mode is set to "User" mode.

**Balance:** Control the sound balance between the right and left speaker.

**AVL:** Turn on to adjust the sound volume depending on the input signal.

**Surround Sound:** Help to create rich and wider sound from stereo sound sources.

**Video Description:** Turn on or turn off the video description function to help the blind or visually impaired viewers.

**Digital Audio Output:** Set the digital audio output mode to PCM or Auto.

**Audio Languages:** Set the primary or secondary digital audio language corresponding to the signal.