



INSTRUCTION MANUAL

Before using the TV, please read this manual thoroughly, and retain it for future reference.



Model: RWOSU5847



*This product has been manufactured and sold under the responsibility of Curtis International Ltd.

RCA, the RCA logo, the two dogs (Nipper and Chipper) logo, are registered trademarks or trademarks of Technicolor (S.A.) or its affiliates and are used under license by Curtis International Ltd.

Any other product, service, company, trade or product name and logo referenced herein are neither endorsed nor sponsored by Technicolor (S.A.) or its Affiliates.*

CONTENTS

1	SAFETY PRECAUTION		1
2	IMPORTANT SAFETY INSTRUCTIONS		2
3	ACCESSORIES		3
4	GETTING STARTED		3
5	CONTROL REFERENCE GUIDE	Remote Control	4
		Front View	5
		Bottom View	5
		Back View	6
6	WALL MOUNT INSTALLATION		7
7	CONNECTIONS	Installation	8
		Antenna Connection	9
		AV Connection	9
		HDMI Connection	10
		Power Cord Connection	10
		Optical audio output Connection	11
8	INITIAL SETUP	Putting The Unit On A Proper Place	12
		Turning The Unit On For The First Time	12
		Source Selection	13
9	TV SETUP	Quick Settings	14
		Using Live Menu	14
		Picture Menu	15
		Sound Menu	16
		Channel Menu	17
		Connection Menu	18
		General Menu	19
		Accessibility Menu	20
		Support Menu	21

CONTENTS

10	SMART TV OPERATION	22
11	Using Home Dashboard	24
11	USB MEDIA PLAYER	25
12	DISPLAY MODE	Video Formats 27
13	SPECIFICATION	28
14	TROUBLE-SHOOTING GUIDE	TV Symptom 29
15	WARRANTY CARD	30

** The pictures, functions and other information provided in the manual are for reference only. If it does not match the actual object, please refer to the actual product.*

SAFETY PRECAUTION

* CAUTION MARKING WAS LOCATED AT THE REAR OF THE APPARATUS. **PLACEMENT INFORMATION**



WARNING: TO REDUCE THE RISK OF ELECTRIC SHOCK, DO NOT REMOVE COVER (OR BACK) NO USER SERVICEABLE PARTS INSIDE. REFER SERVICING TO QUALIFIED SERVICE PERSONNEL.

 The lightning flash with arrowhead symbol, within an equilateral triangle, is intended to alert the user to the presence of uninsulated "dangerous voltage" within the product's enclosure that may be of sufficient magnitude to constitute a risk of electric shock to persons.

 The exclamation point within an equilateral triangle is intended to alert the user to the presence of important operating and maintenance (servicing) instructions in the literature accompanying the appliance.

 **CAUTION**

- DANGER OF EXPLOSION IF BATTERY IS INCORRECTLY REPLACED. REPLACE ONLY WITH THE SAME OR EQUIVALENT TYPE.
- USE OF CONTROLS OR ADJUSTMENTS OR PERFORMANCE OF PROCEDURES OTHER THAN THOSE SPECIFIED MAY RESULT IN HAZARDOUS RADIATION EXPOSURE.

 **WARNING:**

- TO REDUCE THE RISK OF FIRE OR ELECTRIC SHOCK, DO NOT EXPOSE THIS APPLIANCE TO RAIN OR MOISTURE. TO AVOID FIRE OR SHOCK HAZARD, DO NOT EXPOSE THIS UNIT TO RAIN OR MOISTURE. DO NOT PLACE OBJECTS FILLED WITH LIQUIDS ON OR NEAR THIS UNIT.
- SHOULD ANY TROUBLE OCCUR, DISCONNECT THE AC POWER CORD AND REFER SERVICING TO A QUALIFIED TECHNICIAN.

 This equipment is a Class II or double insulated electrical appliance. It has been designed in such a way that it does not require a safety connection to electrical earth.

- Do not use this unit in places that are extremely hot, cold, dusty or humid.
- Do not restrict the airflow of this unit by placing it somewhere with poor airflow, by covering it with a cloth, by placing it on bedding or carpeting.

SAFETY INFORMATION

- When connecting or disconnecting the AC power cord, grip the plug and not the cord itself. Pulling the cord may damage it and create a hazard.
- When you are not going to use the unit for a long period of time, disconnect the AC power cord.

RATING PLATE LOCATION

The rating plate is located on the rear of the unit.

FCC STATEMENTS

NOTE: This unit has been tested and found to comply with the limits for a Class B digital device, pursuant to Part 15 of the FCC Rules. These limits are designed to provide reasonable protection against harmful interference in a residential installation.

This unit generates, uses and can radiate radio frequency energy and, if not installed and used in accordance with the instructions, may cause harmful interference to radio communication. However, there is no guarantee that interference will not occur in a particular installation. If this unit does cause harmful interference to radio or television reception, which can be determined by turning the unit off and on, the user is encouraged to try to correct the interference by one or more of the following measures:

- Reorient or relocate the receiving antenna.
- Increase the separation between the unit and receiver.
- Connect the unit into an outlet on a circuit different from that to which the receiver is connected.
- Consult the dealer or an experienced radio/TV technician for help.

 **WARNING:**

Changes or modifications to this unit not expressly approved by the party responsible for compliance could void the user authority to operate the unit.

This equipment complies with FCC radiation exposure limits set forth for an uncontrolled environment. This equipment should be installed and operated with minimum distance 20cm between the radiator & your body.

HDMI[®]
HIGH-DEFINITION MULTIMEDIA INTERFACE

"HDMI, the HDMI logo and High-Definition Multimedia Interface are trademarks or registered trademarks of HDMI Licensing LLC."

IMPORTANT SAFETY INSTRUCTIONS

- 1) Read these instructions.
- 2) Keep these instructions.
- 3) Heed all warnings.
- 4) Follow all instructions.
- 5) Do not use this apparatus near water.
- 6) Clean only with a dry cloth.
- 7) Do not block any ventilation openings.
Install in accordance with the manufacturer's instructions.
- 8) Do not install near any heat sources such as radiators, heat registers, stoves, or other apparatus (including amplifiers) that produce heat.
- 9) Do not defeat the safety purpose of the polarized or grounding-type plug.
A polarized plug has two blades with one wider than the other.
A grounding type plug has two blades and a third grounding prong.
The wide blade or the third prong is provided for your safety.
If the provided plug does not fit into your wall outlet, consult an electrician for replacement of the obsolete outlet.
- 10) Protect the power cord from being walked on or pinched particularly at plugs, convenience receptacles, and the point where they exit from the apparatus.
- 11) Only use attachments / accessories specified by the manufacturer.
- 12) Use only with the cart, stand, tripod, bracket, or table specified by the manufacturer, or sold with the apparatus.
When a cart is used, use caution when moving the cart / apparatus combination to avoid injury from tip-over.
- 13) Unplug this apparatus during lightning storms or when unused for long periods of time.
- 14) Refer all servicing to qualified service personnel. Servicing is required when the apparatus has been damaged in any way, such as the power cord or plug is damaged, liquid has been spilled or objects have fallen into the apparatus, the apparatus has been exposed to rain or moisture, does not operate normally, or has been dropped.
- 15) The mains plug is used as disconnect device, the disconnect device shall remain readily operable.



PERSONAL SAFETY NOTICE

- ALWAYS read and follow all instructions for the installation and use of the TV.
- Place the TV in a location that is level and sturdy.
- DO NOT place the TV on a furniture with drawers that can be used as steps by small children.
- DO NOT allow children to pull the TV or climb on the furniture where the TV is placed.
- DO NOT allow children to play in front of or around the TV.
- ALWAYS route all the cables connecting to the TV so the cables cannot be easily pulled and grabbed by children.
- When installing the TV on a wall, please purchase a TV mount recommended by a professional TV installer, and follow the installation instructions that come with the TV mount.
- Before installing the TV on a wall, please check to make sure the wall structure can support the weight of the TV and the mount. If in doubt, please ask the advice from a professional TV installer.
- People should not be turning on the TV before checking that the power cord is inserted "well".
- People should be checking the voltage of the AC power receptacle and the TV before plugging in the TV.

ACCESSORIES

Please check and identify the supplied accessories.

Remote control	x 1
Battery(AAA)	x 2
Instruction Manual	x 1
Base stand	x 2
Base stand screws	x 4
Troubleshooting instructions card.....	x 1

GETTING STARTED

USING THE REMOTE CONTROL

- Point the remote control at the remote sensor located on the unit.
- When there is a strong ambient light source, the performance of the infrared remote sensor may be degraded, causing unreliable operation.
- The recommended effective distance for remote operation is about 16 feet (5 meters).

TO INSTALL THE BATTERIES

1. Open the battery door.

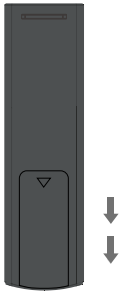

2. Insert 2"AAA"batteries.

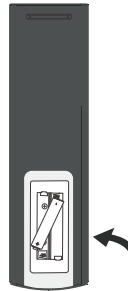

BATTERY REPLACEMENT

When the batteries become weak, the operating distance of the remote control is greatly reduced and you will need to replace the batteries.

⚠ CAUTION : Danger of explosion if battery is incorrectly replaced.

NOTES

- If the remote control is not going to be used for a long time, remove the batteries to avoid damage caused by battery leakage corrosion.
- Do not mix old and new batteries. Do not mix ALKALINE, standard (CARBON-ZINC) or rechargeable (NICKEL-CADMIUM) batteries.
- Always remove batteries as soon as they become weak.
- Weak batteries can leak and severely damage the remote control.

⚠ WARNING :
Do not dispose batteries in a fire. Batteries may explode or leak.
Batteries shall not be exposed to excessive heat such as sunshine, fire or the like.

CONTROL REFERENCE GUIDE

REMOTE CONTROL



Format : NEC

Customer code: 04H FBH

POWER (⏻): Turns the TV on or off.

TV: Switch to TV Mode.

(Q): Switch to search menu.

CC/SUB: Setup the mode of closed caption or access the subtitle.

(⚙): Enters the Quick Settings menu.

(☰): Select the input source mode.

Number buttons: Choose the channel directly

LIST: Access the channel list.

(⋮): It displays the additional buttons on the remote control. Press this button to select the desired option from "More Actions" displayed on the TV screen.

VOL+/VOL-: Increases or decreases the TV volume.

CH^/CHv: Change to the previous or next program.

QUICK ACCESS: Long-press 0, you can add Quick Access.

FAV: Show favorite channel list.

GUIDE: Check the programme.

MUTE (🔇): Mute or restore the sound.

IMPORTANT NOTICE:

Depending on the country where the TV is installed, certain apps may not be available.

The quick launch button on the remote control associated with those apps will therefore not work.

All other functionalities of the remote will work as designed.

*Some functions and features are only available when using the LG ThinQ APP.

PLAY (▶): Play while watching media.

PAUSE (⏸): Pause while watching media.

HOME (🏠): Enter the home page.

Return(Back): Return to the previous step.

EXIT: Exit the current screen.

Navigation buttons: (Up/Down/Left/Right ◀/▶/▲/▼) Navigate the menu.

(⊙): Confirm the selection.

(i) **INFO**: Show the detailed information.

SAP: Turn on the Audio Language.

MOVIES: Search Movies.(make sure the Internet connection is normal)

REC: This button does not apply to this model.

(□): This button does not apply to this model.

NETFLIX: Access the Netflix interface.

PRIME VIDEO: Access the Prime Video interface.

Color Buttons(RED/GREEN/YELLOW/BLUE): Execute the prompt function in specific mode.

CONTROL REFERENCE GUIDE

FRONT VIEW

About remote control working distance and angle, see next page.

Power/Standby Indicator: Blue and red dual-color LED. It shows red when the TV is turned off and blue when turned on. Remote Control Sensor: Remote control IR sensor, which receives infrared ray sent by remote control.

NOTE: If there is a protective film around the screen, remove the protective film before using the TV.

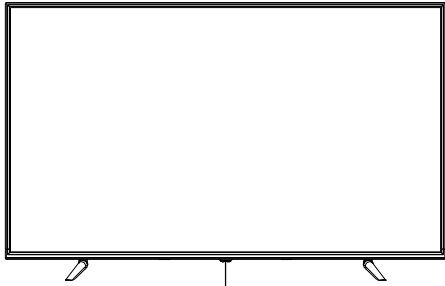

Power/Standby Indicator
Remote Control Sensor

BOTTOM VIEW

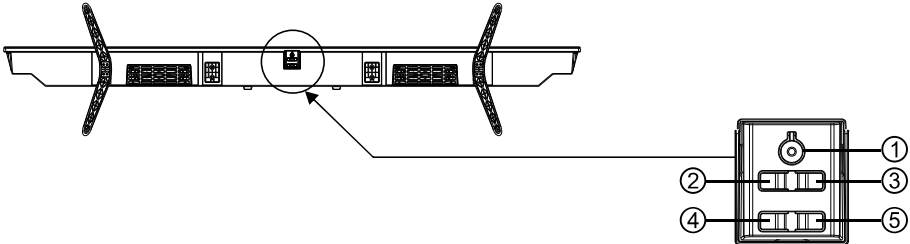

1. **⏻/MENU:** When TV power off, short press this button to turn on. When TV is on, long press this button to turn off, short press this button to call out the TV menu, press the VOL+/- and CH+/- button to select the menu and press the power on/off button again to confirm the selection.
2. **VOL-:** Decreases the volume. In the TV menu system, it acts like the left arrow on the remote control and can be used to select menu options.
3. **VOL+:** Increases the volume. In the TV menu system, it acts like the right arrow on the remote control and can be used to select menu options.
4. **CH-:** Scans down through the channel list. In the TV menu system, it acts like the down arrow on the remote control and can be used to select menu options.
5. **CH+:** Scans up through the channel list. In the TV menu system, it acts like the up arrow on the remote control and can be used to select menu options.

BACK VIEW

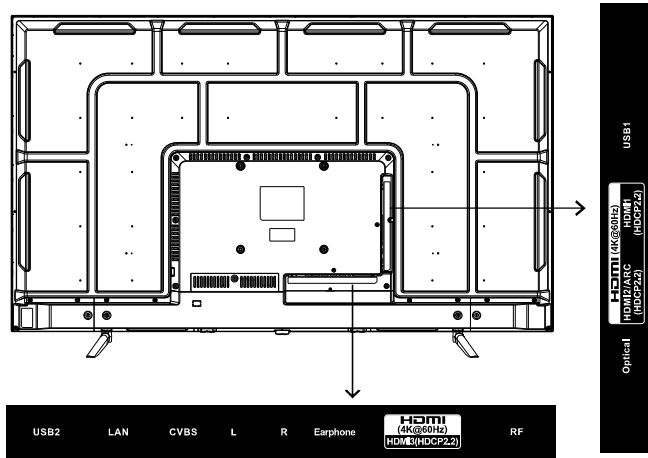

USB: Connect the USB device such as the flash disk to access the TV media function.

LAN: Connect the Internet.

CVBS : Connect an AV device that has composite video jacks, such as a VCR or DVD player.

- **L:** Left audio channel connection.
- **R:** Right audio channel connection.

EARPHONE: Connect a 3.5mm headphone for personal audio.

HDMI: (High-Definition Multimedia Interface) Provides an uncompressed digital connection. Please enter to the setup menu to turn it on.

RF: Connect to receive the signal from your antenna or cable through a coaxial cable.

OPTICAL: Digital TV sound output.

WALL MOUNT INSTALLATION

INSTALLING / REMOVING THE BASE STAND

WARNING : The LED Display is very fragile , and must be protected at all times when removing the base Stand .

Be sure that no hard or sharp object or anything that could scratch or damage the LED display comes into contact with it Do NOT exert pressure on the front of the unit at any time because the screen could crack.

1. Disconnect all cables or cords connected to the unit.
2. Lay the unit down on a flat surface with the back side facing up Please make sure to place a soft cushioned material (such as a pillow or thick piece of foam) beneath the screen,
3. To remove the base stand, loosen screws off the holes then pull downwards to release the base stand

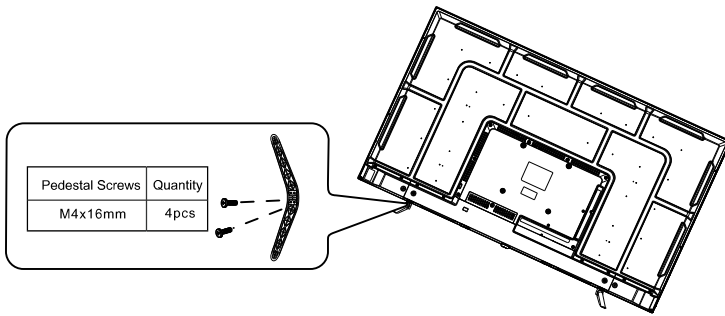

MOUNTING ON THE WALL

This unit is VESA-compliant, and is designed to be wall-mounted with a VESA-compliant 8" x 8" (200mm x 200mm) mounting kit designed for flat-panel TVs (not supplied). Length of screw should be not exceed 8 mm

NOTE

Remove the base stand before mounting the unit on the wall.

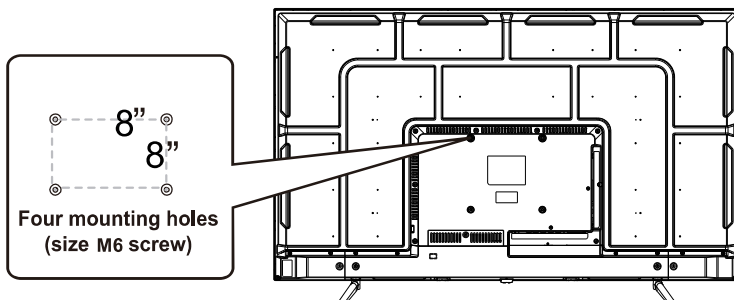

Installation

Your TV is packaged with the stand and the cabinet separated. Before using the TV, install the stand as described below, or if you want to mount it to a wall, see page 7 for mounting advice; the wall mount itself is not supplied.

IMPORTANT!

- Make sure the TV set is unplugged from the power supply before installing or removing the stand.
- The TV panel may be awkward to install on your own. We recommend you ask someone to help with installation and/or removal of the stand.

Attaching the stand

Step 1

Place a soft cushioned material on top of a flat surface to prevent damaging the screen panel. Then place the TV monitor flat on top, with the screen side facing down, as illustrated on the right (1).

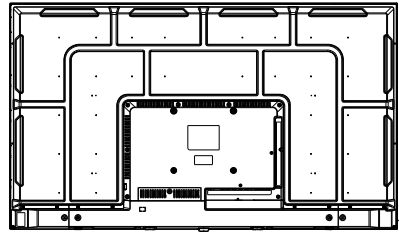

①

Step 2

Align the screw holes on the stand and the bottom of the TV, as illustrated on the right (2).

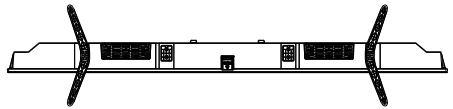

②

Step 3

Tighten the screws (supplied) with a screwdriver to affix the stand to the panel, as illustrated on the right (3).

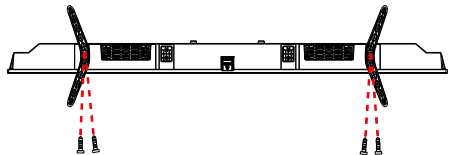

③

NOTE: Do not apply excessive force as this may damage the screw holes.

CONNECTIONS

CONNECTING A TV ANTENNA / CABLE / SATELLITE

To view television channels correctly, a signal must be received from one of the following sources:

- An indoor or outdoor aerial antenna
- A cable system
- A satellite system

NOTE

For receiving over-the-air TV broadcasts, we recommend that you use an external fixed antenna. Should you require the use of a temporary antenna, please ensure that you purchase an antenna with sufficient ability to receive in weak signal areas. Only when you are in close proximity to a transmitter will a temporary antenna reproduce a signal as strongly as a fixed antenna.

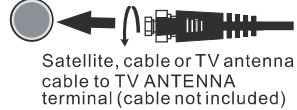
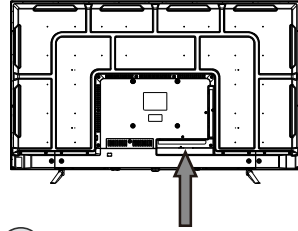

CONNECTING AN A/V DEVICE

To connect to other equipment such as a VCR, camcorder, satellite system or cable, etc.

CONNECTING DEVICES WITH A COMPOSITE VIDEO OUTPUT

To connect A/V devices such as a VCR, video game system or camcorder.

Connecting to a VCR / Video Game System / Camcorder

Connect the AUDIO / VIDEO cable (not included) as shown. Make sure you connect the cable from the other equipment (**AUDIO** and **VIDEO OUT**) to this unit (AV in).

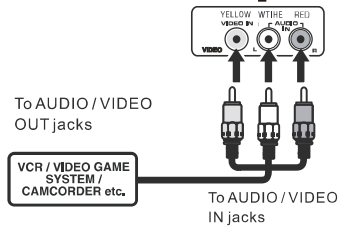
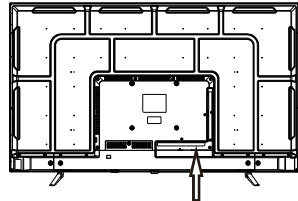

NOTE

1. Please refer to the user manual for the other equipment for more information.
2. Composite video input (shared with component)

CONNECTING HEADPHONES

- Turn down the volume before connecting headphones to the unit, then adjust the volume to your desired level.
- When headphones are connected, no sound will come from the front speakers.

NOTE

Avoiding listening to sound at high Levels for prolonged period of time.

This may be harmful to you and may cause hearing loss.

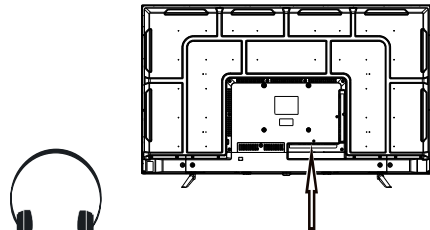

EARPHONE
(1/8" [3.5mm] diameter plug)
NOT INCLUDED

CONNECTIONS

CONNECTING A HIGH-DEFINITION (HD) SOURCE USING HDMI CONNECTION

HDMI (High Definition Multimedia Interface) supports both video and audio on a single digital connection for use with DVD players, DTV, set-top boxes and other digital AV devices. HDMI was developed to provide the technologies of High Bandwidth Digital Content Protection (HDCP) as well as Digital Visual Interface (DVI) in one specification. HDCP is used to protect digital content transmitted and received by DVI-compliant or HDMI-compliant displays.

HDMI has the capability to support standard, enhanced or high-definition video plus standard to multi-channel surround-sound audio. HDMI features include uncompressed digital video, a bandwidth of up to 2.2 gigabytes per second (with HDTV signals), one connector (instead of several cables and connectors), and communication between the AV source and AV devices such as DTVs.

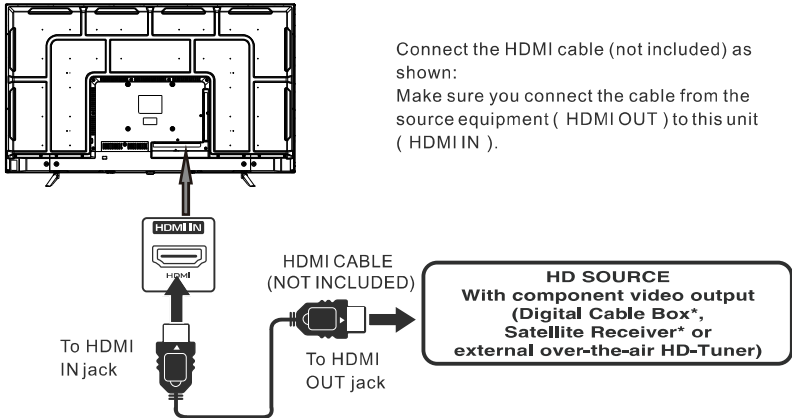

CONNECTING THE POWER CORD

Do not power on your TV unit before making sure the power cord is properly inserted.
At the same time, please check that the rated voltage of your unit matches your local Voltage.

NOTE

- Insert the power plug fully into the socket outlet.
(If the power plug is loose, it could generate heat and cause fire .)
- Ensure that the power plug is easily accessible.
- Ensure the earth pin on the power plug is securely connected to prevent electrical shock.
- Do not touch the power plug with a wet hand.
(This may cause electrical shock)
- Do not use any power cord other than that provided with this TV. (This may cause fire or electrical shock.)
- Do not damage the power cord.
(A damaged cord may cause fire or electrical shock.)
- Do not move the TV with the cord plugged in the socket outlet.
- Do not place a heavy object on the cord or place the cord near a high-temperature object.
- Do not twist the cord, bend it excessively, or stretch it.
- Do not pull on the cord. Hold onto the power plug body when disconnecting cord.
- Do not use a damaged power plug or socket outlet.

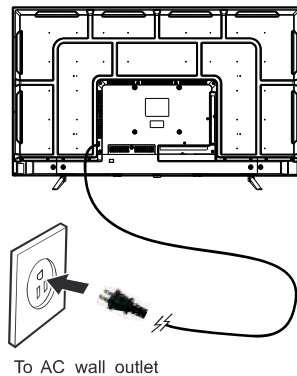

Connection to a Home Theater Audio System

For BEST audio performance

Connecting to a Home Theater System
Dolby Digital can deliver optimal 2 channel stereo or surround sound with five discrete full range channels plus a sixth channel for a subwoofer.

Enjoy optimal sound reproduction from your system with a Dolby Digital amplifier that incorporates a digital optical input. Connect an optional digital cable directly to the television's optical audio output to listen through all inputs.

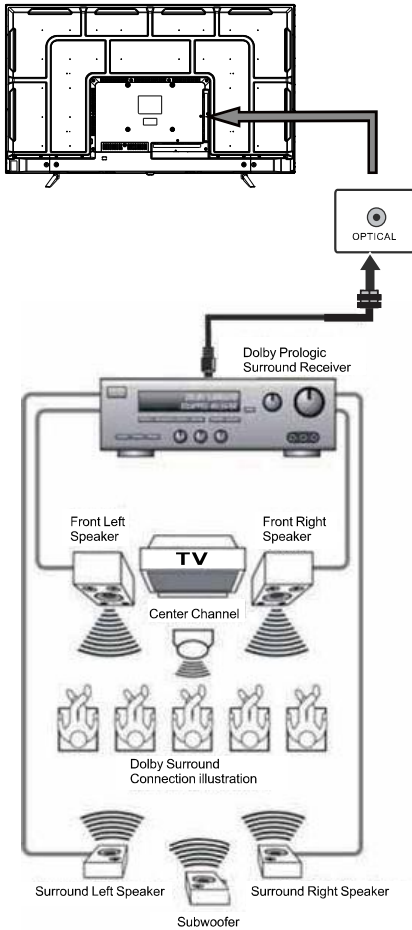

Optional digital cable
(not included)

*NOTE: Refer to the User Manual from your home theater equipment for recommended audio settings.

INITIAL SETUP

PUTTING THE UNIT ON A PROPER PLACE

When you turn on your television set for the first time, be sure to place it on a solid stable surface.

To avoid danger, do not expose the TV to water, or a heat source (e.g. lamp, candle, radiator).

Do not obstruct the ventilation grid at the rear and be sure to leave sufficient gaps around the unit.



TURNING THE UNIT ON FOR THE FIRST TIME

After you have initially connected your TV antenna or cable, turn the television ON. A screen will display asking you to select Language and Location, The way to watch TV and Connect LG ThinQ. After setting the options, you can start to experience webOS TV.

Regarding the selection of the service country, you need to enter general menu to select, which is described in detail on page 19 of the manual.

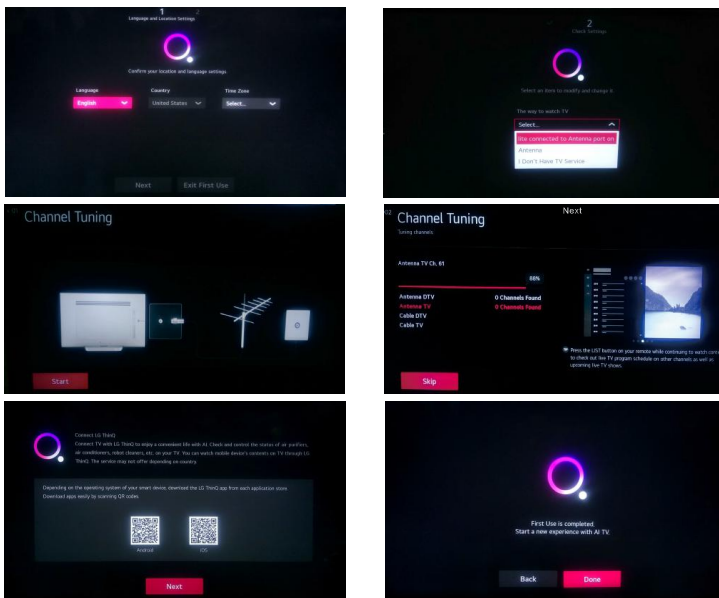

Note: It is not necessary to select the country when performing the initial setup of this TV. And webOS will push these Apps to the Content Store of this TV depending the IP address. Different Countries have different Apps.

RCA WebOS TV Initial Setup Guide

After you have initially connected your TV antenna or cable, turn the television ON. A screen will display asking you to select Language and Location. NB: for location, the Television is preset to USA – If you are in the USA enter your ZIP Code.

If you are located outside of the USA, leave the country set to USA and enter the following ZIP CODE 12345, Complete the initial setup.

INITIAL SETUP

To change your country setting (if you not located in USA) – go to Main Menu “General” (The Wrench Symbol) then Choose Location.

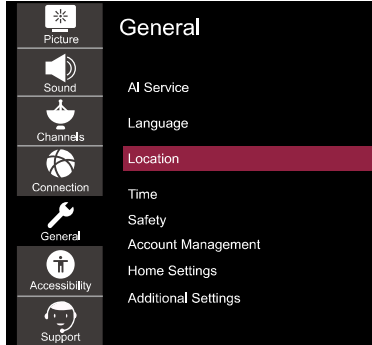

Set your Services Country

Select your country (in the menu) to enable the applicable WebOS Apps and features for your country. If you choose “Set Automatically”, the operating system of your television will detect your location (country) from your internet connection.

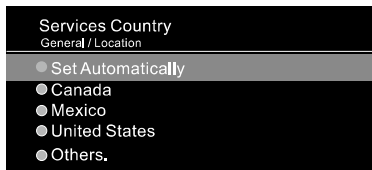

Set the current Date, Time & Time Zone

Setting the correct Date, Time & Time Zone ensures that all of the smart features of your RCA WebOS TV function properly.

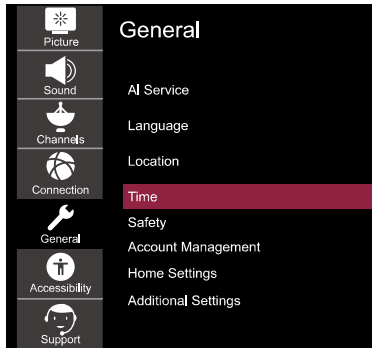

Source Selection

Press (⏪) button to display the input source list.

Press ◀/▶ button to select the input source you want to watch, then press the Wheel (⊙) button to enter the input source. HDMI input source needs to be selected in Home Dashboard.



Note: Before watching please make sure all necessary cables and devices are connected.

TV SETUP

Quick Settings

Press the (⊞) button on the remote control, the screen will display a quick setting menu, such as picture mode, sound mode, sleep timer, etc.

You can add/delete the quick setting items or change their order. After entering each item, press the Wheel (⊙) button on the remote control to go to the corresponding menu. Press ◀/▶ button to select the option.

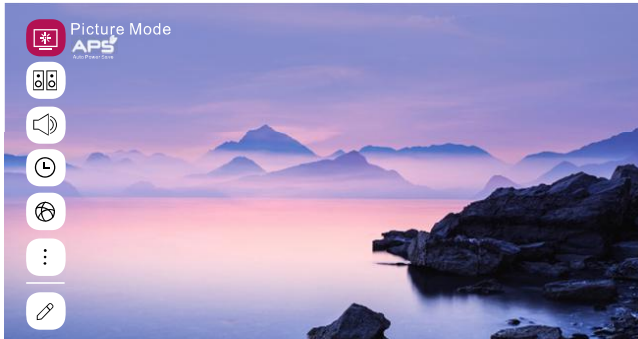

Using Live Menu

You can use the relevant features with ease when watching TV broadcasts. Press the LIST button on the remote control.



1. Programmes : View a list of broadcast content that is currently being broadcast.
2. Guide : You can view programmes and the schedule of each programmes.
3. TV Scheduler : You can enter the time and date of a programme to schedule watching or recording it at the set time.

TV SETUP

Picture Menu

Select All settings in settings menu, press (⊙) button to enter the submenu.

Press ▲/▼ buttons to select **Picture** in the submenu, it will highlight the option, then press ► button to enter menu.

Press ▲/▼ button to select the option and press (⊙) button to enter the submenu.

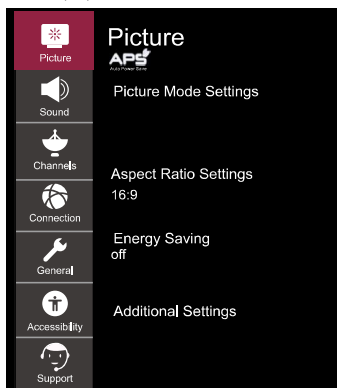

Picture Mode Settings

Select a video mode that matches the viewing environment, or specify settings for a video mode, such as contrast, color and more.

Backlight

Adjust Backlight brightness to brighten or darken the screen. The closer to 100, the brighter.

Contrast

Adjust the difference between bright and dark areas of the screen. Higher values intensify the difference.

Brightness

Adjust the tint to brighten or darken the screen. The closer to 100, the brighter.

Sharpness

Adjust edge sharpness. Higher values increase the crispness and clarity of the image.

Color

Adjust the screen color to be pale or deep. The closer to 100, the clearer the color becomes.

Tint

Adjust the balance of red and green to display the tint on the screen. The closer to 50 the clearer the red, the closer to 50 the clearer the green.

Color Temperature

Display pictures in a warm or cool color temperature. Higher values increase a sense of warmth or coldness.

Advanced Controls

Adjust the contrast, resolution, etc for individual picture mode in detail and set preferred color, gamma, etc additionally.

Picture Options

Set necessary additional functions based on watching environment and screen status.

Reset

Revert picture setting values to default. It is reset to picture mode individually, so select the desired picture mode and reset it.

Aspect Ratio Settings

View the original screen as it is or set the screen size and aspect ratio.

Energy Saving

Energy saving modes to limit power consumption. Adjust screen brightness to reduce energy consumption.

If you use Energy Saving function, brightness of your TV will be affected.

Select the Off option to turn off the ECO picture mode. Darken the surrounding environment so that you can see the on-screen menu information clearly.

Additional Settings

Set additional picture settings. Include Eye Comfort Mode, HDMI Ultra HD Deep Color and Instant Game Response.

Sound Menu

Select **All** settings in settings menu, press (⊙) button to enter the submenu. Press ▲/▼ buttons to select **Sound** in the submenu, it will highlight the option, then press ► button to enter menu. Press ▲/▼ button to select the option and press (⊙) button to enter the submenu.

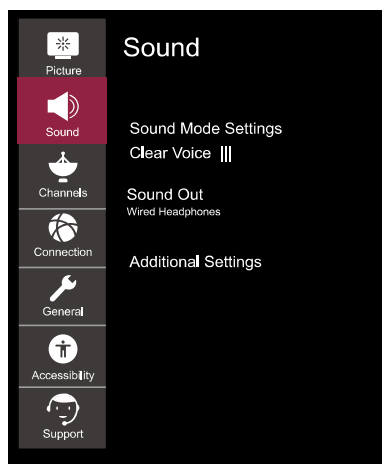

Sound Mode Settings

Select the Sound mode and set detailed Audio effects. This settings is **only** available for **Internal TV Speaker**. Include Standard, Cinema, **Clear Voice III**, Sports, Music and Game.

Balance

Control the sound balance between the right and left speaker.

Ultra Surround

Set the virtual multi-channel . surround sound effect to enjoy more realistic sound.

Equalizer

Adjust the sound to meet your taste for each sound frequency band.

Reset

Revert detailed sound effect settings of standard mode to default.

Sound Out

Select device or speaker for audio output. Include **Internal TV Speaker**, **Bluetooth**, **Mobile Device**, **Optical**, **HDMI ARC**, **Wired Headphones**, **Optical + Internal TV Speaker** etc. for your choice.

Additional Settings

Set additional sound-related settings. Include **TV Installation Type**, **Volume Mode**, **AV Sync Adjustment**, **HDMI Input Audio Format**, **LG Sound Sync** and **Digital Sound Out** for your choice. You can perform the operations you want according to the prompt information on the TV screen.

Channel Menu

Select **All** settings in settings menu, press (⊙) button to enter the submenu.

Press ▲/▼ buttons to select **Channels** in the submenu, it will highlight the option, then press ► button to enter menu.

Press ▲/▼ button to select the option and press (⊙) button to enter the submenu.

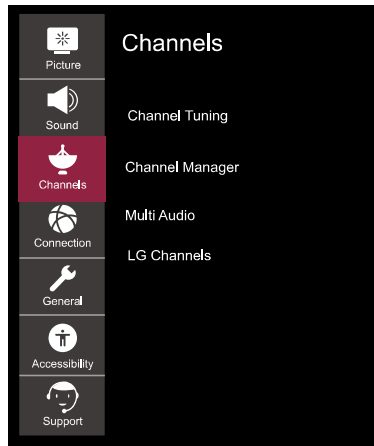

Channel Tuning

Tune and save available channels. You can choose Auto Tuning and manual Tuning to search for TV programs.

Channel Manager

Manage channels stored on the TV.

Multi Audio

Set audio-related options.

Note: Available options depend on the broadcast program.

TV SETUP

Connection Menu

Select **All** settings in settings menu, press (⊙) button to enter the submenu.

Press ▲/▼ buttons to select **connection** in the submenu, it will highlight the option, then press ► button to enter menu.

Press ▲/▼ button to select the option and press (⊙) button to enter the submenu.



TV Name

Set the TV name.

Network Connection Settings

Set settings related to your wired / wireless network.

Device Connection Settings

Set easy connection settings with external devices. After entering the menu, you can select and set these options of Auto Device Detection, SIMPLINK (HDMI-CEC), Auto Power Sync, LG Wireless , Keyboard and Universal Control Settings.

Mobile Connection Management

Connection Management with a smartphone or PC is available. In order to connect a TV with a mobile device, connection settings and requests are required on the smartphone and PC.

Wi-Fi Connection

Select Wi-Fi Connection in the Network Connection Settings menu, press (⊙) button to enter, then select the **WIFI** you want to connect to, and enter the password to connect to **WIFI**.

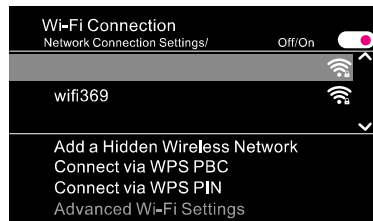

Add a Hidden Wireless Network

Add wireless network by "manually" entering network name (SSID).

Connect via WPS PBC

For a WPS(Wi-Fi Protected Setup)-enabled wireless router press the WPS-PBC button to onnect TV to the wireless network.

Connect via WPS PIN

For a WPS(Wi-Fi Protected Setup)-enabled wireless router, Enter PIN code to connect TV to the wireless network.