

Continental™

USER MANUAL

CE-TV55UQW1F2US

55" UHD/4K

FRAMELESS
SMART TV

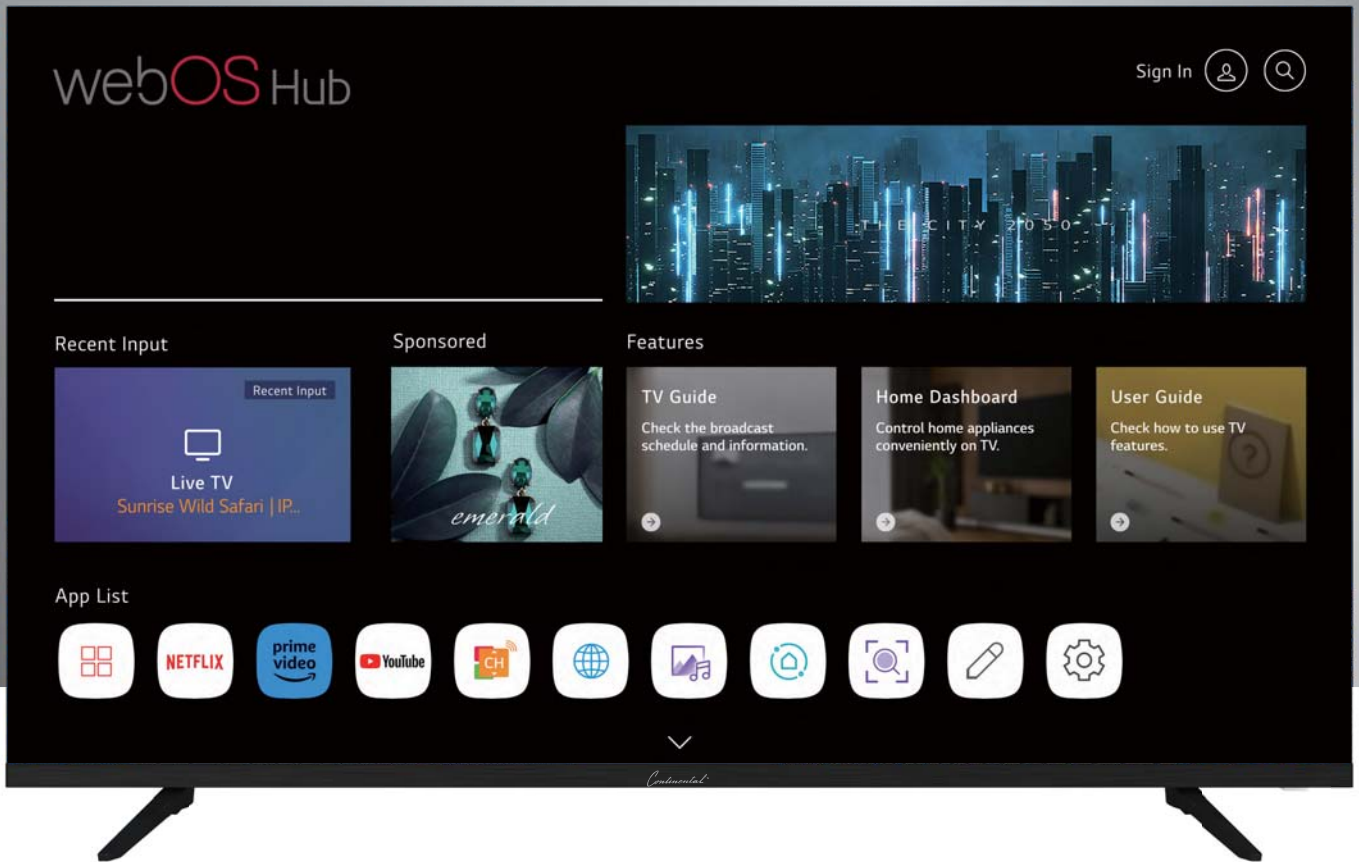

PLEASE READ CAREFULLY
AND KEEP THESE INSTRUCTIONS

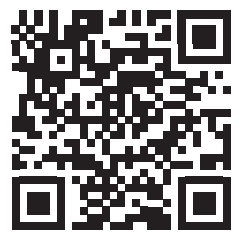

SCAN ME

Table of Contents

Safety warning	1
Important Safety Instructions	2
Preparation for Your New TV	3
Check Accessories	3
Stand Installation Guide	3
Wall mount specification	4
TV Jacks Explanation	5
External Device Connection Diagram	6
Side Keypad and Front Panel	7
Keypad Buttons	7
Front Panel	7
Remote Control Instructions	8
Inserting Batteries in the Remote	8
Remote Control Reception Angle	8
Learning about Remote Control	9
Remote Control Buttons	9
Basic Operations	10
Turning On and Off	10
Select input source	10
Adjust the OSD Screen	10
OSD Menu Operations	11
Menu Setting	11
Smart TV Operation	12
Media Operation	12
Troubleshooting	13
Identifying Problems	13
Specification	14

**The pictures, functions and other information provided in the manual are for reference only.
If it does not match the actual object, please refer to the actual product.*

Safety warning



CAUTION

**RISK OF ELECTRIC SHOCK
DO NOT OPEN**



Caution: To reduce the risk of electric shock, do not remove cover or back. No user-serviceable parts inside. Refer servicing to qualified service personnel.



The lightning flash with arrowhead symbol, within an equilateral triangle is intended to alert the user to the presence of uninsulated dangerous voltage within the product enclosure that may be of sufficient magnitude to constitute a risk of electric shock.



The exclamation point within an equilateral triangle is intended to alert the user to the presence of important operating and maintenance (servicing) instructions in the literature accompanying the TV.

WARNING: TO REDUCE THE RISK OF FIRE OR ELECTRIC SHOCK, DO NOT EXPOSE THIS APPLIANCE TO RAIN OR MOISTURE.

CAUTION: CHANGES OR MODIFICATIONS NOT EXPRESSLY APPROVED BY THE PARTY RESPONSIBLE FOR COMPLIANCE WITH THE FCC RULES COULD AVOID THE USERS AUTHORITY TO OPERATE THIS EQUIPMENT.

Safety Warning

Before operating the unit, please read through this manual.

PLACEMENT

- Do not place the unit on an unstable cart, stand, tripod, bracket, table, or shelf.
- Do not expose the unit to direct sunlight and other sources of heat.
- Do not handle liquids near or on the unit.
- Never spill liquid of any kind into the unit.
- Do not put the unit near appliances that create magnetic fields.
- Do not put heavy objects on top of the unit.

TEMPERATURE

- Do not place the unit near or over a radiator or a heater register.
- If your unit is suddenly moved from a cold to a warm place, unplug the power cord for at least two hours so that moisture that may have formed inside the unit can dry completely.

HUMIDITY

- Do not expose machine in rain, damp or place near water.
- Ensure the indoor drying, cool.

VENTILATION

- Keep the ventilation openings clear.

WARNING(Only applicable to models over 7kg)

Never place a television set in an unstable location. A television set may fall, causing serious personal injury or death. Many injuries, particularly to children, can be avoided by taking simple precautions such as:

- Using cabinets or stands recommended by the manufacturer of the television set.
 - Only using furniture that can safely support the television set.
 - Ensuring the television set is not overhanging the edge of the supporting furniture.
 - Not placing the television set on tall furniture (for example, cupboards or bookcases) without anchoring both the furniture and the television set to a suitable support.
 - Not placing the television set on cloth or other materials that may be located between the television set and supporting furniture.
 - Educating children about the dangers of climbing on furniture to reach the television set or its controls.
- If your existing television set is being retained and relocated, the same considerations as above should be applied.

Important Safety Instructions

1. Read these instructions.
2. Keep these instructions.
3. Heed all warnings.
4. Follow all instructions.
5. Do not use this apparatus near water. For example, do not use near a laundry tub, in a wet basement, or near a swimming pool, and the like.
6. Clean only with dry cloth.
7. Do not block any ventilation openings. Install in accordance with the manufacturer's instructions. Slots and openings in the cabinet back or bottom are provided for ventilation, to ensure reliable operation of the TV and to protect it from overheating. These openings must not be blocked or covered. The openings should never be blocked by placing the TV on a bed, sofa, rug, or other similar surface.
8. Do not install near any heat sources such as radiators, heat registers, stoves, or other apparatus (including amplifiers) that produce heat.
9. Do not defeat the safety purpose of the polarized or grounding-type plug. A polarized plug has two blades with one wider than the other. A grounding-type plug has two blades and a third grounding prong. The wide blade or the third prong is provided for your safety. If the provided plug does not fit into your outlet, consult an electrician for replacement of the obsolete outlet.
10. Protect the power cord from being walked on or pinched particularly at plugs, convenience receptacles, and the point where they exit from the apparatus.
11. Only use attachments/accessories specified by the manufacturer.
12. Use only with cart, stand, tripod, bracket, or table specified by the manufacturer, or sold with the apparatus. When a cart is used, use caution when moving the cart/apparatus combination to avoid injury from tip-over. A TV and cart combination should be moved with care. Quick stops, excessive force, and uneven surfaces may cause the TV and cart combination to overturn.
13. Unplug this apparatus during lightning storms or when unused for long periods of time. For added protection for this TV receiver during a lightning storm, or when it is left unused for long periods of time, unplug it from the wall outlet and disconnect antenna or cable system. This will prevent damage to the TV due to lightning and power line surges.
14. Refer all servicing to qualified service personnel. Servicing is required when the apparatus has been damaged in any way, such as power-supply cord or plug is damaged, liquid has been spilled or objects have fallen into the apparatus, the apparatus has been exposed to rain or moisture, does not operate normally, or has been dropped.
15. This TV should be operated only from the type of power supply indicated on the rating label. If customer is not sure the type of power supply in your home, consult your appliance dealer or local power company. For TV remote control battery power, refer to the operating instructions.
16. The TV set shall not be exposed to dripping or splashing. No objects filled with liquids, such as vases, shall be placed on the TV set.
17. Never push objects of any kind into this TV through openings as they may touch dangerous voltage or other electrical parts that could result in fire or electric shock. Never spill liquid of any kind into the TV.
18. Unplug the TV from the wall outlet before cleaning. Do not use liquid or aero cleaners. Use a damp cloth for cleaning.
19. This TV should never be placed near or over a radiator or heat resource. This TV should not be placed in a built-in installation such as a bookcase or rack unless proper ventilation is provided or the manufacturer's instructions have been adhered to.
20. Do not place this TV on an unstable cart, stand, tripod, bracket, or table. The TV may fall, causing serious injury to someone, and serious damage to the appliance.
21. Do not attempt to service this TV by yourself because opening or removing covers may expose you to dangerous high voltage or other hazards. Refer all servicing to qualified service personnel.
22. Please do the static electricity prevention and panel protect measures before overhaul, avert damage the panel and main board sensitive element, ex. IC etc.
23. **WARNING:** To prevent injury, this apparatus must be securely attached to the floor/wall in accordance with the installation instructions.



Preparation for Your New TV

Check Accessories

Check the accessories that are packed with your TV.



LED TV

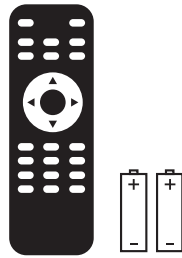

Remote Control & Batteries

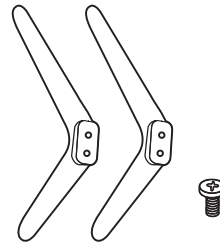

TV Stand Base
+
4 x Screws

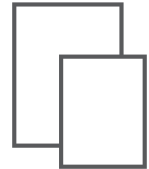

User's manual
+
Warranty Card

Stand Installation Guide

The TV is packaged with the TV stand separated from the cabinet. To setup the TV table stand, please carry out the installation according to the instructions below.

1. The panel can be scratched easily, so please:
Place a soft cloth on the table and place the TV face down on the cloth.
Note: Always unplug the AC cord first when installing/removing the stand.
2. Take the base. Please align the screw holes of the base and the TV, and then insert the screws into the holes on the base and tighten them.
Note: To ensure that the TV is stable, please lock all screws.

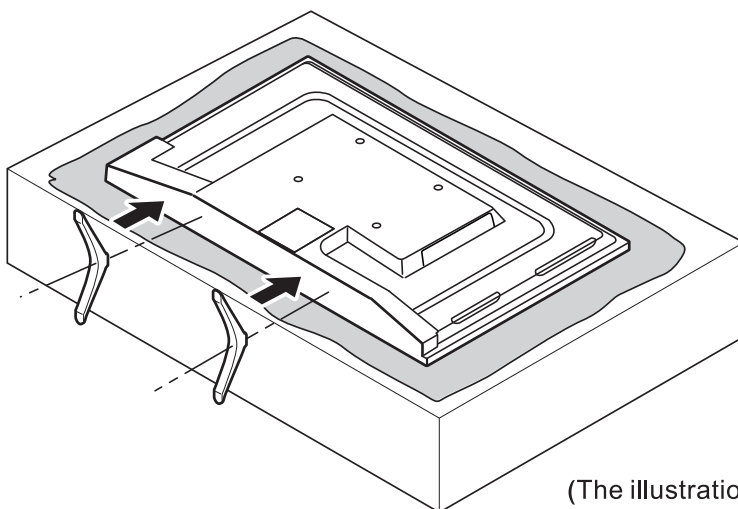

Please take note of the base direction:

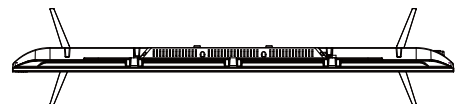

The bottom view of the TV
(Front cabinet faces down)

(The illustration is for reference only, Please prevail in kind)

Wall Mounting(if available)

Unit Dimension (unit:mm)	Screws
VESA 200x200	M6x8mm, 4pcs

Note: The length of the screw specified is only a recommendation; actual length required can vary depending on the type of wall mount used.

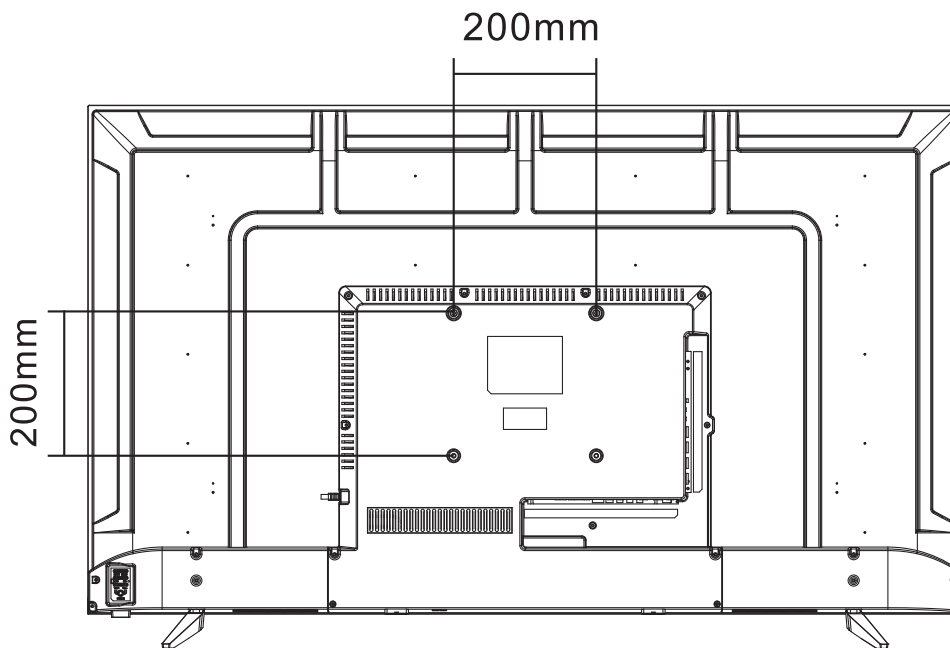

Warnings:

1. Do not set up the wall mount by yourself. Please contact qualified professionals for installation.
2. The TV should not be mounted on walls or surfaces which have an angle more than 10 degrees with vertical direction. Otherwise the TV set may fall.
3. The walls for mounting must have enough strength to hold the whole weight of TV set. For example, concrete wall and brickwork are eligible. Do not place the mount on soft walls such as earth walls and plasterboard.
4. If spare parts of different specifications (such as screws) are used during mounting, consult with qualified professionals to make sure these parts are safe and effective.
5. Before attaching the base to wall, ensure the holes for anchors are in keeping with the installing rules. Otherwise there may exist some potential problems.
6. Do not place any heating source under your television. Or else, it can cause fire.
7. Do not place the TV near anything dripping. Transducers and high voltage wires should be kept far away from the apparatus too. Or else, it may cause creepage, electric shock or bad resonance.
8. Do not place TV in a location where collision or vibration is liable to happen.
9. In order to avoid unexpected falling of the TV set, do not put any strong force on TV or wall mount after installing.
10. Be sure to unplug the TV before installing. Keep anything hard or sharp away from the screen panel to prevent the scuffing.
11. After installing, if there is any need to move the cabinet, please contact the qualified professionals.

TV Jacks Explanation

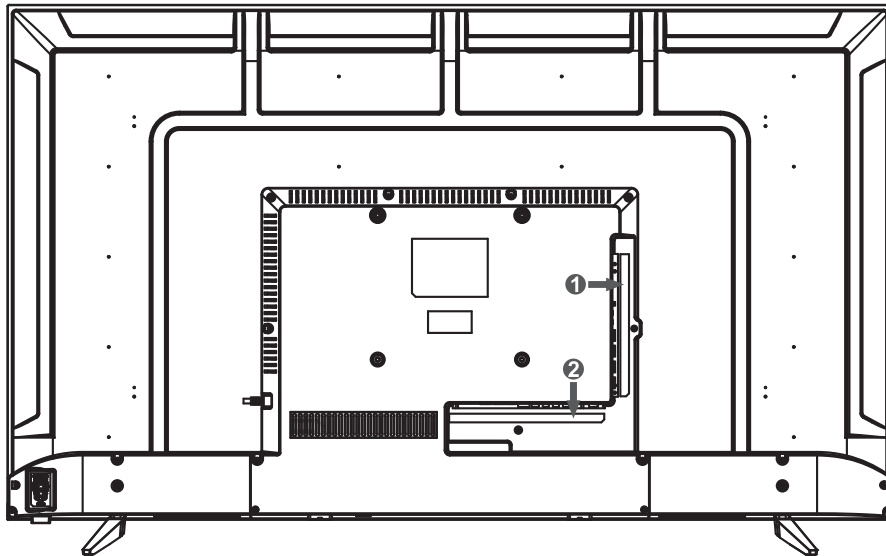

①	HDMI3	HDMI2/ARC	HDMI1	USB2 USB1	Earphone		
②		RJ45	CVBS	L	R	OPTICAL	RF

HDMI: (High-Definition Multimedia Interface) Provides an uncompressed digital connection.

USB: Connect the USB device such as the flash disk to access the TV media function.

EARPHONE: Connect a 3.5mm headset for personal audio.

RJ45:Connect the Internet.

CVBS : Connect an AV device that has composite video jacks, such as a VCR or DVD Player.

L: Left audio channel connection. The left audio connector is usually white.

R: Right audio channel connection. The right audio connector is usually red.

OPTICAL: Digital TV sound output.

RF: Connect to receive the signal from your antenna or cable through a coaxial cable.

External Device Connection Diagram

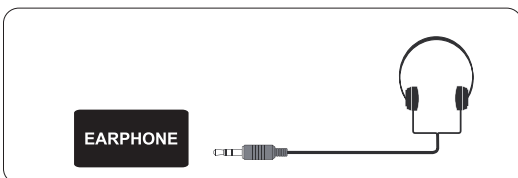
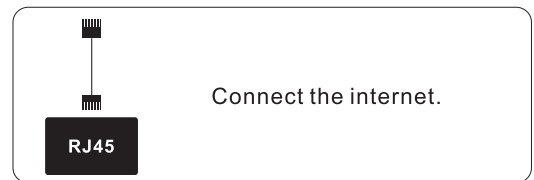
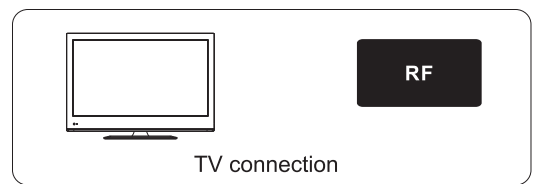
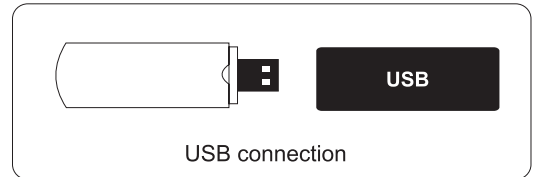
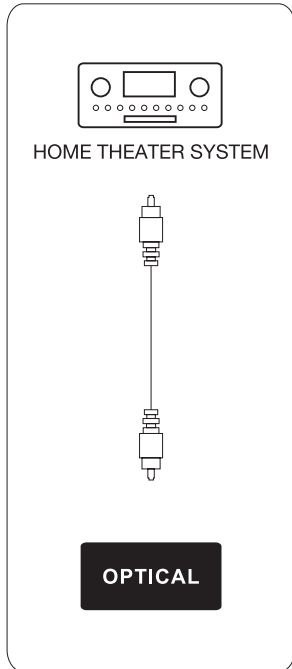
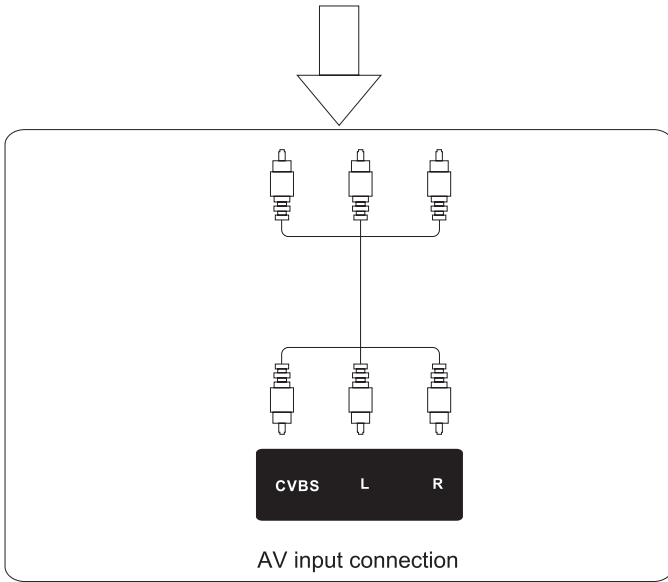
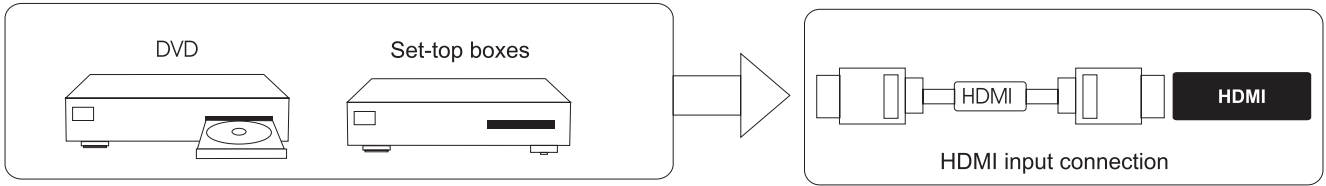

Side Keypad and Front Panel

Keypad Buttons

If you cannot locate your remote, you can use the side keypad buttons on your TV to operate many TV features.

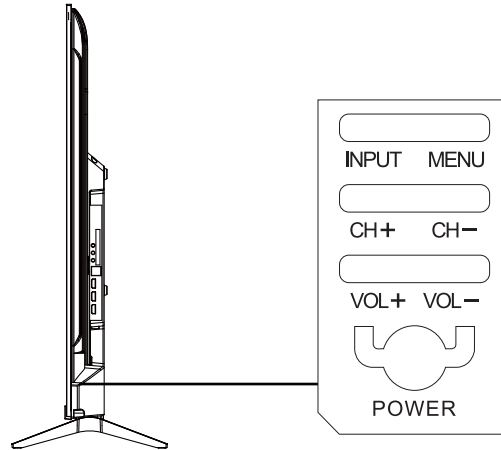

INPUT: Displays the Source Select List.

MENU: Displays the TV Main Menu.

CH+: Scans up through the channel list. In the TV menu system, it acts like the up arrow on the remote control and can be used to select menu options.

CH- : Scans down through the channel list. In the TV menu system, it acts like the down arrow on the remote control and can be used to select menu options.

VOL+: Increases the volume. In the TV menu system, it acts like the right arrow on the remote control and can be used to select menu options.

VOL-: Decreases the volume. In the TV menu system, it acts like the left arrow on the remote control and can be used to select menu options.

POWER / OK: When the unit is off, press this button to turn the TV on. While your TV is on, you can use the OK button to enter and confirm a menu function. Press and hold to turn off your unit.

Front Panel

Power/Standby Indicator: Blue and red dual-color LED. It shows red when the TV is turned off and blue when turned on.

Remote Control Sensor: Remote control IR sensor, which receives infrared ray sent by remote control.

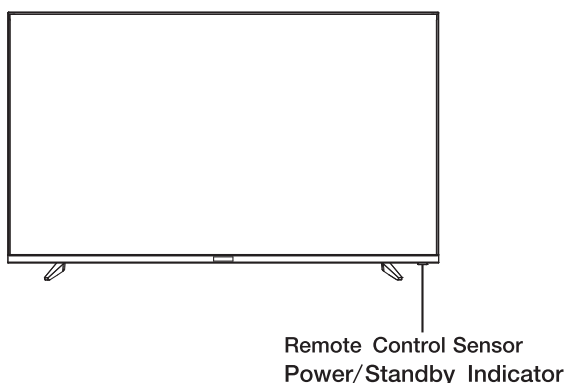

NOTE: If there is a protective film around the screen, remove the protective film before using the TV.

Remote Control Instructions

Inserting Batteries in the Remote

1. Remove the battery compartment cover from the back of the remote control by lifting the cover.
2. Insert 2AAA batteries, making sure the polarities(+and-) are aligned correctly.
3. Replace the cover.

If the remote control does not work, check these points:

- Are the polarities (+, -) correct?
- Are the batteries worn out?
- Is there an AC power failure?
- Is the power cord plugged in?
- Is there any interference or block near the remote control sensor?

CAUTION:

- Used batteries should be recycled.
- Keep out of children's reach.
- DO NOT use new and old batteries together.
- Change both the batteries at the same time.
- When not using the remote control for a long time, remove the batteries from the unit.

Warning: All batteries (packed or in use) must not be exposed to high temperature like sun heat or fire.

Remote Control Reception Angle

Use your remote control within the distance and angle range shown below.

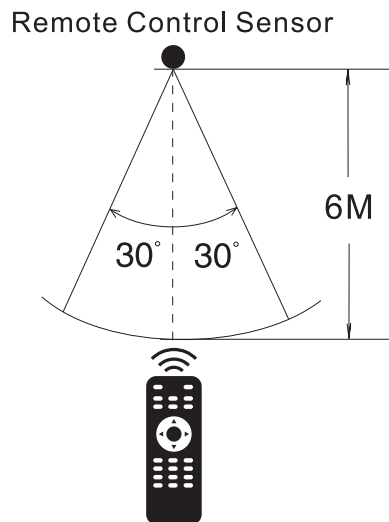

Learning about Remote Control



Power (⏻): Turns the TV on or off.

TV: Switch to TV Mode.

(Q): Switch to search menu.

CC/SUB: Setup the mode of closed caption or access the subtitle.

(⚙️): Enters the Quick Settings menu.

(📺): Select the input source mode.

Number buttons: Choose the channel directly

LIST: Access the channel list.

(⋯): It displays the additional buttons on the remote control.

Press this button to select the desired option from "More Actions" displayed on the TV screen.

VOL+/VOL- : Increases or decreases the TV volume.

CH[^]/_{PAGE} / CH^v/_{PAGE} : Change to the previous or next program.

QUICK ACCESS: long-press 0, you can add Quick Access.

FAV: jump to preset channel manager menu, then can edit the list of favorite channels in the channel management menu.

GUIDE: Check the programme.

MUTE (🔇): Mute or restore the sound.

PLAY (▶): Play while watching media.

PAUSE (⏸): Pause while watching media.

HOME (🏠): Enter the home page.

Return(Back): Return to the previous step.

EXIT: Exit the current screen.

Navigation buttons: (Up/Down/Left/Right ◀/▶/▲/▼)

Navigate the menu.

(⊙): Confirm the selection.

(ⓘ) INFO: Show the detailed information.

SAP: Turn on the Audio Language.

MOVIES: Search Movies.(make sure the Internet connection is normal)

REC: This button does not apply to this model.

(□) : Stop Function(only in multimedia mode).

NETFLIX: Access the Netflix interface.

Prime Video: Access the Prime Video interface.

Color Buttons(RED/GREEN/YELLOW/BLUE): Execute the prompt function in specific mode.

IMPORTANT NOTICE:

Depending on the country where the TV is installed, certain apps may not be available. The quick launch button on the remote control associated with those apps will therefore not work. All other functionalities of the remote will work as designed.

*Some functions and features are only available when using the LG ThinQ APP.



Basic Operations

Turning On and Off

Connect the AC cord to power the TV. At this time the TV will enter standby mode and power indicator will turn red. Use Power button() on the side panel of TV or on the remote control to turn on the TV. After switching off the TV for 5 seconds, you can turn on TV again.

Source Selection

Press () button to display the input source list.

Press  /  button to select the input source you want to watch, then press the Wheel (OK) button to enter the input source. HDMI input source needs to be selected in Home Dashboard.

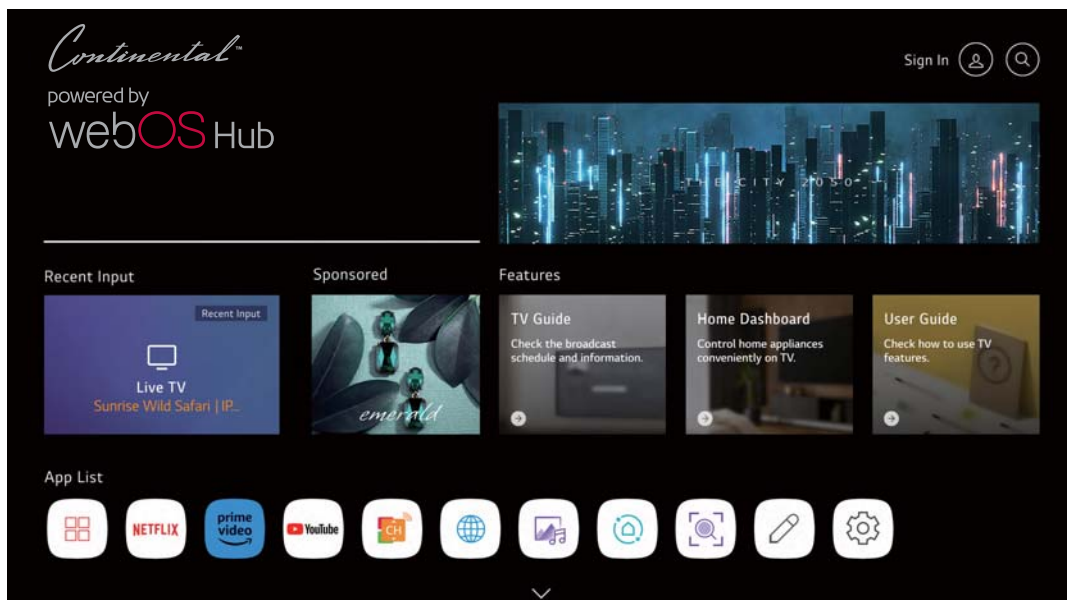

Note: Before watching please make sure all necessary cables and devices are connected.

OSD Menu Operations

Menu Setting

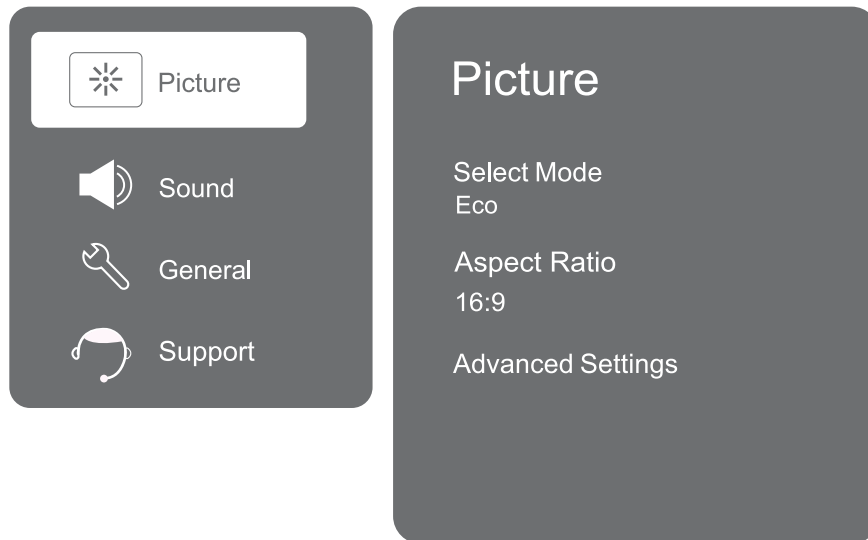

Picture Menu: Used for TV picture effect adjusting.

For example: Select Mode, Aspect Ratio and so on.

Sound Menu: Used for TV sound effect adjusting.

For example: Select Mode, Advanced Settings and so on.

General Menu: Used for TV general settings.

For example: Channels, System and so on.

Note: The default password is **0000**.

Support Menu: Used for TV Support Menu settings.

For example: Software Update, User Guide and so on.

For more settings, please refer to the menu settings.

OSD Menu Operations

Smart Home

Using the home feature of the webOS TV.

You can open the home screen by pressing the (🏠) button on your remote control.

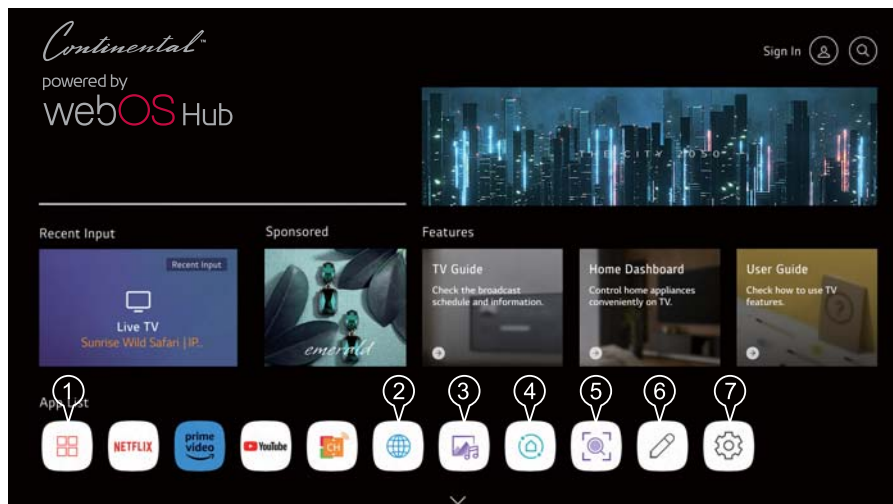

1. Move to the the APP store.
2. Move to the Browser.
3. Move to the Picture and Music playback menu.
4. Move To The Home Dashboard.
5. Enter the search menu. Search for a variety of content and information using the desired search terms.
Need to make sure the network connection is normal.
6. Move to the Edit menu.
7. Move to the Settings menu.

USB Media Player

Connect a USB storage device to the USB port on the TV to enjoy the content files stored on the USB storage device on your TV.

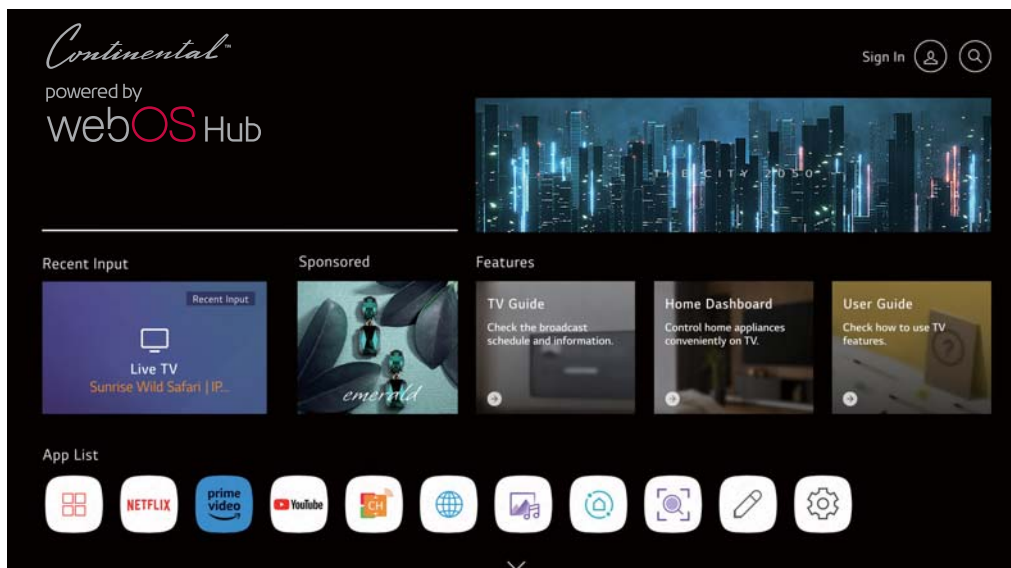

Troubleshooting

Identifying Problems

If there are any problems when using the product, please consult the list below. If the list does not solve the problem, call our Customer Service Center immediately.

TV Problems

The TV can't be turned on.

- Make sure the AC cord is plugged in.
- Check the wall outlet, make sure the AC output works normally and stably.
- Select the Key Lock function in the OPTION Menu and press OK to uncheck the locking status.

No picture or sound but the TV is on and there is a "No Signal" sign on screen.

- Are you trying to use an input source with no device connected to it? For using other video/audio device, make sure the external device works normally first, then press Source and choose the right input source.
- The signal type option may be set incorrectly.
- The channel may be blank. Try to search the channel again or change another channel.

The sound is fine, but the picture is poor.

- If you can only get black and white pictures from external device that you've connected to your TV, maybe it is due to the video cables is not connected well, or they are connected wrongly. Check the connection stability first, then check the correctness.
- For AV input, the yellow video cable connects to the yellow Video In jack on the side of your TV. For Component input, the three Y, Pb, Pr video cables (red, blue, and green) should be connect to the corresponding input jacks on the side of your TV.
- Check the antenna connections. Make sure all of the cables are firmly connected to the TV jack on side of your TV.
- Try adjusting the color features to improve.

There is no sound, but the picture is fine.

- The sound might be muted. Try pressing the MUTE button to restore sound.
- For using AV or Component, remember to connect the device's left and right audio output correctly. The left channel cable is white and the right channel cable is red. Please match the cables and jacks according to their colors.
- The sound settings may not be set correctly.
- If your audio source has only one jack or is a (mono) audio source, make sure you have plugged the connection into the Audio In L jack (white) on the TV.

The buttons on the side panel don't work.

- Unplug the TV from the AC power for 10 minutes and then plug it back. Turn the TV on and try again.

The TV turns off unexpectedly.

- The electronic protection circuit may have been activated because of a power surge. Wait 30 seconds and then turn the TV on again. If this happens frequently, the voltage in your house may be abnormal. If the other electronic equipment in your home can't work normally, consult a qualified service personnel.

The Remote control doesn't work.

- Something might be blocking between the remote control and the remote sensor on the front panel of the TV. Make sure there is a clear path.
- The remote may not be aimed directly at the TV.
- The batteries in the remote may be weak, dead, or installed incorrectly. Put new batteries in the remote.

FCC Radiation Exposure Statement:

This equipment complies with FCC radiation exposure limits set forth for an uncontrolled environment. This equipment should be installed and operated with minimum distance 20cm between the radiator & your body.

FCC Warning

This device complies with Part 15 of the FCC Rules. Operation is subject to the following two conditions:

(1) This device may not cause harmful interference, and (2) this device must accept any interference received, including interference that may cause undesired operation.

NOTE 1: This equipment has been tested and found to comply with the limits for a Class B digital device, pursuant to part 15 of the FCC Rules. These limits are designed to provide reasonable protection against harmful interference in a residential installation. This equipment generates uses and can radiate radio frequency energy and, if not installed and used in accordance with the instructions, may cause harmful interference to radio communications. However, there is no guarantee that interference will not occur in a particular installation. If this equipment does cause harmful interference to radio or television reception, which can be determined by turning the equipment off and on, the user is encouraged to try to correct the interference by one or more of the following measures:

- Reorient or relocate the receiving antenna.
- Increase the separation between the equipment and receiver.
- Connect the equipment into an outlet on a circuit different from that to which the receiver is connected.
- Consult the dealer or an experienced radio/TV technician for help.

NOTE 2: Any changes or modifications to this unit not expressly approved by the party responsible for compliance could void the user's authority to operate the equipment.

SPECIFICATIONS

Product Specifications

Model:	CE-TV55UQW1F2US
Video:	avi , MPEG
Music:	mp3
Photo:	jpg , jpeg, bmp, png
Screen resolution:	3840x2160
Working voltage:	100-240V ~ 50/60Hz
Rated power consumption:	150W

Continental™

MANUAL DE USUARIO

CE-TV55UQW1F2US

55" UHD/4K

FRAMELESS
SMART TV

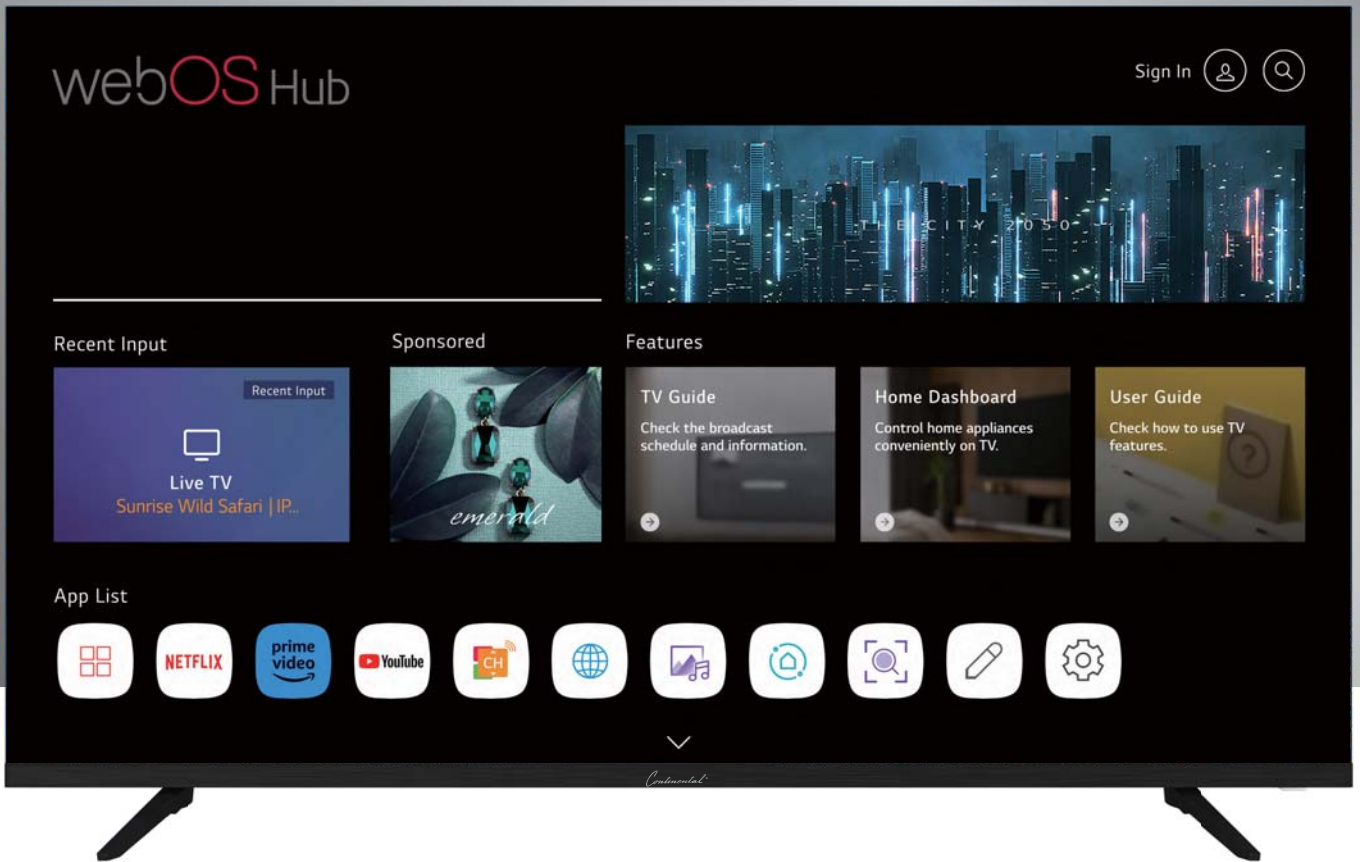

**POR FAVOR, LEA ATENTAMENTE
Y CONSERVE ESTAS INSTRUCCIONES**

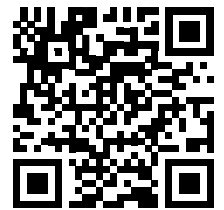

**ESCANEA
AQUÍ**

Tabla de Contenidos

Advertencia de seguridad	1
Precauciones de Seguridad	2
Preparación para Su Nueva Televisor	3
Verifique los Accesorios	3
Guía de Instalación del Soporte	3
Montaje en la Pared (si está disponible)	4
Explicación de las Tomas del TV	5
Diagrama de Conexión del Dispositivo Externo	6
Teclado Lateral y Panel Frontal	7
Botones del Panel Laterall	7
Panel Frontal	7
Instrucciones del Mando a Distancia	8
Insertar Baterías en el Mando a Distancia	8
Ángulo de Recepción del Mando a Distancia	8
Conociendo el Mando a Distancia	9
Botones del Mando a Distancia	9
Operaciones Básicas	10
Encenderlo y Apagarlo	10
Seleccionar de la Fuente	10
Operaciones del Menú OSD	11
Configuraciones del menú	11
Smart Home.....	12
Reproductor multimedia USB.....	12
Solución de Problemas	13
Identificación de Problemas.....	13
Especificaciones	14

Advertencia de seguridad



PRECAUCIÓN
RIESGO DE DESCARGA ELÉCTRICA
NO ABRIR



Precaución: Para reducir el riesgo de descarga eléctrica, no retire la cubierta o la parte posterior. Adentro no hay piezas reparables por el usuario. Remita el servicio al personal de servicio calificado.



El símbolo del rayo con punta de flecha, dentro de un triángulo equilátero, está destinado a alertar al usuario de la presencia de voltaje peligroso no aislado dentro del gabinete del producto que puede ser de magnitud suficiente como para constituir un riesgo de descarga eléctrica.



El signo de exclamación dentro de un triángulo equilátero tiene la intención de alertar al usuario de la presencia de instrucciones importantes de operación y mantenimiento (servicio) en la literatura que acompaña al televisor.

ADVERTENCIA: PARA REDUCIR EL RIESGO DE INCENDIO O DESCARGAS ELÉCTRICAS, NO EXPONGA ESTE APARATO A LA LLUVIA O LA HUMEDAD.

PRECAUCIÓN: LOS CAMBIOS O MODIFICACIONES NO APROBADOS EXPRESAMENTE POR LA PARTE RESPONSABLE DEL CUMPLIMIENTO DE LAS NORMAS DE LA FCC PODRÍAN EVITAR A LA AUTORIDAD DE LOS USUARIOS OPERAR ESTE EQUIPO.

Advertencia de seguridad

Antes de operar esta unidad, por favor, lea este manual detenidamente.

COLOCACIÓN

- No coloque la unidad en un carrito, soporte, trípode o estante inestable.
- No exponga la unidad a la luz solar directa ni a otras fuentes de calor.
- No maneje líquidos cerca o sobre la unidad.
- Nunca derrame líquido de ningún tipo en la unidad
- No coloque la unidad cerca de aparatos que generen campos magnéticos.
- No coloque objetos pesados encima de la unidad

TEMPERATURA

- No coloque la unidad cerca ni conecte un radiador o un registro de sanador.
- Si la unidad se traslada rápidamente de un lugar frío a un lugar cálido, desconecte el cable de alimentación durante al menos dos horas para que la humedad que se hayan formado en el interior de la unidad se seque por completo.

HUMEDAD

- No exponga la máquina a la lluvia, la humedad o colocarla cerca del agua
- Asegúrese de que el interior esté seca y fresca.

VENTILACIÓN

- Mantenga claras las aberturas de ventilación.

ADVERTENCIA (solo aplicable a modelos de más de 7 kg)

Nunca coloque un televisor en una ubicación inestable. Un televisor puede caerse y causar lesiones personales graves o la muerte.

Muchas lesiones, particularmente a los niños, pueden evitarse tomando precauciones simples como:

- Utilizando gabinetes o soportes recomendados por el fabricante del televisor.
- Solo usar muebles que puedan soportar de manera segura el televisor.
- Asegurarse de que el televisor no sobresalga del borde de los muebles de soporte.
- No colocar el televisor en muebles altos (por ejemplo, armarios o estanterías) sin anclar tanto el mobiliario como el televisor a un soporte adecuado.
- No colocar el televisor en un paño u otros materiales que puedan estar ubicados entre el televisor y los muebles de apoyo.
- Educar a los niños sobre los peligros de treparse a los muebles para alcanzar el televisor o sus controles. Si su televisor existente se está reteniendo y reubicando, se deben aplicar las mismas consideraciones que arriba.

Precauciones de Seguridad

1. Lea estas instrucciones.
2. Guarde estas instrucciones.
3. Observe todas las advertencias.
4. Siga todas las instrucciones.
5. No use este aparato cerca del agua. Por ejemplo, no lo use cerca de un lavadero, en un sótano húmedo o cerca de una piscina y similares.
6. Limpie solo con un paño seco.
7. No bloquee ninguna abertura de ventilación. Haga la instalación conforme a las instrucciones del fabricante. Las ranuras y aberturas en la parte posterior o inferior del gabinete se proporcionan para la ventilación, para garantizar un funcionamiento confiable del televisor y para protegerlo de un sobrecalentamiento. Estas aberturas no deben ser bloqueadas o cubiertas. Las aberturas nunca se deben bloquear colocando el televisor en una cama, sofá, alfombra u otra superficie similar.
8. No instale cerca de fuentes de calor como radiadores, registros de calor, estufas u otros aparatos (incluidos amplificadores) que produzcan calor.
9. No modifique el propósito de seguridad del enchufe polarizado o con conexión a tierra. Un enchufe polarizado tiene dos cuchillas con una más ancha que la otra. Un enchufe con toma de tierra tiene dos cuchillas y una tercera a tierra. La cuchilla ancha o la tercera clavija se proporcionan para su seguridad. Si el enchufe provisto no encaja en su toma de corriente, consulte a un electricista para reemplazar el equipo obsoleto.
10. Proteja el cable de alimentación de ser pisado o pellizcado particularmente en los enchufes, receptáculos de conveniencia y el punto donde salen del aparato.
11. Utilice únicamente aditamentos/ accesorios especificados por el fabricante.
12. Use solo con el carrito, el soporte, el trípode, el apoyo o la mesa especificados por el fabricante, o vendidos con el aparato. Cuando se usa un carro, tenga cuidado al mover la combinación del carro / aparato para evitar lesiones por vuelco. Una combinación de TV y carrito debe moverse con cuidado. Las paradas rápidas, la fuerza excesiva y las superficies irregulares pueden hacer que la combinación de TV y carrito se vuelque.
13. Desconecte este aparato durante tormentas eléctricas o cuando no se use durante largos períodos de tiempo. Para una protección adicional para este receptor de TV durante una tormenta eléctrica, o cuando no se utiliza durante largos períodos de tiempo, desenchúfelo de la toma de corriente y desconecte la antena o el sistema de cable. Esto evitará daños al televisor debido a los rayos y las sobretensiones de la línea de alimentación.
14. Remita todos los servicios a personal de servicio calificado. Se requiere servicio cuando el aparato ha sido dañado de alguna manera, como el cable de alimentación o el enchufe está dañado, se ha derramado líquido u objetos han caído en el aparato, el aparato ha estado expuesto a la lluvia o la humedad, no funciona normalmente, o ha sido eliminado.
15. Este televisor debe funcionar solo con el tipo de fuente de alimentación indicada en la etiqueta de clasificación. Si el cliente no está seguro del tipo de fuente de alimentación en su hogar, consulte con su distribuidor de electrodomésticos o con la compañía eléctrica local. Para la potencia de la batería del mando a distancia del televisor, consulte las instrucciones de funcionamiento.
16. El televisor no debe exponerse a goteos o salpicaduras. No se colocarán objetos llenos de líquidos, como jarrones, en el televisor.
17. Nunca inserte objetos de ningún tipo en este televisor a través de las aberturas, ya que pueden tocar una tensión peligrosa u otras partes eléctricas que podrían provocar un incendio o una descarga eléctrica. Nunca derrame líquido de ningún tipo en el televisor.
18. Desenchufe el televisor de la toma de corriente antes de limpiarlo. No use líquidos o aerosoles limpiadores. Utilice un paño húmedo para limpiarlo.
19. Este televisor nunca se debe colocar cerca o sobre un radiador o fuente de calor. Este televisor no debe colocarse en una instalación incorporada, como una estantería o un estante, a menos que se proporcione una ventilación adecuada o se cumplan las instrucciones del fabricante.
20. No coloque este televisor en un carrito, soporte, trípode, soporte o mesa inestable. El televisor puede caerse, causando lesiones graves a alguien y daños graves al aparato.
21. No intente reparar este televisor usted mismo, ya que al abrir o quitar las cubiertas puede exponerse a un alto voltaje peligroso u otros peligros. Remita todos los servicios a personal de servicio calificado.
22. Por favor, haga las medidas de prevención de electricidad estática y protección del panel antes de la revisión, evite dañar el panel y el elemento sensible de la placa principal, por ejemplo, IC, etc.
23. OJO: Para evitar lesiones, este aparato debe estar firmemente sujeto al piso / pared de acuerdo con las instrucciones de instalación.

