



# INSTRUCTION MANUAL

Before using the TV, please read this manual thoroughly, and retain it for future reference.



**Model: RNSMU7040**



“This product is manufactured and sold by Curtis International Ltd.

RCA, the RCA logo, the two dogs (Nipper and Chipper) logo, are registered trademarks or trademarks of RCA Trademark Management and are used under license by Curtis International Ltd.

Any other product, service, company, trade or product name and logo referenced herein are neither endorsed nor sponsored by RCA Trademark Management or its affiliates.”



## CONTENTS

1	<b>SAFETY PRECAUTION</b>		1
2	<b>IMPORTANT SAFETY INSTRUCTIONS</b>		2
3	<b>ACCESSORIES</b>		3
4	<b>GETTING STARTED</b>		3
5	<b>CONTROL REFERENCE GUIDE</b>	Remote Control	4
		Front View	5
		Side View	5
		Back View	6
6	<b>WALL MOUNT INSTALLATION</b>		7
7	<b>CONNECTIONS</b>	Installation	8
		Antenna Connection	9
		AV Connection	9
		HDMI Connection	10
		Power Cord Connection	10
		Optical audio output Connection	11
8	<b>INITIAL SETUP</b>	Putting The Unit On A Proper Place	12
		Turning The Unit On For The First Time	12
		Source Selection	12
9	<b>TV SETUP</b>	Picture Menu	13
		Sound Menu	14
		Channel Menu	15
		Time Menu	16
		Setup Menu	17
		Advance Menu	18
		Network Menu	19

# CONTENTS

---

10	<b>USB MEDIA PLAYER</b>		20
11	<b>SMART TV OPERATION</b>		22
12	<b>DISPLAY MODE</b>	Video Formats	25
13	<b>SPECIFICATION</b>		26
14	<b>TROUBLE- SHOOTING GUIDE</b>	TV Symptom	27
15	<b>WARRANTY CARD</b>		28

---

---

*\* The pictures, functions and other information provided in the manual are for reference only.  
If it does not match the actual object, please refer to the actual product.*

---

# SAFETY PRECAUTION

\* CAUTION MARKING WAS LOCATED AT THE REAR OF THE APPARATUS. **PLACEMENT INFORMATION**



WARNING: TO REDUCE THE RISK OF ELECTRIC SHOCK, DO NOT REMOVE COVER (OR BACK) NO USER SERVICEABLE PARTS INSIDE. REFER SERVICING TO QUALIFIED SERVICE PERSONNEL.

 The lightning flash with arrowhead symbol, within an equilateral triangle, is intended to alert the user to the presence of uninsulated “dangerous voltage” within the product’s enclosure that may be of sufficient magnitude to constitute a risk of electric shock to persons.

 The exclamation point within an equilateral Triangle is intended to alert the user to the presence of important operating and maintenance (servicing) instructions in the literature accompanying the appliance.

 **CAUTION**

- DANGER OF EXPLOSION IF BATTERY IS INCORRECTLY REPLACED. REPLACE ONLY WITH THE SAME OR EQUIVALENT TYPE.
- USE OF CONTROLS OR ADJUSTMENTS OR PERFORMANCE OF PROCEDURES OTHER THAN THOSE SPECIFIED MAY RESULT IN HAZARDOUS RADIATION EXPOSURE.

 **WARNING:**

- TO REDUCE THE RISK OF FIRE OR ELECTRIC SHOCK, DO NOT EXPOSE THIS APPLIANCE TO RAIN OR MOISTURE.
- TO PREVENT FIRE OR SHOCK HAZARD, DO NOT EXPOSE THIS UNIT TO RAIN OR MOISTURE. DO NOT PLACE OBJECTS FILLED WITH LIQUIDS ON OR NEAR THIS UNIT.
- SHOULD ANY TROUBLE OCCUR, DISCONNECT THE AC POWER CORD AND REFER SERVICING TO A QUALIFIED TECHNICIAN.

 This equipment is a Class II or double insulated electrical appliance. It has been designed in such a way that it does not require a safety connection to electrical earth.

- Do not use this unit in places that are extremely hot, cold, dusty or humid.
- Do not restrict the airflow of this unit by placing it somewhere with poor airflow, by covering it with a cloth, by placing it on bedding or carpeting.

## SAFETY INFORMATION

- When connecting or disconnecting the AC power cord, grip the plug and not the cord itself. Pulling the cord may damage it and create a hazard.
- When you are not going to use the unit for a long period of time, disconnect the AC power cord.

## RATING PLATE LOCATION

The rating plate is located on the rear of the unit.

## FCC STATEMENTS

NOTE: This unit has been tested and found to comply with the limits for a Class B digital device, pursuant to Part 15 of the FCC Rules. These limits are designed to provide reasonable protection against harmful interference in a residential installation.

This unit generates, uses and can radiate radio frequency energy and, if not installed and used in accordance with the instructions, may cause harmful interference to radio communication. However, there is no guarantee that interference will not occur in a particular installation. If this unit does cause harmful interference to radio or television reception, which can be determined by turning the unit off and on, the user is encouraged to try to correct the interference by one or more of the following measures:

- Reorient or relocate the receiving antenna.
- Increase the separation between the unit and receiver.
- Connect the unit into an outlet on a circuit different from that to which the receiver is connected.
- Consult the dealer or an experienced radio/TV technician for help.

 **WARNING:**

Changes or modifications to this unit not expressly approved by the party responsible for compliance could void the user authority to operate the unit.

**HDMI**®  
HIGH-DEFINITION MULTIMEDIA INTERFACE

“HDMI, the HDMI logo and High-Definition Multimedia Interface are trademarks or registered trademarks of HDMI Licensing LLC.”

# IMPORTANT SAFETY INSTRUCTIONS

- 1) Read these instructions.
- 2) Keep these instructions.
- 3) Heed all warnings.
- 4) Follow all instructions.
- 5) Do not use this apparatus near water.
- 6) Clean only with a dry cloth.
- 7) Do not block any ventilation openings.  
Install in accordance with the manufacturer's instructions.
- 8) Do not install near any heat sources such as radiators, heat registers, stoves, or other apparatus (including amplifiers) that produce heat.
- 9) Do not defeat the safety purpose of the polarized or grounding-type plug.  
A polarized plug has two blades with one wider than the other.  
A grounding type plug has two blades and a third grounding prong.  
The wide blade or the third prong is provided for your safety.  
If the provided plug does not fit into your wall outlet, consult an electrician for replacement of the obsolete outlet.
- 10) Protect the power cord from being walked on or pinched particularly at plugs, convenience receptacles, and the point where they exit from the apparatus.
- 11) Only use attachments / accessories specified by the manufacturer.
- 12) Use only with the cart, stand, tripod, bracket, or table specified by the manufacturer, or sold with the apparatus.  
When a cart is used, use caution when moving the cart / apparatus combination to avoid injury from tip-over.
- 13) Unplug this apparatus during lightning storms or when unused for long periods of time.
- 14) Refer all servicing to qualified service personnel. Servicing is required when the apparatus has been damaged in any way, such as the power cord or plug is damaged, liquid has been spilled or objects have fallen into the apparatus, the apparatus has been exposed to rain or moisture, does not operate normally, or has been dropped.
- 15) The mains plug is used as disconnect device, the disconnect device shall remain readily operable.



## PERSONAL SAFETY NOTICE

- ALWAYS read and follow all instructions for the installation and use of the TV.
- Place the TV in a location that is level and sturdy.
- DO NOT place the TV on a furniture with drawers that can be used as steps by small children.
- DO NOT allow children to pull the TV or climb on the furniture where the TV is placed.
- DO NOT allow children to play in front of or around the TV.
- ALWAYS route all the cables connecting to the TV so the cables cannot be easily pulled and grabbed by children.
- When installing the TV on a wall, please purchase a TV mount recommended by a professional TV installer, and follow the installation instructions that come with the TV mount.
- Before installing the TV on a wall, please check to make sure the wall structure can support the weight of the TV and the mount. If in doubt, please ask the advice from a professional TV installer.

### FCC Radiation Exposure Statement:

This equipment complies with FCC radiation exposure limits set forth for an uncontrolled environment. This equipment should be installed and operated with minimum distance 20cm between the radiator & your body.

# ACCESSORIES

Please check and identify the supplied accessories.

Remote control .....	x 1
Battery(AAA) .....	x 2
Instruction Manual .....	x 1
Base stand .....	x 2
Base stand screws.....	x 4
Troubleshooting instructions card.....	x 1

## GETTING STARTED

### USING THE REMOTE CONTROL

- Point the remote control at the remote sensor located on the unit.
- When there is a strong ambient light source, the performance of the infrared remote sensor may be degraded, causing unreliable operation.
- The recommended effective distance for remote operation is about 16 feet (5 meters).

### TO INSTALL THE BATTERIES

1. Open the battery door.

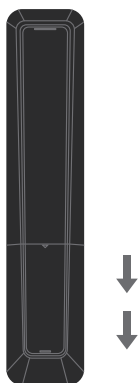

2. Insert 2"AAA"batteries.

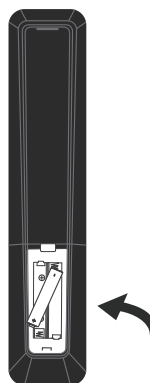

### BATTERY REPLACEMENT

When the batteries become weak, the operating distance of the remote control is greatly reduced and you will need to replace the batteries.

**! CAUTION :** Danger of explosion if battery is incorrectly replaced.

### NOTES

- If the remote control is not going to be used for a long time, remove the batteries to avoid damage caused by battery leakage corrosion.
- Do not mix old and new batteries. Do not mix ALKALINE, standard (CARBON-ZINC) or rechargeable (NICKEL-CADMIUM) batteries.
- Always remove batteries as soon as they become weak.
- Weak batteries can leak and severely damage the remote control.

**! WARNING :**  
Do not dispose batteries in a fire. Batteries may explode or leak.  
Batteries shall not be exposed to excessive heat such as sunshine, fire or the like.

# CONTROL REFERENCE GUIDE

## REMOTE CONTROL

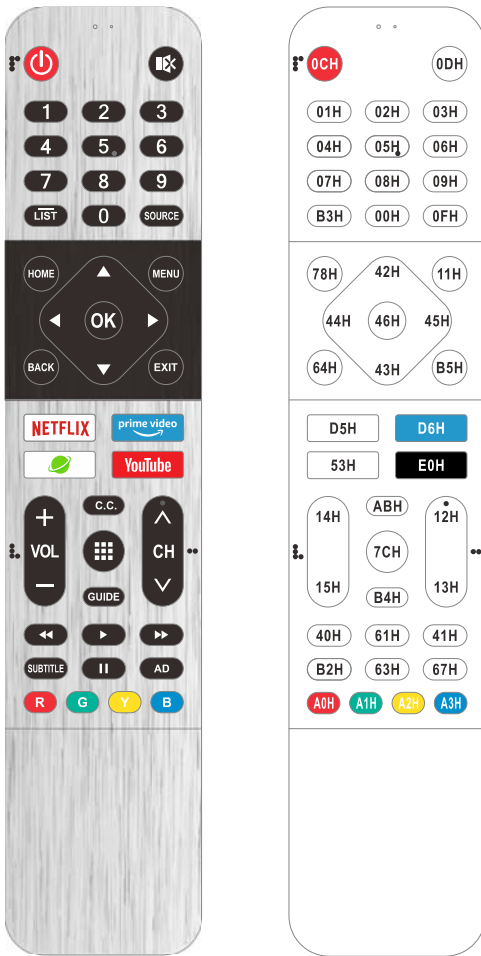

Remote control system code: TC9012

Customer code: 0E

POWER(⏻): Turns the TV on or off.

MUTE(🔇): Mute or restore the sound

Number buttons: Choose the channel directly

LIST: Access the channel list.

SOURCE: Select the input source mode.

HOME(🏠): Enter the home page.

Return(Back): Return to the previously-viewed channel.

MENU: Access the main menu

EXIT: Exit the current screen.

Navigation buttons: (Up/Down/Left/Right ◀/▶/▲/▼)  
Navigate the menu.

OK: Confirm the selection.

NETFLIX: Access the Netflix interface.

PRIME VIDEO: Access the Prime Video interface.

🌐: Access the Internet.

YOUTUBE: Access the Youtube interface.

VOL+/VOL- : Increases or decreases the TV volume.

CH^/CHv : Change to the previous or next program.

CC: Setup the mode of closed caption.

GUIDE: Shows Electronic Program Guide.

FAST BACKWARD/FAST FORWARD (◀◀/▶▶): Fast review of fast forward.

PLAY (▶): Play while watching media.

PAUSE (⏸): Pause while watching media.

SUBTITLE: Access the subtitle.

AD: Shortcut voice channel of blind.

Color Buttons(REDF/GREEN/YELLOW/BLUE): Execute the prompt function in specific mode.

### IMPORTANT NOTICE:

Depending on the country where the TV is installed, certain apps may not be available.

The quick launch button on the remote control associated with those apps will therefore not work.

All other functionalities of the remote will work as designed.



# CONTROL REFERENCE GUIDE

## FRONT VIEW

About remote control working distance and angle, see next page.

Power/Standby Indicator: Blue and red dual-color LED. It shows red when the TV is turned off and blue when turned on. Remote Control Sensor: Remote control IR sensor, which receives infrared ray sent by remote control.

NOTE: If there is a protective film around the screen, remove the protective film before using the TV.

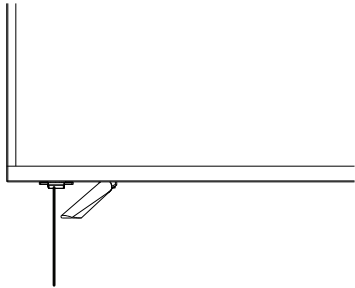

Remote Control Sensor  
Power/Standby Indicator

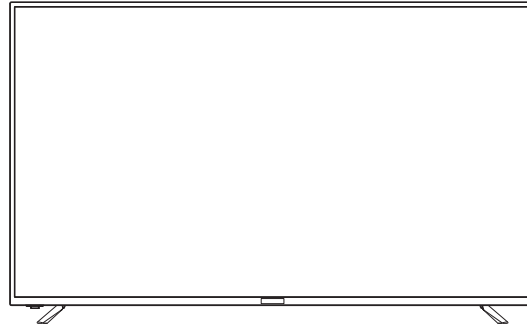

## SIDE VIEW

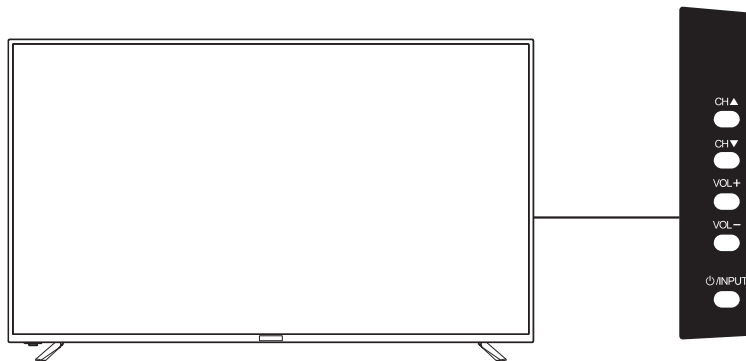

**CH▲:** Scans up through the channel list. In the input source menu, it acts like the up arrow on the remote control.

**CH▼:** Scans down through the channel list. In the input source menu, it acts like the down arrow on the remote control.

**VOL+:** Increases the volume.

**VOL-:** Decreases the volume.

**⏻/INPUT:** When TV power off, short press this button to turn on. When TV is on, long press this button to turn off, short press this button to call out the input source menu, press the CH+/- button to select the input source and press the power on/off button again to confirm the selection.

## BACK VIEW

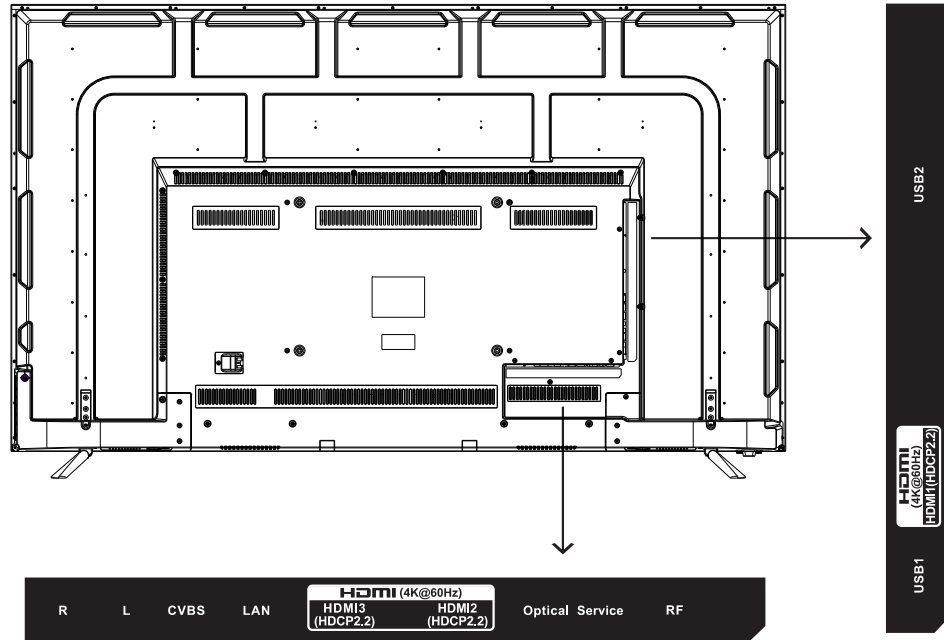

CVBS : Connect an AV device that has composite video jacks, such as a VCR or DVD player.

- *L*: Left audio channel connection.
- *R*: Right audio channel connection.

LAN: Connect the Internet.

HDMI: (High-Definition Multimedia Interface) Provides an uncompressed digital connection. Please enter to the setup menu to turn it on.

OPTICAL: Digital TV sound output.

Service: This port is used by professional maintenance personnel when repairing the machine.

RF: Connect to receive the signal from your antenna or cable through a coaxial cable.

USB: Connect the USB device such as the flash disk to access the TV media function.

HDMI Link (HDMI1): Command and control HDMI devices connected to the TV set. Please enter to the setup menu to turn it on.

# WALL MOUNT INSTALLATION

## INSTALLING / REMOVING THE BASE STAND

**WARNING :** The LED Display is very fragile, and must be protected at all times when removing the base Stand.

Be sure that no hard or sharp object or anything that could scratch or damage the LED display comes into contact with it. Do NOT exert pressure on the front of the unit at any time because the screen could crack.

1. Disconnect all cables or cords connected to the unit.
2. Lay the unit down on a flat surface with the back side facing up. Please make sure to place a soft cushioned material (such as a pillow or thick piece of foam) beneath the screen.
3. To remove the base stand, loosen screws off the holes then pull downwards to release the base stand

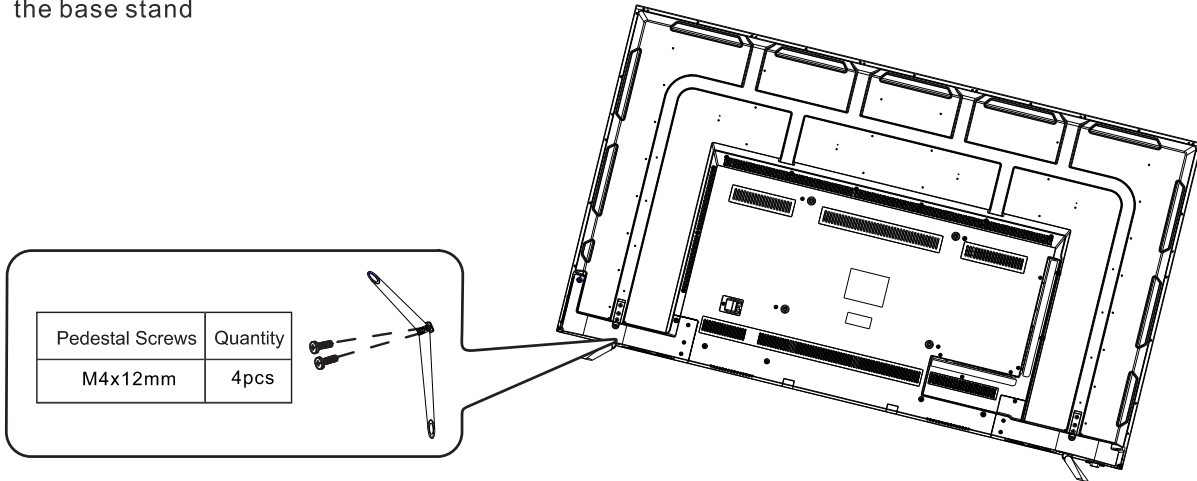

## MOUNTING ON THE WALL

This unit is VESA-compliant, and is designed to be wall-mounted with a VESA-compliant 16" x 12" (400mm x 300mm) mounting kit designed for flat-panel TVs (not supplied). Length of screw should be not exceed 8 mm

## NOTE

Remove the base stand before mounting the unit on the wall.

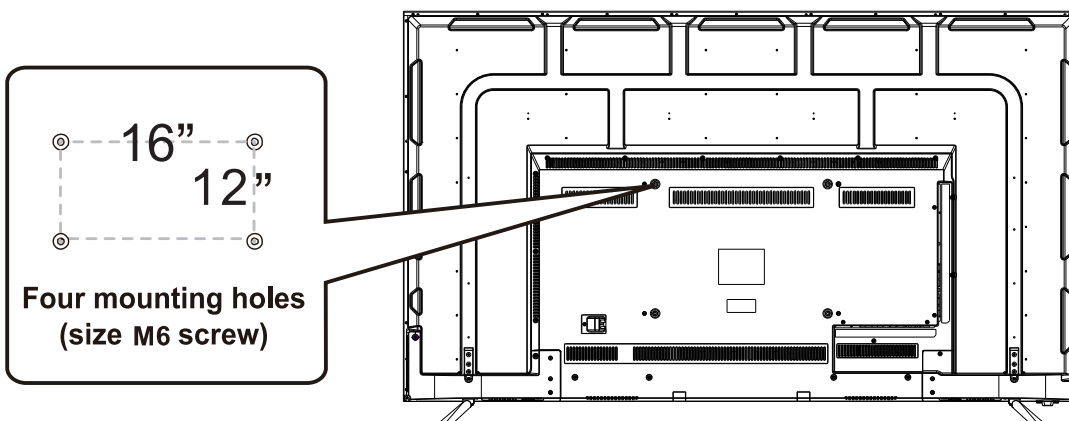

# Installation

Your TV is packaged with the stand and the cabinet separated. Before using the TV, install the stand as described below, or if you want to mount it to a wall, see page 7 for mounting advice; the wall mount itself is not supplied.

## IMPORTANT!

- Make sure the TV set is unplugged from the power supply before installing or removing the stand.
- The TV panel may be awkward to install on your own. We recommend you ask someone to help with installation and/or removal of the stand.

## Attaching the stand

### Step 1

Place a soft cushioned material on top of a flat surface to prevent damaging the screen panel. Then place the TV monitor flat on top, with the screen side facing down, as illustrated on the right (1).

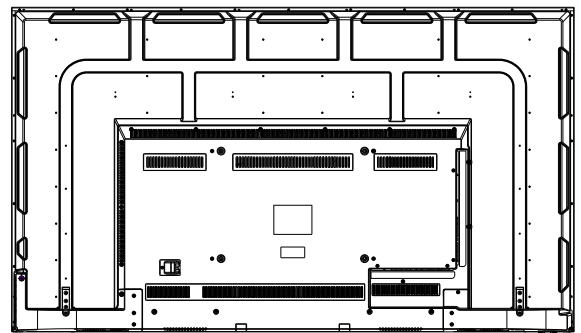

①

### Step 2

Align the screw holes on the stand and the bottom of the TV, as illustrated on the right (2).

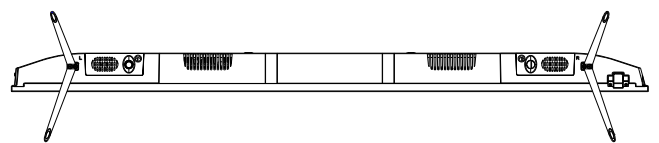

②

### Step 3

Tighten the screws (supplied) with a screwdriver to affix the stand to the panel, as illustrated on the right (3).

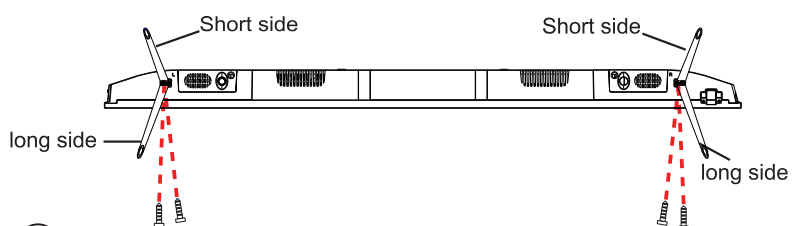

③

# CONNECTIONS

## CONNECTING A TV ANTENNA / CABLE / SATELLITE

To view television channels correctly, a signal must be received from one of the following sources:

- An indoor or outdoor aerial antenna
- A cable system
- A satellite system

### NOTE

For receiving over-the-air TV broadcasts, we recommend that you use an external fixed antenna. Should you require the use of a temporary antenna, please ensure that you purchase an antenna with sufficient ability to receive in weak signal areas. Only when you are in close proximity to a transmitter will a temporary antenna reproduce a signal as strongly as a fixed antenna.

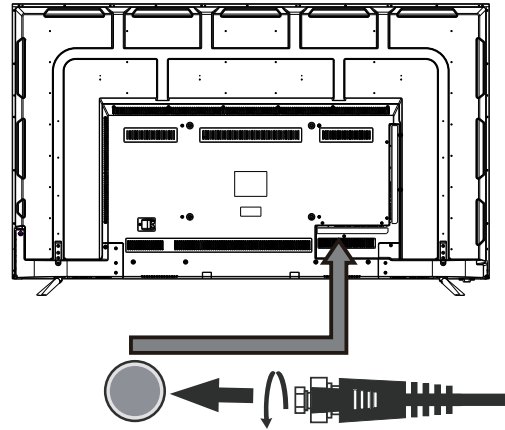

Satellite, cable or TV antenna cable to TV ANTENNA terminal (cable not included)

## CONNECTING AN A/V DEVICE

To connect to other equipment such as a VCR, camcorder, satellite system or cable, etc.

## CONNECTING DEVICES WITH A COMPOSITE VIDEO OUTPUT

To connect A/V devices such as a VCR, video game system or camcorder.

### Connecting to a VCR / Video Game System / Camcorder

Connect the AUDIO / VIDEO cable (not included) as shown.

Make sure you connect the cable from the other equipment ( **AUDIO** and **VIDEO OUT** ) to this unit (AV in)

### NOTE

1. Please refer to the user manual for the other equipment for more information.

2. Composite video input (shared with component)

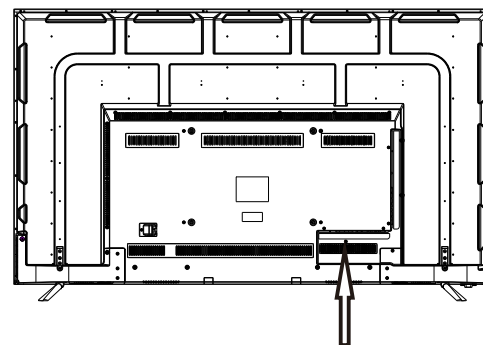

To AUDIO / VIDEO OUT jacks

VCR / VIDEO GAME SYSTEM / CAMCORDER etc.

To AUDIO / VIDEO IN jacks

# CONNECTIONS

## CONNECTING A HIGH-DEFINITION (HD) SOURCE USING HDMI CONNECTION

HDMI (High Definition Multimedia Interface) supports both video and audio on a single digital connection for use with DVD players, DTV, set-top boxes and other digital AV devices. HDMI was developed to provide the technologies of High Bandwidth Digital Content Protection (HDCP) as well as Digital Visual Interface (DVI) in one specification. HDCP is used to protect digital content transmitted and received by DVI-compliant or HDMI-compliant displays.

HDMI has the capability to support standard, enhanced or high-definition video plus standard to multi-channel surround-sound audio. HDMI features include uncompressed digital video, a bandwidth of up to 2.2 gigabytes per second (with HDTV signals), one connector (instead of several cables and connectors), and communication between the AV source and AV devices such as DTVs.

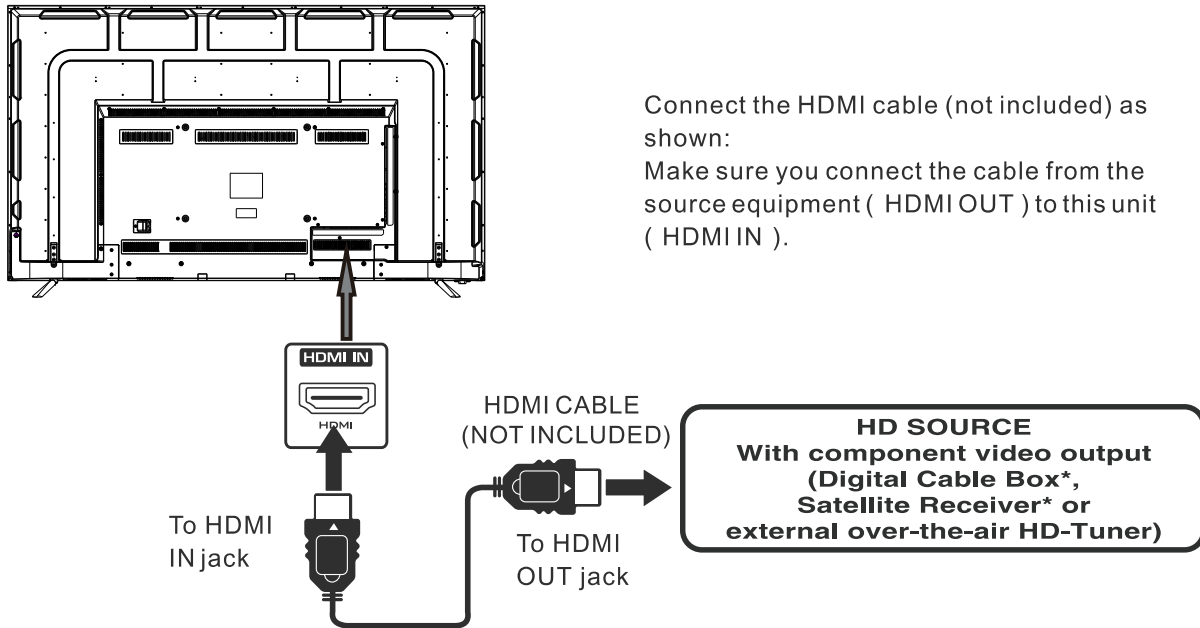

Connect the HDMI cable (not included) as shown:

Make sure you connect the cable from the source equipment ( HDMI OUT ) to this unit ( HDMI IN ).

## CONNECTING THE POWER CORD

You can power on your TV unit before you make sure the power cord is inserted well.

At the same time, please check that the rated voltage of your unit matches your local Voltage.

### NOTE

- Insert the power plug fully into the socket outlet. (If the power plug is loose, it could generate heat and cause fire .)
- Ensure that the power plug is easily accessible.
- Ensure the earth pin on the power plug is securely connected to prevent electrical shock.
- Do not touch the power plug with a wet hand. (This may cause electrical shock.)
- Do not use any power cord other than that provided with this TV. (This may cause fire or electrical shock.)
- Do not damage the power cord. (A damaged cord may cause fire or electrical shock.)
- Do not move the TV with the cord plugged in the socket outlet.
- Do not place a heavy object on the cord or place the cord near a high-temperature object.
- Do not twist the cord, bend it excessively, or stretch it.
- Do not pull on the cord. Hold onto the power plug body when disconnecting cord.
- Do not use a damaged power plug or socket outlet.

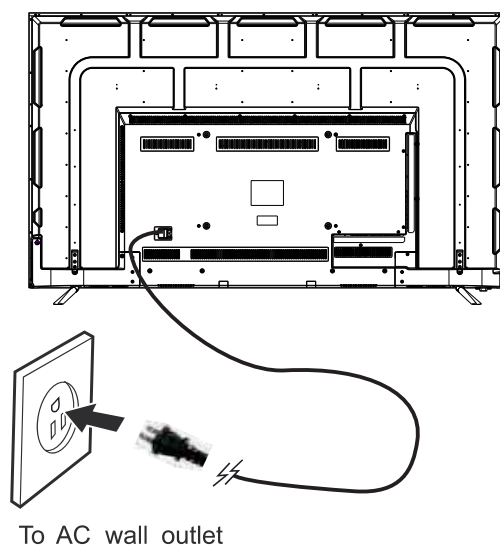

# CONNECTIONS

## Connection to a Home Theater Audio System

### For BEST audio performance

Connecting to a Home Theater System  
Dolby Digital can deliver optimal 2 channel stereo or surround sound with five discrete full range channels plus a sixth channel for a subwoofer.

Enjoy optimal sound reproduction from your system with a Dolby Digital amplifier that incorporates a digital optical input. Connect an optional digital cable directly to the television's optical audio output to listen through all inputs except VGA.  
(The VGA does not support digital audio)

### How To Setup SPDIF Mode

Press the MENU button on the remote control  
Press the arrow button to select SPDIF Mode in sound menu.  
Press OK button enter the Sub-menu.  
Press down ▼ arrow button to select PCM, Auto, Transcode DD or Transcode DDP.  
Please set the SPDIF Mode to PCM when using the digital amplifier normally.

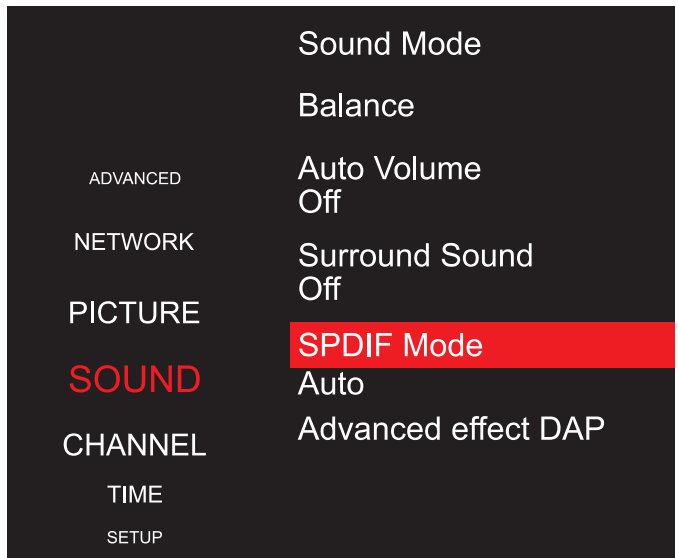
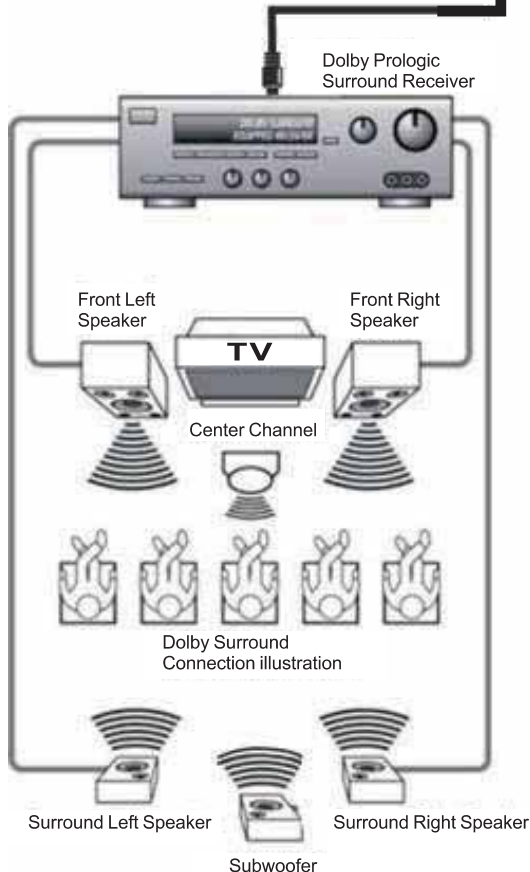
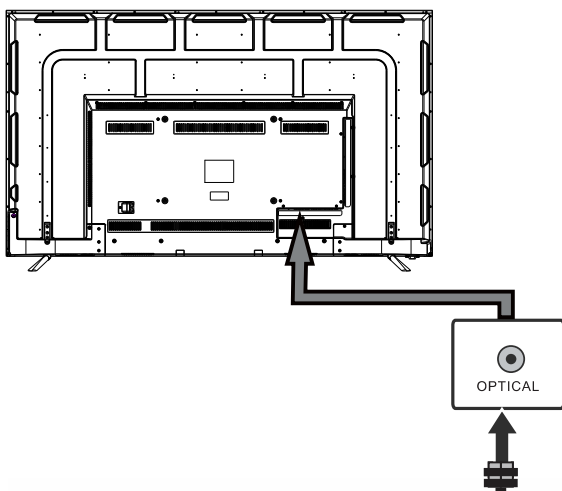

Optional digital cable  
(not included)

\*NOTE: Refer to the User Manual from your home theater equipment for recommended audio settings.

# INITIAL SETUP

## PUTTING THE UNIT ON A PROPER PLACE

When you turn on your television set for the first time, be sure to place it on a solid stable surface.

To avoid danger, do not expose the TV to water, or a heat source (e.g. lamp, candle, radiator).

Do not obstruct the ventilation grid at the rear and be sure to leave sufficient gaps around the unit.



## TURNING THE UNIT ON FOR THE FIRST TIME

After you have initially connected your TV antenna or cable, turn the television ON. A screen will display asking you to select a Language, Environment, Country, Time Setting, Network Connection, Antenna Type and Auto Tuning.

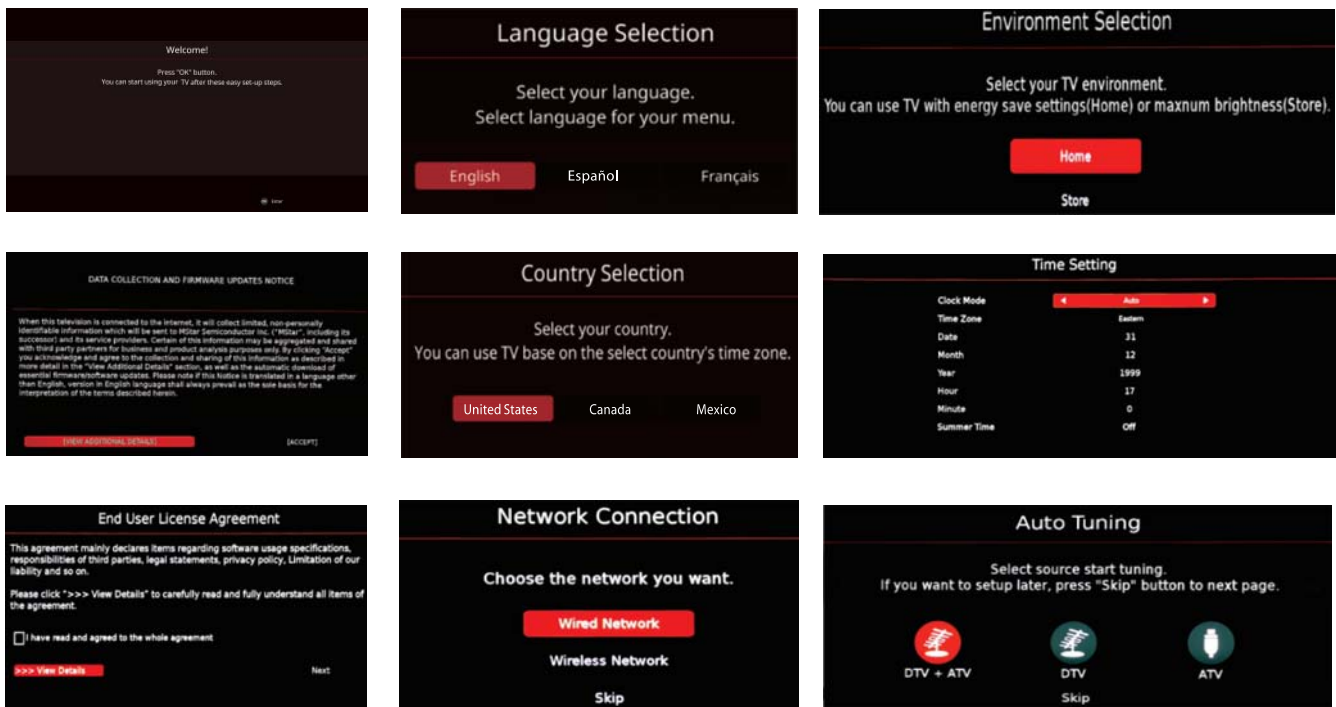

## SOURCE SELECTION

1. Press the **SOURCE** button on the remote control.
2. Use the **▲** or **▼** button to select the options (TV,AV,HDMI1,HDMI2,HDMI3) and select any of them using the **OK** button. (The screen will change to your desired source).



Note:

Before watching please make sure all necessary cables and devices are connected.



## Picture Menu

Press **MENU** button to display the main menu.

Press **▲/▼** button to select **PICTURE** in the main menu, it will highlight the option.

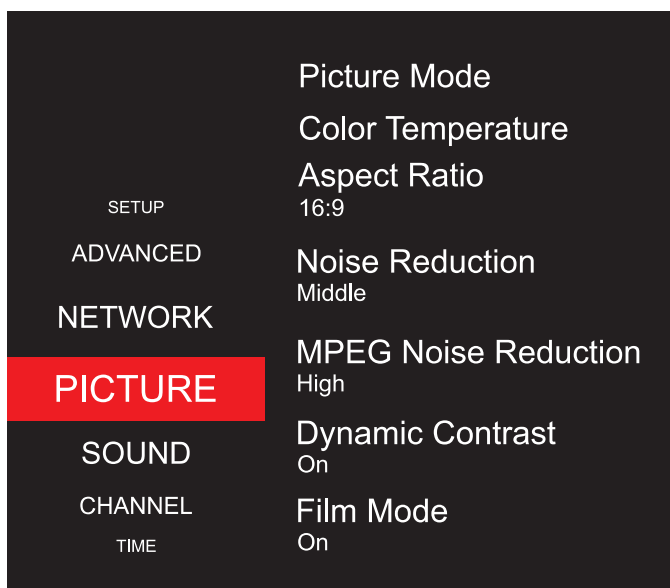

**Picture Mode:** Choose among Standard, Movie, User and Dynamic/Soccer depending on the region. It will be set to "User" mode automatically when you adjust any of the following six items.

This product is on standard picture mode in default, this is a power saving mode and the picture will be a little dark. Please change the picture mode to the desired mode from this setup menu.

Contrast: Adjust the difference between light and dark areas of the picture.

Brightness: Adjust the lightness of the picture.

Color: Adjust the richness of the picture.

Sharpness: Adjust the edge of the picture.

Tint: (Only for some sources) Adjust the tint value of the color.

Backlight: Adjust the backlight value of the TV screen.

**Color Temperature:** Select the overall color tone of the picture. Choices are Cool, Nature, Warm and User.

**Aspect Ratio:** Select the aspect ratio (display proportions) according to your video signal type or preference. Choices are Auto, 4:3, 16:9, Movie or Panorama.

**Noise Reduction:** Eliminate noise in the picture. Choices are Off, Low, Middle and High.

**MPEG Noise Reduction:** Eliminate noise generated while creating digital picture signals.

**Dynamic Contrast:** Turn on or turn off the function of dynamic contrast.

**Film Mode:** Turn on or turn off the function of film mode.

## Sound Menu

Press **MENU** button to display the main menu.

Press **▲/▼** button to select **SOUND** in the main menu, it will highlight the option.

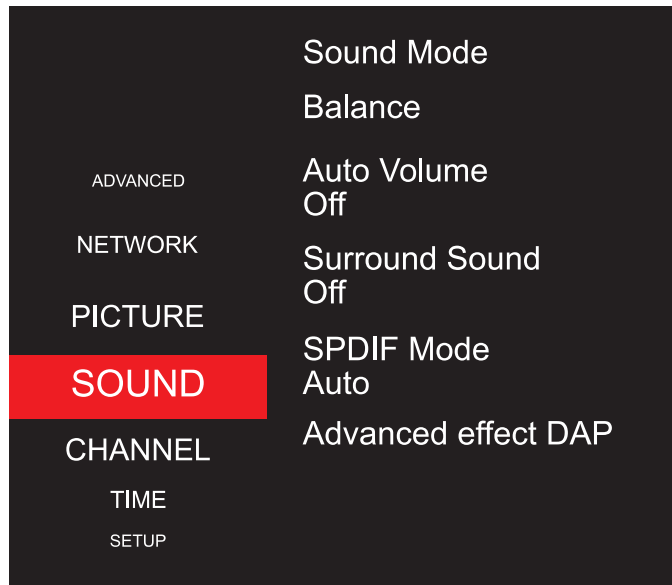

**Sound Mode:** Choose among Standard, Music, Movie, Soccer and User depending on the region, User. It will be set to "User" mode automatically when you adjust the value of 120Hz, 500Hz, 1.5KHz, 5KHz or 10KHz.

**Balance:** Control the sound balance between the right and left speaker.

**Auto Volume:** Turn on to adjust the sound volume depending on the input signal.

**Surround Sound:** Help to create rich and wider sound from stereo sound sources.

**SPDIF Mode:** Set the SPDIF sound output mode.

**Advanced Effect DAP:** Setup the advanced effect of Dolby Audio Processor(Only for some regions).