



INSTRUCTION MANUAL

Before using the TV, please read this manual thoroughly, and retain it for future reference.



Model: RNSMU5836



"This product is manufactured and sold by Curtis International Ltd.

RCA, the RCA logo, the two dogs (Nipper and Chipper) logo, are registered trademarks or trademarks of RCA Trademark Management and are used under license by Curtis International Ltd.

Any other product, service, company, trade or product name and logo referenced herein are neither endorsed nor sponsored by RCA Trademark Management or its affiliates."

CONTENTS

1	SAFETY PRECAUTION		1
2	IMPORTANT SAFETY INSTRUCTIONS		2
3	ACCESSORIES		3
4	GETTING STARTED		3
5	CONTROL REFERENCE GUIDE	Remote Control	4
		Front View	5
		Side View	5
		Back View	6
6	WALL MOUNT INSTALLATION		7
7	CONNECTIONS	Installation	8
		Antenna Connection	9
		AV Connection	9
		YPbPr Connection	10
		HDMI Connection	10
		Power Cord Connection	11
		Optical audio output Connection	12
8	INITIAL SETUP	Putting The Unit On A Proper Place	13
		Turning The Unit On For The First Time	13
		Source Selection	13
9	TV SETUP	Picture Menu	14
		Sound Menu	15
		Function Menu	16
		Time Menu	17
		Option Menu	18
		Lock Menu	20
		Channel Menu	21

CONTENTS

10	USB MEDIA PLAYER	22
11	SMART TV OPERATION	24
12	DISPLAY MODE	Video Formats 26
13	SPECIFICATION	27
14	TROUBLE- SHOOTING GUIDE	TV Symptom 28
15	WARRANTY CARD	29

** The pictures, functions and other information provided in the manual are for reference only. If it does not match the actual object, please refer to the actual product.*

SAFETY PRECAUTION

- * CAUTION MARKING WAS LOCATED AT THE REAR OF THE APPARATUS. **PLACEMENT INFORMATION**



WARNING: TO REDUCE THE RISK OF ELECTRIC SHOCK, DO NOT REMOVE COVER (OR BACK) NO USER SERVICEABLE PARTS INSIDE. REFER SERVICING TO QUALIFIED SERVICE PERSONNEL.

 The lightning flash with arrowhead symbol, within an equilateral triangle, is intended to alert the user to the presence of uninsulated "dangerous voltage" within the product's enclosure that may be of sufficient magnitude to constitute a risk of electric shock to persons.

 The exclamation point within an equilateral triangle is intended to alert the user to the presence of important operating and maintenance (servicing) instructions in the literature accompanying the appliance.

 **CAUTION**

- DANGER OF EXPLOSION IF BATTERY IS INCORRECTLY REPLACED. REPLACE ONLY WITH THE SAME OR EQUIVALENT TYPE.
- USE OF CONTROLS OR ADJUSTMENTS OR PERFORMANCE OF PROCEDURES OTHER THAN THOSE SPECIFIED MAY RESULT IN HAZARDOUS RADIATION EXPOSURE.

 **WARNING:**

- TO REDUCE THE RISK OF FIRE OR ELECTRIC SHOCK, DO NOT EXPOSE THIS APPLIANCE TO RAIN OR MOISTURE. TO AVOID FIRE OR SHOCK HAZARD, DO NOT EXPOSE THIS UNIT TO RAIN OR MOISTURE. DO NOT PLACE OBJECTS FILLED WITH LIQUIDS ON OR NEAR THIS UNIT.
- SHOULD ANY TROUBLE OCCUR, DISCONNECT THE AC POWER CORD AND REFER SERVICING TO A QUALIFIED TECHNICIAN.

 This equipment is a Class II or double insulated electrical appliance. It has been designed in such a way that it does not require a safety connection to electrical earth.

- Do not use this unit in places that are extremely hot, cold, dusty or humid.
- Do not restrict the airflow of this unit by placing it somewhere with poor airflow, by covering it with a cloth, by placing it on bedding or carpeting.

SAFETY INFORMATION

- When connecting or disconnecting the AC power cord, grip the plug and not the cord itself. Pulling the cord may damage it and create a hazard.
- When you are not going to use the unit for a long period of time, disconnect the AC power cord.

RATING PLATE LOCATION

The rating plate is located on the rear of the unit.

FCC STATEMENTS

NOTE: This unit has been tested and found to comply with the limits for a Class B digital device, pursuant to Part 15 of the FCC Rules. These limits are designed to provide reasonable protection against harmful interference in a residential installation.

This unit generates, uses and can radiate radio frequency energy and, if not installed and used in accordance with the instructions, may cause harmful interference to radio communication. However, there is no guarantee that interference will not occur in a particular installation. If this unit does cause harmful interference to radio or television reception, which can be determined by turning the unit off and on, the user is encouraged to try to correct the interference by one or more of the following measures:

- Reorient or relocate the receiving antenna.
- Increase the separation between the unit and receiver.
- Connect the unit into an outlet on a circuit different from that to which the receiver is connected.
- Consult the dealer or an experienced radio/TV technician for help.

 **WARNING:**

Changes or modifications to this unit not expressly approved by the party responsible for compliance could void the user authority to operate the unit.

HDMI[®]
HIGH-DEFINITION MULTIMEDIA INTERFACE

"HDMI, the HDMI logo and High-Definition Multimedia Interface are trademarks or registered trademarks of HDMI Licensing LLC."

IMPORTANT SAFETY INSTRUCTIONS

- 1) Read these instructions.
- 2) Keep these instructions.
- 3) Heed all warnings.
- 4) Follow all instructions.
- 5) Do not use this apparatus near water.
- 6) Clean only with a dry cloth.
- 7) Do not block any ventilation openings.
Install in accordance with the manufacturer's instructions.
- 8) Do not install near any heat sources such as radiators, heat registers, stoves, or other apparatus (including amplifiers) that produce heat.
- 9) Do not defeat the safety purpose of the polarized or grounding-type plug.
A polarized plug has two blades with one wider than the other.
A grounding-type plug has two blades and a third grounding prong.
The wide blade or the third prong is provided for your safety.
If the provided plug does not fit into your wall outlet, consult an electrician for replacement of the obsolete outlet.
- 10) Protect the power cord from being walked on or pinched particularly at plugs, convenience receptacles, and the point where they exit from the apparatus.
- 11) Only use attachments / accessories specified by the manufacturer.
- 12) Use only with the cart, stand, tripod, bracket, or table specified by the manufacturer, or sold with the apparatus.
When a cart is used, use caution when moving the cart / apparatus combination to avoid injury from tip-over.
- 13) Unplug this apparatus during lightning storms or when unused for long periods of time.
- 14) Refer all servicing to qualified service personnel. Servicing is required when the apparatus has been damaged in any way, such as the power cord or plug is damaged, liquid has been spilled or objects have fallen into the apparatus, the apparatus has been exposed to rain or moisture, does not operate normally, or has been dropped.
- 15) The mains plug is used as disconnect device, the disconnect device shall remain readily operable.



PERSONAL SAFETY NOTICE

- ALWAYS read and follow all instructions for the installation and use of the TV.
- Place the TV in a location that is level and sturdy.
- DO NOT place the TV on a furniture with drawers that can be used as steps by small children.
- DO NOT allow children to pull the TV or climb on the furniture where the TV is placed.
- DO NOT allow children to play in front of or around the TV.
- ALWAYS route all the cables connecting to the TV so the cables cannot be easily pulled and grabbed by children.
- When installing the TV on a wall, please purchase a TV mount recommended by a professional TV installer, and follow the installation instructions that come with the TV mount.
- Before installing the TV on a wall, please check to make sure the wall structure can support the weight of the TV and the mount. If in doubt, please ask the advice from a professional TV installer.

ACCESSORIES

Please check and identify the supplied accessories.

Remote control	x 1
Battery(AAA)	x 2
Instruction Manual	x 1
Mini AV in Cable.....	x 1
Mini YPbPr in Cable	x 1
Base stand	x 2
Base stand screws	x 4
Troubleshooting instructions card.....	x 1

GETTING STARTED

USING THE REMOTE CONTROL

- Point the remote control at the remote sensor located on the unit.
- When there is a strong ambient light source, the performance of the infrared remote sensor may be degraded, causing unreliable operation.
- The recommended effective distance for remote operation is about 16 feet (5 meters).

TO INSTALL THE BATTERIES

1. Open the battery door.

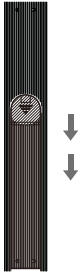

2. Insert 2"AAA"batteries.

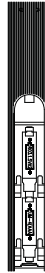

BATTERY REPLACEMENT

When the batteries become weak, the operating distance of the remote control is greatly reduced and you will need to replace the batteries.

CAUTION : Danger of explosion if battery is incorrectly replaced.

NOTES

- If the remote control is not going to be used for a long time, remove the batteries to avoid damage caused by battery leakage corrosion.
- Do not mix old and new batteries. Do not mix ALKALINE, standard (CARBON-ZINC) or rechargeable (NICKEL-CADMIUM) batteries.
- Always remove batteries as soon as they become weak.
- Weak batteries can leak and severely damage the remote control.

WARNING :
Do not dispose batteries in a fire. Batteries may explode or leak.
Batteries shall not be exposed to excessive heat such as sunshine, fire or the like.

REMOTE CONTROL

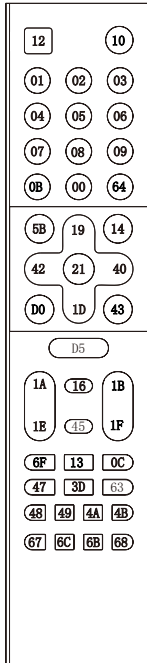

Format : NEC
Remote Code: 20DF

Code location Chart

- POWER(⏻): Turns the TV on or off.
- MUTE(🔇): Mute or restore the sound
- Number buttons: Choose the channel directly
- Decimal Point: Input the decimal point.
- Return(Back): Return to the previously-viewed channel.
- MENU: Access the main menu
- SOURCE: Select the input source mode.
- Navigation buttons: (Up/Down/Left/Right ◀/▶/▲/▼)
- Navigate the menu.
- OK: Confirm the selection.
- HOME(🏠): Enter the home page.
- EXIT: Exit the current screen.
- NETFLIX: Access the Netflix interface.
- VOL+/VOL- : Increases or decreases the TV volume.
- CH^/CHv : Change to the previous or next program.

- INFO: Show the detailed information.
- EPG: This control button does not apply to this product.
- REC(📽): This control button does not apply to this product.
- MTS: Select desired sound output depending on the broadcasting channel.
- CC: Setup the mode of closed caption.
- SUBTITLE: Access the subtitle.
- CH LIST: Access the channel list.
- FAV: View your assigned favorite channels.
- QUICK: Access the quick menu.
- Color Buttons(REDF/GREEN/YELLOW/BLUE): Execute the prompt function in specific mode.
- PLAY/PAUSE (▶/⏸): Pause or continue the playback.
- STOP (■): Stop playback.
- FAST BACKWARD/FAST FORWARD (◀◀/▶▶): Fast review of fast forward.

IMPORTANT NOTICE:

Depending on the country where the TV is installed, certain apps may not be available. The quick launch button on the remote control associated with those apps will therefore not work. All other functionalities of the remote will work as designed.

CONTROL REFERENCE GUIDE

FRONT VIEW

About remote control working distance and angle, see next page.

Power/Standby Indicator: Blue and red dual-color LED. It shows red when the TV is turned off and blue when turned on. Remote Control Sensor: Remote control IR sensor, which receives infrared ray sent by remote control.

NOTE: If there is a protective film around the screen, remove the protective film before using the TV.

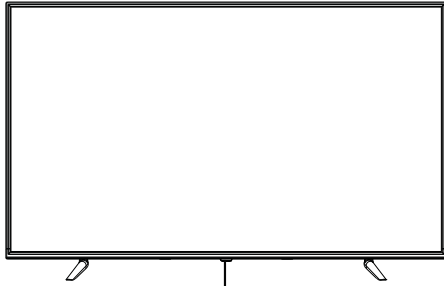

Power/Standby Indicator
Remote Control Sensor

BOTTOM VIEW

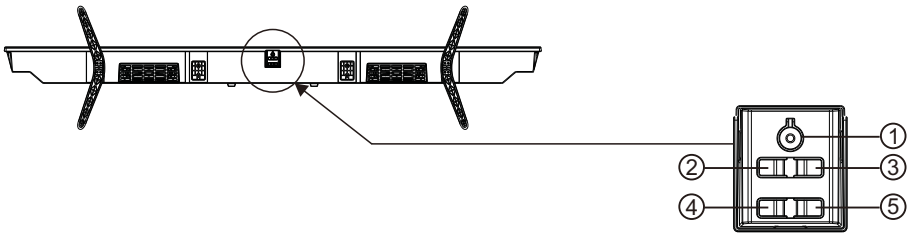

1. **⏻/INPUT:** When TV power off, long press this button to turn on. When TV is on, long press this button to turn off, short press this button to call out the input source menu, press the VOL+/- button to select the input source and press the power on/off button again to confirm the selection.
2. **VOL-:** Decreases the volume. In the TV menu system, it acts like the left arrow on the remote control and can be used to select menu options.
3. **VOL+:** Increases the volume. In the TV menu system, it acts like the right arrow on the remote control and can be used to select menu options.
4. **CH-:** Scans down through the channel list. In the TV menu system, it acts like the down arrow on the remote control and can be used to select menu options.
5. **CH+:** Scans up through the channel list. In the TV menu system, it acts like the up arrow on the remote control and can be used to select menu options.

BACK VIEW

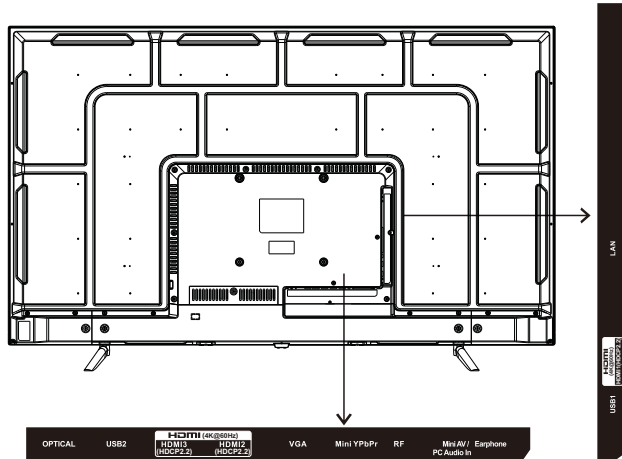

OPTICAL: Digital TV sound output.

USB: Connect the USB device such as the flash disk to access the TV media function.

HDMI: (High-Definition Multimedia Interface) Provides an uncompressed digital connection.

VGA: Connect the PC to these jacks.

MINI YPbPr: Connect the YPbPr output jack of the DVD or VCR.

RF: Connect to receive the signal from your antenna or cable through a coaxial cable.

MINI AV: Connect an AV device that has composite video jacks, such as a VCR or DVD Player.

Note: PC AUDIO IN and mini AV share one port, PC audio and YPbPr audio should connect from this port.

EARPHONE: Connect a 3.5mm headset for personal audio.

LAN: Connect the Internet.

WALL MOUNT INSTALLATION

INSTALLING / REMOVING THE BASE STAND

WARNING : The LED Display is very fragile , and must be protected at all times when removing the base Stand .

Be sure that no hard or sharp object or anything that could scratch or damage the LED display comes into contact with it Do NOT exert pressure on the front of the unit at any time because the screen could crack.

1. Disconnect all cables or cords connected to the unit.
2. Lay the unit down on a flat surface with the back side facing up Please make sure to place a soft cushioned material (such as a pillow or thick piece of foam) beneath the screen.
3. To remove the base stand, loosen screws off the holes then pull downwards to release the base stand

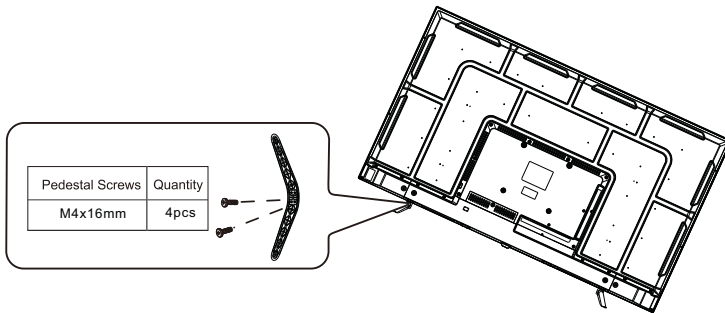

MOUNTING ON THE WALL

This unit is VESA-compliant, and is designed to be wall-mounted with a VESA-compliant 8" x 8" (200mm x 200mm) mounting kit designed for flat-panel TVs (not supplied). Length of screw should not exceed 10mm

NOTE

Remove the base stand before mounting the unit on the wall.

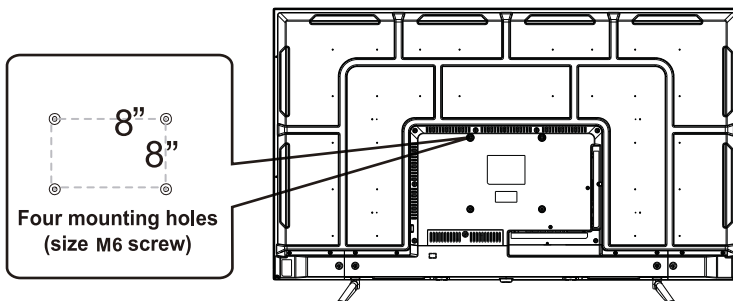

Installation

Your TV is packaged with the stand and the cabinet separated. Before using the TV, install the stand as described below, or if you want to mount it to a wall, see page 7 for mounting advice; the wall mount itself is not supplied.

IMPORTANT!

- Make sure the TV set is unplugged from the power supply before installing or removing the stand.
- The TV panel may be awkward to install on your own. We recommend you ask someone to help with installation and/or removal of the stand.

Attaching the stand

Step 1

Place a soft cushioned material on top of a flat surface to prevent damaging the screen panel. Then place the TV monitor flat on top, with the screen side facing down, as illustrated on the right (1).

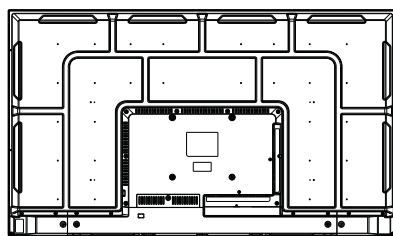

①

Step 2

Align the screw holes on the stand and the bottom of the TV, as illustrated on the right (2).

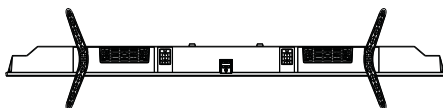

②

Step 3

Tighten the screws (supplied) with a screwdriver to affix the stand to the panel, as illustrated on the right (3).

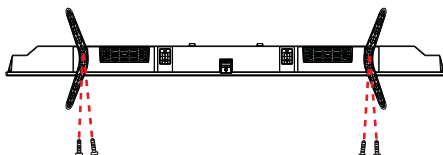

③

NOTE: Do not apply excessive force as this may damage the screw holes.

CONNECTIONS

CONNECTING A TV ANTENNA / CABLE / SATELLITE

To view television channels correctly, a signal must be received from one of the following sources:

- An indoor or outdoor aerial antenna
- A cable system
- A satellite system

NOTE

For receiving over-the-air TV broadcasts, we recommend that you use an external fixed antenna. Should you require the use of a temporary antenna, please ensure that you purchase an antenna with sufficient ability to receive in weak signal areas. Only when you are in close proximity to a transmitter will a temporary antenna reproduce a signal as strongly as a fixed antenna.

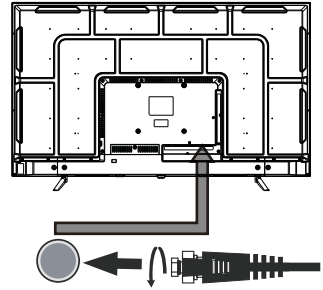

Satellite, cable or TV antenna cable to TV ANTENNA terminal (cable not included)

CONNECTING AN A/V DEVICE

To connect to other equipment such as a VCR, camcorder, satellite system or cable, etc.

CONNECTING DEVICES WITH A COMPOSITE VIDEO OUTPUT

To connect AV devices such as a VCR, video game system or camcorder.

Connecting to a VCR / Video Game System / Camcorder

Connect the AUDIO / VIDEO cable (not included) as shown.

Make sure you connect the cable from the other equipment (**AUDIO** and **VIDEO OUT**) to this unit (Mini AV)

NOTE

1. Please refer to the user manual for the other equipment for more information.
2. Composite video input (shared with component)

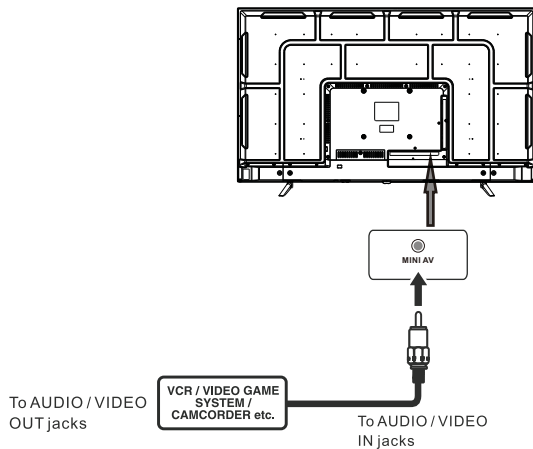

CONNECTIONS

CONNECTING A HIGH-DEFINITION (HD) SOURCE USING COMPONENT CONNECTION

High-Definition (HD) Devices with component video output must be connected to the YPbPr input. Connect the component video cable and audio cable (not included) as shown. Make sure you connect the component video cable and audio cable from the other equipment (COMPONENT OUT and AUDIO OUT) to the unit COMPONENT IN.

NOTE

When connecting a DVD player to the television, the picture resolution is solely dependent upon the resolution supported by the DVD player attached. DVD player resolutions vary from 480i to 1080P and this television can support DVD players up to a maximum resolution of 1080P.

* May require a subscription for receiving HD channels, check with your cable/satellite service provider for details.

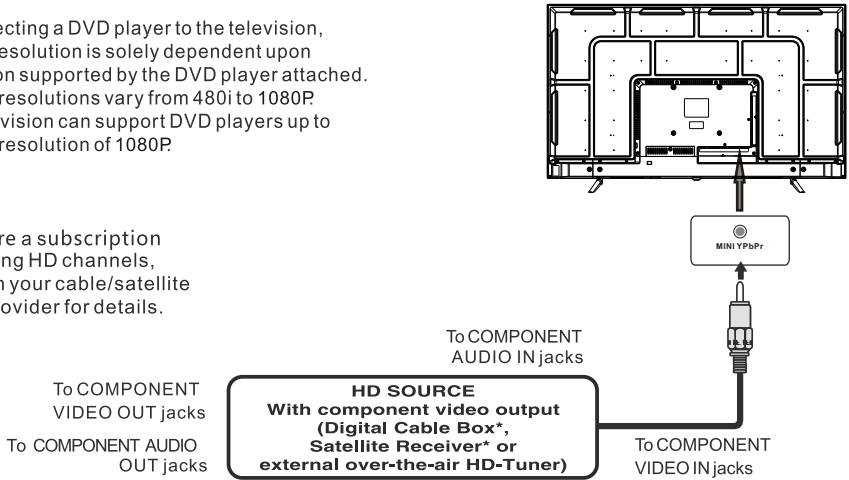

CONNECTING A HIGH-DEFINITION (HD) SOURCE USING HDMI CONNECTION

HDMI (High Definition Multimedia Interface) supports both video and audio on a single digital connection for use with DVD players, DTV, set-top boxes and other digital AV devices. HDMI was developed to provide the technologies of High Bandwidth Digital Content Protection (HDCP) as well as Digital Visual Interface (DVI) in one specification. HDCP is used to protect digital content transmitted and received by DVI-compliant or HDMI-compliant displays.

HDMI has the capability to support standard, enhanced or high-definition video plus standard to multi-channel surround-sound audio. HDMI features include uncompressed digital video, a bandwidth of up to 2.2 gigabytes per second (with HDTV signals), one connector (instead of several cables and connectors), and communication between the AV source and AV devices such as DTVs.

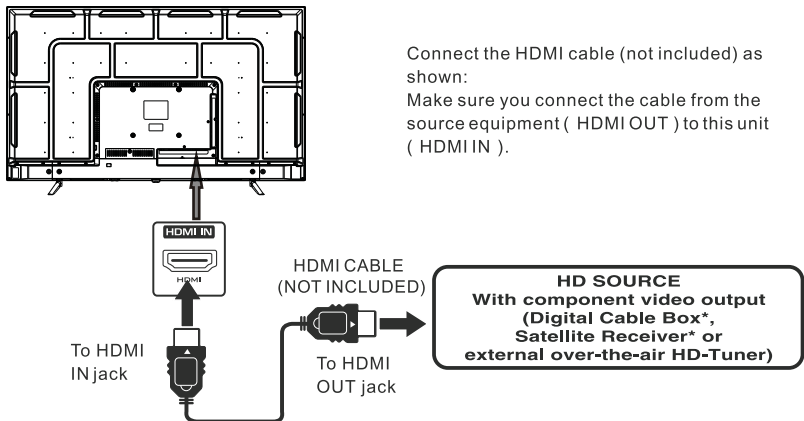

Connect the HDMI cable (not included) as shown: Make sure you connect the cable from the source equipment (HDMI OUT) to this unit (HDMI IN).

CONNECTIONS

CONNECTING A PC

Connect the 15-pin D-SUB PC/VGA connector from your computer to the 15-pin D-SUB PC/VGA input on this unit using a monitor cable and an audio cable (not included) as shown.

Make sure you connect the cable from the computer (VGA and AUDIO - PC OUT) to this unit (VGA and AUDIO - PC IN).

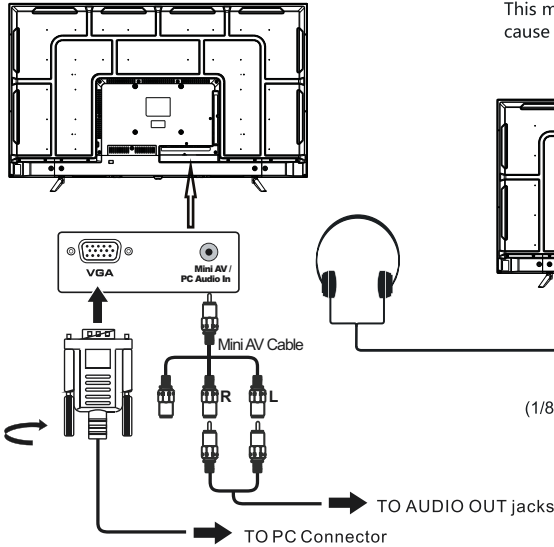

CONNECTING HEADPHONES

- Turn down the volume before connecting headphones to the unit, then adjust the volume to your desired level.
- When headphones are connected, no sound will come from the front speakers.

NOTE

Avoiding listening to sound at high Levels for prolonged period of time. This may be harmful to you and may cause hearing loss.

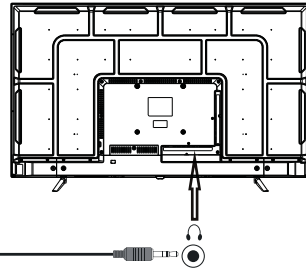

EARPHONE
(1/8" [3.5mm] diameter plug)
NOT INCLUDED

CONNECTING THE POWER CORD

You can power on your TV unit before you make sure the power cord is inserted well. At the same time, please check that the rated voltage of your unit matches your local Voltage.

NOTE

- Insert the power plug fully into the socket outlet. (If the power plug is loose it could generate heat and cause fire .)
- Ensure that the power plug is easily accessible.
- Ensure the earth pin on the power plug is securely connected to prevent electrical shock.
- Do not touch the power plug with a wet hand. (This may cause electrical shock)
- Do not use any power cord other than that provided with this TV. (This may cause fire or electrical shock.)
- Do not damage the power cord. (A damaged cord may cause fire or electrical shock.)
- Do not move the TV with the cord plugged in the socket outlet.
- Do not place a heavy object on the cord or place the cord near a high-temperature object.
- Do not twist the cord, bend it excessively, or stretch it.
- Do not pull on the cord. Hold onto the power plug body when disconnecting cord.
- Do not use a damaged power plug or socket outlet.

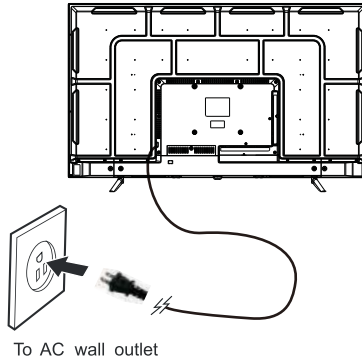

Connection to a Home Theater Audio System

For BEST audio performance

Connecting to a Home Theater System
Dolby Digital can deliver optimal 2 channel stereo or surround sound with five discrete full range channels plus a sixth channel for a subwoofer.

Enjoy optimal sound reproduction from your system with a Dolby Digital amplifier that incorporates a digital optical input. Connect an optional digital cable directly to the television's optical audio output to listen through all inputs except VGA.
(The VGA does not support digital audio)

How To Setup Digital Audio Output
Press the MENU button on the remote control
Press the right ► arrow button to select sound
Press the down ▼ arrow button to highlight Digital Audio Output ► Audio, PCM.

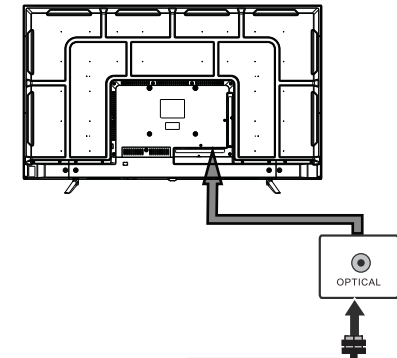
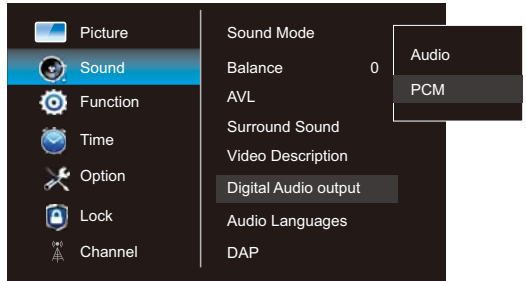

Optional digital cable
(not included)

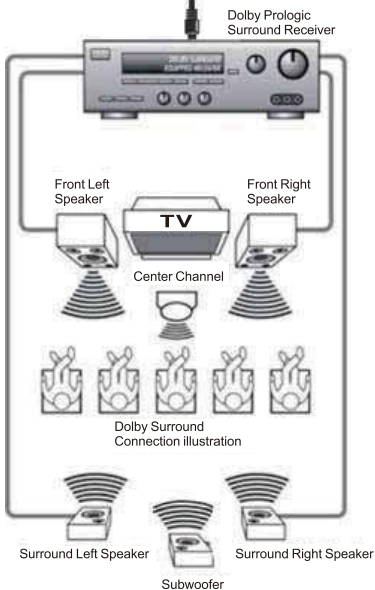

*NOTE: Refer to the User Manual from your home theater equipment for recommended audio settings.

INITIAL SETUP

PUTTING THE UNIT ON A PROPER PLACE

When you turn on your television set for the first time, be sure to place it on a solid stable surface.

To avoid danger, do not expose the TV to water, or a heat source (e.g. lamp, candle, radiator).

Do not obstruct the ventilation grid at the rear and be sure to leave sufficient gaps around the unit.



TURNING THE UNIT ON FOR THE FIRST TIME

After you have initially connected your TV antenna or cable, turn the television ON. A screen will display asking you to select a Language, Country and Internet.

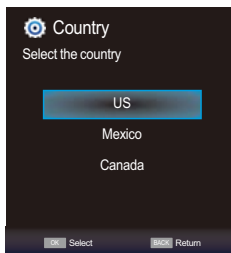

Select option of Auto Tuning under the up and down keys. Then press OK button on suitable location and the auto tuning will begin.

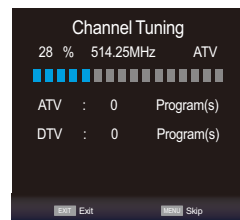
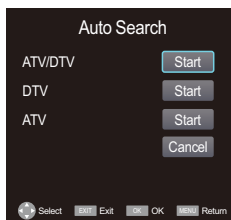
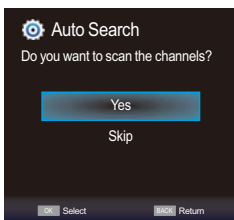

SOURCE SELECTION

1. Press the **SOURCE** button on the remote control.
2. Use the **▲** or **▼** button to select the options (TV,AV,Component,HDMI,USB) and select any of them using the **OK** button. (The screen will change to your desired source).

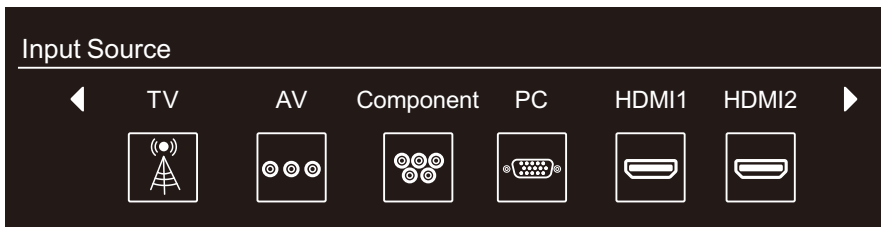

Note:

Before watching please make sure all necessary cables and devices are connected.

Picture Menu

Press **MENU** button to display the main menu.

Press ◀ / ▶ button to select **PICTURE** in the main menu, it will highlight the first option.

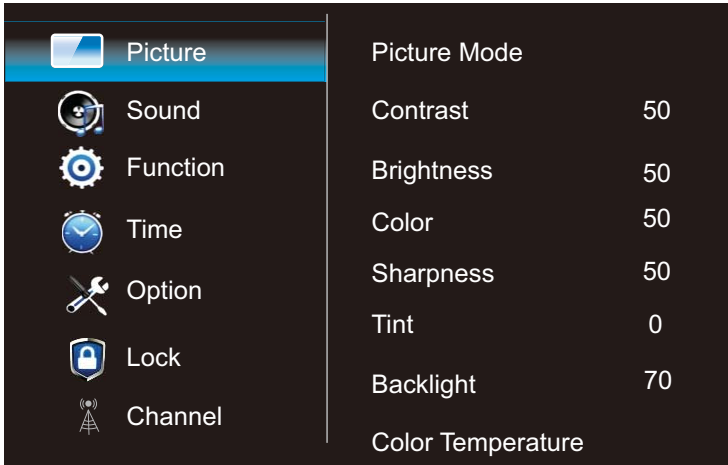

Picture Mode: Choose among Sports, Normal, Mild, Save and User. The following five items (Contrast, Brightness, Color, Sharpness and Tint) can be adjust only when the picture mode is set to "User" mode.

Contrast: Adjust the difference between light and dark areas of the picture.

Brightness: Adjust the lightness of the picture.

Color: Adjust the richness of the picture.

Sharpness: Adjust the edge of the picture.

Tint: (Only for some sources) Adjust the tint value of the color.

Backlight: Adjust the backlight value of the TV screen.

Color Temperature: Select the overall color tone of the picture. Choices are Cool, Standard and Warm.

TV SETUP

Sound Menu

Press **MENU** button to display the main menu.

Press ◀ / ▶ button to select **SOUND** in the main menu, it will highlight the first option.

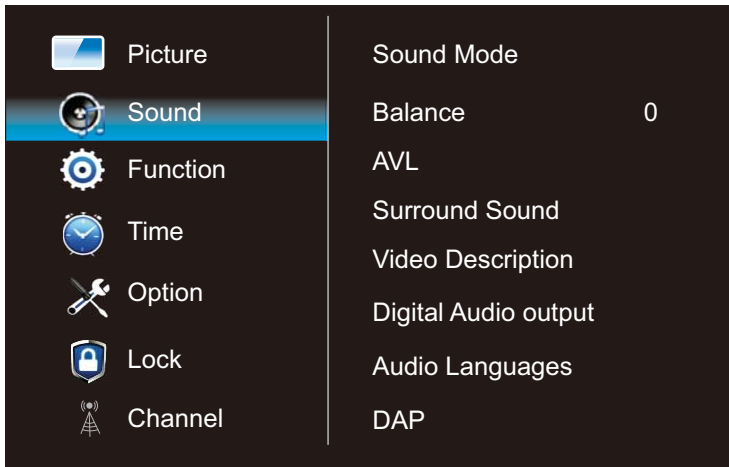

Sound Mode: Choose among Standard, Music, Movie, Sports and User. The value of 120Hz, 500Hz, 1.5KHz, 5KHz or 10KHz can be adjusted only when the sound mode is set to "User" mode.

Balance: Control the sound balance between the right and left speaker.

AVL: Turn on to adjust the sound volume depending on the input signal.

Surround Sound: Help to create rich and wider sound from stereo sound sources.

Video Description: Turn on or turn off the video description function to help the blind or visually impaired viewers.

Digital Audio Output: Set the digital audio output mode to PCM or Auto.

Audio Languages: Set the primary or secondary digital audio language corresponding to the signal.

Function Menu

Press **MENU** button to display the main menu.

Press ◀ / ▶ button to select **FUNCTION** in the main menu, it will highlight the first option.

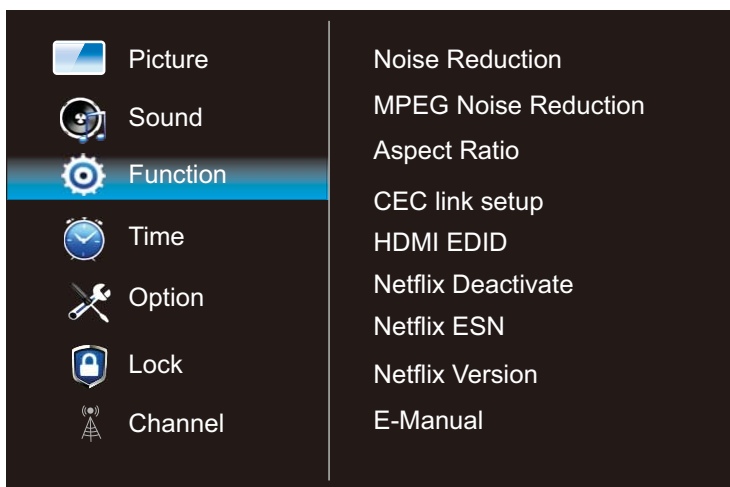

Noise Reduction: Eliminate noise in the picture. Choices are Off, Low, Middle, High and Auto.

MPEG Noise Reduction: Eliminate noise generated while converting or compressing MPEG signals. Choices are Off, Low, Middle and High. **Aspect Ratio:** Select the aspect ratio (display proportions) according to your video signal type or preference. Choices are 4:3, 16:9, Movie, Native and Panorama.

Note: The choices of aspect ratio differ by different regions or sources.

CEC Link Setup: Command and control HDMI devices connected to the TV set.

1. Enable Link: Turn on or turn off HDMI Link function.
2. Auto Power On: Turn on to power on the TV set automatically when you turn on the HDMI device.
3. Auto Standby: Turn on to change the HDMI device to standby mode automatically when you turn off the TV set.
4. Device Select: Select the HDMI device from the device list.

HDMI EDID: Switch the version of Extended Display Identification Data.

Netflix Deactive: Logout your your Netflix user account.

Netflix ESN: Check the Netflix ESN number.

Netflix Version: Check the Netflix SW version.

E-Manual: Electronic User Manual.

TTS: Setup the function of Text-to-Sound.

1. TTS: Turn on or turn off the TTS function. The following four items can be adjusted only when TTS is turned on.
2. Verbosity: Select the verbosity level.
3. Rate Support: Select the sound speed.

TV SETUP

Time Menu

Press **MENU** button to display the main menu.

Press ◀ / ▶ button to select **TIME** in the main menu, it will highlight the first option.

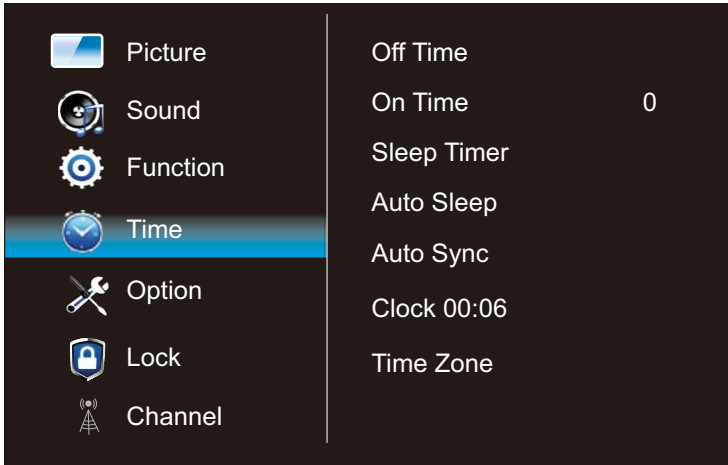

Off Time: Setup the repeat mode and timer to turn off the TV set.

On Time: Setup the repeat mode and timer to turn on the TV set.

Sleep Timer: Set to turn off the TV set automatically. Choices are off, 10, 20, 30, 60, 90, 120, 180 and 240 minutes.

Auto Sleep: Setup the timer to turn off the TV set automatically when there is no operation. Choices are Off, 4 hours, 6 hours and 8 hours.

Auto Sync: Turn on or turn off the function of Auto Sync.

Clock: Setup the TV clock (Day, Month, Year, Hour and Minute). It is available only when Auto Sync is turned off.

Time Zone: Select the time zone. It is available only when Auto Sync is turned on.

TV SETUP

Option Menu

Press **MENU** button to display the main menu.

Press ◀ / ▶ button to select **OPTION** in the main menu, it will highlight the first option.

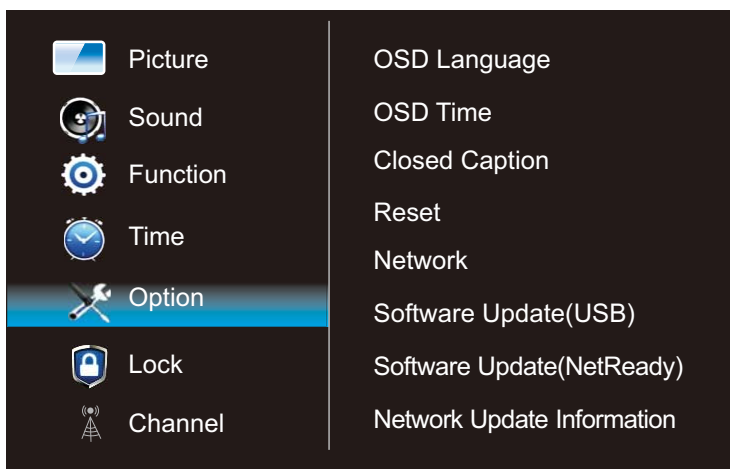

OSD Language: Select your desired OSD language.

OSD Time: Select the time to keep the OSD display on the screen.

Closed Caption: Setup the function of Closed Caption.

1. CC Mode - Select the CC mode. The following three items can't be adjusted when the CC Mode is turned off.
2. Basic Selection - Select the basic CC type.
3. Advanced Selection - Select the advanced CC service type.
4. Closed Caption Option - Adjust the detailed CC settings such as font, color and so on.

Reset: Restore Menu options to the factory defaults, and restart the initial setup.

Note: User data on this TV will lose completely after operating this feature.

Network:

1. Status: Check the detailed information of network connection such as IP, MAC Address and so on.
2. WIFI: Setup to connect the TV set to the Wireless Network.
3. LAN: Setup to connect the TV set to the Wired Network.

Software Update (USB): Select to update Software from USB.

Software update (NetReady): Select to update software by network connection.

Network Update Information: Show network update information such as software version and so on.

Option Menu

How to connect to WIFI?

Press **MENU** button to display the main menu.

Press ◀ / ▶ button to select **OPTION** in the main menu, choose the **Network**.

After pressing the **OK** button, select WIFI.

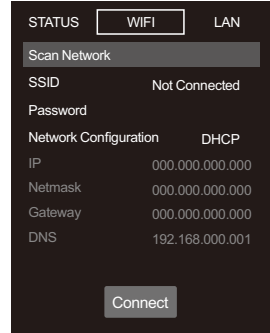

Select to WIFI setting and turn on the WIFI, select your WIFI network and enter the password, then select the Setting to connect the WIFI. If you want to connect a new WIFI network, please select to WIFI item and press the OK button from the remote, it will search some new WIFI network nearby the TV, select the WIFI network and enter the password to connect it.

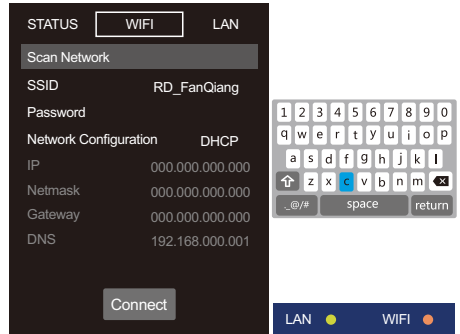
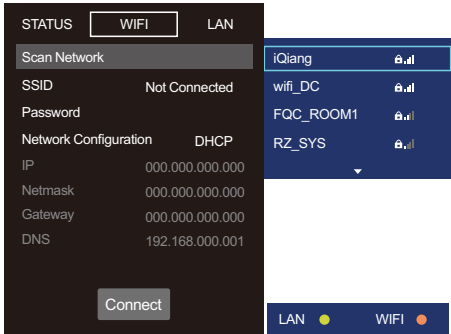

TV SETUP

Lock Menu

Press **MENU** button to display the main menu.

Press **◀ / ▶** button to select **LOCK** in the main menu, it will highlight the first option.

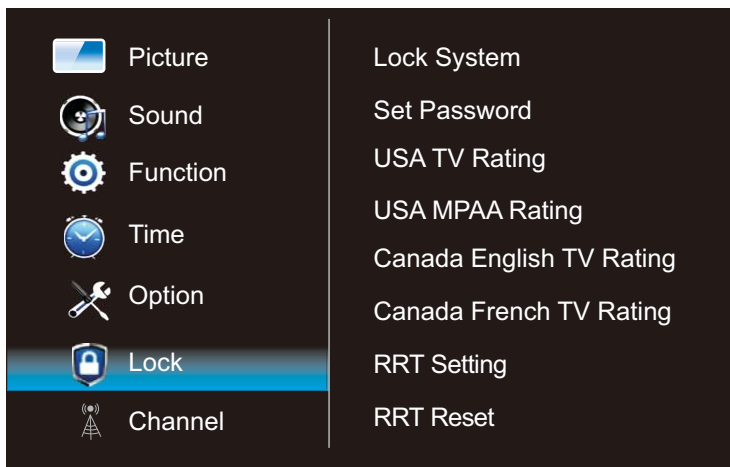

Input the initial password(**0000**) or your own password to access this feature, then press **OK** button to enter the following features.

Lock System: Select On to enable the following eight items.

Set Password: Use to change the current Lock password.

USA TV Rating: Block or unblock programs according to USA TV Rating.

USA MPAA Rating: Block or unblock programs according to USA MPAA Rating.

Canada English TV Rating: Block or unblock programs according to Canada English TV Rating.

Canada French TV Rating: Block or unblock programs according to Canada French TV Rating.

RRT Setting: Adjust the settings of RRT(Region Rating Table).

RRT Reset: Reset the RRT settings to the defaults.

Note: If you change the password and forget it, you can use the super password 8899 to enter the lock system.

TV SETUP

Channel Menu

Press **MENU** button to display the main menu.

Press ◀ / ▶ button to select **CHANNEL** in the main menu, it will highlight the first option.

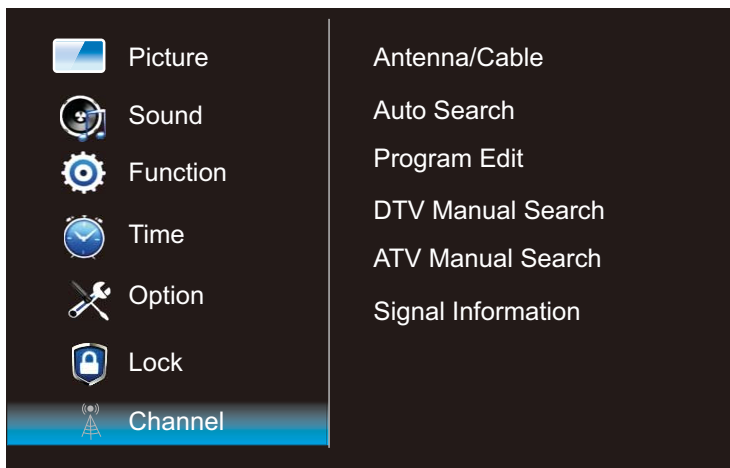

Antenna/Cable: Select the tuner mode between Antenna and Cable.

Auto Search: Search for programs automatically. If you want to stop the auto search, press EXIT button. Then Select "Yes" to exit searching and "No" to continue searching.

Program Edit: Edit the programs. You can press RED button to delete programs, press BLUE button to skip programs, and add programs to the favorite list by pressing Yellow button.

DTV Manual Search: Search for the DTV programs manually. The search stops when a program is found and this program will be stored automatically. Press EXIT button to exit the searching. Before DTV manual search, you need to Select the desired UHF CH.

ATV Manual Search: Search for the ATV programs manually. When a program is found, press RED button to save it. Press EXIT button to exit the searching. Before ATV manual search, you need to select the desired Current Channel. If the signal is weak or distorted, you can select "Fine Tune" to adjust the frequency slightly until the image is clear.

Signal Information: Show the signal information of current DTV channel.

USB Media Player

USB Media Menu

Before operating Media menu, Plug in USB device, then press INPUT button.

Press ▼/▲ button to select USB Media Player in the Source menu, then press Enter button to enter.

Press ◀/▶ button to select the option you want to adjust in the main Media menu, then press Enter button to enter.

Support format: JPEG, BMP and PNG for photo. MPG, MPEG, MP4, MKV, AVI and FLV for Movie.

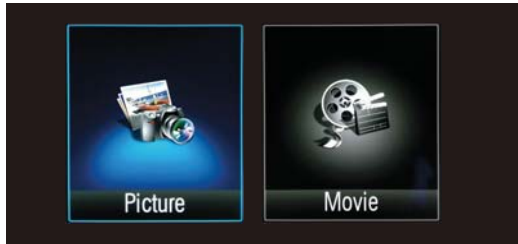

Photo Menu

Press ◀/▶ button to select PHOTO in the main menu, then press Enter button to enter.

Press ◀/▶ button to select drive disk you want to watch, then press Enter button to enter.

Press ◀/▶ button to select return option to back to the previous menu.



Press ◀/▶ button to select the file you want to watch in the file selecting menu, then press media button to display picture.



Press ◀/▶ button to select the file folder you want to search in the file selecting menu, then press Enter button on your remote control to enter sub-menu.

USB Media Player

Movie Menu

Press ◀/▶ button to select Movie in the main menu, then press Enter button to enter.
Press menu button to return back to the previous menu and exit menu to quit.
Press ◀/▶ button to select drive disk you want to watch, then press Enter button to enter.



Press ◀/▶ button to select the file you want to watch in the file selecting menu, then press Enter button to add the file to play list, press media button to display and operate file details.



NOTE: It can not play music and TEXT format.

Smart TV Operation

Press **HOME** button on the remote control to enter the Main Launcher.

Press the arrow buttons ◀/▶ to select the APP, then press "OK" button to enter.

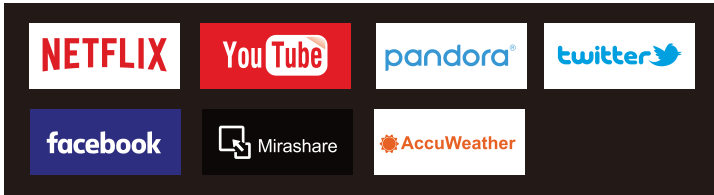

Note: Depending on the country where the TV is installed, certain apps may not be available.

NETFLIX YOU can press "NETFLIX" button or press **HOME** button select the NETFLIX to enter.

After enter the NETFLIX you can see below login interface, input your account and password, press "OK" button, then you can enjoy the NETFLIX resources.

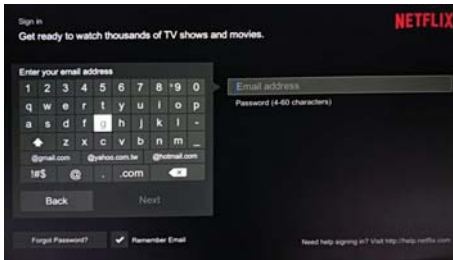

facebook Press the arrow buttons ◀/▶ to select the Facebook, then press "OK" button to enter.

After enter the FACEBOOK you can see below login interface with 8 random code, first pls visit <http://www.facebook.com/device> on your smart phone or computer and enter this code.

Second input your facebook account and password then login in.

Third enter the 8 random code which marked in the first picture. Then you can success to use facebook.

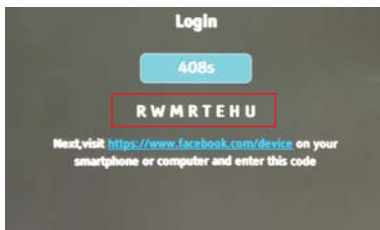

①

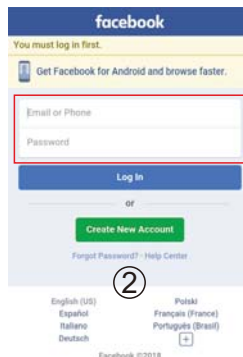

②

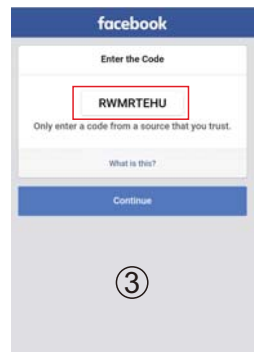

③

Smart TV Operation



1. Use arrow key to Select button, then press “ENTER” key to enter Youtube.
2. Use arrow button to select one video and press “ENTER” key to play. Press “Menu” key to exit playing.
3. Press ▼ key to open or close control menu when playing.
4. Press ▲ key to enter search interface, input the keyword and then press “ENTER” to search videos.

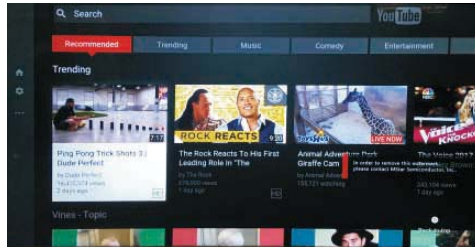

Use arrow key to Select button, then press “OK” key to enter pandora.



Press the arrow buttons ◀/▶ to select the Mirashart, then press “OK” button to enter.



Note: Please note that depending on the mobile device, Screenshot may not operate as indicated.



1. Use arrow key to Select button, then press “ENTER” key to enter Accuweather.
2. Input a city or zip code pr ess select to get the weather information.



DISPLAY MODE

VIDEO FORMATS

SUPPORTED COMPONENT / HDMI INPUT MODE			
Resolution	Horizontal Scanning Frequency (KHz)	Vertical Scanning Frequency (Hz)	Format
720 X 480	15.73	59.94	480 i
720 X 480	31.5	59.94	480 p
1280 X 720	45	60	720 p
1920 X 1080	33.75	60	1080 i
1920 X 1080	27	24	1080 p
1920 X 1080	67.50	60	1080 p
3840 X 2160	53.9	24	2160p
3840 X 2160	67.5	30	2160p
3840 X 2160	134.5	60	2160p

NOTE:

The above listed formats are also related to the AV devices you are about to connect. Before you connect this unit with others please read all instructions carefully and make sure all necessary cables are connected.

This unit may be incompatible with some other formats which are not meet the above conditions.

SPECIFICATION

Model Description		58"LED TV
Panel	Panel Type	LED Panel
	Diagonal Size	58inches
	Screen Format	16:9
	Resolution	3840 x 2160
	Brightness	250 cd/m ²
	Contrast	4000:1
	View Angle	178(H)/178(V)
	Response Time	8.0ms
Systems	Maximum Color	16.7M colors
	Color System	NTSC/ATSC
	Sound System	M/MTS
Input / Output Jacks	Sound Output	L/R Speaker: 10W+10W
	RF Input	75 ohm external terminal
	HDMI Input	480i, 480p, 720p, 1080i, 1080p, 2160p.
		HDMI1(2.0), HDMI2(2.0), HDMI3(2.0)
	Composite Video Input	1.0 Vp-p, 75ohms
	Component/Y Pb Pr Input	Y: 1.0 Vp-p, 75ohms, 0.3V negative sync Pb: 0.7Vp-p, 75ohms Pr: 0.7Vp-p, 75ohms
	Sound Input	AV AUDIO: For CVBS/COMPONENT Audio input PC AUDIO: For PC RGB Audio input 500mV rms, Impedance: 20k ohms
Digital audio out	S/PDIF Optical	
Power	USB Port	Media player
	Power Requirement	100-120V~60Hz
	Rated Power Consumption	95W

This manual is only for your reference.
Specifications are subject to update without prior notice.

TROUBLESHOOTING GUIDE

SYMPTOM	CAUSE (AND REMEDY)
TV	
Bad Picture (snow, multiple images distortion,blurry)	<ul style="list-style-type: none"> • Check the location of the antenna and adjust it if necessary. • Make sure the antenna cable is firmly connected. • Make sure all input cables are firmly connected.
No sound.	<ul style="list-style-type: none"> • Increase the volume. • Check whether the mute function has been activated on the Remote Control.
Black and White picture.	<ul style="list-style-type: none"> • Check the PICTURE setting within the PICTURE menu. • Check to make sure the program you are watching is broadcast in Color and not Black & White.
No picture or sound.	<ul style="list-style-type: none"> • Make sure the unit is plugged in and turned on. • Make sure that the ATV mode is selected. • Try a new channel to check for possible station trouble. • Make sure the antenna is connected properly. • Increase the volume. • Make sure the antenna or audio/video source device is working properly. • Make sure all cables are firmly connected. • Check for local interference.
Colored patches of picture.	<ul style="list-style-type: none"> • Make sure there are no unshielded electrical devices nearby that are causing interference. • Turn the TV off for 30 minutes, then try it again.
Panel function key does not respond correctly.	<ul style="list-style-type: none"> • Under the influence of electrostatic phenomenon, the product may malfunction and require usertopowerreset. • Unplug and re-plug the AC power cord.
The display monitor's panel goes hot.	<ul style="list-style-type: none"> • LED TV takes inside lighten phosphor. It may increase the temperature of the screen in some occasions. It's not a defect.
Unusual dots	<ul style="list-style-type: none"> • Black dots and Bright points may appear on the LED screen. This is a structural property of the LED panel and is not a defect.
Stripes on screen	<ul style="list-style-type: none"> • Adjust the impulse phase may decrease stripes. RGB in
The top of the monitor gets hot.	<ul style="list-style-type: none"> • It may occur during long-time working. It's not a defect.
Unable to select a certain channel.	<ul style="list-style-type: none"> • The channel may be skipped. Choose this channel by directly selecting the buttons from the remote control.
Disorder display at power on.	<ul style="list-style-type: none"> • This may be caused because of a very short interval between POWER OFF and ON. • Unplug the power and restart.

To make a warranty claim, do not return this product to the store. Please email support@curtiscs.com or call 1-800-968-9853.

1 Year Warranty

This product is warranted to be free from defects in material and workmanship for a period of one (1) year from the date of original purchase. During this period, your exclusive remedy is repair or replacement of this product or component found to be defective, at our option; however, you are responsible for all costs associated with returning the product to us. If the product or component is no longer available, we will replace with a similar one of equal or greater value. Prior to a replacement being sent, the product must be rendered inoperable or returned to us.

This warranty does **not** cover glass, filters, wear from normal use, use not in conformity with the printed directions., or damage to the product resulting from accident, alteration, abuse, or misuse. This warranty extends only to the original consumer purchaser or gift recipient. Keep the original sales receipt, as proof of purchase is required to make a warranty claim. This warranty is void if the product is used for other than single-family household use or subjected to any voltage and waveform other than as on the specified rating on the label (e.g., 120V~60Hz).

We exclude all claims for special, incidental, and consequential damages caused by breach of express or implied warranty. All liability is limited to the amount of the purchase price. **Every implied warranty, including any statutory warranty or condition of merchantability or fitness for a particular purpose, is disclaimed except to the extent prohibited by law, in which case such warranty or condition is limited to the duration of this written warranty.** This warranty gives you specific legal rights. You may have other legal rights that vary depending on where you live. Some states or provinces do not allow limitations on implied warranties or special, incidental, or consequential damages, so the foregoing limitations may not apply to you.

For faster service, locate the model, type, and serial numbers on your appliance.

