



FCC ID: X09-DOOR-1001
IC No: 8906A-DOOR1001

FCC details

FRN: 0019054196
FCC ID: X09-DOOR-1001
Model ID: SUR101

IC details

IC Company No: 8906A
Certification No: 8906A-DOOR1001
Model No: SUR101

Internal Photos

Front cover removed



PCB cover removed

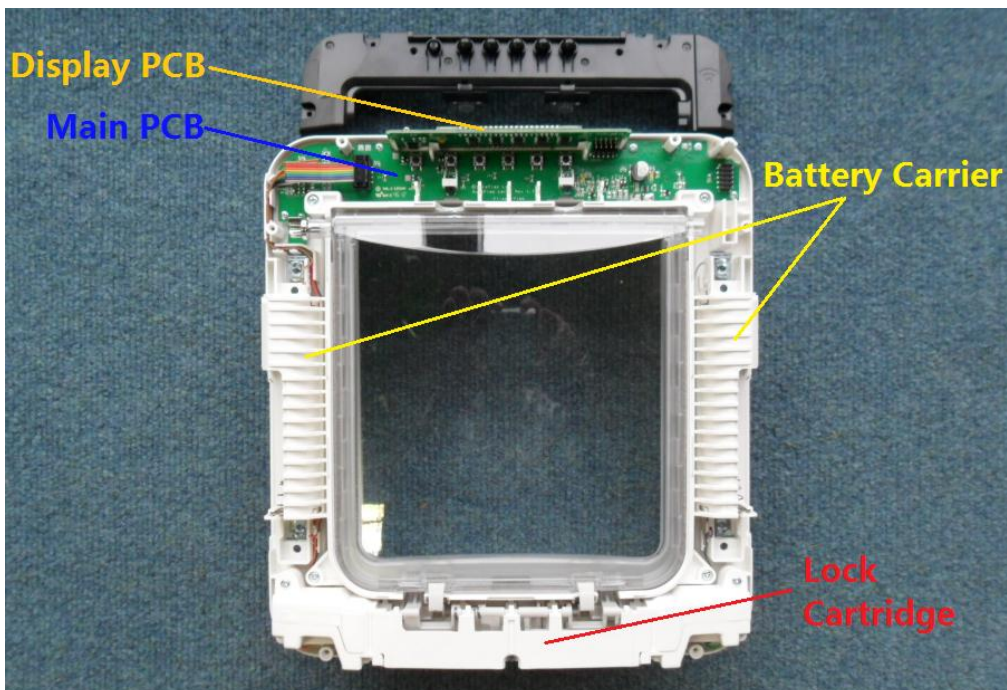

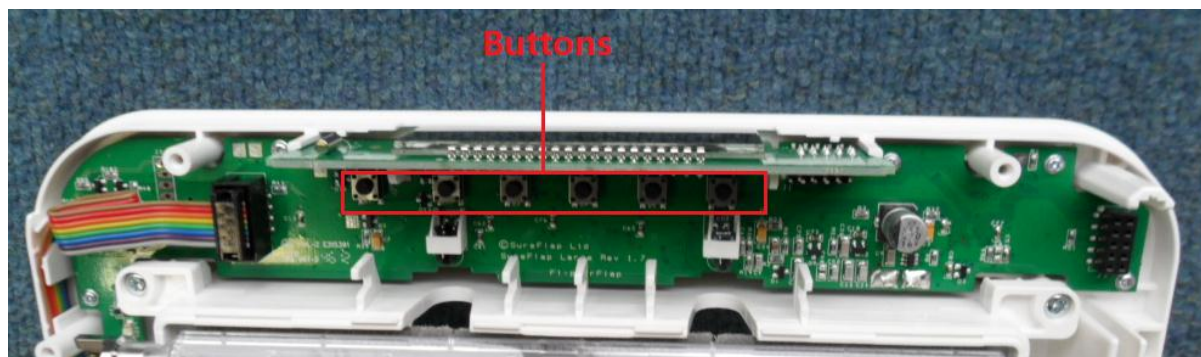
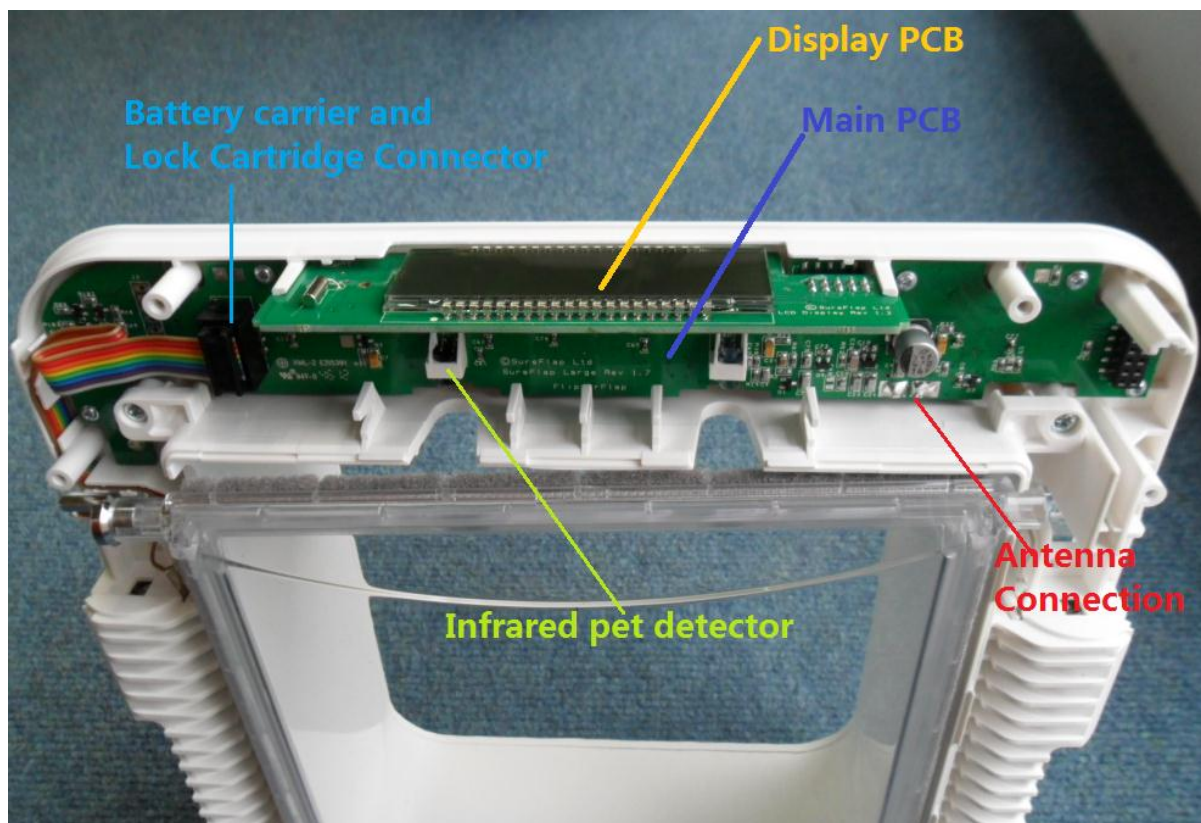

Integrated Antenna



Lock Cartridge Removed



Motor in lock cartridge

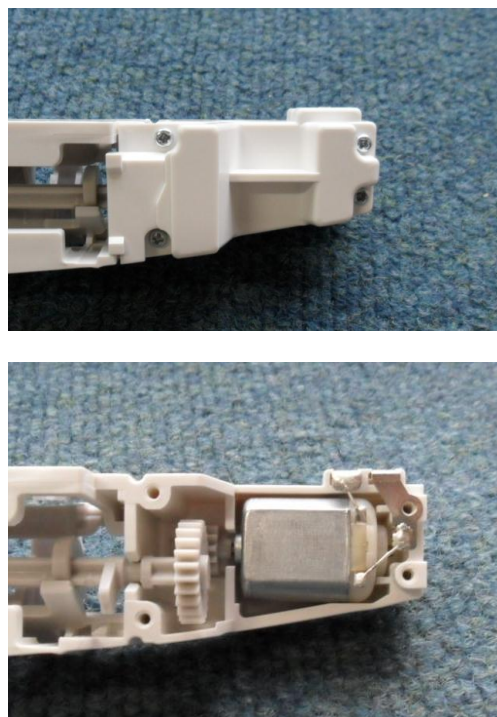

Motorised Lock (Back view)

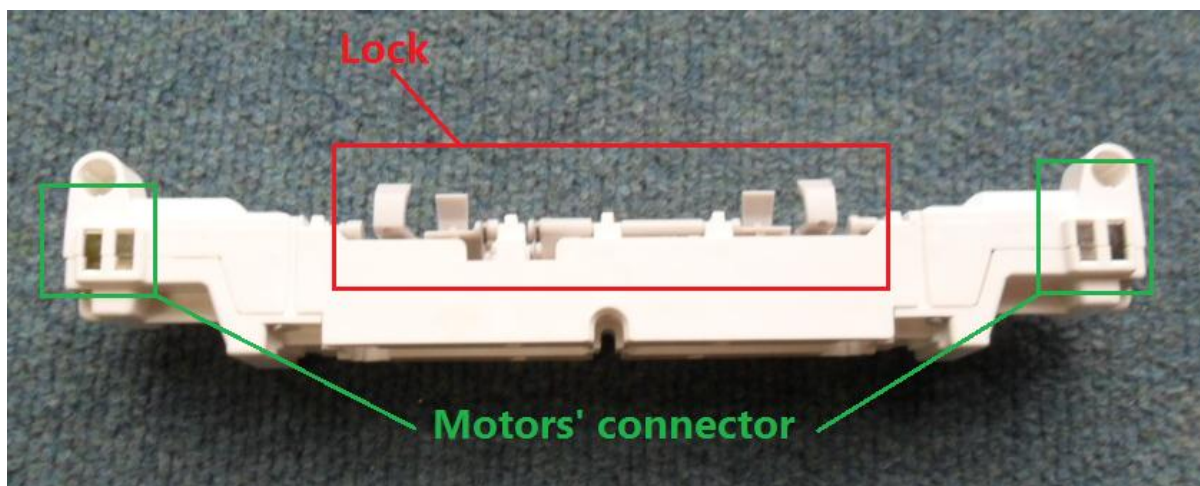

Display Board Top

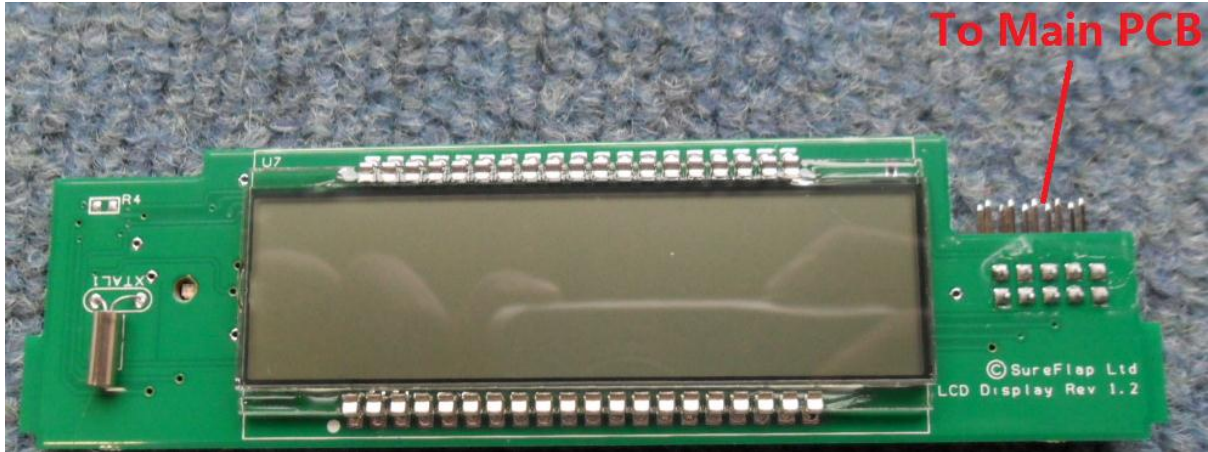

Display Board Bottom

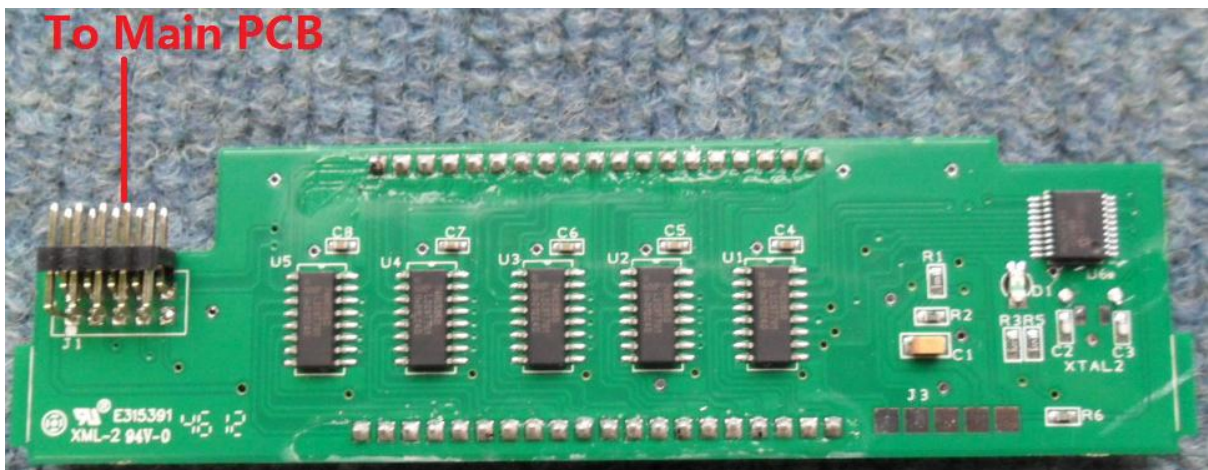

Main Board Top

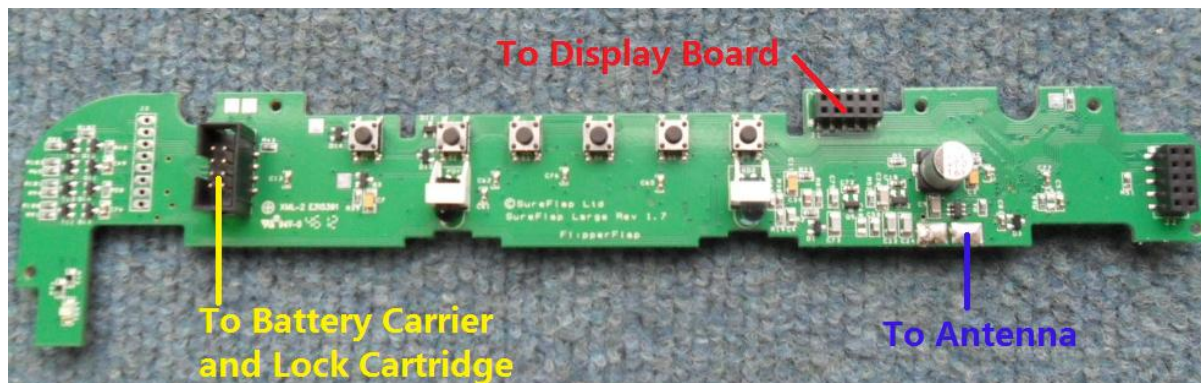

Main Board Bottom

