



Project No.: TM-2207000169P  
Report No.: TMTN2207000954NR

FCC ID: XO8-917TX

Page: 1 / 40  
Rev.: 00

# FCC 47 CFR PART 15 SUBPART C ANSI C63.10: 2013

## TEST REPORT

For

**Halo Transmitter**

**Model: 917TX**

**Data Applies To: N/A**

Brand: 

Test Report Number:  
TMTN2207000954NR

Issued to:

**Instant Care, Inc.**

**2080 Wineridge Pl. Suite A, Escondido, California, United States, 92029**

Issued by:

**Compliance Certification Services Inc.**

**Tainan Lab.**

**No.8, Jiucengling, Xinhua Dist.,  
Tainan City, Taiwan**

**Issued Date: September 02, 2022**

**Note:** This report shall not be reproduced except in full, without the written approval of Compliance Certification Services Inc. Ltd. This document may be altered or revised by Compliance Certification Services Inc. personnel only, and shall be noted in the revision section of the document

Unless otherwise stated the results shown in this test report refer only to the sample(s) tested and such sample(s) are retained for 90 days only.  
除非另有說明，此報告結果僅對測試之樣品負責，同時此樣品僅保留 90 天。本報告未經本公司書面許可，不可部份複製。

This document is issued by the Company subject to its General Conditions of Service printed overleaf, available on request or accessible at <http://www.sgs.com.tw/Terms-and-Conditions> and, for electronic format documents, subject to Terms and Conditions for Electronic Documents at <http://www.sgs.com.tw/Terms-and-Conditions>. Attention is drawn to the limitation of liability, indemnification and jurisdiction issues defined therein. Any holder of this document is advised that information contained hereon reflects the Company's findings at the time of its intervention only and within the limits of client's instruction, if any. The Company's sole responsibility is to its Client and this document does not exonerate parties to a transaction from exercising all their rights and obligations under the transaction documents. This document cannot be reproduced, except in full, without prior written approval of the Company. Any unauthorized alteration, forgery or falsification of the content or appearance of this document is unlawful and offenders may be prosecuted to the fullest extent of the law.

### REVISION HISTORY

Rev.	Issue Date	Revisions	Effect Page	Revised By
00	September 02, 2022	Initial Issue	ALL	Polly Wang

## TABLE OF CONTENTS

<b>1. TEST RESULT CERTIFICATION .....</b>	<b>4</b>
<b>2. EUT DESCRIPTION.....</b>	<b>5</b>
<b>3. TEST METHODOLOGY .....</b>	<b>6</b>
3.1 EUT CONFIGURATION .....	6
3.2 EUT EXERCISE .....	6
3.3 GENERAL TEST PROCEDURES .....	6
3.4 FCC PART 15.205 RESTRICTED BANDS OF OPERATIONS .....	7
3.5 DESCRIPTION OF TEST MODES .....	7
<b>4. INSTRUMENT CALIBRATION .....</b>	<b>8</b>
4.1 MEASURING INSTRUMENT CALIBRATION.....	8
4.2 MEASUREMENT EQUIPMENT USED .....	8
4.3 MEASUREMENT UNCERTAINTY .....	9
<b>5. FACILITIES AND ACCREDITATIONS .....</b>	<b>10</b>
5.1 FACILITIES .....	10
5.2 EQUIPMENT .....	10
5.3 LABORATORY ACCREDITATIONS LISTING.....	10
5.4 TABLE OF ACCREDITATIONS AND LISTINGS.....	11
<b>6. SETUP OF EQUIPMENT UNDER TEST .....</b>	<b>12</b>
6.1 SETUP CONFIGURATION OF EUT .....	12
6.2 SUPPORT EQUIPMENT .....	12
6.3 CONFIGURATION OF SYSTEM UNDER TEST .....	13
6.4 EUT OPERATING CONDITION .....	13
<b>7. FCC PART 15.249 REQUIREMENTS.....</b>	<b>14</b>
7.1 20 DB BANDWIDTH.....	14
7.2 DUTY CYCLE.....	17
7.3 SPURIOUS EMISSION .....	20
7.4 POWERLINE CONDUCTED EMISSIONS .....	31
<b>APPENDIX I - PHOTOGRAPHS OF TEST SETUP.....</b>	<b>32</b>
<b>APPENDIX II PHOTOGRPHS OF EUT .....</b>	<b>36</b>

Report No.: TMTN2203000443NR

## 1. TEST RESULT CERTIFICATION

<b>Product:</b>	Halo Transmitter
<b>Model:</b>	917TX
<b>Data Applies To:</b>	N/A
<b>Brand Name:</b>	
<b>Applicant:</b>	Instant Care, Inc. 2080 Wineridge Pl.Suite A, Escondido, California, United States, 92029
<b>Manufacturer:</b>	Vision Automobile Electronics Industrial Co Ltd No.78, Gongye 3rd Rd., Technology Industrial Park, Tainan , Taiwan , 70955
<b>Tested:</b>	July 20, 2022

APPLICABLE STANDARDS	
STANDARD	TEST RESULT
FCC 47 CFR Part 15 Subpart C ANSI C63.10: 2013	No non-compliance noted

Statements of Conformity
Determining compliance shall be based on the results of the compliance measurement, not taking into account measurement instrumentation uncertainty.

FCC Standard Section	Report Section	Test Item	Result
15.215(c)	7.1	20dB BANDWIDTH	Pass
-	7.3	DUTY CYCLE	-
15.249(a)	7.4	SPURIOUS EMISSION	Pass
15.207(a)	7.5	POWERLINE CONDUCTED EMISSIONS	N/A

### We hereby certify that:

The above equipment was tested by Compliance Certification Services Inc. The test data, data evaluation, test procedures, and equipment configurations shown in this report were made in accordance with the procedures given in ANSI C63.10: 2013 and the energy emitted by the sample EUT tested as described in this report is in compliance with the requirements emission limits of FCC Rules Part 15.107, 15.109, 15.207, 15.209 and 15.249.

The test results of this report relate only to the tested sample identified in this report.

Approved by:



**John Chen**  
Supervisor

## 2. EUT DESCRIPTION

<b>Product</b>	Halo Transmitter
<b>Model Number</b>	917TX
<b>Data Applies To</b>	N/A
<b>Brand Name</b>	
<b>Received Date</b>	July 18, 2022
<b>Reported Date</b>	July 29, 2022
<b>Operation Frequency</b>	917MHz±20kHz- 919MHz±20kHz 921MHz±20kHz
<b>Transmit Peak Power</b>	89.73dBuV/m
<b>Transmit Data Rate</b>	4.8Kbps
<b>Type of Modulation</b>	2FSK
<b>Number of Channels</b>	3 Channel
<b>Power Supply</b>	DC 3V (Powered from battery)
<b>Antenna Type</b>	Type: PCB Antenna Model: 917TX Manufacturer: N/A Gain: -3.6 dBi
<b>RF Module Brand /Model</b>	(U2) TI / CC115L
<b>Hardware Version</b>	Rev.0
<b>Software Version</b>	Rev.0
<b>Temperature Range</b>	-20°C ~ +60°C

**Remark:**

1. Client consigns only one model sample to test (Model Number: **917TX**). Therefore, the testing Lab. just guarantees the unit, which has been tested.
2. This submittal(s) (test report) is intended for FCC ID: **XO8-917TX** filing to comply with Section 15.207, 15.209, 15.249.
3. For more details, please refer to the User's manual of the EUT.

### 3. TEST METHODOLOGY

The tests documented in this report were performed in accordance with ANSI C63.10 and FCC CFR 47 2.1046, 2.1047, 2.1049, 2.1051, 2.1053, 2.1055, 2.1057, 15.207, 15.209 and 15.249.

#### 3.1 EUT CONFIGURATION

The EUT configuration for testing is installed on RF field strength measurement to meet the Commissions requirement and operating in a manner that intends to maximize its emission characteristics in a continuous normal application.

#### 3.2 EUT EXERCISE

The EUT was operated in the engineering mode to fix the TX frequency that was for the purpose of the measurements.

According to its specifications, the EUT must comply with the requirements of the Section 15.207, 15.209, 15.249 under the FCC Rules Part 15 Subpart C.

#### 3.3 GENERAL TEST PROCEDURES

##### Conducted Emissions

The EUT is placed on the turntable, which is 0.8 m above ground plane. According to the requirements in Section 6.2.2 of ANSI C63.10 Conducted emissions from the EUT measured in the frequency range between 0.15 MHz and 30MHz using CISPR Quasi-peak and average detector modes.

##### Radiated Emissions

The EUT is placed on a turn table, which is 0.8 m and 1.5 m above ground plane. The turntable shall rotate 360 degrees to determine the position of maximum emission level. EUT is set 3m away from the receiving antenna, which varied from 1m to 4m to find out the highest emission. And also, each emission was to be maximized by changing the polarization of receiving antenna both horizontal and vertical. In order to find out the maximum emissions, exploratory radiated emission measurements were made according to the requirements in Section 6.5.4 and Section 6.6.4.2 of ANSI C63.10.

### 3.4 FCC PART 15.205 RESTRICTED BANDS OF OPERATIONS

1. Except as shown in paragraph (d) of this section, only spurious emissions are permitted in any of the frequency bands listed below:

MHz	MHz	MHz	GHz
0.090 - 0.110	16.42 - 16.423	399.9 - 410	4.5 - 5.15
<sup>1</sup> 0.495 - 0.505	16.69475 - 16.69525	608 - 614	5.35 - 5.46
2.1735 - 2.1905	16.80425 - 16.80475	960 - 1240	7.25 - 7.75
4.125 - 4.128	25.5 - 25.67	1300 - 1427	8.025 - 8.5
4.17725 - 4.17775	37.5 - 38.25	1435 - 1626.5	9.0 - 9.2
4.20725 - 4.20775	73 - 74.6	1645.5 - 1646.5	9.3 - 9.5
6.215 - 6.218	74.8 - 75.2	1660 - 1710	10.6 - 12.7
6.26775 - 6.26825	108 - 121.94	1718.8 - 1722.2	13.25 - 13.4
6.31175 - 6.31225	123 - 138	2200 - 2300	14.47 - 14.5
8.291 - 8.294	149.9 - 150.05	2310 - 2390	15.35 - 16.2
8.362 - 8.366	156.52475 -	2483.5 - 2500	17.7 - 21.4
8.37625 - 8.38675	156.52525	2655 - 2900	22.01 - 23.12
8.41425 - 8.41475	156.7 - 156.9	3260 - 3267	23.6 - 24.0
12.29 - 12.293	162.0125 - 167.17	3332 - 3339	31.2 - 31.8
12.51975 - 12.52025	167.72 - 173.2	3345.8 - 3358	36.43 - 36.5
12.57675 - 12.57725	240 - 285	3600 - 4400	( <sup>2</sup> )
13.36 - 13.41	322 - 335.4		

<sup>1</sup> Until February 1, 1999, this restricted band shall be 0.490-0.510 MHz.

<sup>2</sup> Above 38.6

2. Except as provided in paragraphs (d) and (e), the field strength of emissions appearing within these frequency bands shall not exceed the limits shown in Section 15.209. At frequencies equal to or less than 1000 MHz, compliance with the limits in Section 15.209 shall be demonstrated using measurement instrumentation employing a CISPR quasi-peak detector. Above 1000 MHz, compliance with the emission limits in Section 15.209 shall be demonstrated based on the average value of the measured emissions. The provisions in Section 15.35 apply to these measurements.

### 3.5 DESCRIPTION OF TEST MODES

The EUT ( **Model: 917TX** ) had been tested under engineering test mode condition and the EUT staying in continuous transmitting mode.

Note :

The field strength of spurious emission was measured in the following position:

- 1) The field strength of spurious emission was measured in the following position: EUT stand-up position (Y axis), lie-down position (X, Z axis). The worst emission was found in lie-down position (X axis) and the worst case was recorded.

## 4. INSTRUMENT CALIBRATION

### 4.1 MEASURING INSTRUMENT CALIBRATION

The measuring equipment, which was utilized in performing the tests documented herein, has been calibrated in accordance with the manufacturer's recommendations for utilizing calibration equipment, which is traceable to recognized national standards.

### 4.2 MEASUREMENT EQUIPMENT USED

#### Equipment Used for Emissions Measurement

Chamber Room #966					
Name of Equipment	Manufacturer	Model	Serial Number	Calibration Date	Calibration Due
Active Loop Antenna	ETS-LINDREN	6502	8905-2356	09/06/2021	09/05/2023
Attenuator	MCL	BW-S15W5	0535	01/28/2022	01/27/2023
Band Reject Filter	MICRO-TRONIC S	HPM13525	006	01/28/2022	01/27/2023
Bilog Antenna With 6dB Attenuator	SUNOL SCIENCES & EMCI	JB1 & N-6-06	A070506-1 & AT-N0681	10/07/2021	10/06/2022
Cable	Suhner	SUCOFLEX104PEA	20520/4PEA&O6	01/28/2022	01/27/2023
EMI Test Receiver	R&S	ESCI 7	100856	06/21/2022	06/20/2023
EXA Spectrum Analyzer	KEYSIGHT	N9010A	MY54430216	07/22/2021	01/21/2023
Double Ridged Guide Horn Antenna	COM-POWER	AH-118	071032	05/16/2022	05/15/2023
Pre-Amplifier	EMCI	EMC012645	980098	01/28/2022	01/27/2023
Pre-Amplifier	HP	8447F	2443A01683	01/18/2022	01/17/2023
Type N coaxial cable	Suhner	CHA9513	6	01/18/2022	01/17/2023
<b>Software</b>	Excel(ccs-o6-2020 v1.1) , e3(v6.101222)				

**Remark:** Each piece of equipment is scheduled for calibration once a year.



### 4.3 MEASUREMENT UNCERTAINTY

Parameter	Uncertainty
Radiated Emission, 30 to 200 MHz Test Site : CB966	±3.1dB
Radiated Emission, 200 to 1000 MHz Test Site : CB966	±2.7dB
Radiated Emission, 1 to 6 GHz	± 2.7dB
Radiated Emission, 6 to 18 GHz	± 2.7dB
Radiated Emission, 18 to 26.5 GHz	± 2.7dB
Radiated Emission, 26 to 40 GHz	± 3.7dB
Power Line Conducted Emission	± 2.0dB

Uncertainty figures are valid to a confidence level of 95%, k=2

## 5. FACILITIES AND ACCREDITATIONS

### 5.1 FACILITIES

All measurement facilities used to collect the measurement data are located at

No.8, Jiucengling, Xinhua Dist., Tainan City 712, Taiwan (R.O.C.)

The sites are constructed in conformance with the requirements of ANSI C63.7:1992, ANSI C63.10: 2013 and CISPR Publication 22.

### 5.2 EQUIPMENT

Radiated emissions are measured with one or more of the following types of linearly polarized antennas: tuned dipole, biconical, log periodic, bi-log, and/or ridged waveguide, horn. Spectrum analyzers with pre-selectors and quasi-peak detectors are used to perform radiated measurements.

Conducted emissions are measured with Line Impedance Stabilization Networks and EMI Test Receivers.

Calibrated wideband preamplifiers, coaxial cables, and coaxial attenuators are also used for making measurements.

All receiving equipment conforms to CISPR Publication 16-1, "Radio Interference Measuring Apparatus and Measurement Methods."

### 5.3 LABORATORY ACCREDITATIONS LISTING

The test facilities used to perform radiated and conducted emissions tests are accredited by Taiwan Accreditation Foundation for the specific scope of accreditation under Lab Code: 1109 to perform Electromagnetic Interference tests according to FCC PART 15 AND CISPR 22 requirements. No part of this report may be used to claim or imply product endorsement by TAF or any agency of the Government. In addition, the test facilities are listed with Federal Communications Commission (registration no: TW1109).

## 5.4 TABLE OF ACCREDITATIONS AND LISTINGS

Our laboratories are accredited and approved by the following accreditation body according to ISO/IEC 17025.

<b>Taiwan</b>	TAF
---------------	-----

The measuring facility of laboratories has been authorized or registered by the following approval agencies.

<b>Canada</b>	Industry Canada
<b>Germany</b>	TUV NORD
<b>Taiwan</b>	BSMI
<b>USA</b>	FCC

## 6. SETUP OF EQUIPMENT UNDER TEST

### 6.1 SETUP CONFIGURATION OF EUT

See test photographs attached in Appendix I for the actual connections between EUT and support equipment.

### 6.2 SUPPORT EQUIPMENT

#### 【RF】

No.	Product	Manufacturer	Model No.	Certify No.	Signal cable
1	N/A	N/A	N/A	N/A	N/A

No.	Signal cable description	
A	N/A	N/A

#### 【EMC】

No.	Product	Manufacturer	Model No.	Certify No.	Signal cable
1	N/A	N/A	N/A	N/A	N/A

No.	Signal cable description	
A	N/A	N/A

#### Remark:

1. All the equipment/cables were placed in the worst-case configuration to maximize the emission during the test.
2. Grounding was established in accordance with the manufacturer's requirements and conditions for the intended use.

## 6.3 CONFIGURATION OF SYSTEM UNDER TEST

**【RF】**

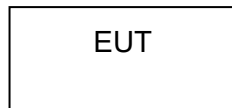

## 6.4 EUT OPERATING CONDITION

### RF Setup

1. Set up a whole system as the setup diagram.
2. Turn on power.

## 7. FCC PART 15.249 REQUIREMENTS

### 7.1 20 dB BANDWIDTH

#### LIMIT

None; for reporting purposes only.

#### TEST CONFIGURATION

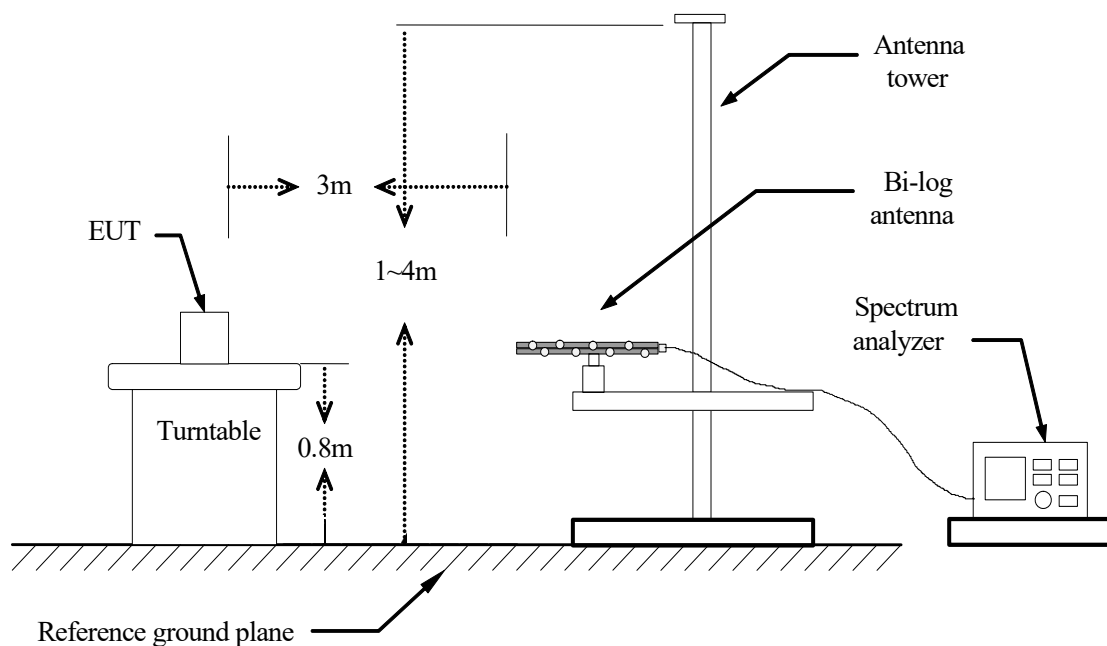

#### TEST PROCEDURE

1. The EUT is placed on a turntable, which is 0.8m above ground plane.
2. The turntable shall be rotated for 360 degrees to determine the position of maximum emission level.
3. EUT is set 3m away from the receiving antenna, which is varied from 1m to 4m to find out the highest emissions.
4. Maximum procedure was performed on the six highest emissions to ensure EUT compliance.
5. And also, each emission was to be maximized by changing the polarization of receiving antenna both horizontal and vertical.
6. Set the spectrum analyzer in the following setting as:  
RBW is set to 3 kHz and VBW is set 10kHz.

## **TEST RESULTS**

No non-compliance noted.

## **TEST DATA**

**Operation Mode:** TX

**Test Date:** 07/20/2022

**Temperature:** 29.4°C

**Tested by:** Peter Chu

**Humidity:** 55% RH

**Polarity:** Ver. / Hor.

<b>Frequency (MHz)</b>	<b>20 dB Bandwidth (MHz)</b>
917	0.01
921	0.01

## TEST PLOT

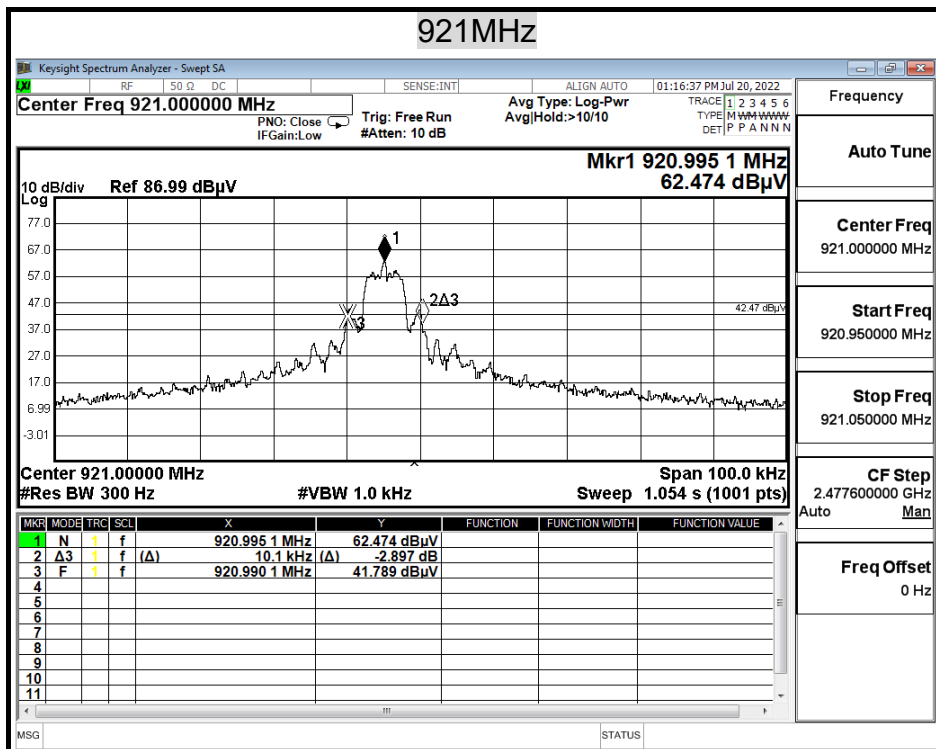
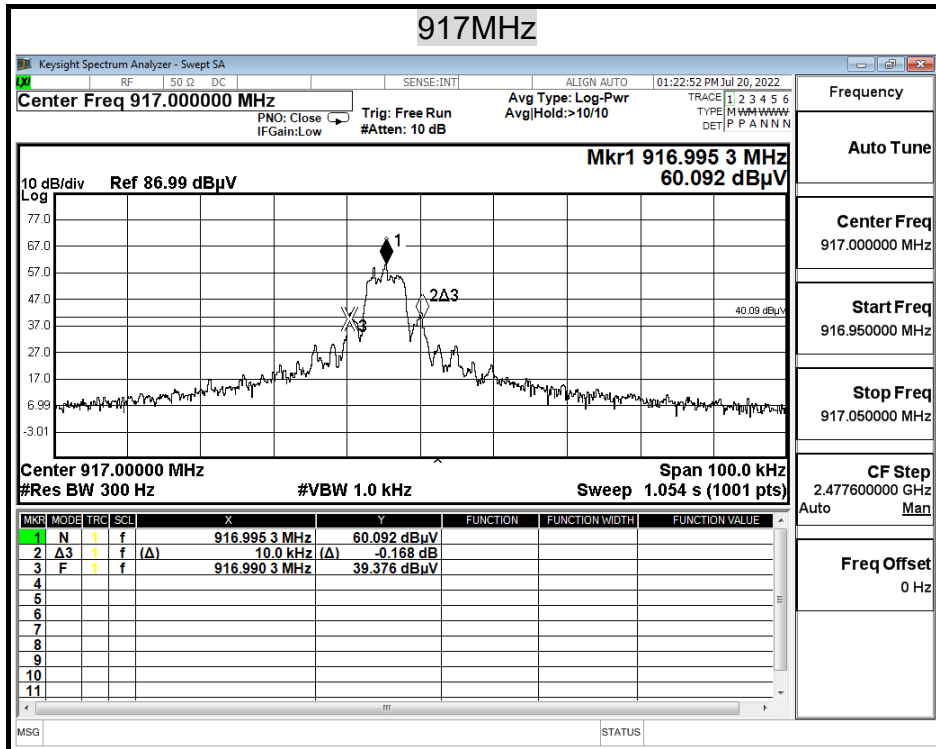



## 7.2 DUTY CYCLE

### LIMIT

Nil (No dedicated limit specified in the Rules)

### TEST CONFIGURATION

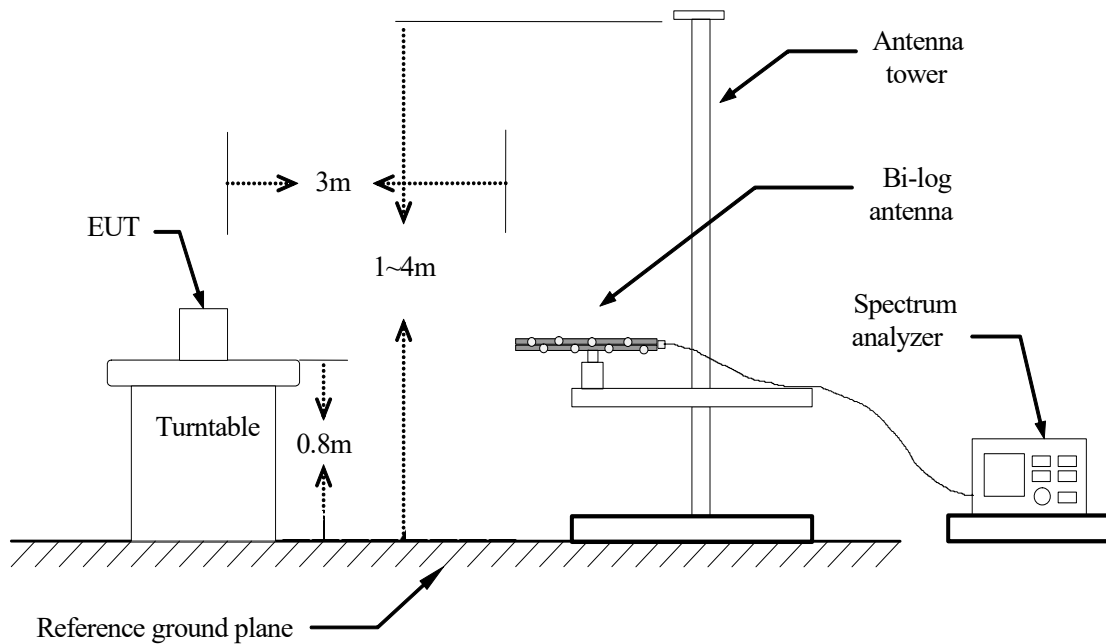

### TEST PROCEDURE

1. Place the EUT on the table and set it in transmitting mode.
2. Set center frequency of spectrum analyzer = operating frequency.
3. Set the spectrum analyzer as RBW=1MHz, VBW=3MHz, Span = 0Hz, a suitable Sweep Time.
4. Repeat above procedures until all frequency measured were complete.

### TEST RESULTS

No non-compliance noted.

**TEST DATA**

**Operation Mode:** TX

**Test Date:** 07/20/2022

**Temperature:** 29.4°C

**Tested by:** Peter Chu

**Humidity:** 55% RH

**Polarity:** Ver. / Hor.

**908 MHz**

	us	Times	Ton	Total Ton time(ms)
Ton1	38700.000	1	38700.000	38.700
Ton2		0	0.000	
Ton3		0	0.000	
Tp				100.000

Ton	38.700
Tp(Ton+Toff)	100.000
Duty Cycle	0.387
Duty Factor	-8.246

38.7 %

## TEST PLOT

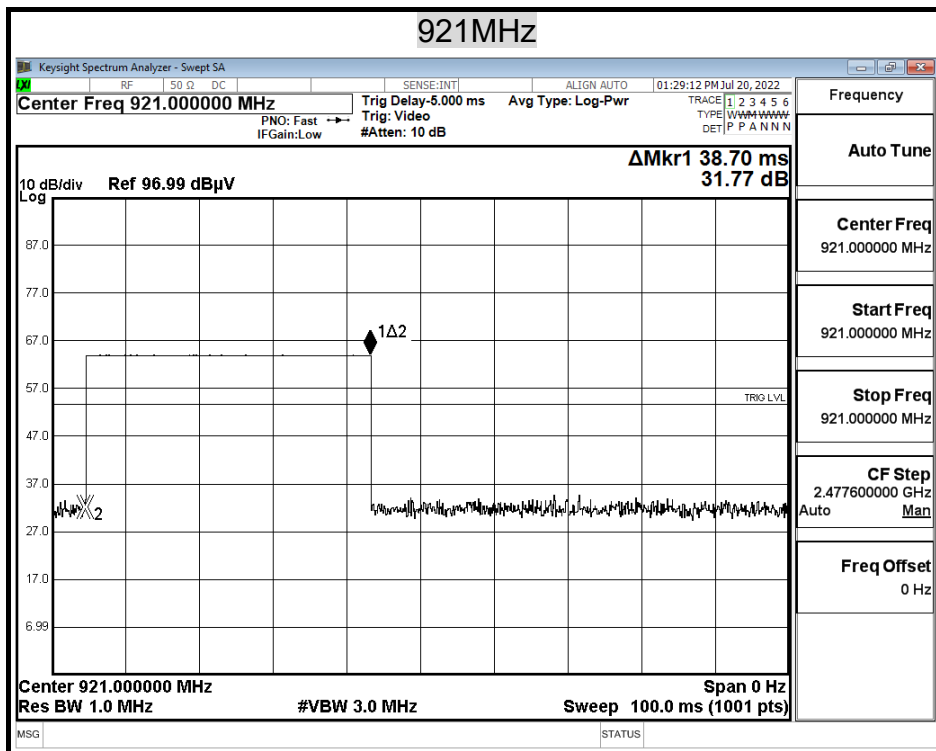
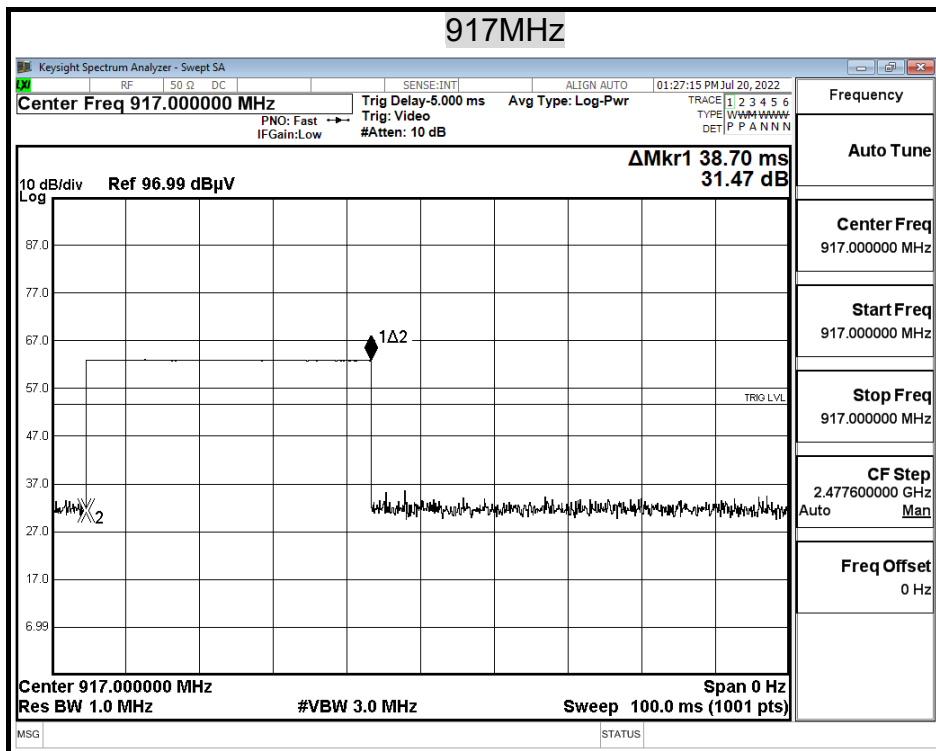

Report No.: TMTN2203000443NR

## 7.3 SPURIOUS EMISSION

### LIMIT

1. In the section 15.249(a):

Except as provided in paragraph (b) of this section, the field strength of emissions from intentional radiators operated within these frequency bands shall comply with the following:

Fundamental Frequency (MHz)	Field Strength of Fundamental Field Strength (mV/m)	Field Strength of Harmonics ( $\mu\text{V/m}$ )
902-928 MHz	50	500
2400 - 2483.5 MHz	50	500
5725 - 5875 MHz	50	500
24.0 - 24.25 GHz	250	2500

2. Except as provided elsewhere in this Subpart, the emissions from an intentional radiator shall not exceed the field strength levels specified in the following table:

Frequency (MHz)	Field Strength ( $\mu\text{V/m}$ )	Measurement Distance (m)
30-88	100*	3
88-216	150*	3
216-960	200*	3
Above 960	500	3

**Remark:** Except as provided in paragraph (g), fundamental emissions from intentional radiators operating under this Section shall not be located in the frequency bands 54-72 MHz, 76-88 MHz, 174-216 MHz or 470-806 MHz. However, operation within these frequency bands is permitted under other sections of this Part, e.g., Sections 15.231 and 15.241.

3. In the above emission table, the tighter limit applies at the band edges.

Frequency (MHz)	Field Strength ( $\mu\text{V/m}$ at 3-meter)	Field Strength (dB $\mu\text{V/m}$ at 3-meter)
30-88	100	40
88-216	150	43.5
216-960	200	46
Above 960	500	54

## TEST CONFIGURATION

9kHz ~ 30MHz

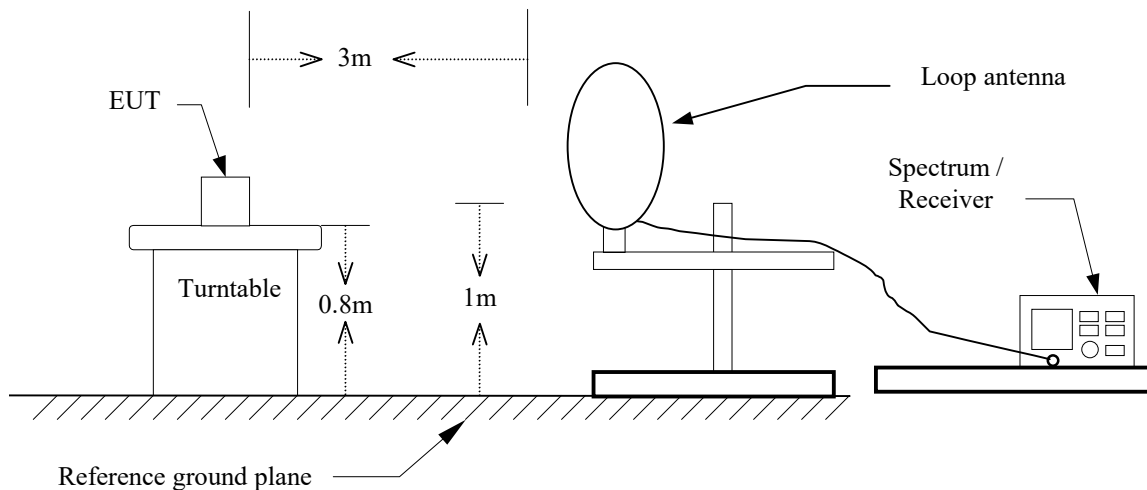

30MHz ~ 1GHz

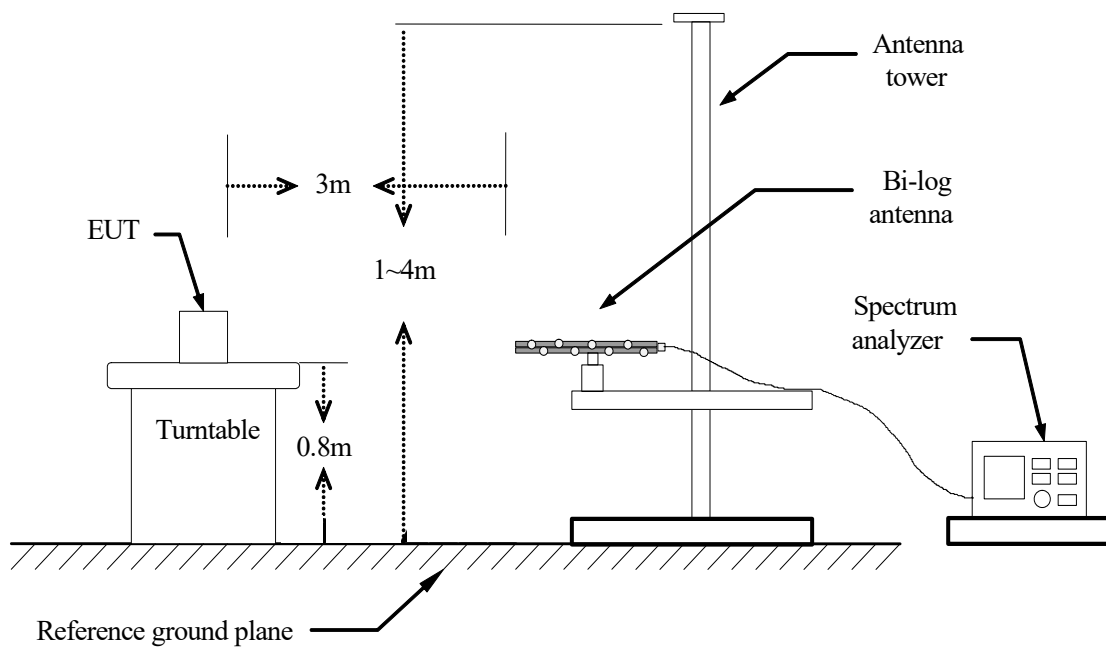

Report No.: TMTN2203000443NR

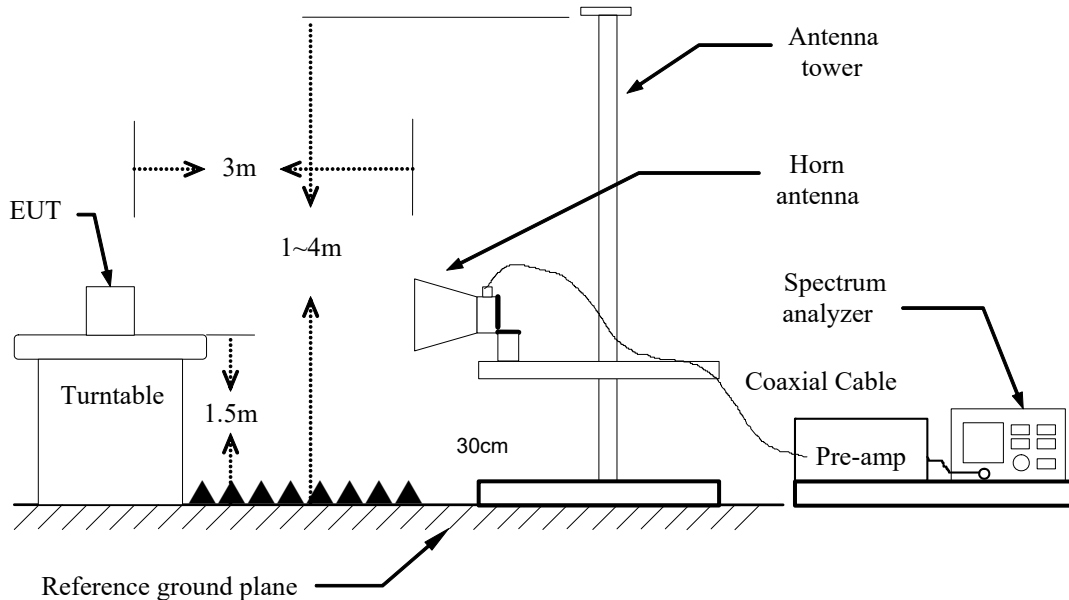
**Above 1 GHz****TEST PROCEDURE**

1. The EUT is placed on a turntable, which is 0.8/1.5m above ground plane.
2. The turntable shall be rotated for 360 degrees to determine the position of maximum emission level.
3. EUT is set 3m away from the receiving antenna, which is varied from 1m to 4m to find out the highest emissions.
4. Maximum procedure was performed on the six highest emissions to ensure EUT compliance.
5. And also, each emission was to be maximized by changing the polarization of receiving antenna both horizontal and vertical.
6. Set the spectrum analyzer in the following setting as:  
Below 1GHz:  
RBW=100kHz / VBW=300kHz / Sweep=AUTO  
Above 1GHz:  
(a) PEAK: RBW=VBW=1MHz / Sweep=AUTO  
(b) AVERAGE: Peak Level + Duty Factor
7. Repeat above procedures until the measurements for all frequencies are complete.

Report No.: TMTN2203000443NR

**Below 1 GHz**

Operation Mode: TX

Test Date: 07/20/2022

Temperature: 30.5°C

Tested by: Peter Chu

Humidity: 58% RH

Polarity: Ver. / Hor.

**Vertical**

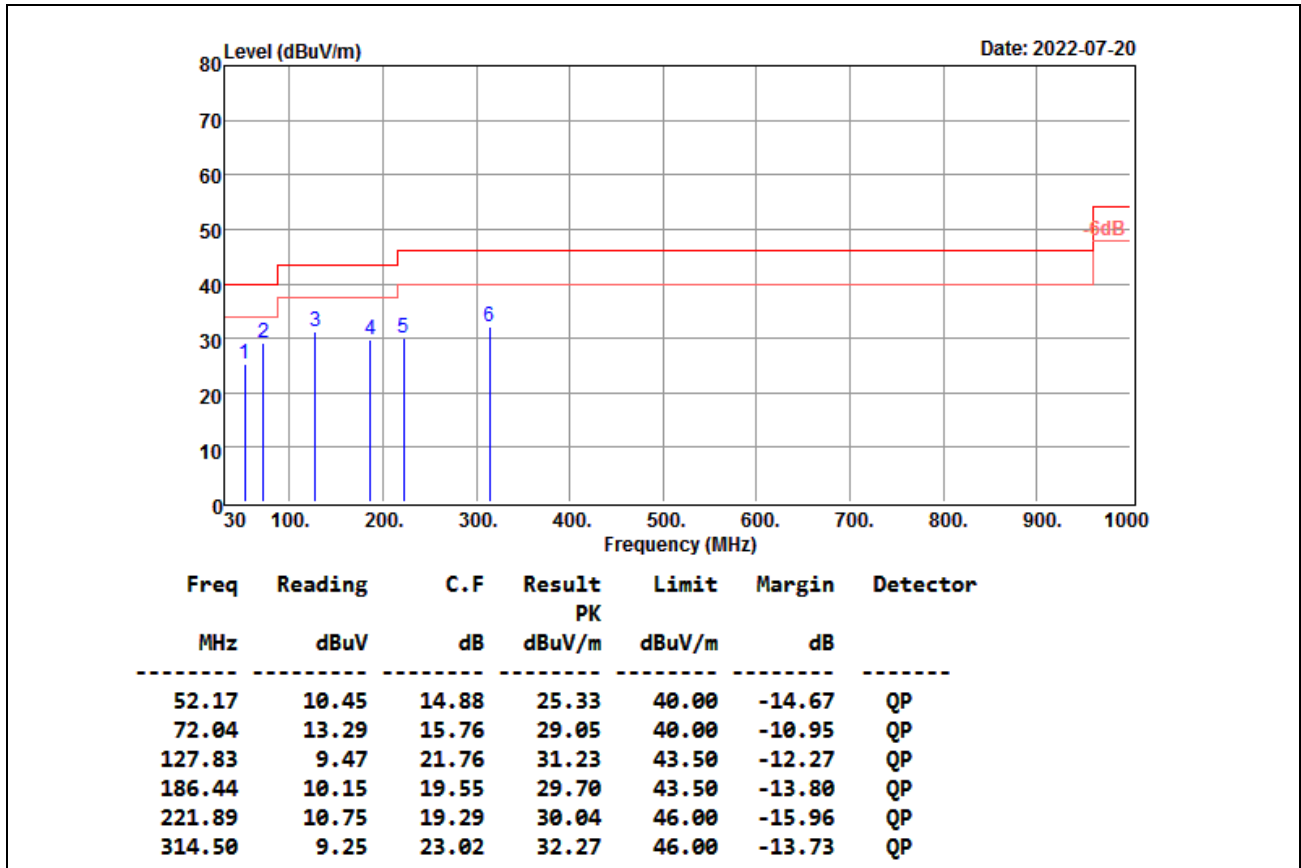

**Remark:**

- No emission found between lowest internal used/generated frequency to 30MHz (9kHz~30MHz).
- Radiated emissions measured in frequency range from 30 MHz to 1000MHz were made with an instrument using peak/quasi-peak detector mode.
- Quasi-peak test would be performed if the peak result were greater than the quasi-peak limit or as required by the applicant.
- Measurements above show only up to 6 maximum emissions noted, or would be lesser, with " N/A " remark, if no specific emissions from the EUT are recorded (ie: margin>20dB from the applicable limit) and considered that's already beyond the background noise floor.
- Margin (dB) = Remark result (dBuV/m) – Quasi-peak limit (dBuV/m).
- That the limit for signals below 1GHz is a QP limit and peak readings are below the QP limit.
- The fundamental signal is not shown in the test data because measurements at fundamental frequency are shown separately and were ignored during the 30 – 1000 MHz scan.

Report No.: TMTN2203000443NR

Operation Mode: TX

Test Date: 07/20/2022

Temperature: 30.5°C

Tested by: Peter Chu

Humidity: 58% RH

Polarity: Ver. / Hor.

**Horizontal**

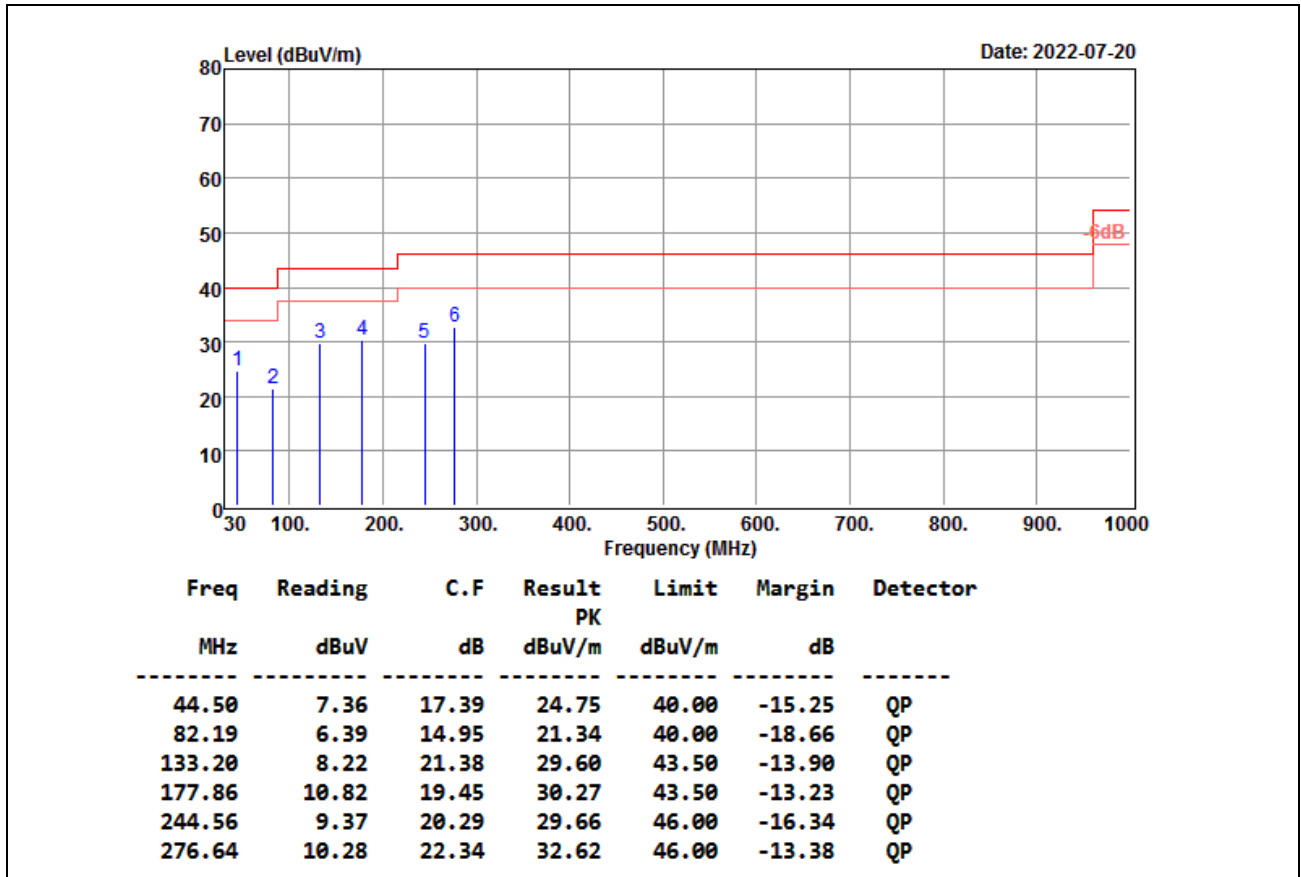

**Remark:**

- No emission found between lowest internal used/generated frequency to 30MHz (9kHz~30MHz).
- Radiated emissions measured in frequency range from 30 MHz to 1000MHz were made with an instrument using peak/quasi-peak detector mode.
- Quasi-peak test would be performed if the peak result were greater than the quasi-peak limit or as required by the applicant.
- Measurements above show only up to 6 maximum emissions noted, or would be lesser, with "N/A" remark, if no specific emissions from the EUT are recorded (ie: margin>20dB from the applicable limit) and considered that's already beyond the background noise floor.
- Margin (dB) = Remark result (dBuV/m) – Quasi-peak limit (dBuV/m).
- That the limit for signals below 1GHz is a QP limit and peak readings are below the QP limit.
- The fundamental signal is not shown in the test data because measurements at fundamental frequency are shown separately and were ignored during the 30 – 1000 MHz scan.



**The fundamental signal**

**Operation Mode:** 917MHz

**Temperature:** 29.4°C

**Humidity:** 55% RH

**Test Date:** 07/20/2022

**Tested by:** Peter Chu

**Polarity:** Ver. / Hor.

Horizontal

Freq.	Reading	AF	Cable Loss	Pre-amp	Filter	Level	Limit	Margin	Mark
(MHz)	(dBμV)	(dB/m)	(dB)	(dB)	(dB)	(dBμV/m)	(dBμV/m)	(dB)	(P/Q/A)
917.000	77.630	28.753	6.803	24.409	0.000	88.777	114.000	-25.223	P
917.000	76.817	28.753	6.803	24.409	0.000	87.964	94.000	-6.036	Q

Vertical

Freq.	Reading	AF	Cable Loss	Pre-amp	Filter	Level	Limit	Margin	Mark
(MHz)	(dBμV)	(dB/m)	(dB)	(dB)	(dB)	(dBμV/m)	(dBμV/m)	(dB)	(P/Q/A)
917.000	65.450	28.753	6.803	24.409	0.000	76.597	114.000	-37.403	P
917.000	64.550	28.753	6.803	24.409	0.000	75.697	94.000	-18.303	Q

**Remark:**

*Margin (dB) = Remark result (dBuV/m) – Quasi-peak limit (dBuV/m).*

**Operation Mode:** 921MHz  
**Temperature:** 29.4°C  
**Humidity:** 55% RH

**Test Date:** 07/20/2022  
**Tested by:** Peter Chu  
**Polarity:** Ver. / Hor.

Horizontal

Freq.	Reading	AF	Cable Loss	Pre-amp	Filter	Level	Limit	Margin	Mark
(MHz)	(dBμV)	(dB/m)	(dB)	(dB)	(dB)	(dBμV/m)	(dBμV/m)	(dB)	(P/Q/A)
921.00	78.54	28.79	6.82	24.42	0.00	89.73	114.00	-24.27	P
921.00	77.69	28.79	6.82	24.42	0.00	88.88	94.00	-5.12	Q

Vertical

Freq.	Reading	AF	Cable Loss	Pre-amp	Filter	Level	Limit	Margin	Mark
(MHz)	(dBμV)	(dB/m)	(dB)	(dB)	(dB)	(dBμV/m)	(dBμV/m)	(dB)	(P/Q/A)
921.00	65.56	28.79	6.82	24.42	0.00	76.75	114.00	-37.25	P
921.00	64.69	28.79	6.82	24.42	0.00	75.88	94.00	-18.12	Q

**Remark:**

*Margin (dB) = Remark result (dBuV/m) – Quasi-peak limit (dBuV/m).*

Report No.: TMTN2203000443NR

**Above 1 GHz**

**Operation Mode:** 917MHz

**Test Date:** 07/20/2022

**Temperature:** 29.4°C

**Tested by:** Peter Chu

**Humidity:** 55% RH

**Polarity:** Ver. / Hor.

Horizontal

Freq.	Reading	AF	Cable Loss	Pre-amp	Filter	Level	Limit	Margin	Mark
(MHz)	(dBμV)	(dB/m)	(dB)	(dB)	(dB)	(dBμV/m)	(dBμV/m)	(dB)	(P/Q/A)
1833.92	68.56	29.20	3.50	44.28	0.41	57.39	74.00	-16.61	P
1833.92	60.83	29.20	3.50	44.28	0.41	49.66	54.00	-4.34	A
* 2750.92	57.13	30.15	4.12	43.49	0.25	48.16	74.00	-25.84	P
* 2750.92	46.17	30.15	4.12	43.49	0.25	37.20	54.00	-16.80	A
* 3668.09	57.03	30.67	4.67	42.89	0.33	49.81	74.00	-24.19	P
* 3668.09	48.75	30.67	4.67	42.89	0.33	41.53	54.00	-12.47	A
5501.96	57.94	34.10	5.87	42.67	0.26	55.50	74.00	-18.50	P
5501.96	49.94	34.10	5.87	42.67	0.26	47.50	54.00	-6.50	A
* 7336.09	55.82	39.18	6.59	42.27	0.49	59.81	74.00	-14.19	P
* 7336.09	45.65	39.18	6.59	42.27	0.49	49.64	54.00	-4.36	A
* 9169.96	54.40	38.50	6.97	40.12	0.68	60.43	74.00	-13.57	P
* 9169.96	46.24	38.50	6.97	40.12	0.68	52.27	54.00	-1.73	A

**Remark:**

1. Measuring frequencies from 1 GHz to the 10th harmonic of highest fundamental frequency.
2. Radiated emissions measured in frequency above 1000MHz were made with an instrument using peak/average detector mode.
3. Average test would be performed if the peak result were greater than the average limit or as required by the applicant.
4. Data of measurement within this frequency range shown " --- " in the table above means the reading of emissions are attenuated more than 20dB below the permissible limits or the field strength is too small to be measured.
5. Measurements above show only up to 6 maximum emissions noted, or would be lesser, with " N/A " remark, if no specific emissions from the EUT are recorded (ie: margin>20dB from the applicable limit) and considered that's already beyond the background noise floor.
6. Margin (dB) = Remark result (dBuV/m) – Average limit (dBuV/m). Peak detector mode and average detector mode of the emission shown in Result column.
7. Average level=Peak level + Duty factor.
8. \*=Restricted bands of operation

Report No.: TMTN2203000443NR

Operation Mode: 917MHz  
Temperature: 29.4°C  
Humidity: 55% RH

Test Date: 07/20/2022  
Tested by: Peter Chu  
Polarity: Ver. / Hor.

Vertical

Freq.	Reading	AF	Cable Loss	Pre-amp	Filter	Level	Limit	Margin	Mark
(MHz)	(dBμV)	(dB/m)	(dB)	(dB)	(dB)	(dBμV/m)	(dBμV/m)	(dB)	(P/Q/A)
1834.02	72.03	29.21	3.50	44.28	0.41	60.86	74.00	-13.14	P
1834.02	60.51	29.21	3.50	44.28	0.41	49.34	54.00	-4.66	A
* 2751.04	56.89	30.15	4.12	43.49	0.25	47.92	74.00	-26.08	P
* 2751.04	46.88	30.15	4.12	43.49	0.25	37.91	54.00	-16.09	A
* 3667.89	57.54	30.67	4.67	42.89	0.33	50.32	74.00	-23.68	P
* 3667.89	47.44	30.67	4.67	42.89	0.33	40.22	54.00	-13.78	A
5501.93	58.28	34.10	5.87	42.67	0.26	55.84	74.00	-18.16	P
5501.93	49.91	34.10	5.87	42.67	0.26	47.47	54.00	-6.53	A
* 7335.91	55.88	39.18	6.59	42.27	0.49	59.87	74.00	-14.13	P
* 7335.91	45.73	39.18	6.59	42.27	0.49	49.72	54.00	-4.28	A
* 9170.13	54.01	38.50	6.97	40.12	0.68	60.04	74.00	-13.96	P
* 9170.13	45.68	38.50	6.97	40.12	0.68	51.71	54.00	-2.29	A

Remark:

1. Measuring frequencies from 1 GHz to the 10th harmonic of highest fundamental frequency.
2. Radiated emissions measured in frequency above 1000MHz were made with an instrument using peak/average detector mode.
3. Average test would be performed if the peak result were greater than the average limit or as required by the applicant.
4. Data of measurement within this frequency range shown " --- " in the table above means the reading of emissions are attenuated more than 20dB below the permissible limits or the field strength is too small to be measured.
5. Measurements above show only up to 6 maximum emissions noted, or would be lesser, with " N/A " remark, if no specific emissions from the EUT are recorded (ie: margin>20dB from the applicable limit) and considered that's already beyond the background noise floor.
6. Margin (dB) = Remark result (dBuV/m) – Average limit (dBuV/m). Peak detector mode and average detector mode of the emission shown in Result column.
7. Average level=Peak level + Duty factor.
8. \*=Restricted bands of operation

Report No.: TMTN2203000443NR

Operation Mode: 921MHz  
Temperature: 29.4°C  
Humidity: 55% RH

Test Date: 07/20/2022  
Tested by: Peter Chu  
Polarity: Ver. / Hor.

Horizontal

Freq.	Reading	AF	Cable Loss	Pre-amp	Filter	Level	Limit	Margin	Mark
(MHz)	(dBμV)	(dB/m)	(dB)	(dB)	(dB)	(dBμV/m)	(dBμV/m)	(dB)	(P/Q/A)
1842.03	68.56	29.27	3.51	44.27	0.41	57.47	74.00	-16.53	P
1842.03	60.78	29.27	3.51	44.27	0.41	49.69	54.00	-4.31	A
* 2763.04	56.25	30.15	4.13	43.48	0.25	47.30	74.00	-26.70	P
* 2763.04	46.57	30.15	4.13	43.48	0.25	37.62	54.00	-16.38	A
* 3684.01	57.11	30.68	4.68	42.88	0.32	49.93	74.00	-24.07	P
* 3684.01	48.45	30.68	4.68	42.88	0.32	41.27	54.00	-12.73	A
5526.13	57.28	34.12	5.87	42.67	0.26	54.86	74.00	-19.14	P
5526.13	48.88	34.12	5.87	42.67	0.26	46.46	54.00	-7.54	A
* 7368.02	56.75	39.32	6.60	42.22	0.50	60.95	74.00	-13.05	P
* 7368.02	45.42	39.32	6.60	42.22	0.50	49.62	54.00	-4.38	A
9209.91	54.04	38.53	6.99	40.13	0.68	60.11	74.00	-13.89	P
9209.91	44.72	38.53	6.99	40.13	0.68	50.79	54.00	-3.21	A

Remark:

1. Measuring frequencies from 1 GHz to the 10th harmonic of highest fundamental frequency.
2. Radiated emissions measured in frequency above 1000MHz were made with an instrument using peak/average detector mode.
3. Average test would be performed if the peak result were greater than the average limit or as required by the applicant.
4. Data of measurement within this frequency range shown " --- " in the table above means the reading of emissions are attenuated more than 20dB below the permissible limits or the field strength is too small to be measured.
5. Measurements above show only up to 6 maximum emissions noted, or would be lesser, with " N/A " remark, if no specific emissions from the EUT are recorded (ie: margin>20dB from the applicable limit) and considered that's already beyond the background noise floor.
6. Margin (dB) = Remark result (dBuV/m) – Average limit (dBuV/m). Peak detector mode and average detector mode of the emission shown in Result column.
7. Average level=Peak level + Duty factor.
8. \*=Restricted bands of operation

Report No.: TMTN2203000443NR

Operation Mode: 921MHz  
Temperature: 29.4°C  
Humidity: 55% RH

Test Date: 07/20/2022  
Tested by: Peter Chu  
Polarity: Ver. / Hor.

Vertical

Freq.	Reading	AF	Cable Loss	Pre-amp	Filter	Level	Limit	Margin	Mark
(MHz)	(dBμV)	(dB/m)	(dB)	(dB)	(dB)	(dBμV/m)	(dBμV/m)	(dB)	(P/Q/A)
1842.34	69.55	29.27	3.51	44.27	0.41	58.46	74.00	-15.54	P
1842.34	59.36	29.27	3.51	44.27	0.41	48.27	54.00	-5.73	A
* 2763.07	57.70	30.15	4.13	43.48	0.25	48.75	74.00	-25.25	P
* 2763.07	46.47	30.15	4.13	43.48	0.25	37.52	54.00	-16.48	A
* 3684.13	56.82	30.68	4.68	42.88	0.32	49.64	74.00	-24.36	P
* 3684.13	46.37	30.68	4.68	42.88	0.32	39.19	54.00	-14.81	A
5525.84	57.59	34.12	5.87	42.67	0.26	55.17	74.00	-18.83	P
5525.84	49.18	34.12	5.87	42.67	0.26	46.76	54.00	-7.24	A
* 7368.34	56.10	39.32	6.60	42.22	0.50	60.30	74.00	-13.70	P
* 7368.34	44.70	39.32	6.60	42.22	0.50	48.90	54.00	-5.10	A
9209.87	54.21	38.53	6.99	40.13	0.68	60.28	74.00	-13.72	P
9209.87	45.75	38.53	6.99	40.13	0.68	51.82	54.00	-2.18	A

Remark:

1. Measuring frequencies from 1 GHz to the 10th harmonic of highest fundamental frequency.
2. Radiated emissions measured in frequency above 1000MHz were made with an instrument using peak/average detector mode.
3. Average test would be performed if the peak result were greater than the average limit or as required by the applicant.
4. Data of measurement within this frequency range shown " --- " in the table above means the reading of emissions are attenuated more than 20dB below the permissible limits or the field strength is too small to be measured.
5. Measurements above show only up to 6 maximum emissions noted, or would be lesser, with " N/A " remark, if no specific emissions from the EUT are recorded (ie: margin>20dB from the applicable limit) and considered that's already beyond the background noise floor.
6. Margin (dB) = Remark result (dBuV/m) – Average limit (dBuV/m). Peak detector mode and average detector mode of the emission shown in Result column.
7. Average level=Peak level + Duty factor.
8. \*=Restricted bands of operation

## 7.4 POWERLINE CONDUCTED EMISSIONS

### LIMIT

According to §15.207(a), except as shown in paragraphs (b) and (c) of this section, for an intentional radiator that is designed to be connected to the public utility (AC) power line, the radio frequency voltage that is conducted back onto the AC power line on any frequency or frequencies within the band 150 kHz to 30 MHz shall not exceed the limits in the following table, as measured using a 50  $\mu$ H/50 ohms line impedance stabilization network (LISN). Compliance with the provisions of this paragraph shall be based on the measurement of the radio frequency voltage between each power line and ground at the power terminal. The lower limit applies at the boundary between the frequency ranges.

Frequency Range (MHz)	Limits (dB $\mu$ V)	
	Quasi-peak	Average
0.15 to 0.50	66 to 56	56 to 46
0.50 to 5	56	46
5 to 30	60	50

Compliance with this provision shall be based on the measurement of the radio frequency voltage between each power line (LINE and NEUTRAL) and ground at the power terminals.

### MEASUREMENT EQUIPMENT USED

Conducted Emission room #1					
Name of Equipment	Manufacturer	Model	Serial Number	Calibration Date	Calibration Due
-	-	-	-	-	-
-	-	-	-	-	-
-	-	-	-	-	-
-	-	-	-	-	-
-	-	-	-	-	-
Test S/W	-				

**Remark:** Each piece of equipment is scheduled for calibration once a year.

### TEST RESULTS

※ This EUT is not connected to AC Source directly. No applicability for this test.

===End of Test Report===