

SPECIFICATION

Part No.	: GW.71.5153
Product Name	: 2.4GHz/5.8GHz Terminal Mount Dipole Antenna for ISM Band and WLAN IEEE 802.11a/b/g/h
Feature	: 5dBi High Performance Antenna RP-SMA(M) Hinged Antenna RoHS Compliant



1. Introduction

Many module manufacturers specify peak gain limits for any antennas that are to be connected to that module. Those peak gain limits are based on free-space conditions. In practice, the peak gain of an antenna tested in free-space can degrade by at least 1 or 2dBi when put inside a device. So ideally you should go for a slightly higher peak gain antenna than mentioned on the module specification to compensate for this effect, giving you better performance.

Upon testing of any of our antennas with your device and a selection of appropriate layout, integration technique, or cable, Taoglas can make sure any of our antennas' peak gain will be below the peak gain limits. Taoglas can then issue a specification and/or report for the selected antenna in your device that will clearly show it complying with the peak gain limits, so you can be assured you are meeting regulatory requirements for that module.

For example, a module manufacturer may state that the antenna must have less than 2dBi peak gain, but you don't need to select an embedded antenna that has a peak gain of less than 2dBi in free-space. This will give you a less optimized solution. It is better to go for a slightly higher free-space peak gain of 3dBi or more if available. Once that antenna gets integrated into your device, performance will degrade below this 2dBi peak gain due to the effects of GND plane, surrounding components, and device housing. If you want to be absolutely sure, contact Taoglas and we will test. Choosing a Taoglas antenna with a higher peak gain than what is specified by the module manufacturer and enlisting our help will ensure you are getting the best performance possible without exceeding the peak gain limits.

2. Specification

ELECTRICAL		
Frequency	2.4 ~ 2.5GHz,	4.9 ~ 5.8GHz
VSWR	<2	<2.1
Peak Gain (straight)	3.3dBi	4.9dBi
Peak Gain (bend)	3.8dBi	5.5dBi
Average Gain (straight)	-0.9dBi	-1.5dBi
Average Gain (bend)	-0.7dBi	-0.0dBi
Efficiency (straight)	80%	71%
Efficiency (bend)	86%	83%
Polarization	Linear	
Impedance	50 Ohms	
Radiation Pattern	Omni	
Input Power	2W max.	
MECHANICAL		
Antenna Length	194mm	
Antenna Diameter	12.8mm	
Weight	24.6g	
Antenna Body Material	TPU	
ENVIRONMENTAL		
Temperature Range	-40°C to 85°C	
Humidity	Non-condensing 65°C 95% RH	

3. Antenna S11 Property

3.1. Return Loss

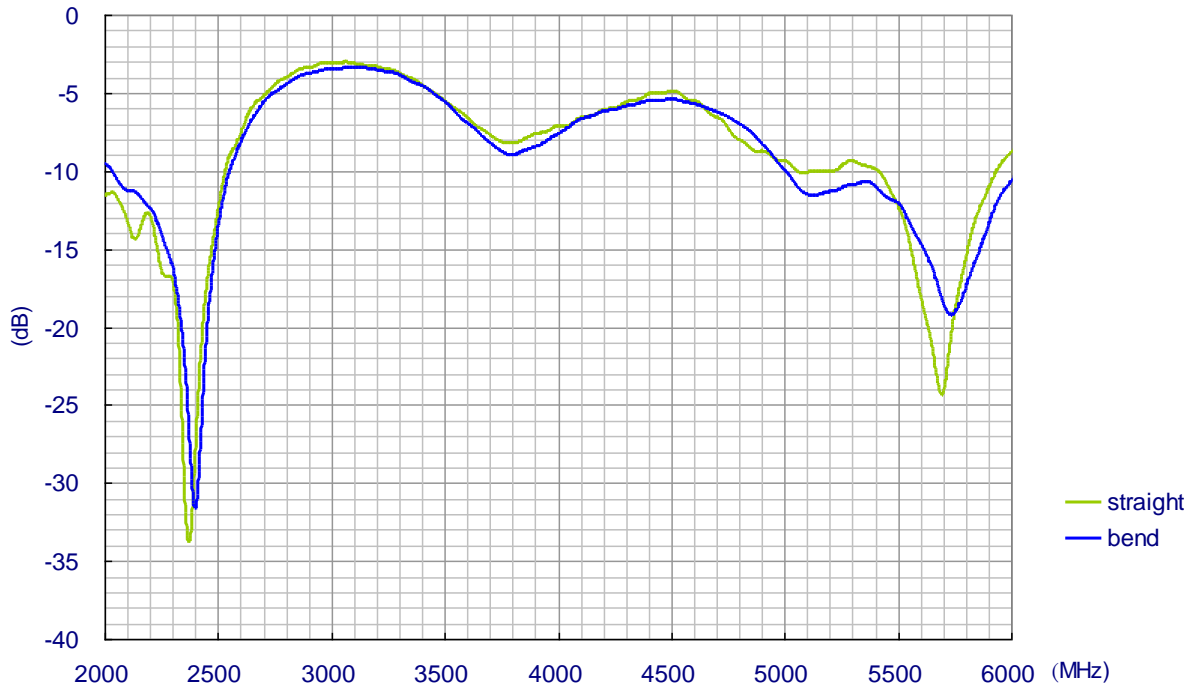

3.2. VSWR

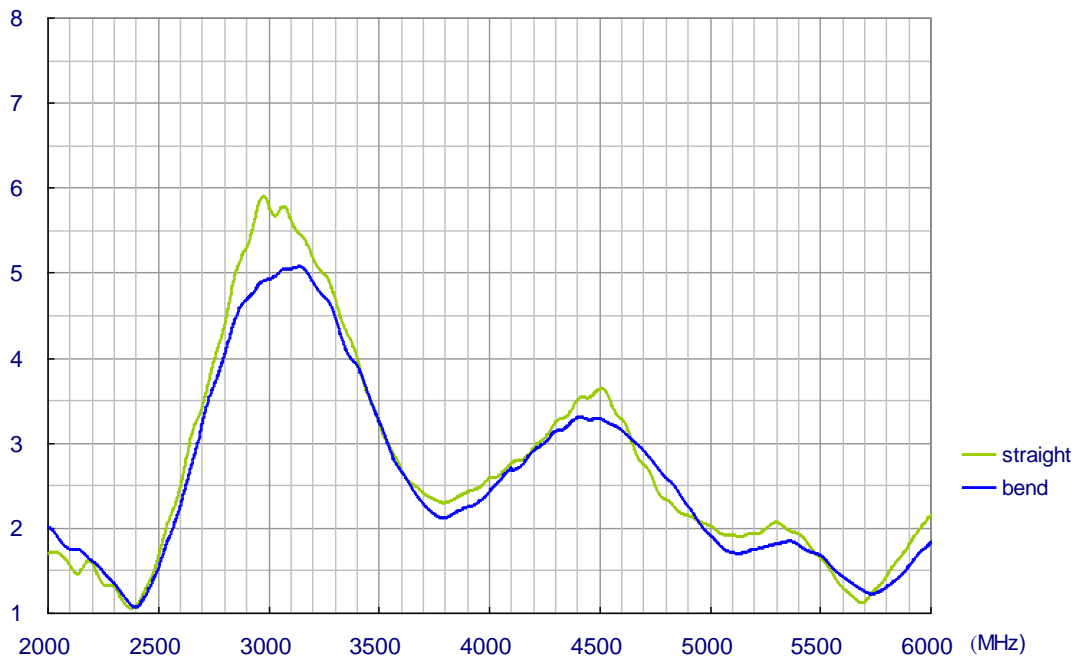

4. 3D Radiation Property

4.1. Radiation Efficiency

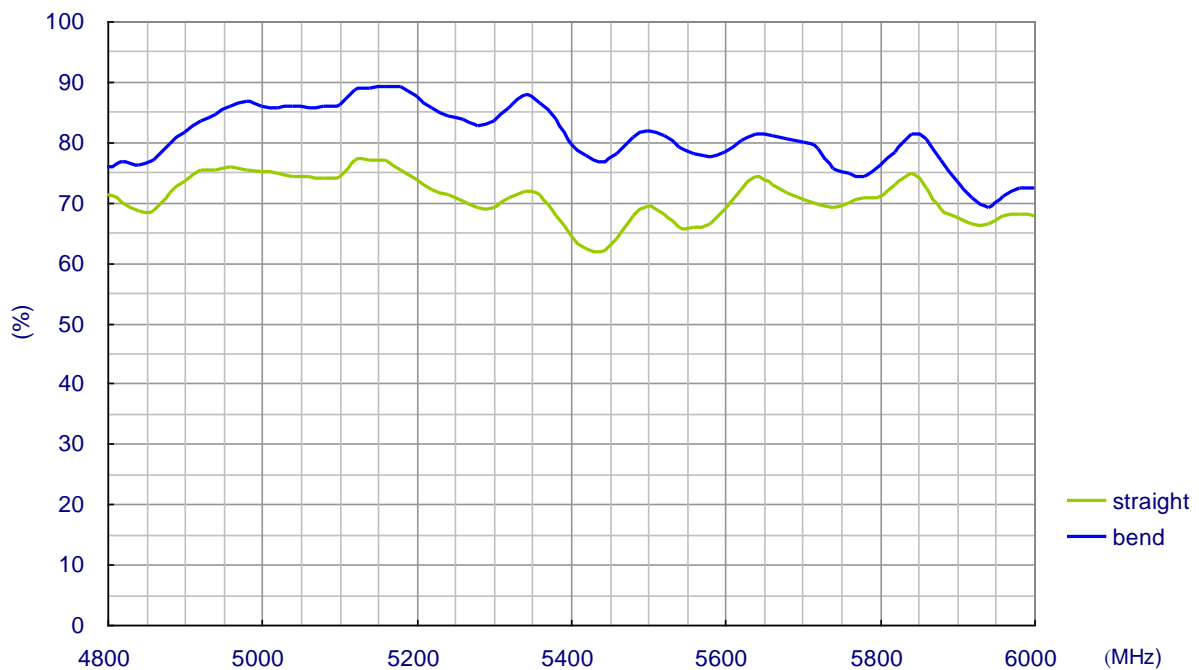
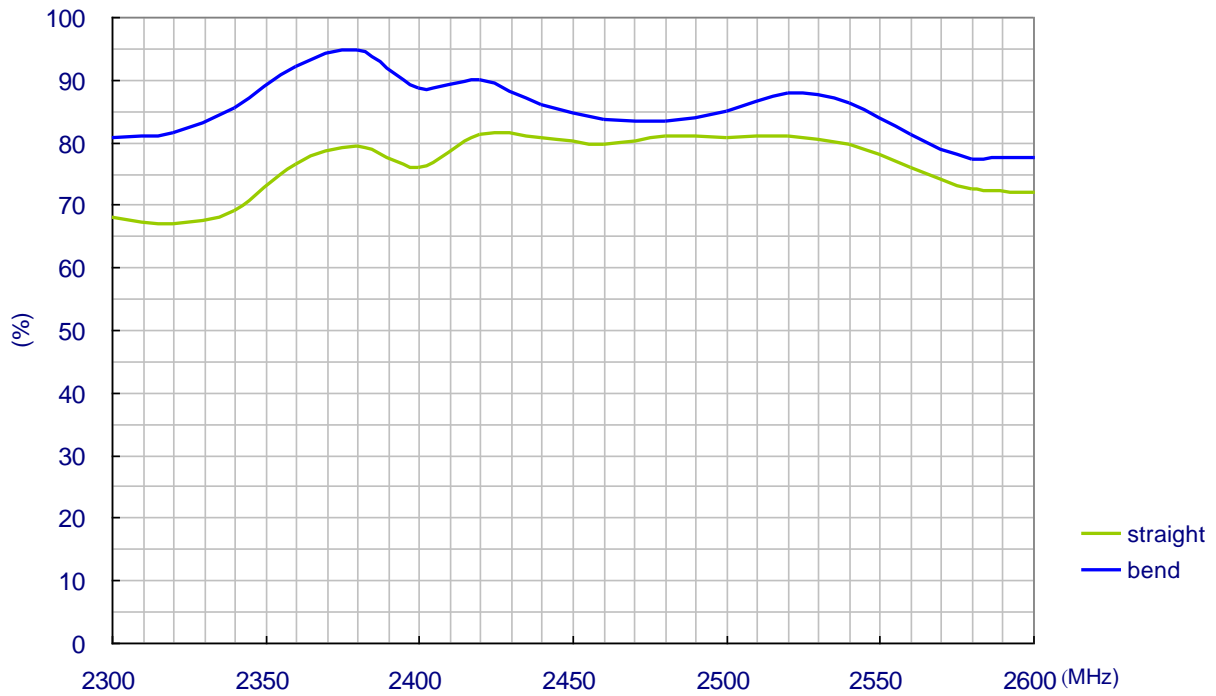

4.2. Peak Gain

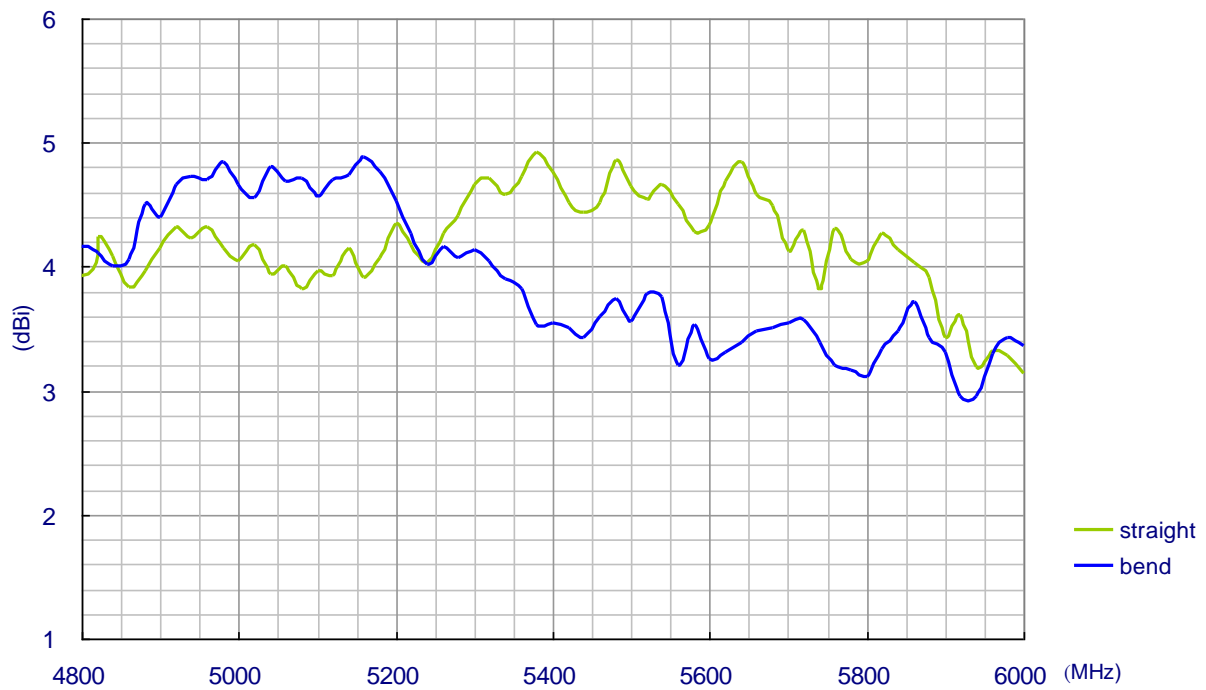
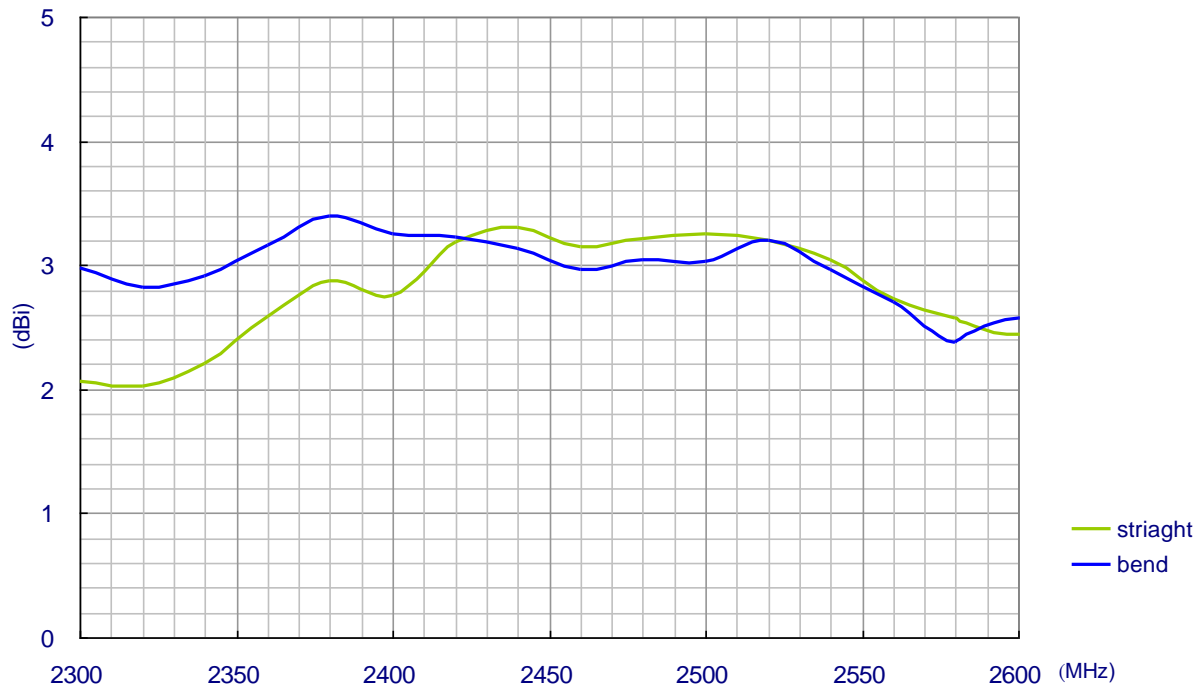

4.3. Average Gain

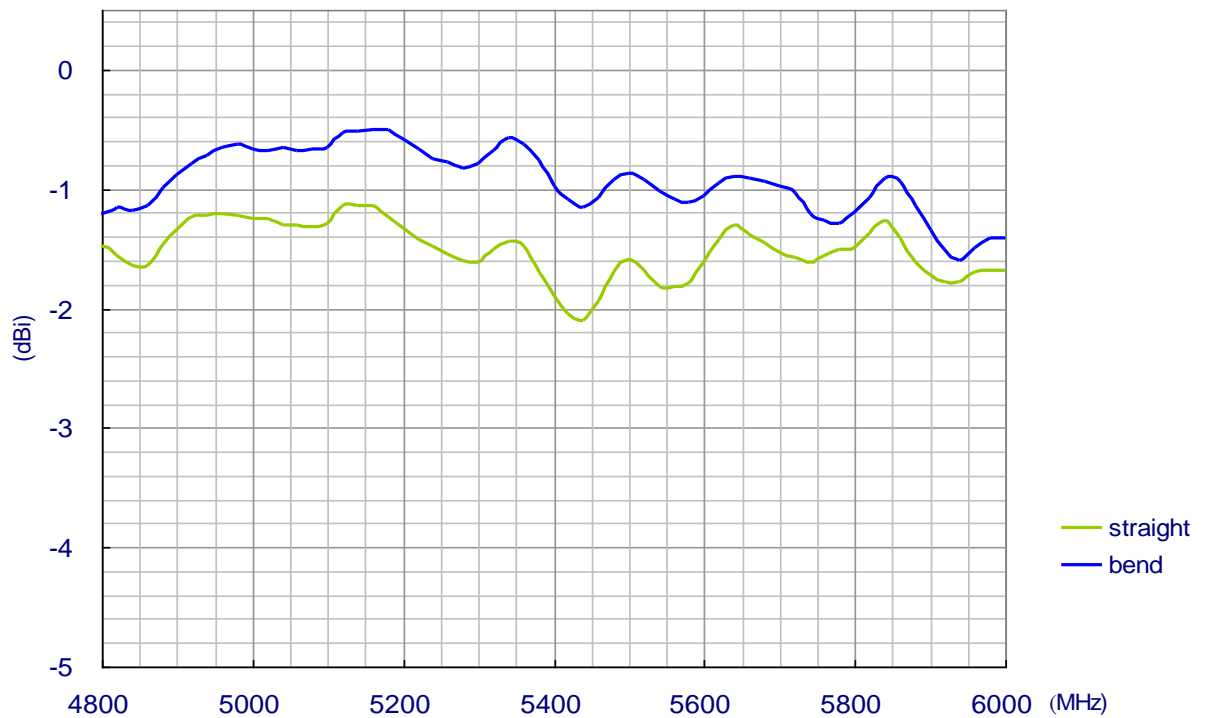
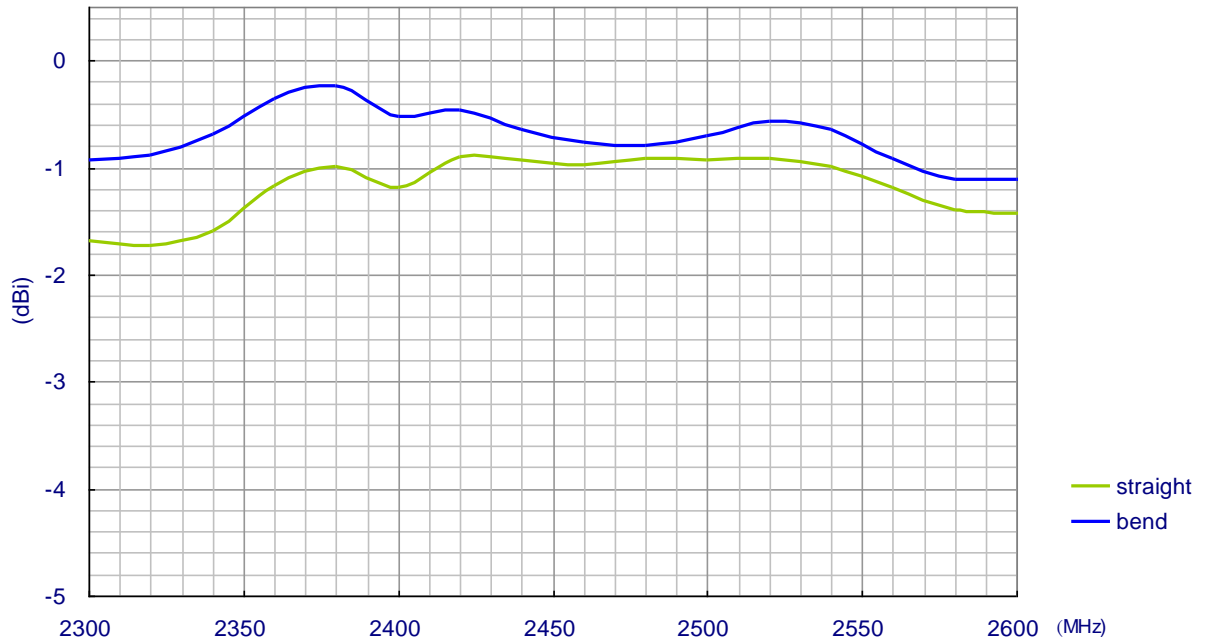

4.4. Radiation Pattern

E-Plane Radiation of Straight Position

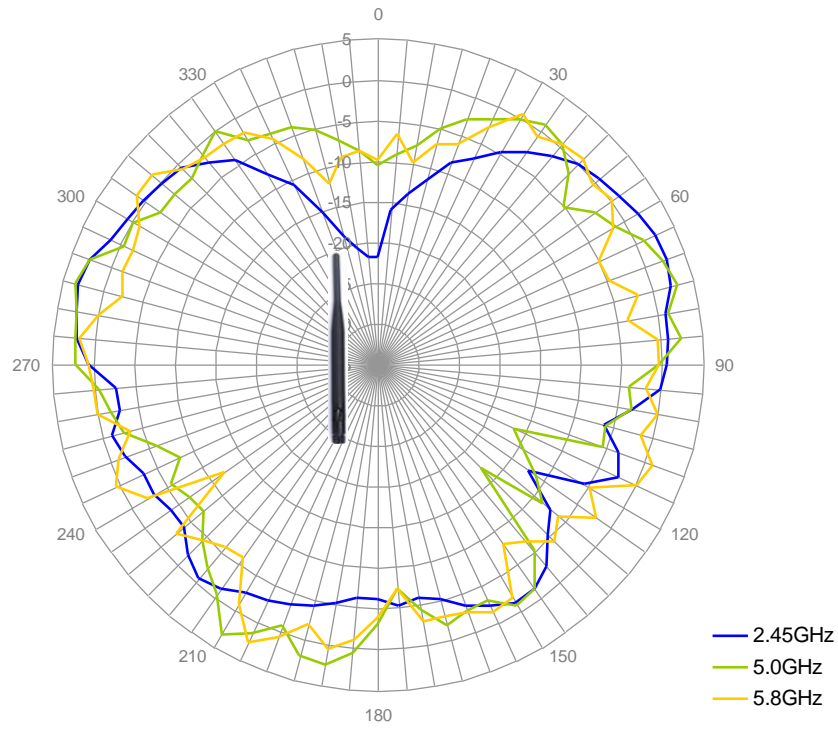

H-Plane Radiation of Straight Position

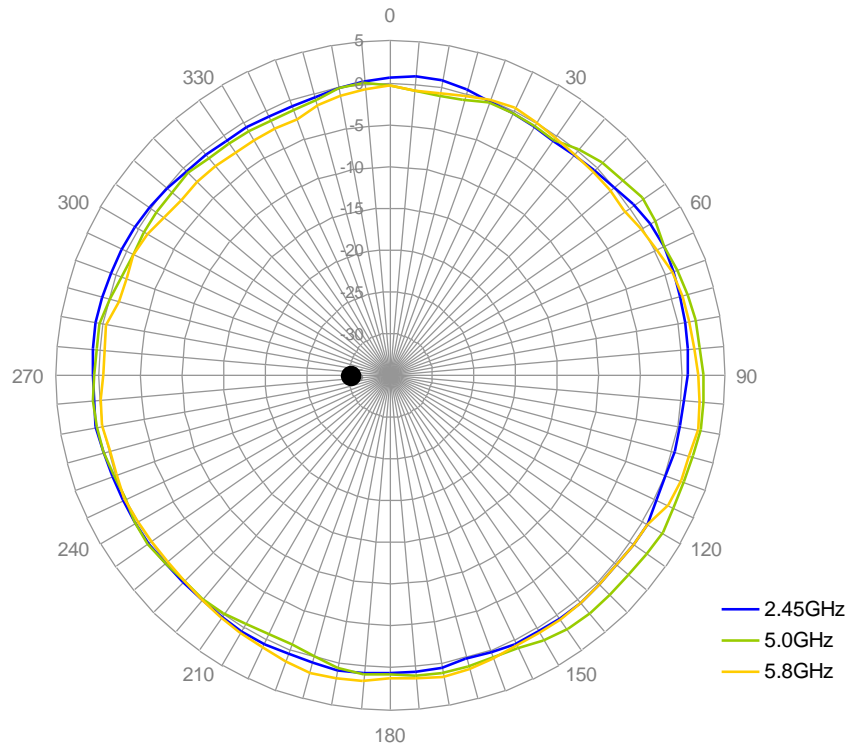

E-Plane Radiation of Bend Position

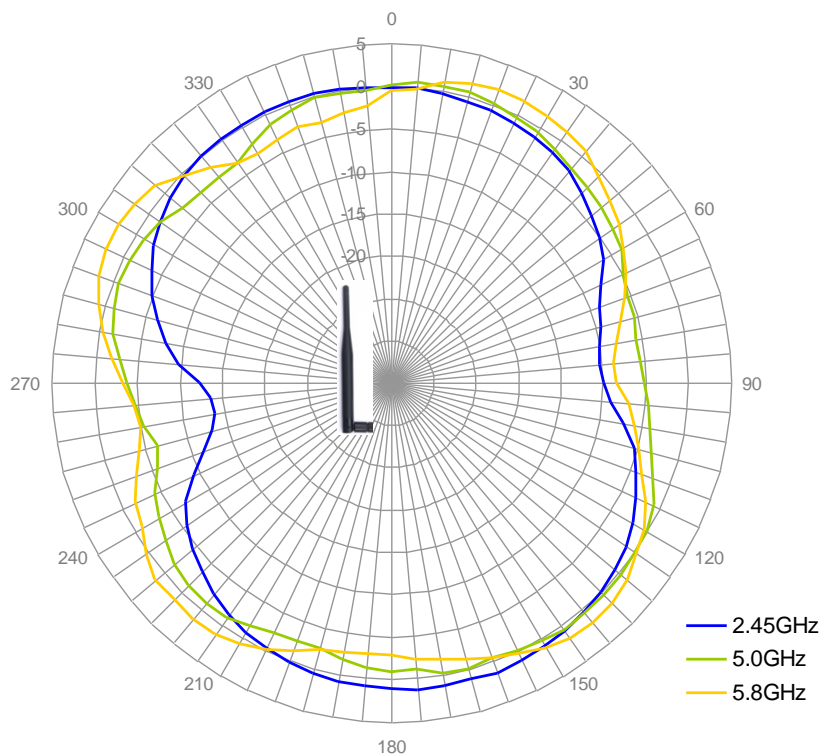

H-Plane Radiation of Bend Position

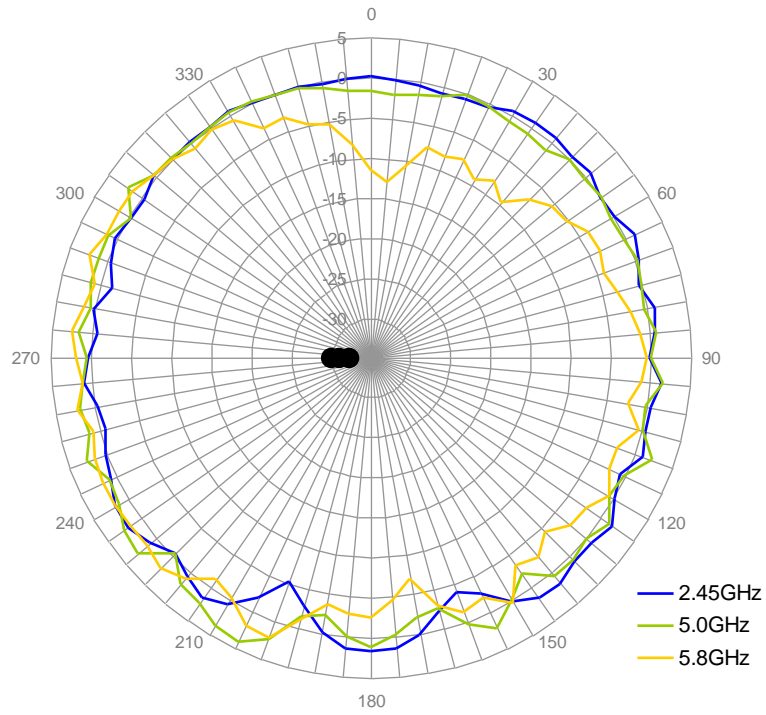

5. Ground Plane Effect

Three ground setups are used to see the affect of positioning GW.71 close to ground -

1. Small Ground (15 x 9cm) – common size of CPE devices. GW.71 is mounted at the longer edge for testing.
2. Big Ground Edge (45 x 30cm) – simulate the effect of mounting antenna on a base station device. GW.71 is mounted at the centre of the longer edge.
3. Big Ground Centre (45 x 30cm) – simulate the effect of mounting antenna in a centre of a big ground plane, such as vehicle top.

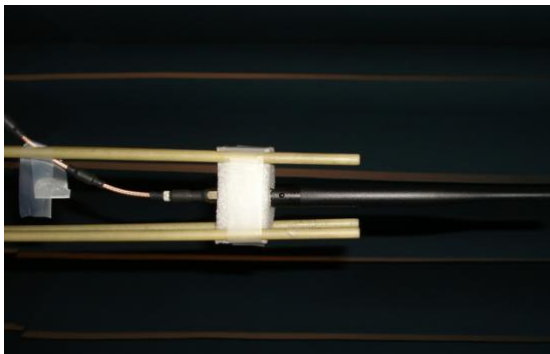

Free space



Small ground edge

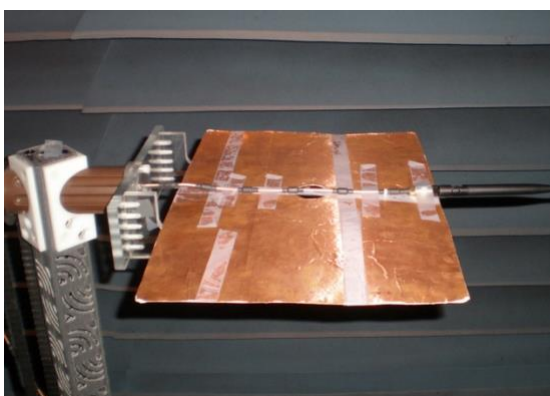

Big ground edge

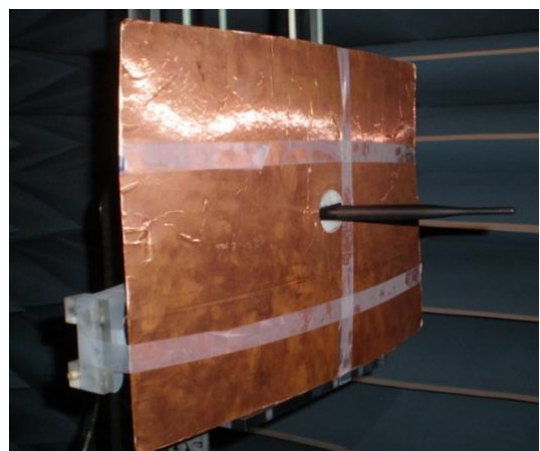

Big ground center

6. Radiation Property of GW.71 with Different Ground

6.1. Radiation Efficiency of Straight GW.71

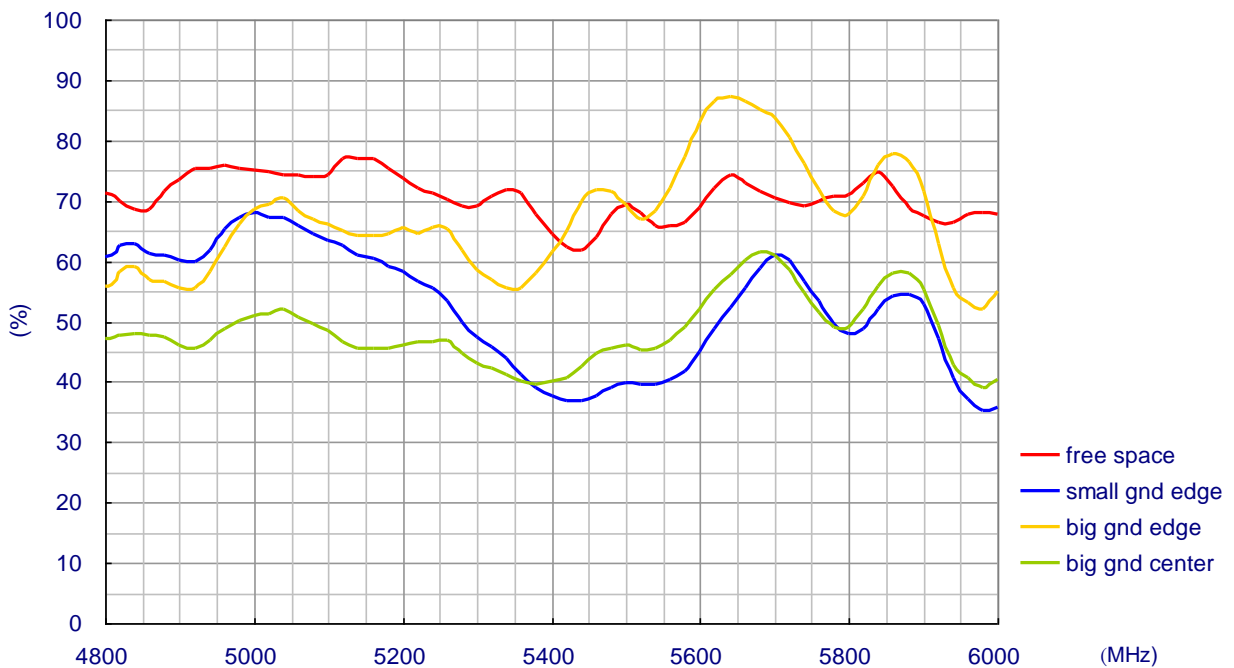
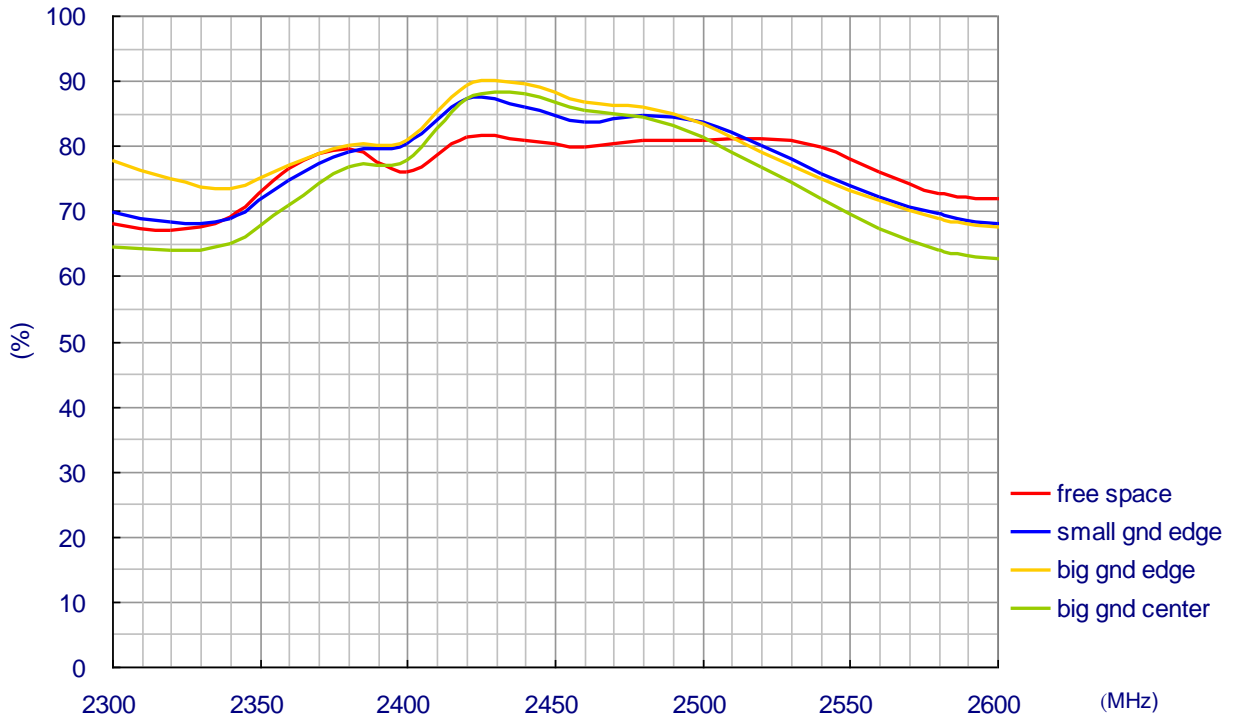

6.2. Radiation Efficiency of Bend GW.71

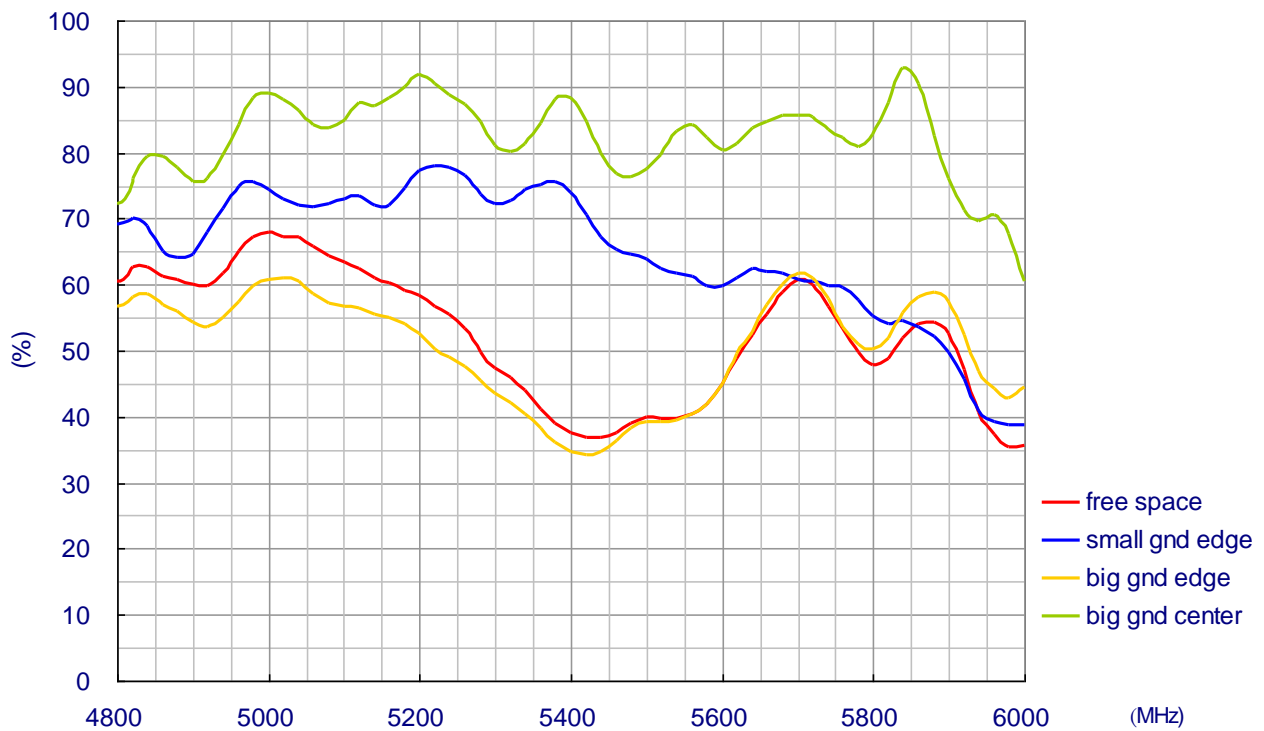
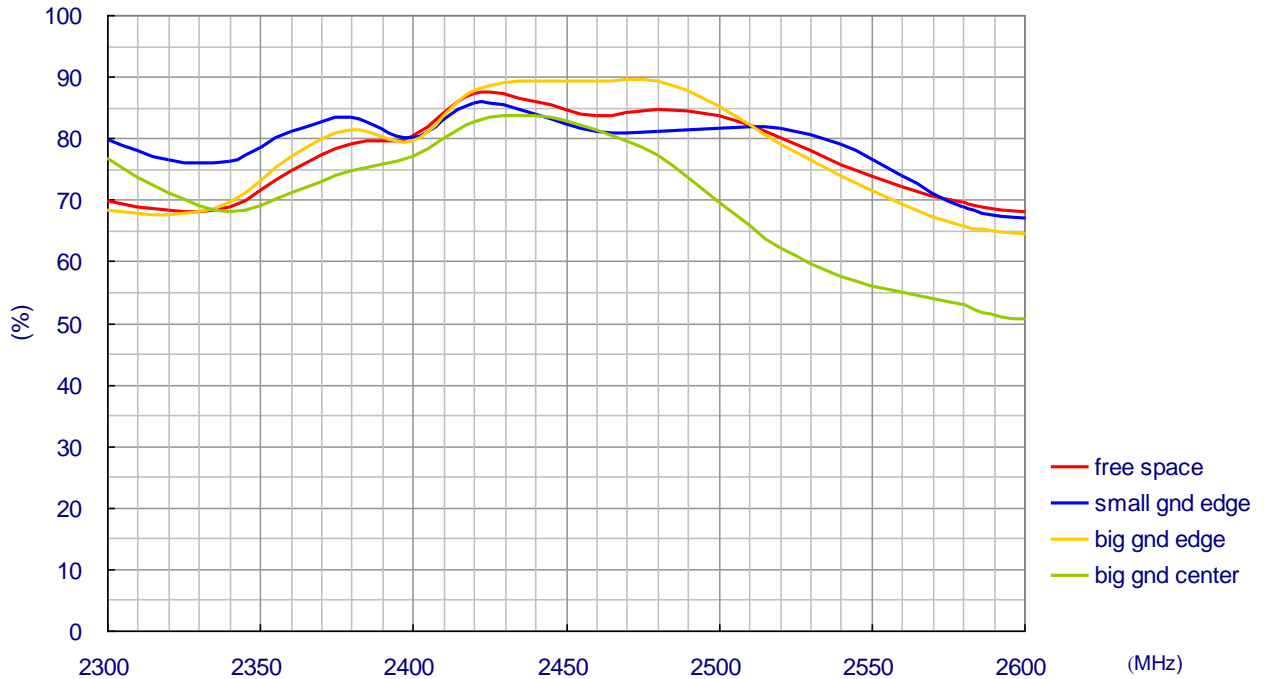

6.3. Peak Gain of Straight GW.71

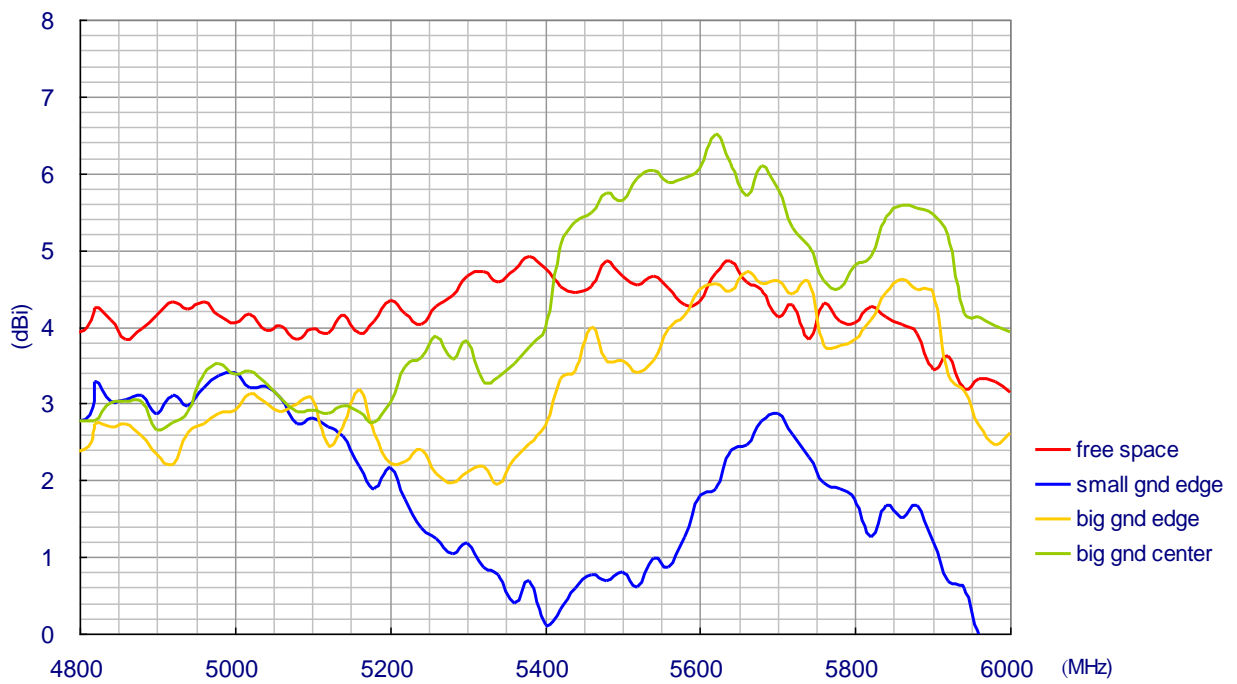
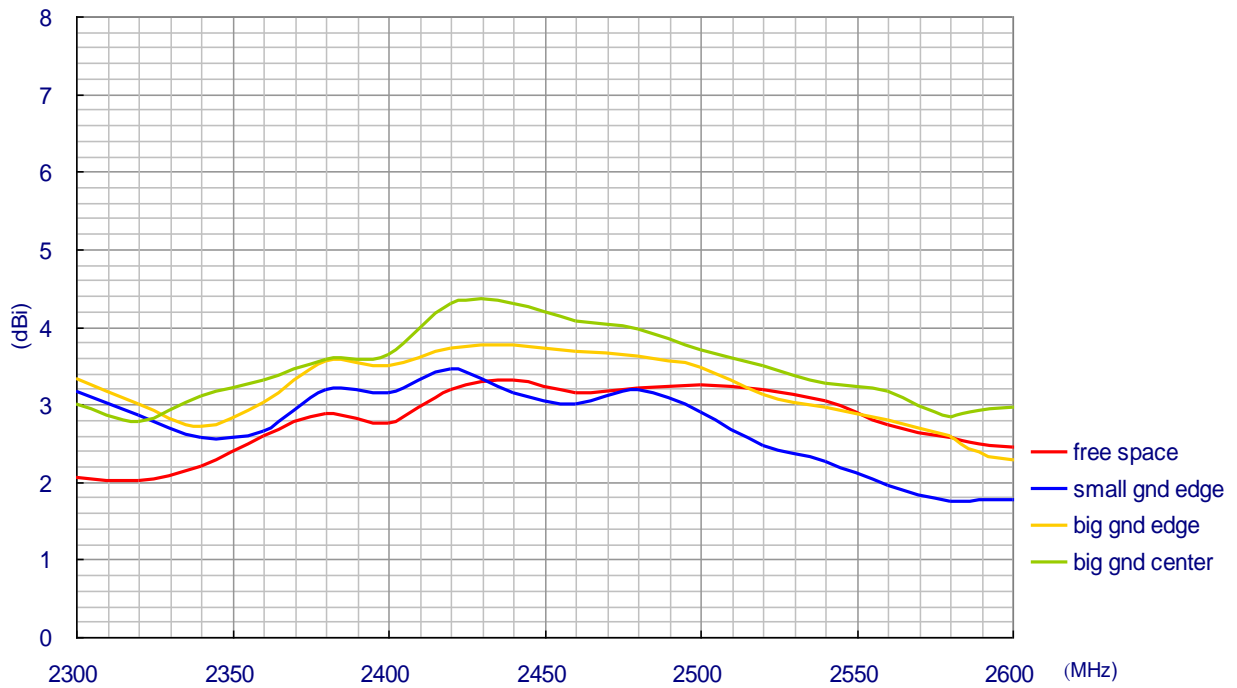

6.4. Peak Gain of Bend GW.71

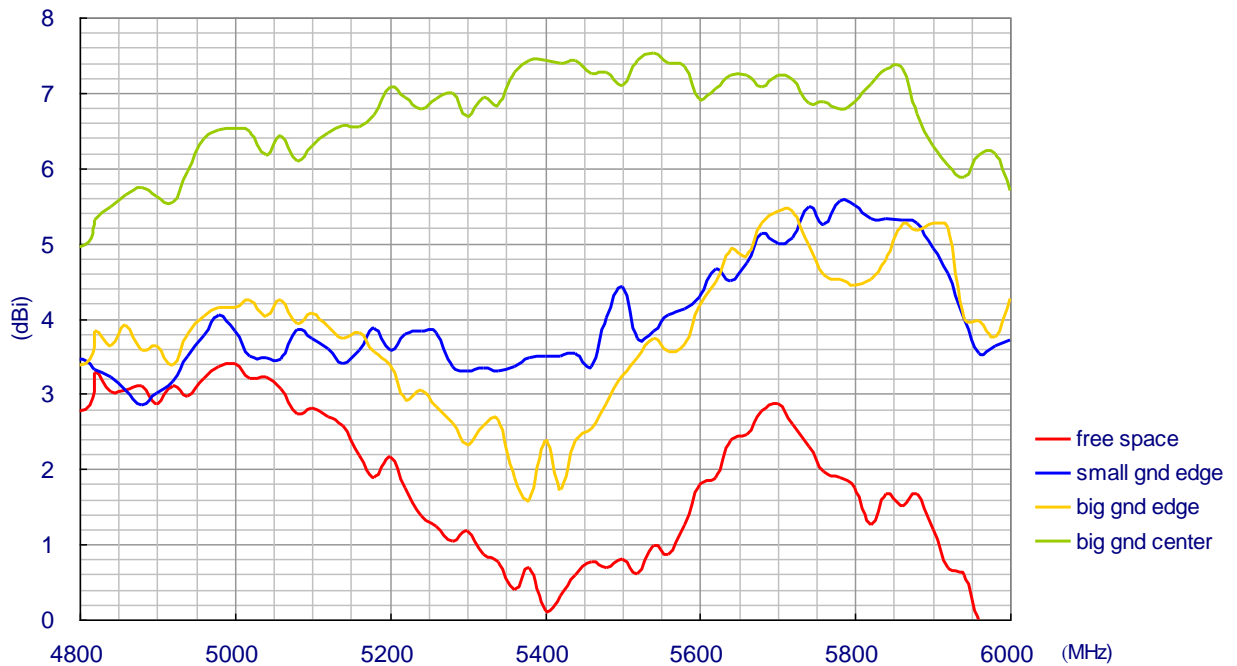
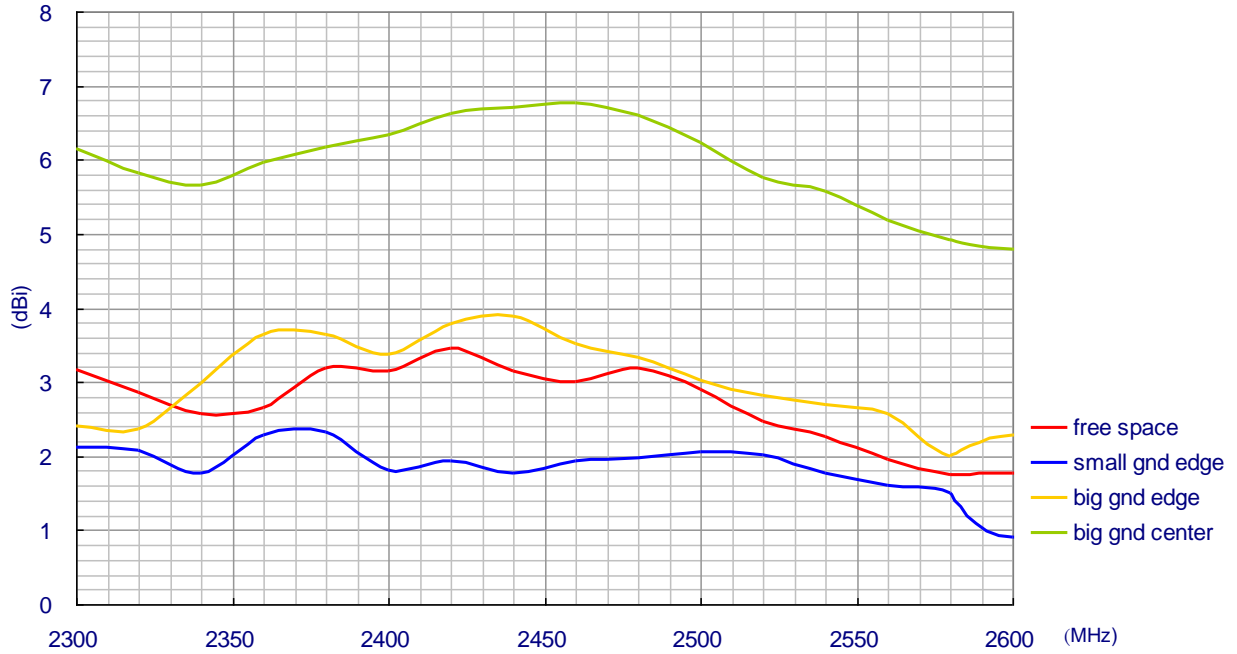

6.5. Average Gain of Straight GW.71

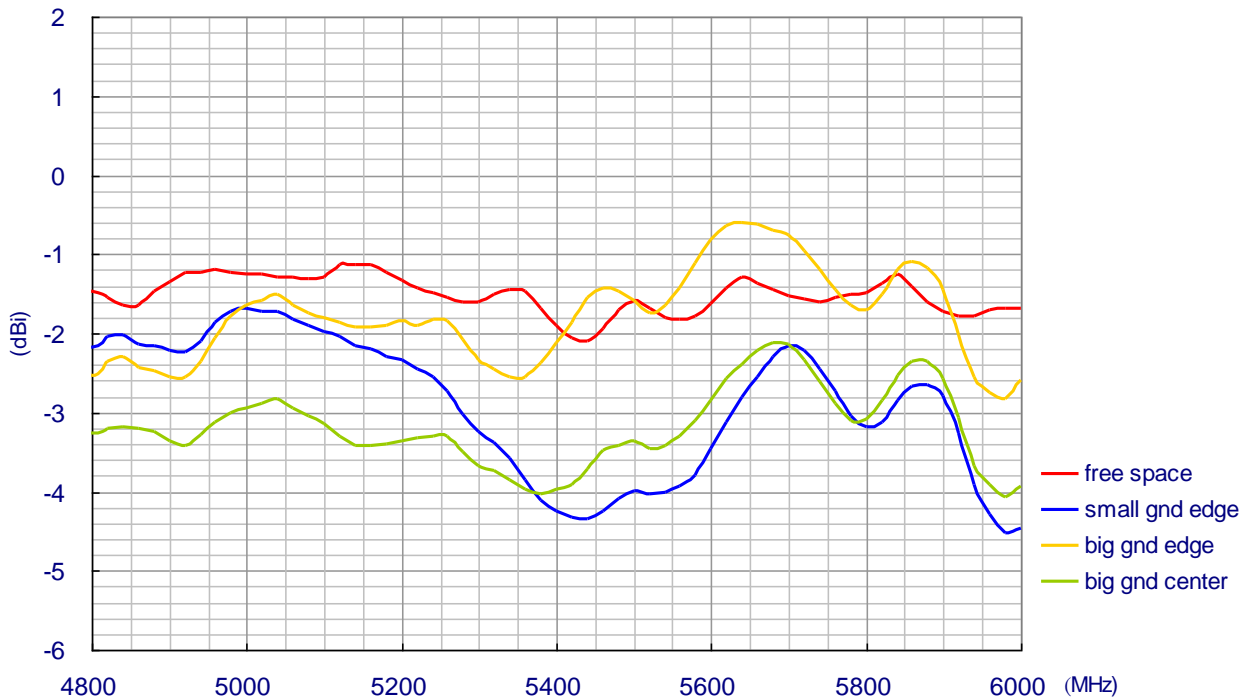
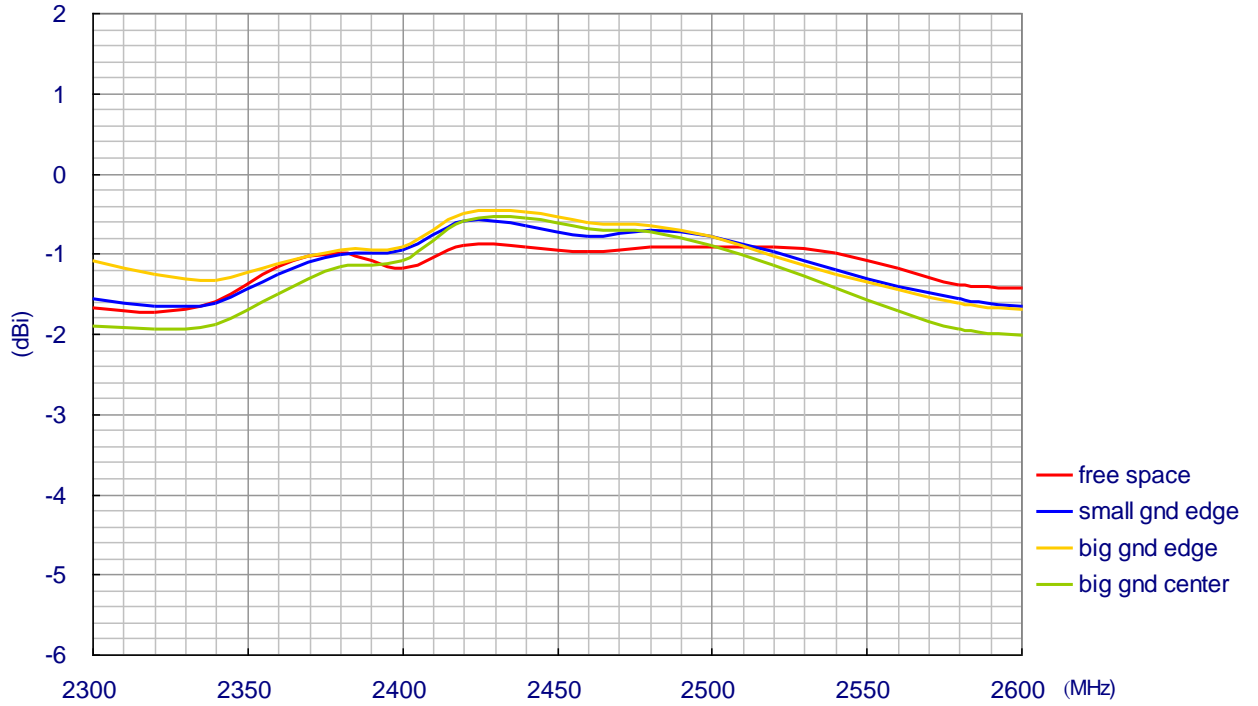

6.6. Average Gain of Bend GW.71

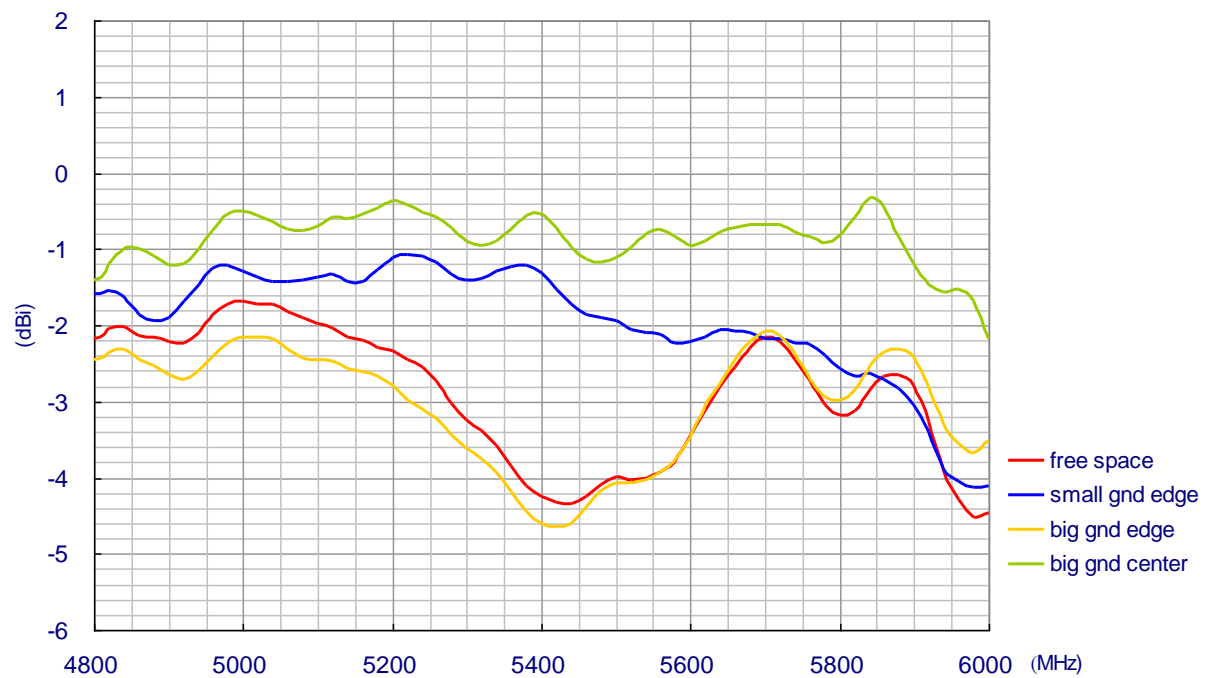
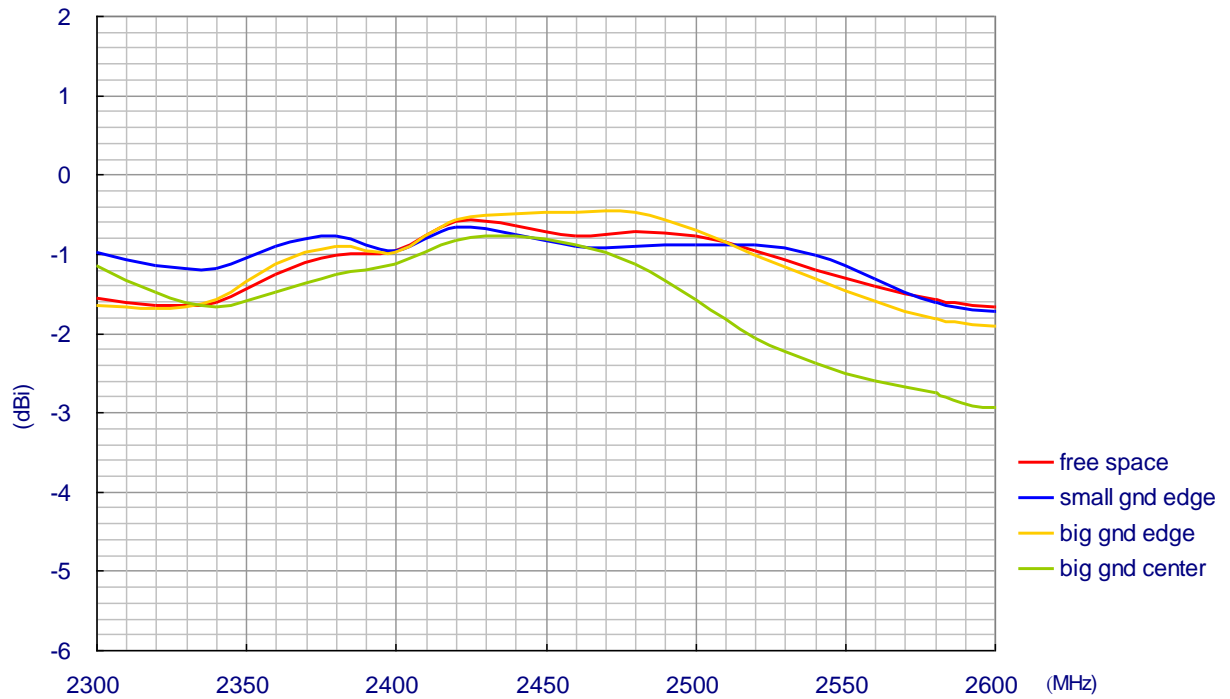

6.7. Radiation Pattern of Straight GW.71 at 2.45GHz

E-Plane Radiation

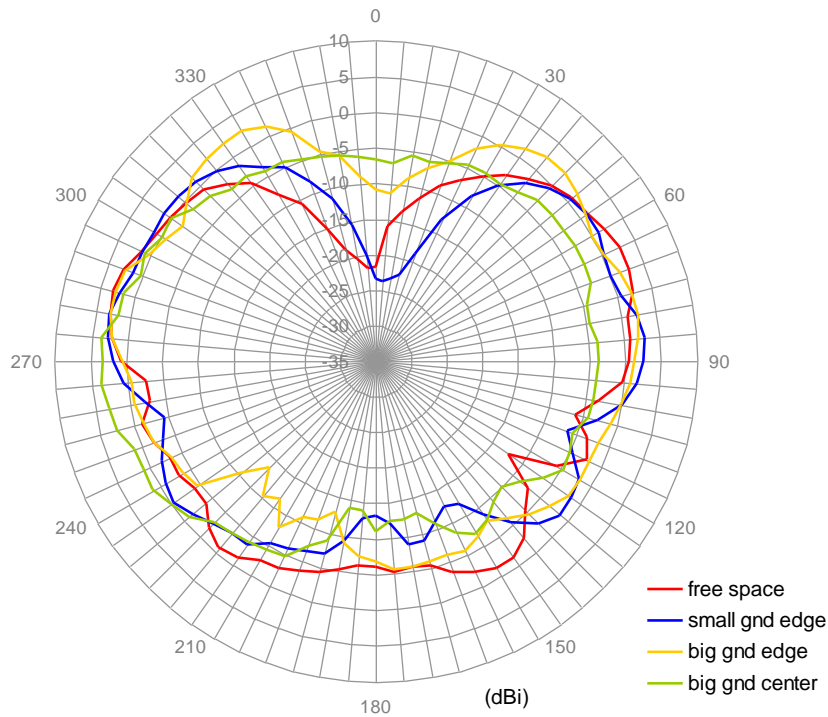

H-Plane Radiation

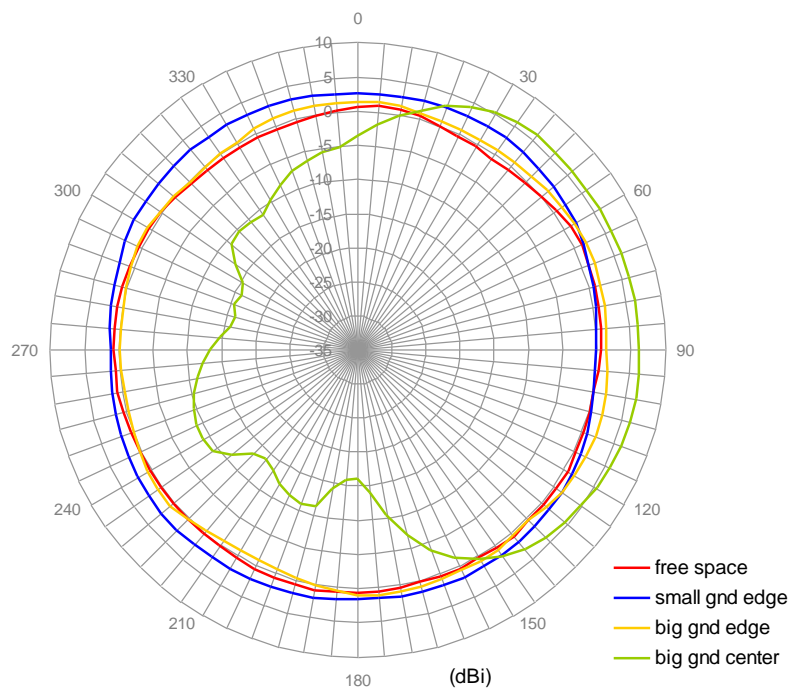

6.8. Radiation Pattern of Bend GW.71 at 2.45GHz

E-Plane Radiation

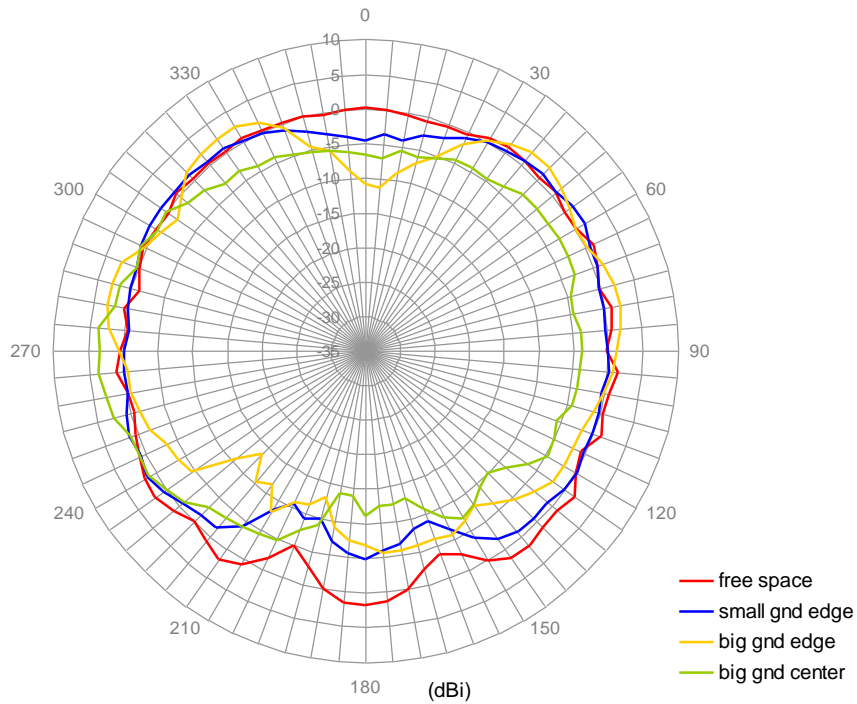

H-Plane Radiation

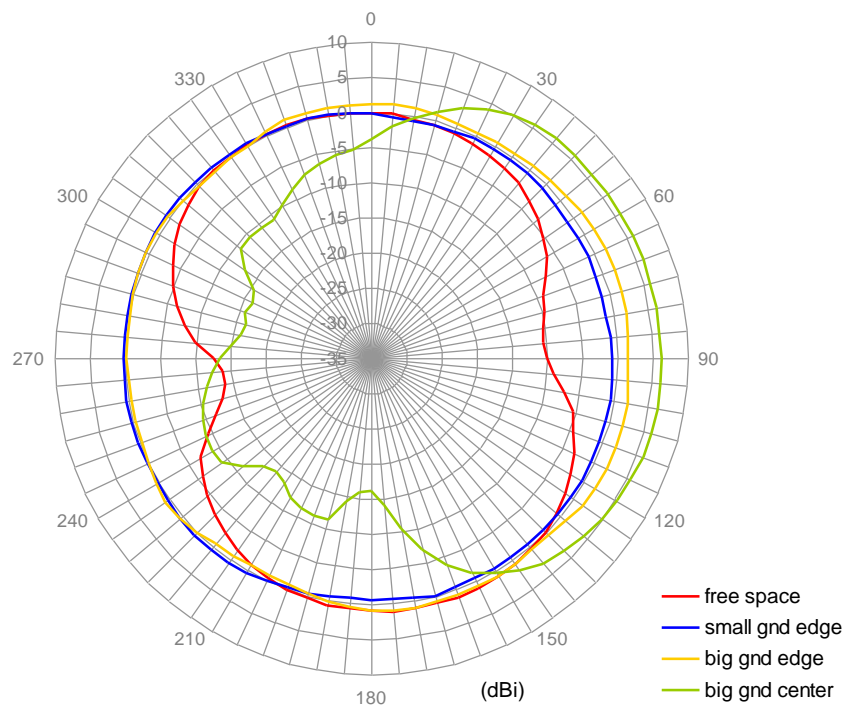

6.9. Radiation Pattern of Straight GW.71 at 5.0GHz

E-Plane Radiation

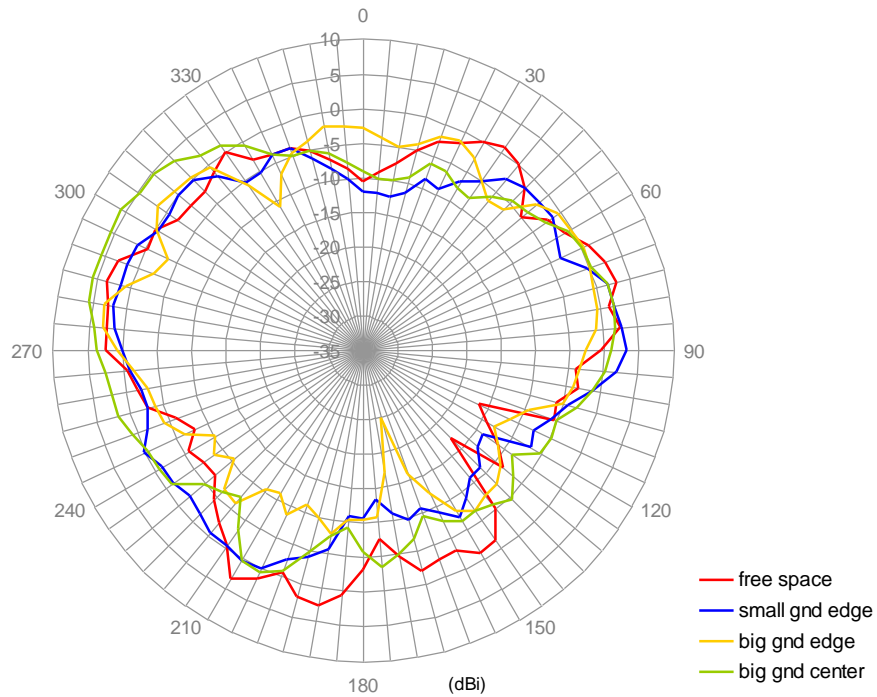

H-Plane Radiation

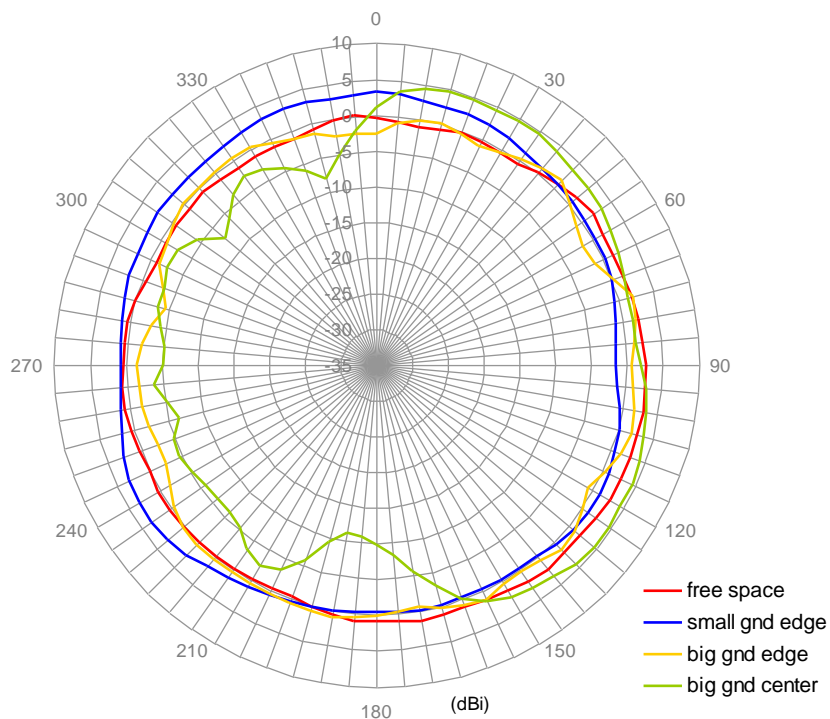

6.10. Radiation Pattern of Bend GW.71 at 5.0GHz

E-Plane Radiation

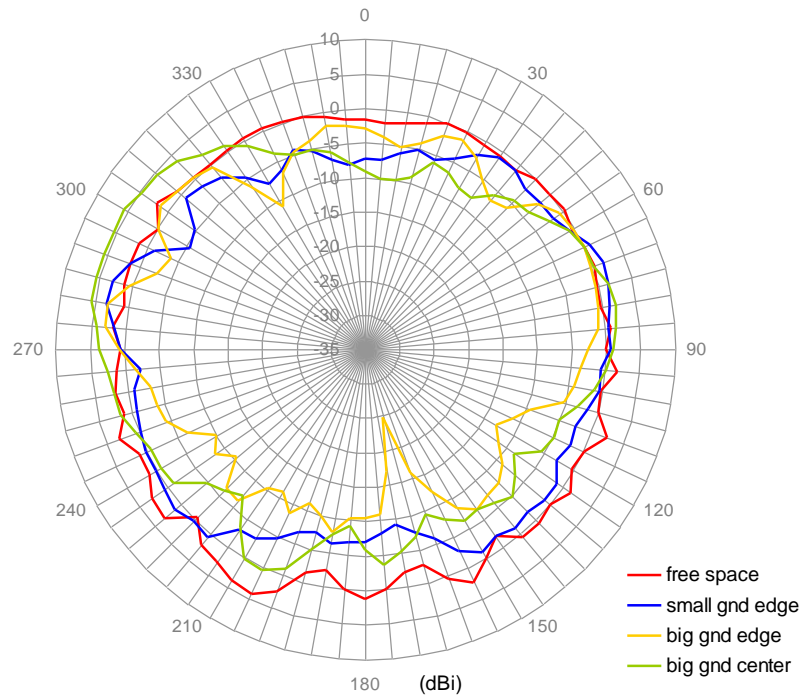

H-Plane Radiation

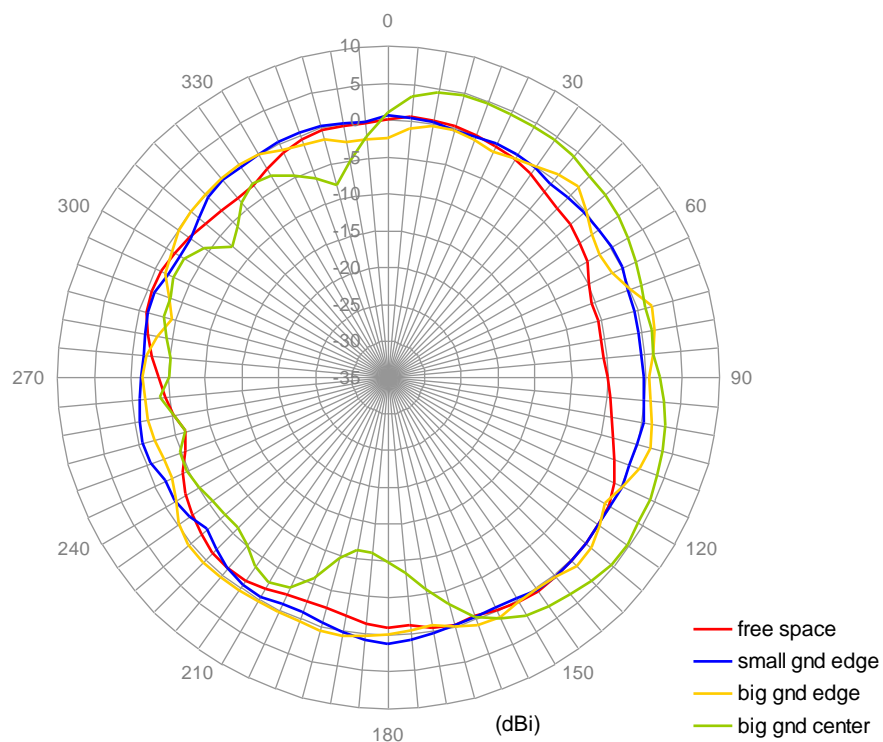

6.11. Radiation Pattern of Straight GW.71 at 5.8GHz

E-Plane Radiation

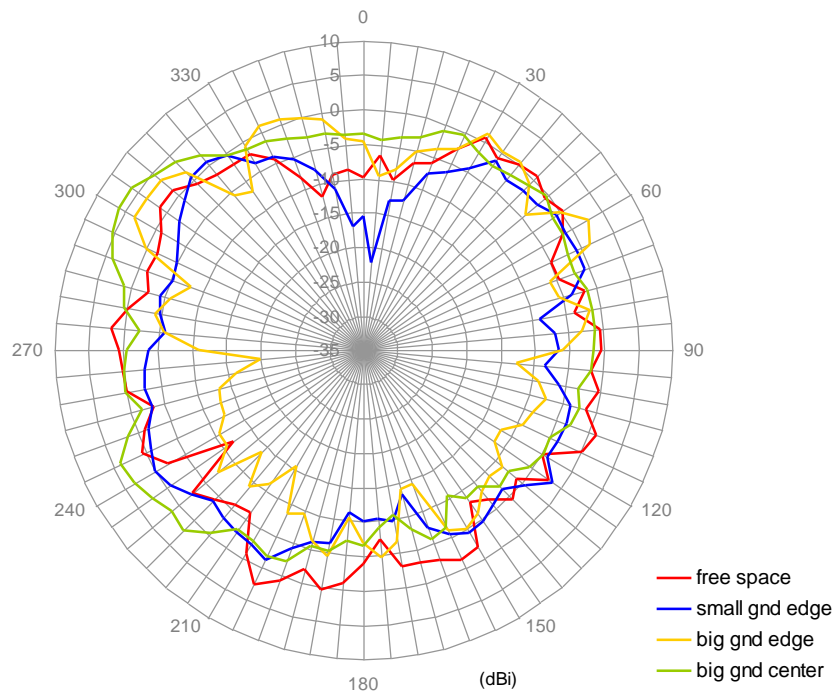

H-Plane Radiation

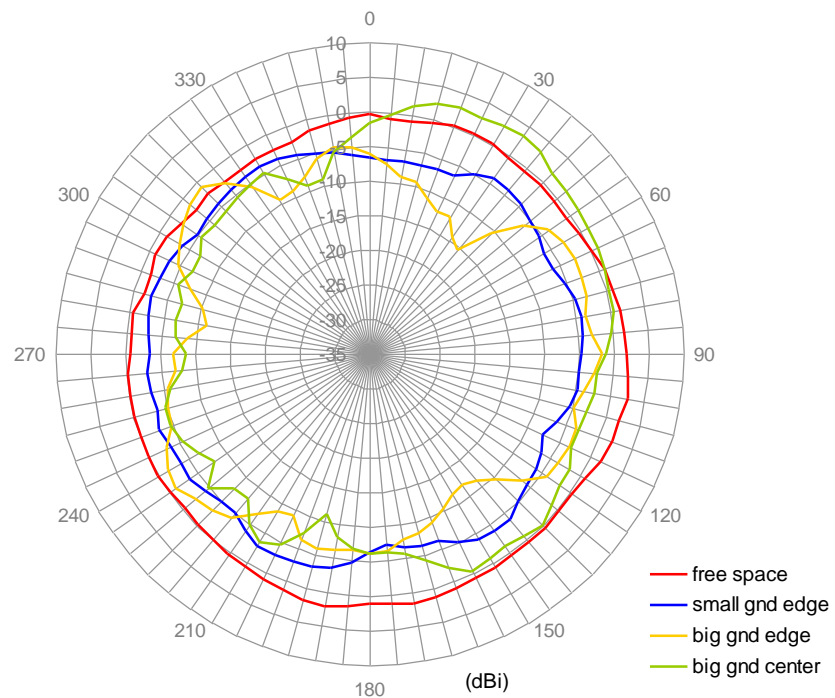

6.12. Radiation Pattern of Bend GW.71 at 5.8GHz

E-Plane Radiation

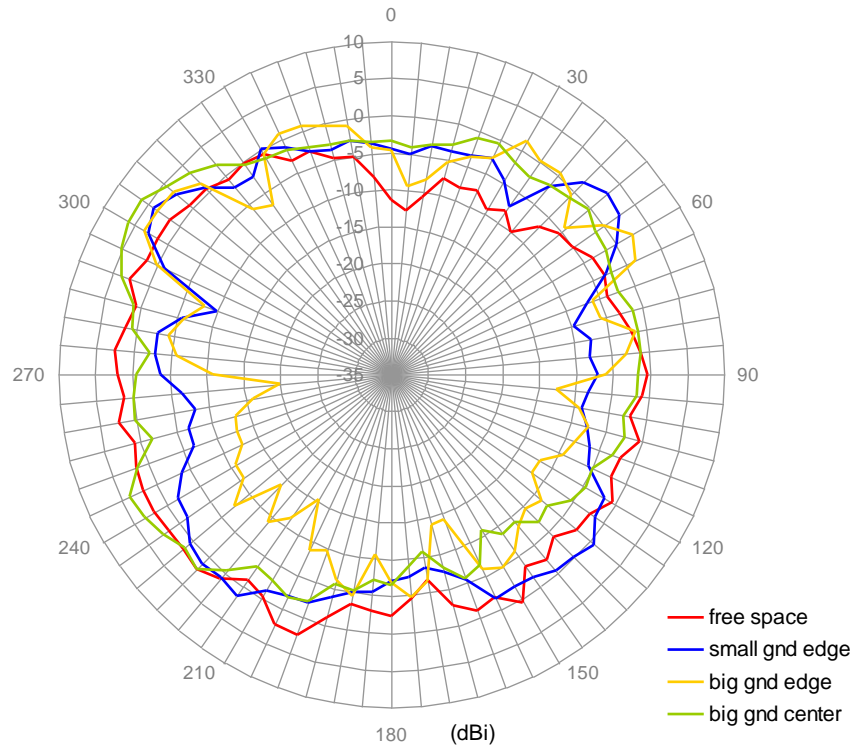

H-Plane Radiation

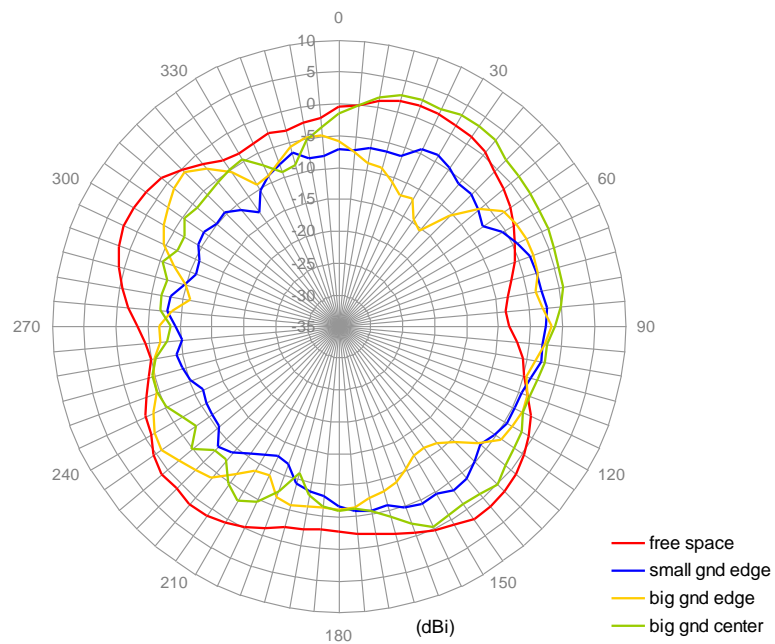

7. 3-D Radiation Patterns (Straight in free space)

2450MHz

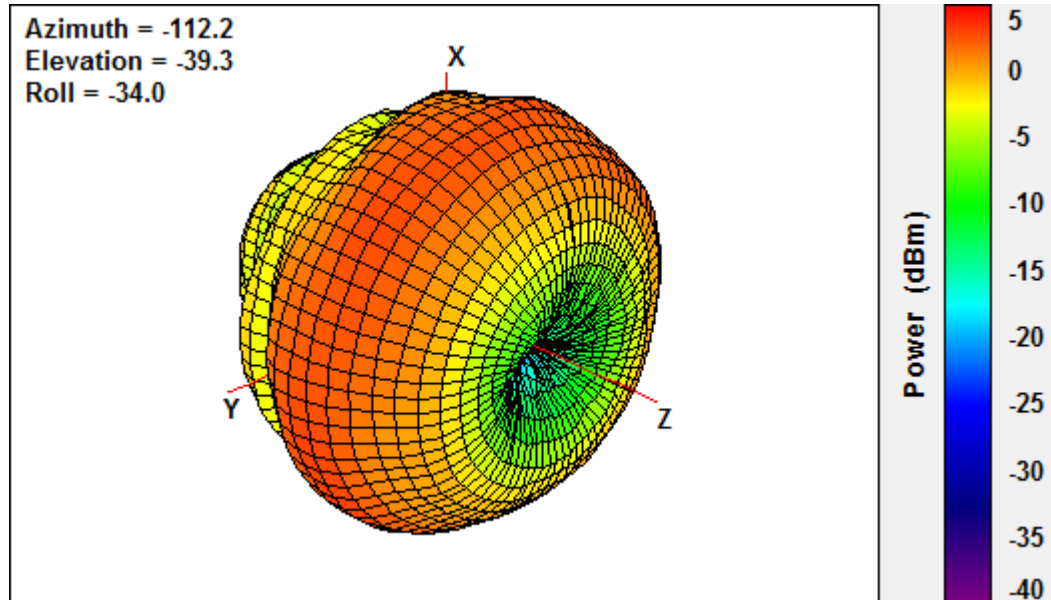
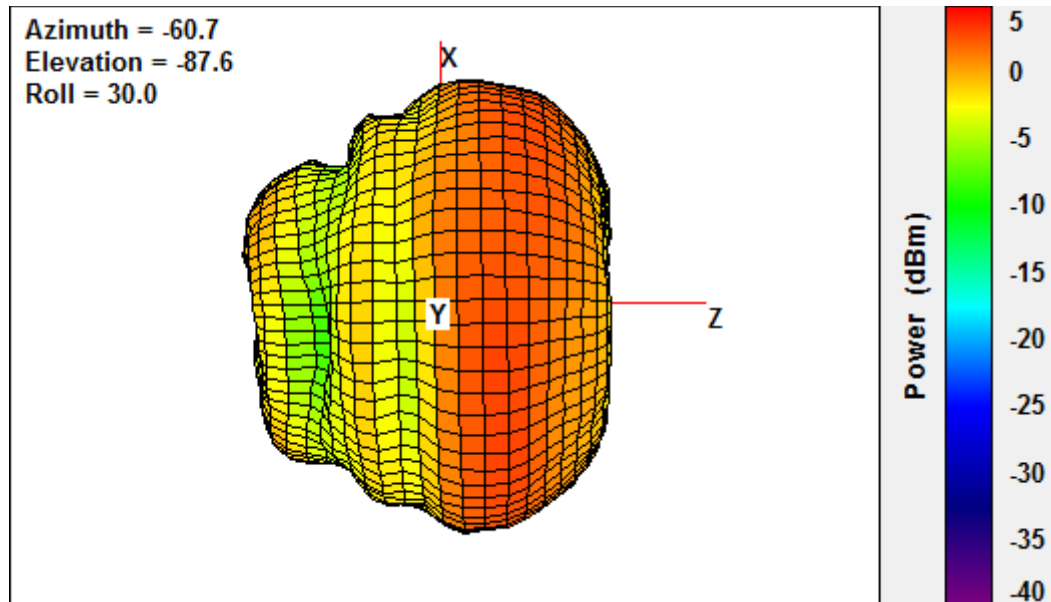

5000MHz

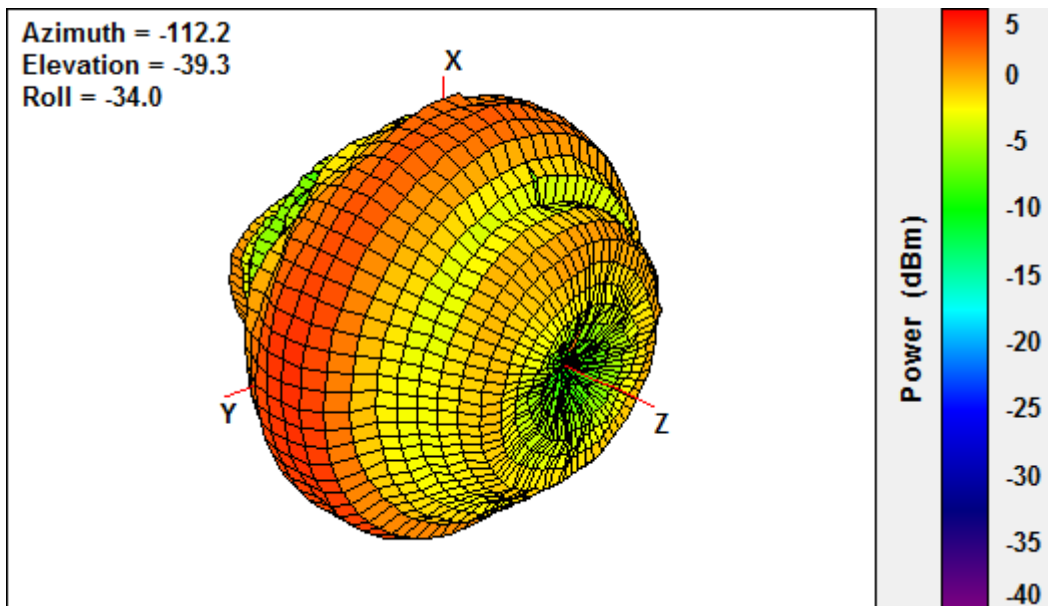
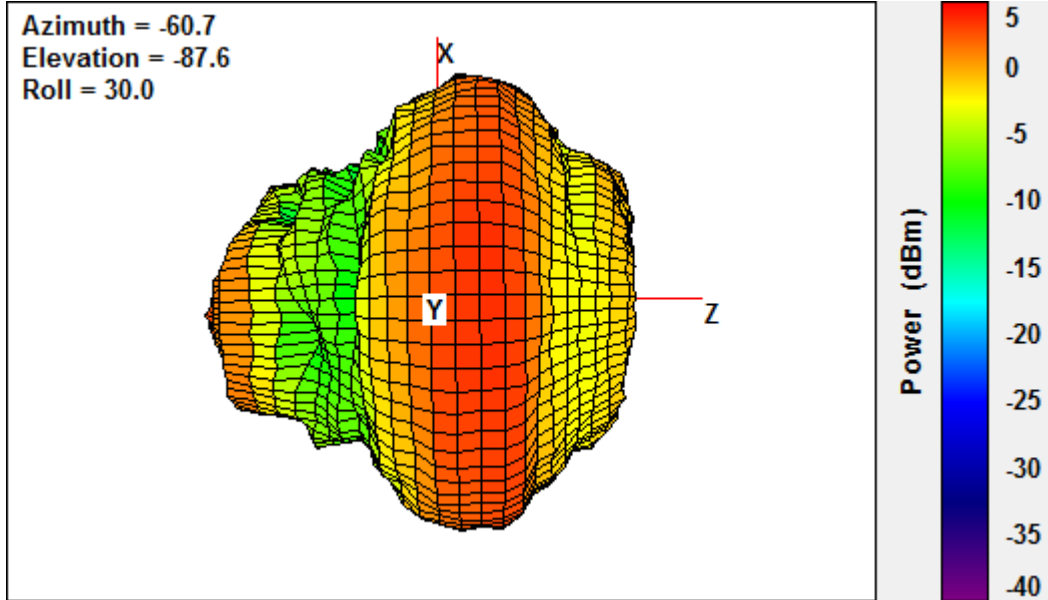

5800MHz

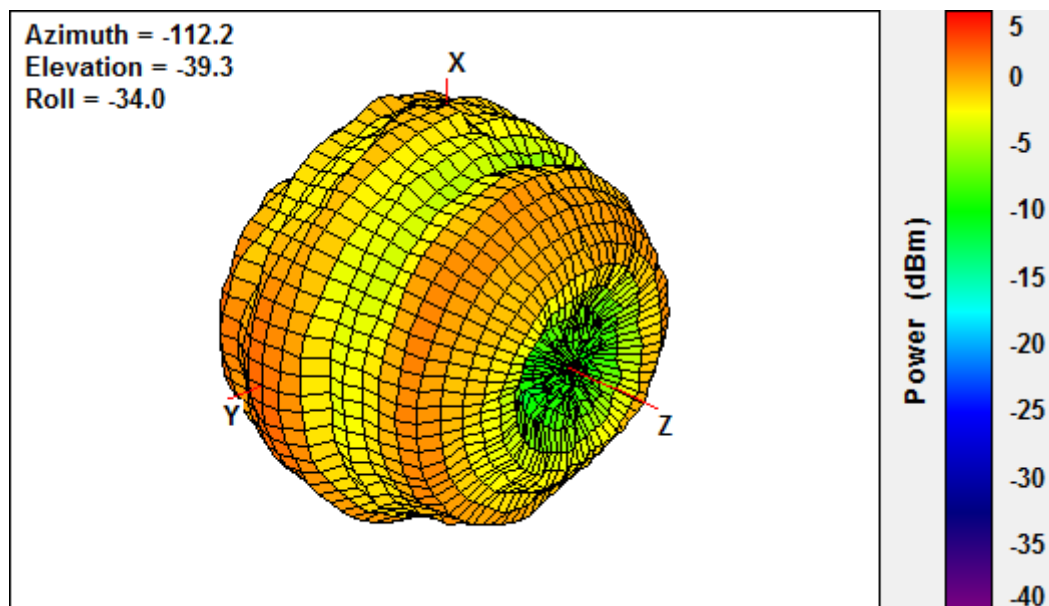
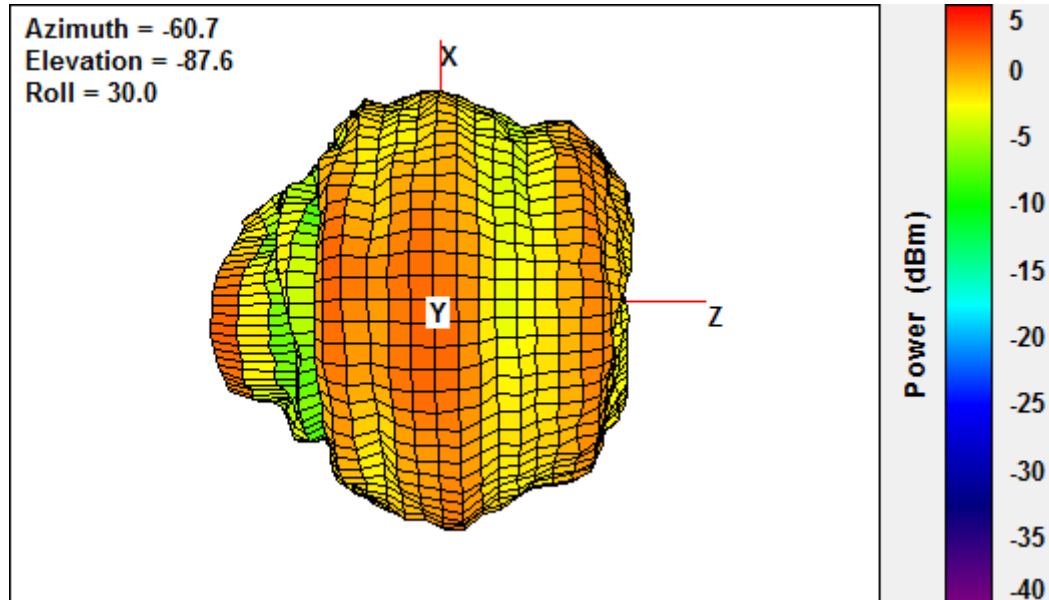

8. Antenna Drawing

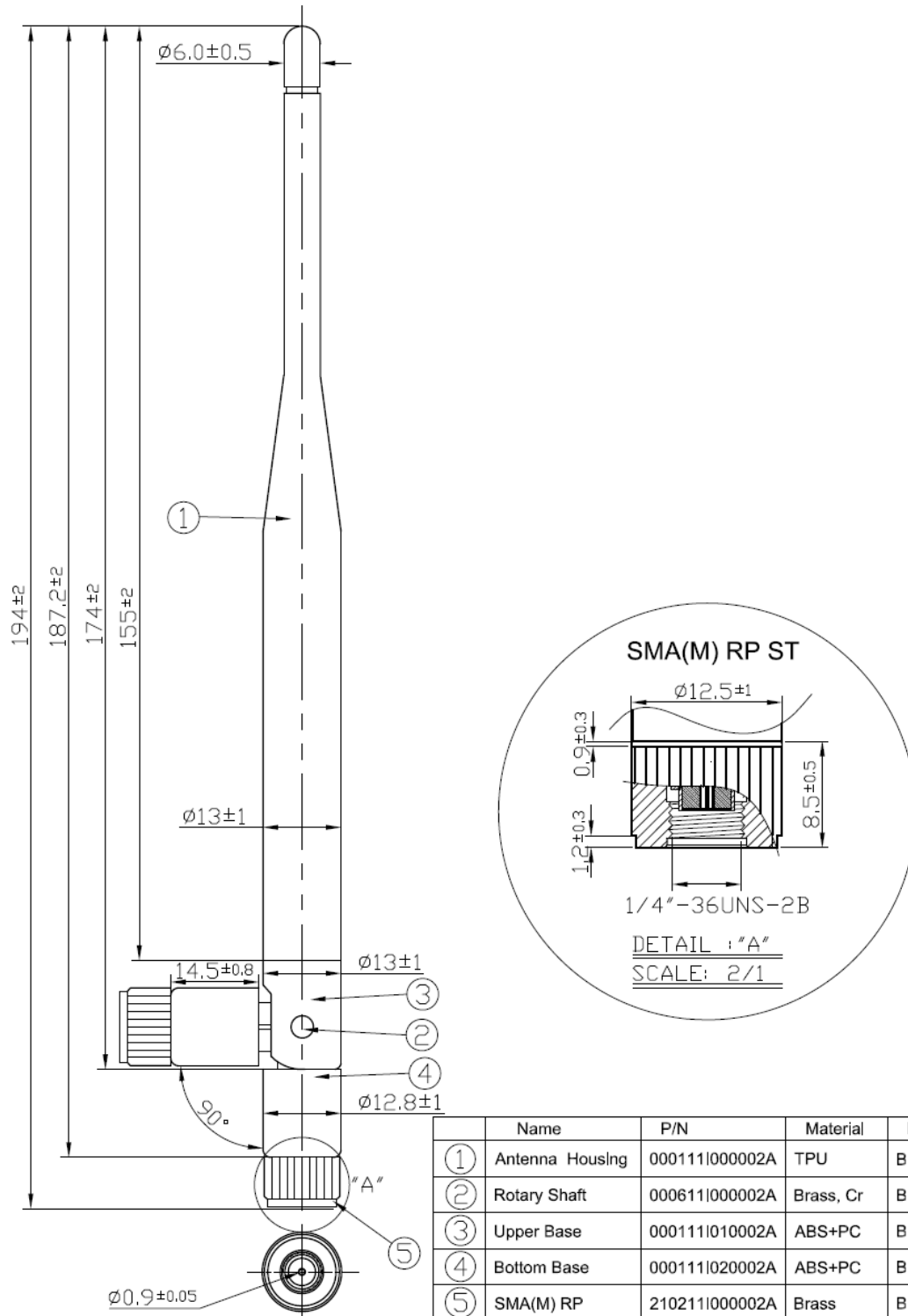

9. Packaging

GW.71.5153 Packaging Specifications

10 pcs GW.71.5153 per PE bag
PE Bag Dimensions - 150*260mm
Weight - 257g

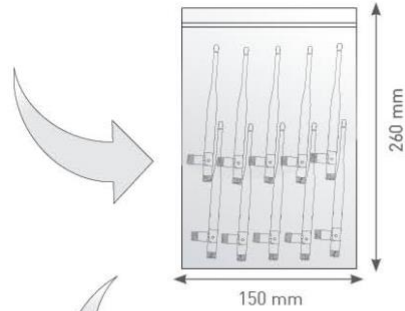

100 PE bags per large PE bag
100 pcs GW.71.5153 per large PE bags
Large PE bag Dimensions - 250*430mm
Weight - 2.57kg

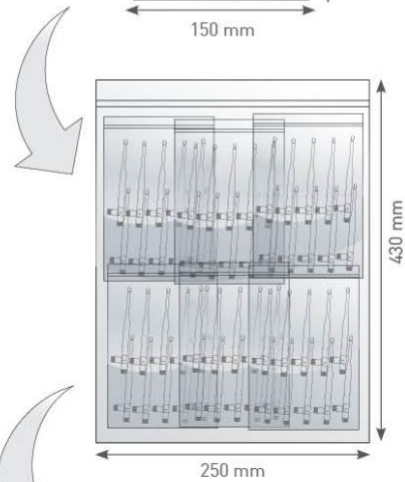

4 Large PE bags per carton
400 pcs GW.71.5153 per carton
Carton Dimensions - 360*310*160mm
Weight - 10.7kg

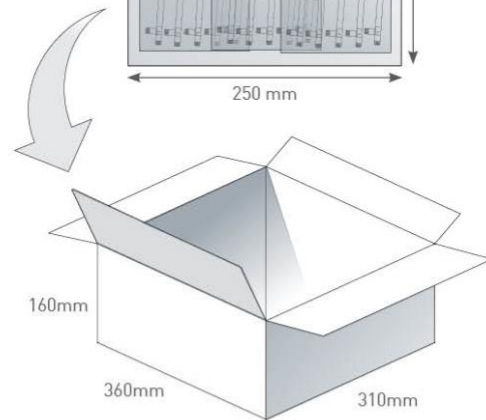

Pallet Dimensions 1200*1000*1430mm
63 Cartons per Pallet
9 Cartons per layer
7 Layers

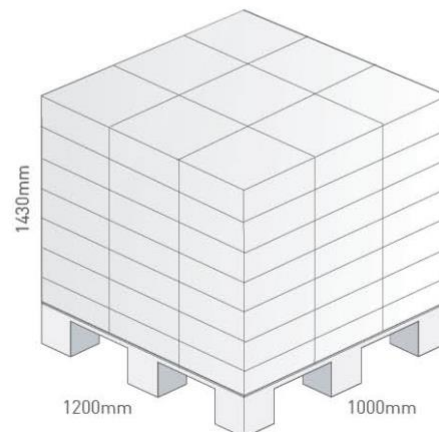



Taoglas makes no warranties based on the accuracy or completeness of the contents of this document and reserves the right to make changes to specifications and product descriptions at any time without notice. Taoglas reserves all rights to this document and the information contained herein.

Reproduction, use or disclosure to third parties without express permission is strictly prohibited.

© Taoglas

Mouser Electronics

Authorized Distributor

Click to View Pricing, Inventory, Delivery & Lifecycle Information:

[Taoglas:](#)

[GW.71.5153](#)